

HP ENVY 15 User Guide

Antenna House XSL Formatter

© Copyright 2009 Hewlett-Packard Development Company, L.P.

Intel is a trademark of Intel Corporation in the U.S. and other countries. Microsoft and Windows are U.S. registered trademarks of Microsoft Corporation. Bluetooth is a trademark owned by its proprietor and used by Hewlett-Packard Company under license. SD Logo is a trademark of its proprietor.

The information contained herein is subject to change without notice. The only warranties for HP products and services are set forth in the express warranty statements accompanying such products and services. Nothing herein should be construed as constituting an additional warranty. HP shall not be liable for technical or editorial errors or omissions contained herein.

Second Edition: December 2009

First Edition: September 2009

Document Part Number: 572050-002

Product notice

This user guide describes features that are common to most models. Some features may not be available on your computer.

Safety warning notice

⚠ WARNING! To reduce the possibility of heat-related injuries or of overheating the computer, do not place the computer directly on your lap or obstruct the computer air vents. Use the computer only on a hard, flat surface. Do not allow another hard surface, such as an adjoining optional printer, or a soft surface, such as pillows or rugs or clothing, to block airflow. Also, do not allow the AC adapter to contact the skin or a soft surface, such as pillows or rugs or clothing, during operation. The computer and the AC adapter comply with the user-accessible surface temperature limits defined by the International Standard for Safety of Information Technology Equipment (IEC 60950).

Antenna House XSL Formatter

Table of contents

1 Notebook four

Identifying hardware	2
Components	3
Top components	3
TouchPad	3
TouchPad buttons	3
Lights	4
Button	5
Keys	6
Front components	7
Right-side components	7
Left-side components	8
Bottom components	9
Display components	10
Wireless antennas	10
Additional hardware components	11
Labels	12

2 Using HP QuickWeb software (select models only)

3 Wireless and local area network

Using wireless devices	15
Identifying wireless and network status icons	15
Using the wireless controls	16
Using the wireless key	16
Using Wireless Assistant software	17
Using operating system controls	17
Using a WLAN	18
Setting up a WLAN	18
Protecting your WLAN	18
Connecting to a WLAN	19
Roaming to another network	20
Using Bluetooth wireless devices	21
Bluetooth and Internet Connection Sharing (ICS)	21

Troubleshooting wireless connection problems	22
Cannot connect to a preferred network	22
Network icon for WLAN is not displayed	22
Current WLAN network security codes are unavailable	22
WLAN connection is very weak	23
Cannot connect to the wireless router	23
Connecting to a local area network (LAN)	24

4 Pointing devices and keyboard

Using pointing devices	26
Setting pointing device preferences	26
Using the TouchPad	26
Using TouchPad gestures	26
Scrolling	26
Pinching	27
Rotating	27
Using the action keys	29
Using the hotkeys	31
Cleaning the TouchPad and keyboard	32

5 Multimedia

Multimedia features	34
Adjusting the volume	34
Using the media activity keys	34
Multimedia software	36
Using HP MediaSmart software	36
Using multimedia software	36
Installing multimedia software from a disc	37
Audio	38
Connecting external audio devices	38
Checking your audio functions	38
Using Beats Audio	39
Identifying Beats Audio icons	40
Video	41
Connecting an external monitor or projector	41
Connecting an HDMI device	42
Configuring audio for HDMI	43
Webcam	44
Webcam tips	44
Adjusting webcam properties	44
Using the ambient light sensor	46
Using adaptive brightness	46
Using the webcam IR light	46

6 Power management

Setting power devices	49
Using power-saving states	49
Initiating and exiting Sleep	49
Initiating and exiting Hibernation	49
Conserving power	50
Using the battery meter	50
Using power plans	51
Viewing the current power plan	51
Selecting a different power plan	51
Customizing power plans	51
Setting password protection on wakeup	51
Using external AC power	52
Connecting AC power	52
Testing an AC adapter	53
Using battery power	54
Identifying batteries	54
Finding battery information in Help and Support	54
Using Battery Check	54
Displaying the remaining battery charge	55
Removing or inserting the primary battery	55
Charging a battery	56
Maximizing battery discharge time	57
Managing low battery levels	57
Identifying low battery levels	57
Resolving a low battery level	58
Resolving a low battery level when external power is available	58
Resolving a low battery level when a charged battery is available	58
Resolving a low battery level when no power source is available	58
Resolving a low battery level when the computer cannot exit Hibernation	58
Using the accessory battery (select models only)	58
Identifying the accessory battery components	59
Inserting or removing an accessory battery	59
Battery charging and discharging sequence	61
Calibrating a battery	61
Storing a battery	62
Disposing of a used battery	62
Replacing the battery	62
Shutting down the computer	63

7 Drives and external devices

Drives	65
Identifying installed drives	65
Handling drives	65
Improving hard drive performance	65
Using Disk Defragmenter	65
Using Disk Cleanup	66
Using HP ProtectSmart Hard Drive Protection (select models only)	66
Identifying HP ProtectSmart Hard Drive Protection status	66
Managing power with a parked hard drive	67
Using HP ProtectSmart Hard Drive Protection software	67
Using external drives	68
Connecting optional external drives	68
Using the external optical drive (select models only)	68
Removing an optical disc when the disc tray will not open	69
Sharing optical drives	69
External devices	71
Using a USB device	71
Connecting a USB device	71
Removing a USB device	71
Using an eSATA device	72
Connecting an eSATA device	72
Removing an eSATA device	72
Using Digital Media Slot cards	73
Inserting a digital card	73
Removing a digital card	74

8 Memory modules

Adding or replacing a memory module in single-slot models	76
Adding or replacing a memory module in double-slot models	79

9 Security

Protecting the computer	84
Using passwords	85
Setting passwords in Windows	85
Setting passwords in Setup Utility	86
Administrator password	86
Managing an administrator password	87
Entering an administrator password	87
Power-on password	87
Managing a power-on password	88
Entering a power-on password	88
Using antivirus software	89

Using firewall software	90
Installing critical security updates	91
Installing an optional security cable	92
Appendix A Setup Utility (BIOS)	
Starting Setup Utility	94
Using Setup Utility	95
Changing the language of Setup Utility	95
Navigating and selecting in Setup Utility	95
Displaying system information	96
Restoring default settings in Setup Utility	96
Exiting Setup Utility	96
Setup Utility menus	98
Main menu	98
Security menu	98
System Configuration menu	98
Diagnostics menu	99
Updating the BIOS	100
Updating the BIOS	100
Determining the BIOS version	100
Downloading a BIOS update	100
Appendix B Backup and recovery	
Creating recovery discs	103
Backing up your information	104
Using Windows Backup and Restore	104
Using system restore points	105
When to create restore points	105
Create a system restore point	105
Restore to a previous date and time	105
Performing a recovery	106
Recovering using the recovery discs	106
Recovering using the dedicated recovery partition (select models only)	106
Appendix C RAID 0 (select models only)	
Disabling RAID 0	108
Index	109

Antenna House XSL Formatter

1 Notebook tour

Antenna House XSL FORMATTER

Identifying hardware

To see a list of hardware installed in the computer:

- ▲ Select **Start > Control Panel > System and Security**. Then in the System area, click **Device Manager**.

You can also add hardware or modify device configurations using Device Manager.

 **NOTE:** Windows® includes the User Account Control feature to improve the security of your computer. You may be prompted for your permission or password for tasks such as installing applications, running utilities, or changing Windows settings. Refer to Help and Support for more information.

Components

Top components

TouchPad

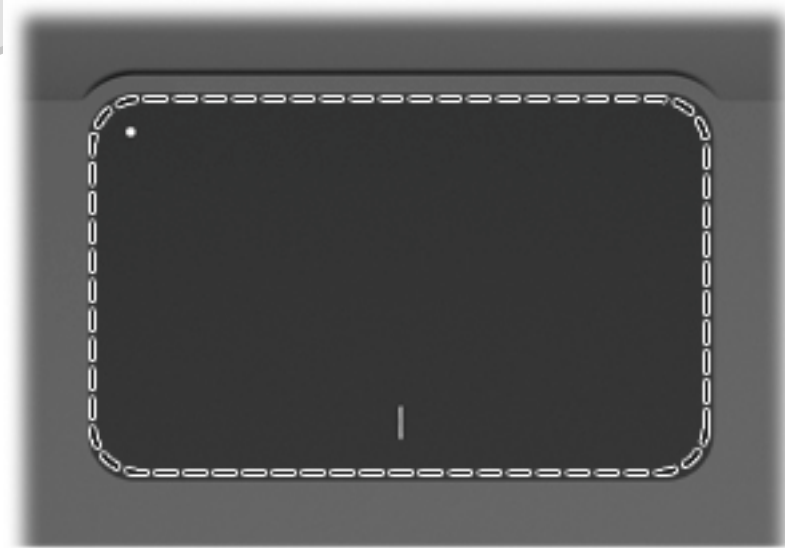



Component	Description
TouchPad*	Moves the pointer and selects or activates items on the screen.

*This table describes factory settings. To view and change pointing device preferences, select **Start > Devices and Printers**. Then, right-click the device representing your computer, and select **Mouse settings**.

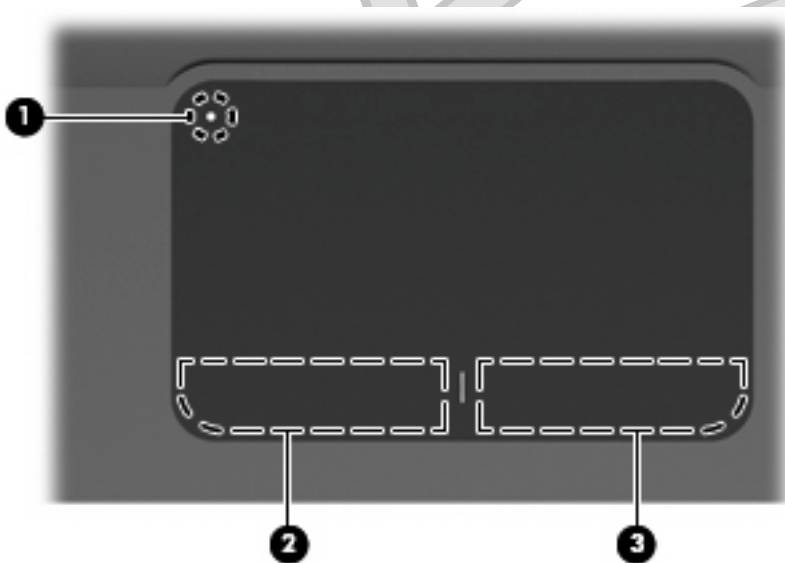
TouchPad buttons





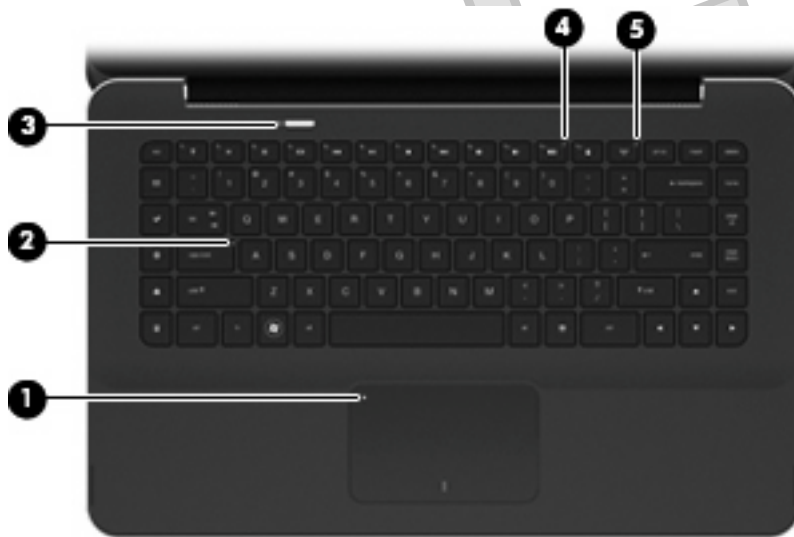

Component	Description
(1)  TouchPad on/off button	Turns the TouchPad on and off. Lightly press the button and hold for several seconds to turn the TouchPad on and off.
(2)  Left TouchPad button*	Functions like the left button on an external mouse.
(3)  Right TouchPad button*	Functions like the right button on an external mouse.

*This table describes factory settings. To view and change pointing device preferences, select **Start > Devices and Printers**. Then, right-click the device representing your computer, and select **Mouse settings**.

Lights



Component	Description
(1)  TouchPad light	Amber: The TouchPad is disabled.
(2)  Caps lock light	White: Caps lock is on.
(3)  Power light	<ul style="list-style-type: none"> White: The computer is on. Blinking white: The computer is in the Sleep state. Off: The computer is off or in Hibernation.
(4)  Mute light	Amber: Computer sound is off.
(5)  Wireless light	<ul style="list-style-type: none"> Off: An integrated wireless device, such as a wireless local area network (WLAN) device and/or a Bluetooth® device, is on. NOTE: Wireless devices are enabled at the factory. Amber: All wireless devices are off.







Button

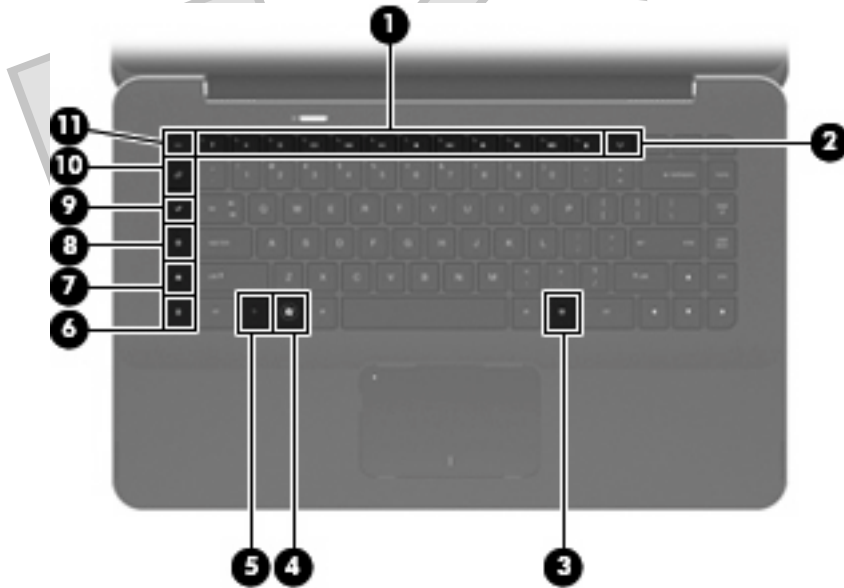



Component	Description
 Power button	<ul style="list-style-type: none">• When the computer is off, press the button to turn on the computer.• When the computer is on, press the button briefly to initiate Sleep.• When the computer is in the Sleep state, press the button briefly to exit Sleep.• When the computer is in Hibernation, press the button briefly to exit Hibernation. <p>If the computer has stopped responding and Windows® shutdown procedures are ineffective, press and hold the power button for at least 5 seconds to turn off the computer.</p> <p>To learn more about your power settings, select Start > Control Panel > System and Security > Power Options.</p>

Keys



Component	Description
(1) Action keys	Execute frequently used system functions.
(2)  wireless key	Turns the wireless feature on or off. NOTE: This key does not establish a wireless connection. To establish a wireless connection, a wireless network must also be set up.
(3)  Windows application key	Displays a shortcut menu for items beneath the cursor.
(4)  Windows logo key	Displays the Windows Start menu.
(5) fn key	Executes frequently used system functions when pressed in combination with a function key or the esc key.
(6)  calculator key	Opens the Windows calculator function.
(7)  print options key	Opens the Print Options window of the active Windows application.
(8)  Web key	Opens a Web browser. NOTE: Until you have set up your Internet or network services, the Web key opens the Windows Internet Connection Wizard. After you have set up your Internet or network services and your Web browser home page, you can press the Web key to quickly access your home page and the Internet.
(9)  Media Launch key	Opens HP MediaSmart. HP MediaSmart turns your computer into a mobile entertainment center. You can enjoy music and movies and manage and edit your photo collections.

Component	Description
(10)  mail key	Opens your default e-mail program. NOTE: The first time you press the mail key, you may be prompted to set up your e-mail account. After you have set up your e-mail, you can press the mail key to quickly access your e-mail.
(11)  esc key	Displays system information when pressed in combination with the fn key.

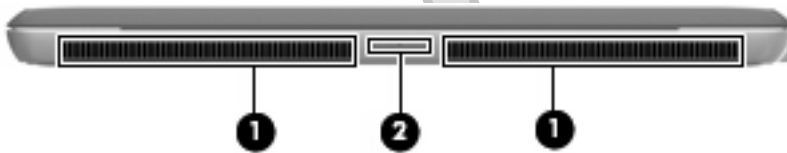

Front components





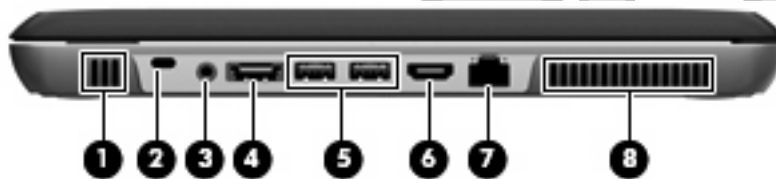

Component	Description
(1) Vents (2)	Enables airflow to cool internal components. NOTE: The computer fan starts up automatically to cool internal components and prevent overheating. It is normal for the internal fan to cycle on and off during routine operation.
(2) Digital Media Slot	Supports the following digital card formats: <ul style="list-style-type: none"> • MultiMediaCard • Micro MultiMediaCard (adapter required) • MultiMediaCard Plus • Secure Digital Memory Card • Micro Secure Digital Memory Card (adapter required) • Secure Digital High Capacity Memory Card

Right-side components



Component	Description
(1)  Speaker	Produces sound.
(2)  Security cable slot	Attaches an optional security cable to the computer. NOTE: The security cable is designed to act as a deterrent, but it may not prevent the computer from being mishandled or stolen.

Component	Description
(3)  Audio-out (headphone) jack/Audio-in (microphone) jack	Produces sound when connected to optional powered stereo speakers, headphones, earbuds, a headset, or television audio. Also connects an optional headset microphone. NOTE: When a device is connected to the jack, the device speakers are disabled.
(4)  eSATA/USB port	Connects a high-performance eSATA component, such as an eSATA external hard drive, or connects an optional USB device.
(5)  USB ports (2)	Connect optional USB devices.
(6)  HDMI port	Connects an optional video or audio device, such as a high-definition television, or any compatible digital or audio component.
(7)  RJ-45 (network) jack	Connects a network cable.
(8) Vent	Enables airflow to cool internal components. NOTE: The computer fan starts up automatically to cool internal components and prevent overheating. It is normal for the internal fan to cycle on and off during routine operation.

Left-side components





Component	Description
(1) Battery light	<ul style="list-style-type: none"> Off: The computer is running on battery power. Blinking amber: The battery has reached a low battery level, a critical battery level, or there is a battery error. Amber: A battery is charging. White: The computer is connected to external power and the battery is fully charged.
(2) Power connector	Connects an AC adapter.
(3) Vent	Enables airflow to cool internal components. NOTE: The computer fan starts up automatically to cool internal components and prevent overheating. It is normal for the internal fan to cycle on and off during routine operation.

Component	Description
(4) Drive light	<ul style="list-style-type: none"> Blinking white: The hard drive is being accessed. Amber (select models only): HP ProtectSmart Hard Drive Protection has temporarily parked the hard drive.
(5) Speaker	Produces sound.

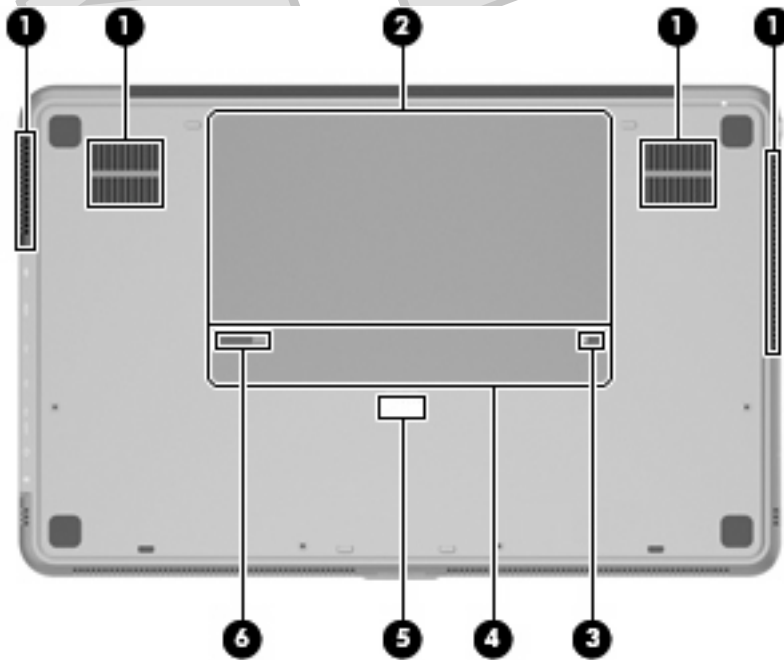
Bottom components



Component	Description
(1) Vents (4)	<p>Enable airflow to cool internal components.</p> <p>NOTE: The computer fan starts up automatically to cool internal components and prevent overheating. It is normal for the internal fan to cycle on and off during routine operation.</p>
(2) Battery bay	<p>Holds the primary battery.</p> <p>NOTE: The primary battery is preinstalled in the battery bay at the factory.</p>
(3)  Battery lock	Locks the primary battery inside the battery bay.
(4) Memory module compartment	Holds the memory modules.
(5) Accessory battery connector	Connects an optional accessory battery.
(6)  Battery release latch	Releases the primary battery from the battery bay.

Display components

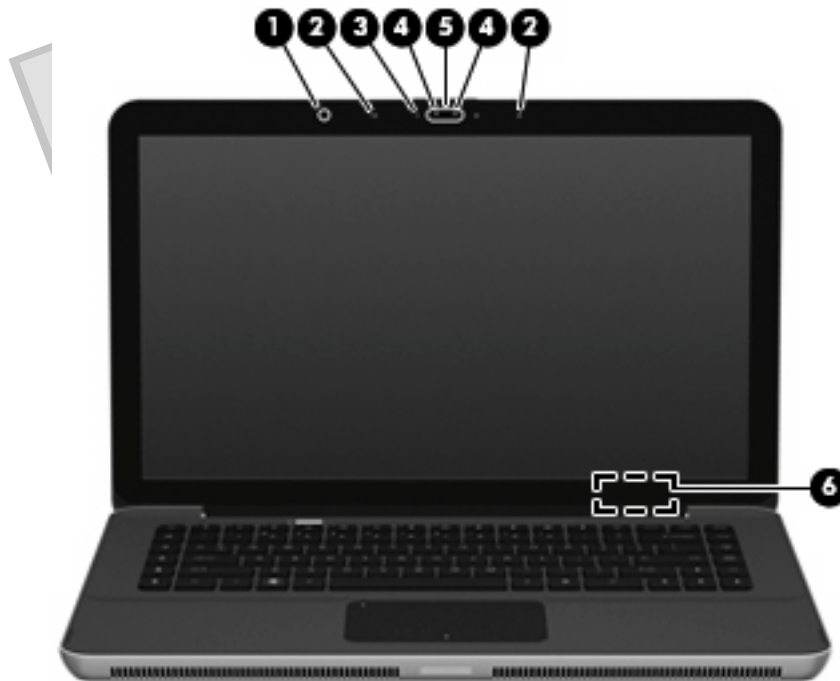

Component	Description
(1) Ambient light sensor	Adjusts the screen brightness levels automatically, based on surrounding lighting conditions.
(2) Internal microphones (2)	Record sound.
(3) Webcam light	On: The webcam is in use.
(4) Webcam infrared (IR) light	Improves the webcam picture quality in low-light conditions.
(5) Webcam	Records video and captures still photographs.
(6) Internal display switch	Turns off the display and initiates Sleep if the display is closed while the power is on. NOTE: The internal display switch is not visible from the outside of the computer.

Wireless antennas

The computer has 2 antennas that send and receive signals from one or more wireless devices. These antennas are not visible from the outside of the computer.

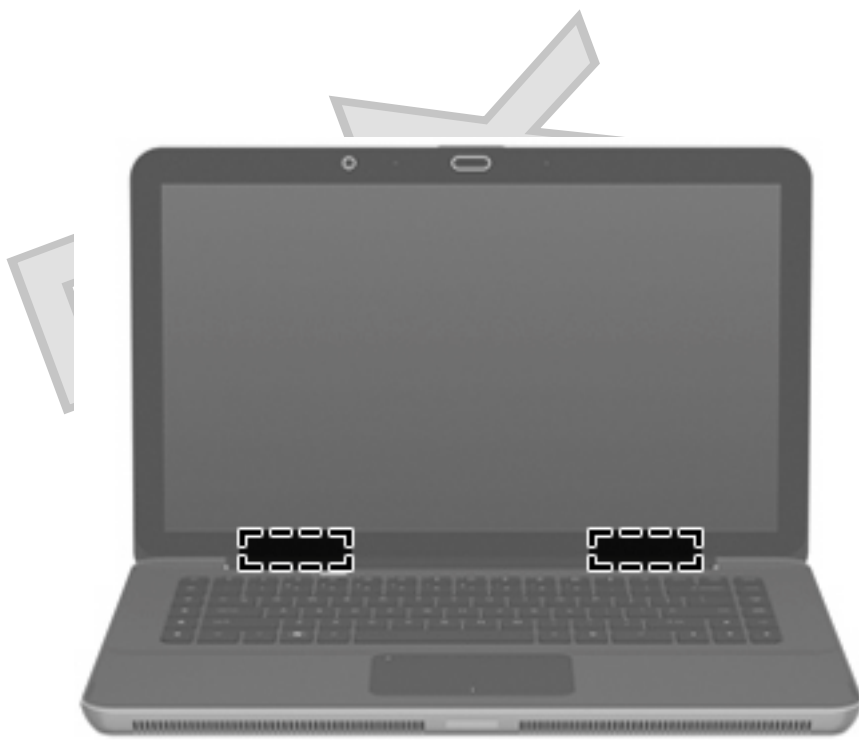

NOTE: For optimal transmission, keep the areas immediately around the antennas free from obstructions.

To see wireless regulatory notices, refer to the section of the *Regulatory, Safety and Environmental Notices* that applies to your country or region. These notices are located in Help and Support.

Additional hardware components



Component	Description
(1) Power cord*	Connects the AC adapter.
(2) AC adapter	Converts AC power to DC power.

*Power cords vary in appearance by region and country.

Labels

The labels affixed to the computer provide information you may need when you troubleshoot system problems or travel internationally with the computer.

- Service tag—Provides important information including the following:

The service tag is located inside the battery bay.



- Serial number (s/n) (1). This is an alphanumeric identifier that is unique to each product.
- Product name (2). This is the product name affixed to the front of your notebook.
- Model description (3). This is the alphanumeric identifier you use to locate documents, drivers, and support for your notebook.
- Warranty period (4). This number describes the duration (in years) of the warranty period for this computer.
- Part number/Product number (p/n) (5). This number provides specific information about the product's hardware components. The part number helps a service technician to determine what components and parts are needed.

Have this information available when you contact technical support.

- Microsoft® Certificate of Authenticity—Contains the Windows® Product Key. You may need the Product Key to update or troubleshoot the operating system. This certificate is affixed to the bottom of the computer.
- Regulatory label—Provides regulatory information about the computer. The regulatory label is affixed inside the battery bay.
- Wireless certification label(s)—Provide information about optional wireless devices and the approval markings of some of the countries or regions in which the devices have been approved for use. An optional device may be a wireless local area network (WLAN) device or an optional Bluetooth® device. If your computer model includes one or more wireless devices, one or more certification labels are included with your computer. You may need this information when traveling internationally. Wireless certification labels are affixed inside the battery bay.

2 Using HP QuickWeb software (select models only)

HP QuickWeb software is an optional, instant-on environment that is separate from the Windows operating system. This allows you to rapidly access certain applications without the need to start the operating system. You will enjoy this feature if you browse the Internet, view and send e-mail, view digital photos, listen to music, or keep in touch through instant messages or Skype. QuickWeb is ready to go within seconds of pressing the power button.

 **NOTE:** On computers with two solid-state drives (SSDs), QuickWeb is supported on select models only.

QuickWeb includes the following features:

- Web browser—Search and browse the Internet and create links to your favorite Web sites.
- Music player—Listen to your favorite music and create playlists.
- Photo viewer—Browse through photos, create albums, and view slide shows.
- Skype—Skype is a voice-over-Internet protocol (VoIP) that lets you communicate free of charge with other Skype users. With Skype, you can have a conference call or a video chat with one or more people at a time. You can also make long-distance phone calls to land lines.
- Chat—Chat with friends on multiple Instant Messaging programs, such as AOL Instant Messenger, Google Talk, MSN, Windows Live! Messenger, or Yahoo Messenger.
- Web calendar—Display, edit, and organize your schedule.
- Web mail—View and send e-mail.

 **NOTE:** For information on using QuickWeb, refer to the *HP ENVY 15 User Manual*. This guide is located on the Secure Digital (SD) Memory Card that came with your computer.

3 Wireless and local area network

Antenna House XSL Formatter

Using wireless devices

Wireless technology transfers data across radio waves instead of wires. Your computer may be equipped with one or more of the following wireless devices:

- Wireless local area network (WLAN) device—Connects the computer to wireless local area networks (commonly referred to as Wi-Fi networks, wireless LANs, or WLANs) in corporate offices, your home, and public places such as airports, restaurants, coffee shops, hotels, and universities. In a WLAN, each mobile wireless device communicates with a wireless router or a wireless access point.
- Bluetooth® device—Creates a personal area network (PAN) to connect to other Bluetooth-enabled devices such as computers, phones, printers, headsets, speakers, and cameras. In a PAN, each device communicates directly with other devices, and devices must be relatively close together—typically within 10 meters (approximately 33 feet) of each other.

Computers with WLAN devices support one or more of the following IEEE industry standards:





- 802.11b, the first popular standard, supports data rates of up to 11 Mbps and operates at a frequency of 2.4 GHz.
- 802.11g supports data rates of up to 54 Mbps and operates at a frequency of 2.4 GHz. An 802.11g WLAN device is backward compatible with 802.11b devices, so they can operate on the same network.
- 802.11a supports data rates of up to 54 Mbps and operates at a frequency of 5 GHz.



 **NOTE:** 802.11a is not compatible with 802.11b and 802.11g.

- 802.11n supports data rates of up to 450 Mbps and may operate at 2.4 GHz or 5 GHz, making it backward compatible with 802.11a, b, and g.

For more information on wireless technology, refer to the information and Web site links provided in Help and Support.

Identifying wireless and network status icons

Icon	Name	Description
	Wireless (connected)	Identifies the location of the wireless light and the wireless key on the computer. Also identifies the Wireless Assistant software on the computer and indicates that one or more of the wireless devices are on.
	Wireless (disconnected)	Identifies the Wireless Assistant software on the computer and indicates that all of the wireless devices are off.
	Wired network (connected)	Indicates that one or more network drivers on your computer are installed and one or more network devices are connected to the network.
	Wired network (disabled/disconnected)	Indicates that one or more of your network drivers are installed, all network devices or all wireless devices are disabled in Windows Control Panel, and no network devices are connected to a wired network.

	<p>Network (connected)</p>	<p>Indicates that one or more of your network drivers are installed, one or more network devices are connected to a wireless network, and one or more network devices may be connected to a wired network.</p>
	<p>Network (disabled/disconnected)</p>	<p>Indicates that one or more of your network drivers are installed, no wireless connections are available or all wireless network devices are disabled by the wireless button or Wireless Assistant, and no network devices are connected to a wired network.</p>
	<p>Network (disconnected)</p>	<p>Indicates that one or more of your network drivers are installed and wireless connections are available, but no network devices are connected to a wired or wireless network.</p>

Using the wireless controls

You can control the wireless devices in your computer using these features:

- wireless key
- Wireless Assistant software
- Operating system controls

Using the wireless key

The computer has a wireless key (1), one or more wireless devices, and one wireless light (2). All of the wireless devices on your computer are enabled at the factory.

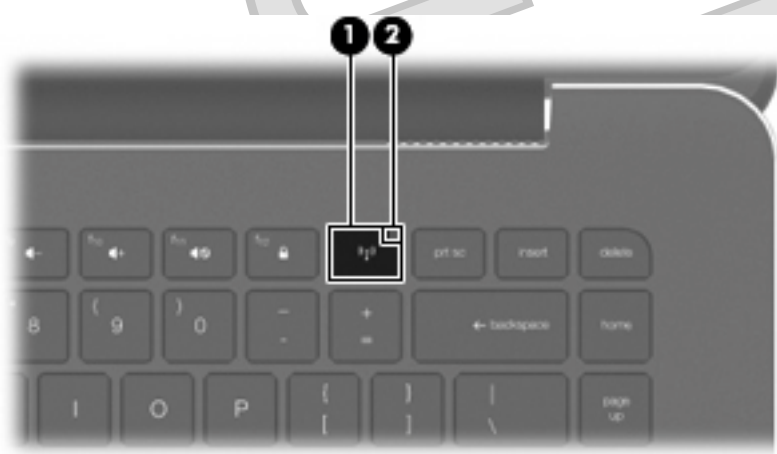

If the wireless light is amber, all wireless devices are off. If the wireless light is off, all wireless devices are on.

The wireless light indicates the overall power state of your wireless devices, not the status of individual devices. Press the wireless key to turn the wireless devices off or on.

Because the wireless devices are enabled at the factory, you can use the wireless key to turn on or turn off the wireless devices simultaneously. Individual wireless devices can be controlled through Wireless Assistant software.

Using Wireless Assistant software

A wireless device can be turned on or off using the Wireless Assistant software. If a wireless device is disabled in Setup Utility, it must be reenabled in Setup Utility before it can be turned on or off using Wireless Assistant.

 **NOTE:** Enabling or turning on a wireless device does not automatically connect the computer to a network or a Bluetooth-enabled device.

To view the state of the wireless devices, click the **Show hidden icons** icon, the arrow at the left of the notification area, and position the mouse pointer over the wireless icon.

If the wireless icon is not displayed in the notification area, complete the following steps to change Wireless Assistant properties:

1. Select **Start > Control Panel > Hardware and Sound > Windows Mobility Center**.
2. Click the wireless icon in the Wireless Assistant tile, which is located in the bottom row of Windows® Mobility Center.
3. Click **Properties**.
4. Select the check box next to **HP Wireless Assistant icon in notification area**.
5. Click **Apply**.
6. Click **Close**.

For more information, refer to the Wireless Assistant software Help:

1. Open Wireless Assistant by clicking the wireless icon in Windows Mobility Center.
2. Click the **Help** button.

Using operating system controls

Some operating systems also offer a way to manage integrated wireless devices and the wireless connection. For example, Windows provides the Network and Sharing Center that allows you to set up a connection or network, connect to a network, manage wireless networks, and diagnose and repair network problems.

To access the Network and Sharing Center, select **Start > Control Panel > Network and Internet > Network and Sharing Center**.

For more information, select **Start > Help and Support**.

Using a WLAN

With a WLAN device, you can access a wireless local area network (WLAN), which is composed of other computers and accessories that are linked by a wireless router or a wireless access point.

 **NOTE:** The terms *wireless router* and *wireless access point* are often used interchangeably.

- A large-scale WLAN, such as a corporate or public WLAN, typically uses wireless access points that can accommodate a large number of computers and accessories and can separate critical network functions.
- A home or small office WLAN typically uses a wireless router, which allows several wireless and wired computers to share an Internet connection, a printer, and files without requiring additional pieces of hardware or software.

To use the WLAN device in your computer, you must connect to a WLAN infrastructure (provided through a service provider or a public or corporate network).

Setting up a WLAN

To set up a WLAN and connect to the Internet, you need the following equipment:

- A broadband modem (either DSL or cable) (1) and high-speed Internet service purchased from an Internet service provider (ISP)
- A wireless router (purchased separately) (2)
- The wireless computer (3)

The following illustration shows an example of a wireless network installation that is connected to the Internet.

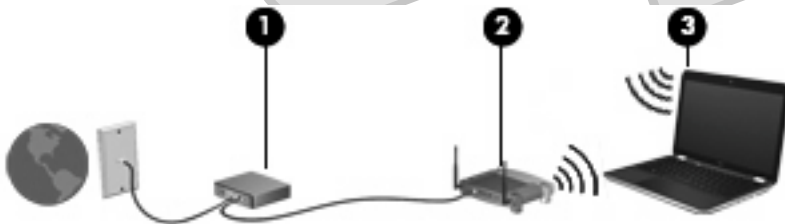

 **NOTE:** When setting up a wireless connection, be sure that your computer and wireless router are synchronized. To synchronize your computer and wireless router, turn your computer and wireless router off and then back on.

As your network grows, additional wireless and wired computers can be connected to the network to access the Internet.

For help in setting up your WLAN, refer to the information provided by your router manufacturer or your ISP.

Protecting your WLAN

Because the WLAN standard was designed with only limited security capabilities—basically to foil casual eavesdropping rather than more powerful forms of attack—it is essential to understand that WLANs are vulnerable to well-known and well-documented security weaknesses.

WLANs in public areas, or “hotspots,” like coffee shops and airports may not provide any security. New technologies are being developed by wireless manufacturers and hotspot service providers that make

the public environment more secure and anonymous. If you are concerned about the security of your computer in a hotspot, limit your network activities to noncritical e-mail and basic Internet surfing.

When you set up a WLAN or access an existing WLAN, always enable security features to protect your network from unauthorized access. The common security levels are Wi-Fi Protected Access (WPA)-Personal and Wired Equivalent Privacy (WEP). Because wireless radio signals travel outside the network, other WLAN devices can pick up unprotected signals and either connect to your network (uninvited) or capture information being sent across it. However, you can take precautions to protect your WLAN:

- **Use a wireless transmitter with built-in security**

Many wireless base stations, gateways, or routers provide built-in security features such as wireless security protocols and firewalls. With the correct wireless transmitter, you can protect your network from the most common wireless security risks.

- **Work behind a firewall**

A firewall is a barrier that checks both data and requests for data that are sent to your network, and discards any suspicious items. Firewalls are available in many varieties, both software and hardware. Some networks use a combination of both types.

- **Use wireless encryption**

A variety of sophisticated encryption protocols is available for your WLAN. Find the solution that works best for your network security:

- **Wired Equivalent Privacy (WEP)** is a wireless security protocol that encodes or encrypts all network data before it is transmitted using a WEP key. Usually, you can allow the network to assign the WEP key. Alternatively, you can set up your own key, generate a different key, or choose other advanced options. Without the correct key, others will not be able to use the WLAN.
- **WPA (Wi-Fi Protected Access)**, like WEP, uses security settings to encrypt and decrypt data that is transmitted over the network. However, instead of using one static security key for encryptions as WEP does, WPA uses “temporal key integrity protocol” (TKIP) to dynamically generate a new key for every packet. It also generates different sets of keys for each computer on the network.

Connecting to a WLAN

To connect to the WLAN, follow these steps:

1. Be sure that the WLAN device is on (wireless light is off). If the wireless light is amber, press the [wireless](#) key.
2. Click the network icon in the notification area, at the far right of the taskbar.
3. Select your WLAN from the list.
4. Click **Connect**.

If the network is a security-enabled WLAN, you are prompted to enter a network security key, which is a security code. Type the code, and then click **Connect** to complete the connection.

 **NOTE:** If no WLANs are listed, you are out of range of a wireless router or access point.

NOTE: If you do not see the network you want to connect to, **Open Network and Sharing Center**, and then click **Set up a new connection or network**. A list of options is displayed. You can choose to manually search for and connect to a network or to create a new network connection.

After the connection is made, place the mouse pointer over the network icon in the notification area, at the far right of the taskbar, to verify the name and status of the connection.

 **NOTE:** The functional range (how far your wireless signals travel) depends on WLAN implementation, router manufacturer, and interference from other electronic devices or structural barriers such as walls and floors.

More information about using a WLAN is available through the following resources:

- Information from your ISP and the user guides included with your wireless router and other WLAN equipment
- Information and Web site links provided in Help and Support

For a list of public WLANs near you, contact your ISP or search the Web. Web sites that list public WLANs include Cisco Internet Mobile Office Wireless Locations, Hotspotlist, and Geektools. Check with each public WLAN location for cost and connection requirements.

For additional information on connecting your computer to a corporate WLAN, contact your network administrator or IT department.

Roaming to another network

When you move your computer within range of another WLAN, Windows attempts to connect to that network. If the attempt is successful, your computer is automatically connected to the new network. If Windows does not recognize the new network, follow the same procedure you used initially to connect to your WLAN.

Using Bluetooth wireless devices

A Bluetooth device provides short-range wireless communications that replace the physical cable connections that traditionally link electronic devices such as the following:

- Computers (desktop, notebook, PDA)
- Phones (cellular, cordless, smart phone)
- Imaging devices (printer, camera)
- Audio devices (headset, speakers)

Bluetooth devices provide peer-to-peer capability that allows you to set up a personal area network (PAN) of Bluetooth devices. For information on configuring and using Bluetooth devices, refer to the Bluetooth software Help.

Bluetooth and Internet Connection Sharing (ICS)

HP does **not** recommend setting up one computer with Bluetooth as a host and using it as a gateway through which other computers may connect to the Internet. When two or more computers are connected using Bluetooth, and Internet Connection Sharing (ICS) is enabled on one of the computers, the other computers may not be able to connect to the Internet using the Bluetooth network.

The strength of Bluetooth is in synchronizing information transfers between your computer and wireless devices including cellular phones, printers, cameras, and PDAs. The inability to consistently connect two or more computers to share the Internet through Bluetooth is a limitation of Bluetooth and the Windows operating system.

Troubleshooting wireless connection problems

Some possible causes for wireless connection problems include the following:

- Network configuration (SSID or security) has been changed.
- Wireless device is not installed correctly or has been disabled.
- Wireless device or router hardware has failed.
- Wireless device encountered interference from other devices.

Cannot connect to a preferred network

Windows can automatically repair a corrupted WLAN connection:

- If there is a network icon in the notification area, at the far right of the taskbar, right-click the icon, and then click **Diagnose and repair** from the menu.

Windows resets your network device and attempts to reconnect to one of the preferred networks.

- If there is no network icon in the notification area, follow these steps:
 1. Select **Start > Control Panel > Network and Internet > Network and Sharing Center**.
 2. Click **Troubleshoot problems** and select the network you wish to repair.

Network icon for WLAN is not displayed

If the network icon is not displayed in the notification area after you configure the WLAN, the software driver is either missing or corrupted. A Windows "Device not Found" error message may also be displayed. The driver must be reinstalled.

Get the latest version of the WLAN device software and drivers for your computer from the HP Web site at <http://www.hp.com>:

1. Open your Web browser and go to <http://www.hp.com/support>.
2. Select your country or region.
3. Click the option for software and driver downloads, and then type your computer model number in the search box.
4. Press **enter**, and then follow the on-screen instructions.

Current WLAN network security codes are unavailable

If you are prompted for a network key or a name (SSID) when connecting to a WLAN, the network is protected by security. You must have the current codes to make a connection on a secure network. The SSID and network key are alphanumeric codes that you enter into your computer to identify your computer to the network.

- For a network connected to your personal wireless router, review the router user guide for instructions on setting up the same codes on both the router and the WLAN device.
- For a private network, such as a network in an office or at a public Internet chat room, contact the network administrator to obtain the codes, and then enter the codes when prompted to do so.

Some networks change the SSID or network keys used in their routers or access points on a regular basis to improve security. You must change the corresponding code in your computer accordingly.

If you are provided with new wireless network keys and SSID for a network, and if you have previously connected to that network, follow these steps to connect to the network:

1. Select **Start > Control Panel > Network and Internet > Network and Sharing Center**.
2. Click **Manage wireless networks** in the left panel.

A list showing the available WLANs is displayed. If you are in a hotspot where several WLANs are active, several will be displayed.

3. Select the network in the list, right-click the network, and then click **Properties**.

 **NOTE:** If the network you want is not listed, check with the network administrator to be sure that the router or access point is operating.

4. Click the **Security** tab and enter the correct wireless encryption data into the **Network security key** box.
5. Click **OK** to save these settings.

WLAN connection is very weak

If the connection is very weak, or if your computer cannot make a connection to a WLAN, minimize interference from other devices, as follows:

- Move your computer closer to the wireless router or access point.
- Temporarily disconnect devices such as a microwave, cordless phone, or cellular phone to be sure that other wireless devices are not interfering.

If the connection does not improve, try forcing the device to reestablish all connection values:

1. Select **Start > Control Panel > Network and Internet > Network and Sharing Center**.
2. Click **Manage wireless networks** in the left pane.

A list showing the available WLANs is displayed. If you are in a hotspot where several WLANs are active, several will be displayed.

3. Click a network, and then click **Remove**.

Cannot connect to the wireless router

If you are trying to connect to the wireless router and are unsuccessful, reset the wireless router by removing power from the router for 10 to 15 seconds.

If the computer still cannot make a connection to a WLAN, restart the wireless router. For details, refer to the router manufacturer's instructions.

Connecting to a local area network (LAN)

Connecting to a local area network (LAN) requires an 8-pin, RJ-45 network cable (purchased separately). If the network cable contains noise suppression circuitry (1), which prevents interference from TV and radio reception, orient the circuitry end of the cable (2) toward the computer.



To connect to a LAN:

1. Plug the network cable into the network jack (1) on the computer.
2. Plug the other end of the network cable into a network wall jack (2).

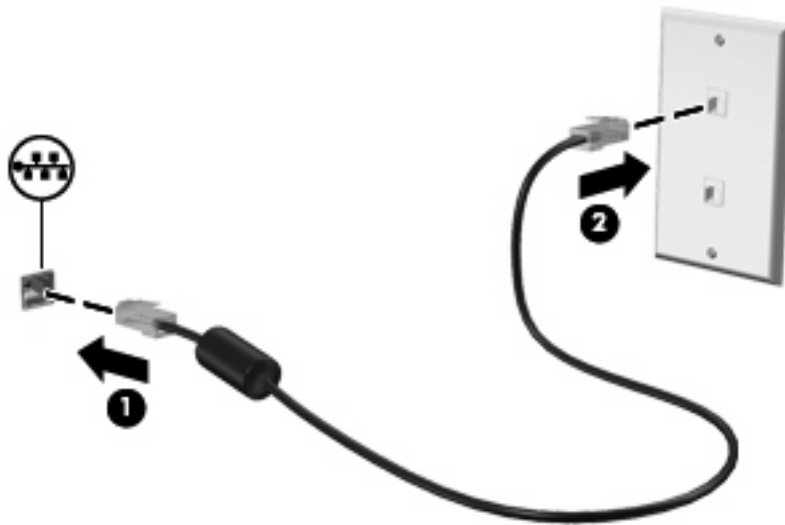

⚠ WARNING! To reduce the risk of electric shock, fire, or damage to the equipment, do not plug a modem cable or telephone cable into an RJ-45 (network) jack.

4 Pointing devices and keyboard

Antenna House XSL Formatter

Using pointing devices

 **NOTE:** In addition to the TouchPad, you can also connect an external USB mouse to one of the USB ports on the computer.

Setting pointing device preferences

Use Mouse Properties in Windows® to customize settings for pointing devices, such as button configuration, click speed, and pointer options.

To access Mouse Properties, select **Start > Devices and Printers**. Then, right-click the device representing your computer, and select **Mouse settings**.

Using the TouchPad

To move the pointer, slide one finger across the TouchPad surface in the direction you want the pointer to go. Use the left and right TouchPad buttons like the corresponding buttons on an external mouse.

 **NOTE:** For information on identifying the TouchPad components, refer to [TouchPad buttons on page 3](#).

Using TouchPad gestures

The TouchPad supports a variety of TouchPad gestures. To activate the TouchPad gestures, place two fingers on the TouchPad as described in the following sections.

The TouchPad gestures described in this section are enabled at the factory. To disable or reenab these gestures:

1. Double-click on the **Synaptics** icon in the notification area, at the far right of the taskbar, and then click the **Device Settings** tab.
2. Select the device, and then click **Settings**.
3. Select the checkbox to disable or reenab the TouchPad gesture.
4. Click **Apply**, and then click **OK**.

 **NOTE:** Your computer also supports additional TouchPad features that are disabled at the factory. To view and enable these features, click the **Synaptics** icon in the notification area, at the far right of the taskbar, and then click the **Device Settings** tab. Select the device, and then click **Settings**.

Scrolling

Scrolling is useful for moving up or down on a page or image. To scroll, place two fingers on the TouchPad and drag them across the TouchPad in an up, down, left, or right motion.

 **NOTE:** Scrolling speed is controlled by finger speed.

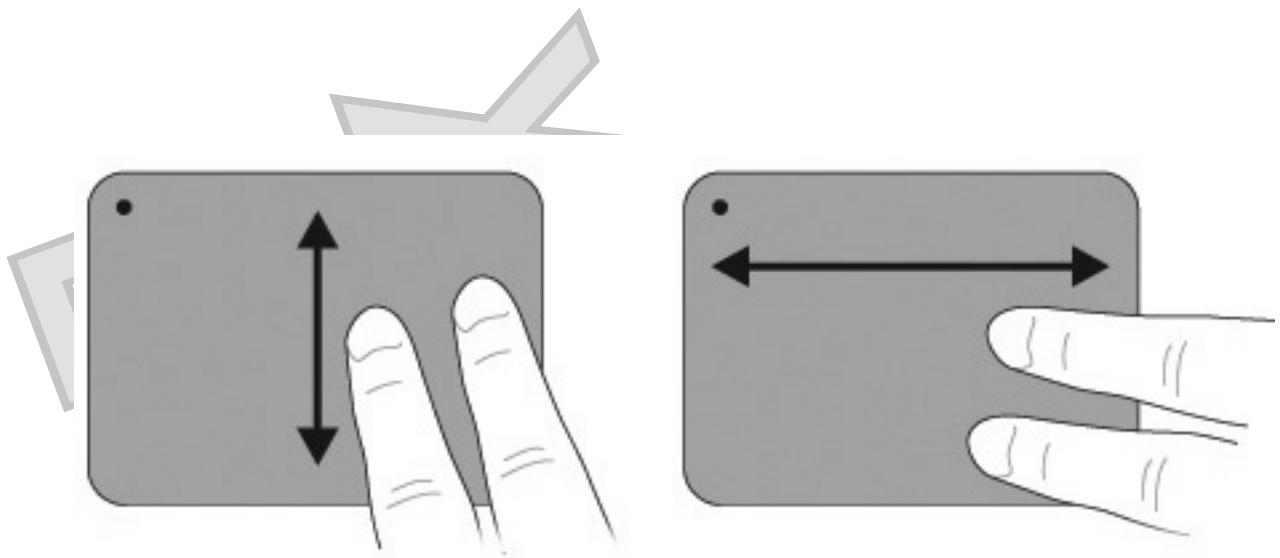

Pinching

Pinching allows you to zoom in or out on items such as PDFs, images, and photos.

To pinch:

- Zoom in by holding two fingers together on the TouchPad, and then pull the fingers apart to increase an object's size.
- Zoom out by holding two fingers apart on the TouchPad, and then pull the fingers together to decrease an object's size.

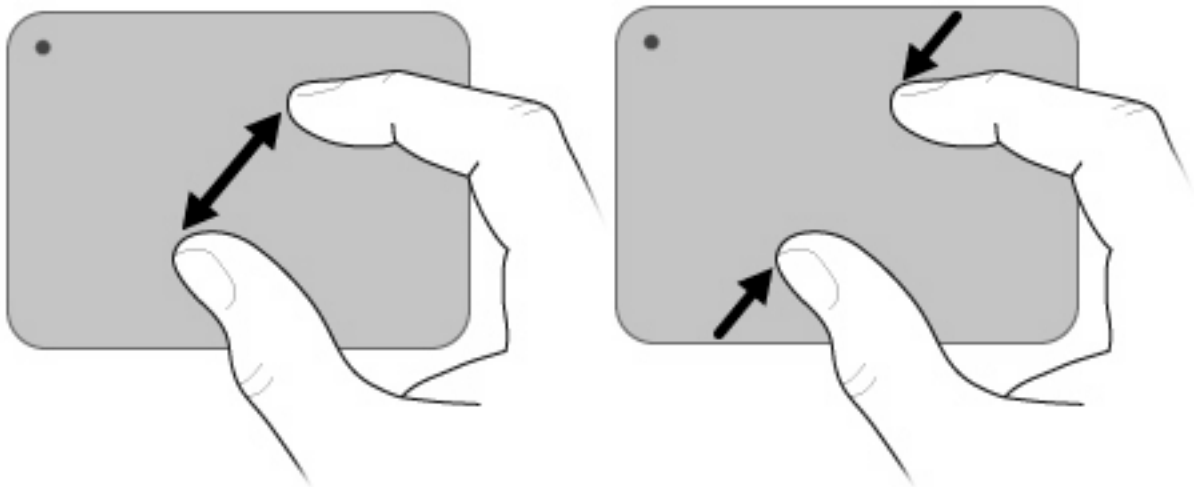

Rotating

Rotating allows you to rotate items such as photos and pages. To rotate, anchor your thumb on the TouchPad, and then move your forefinger in a semicircular motion around your thumb.

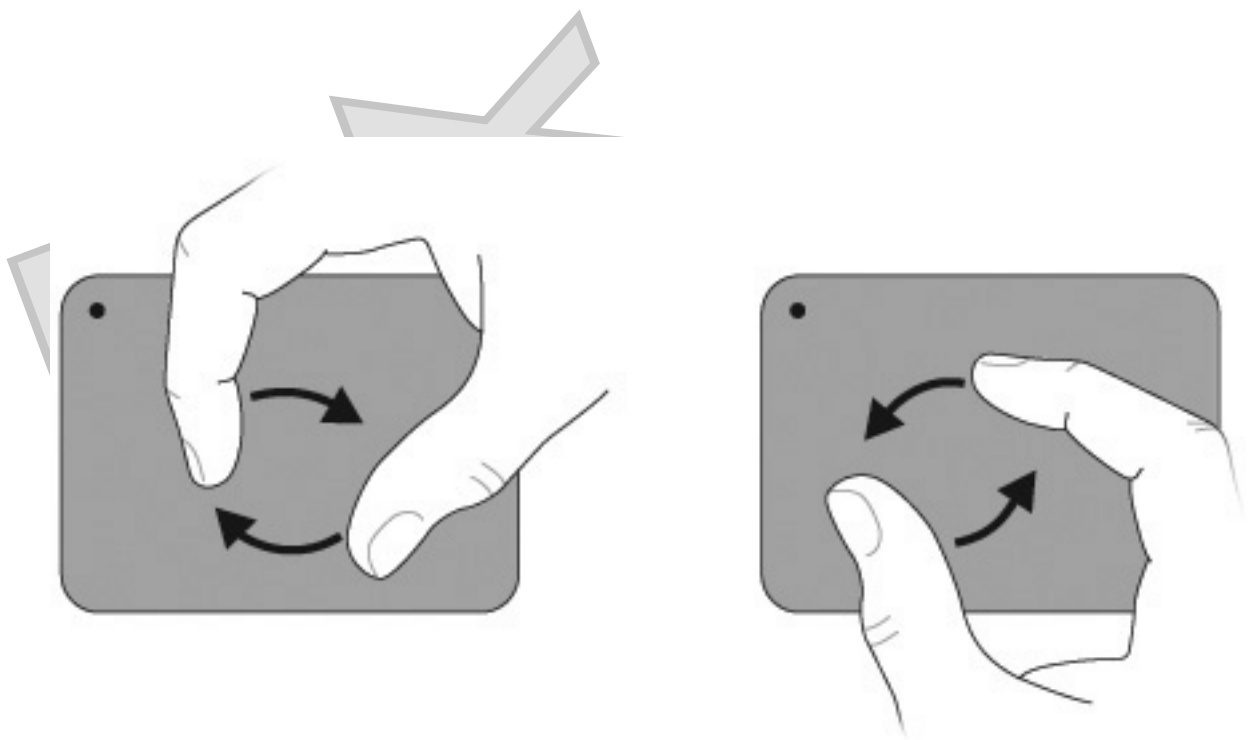

ANTENNA HOUSE XSL FORMATTER

Using the action keys

 **NOTE:** Some action keys are not available in QuickWeb.











Action keys are customized actions that are assigned to specific keys on the keyboard.



To use an action key, press and hold this key to activate the assigned function.

 **NOTE:** Depending on the application you are using, pressing **fn** and one of the action keys will open a specific shortcut menu within that application.

NOTE: The action key feature is enabled at the factory. You can disable this feature in Setup Utility (BIOS) to require pressing the **fn** key and one of the action keys to activate the assigned function. Refer to [Setup Utility \(BIOS\) on page 93](#) for additional information.



Icon	Description
	Opens Help and Support, which provides information about your Windows operating system and computer, answers to questions and tutorials, and updates to your computer. Help and Support also provides automated troubleshooting and links to support specialists.
	Decreases the screen brightness level incrementally when you hold down this key.
	Increases the screen brightness level incrementally when you hold down this key.
	Switches the screen image among display devices connected to the system. For example, if a monitor is connected to the computer, pressing this key alternates the screen image from computer display to monitor display to simultaneous display on both the computer and the monitor. Most external monitors receive video information from the computer using the external VGA video standard. The switch screen image key can also alternate images among other devices that are receiving video information from the computer.
	Plays the previous track of a CD or the previous section of a DVD or a BD.
	Plays, pauses, or resumes an audio CD, a DVD, or a BD.
	Stops audio playback of a CD, a DVD, or a BD.
	Plays the next track of an audio CD or the next section of a DVD or a BD.
	Decreases speaker sound incrementally when you hold down this key.
	Increases speaker sound incrementally when you hold down this key.

Icon	Description
	Mutes or restores speaker sound.
	Initiates the QuickLock security feature. QuickLock protects your information by displaying the operating system Log On window. While the Log On window is displayed, the computer cannot be accessed until a Windows user password or a Windows administrator password is entered. NOTE: Before you can use QuickLock, you must set a Windows user password or a Windows administrator password. For instructions, refer to Help and Support.
<code>prt sc</code>	Takes a snapshot or picture of your computer screen and copies it to the clipboard.

Using the hotkeys

Hotkeys are combinations of the **fn** key (1) and either the **esc** key (2) or the **b** key (3).

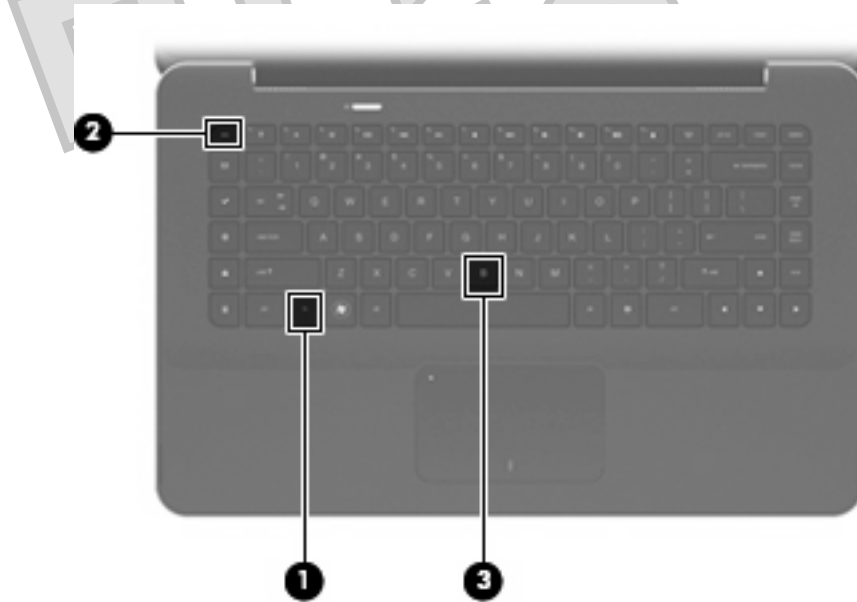

Function	Hotkey	Description
Display system information.	fn+esc	Displays information about system hardware components and the system BIOS version number.
Control the bass settings.	fn+b	Increases or decreases the bass settings with the Beats Audio feature.

To use a hotkey command, follow either of these steps:

- Briefly press the **fn** key, and then briefly press the second key of the hotkey command.
– or –
- Press and hold down the **fn** key, briefly press the second key of the hotkey command, and then release both keys at the same time.

Cleaning the TouchPad and keyboard

Dirt and grease on the TouchPad can cause the pointer to jump around on the screen. To avoid this, clean the TouchPad with a damp cloth, and wash your hands frequently when using the computer.

- ⚠ **WARNING!** To reduce the risk of electric shock or damage to internal components, do not use a vacuum cleaner attachment to clean the keyboard. A vacuum cleaner can deposit household debris on the keyboard surface.

Clean the keyboard regularly to prevent keys from sticking and to remove dust, lint, and particles that can become trapped beneath the keys. A can of compressed air with a straw extension can be used to blow air around and under the keys to loosen and remove debris.

5 Multimedia

Antenna House XSL Formatter

Multimedia features

Your computer includes multimedia features that allow you to listen to music, watch movies, and view pictures. Your computer may include the following multimedia components:

- Integrated speakers for listening to music
- Integrated microphones for recording your own audio
- Integrated webcam that allows you to capture and share video
- Preinstalled multimedia software that allows you to play and manage your music, movies, and pictures
- Multimedia keys that provide fast access to multimedia tasks

The following sections explain how to use the multimedia components included with your computer.

Adjusting the volume

You can adjust the volume using the computer volume keys.

- To decrease volume, press the **volume down** key (1).
- To increase volume, press the **volume up** key (2).
- To mute or restore volume, press the **volume mute** key (3).



 **NOTE:** Volume can also be controlled through the Windows operating system and some programs.

Using the media activity keys

The media activity keys control the play of an audio CD or a DVD or BD that is inserted into an external optical drive (purchased separately).

- When an audio CD or a DVD is not playing, press the **play/pause** key (2) to play the disc.
- When an audio CD or a DVD is playing, use the following keys:
 - To play the previous track of an audio CD or the previous chapter of a DVD, press the **previous track** key (1).
 - To pause or resume playing the disc, press **play/pause** key (2).
 - To stop the disc, press the **stop** key (3).
 - To play the next track of an audio CD or the next chapter of a DVD, press the **next track** key (4).

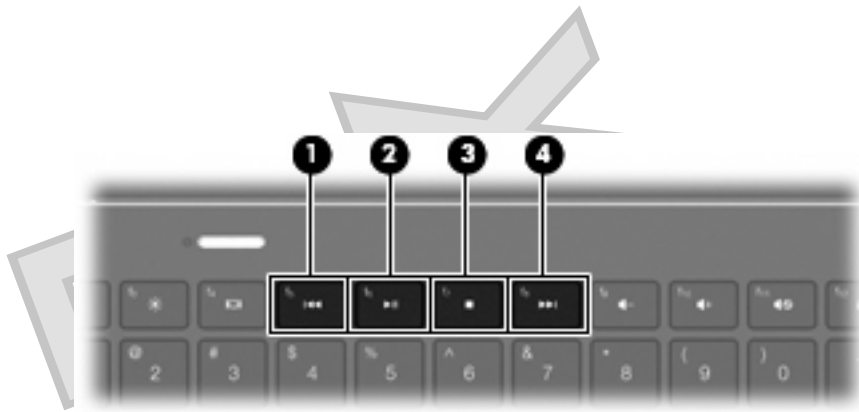

Antenna House XSL Formatter

Multimedia software

The computer includes preinstalled multimedia software.

If you have an external optical drive (purchased separately), you can also perform the following multimedia tasks:

- Playing digital media, including audio and video CDs, audio and video DVDs
- Creating or copying data CDs
- Creating, editing, and burning audio CDs
- Creating, editing, and burning a video or movie to a DVD or video CD

Using HP MediaSmart software

HP MediaSmart turns your computer into a mobile entertainment center. With MediaSmart, you can enjoy music and DVD and BD movies. You can also manage and edit your photo collections. MediaSmart includes the following features:

- Playlist upload support:
 - Upload your MediaSmart photo playlists to Internet photo albums, such as Snapfish.
 - Upload your MediaSmart video playlists to YouTube.
 - Export your MediaSmart playlist to the CyberLink DVD Suite.
- Pandora Internet radio (North America only)—Listen to music selected just for you, streamed from the Internet.

To start MediaSmart:

- ▲ Select **Start > All Programs > HP > HP MediaSmart**.

– or –

- ▲ Press the **media launch** key on the keyboard.

For more information on using MediaSmart, select **Start > Help and Support**.

Using multimedia software

- ▲ Select **Start > All Programs**, and then open the multimedia program you want to use. For example, if you want to use Windows Media Player to play an audio CD, click **Windows Media Player**.

– or –

1. Insert a disc into an external optical drive (purchased separately).
An AutoPlay dialog box opens.
2. Click a multimedia task from the list, and then choose the software you want to use for that task.

Installing multimedia software from a disc

Although your computer does not have an integrated optical drive, you can easily access software, as well as install applications and access data in either of the following ways:

- Connect an external optical drive (purchased separately) to one of the USB ports on your computer.

 **NOTE:** For additional information on external optical drives, refer to [Using external drives on page 68](#).

NOTE: Select computer models ship with an external optical drive.

- Share the optical drive that is connected to another computer on your network.

 **NOTE:** You must have a network set up in order to share an optical drive. For additional information on sharing optical drives, refer to [Sharing optical drives on page 69](#).

NOTE: Some discs, such as DVD movies and game discs, may be copy-protected and therefore unusable through DVD or CD sharing.

Audio

Your computer enables you to use a variety of audio features:

- Play music using your computer speakers and/or connected external speakers
- Control the bass with the Beats Audio feature (**fn+b**)
- Record sound using the internal microphone or connect an external microphone
- Download music from the Internet
- Create multimedia presentations using audio and images
- Transmit sound and images with instant messaging programs
- Stream radio programs
- Create (burn) audio CDs with an optional optical drive

Connecting external audio devices

⚠ WARNING! To reduce the risk of personal injury, adjust the volume before putting on headphones, earbuds, or a headset. For additional safety information, refer to the *Regulatory, Safety and Environmental Notices*.

To connect external devices such as external speakers, headphones, earbuds, a headset, television audio, or a headset microphone, refer to the information provided with the device. For best results, remember the following tips:

- Be sure that the device cable has a 4-conductor connector that supports both audio-out (headphone) and audio-in (microphone).
- Be sure that the device cable is securely connected to the correct jack on your computer.
- Be sure to install any drivers required by the external device.

📝 NOTE: A driver is a required program that acts like a translator between the device and the programs that use the device.

Checking your audio functions

To check the system sound on your computer, follow these steps:

1. Select **Start > Control Panel**.
2. Click **Hardware and Sound**.
3. Click **Sound**.
4. When the Sound window opens, click the **Sounds** tab. Under **Program Events**, select any sound event, such as a beep or alarm, and click the **Test** button.

You should hear sound through the speakers or through connected headphones.

To check the record functions of the computer, follow these steps:

1. Select **Start > All Programs > Accessories > Sound Recorder**.
2. Click **Start Recording** and speak into the microphone. Save the file to your desktop.
3. Open Windows Media Player or MediaSmart and play back the sound.

 **NOTE:** For best results when recording, speak directly into the microphone and record sound in a setting free of background noise.

To confirm or change the audio settings on your computer, select **Start > Control Panel > Hardware and Sound > Sound**.



Using Beats Audio

Beats Audio is an enhanced audio profile that provides a deep controlled bass while maintaining a clear sound. Beats Audio is enabled by default.

- ▲ To increase or decrease the Beats Audio bass settings, press **fn+b**.

You can also view and control the bass settings through the Windows operating system. Select **Start > Control Panel > Sound > Speakers and Headphone Properties** to view and control the bass properties.

Identifying Beats Audio icons

Icon	Name	Description
	Beats Audio (connected)	Indicates that Beats Audio is enabled.
	Beats Audio (disconnected)	Indicates that Beats Audio is disabled.

Video

Your computer enables you to use a variety of video features:

- Watch movies
- Play games over the Internet
- Edit pictures and video and create presentations
- Connect external video devices
- Watch TV over the Internet

Connecting an external monitor or projector

To connect an external display such as a monitor or projector to the computer, connect the HP HDMI to VGA Display Adapter (select models only) to the HDMI port on the computer.

The HP HDMI to VGA Display Adapter supports the following resolutions:

- 800 × 600
- 1024 × 768
- 1280 × 720
- 1280 × 800
- 1280 × 1024
- 1400 × 1050
- 1440 × 900
- 1600 × 1200
- 1680 × 1050
- 1920 × 1080

To connect an external monitor or projector using the HDMI to VGA Display Adapter, follow these steps:

1. Connect the HDMI to VGA Display Adapter to the HDMI port on the computer.



2. Connect an external monitor or projector to the other end of the adapter.

NOTE: If a properly connected external display device does not display an image, press the [switch screen image](#) key to transfer the image to the device. Repeatedly pressing the [switch screen image](#) key alternates the screen image between the computer display and the device.

Connecting an HDMI device

The computer includes an HDMI (High Definition Multimedia Interface) port. The HDMI port connects the computer to an optional video or audio device, such as a high-definition television, or any compatible digital or audio component.

NOTE: To transmit video signals through the HDMI port, you need an HDMI cable (purchased separately).

The computer can support one HDMI device connected to the HDMI port, while simultaneously supporting an image on the computer display or any other supported external display.

To connect a video or audio device to the HDMI port:

1. Connect one end of the HDMI cable to the HDMI port on the computer.

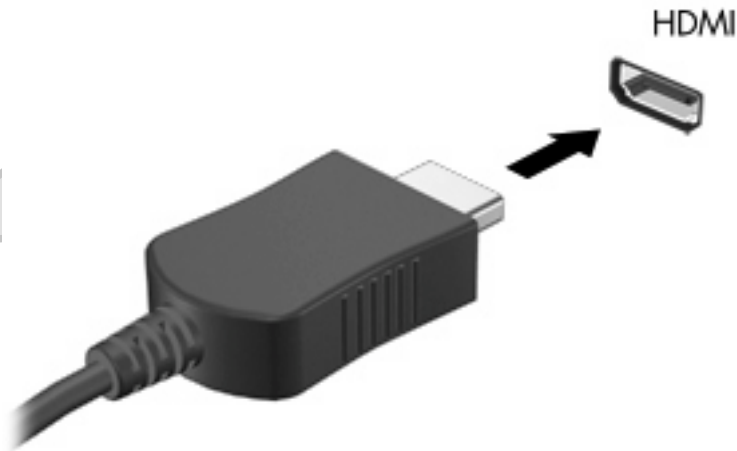

2. Connect the other end of the cable to the video device, according to the device manufacturer's instructions.
3. Press the [switch screen image](#) key on the computer to switch the image between the display devices connected to the computer.

Configuring audio for HDMI

To configure HDMI audio, first connect an audio or video device, such as a high-definition TV, to the HDMI port on your computer. Then configure the default audio playback device as follows:

1. Right-click the **Speakers** icon in the notification area, at the far right of the taskbar, and then click **Playback devices**.
2. On the **Playback** tab, click either **Digital Output** or **Digital Output Device (HDMI)**.
3. Click **Set Default**, and then click **OK**.

To return audio to the computer speakers, follow these steps:

1. Right-click the **Speakers** icon in the notification area, at the far right of the taskbar, and then click **Playback devices**.
2. On the **Playback** tab, click **Speakers**.
3. Click **Set Default**, and then click **OK**.

Webcam

Your computer includes an integrated webcam, located at the top of the display. With the preinstalled software, you can use the webcam to take a photo or record a video. You can preview the photo or video recording, and save it on your computer hard drive.

To use the webcam, select **Start > All Programs > HP > HP MediaSmart > HP MediaSmart Webcam**.

 **NOTE:** For more information on using HP MediaSmart, select **Start > Help and Support**, and type **MediaSmart** in the Search box.

The webcam software enables you to experiment with the following features:

- Capturing and sharing video
- Streaming video with instant message software
- Taking still photos

Webcam tips

For optimum performance, observe the following guidelines while using the integrated webcam:

- Be sure that you have the latest version of an instant message program before attempting a video conversation.
- Your integrated webcam may not work properly across some network firewalls. If you are having trouble viewing or sending video to someone on another LAN or outside your network firewall, contact your Internet service provider for assistance.

 **NOTE:** If you are having trouble viewing or sending multimedia files to someone on another LAN or outside your network firewall, temporarily disable the firewall, perform the task you want to perform, and then reenable the firewall. To permanently resolve the problem, reconfigure the firewall as necessary, and adjust the policies and settings of other intrusion detection systems.

- Whenever possible, place bright light sources behind the webcam and out of the picture area.

Adjusting webcam properties

You can adjust webcam properties using the Properties dialog box, which is accessible from various programs that use the integrated camera, usually from a configuration, settings, or properties menu:

- **Brightness**—Controls the amount of light that is incorporated into the image. A higher brightness setting creates a brighter image; a lower brightness setting creates a darker image.
- **Contrast**—Controls the difference between lighter and darker areas on the image. A higher contrast setting intensifies the image; a lower contrast setting maintains more of the original information's dynamic range but leads to a flatter image.
- **Hue**—Controls the aspect of color that distinguishes it from another color (what makes a color red, green, or blue). Hue is distinct from saturation, which measures the intensity of the hue.
- **Saturation**—Controls the strength of color in the final image. A higher saturation setting creates a bolder image; a lower saturation setting creates a more subtle image.
- **Sharpness**—Controls the definition of edges in an image. A higher sharpness setting creates a more defined image; a lower sharpness setting creates a softer image.

- **Gamma**—Controls the contrast affecting the mid-level grays or midtones of an image. Adjusting the gamma of an image allows you to change the brightness values of the middle range of gray tones without dramatically altering the shadows and highlights. A lower gamma setting makes grays look black, and makes dark colors even darker.
- **Backlight Comp**—Compensates in cases where a subject with a large amount of background light would otherwise be obscured by blooming or silhouetting.

For more information about using the webcam, select **Start > Help and Support**.

Using the ambient light sensor

The ambient light sensor (ALS) controls the display brightness and the webcam lighting in low-light conditions. The ambient light sensor includes the following features:

- Adaptive brightness
- Webcam infrared (IR) light

The ambient light sensor is enabled by default. To disable or reenable the ambient light sensor:

1. Select **Start > Control Panel > Hardware and Sound > Location and Other Sensors**.
2. Select the **Microsoft Windows ALS Device** check box.

Using adaptive brightness

Adaptive brightness automatically adjusts the screen brightness when the lighting conditions change. In low-light conditions, adaptive brightness automatically decreases the display brightness. As surrounding light increases, the display brightness level increases accordingly.

Adaptive brightness is enabled by default. To disable or reenable adaptive brightness:

 **NOTE:** The ambient light sensor must be enabled to use the adaptive brightness feature.

1. Select **Start > Control Panel > System and Security > Power Options**.
2. Click **Change plan setting**, and then click **Change advanced power settings**.
3. Click the plus sign next to **Display**, and then click the plus sign next to **Enable adaptive brightness**.
4. Change the settings as needed, and then click **Apply**.
5. Click **OK**.

Using the webcam IR light

The webcam IR light improves the webcam picture quality in low-light conditions. The webcam IR light turns on automatically when lighting conditions are very low. When the light conditions return to normal, the webcam IR light turns off automatically.

The webcam IR light behaves in the following ways:

- Normal lighting conditions—There will be no low light compensation and the webcam IR light will not be activated.
- Low light conditions—The Low Light Compensation function is activated and the picture quality improves.
- Extreme low light or zero light conditions—The webcam IR light is activated. This allows the webcam to operate in dark environments. Pictures are in black and white.

The webcam IR light is enabled by default. To disable or reenable the webcam IR light:

1. Select **Start > All Programs > HP > HP MediaSmart > HP MediaSmart Webcam**.
2. In HP MediaSmart Webcam, select **Settings > Display > Advanced Settings**, and then click the **Camera Control** tab.

3. Select the **Low Light Compensation** check box, and then click **Apply**.
4. Click **OK**.



NOTE: The webcam IR light is also available on other webcam programs. Refer to the software Help for additional information.

6 Power management

Setting power devices

Using power-saving states

The computer has two power-saving states enabled at the factory: Sleep and Hibernation.

When Sleep is initiated, the power light blinks and the screen clears. Your work is saved to memory, letting you exit Sleep faster than exiting Hibernation. If the computer is in the Sleep state for an extended period or if the battery reaches a critical battery level while in the Sleep state, the computer initiates Hibernation.

When Hibernation is initiated, your work is saved to a hibernation file on the hard drive and the computer turns off.

△ **CAUTION:** To prevent possible audio and video degradation, loss of audio or video playback functionality, or loss of information, do not initiate Sleep or Hibernation while reading from or writing to a disc or an external media card.

📝 **NOTE:** You cannot initiate any type of networking connection or perform any computer functions while the computer is in the Sleep state or in Hibernation.

Initiating and exiting Sleep

The system is set at the factory to initiate Sleep after 15 minutes of inactivity when running on battery power and 30 minutes of inactivity when running on external power.

Power settings and timeouts can be changed using Power Options in Windows® Control Panel.

With the computer on, you can initiate Sleep in any of the following ways:

- Briefly press the power button.
- Close the display.
- Click **Start**, click the arrow next to the Shut down button, and then click **Sleep**.

You can exit Sleep in any of the following ways:

- Briefly press the power button.
- If the display is closed, open the display.
- Press a key on the keyboard.
- Activate the TouchPad.

When the computer exits Sleep, the power light turns on and your work returns to the screen where you stopped working.

📝 **NOTE:** If you have set a password to be required on wakeup, you must enter your Windows password before your work will return to the screen.

Initiating and exiting Hibernation

The system is set at the factory to initiate Hibernation after 1,080 minutes (18 hours) of inactivity when running on battery power, 1,080 minutes (18 hours) of inactivity when running on external power, or when the battery reaches a critical battery level.

Power settings and timeouts can be changed using Power Options in Windows Control Panel.

To initiate Hibernation:

- ▲ Click **Start**, click the arrow next to the Shut down button, and then click **Hibernate**.

To exit Hibernation:

- ▲ Briefly press the power button.

The power light turns on and your work returns to the screen where you stopped working.

 **NOTE:** If you have set a password to be required on wakeup, you must enter your Windows password before your work will return to the screen.

Conserving power

- Select the Power saver power plan through Power Options under **System and Security** in Windows Control Panel.
- Turn off wireless and local area network (LAN) connections and exit modem applications when you are not using them.
- Disconnect external devices that are not plugged into an external power source, when you are not using them.
- Stop, disable, or remove any external media cards that you are not using.
- Use the screen brightness keys to adjust screen brightness as needed.
- If you leave your work, initiate Sleep or Hibernation, or shut down the computer.

Using the battery meter

The battery meter is located in the notification area, at the far right of the taskbar. The battery meter allows you to quickly access power settings, view remaining battery charge, and select a different power plan.

- To display the percentage of remaining battery charge and the current power plan, move the pointer over the battery meter icon.
- To access Power Options, or to change the power plan, click the battery meter icon and select an item from the list.

Different battery meter icons indicate whether the computer is running on battery or external power. The icon also displays a message if the battery has reached a low battery level, critical battery level, or reserve battery level.

To hide or display the battery meter icon:

1. Right-click the **Show hidden icons** icon (the arrow at the left side of the notification area).
2. Click **Customize notification icons**.
3. Under **Behaviors**, select **Show icon and notifications** for the Power icon.
4. Click **OK**.

Using power plans

A power plan is a collection of system settings that manages how the computer uses power. Power plans can help you conserve power or maximize performance.

You can change power plan settings or create your own power plan.

Viewing the current power plan

- ▲ Click the battery meter icon in the notification area, at the far right of the taskbar.

– or –

Select **Start > Control Panel > System and Security > Power Options**.

Selecting a different power plan

- ▲ Click the battery meter icon in the notification area, and then select a power plan from the list.

– or –

Select **Start > Control Panel > System and Security > Power Options**, and then select a power plan from the list.

Customizing power plans

1. Click the battery meter icon in the notification area and then click **More power options**.

– or –

Select **Start > Control Panel > System and Security > Power Options**.

2. Select a power plan, and then click **Change plan settings**.
3. Change the settings as needed.
4. To change additional settings, click **Change advanced power settings** and make your changes.

Setting password protection on wakeup

To set the computer to prompt for a password when the computer exits Sleep or Hibernation, follow these steps:

1. Select **Start > Control Panel > System and Security > Power Options**.
2. In the left pane, click **Require a password on wakeup**.
3. Click **Change Settings that are currently unavailable**.
4. Click **Require a password (recommended)**.



NOTE: If you need to create a user account password or change your current user account password, click **Create or change your user account password**, and then follow the on-screen instructions. If you do not need to create or change a user account password, go to step 5.

5. Click **Save changes**.

Using external AC power

External AC power is supplied through an approved AC adapter.

⚠ WARNING! To reduce potential safety issues, use only the AC adapter provided with the computer, a replacement AC adapter provided by HP, or a compatible AC adapter purchased from HP.

Connect the computer to external AC power under any of the following conditions:

- When you are charging or calibrating a battery

⚠ WARNING! Do not charge the computer battery while you are onboard aircraft.

- When you are installing or modifying system software
- When you are writing information to an optional external CD or DVD

When you connect the computer to external AC power, the following events occur:

- The battery begins to charge.
- If the computer is turned on, the battery meter icon in the notification area changes appearance.

When you disconnect external AC power, the following events occur:

- The computer switches to battery power.
- The display brightness is automatically decreased to save battery life. To increase display brightness, press the [increase display brightness](#) key or reconnect the AC adapter.

Connecting AC power

⚠ WARNING! To reduce the risk of electric shock or damage to the equipment:

Plug the power cord into an AC outlet that is easily accessible at all times.

Disconnect power from the computer by unplugging the power cord from the AC outlet (not by unplugging the power cord from the computer).

If provided with a 3-pin attachment plug on the power cord, plug the cord into a grounded (earthed) 3-pin outlet. Do not disable the power cord grounding pin, for example, by attaching a 2-pin adapter. The grounding pin is an important safety feature.

To connect the computer to external AC power:

1. Plug the adapter into the power connector **(1)** on the computer.
2. Plug the power cord into the adapter **(2)**.

3. Plug the other end of the power cord into an AC outlet (3).



Testing an AC adapter

Test the AC adapter if the computer exhibits any of the following symptoms when it is connected to AC power:

- The computer will not turn on.
- The display does not turn on.
- The power light is off.

To test the AC adapter:

1. Remove the battery from the computer.
2. Connect the AC adapter to the computer, and then plug it into an AC outlet.
3. Turn on the computer.
 - If the power light turns **on**, the AC adapter is working properly.
 - If the power light remains **off**, the AC adapter is not functioning and should be replaced.

Contact technical support for information on obtaining a replacement AC power adapter. Select **Start > Help and Support > Get assistance**.

Using battery power

When a charged battery is in the computer and the computer is not plugged into external power, the computer runs on battery power. When the computer is plugged into external AC power, the computer runs on AC power.

If the computer contains a charged battery and is running on external AC power supplied through the AC adapter, the computer switches to battery power if the AC adapter is disconnected from the computer.

 **NOTE:** The display brightness is decreased to save battery life when you disconnect AC power. To increase display brightness, press the [increase screen brightness](#) key or reconnect the AC adapter.

You can keep a battery in the computer or in storage, depending on how you work. Keeping the battery in the computer whenever the computer is plugged into AC power charges the battery and also protects your work in case of a power outage. However, a battery in the computer slowly discharges when the computer is off and unplugged from external power.

 **WARNING!** To reduce potential safety issues, use only the battery provided with the computer, a replacement battery provided by HP, or a compatible battery purchased from HP.

Computer battery life varies, depending on power management settings, programs running on the computer, display brightness, external devices connected to the computer, and other factors.

Identifying batteries

The computer can support 2 batteries:

- One lithium-ion primary battery is included with the computer and is installed at the factory.
- An optional accessory battery (purchased separately) can be attached to the bottom of the computer in addition to the primary battery.

Finding battery information in Help and Support

Help and Support provides the following tools and information about the battery:

- Battery Check tool to test battery performance
- Information on calibration, power management, and proper care and storage to maximize battery life
- Information on battery types, specifications, life cycles, and capacity

To access battery information:

- ▲ Select **Start > Help and Support > Learn > Power Plans: Frequently Asked Questions.**

Using Battery Check

 **NOTE:** Battery Check can be performed only on the primary battery. Remove any additional batteries before performing Battery Check

Help and Support provides information on the status of the battery installed in the computer.

To run Battery Check:

1. Connect the AC adapter to the computer.

 **NOTE:** The computer must be connected to external power for Battery Check to function properly.

2. Select **Start > Help and Support > Troubleshoot > Power, Thermal and Mechanical**.
3. Click the **Power** tab, and then click **Battery Check**.

Battery Check examines the battery and its cells to see if they are functioning properly, and then reports the results of the examination.

Displaying the remaining battery charge

- ▲ Move the pointer over the battery meter icon in the notification area, at the far right of the taskbar.

Removing or inserting the primary battery

△ **CAUTION:** Removing a battery that is the sole power source can cause loss of information. To prevent loss of information, initiate Hibernation or shut down the computer through Windows before removing the battery.

To remove the primary battery:

1. Shut down the computer and close the display.
2. Turn the computer upside down on a flat surface.
3. Slide the battery lock **(1)** to the right to unlock the battery.
4. Slide the battery release latch **(2)** to the right to release the battery.

 **NOTE:** The battery release latch automatically returns to its original position.

5. Raise the battery and remove it from the battery bay **(3)**.

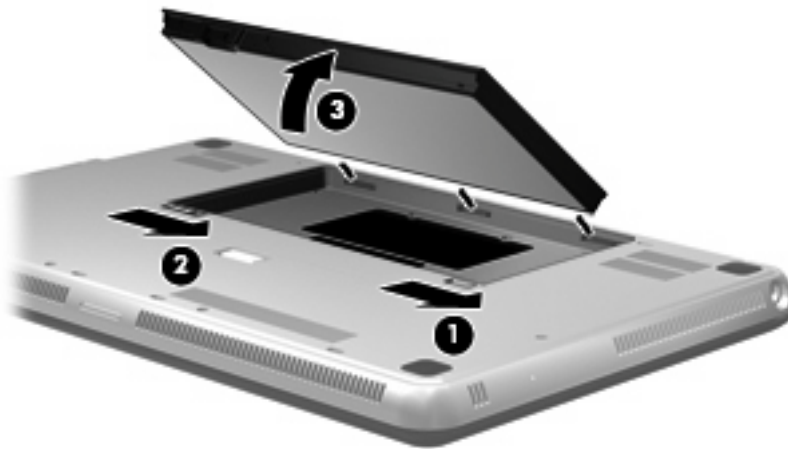

To insert the primary battery:

1. Shut down the computer and close the display.
2. Turn the computer upside down on a flat surface.

3. Align the tabs on the battery with the notches on the outer edge of the battery bay (1) and lower the battery into the battery bay until it is seated (2).
4. Slide the battery lock (3) to lock the battery into place.



Charging a battery

⚠ WARNING! Do not charge the computer battery while you are onboard aircraft.

The battery charges whenever the computer is plugged into external power through an AC adapter or an optional power adapter.

The battery charges whether the computer is off or in use, but it charges faster when the computer is off.

Charging may take longer if a battery is new, has been unused for 2 weeks or more, or is much warmer or cooler than room temperature.

To prolong battery life and optimize the accuracy of battery charge displays, follow these recommendations:

- If you are charging a new battery, charge it fully before turning on the computer.
- Charge the battery until the battery light turns white.

📄 NOTE: If the computer is on while the battery is charging, the battery meter in the notification area may show 100 percent charge before the battery is fully charged.

- Allow the battery to discharge below 5 percent of a full charge through normal use before charging it.
- If the battery has been unused for one month or more, calibrate the battery instead of simply charging it.

The battery light on the computer displays the following charge status:

- Off: The computer is running on battery power.
- Blinking amber: The battery has reached a low battery level, a critical battery level, or there is a battery error.

- Amber: The battery is charging.
- White: The computer is connected to external power and the battery is fully charged.

Maximizing battery discharge time

Battery discharge time varies depending on the features you use while on battery power. Maximum discharge time gradually shortens, as the battery storage capacity naturally degrades.

Tips for maximizing battery discharge time:

- Lower the brightness on the display.
- Check the **Power saver** setting in Power Options.
- Remove the battery from the computer when it is not being used or charged.
- Store the battery in a cool, dry location.

Managing low battery levels

The information in this section describes the alerts and system responses set at the factory. Some low-battery alerts and system responses can be changed using Power Options in Windows Control Panel. Preferences set using Power Options do not affect lights.

Identifying low battery levels

When a battery that is the sole power source for the computer reaches a low or critical battery level, the battery meter icon in the notification area shows a low or critical battery notification.

When the battery reaches a critical battery level, a notification appears above the battery meter icon that shows how much battery charge remains.

 **NOTE:** For additional information on the battery meter, refer to [Using the battery meter on page 50](#).

The computer takes the following actions for a critical battery level:

- If Hibernation is enabled and the computer is on or in the Sleep state, the computer initiates Hibernation.
- If Hibernation is disabled and the computer is on or in the Sleep state, the computer remains briefly in the Sleep state, and then shuts down and loses any unsaved information.

Resolving a low battery level

△ **CAUTION:** To reduce the risk of losing information when the computer reaches a critical battery level and has initiated Hibernation, do not restore power until the power light turns off.

Resolving a low battery level when external power is available

- ▲ Connect one of the following devices:
 - AC adapter
 - Optional power adapter purchased as an accessory from HP

Resolving a low battery level when a charged battery is available

1. Turn off the computer or initiate Hibernation.
2. Remove the discharged battery, and then insert a charged battery.
3. Turn on the computer.

Resolving a low battery level when no power source is available

- ▲ Initiate Hibernation.
 - or –
 - Save your work and shut down the computer.

Resolving a low battery level when the computer cannot exit Hibernation

When the computer lacks sufficient power to exit Hibernation, follow these steps:

1. Insert a charged battery or plug the computer into external power.
2. Exit Hibernation by pressing the power button.

Using the accessory battery (select models only)

An accessory battery can add hours of battery life to your computer.

Identifying the accessory battery components

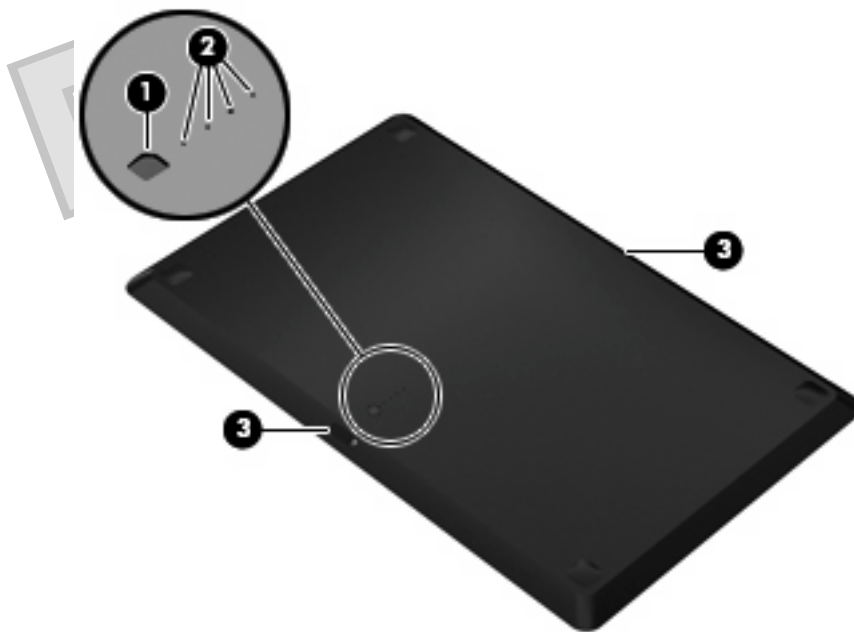

Component	Description
(1) Battery fuel gauge	When pressed, the battery fuel gauge checks the amount of available battery charge.
(2) Battery charge lights	Show the percentage of available battery power. <ul style="list-style-type: none">• Blinking: The accessory battery has reached a low battery level.• One light on: The accessory battery has 25 percent remaining battery charge.• Two lights on: The accessory battery has 50 percent remaining battery charge.• Three lights on: The accessory battery has 75 percent remaining battery charge.• Four lights on: The accessory battery is fully charged.
(3) Battery release latches	Release the battery from the bottom of the computer.

Inserting or removing an accessory battery

△ **CAUTION:** Removing a battery that is the sole power source can cause loss of information. To prevent loss of information, save your work before removing the battery.

To insert the accessory battery:

📄 **NOTE:** When you install the accessory for the first time, be sure to remove the protective cover on the accessory battery connector.

NOTE: It is not necessary to turn off the computer before inserting or removing the accessory battery.

1. Turn the computer upside down on a flat surface, with the battery bay toward you.
2. Align the accessory battery with the bottom of the computer, with the battery fuel gauge toward you.
3. Press the accessory battery down until it is seated **(1)**.
4. Slide the battery release latches **(2)** to lock the accessory battery into place on the computer.

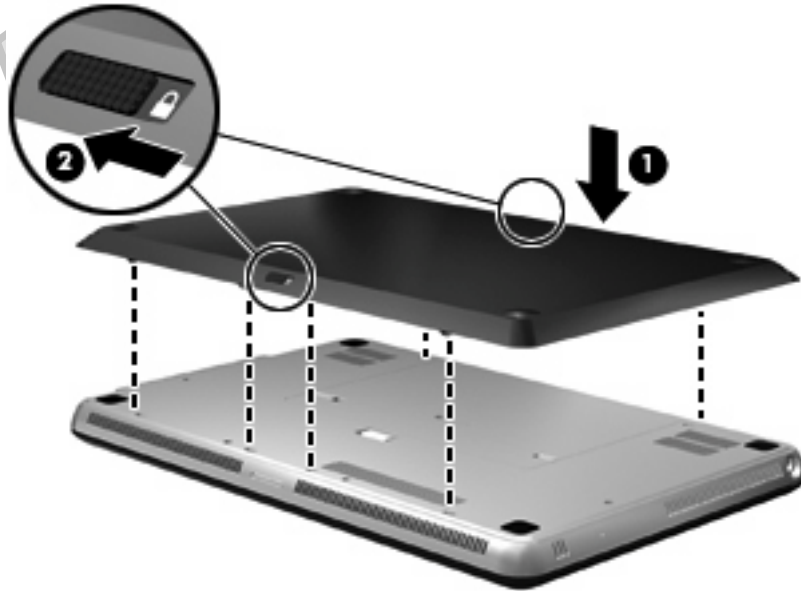

To remove the accessory battery:

1. Turn the computer upside down on a flat surface.
2. Slide the battery release latches **(1)** to release the accessory battery.

3. Lift the accessory battery from the bottom of the computer (2).

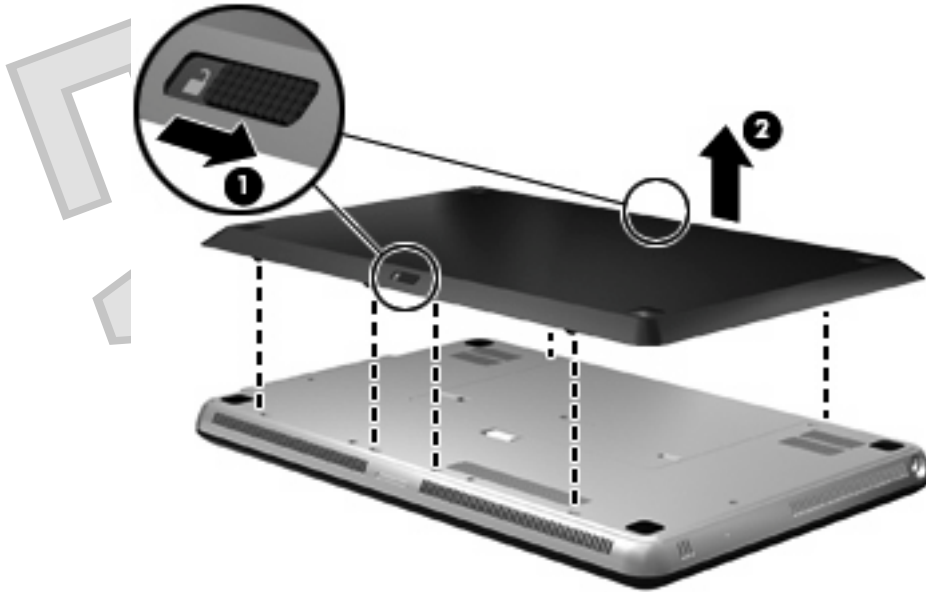

Battery charging and discharging sequence

Battery charging and discharging sequence varies when both the primary battery and optional accessory battery are installed.

- The computer supports Fast Charge Mode (enabled at the factory). When both batteries are charging, the primary battery will charge to 90 percent before the accessory battery begins charging. Charging is then switched to the accessory battery. When the accessory battery reaches 90 percent, the primary battery will then charge to 100 percent. After the primary battery is completely charged, the accessory battery will charge to 100 percent.

 **NOTE:** Fast Charge Mode can be disabled in Setup Utility (BIOS). If Fast Charge Mode is disabled, the primary battery will charge to 100 percent before the accessory battery begins charging. Refer to [Setup Utility \(BIOS\) on page 93](#) for additional information.

- When the accessory battery reaches a critical battery level, battery power is transferred to the primary battery.
- The accessory battery will discharge before the primary battery discharges.
- When the accessory battery is removed from the computer, battery power is transferred to the primary battery.
- When the accessory battery is inserted in the computer, battery power is transferred to the accessory battery.

Calibrating a battery

To maximize battery performance, you should calibrate a battery under the following conditions:

- When battery charge displays seem inaccurate
- When you observe a significant change in battery run time

Even if a battery is heavily used, it should not need to be calibrated more than once a month. It is also not necessary to calibrate a new battery.

 **NOTE:** To calibrate a battery and for additional information, select **Start > Help and Support**.

Storing a battery

△ **CAUTION:** To prevent damage to a battery, do not expose it to high temperatures for extended periods of time.

If a computer will be unused and unplugged from external power for more than 2 weeks, remove the battery and store it separately.

To prolong the charge of a stored battery, place it in a cool, dry place.

 **NOTE:** A stored battery should be checked every 6 months. If the capacity is less than 50 percent, recharge the battery before returning it to storage.

Calibrate a battery before using it if it has been stored for one month or more.

Disposing of a used battery

△ **WARNING!** To reduce the risk of fire or burns, do not disassemble, crush, or puncture; do not short external contacts; do not dispose of in fire or water.

Refer to the *Regulatory, Safety and Environmental Notices* for proper battery disposal.

Replacing the battery

Computer battery life varies, depending on power management settings, programs running on the computer, display brightness, external devices connected to the computer, and other factors.

Battery Check notifies you to replace the battery when an internal cell is not charging properly, or when the battery storage capacity has reached a “weak” condition. A message refers you to the HP Web site for more information about ordering a replacement battery. If the battery is possibly covered by an HP warranty, instructions include a warranty ID.

 **NOTE:** To ensure that you always have battery power when you need it, HP recommends purchasing a new battery when the storage capacity indicator turns green-yellow.

Shutting down the computer

△ **CAUTION:** Unsaved information will be lost when the computer is shut down.

The Shut down command closes all open programs, including the operating system, and then turns off the display and computer.

Shut down the computer under any of the following conditions:

- When you need to replace the battery or access components inside the computer
- When you are connecting an external hardware device that does not connect to a USB port
- When the computer will be unused and disconnected from external power for an extended period

Although you can shut down the computer with the power button, the recommended procedure is to use the Windows Shut down command.

To shut down the computer:

📄 **NOTE:** If the computer is in the Sleep state or in Hibernation, you must first exit Sleep or Hibernation before shutdown is possible.

1. Save your work and close all open programs.
2. Click **Start**.
3. Click **Shut down**.

If the computer is unresponsive and you are unable to use the preceding shutdown procedures, try the following emergency procedures in the sequence provided:

- Press **ctrl+alt+delete**, and then click the **Power** button.
- Press and hold the power button for at least 5 seconds.
- Disconnect the computer from external power and remove the battery.

7 Drives and external devices

Antenna House XSL Formatter

Drives

Identifying installed drives

Your computer includes a hard drive (with a rotating disc) or a solid-state drive (SSD) with solid-state memory. Because it has no moving parts, an SSD does not generate as much heat as a hard drive.

Select computer models can support up to two drives. To view the drives installed on the computer, select **Start > Computer**.

Computers with two SSDs installed will ship in a RAID 0 configuration. To view the two SSDs and RAID 0 configuration:

1. Turn on or restart the computer.
2. When the **POST** screen opens, press **ctrl+l** to enter the configuration utility.
3. Under **Disk/Volume Information**, RAID 0 (Stripe) and the two SSDs will be listed.

 **NOTE:** For additional information on RAID 0, refer to [RAID 0 \(select models only\) on page 107](#).

NOTE: Windows® includes the User Account Control feature to improve the security of your computer. You may be prompted for your permission or password for tasks such as installing applications, running utilities, or changing Windows settings. Refer to Help and Support for more information.

Handling drives

Drives are fragile computer components that must be handled with care. Refer to the following cautions before handling drives. Additional cautions are included with the procedures to which they apply.

△ **CAUTION:** To reduce the risk of damage to the computer, damage to a drive, or loss of information, observe these precautions:

Before you move a computer that is connected to an external hard drive, initiate Sleep and allow the screen to clear, or properly disconnect the external hard drive.

Handle a drive carefully; do not drop a drive or place items on it.

When the battery is the only source of power, be sure that the battery is sufficiently charged before writing to media.

Avoid exposing a drive to temperature or humidity extremes.

Avoid exposing a drive to liquids. Do not spray the drive with cleaning products.

Avoid exposing a drive to magnetic fields. Security devices with magnetic fields include airport walk-through devices and security wands. The airport security devices that check carry-on luggage, such as conveyor belts, use X-rays instead of magnetism and will not damage a drive.

Improving hard drive performance

Using Disk Defragmenter

As you use the computer, files on the hard drive become fragmented. Disk Defragmenter consolidates the fragmented files and folders on the hard drive so that the system can run more efficiently.

 **NOTE:** It is not necessary to run Disk Defragmenter on solid-state drives.

To run Disk Defragmenter:

1. Select **Start > All Programs > Accessories > System Tools > Disk Defragmenter**.
2. Click **Defragment disk**.

 **NOTE:** Windows® includes the User Account Control feature to improve the security of your computer. You may be prompted for your permission or password for tasks such as installing applications, running utilities, or changing Windows settings. Refer to Help and Support for more information.

For additional information, access the Disk Defragmenter software Help.

Using Disk Cleanup

Disk Cleanup searches the hard drive for unnecessary files that you can safely delete to free up disk space and help the computer to run more efficiently.

To run Disk Cleanup:

1. Select **Start > All Programs > Accessories > System Tools > Disk Cleanup**.
2. Follow the on-screen instructions.

Using HP ProtectSmart Hard Drive Protection (select models only)

HP ProtectSmart Hard Drive Protection protects a hard drive by parking the drive and halting data requests under either of the following conditions:

- You drop the computer.
- You move the computer with the display closed while the computer is running on battery power.

A short time after the end of one of these events, HP ProtectSmart Hard Drive Protection returns the hard drive to normal operation.

 **NOTE:** Because solid-state drives (SSD) lack moving parts, HP ProtectSmart Hard Drive Protection is unnecessary.

NOTE: Hard drives in the primary hard drive bay or in the secondary hard drive bay are protected by HP ProtectSmart Hard Drive Protection. Hard drives connected to USB ports are not covered by HP ProtectSmart Hard Drive Protection.

For more information, refer to the HP ProtectSmart Hard Drive Protection software Help.

Identifying HP ProtectSmart Hard Drive Protection status

The drive light on the computer changes to an amber color to show that a drive in the primary hard drive bay or a drive in the secondary hard drive bay (select models only) is parked. To determine whether drives are currently protected or whether a drive is parked, select **Start > Control Panel > Hardware and Sound > Windows Mobility Center**:

- If the software is enabled, a green check mark is superimposed over the hard drive icon.
- If the software is disabled, a red X is superimposed over the hard drive icon.
- If the drives are parked, a yellow moon is superimposed over the hard drive icon.

The icon in the Mobility Center may not show the most up-to-date status for the drive. For immediate updates after a change in status, you need to enable the notification area icon.

To enable the notification area icon:

1. Select **Start > Control Panel > Hardware and Sound > HP ProtectSmart Hard Drive Protection**.

 **NOTE:** If prompted by User Account Control, click **Yes**.

2. On the **Icon in System Tray** row, click **Show**.
3. Click **OK**.

Managing power with a parked hard drive

If HP ProtectSmart Hard Drive Protection has parked the drive, the computer will behave in the following ways:

- The computer will not shut down.
- The computer will not initiate Sleep or Hibernation, except as described in the following Note.

 **NOTE:** If the computer is running on battery power and reaches a critical battery level, HP ProtectSmart Hard Drive Protection allows the computer to initiate Hibernation.

Before you move the computer, HP recommends that you either shut it down or initiate Sleep or Hibernation.

Using HP ProtectSmart Hard Drive Protection software

The HP ProtectSmart Hard Drive Protection software enables you to perform the following tasks:

- Enable and disable HP ProtectSmart Hard Drive Protection.

 **NOTE:** Depending on your user privileges, you may not be able to enable or disable HP ProtectSmart Hard Drive Protection. Additionally, members of an Administrator group can change the privileges for non-Administrator users.

- Determine whether a drive in the system is supported.

To open the software and change settings, follow these steps:

1. In Mobility Center, click the hard drive icon to open the HP ProtectSmart Hard Drive Protection window.

– or –

Select **Start > Control Panel > Hardware and Sound > HP ProtectSmart Hard Drive Protection**.

 **NOTE:** If prompted by User Account Control, click **Yes**.

2. Click the appropriate button to change settings.
3. Click **OK**.

Using external drives

Removable external drives expand your options for storing and accessing information.

USB drives include the following types:

- 1.44-megabyte diskette drive
- Hard drive module (a hard drive with an adapter attached)
- DVD-ROM Drive
- DVD±RW SuperMulti Double-Layer (DL) Drive
- Blu-ray ROM DVD±R/RW SuperMulti Double-Layer (DL) Drive

Connecting optional external drives

 **NOTE:** For more information about required software and drivers, or to learn which computer port to use, refer to the manufacturer's instructions.

To connect an external drive to the computer:

 **CAUTION:** To reduce the risk of damage to the equipment when connecting a powered drive, be sure that the drive is turned off and the AC power cord is unplugged.

1. Connect the drive to the computer.
2. If you are connecting a powered drive, plug the device power cord into a grounded AC outlet.
3. Turn on the drive.

To disconnect an unpowered external drive, turn off the drive, and then disconnect it from the computer. To disconnect a powered external drive, turn off the drive, disconnect it from the computer, and then unplug the AC power cord.

Using the external optical drive (select models only)

Select computer models ship with an external optical drive. An external optical drive connects to a USB port on the computer and enables you to read data discs, play music, and watch movies. If your external optical drive includes a Blu-ray Disc (BD) drive, also known as a BD, you can also watch high-definition video from discs.

You may have one of the following types of drives:

- DVD±RW SuperMulti Double-Layer (DL) Drive
- Blu-ray ROM DVD±R/RW SuperMulti Double-Layer (DL) Drive

The external optical drive can be either a tray load or slot load drive. The optical drive also contains two additional USB ports.



Removing an optical disc when the disc tray will not open

If your optical drive is a tray load drive and the disc tray does not open, follow these steps:

1. Insert the end of a paper clip (1) into the release access in the front bezel of the drive.
2. Press gently on the paper clip until the tray is released, and then pull out the tray (2) until it stops.
3. Remove the disc (3) from the tray by gently pressing down on the spindle while lifting the outer edges of the disc. Hold the disc by the edges and avoid touching the flat surfaces.

 **NOTE:** If the tray is not fully accessible, tilt the disc carefully as you remove it.



4. Close the disc tray and place the disc in a protective case.

Sharing optical drives

Although your computer does not have an integrated optical drive, you can easily access software, install applications, and access data by sharing an optical drive connected to another computer in your network. Sharing drives is a feature of the Windows operating system that allows a drive on one computer to be accessible to other computers on the same network.

 **NOTE:** You must have a network set up in order to share an optical drive; refer to [Wireless and local area network on page 14](#) for additional information on setting up a network.

NOTE: Some discs, such as DVD movies and game discs, may be copy-protected and therefore unusable through DVD or CD sharing.

To share an optical drive:

1. From the computer with the optical drive you are sharing, select **Start > Computer**.
2. Right-click the optical drive you want to share, and click **Properties**.
3. Select the **Sharing** tab > **Advanced Sharing**.
4. Select the **Share this folder** check box.
5. Type a name for the optical drive in **Share name**.
6. Click **Apply**, and then click **OK**.
7. To view the shared optical drive on your computer, select **Start > Control Panel > Network and Sharing Center > View computers and devices**.

External devices

Using a USB device

A USB port connects an optional external device, such as a USB keyboard, mouse, drive, printer, scanner, or hub, to the computer.

Some USB devices may require additional support software, which is usually included with the device. For more information about device-specific software, refer to the manufacturer's instructions.

The computer has 2 USB ports, which support USB 1.0, USB 1.1, USB 2.0 devices. Select models also support USB 3.0 devices. To add more USB ports, connect an optional hub.

Connecting a USB device

△ **CAUTION:** To prevent damage to a USB connector, use minimal force to connect a USB device.

▲ To connect a USB device to the computer, connect the USB cable for the device to the USB port.



You will hear a sound when the device has been detected.

📄 **NOTE:** The first time you connect a USB device, the "Installing device driver software" message is displayed in the notification area, at the far right of the taskbar.

Removing a USB device

△ **CAUTION:** To prevent loss of information or an unresponsive system, use the following procedure to safely remove the USB device.

CAUTION: To prevent damage to a USB connector, do not pull on the cable to remove the USB device.

To remove a USB device:

1. Click the **Safely Remove Hardware and Eject Media** icon in the notification area, at the far right of the taskbar.

 **NOTE:** To display the Safely Remove Hardware and Eject Media icon, click the **Show hidden icons** icon (the arrow at the left of the notification area).

2. Click the name of the device in the list.

 **NOTE:** You are prompted that it is safe to remove the hardware device.

3. Remove the device.

Using an eSATA device

An eSATA port connects an optional high-performance eSATA component, such as an eSATA external hard drive.

Some eSATA devices may require additional support software, which is usually included with the device. For more information about device-specific software, refer to the manufacturer's instructions.

 **NOTE:** The eSATA port also supports an optional USB device.

Connecting an eSATA device

△ **CAUTION:** To prevent damage to an eSATA port connector, use minimal force to connect an eSATA device.

- ▲ To connect an eSATA device to the computer, connect the eSATA cable for the device to the eSATA port.

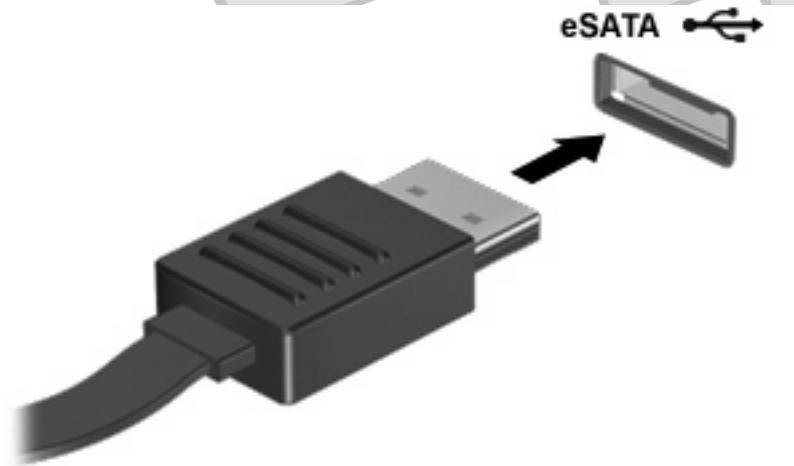

You will hear a sound when the device has been detected.

Removing an eSATA device

△ **CAUTION:** To prevent loss of information or an unresponsive system, use the following procedure to safely remove the device.

CAUTION: To prevent damage to an eSATA connector, do not pull on the cable to remove the eSATA device.

1. Click the **Safely Remove Hardware and Eject Media** icon in the notification area, at the far right of the taskbar.

 **NOTE:** To display the Safely Remove Hardware and Eject Media icon, click the **Show hidden icons** icon (the arrow at the left of the notification area).

2. Click the name of the device in the list.

 **NOTE:** You are prompted that it is safe to remove the hardware device.

3. Remove the device.

Using Digital Media Slot cards

Optional digital cards provide secure data storage and convenient data sharing. These cards are often used with digital media-equipped cameras and PDAs as well as with other computers.

The Digital Media Slot supports the following digital card formats:

- MultiMediaCard
- Micro MultiMediaCard (adapter required)
- MultiMediaCard Plus
- Secure Digital Memory Card
- Micro Secure Digital Memory Card (adapter required)
- Secure Digital High Capacity Memory Card

Inserting a digital card

△ **CAUTION:** To prevent damage to the digital card connectors, use minimal force to insert a digital card.

1. Hold the digital card label-side up, with the connectors facing the computer.
2. Insert the card into the Digital Media Slot, and then push in on the card until it is firmly seated.

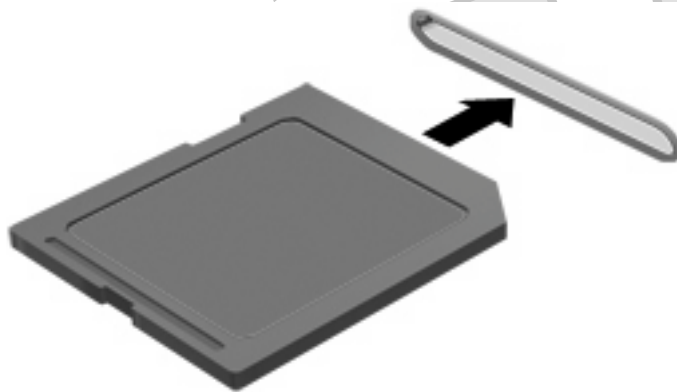

You will hear a sound when the device has been detected, and a menu of options may be displayed.

Removing a digital card

△ **CAUTION:** To prevent loss of data or an unresponsive system, use the following procedure to safely remove the digital card.

1. Save your information and close all programs associated with the digital card.

📝 **NOTE:** To stop a data transfer, click **Cancel** in the operating system Copying window.

2. To remove a digital card:

a. Click the **Safely Remove Hardware and Eject Media** icon in the notification area, at the far right of the taskbar.

📝 **NOTE:** To display the Safely Remove Hardware and Eject Media icon, click the **Show hidden icons** icon (the arrow at the left of the notification area).

b. Click the name of the digital card in the list.

📝 **NOTE:** You are prompted that it is safe to remove the hardware device.

3. Pull the digital card from the slot.

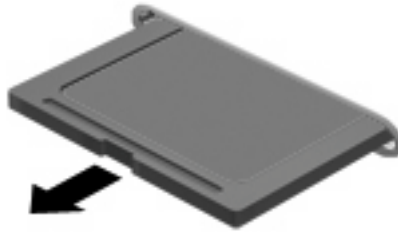

8 Memory modules

Depending on the computer model, your computer has either one or two memory module slots. The memory module slots are located on the bottom of the computer. The memory capacity of the computer can be upgraded by adding a memory module or replacing the existing memory module in one of the memory module slots.

- △ **WARNING!** To reduce the risk of electric shock and damage to the equipment, unplug the power cord and remove all batteries before installing a memory module.
- △ **CAUTION:** Electrostatic discharge (ESD) can damage electronic components. Before beginning any procedure, touch a grounded metal object to be sure that you are discharged of static electricity.

Adding or replacing a memory module in single-slot models

To add or replace a memory module:

1. Save your work.
2. Shut down the computer and close the display.
If you are not sure whether the computer is off or in Hibernation, turn the computer on by briefly pressing the power button. Then shut down the computer through the operating system.
3. Disconnect all external devices connected to the computer.
4. Unplug the power cord from the AC outlet.
5. Turn the computer upside down on a flat surface.
6. Remove the battery from the computer.
7. Loosen the memory module compartment cover screws (1) and lift the memory module compartment cover (2) away from the computer.

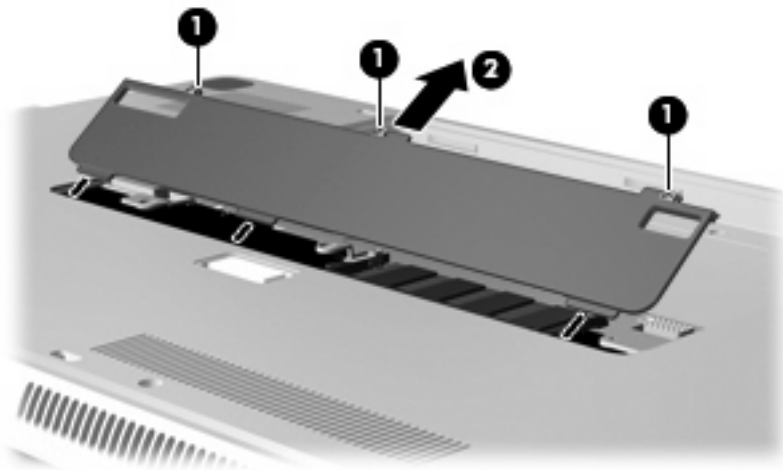

8. Remove a memory module in the memory module slot:

- a. Pull away the retention clips (1) on each side of the memory module.

△ **CAUTION:** To prevent damage to the memory module, hold the memory module by the edges only. Do not touch the components on the memory module.

- b. Grasp the edge of the memory module (2), gently rotate the module up, and then pull it out of the memory module slot.

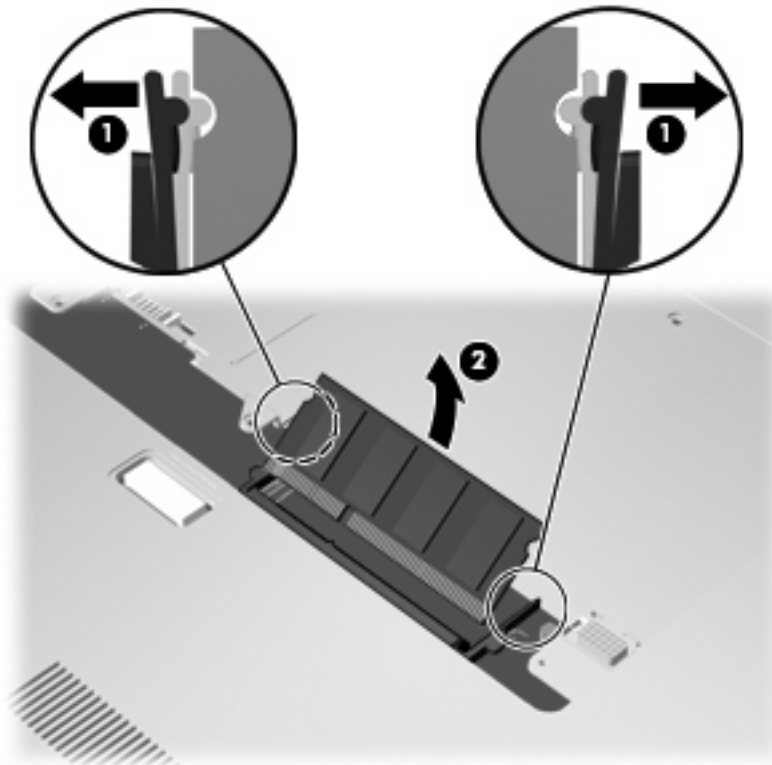

To protect the memory module after removal, place it in an electrostatic-safe container.

- 9. Insert a memory module in the memory module slot:
 - a. Align the notched edge (1) of the memory module with the tab in the top memory module slot.
 - b. Insert the memory module into the memory module slot and rotate the module downward (2) until it is seated and the retention clips (3) snap into place.

△ **CAUTION:** To prevent damage to the memory module, hold the memory module by the edges only. Do not touch the components on the memory module.

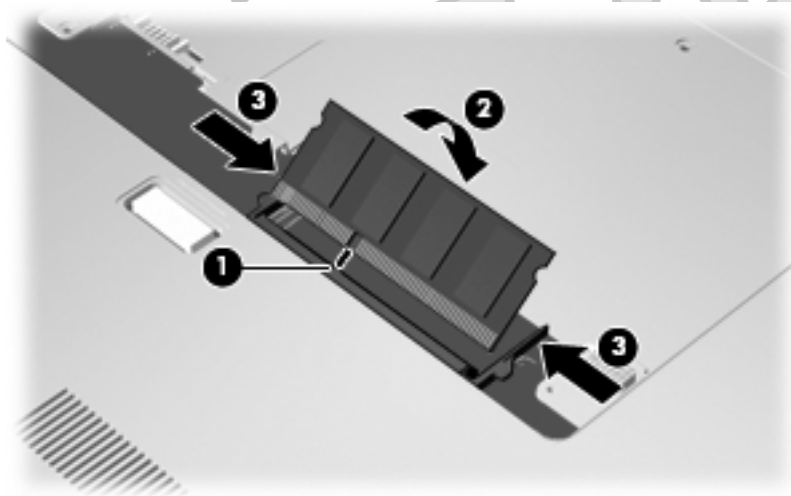

10. Align the tabs (1) on the memory module compartment cover with the notches on the computer.
11. Close the cover (2).
12. Tighten the memory module compartment cover screws (3).

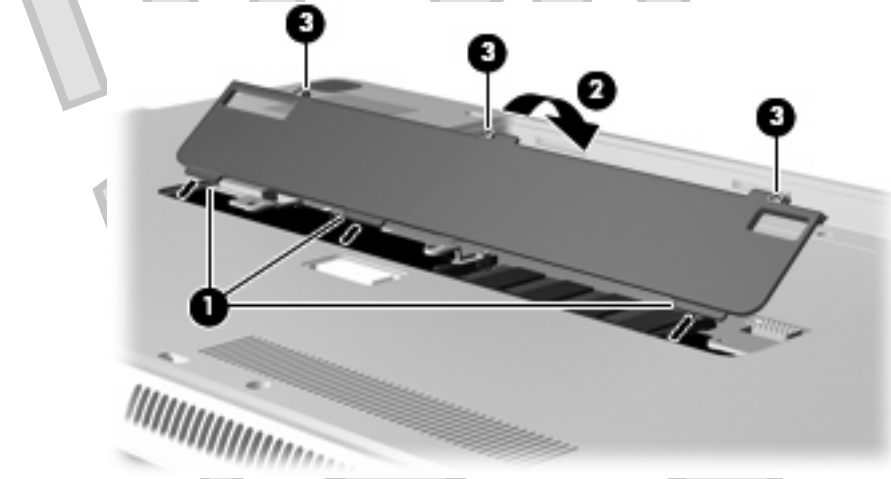

13. Replace the battery.
14. Turn the computer right-side up, and then reconnect external power and external devices.
15. Turn on the computer.

Adding or replacing a memory module in double-slot models

To add or replace a memory module:

 **NOTE:** If you are inserting only one memory module, you must insert it in the top memory module slot or the computer will not recognize the memory module.

1. Save your work.
2. Shut down the computer and close the display.

If you are not sure whether the computer is off or in Hibernation, turn the computer on by briefly pressing the power button. Then shut down the computer through the operating system.

3. Disconnect all external devices connected to the computer.
4. Unplug the power cord from the AC outlet.
5. Turn the computer upside down on a flat surface.
6. Remove the battery from the computer.
7. Loosen the memory module compartment cover screws (1) and lift the memory module compartment cover (2) away from the computer.

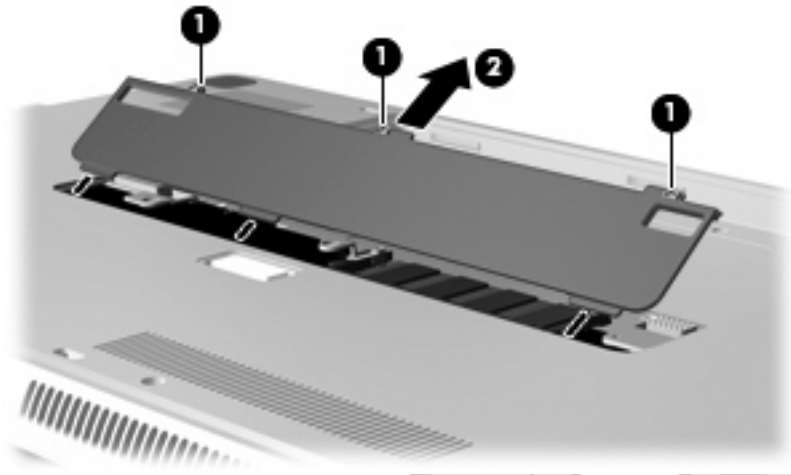

8. Remove a memory module in the top memory module slot:
 - a. Pull away the retention clips (1) on each side of the memory module.

 **CAUTION:** To prevent damage to the memory module, hold the memory module by the edges only. Do not touch the components on the memory module.

- b. Grasp the edge of the memory module (2), and gently pull the module out of the memory module slot.

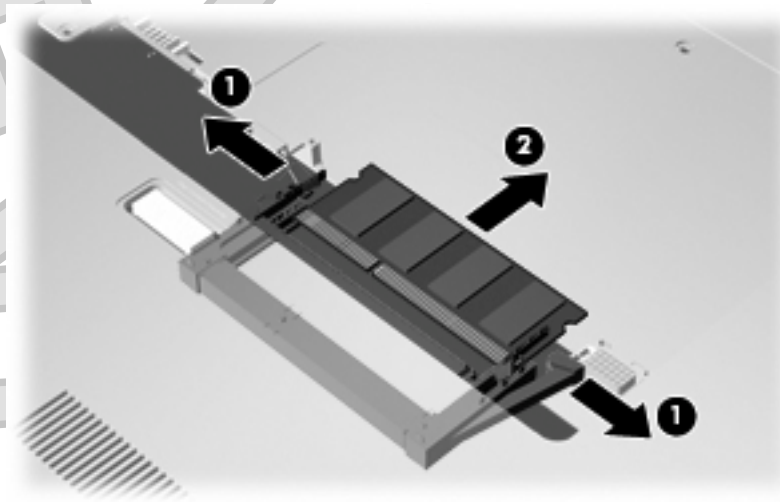

To protect the memory module after removal, place it in an electrostatic-safe container.

- 10. Insert a memory module in the bottom memory module slot:
 - a. Align the notched edge (1) of the memory module with the tab in the bottom memory module slot.
 - b. Insert the memory module firmly into the bottom memory module slot (2) until it is seated and the retention clips (3) automatically snap into place.

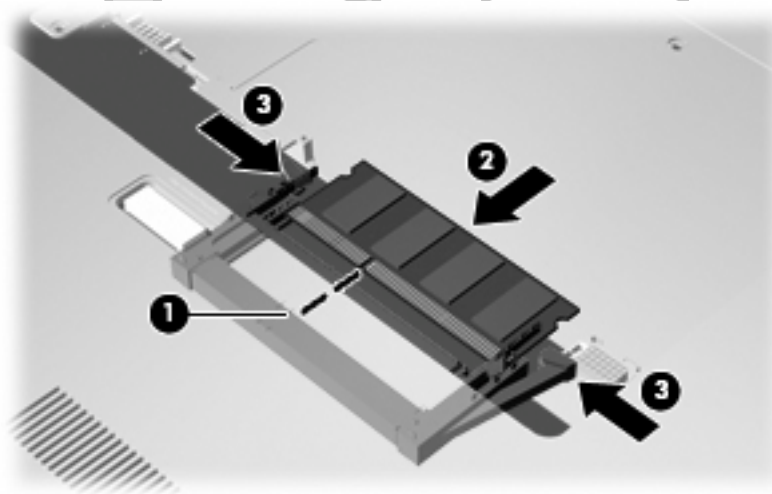

- 11. Insert a memory module in the top memory module slot:
 - a. Align the notched edge (1) of the memory module with the tab in the top memory module slot.

- b. Insert the memory module into the top memory module slot and rotate the module downward (2) until it is seated and the retention clips (3) snap into place.

△ **CAUTION:** To prevent damage to the memory module, hold the memory module by the edges only. Do not touch the components on the memory module.

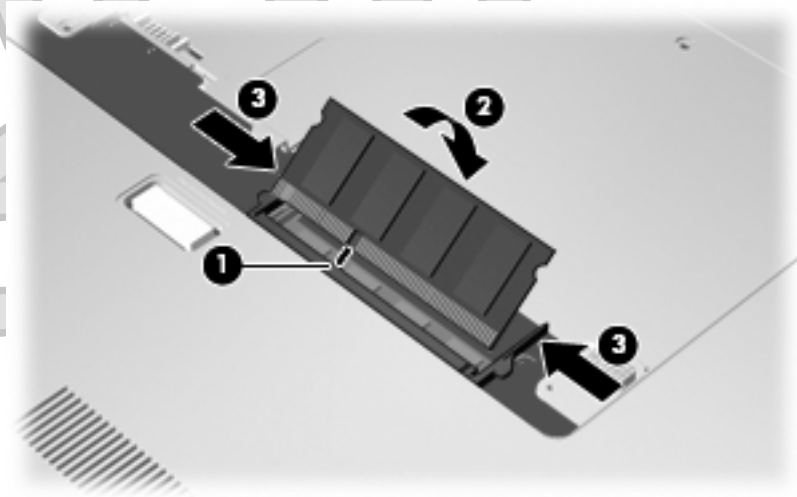

12. Align the tabs (1) on the memory module compartment cover with the notches on the computer.
13. Close the cover (2).
14. Tighten the memory module compartment cover screws (3).

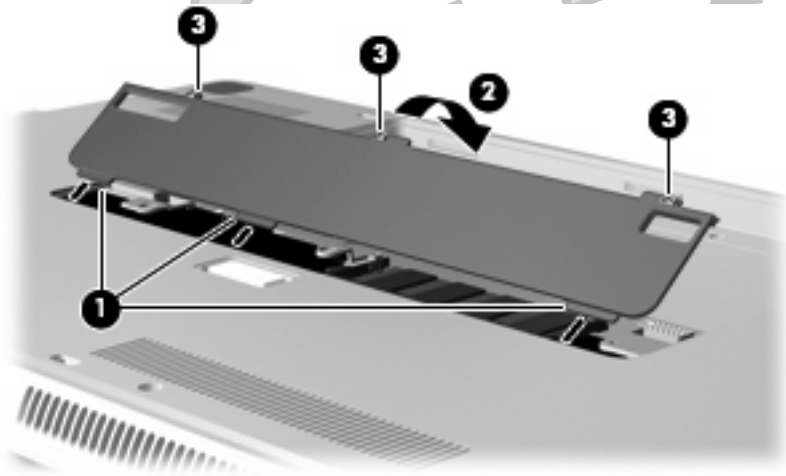

15. Replace the battery.
16. Turn the computer right-side up, and then reconnect external power and external devices.
17. Turn on the computer.

9 Security

Antenna House XSL Formatter

Protecting the computer

Standard security features provided by the Windows® operating system and the non-Windows Setup Utility can protect your personal settings and data from a variety of risks.

Follow the procedures in this guide to use the following features:

- Passwords
- Antivirus software
- Firewall software
- Critical security updates
- Optional security cable

 **NOTE:** Security solutions are designed to act as deterrents, but they may not deter software attacks or prevent the computer from being mishandled or stolen.

NOTE: Before you send your computer for service, remove all password settings.

Computer risk	Security feature
Unauthorized use of the computer	<ul style="list-style-type: none"> • QuickLock • Power-on password
Computer viruses	Norton Internet Security software
Unauthorized access to data	<ul style="list-style-type: none"> • Firewall software • Windows updates
Unauthorized access to Setup Utility, BIOS settings, and other system identification information	Administrator password
Ongoing or future threats to the computer	Critical security updates from Microsoft
Unauthorized access to a Windows user account	User password
Unauthorized removal of the computer	Security cable slot (used with an optional security cable)

Using passwords

A password is a group of characters that you choose to secure your computer information. Several types of passwords can be set, depending on how you want to control access to your information. Passwords can be set in Windows or in the non-Windows Setup Utility preinstalled on the computer.

△ **CAUTION:** To prevent being locked out of the computer, record each password you set. Because most passwords are not displayed as they are set, changed, or deleted, it is essential to record each password immediately and store it in a secure place.

You can use the same password for a Setup Utility feature and for a Windows security feature. You can also use the same password for more than one Setup Utility feature.

Use the following guidelines when setting a password in Setup Utility:

- A password can be any combination of up to 8 letters and numbers and is case sensitive.
- A password set in Setup Utility must be entered at a Setup Utility prompt. A password set in Windows must be entered at a Windows prompt.

Use the following tips for creating and saving passwords:

- When creating passwords, follow requirements set by the program.
- Write down your passwords and store them in a secure place away from the computer.
- Do not store passwords in a file on the computer.
- Do not use your name or other personal information that could be easily discovered by an outsider.

The following sections list Windows and Setup Utility passwords and describe their functions. For additional information about Windows passwords, such as screen-saver passwords, select **Start > Help and Support**.

Setting passwords in Windows

Password	Function
Administrator password	Protects administrator-level access to computer contents. NOTE: This password cannot be used to access Setup Utility contents.
User password	Protects access to a Windows user account. It also protects access to the computer contents and must be entered when you exit Sleep or Hibernation.
QuickLock	Protects the computer by requiring a password to be entered in the Windows Log On dialog box before you access the computer. After you set a user or administrator password, follow these steps: <ol style="list-style-type: none">1. Initiate QuickLock by pressing the QuickLock key.2. Exit QuickLock by entering your Windows user or administrator password.

Setting passwords in Setup Utility

Password	Function
Administrator password*	<ul style="list-style-type: none">• Protects access to Setup Utility.• After this password is set, it must be entered each time you access Setup Utility. <p>CAUTION: If you forget your administrator password, you cannot access Setup Utility.</p>
Power-on password*	<ul style="list-style-type: none">• Protects access to the computer contents.• After this password is set, it must be entered each time you turn on or restart the computer, or exit Hibernation. <p>CAUTION: If you forget your power-on password, you cannot turn on or restart the computer, or exit Hibernation.</p> <p>NOTE: The administrator password can be used in place of the power-on password.</p>

*For details about each of these passwords, refer to the following topics.

Administrator password

Your administrator password protects the configuration settings and system identification information in Setup Utility. After this password is set, you must enter it each time you access Setup Utility.

Your administrator password is not interchangeable with an administrator password set in Windows, nor is it displayed as it is set, entered, changed, or deleted. Be sure that you record your password and store it in a safe place.

If you enter the administrator password at the first password check before the “Press the ESC key for Startup Menu” message is displayed, you do not have to enter it again to access Setup Utility.

If you enter the power-on password at the first password check before the “Press the ESC key for Startup Menu” message is displayed, you must enter the administrator password to access Setup Utility.

Managing an administrator password

To set, change, or delete this password, follow these steps:

1. Open Setup Utility by turning on or restarting the computer. While the “Press the ESC key for Startup Menu” message is displayed in the lower-left corner of the screen, press **f10**.
– or –
Open Setup Utility by turning on or restarting the computer. While the “Press the ESC key for Startup Menu” message is displayed in the lower-left corner of the screen, press **esc**. When the Startup Menu is displayed, press **f10**.
2. Use the arrow keys to select **Security > Set Administrator Password**, and then press **enter**.
 - To set an administrator password, type your password in the **Enter New Password** and **Confirm New Password** fields, and then press **enter**.
 - To change an administrator password, type your current password in the **Enter Current Password** field, type a new password in the **Enter New Password** and **Confirm New Password** fields, and then press **enter**.
 - To delete an administrator password, type your current password in the **Enter Password** field, and then press **enter** 4 times.
3. To save your changes and exit Setup Utility, use the arrow keys to select **Exit > Exit Saving Changes**.

Your changes go into effect when the computer restarts.

Entering an administrator password

At the **Enter Password** prompt, type your administrator password, and then press **enter**. After 3 unsuccessful attempts to enter the administrator password, you must restart the computer and try again.

Power-on password

Your power-on password prevents unauthorized use of the computer. After this password is set, it must be entered each time you turn on or restart the computer, or exit Hibernation. A power-on password is not displayed as it is set, entered, changed, or deleted.

Managing a power-on password

To set, change, or delete this password, follow these steps:

1. Open Setup Utility by turning on or restarting the computer. While the “Press the ESC key for Startup Menu” message is displayed in the lower-left corner of the screen, press **f10**.

– or –

Open Setup Utility by turning on or restarting the computer. While the “Press the ESC key for Startup Menu” message is displayed in the lower-left corner of the screen, press **esc**. When the Startup Menu is displayed, press **f10**.

2. Use the arrow keys to select **Security > Set Power-On Password**, and then press **enter**.
 - To set a power-on password, type your password in the **Enter New Password** and **Confirm New Password** fields, and then press **enter**.
 - To change a power-on password, type your current password in the **Enter Current Password** field, type a new password in the **Enter New Password** and **Confirm New Password** fields, and then press **enter**.
 - To delete a power-on password, type your current password in the **Enter Current Password** field, and then press **enter** 4 times.
3. To save your changes and exit Setup Utility, use the arrow keys to select **Exit > Exit Saving Changes**.

Your changes go into effect when the computer restarts.

Entering a power-on password

At the **Enter Password** prompt, type your password, and then press **enter**. After 3 unsuccessful attempts to enter the password, you must restart the computer and try again.

Using antivirus software

When you use the computer to access e-mail, a network, or the Internet, you expose it to computer viruses. Computer viruses can disable the operating system, programs, or utilities, or cause them to function abnormally.

Antivirus software can detect most viruses, destroy them, and in most cases, repair any damage they have caused. To provide ongoing protection against newly discovered viruses, antivirus software must be kept up to date.

Norton Internet Security, an antivirus program, is preinstalled on the computer. The software includes 60 days of free updates. It is strongly recommended that you protect the computer against new viruses beyond 60 days by purchasing extended update service. Instructions for using and updating Norton Internet Security software and for purchasing extended update service are provided within the program. To view and access Norton Internet Security, select **Start > All Programs > Norton Internet Security**.

For more information about computer viruses, type `viruses` in the Search box in Help and Support.

Using firewall software

When you use the computer for e-mail, network, or Internet access, unauthorized persons may be able to gain access to the computer, your personal files, and information about you. Use the firewall software preinstalled on the computer to protect your privacy.

Firewall features include logging and reporting of network activity, and automatic monitoring of all incoming and outgoing traffic. Refer to the firewall user guide or contact your firewall manufacturer for more information.

 **NOTE:** Under some circumstances a firewall can block access to Internet games, interfere with printer or file sharing on a network, or block authorized e-mail attachments. To temporarily resolve the problem, disable the firewall, perform the task that you want to perform, and then reenables the firewall. To permanently resolve the problem, reconfigure the firewall.

Installing critical security updates

△ **CAUTION:** Microsoft sends alerts regarding critical updates. To protect the computer from security breaches and computer viruses, install all critical updates from Microsoft as soon as you receive an alert.

Updates to the operating system and other software may have become available after the computer was shipped. To be sure that all available updates are installed on the computer, observe these guidelines:

- Run Windows Update as soon as possible after you set up your computer. Use the update link at **Start > All Programs > Windows Update**.
- Run Windows Update monthly thereafter.
- Obtain updates to Windows and other Microsoft® programs, as they are released, from the Microsoft Web site and through the updates link in Help and Support.

Installing an optional security cable

 **NOTE:** A security cable is designed to act as a deterrent, but it may not prevent the computer from being mishandled or stolen.

1. Loop the security cable around a secured object.
2. Insert the key (1) into the cable lock (2).
3. Insert the cable lock into the security cable slot on the computer (3), and then lock the cable lock with the key.

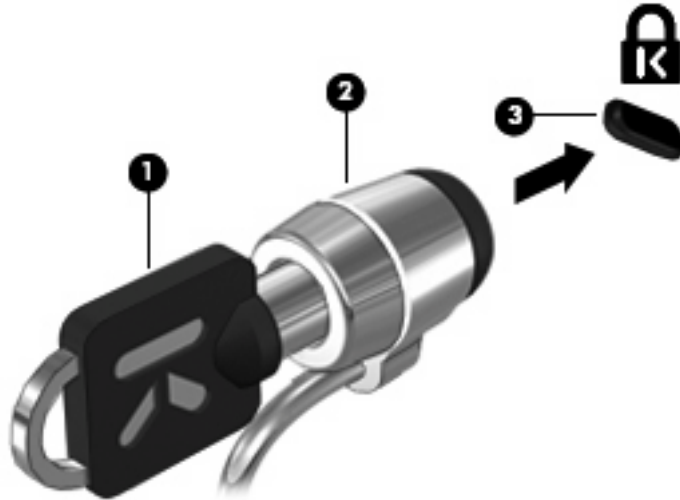

4. Remove the key and keep it in a safe place.

A Setup Utility (BIOS)

Antenna House XSL Formatter

Starting Setup Utility

Setup Utility is a ROM-based information and customization utility that can be used even when your Windows® operating system is not working.

The utility reports information about the computer and provides settings for startup, security, and other preferences.

To start Setup Utility:

- ▲ Open Setup Utility by turning on or restarting the computer. While the “Press the ESC key for Startup Menu” message is displayed in the lower-left corner of the screen, press [f10](#).

– or –

1. Open Setup Utility by turning on or restarting the computer. While the “Press the ESC key for Startup Menu” message is displayed in the lower-left corner of the screen, press [esc](#).
2. When the Startup Menu is displayed, press [f10](#).

Using Setup Utility

Changing the language of Setup Utility

The following procedure explains how to change the language of Setup Utility. If Setup Utility is not already running, begin at step 1. If Setup Utility is already running, begin at step 2.

1. Open Setup Utility by turning on or restarting the computer. While the “Press the ESC key for Startup Menu” message is displayed in the lower-left corner of the screen, press **f10**.

– or –

Open Setup Utility by turning on or restarting the computer. While the “Press the ESC key for Startup Menu” message is displayed in the lower-left corner of the screen, press **esc**. When the Startup Menu is displayed, press **f10**.

2. Use the arrow keys to select **System Configuration > Language**, and then press **enter**.
3. Use the arrow keys to select a language, and then press **enter**.
4. When a confirmation prompt with your language selected is displayed, press **enter**.
5. To save your change and exit Setup Utility, use the arrow keys to select **Exit > Exit Saving Changes**, and then press **enter**.

Your change goes into effect immediately.

Navigating and selecting in Setup Utility

Because Setup Utility is not Windows based, it does not support the TouchPad. Navigation and selection are by keystroke.

- To choose a menu or a menu item, use the arrow keys.
- To choose an item in a list or to toggle a field, for example an Enable/Disable field, use either the arrow keys or **f5** or **f6**.
- To select an item, press **enter**.
- To close a text box or return to the menu display, press **esc**.
- To display additional navigation and selection information while Setup Utility is open, press **f1**.

Displaying system information

The following procedure explains how to display system information in Setup Utility. If Setup Utility is not open, begin at step 1. If Setup Utility is open, begin at step 2.

1. Open Setup Utility by turning on or restarting the computer. While the “Press the ESC key for Startup Menu” message is displayed in the lower-left corner of the screen, press **f10**.

– or –

Open Setup Utility by turning on or restarting the computer. While the “Press the ESC key for Startup Menu” message is displayed in the lower-left corner of the screen, press **esc**. When the Startup Menu is displayed, press **f10**.

2. Select the **Main** menu. System information such as the system time and date, and identification information about the computer is displayed.
3. To exit Setup Utility without changing any settings, use the arrow keys to select **Exit > Exit Discarding Changes**, and then press **enter**.

Restoring default settings in Setup Utility

The following procedure explains how to restore the Setup Utility default settings. If Setup Utility is not already running, begin at step 1. If Setup Utility is already running, begin at step 2.

1. Open Setup Utility by turning on or restarting the computer. While the “Press the ESC key for Startup Menu” message is displayed in the lower-left corner of the screen, press **f10**.

– or –

Open Setup Utility by turning on or restarting the computer. While the “Press the ESC key for Startup Menu” message is displayed in the lower-left corner of the screen, press **esc**. When the Startup Menu is displayed, press **f10**.

2. Use the arrow keys to select **Exit > Load Setup Defaults**, and then press **enter**.
3. When the Setup Confirmation is displayed, press **enter**.
4. To save your change and exit Setup Utility, use the arrow keys to select **Exit > Exit Saving Changes**, and then press **enter**.

The Setup Utility default settings go into effect when the computer restarts.

 **NOTE:** Your password, security, and language settings are not changed when you restore the factory default settings.

Exiting Setup Utility

You can exit Setup Utility with or without saving changes.

- To exit Setup Utility and save your changes from the current session:

If the Setup Utility menus are not visible, press **esc** to return to the menu display. Then use the arrow keys to select **Exit > Exit Saving Changes**, and then press **enter**.

- To exit Setup Utility without saving your changes from the current session:

If the Setup Utility menus are not visible, press **esc** to return to the menu display. Then use the arrow keys to select **Exit > Exit Discarding Changes**, and then press **enter**.

After either choice, the computer restarts in Windows.

ANTENNA HOUSE
XSL FORMATTER
EVALUATION

Setup Utility menus

The menu tables in this section provide an overview of Setup Utility options.

 **NOTE:** Some of the Setup Utility menu items listed in this chapter may not be supported by your computer.

Main menu

Select	To do this
System information	<ul style="list-style-type: none">• View and change the system time and date.• View identification information about the computer.• View specification information, such as processor information, memory size, and system BIOS.

Security menu

Select	To do this
Administrator password	Enter, change, or delete an administrator password.
Power-On Password	Enter, change, or delete a power-on password.

System Configuration menu

Select	To do this
Language Support	Change the Setup Utility language.
Virtualization Technology	Enable/disable the processor Virtualization Technology.
Fan Always On	Enabled/disable Fan Always On. When enabled, the computer fan will always be on.
Fast Charge Mode	Enable/disable the Fast Charge Mode for the primary and accessory batteries.

Select	To do this
Action Key Mode	Enable/disable the Action Key Mode.
Boot Options	<p>Set the following boot options:</p> <ul style="list-style-type: none"> • POST Hot Key Delay (sec.)—Set the delay for the user to press hot keys in intervals of 5 seconds each (0, 5, 10, 15, 20). • HP QuickWeb—Enable/disable the HP QuickWeb Boot Menu during Setup Utility. Set the delay for the user to start HP QuickWeb in intervals of 5 seconds each (0, 5, 10, 15, 20). • Floppy Boot—Enable/disable boot from diskette. • Network Adapter Boot—Enable/disable boot from external Network Adapter. • Boot Order—Set the boot order for: <ul style="list-style-type: none"> ◦ Notebook Hard Drive ◦ USB Diskette on Key/USB Hard Drive ◦ USB CD/DVD ROM Drive ◦ USB Floppy ◦ Network adapter

Diagnostics menu

Select	To do this
Primary Hard Disk Self Test	Run a comprehensive self-test on the primary hard drive.
Secondary Hard Disk Self Test (select models only)	Run a comprehensive self-test on the secondary hard drive.
Memory Test	Run a diagnostic test on the system memory.

Updating the BIOS

Updated versions of the BIOS may be available on the HP Web site.

Most BIOS updates on the HP Web site are packaged in compressed files called *SoftPags*.

Some download packages contain a file named *Readme.txt*, which contains information regarding installing and troubleshooting the file.

Updating the BIOS

Determining the BIOS version

To determine whether available BIOS updates contain later BIOS versions than those currently installed on the computer, you need to know the version of the system BIOS currently installed.

BIOS version information (also known as *ROM date* and *System BIOS*) can be displayed by pressing **fn+esc** (if you are already in Windows) or by opening Setup Utility.

To use Setup Utility for displaying BIOS information:

1. Open Setup Utility by turning on or restarting the computer. While the “Press the ESC key for Startup Menu” message is displayed in the lower-left corner of the screen, press **f10**.
2. If Setup Utility does not open with the system information displayed, use the arrow keys to select the **Main** menu.

When the Main menu is selected, BIOS and other system information is displayed.

3. To exit Setup Utility, use the arrow keys to select **Exit > Exit Discarding Changes**, and then press **enter**.

Downloading a BIOS update

- △ **CAUTION:** To prevent damage to the computer or an unsuccessful installation, download and install a BIOS update only when the computer is connected to reliable external power using the AC adapter. Do not download or install a BIOS update while the computer is running on battery power, docked in an optional docking device, or connected to an optional power source. During the download and installation, follow these instructions:

Do not disconnect power from the computer by unplugging the power cord from the AC outlet.

Do not shut down the computer or initiate Sleep or Hibernation.

Do not insert, remove, connect, or disconnect any device, cable, or cord.

To download a BIOS update:

1. Access the page on the HP Web site that provides software for your computer:
Select **Start > Help and Support > Maintain**.
2. Follow the instructions on the screen to identify your computer and access the BIOS update you want to download.
3. At the download area, follow these steps:
 - a. Identify the BIOS update that is later than the BIOS version currently installed on your computer. Make a note of the date, name, or other identifier. You may need this information to locate the update later, after it has been downloaded to your hard drive.
 - b. Follow the instructions on the screen to download your selection to the hard drive.
Make a note of the path to the location on your hard drive where the BIOS update will be downloaded. You will need to access this path when you are ready to install the update.

 **NOTE:** If you connect your computer to a network, consult the network administrator before installing any software updates, especially system BIOS updates.

BIOS installation procedures vary. Follow any instructions that are displayed on the screen after the download is complete. If no instructions are displayed, follow these steps:

1. Open Windows Explorer by selecting **Start > Computer**.
2. Double-click your hard drive designation. The hard drive designation is typically Local Disk (C:).
3. Using the hard drive path you recorded earlier, open the folder on your hard drive that contains the update.
4. Double-click the file that has an .exe extension (for example, *filename.exe*).
The BIOS installation begins.
5. Complete the installation by following the instructions on the screen.

 **NOTE:** After a message on the screen reports a successful installation, you can delete the downloaded file from your hard drive.

B Backup and recovery

Recovery after a system failure is as complete as your most current backup. HP recommends that you create recovery discs immediately after software setup. As you add new software and data files, you should continue to back up your system on a regular basis to maintain a reasonably current backup.

Tools provided by the operating system and HP Recovery Manager software are designed to help you with the following tasks for safeguarding your information and restoring it in case of a system failure:

- Creating a set of recovery discs (Recovery Manager software feature). Recovery discs are used to start up (boot) your computer and restore the operating system and software programs to factory settings in case of system failure or instability.
- Backing up your information regularly to protect your important system files.
- Creating system restore points (operating system feature). System restore points allow you to reverse undesirable changes to your computer by restoring the computer to an earlier state.
- Recovering a program or driver (Recovery Manager software feature). This feature helps you reinstall a program or driver without performing a full system recovery.
- Performing a full system recovery (Recovery Manager software feature). With Recovery Manager, you can recover your full factory image if you experience system failure or instability. Recovery Manager works from a dedicated recovery partition (select models only) on the hard drive or from recovery discs you create.

 **NOTE:** Computers with a solid-state drive (SSD) may not have a recovery partition. Recovery discs have been included for computers that do not have a partition. Use these discs to recover your operating system and software. To check for the presence of a recovery partition, select **Start**, right-click **Computer**, click **Manage**, and then click **Disk Management**. If the partition is present, an HP Recovery drive is listed in the window.

Creating recovery discs

HP recommends that you create recovery discs to be sure that you can restore your system to its original factory state if you experience serious system failure or instability. Create these discs after setting up the computer for the first time.

Handle these discs carefully and keep them in a safe place. The software allows the creation of only one set of recovery discs.

 **NOTE:** If your computer does not include an internal optical drive, you can use an optional external optical drive (purchased separately) to create recovery discs, or you can purchase recovery discs for your computer from the HP Web site.

Note the following guidelines before creating recovery discs:

- You will need high-quality DVD-R, DVD+R, BD-R (writable Blu-ray), or CD-R discs. All these discs are purchased separately. DVDs and BDs have a much higher capacity than CDs. If you use CDs, up to 20 discs may be required, whereas only a few DVDs or BDs are required.

 **NOTE:** Read-write discs, such as CD-RW, DVD±RW, double-layer DVD±RW, and BD-RE (rewritable Blu-ray) discs, are not compatible with the Recovery Manager software.

- The computer must be connected to AC power during this process.
- Only one set of recovery discs can be created per computer.
- Number each disc before inserting it into the optical drive.
- If necessary, you can exit the program before you have finished creating the recovery discs. The next time you open Recovery Manager, you will be prompted to continue the disc creation process.

To create a set of recovery discs:

1. Select **Start > All Programs > Recovery Manager > Recovery Disc Creation**.
2. Follow the on-screen instructions.

Backing up your information

As you add new software and data files, you should back up your system on a regular basis to maintain a reasonably current backup. Back up your system at the following times:

- At regularly scheduled times

 **NOTE:** Set reminders to back up your information periodically.

- Before the computer is repaired or restored
- Before you add or modify hardware or software

Note the following when backing up:

- Create system restore points using the Windows® System Restore feature, and periodically copy them to disc.
- Store personal files in the Documents library and back up this folder periodically.
- Back up templates stored in their associated programs.
- Save customized settings in a window, toolbar, or menu bar by taking a screen shot of your settings. The screen shot can be a time-saver if you have to reset your preferences.

To copy the screen and paste it into a word-processing document, follow these steps:

1. Display the screen.

2. Copy the screen:

To copy only the active window, press **alt+prt sc**.

To copy the entire screen, press **prt sc**.

3. Open a word-processing document, and then select **Edit > Paste**.
4. Save the document.

- You can back up your information to an optional external hard drive, a network drive, or discs.
- When backing up to discs, use any of the following types of discs (purchased separately): CD-R, CD-RW, DVD+R, DVD-R, or DVD±RW. The discs you use will depend on the type of optical drive connected to your computer.

 **NOTE:** DVDs store more information than CDs, so using them for backup reduces the number of recovery discs required.

- When backing up to discs, number each disc before inserting it into the optical drive of the computer.

Using Windows Backup and Restore

To create a backup using Windows Backup and Restore, follow these steps:

 **NOTE:** Be sure that the computer is connected to AC power before you start the backup process.

NOTE: The backup process may take over an hour, depending on file size and the speed of the computer.

1. Select **Start > All Programs > Maintenance > Backup and Restore**.
2. Follow the on-screen instructions to set up and create a backup.

 **NOTE:** Windows® includes the User Account Control feature to improve the security of your computer. You may be prompted for your permission or password for tasks such as installing software, running utilities, or changing Windows settings. Refer to Help and Support for more information.

Using system restore points

When you back up your system, you are creating a system restore point. A system restore point allows you to save and name a snapshot of your hard drive at a specific point in time. You can then recover back to that point if you want to reverse subsequent changes made to your system.

 **NOTE:** Recovering to an earlier restore point does not affect data files saved or e-mails created since the last restore point.

You also can create additional restore points to provide increased protection for your system files and settings.

When to create restore points

- Before you add or extensively modify software or hardware
- Periodically, whenever the system is performing optimally

 **NOTE:** If you revert to a restore point and then change your mind, you can reverse the restoration.

Create a system restore point

1. Select **Start > Control Panel > System and Security > System**.
2. In the left pane, click **System Protection**.
3. Click the **System Protection** tab.
4. Under **Protection Settings**, select the disk for which you want to create a restore point.
5. Click **Create**.
6. Follow the on-screen instructions.

Restore to a previous date and time

To revert to a restore point (created at a previous date and time), when the computer was functioning optimally, follow these steps:

1. Select **Start > Control Panel > System and Security > System**.
2. In the left pane, click **System protection**.
3. Click the **System Protection** tab.
4. Click **System Restore**.
5. Follow the on-screen instructions.

Performing a recovery

 **NOTE:** You can recover only files that you have previously backed up. HP recommends that you use HP Recovery Manager to create a set of recovery discs (entire drive backup) as soon as you set up your computer.

Recovery Manager software allows you to repair or restore the system if you experience system failure or instability. Recovery Manager works from recovery discs or from a dedicated recovery partition (select models only) on the hard drive. However, if your computer includes a solid-state drive (SSD), you may not have a recovery partition. If that is the case, recovery discs have been included with your computer. Use these discs to recover your operating system and software.

 **NOTE:** Windows has its own built-in repair features, such as System Restore. If you have not already tried these features, try them before using Recovery Manager.

NOTE: Recovery Manager recovers only software that was preinstalled at the factory. Software not provided with this computer must be downloaded from the manufacturer's Web site or reinstalled from the disc provided by the manufacturer.

Recovering using the recovery discs

To restore the system from the recovery discs:

1. Back up all personal files.
2. Insert the first recovery disc into the optical drive and restart the computer.
3. Follow the on-screen instructions.

Recovering using the dedicated recovery partition (select models only)

 **NOTE:** Computers with an SSD may not have a recovery partition. If the computer does not have a recovery partition, you will not be able to recover using this procedure. Recovery discs have been included for computers that do not have a partition. Use these discs to recover your operating system and software.

On some models, you can perform a recovery from the partition on the hard drive, accessed by pressing either the Start button or **f11**. This restores the computer to its factory condition.

To restore the system from the partition, follow these steps:

1. Access Recovery Manager in either of the following ways:
 - Select **Start > All Programs > Recovery Manager > Recovery Manager**.
 - or –
 - Turn on or restart the computer, and then press **esc** while the “Press the ESC key for Startup Menu” message is displayed at the bottom of the screen. Then, press **f11** while the “Press <F11> for recovery” message is displayed on the screen.
2. Click **System Recovery** in the **Recovery Manager** window.
3. Follow the on-screen instructions.

C RAID 0 (select models only)

Select computer models with two solid-state drives (SSDs) ship in a RAID 0 configuration. RAID benefits users who frequently work with large files and want to improve the storage performance of their computer. With RAID 0, data is distributed across both drives. This allows data, especially large files, to be read faster because data is read simultaneously from both drives. However, RAID 0 offers no fault tolerance, which means that the entire array fails if one drive fails.

 **NOTE:** QuickWeb software is not supported on computers with two solid-state drives.

To enhance the write performance of RAID 0, Intel® Matrix Storage Manager software has implemented a volume write-back cache. The volume write-back cache allows writes to be buffered and improves coalescing. The cache is enabled by default and can be disabled or reenabled in the Intel® Matrix Storage Console. An Uninterrupted Power Supply (UPS) is recommended for use if the cache is enabled.

Disabling RAID 0

△ **CAUTION:** Disabling RAID 0 completely erases hard drive contents and reformats the hard drive. All files you have created and any software installed on the computer are permanently removed. Before you disable RAID 0, be sure to back up your information and create a set of recovery discs. Refer to [Backup and recovery on page 102](#) for additional information.

To disable RAID 0:

1. Back up all personal files.
2. Turn on or restart the computer.
3. When the **POST** screen opens, press **ctrl+l** to enter the configuration utility.
4. In the **Main** menu, use the up or down arrow key to select **3. Reset Disks to Non-RAID**, and then press **enter**. The Reset RAID Data window is displayed.
5. Press the space bar to select the first SSD drive, and then press the down arrow key and the space bar to select the second SSD drive.
6. Press **enter**, and then press **Y** to confirm the selection.
7. Use the down arrow key to select **5. Exit**.
8. Press **enter**, and then press **Y** to boot the system.
9. Restore the system from the recovery discs:
 - a. Insert the first recovery disc into an optional external optical drive and restart the computer.
 - b. Follow the on-screen instructions.

Index

A

AC adapter
 identifying 11
 testing 53
AC power, connecting 52
accessory battery
 components 59
 inserting 59
 removing 59
accessory battery charge lights 59
accessory battery connector, identifying 9
accessory battery fuel gauge 59
action key mode 99
action keys
 adjusting volume 29
 audio CD, DVD, or BD controls 29
 decreasing screen brightness 29
 Help and Support 29
 identifying 6
 increasing screen brightness 29
 muting speaker sound 30
 QuickLock 30
 switching screen image 29
 using 29
 volume 34
adaptive brightness, using 46
administrator password
 creating 87
 entering 87
 managing 87
airport security devices 65
ambient light sensor
 adaptive brightness 46
 identifying 10

 using 46
 webcam IR light 46
antennas 10
antivirus software, using 89
audio devices, connecting external 38
audio functions, checking 38
audio-in (microphone) jack, identifying 8
audio-out (headphone) jack, identifying 8

B

backing up
 customized window, toolbar, and menu bar settings 104
 personal files 104
 templates 104
battery
 calibrating 61
 charging 56
 charging sequence 61
 conserving power 50
 discharging 57
 disposing 62
 Fast Charge Mode 61
 inserting 55
 low battery levels 57
 removing 55
 replacing 62
 storing 62
battery bay, identifying 9
Battery Check 54
battery light 8, 56
battery lock, identifying 9
battery power 54
battery release latch 9, 55
battery temperature 62
BD drive 68
Beats Audio, using 39

BIOS, updating 100
Bluetooth device 15
Bluetooth label 12
Bluetooth wireless devices 21
boot options 99
boot order 99
buttons
 left TouchPad 4
 power 5
 right TouchPad 4
 TouchPad on/off 4

C

cables
 eSATA 72
 USB 71
calculator key, identifying 6
calibrating battery 61
caps lock light, identifying 4
CD drive 68
Certificate of Authenticity label 12
charging batteries 56
checking audio functions 38
cleaning, TouchPad and keyboard 32
components
 additional hardware 11
 bottom 9
 display 10
 front 7
 left-side 8
 right-side 7
 top 3
configuring HDMI 43
connection, external power 52
connector, power 8
conservation, power 50
cord, power 11
critical battery level 49, 57

critical security updates,
installing 91

D

default settings, restoring 96

Diagnostics menu 99

digital card

inserting 73

removing 74

supported formats 73

Digital Media Slot, identifying 7

Disk Cleanup software 66

Disk Defragmenter software 65

diskette drive 68

display image, switching 29

drive light 9, 66

drive media 49

drives

boot order 99

connecting external 68

diskette 68

external 68

hard 68

optical 68

DVD drive 68

E

encryption 19

entering a power-on

password 88

entering an administrator

password 87

eSATA cable, connecting 72

eSATA devices

connecting 72

removing 72

eSATA port, identifying 8

esc key, identifying 7

external audio devices,

connecting 38

external drive 68

external optical drive 37

F

f11 106

fan always on 98

Fast Charge Mode 61, 98

firewall software 19, 90

fn key, identifying 6, 31

full system recovery 102

H

hard disk drive

external 68

hard drive

external 68

HP ProtectSmart Hard Drive

Protection 66

HDMI

configuring 43

connecting 42

HDMI port, identifying 8, 41, 42

headphone (audio-out) jack 8

Help and Support key 29

Hibernation

exiting 49

initiated during critical battery

level 57

initiating 49

high-definition devices,

connecting 42

hotkeys

description 31

display system information 31

using 31

HP HDMI to VGA Display Adapter

using 41

HP ProtectSmart Hard Drive

Protection 66

hubs 71

I

icons

network 15, 22

wireless 15

installed drives, identifying 65

integrated webcam light,

identifying 10

interference, minimizing 23

internal microphones,

identifying 10

Internet connection setup 18

J

jacks

audio-in (microphone) 8

audio-out (headphone) 8

RJ-45 (network) 8

K

keyboard hotkeys, identifying 31

keyboard, cleaning 32

keys

action 6

calculator 6

esc 7

fn 6

mail key 7

Media Launch 6

print options 6

volume mute 34

Web 6

Windows application 6

Windows logo 6

wireless 6, 16

L

labels

Bluetooth 12

Microsoft Certificate of

Authenticity 12

regulatory 12

service tag 12

wireless certification 12

WLAN 12

language support 98

latch, battery release 9

lights

battery 8

caps lock 4

drive 9, 66

mute 4

power 4

TouchPad 4

webcam 10

wireless 4

local area network (LAN)

cable required 24

connecting cable 24

low battery level 57

M

mail key, identifying 7

Main menu 98

maintenance

Disk Cleanup 66

Disk Defragmenter 65

managing a power-on

password 88

managing an administrator

password 87

media activity keys 34

- media controls, keys 29
 - Media Launch key, identifying 6
 - MediaSmart
 - starting 36
 - using 36
 - memory module
 - inserting 77, 81
 - removing 76, 79
 - memory module compartment,
 - identifying 9
 - memory test 99
 - microphone (audio-out) jack,
 - identifying 8
 - Microsoft Certificate of Authenticity
 - label 12
 - minimizing interference 23
 - monitor, connecting 41
 - mouse, external
 - setting preferences 26
 - multimedia software
 - installing 37
 - using 36
 - mute key
 - identifying 30
 - using 34
 - mute light, identifying 4
- N**
- network (RJ-45) jack,
 - identifying 8
 - network cable, connecting 24
 - network icon 15, 22
 - network key 22
 - network security codes
 - network key 22
 - SSID 22
- O**
- operating system
 - Microsoft Certificate of Authenticity label 12
 - Product Key 12
 - optical drive
 - external 37, 68
 - sharing 37
- P**
- passwords
 - administrator 86
 - power-on 87
 - set in Setup Utility 86
 - set in Windows 85
 - pinching TouchPad gesture 27
 - pointing devices
 - setting preferences 26
 - ports
 - eSATA 8
 - HDMI 8, 42
 - USB 8, 71
 - power
 - connecting 52
 - conserving 50
 - power button, identifying 5
 - power connector, identifying 8
 - power cord, identifying 11
 - power light, identifying 4
 - power-on password
 - creating 88
 - entering 88
 - managing 88
 - primary hard disk self test 99
 - print options key, identifying 6
 - Product Key 12
 - product name and number,
 - computer 12
 - programs, using 36
 - projector, connecting 41
- Q**
- QuickLock 30, 84, 85
 - QuickWeb software 13
- R**
- RAID 0 65
 - readable media 49
 - recovering a program or
 - driver 102
 - recovering using the dedicated
 - recovery partition 106
 - recovering using the recovery
 - discs 106
 - recovery discs 102, 103
 - Recovery Manager 102, 106
 - recovery partition 102
 - recovery, system 106
 - regulatory information
 - regulatory label 12
 - wireless certification labels 12
 - restore points 105
- RJ-45 (network jack),
 - identifying 8
 - rotating TouchPad gesture 27
- S**
- screen brightness keys 29
 - screen image, switching 29
 - scrolling TouchPad gesture 26
 - secondary hard disk self test 99
 - security cable slot, identifying 7
 - security cable, installing 92
 - Security menu 98
 - security, wireless 18
 - serial number, computer 12
 - service tag 12
 - setup of WLAN 18
 - Setup Utility
 - changing the language 95
 - displaying system
 - information 96
 - exiting 96
 - menus 98
 - navigating 95
 - passwords set in 86
 - restoring default settings 96
 - selecting 95
 - starting 94
 - shared drives 37
 - shutdown 63
 - Sleep
 - exiting 49
 - initiating 49
 - slots
 - Digital Media 7
 - memory 75
 - security cable 7
 - software
 - Disk Cleanup 66
 - Disk Defragmenter 65
 - MediaSmart 36
 - using 36
 - Wireless Assistant 17
 - solid-state drive (SSD) 65, 102, 106
 - storing battery 62
 - supported discs 103
 - System Configuration menu 98
 - system failure or instability 102
 - system information hotkey 31

system information,
 displaying 96, 98
system recovery 106
system restore points 102, 105

T

temperature 62
TouchPad
 buttons 4
 cleaning 32
 gestures 26
 identifying 3
 using 26
TouchPad gestures
 pinching 27
 rotating 27
 scrolling 26
 zooming 27
TouchPad light, identifying 4
TouchPad on/off button 4
traveling with the computer 62
turning off the computer 63

U

unresponsive system 63
USB cable, connecting 71
USB devices
 connecting 71
 description 71
 removing 71
USB hubs 71
USB ports, identifying 8, 71
using system restore 105

V

vents, identifying 7, 8, 9
Virtualization Technology 98
volume
 adjust 34
 keys 34
 mute 34
volume keys, identifying 29
volume mute key 34

W

Web key, identifying 6
webcam
 adjusting properties 44
 identifying 10
 tips 44

webcam infrared (IR) light,
 identifying 10
webcam IR light, using 46
webcam light, identifying 10
Windows application key,
 identifying 6
Windows logo key, identifying 6
Windows, passwords set in 85
wireless
 protecting 18
 set up 18
 troubleshooting 22
wireless antennas 10
Wireless Assistant software 16,
 17
wireless certification label 12
wireless controls
 key 16
 operating system 16
Wireless Assistant
 software 16
wireless icon 15
wireless key
 using 16
wireless key, identifying 6
wireless light 4, 16
wireless network (WLAN)
 equipment needed 18
 security 18
WLAN device 12, 15
WLAN label 12
writable media 49

Z

zooming TouchPad gesture 27

EXSLT ANTENNA HOUSE XSL FORMATTER