

# Lenovo ideapad D330-10IGM User Guide



Read the safety notices and important tips in the included manuals before using your computer.

Lenovo™

## Notes

- Before using the product, be sure to read *Lenovo Safety and General Information Guide* first.
- The latest electronic compliance and environmental information are available from the Lenovo compliance information Web sites.
  - To view compliance information go to:  
<http://www.lenovo.com/compliance>
  - To download environmental information go to:  
<http://www.lenovo.com/ecodeclaration>.
- Some instructions in this guide may assume that you are using Windows® 10. If you are using another Windows operating system, some operations may be slightly different. If you are using other operating systems, some operations may not apply to you.
- The features described in this guide are common to most models. Some features may not be available on your computer or your computer may include features that are not described in this user guide.
- The illustrations in this manual may differ from the actual product. The screenshots of operating system are for reference only. Please refer to the actual product.

## Regulatory Notice

- For details, refer to **Guides & Manuals** at <http://support.lenovo.com>.

**First Edition (May 2018)**

**© Copyright Lenovo 2018.**

LIMITED AND RESTRICTED RIGHTS NOTICE: If data or software is delivered pursuant to a General Services Administration "GSA" contract, use, reproduction, or disclosure is subject to restrictions set forth in Contract No. GS-35F-05925.

# Contents

<b>Chapter 1. Getting to know your computer .....</b>	<b>1</b>
Top view .....	1
Left-side view .....	3
Right-side view .....	5
Bottom view .....	6
Rear View .....	10
Keyboard dock top view (Optional) .....	11
Keyboard dock left-side view (Optional) .....	14
Keyboard dock right-side view (Optional) .....	14
To use the Lenovo Active Pen (on select models).....	18
To use the Lenovo Active Pen2 (on select models).....	20
<b>Chapter 2. Starting to use Windows 10 .....</b>	<b>22</b>
Configuring the operating system for the first time .....	22
Operating system interfaces .....	22
Putting the computer to sleep or shutting it down .....	25
Touch screen operation .....	27
Connecting to a wireless network .....	30
Get help from Windows .....	31
<b>Chapter 3. Recovery system .....</b>	<b>32</b>
<b>Chapter 4. Troubleshooting .....</b>	<b>35</b>
Frequently asked questions .....	35
Troubleshooting .....	36
<b>Trademarks .....</b>	<b>39</b>



# Chapter 1. Getting to know your computer

## ■ ■ Top view

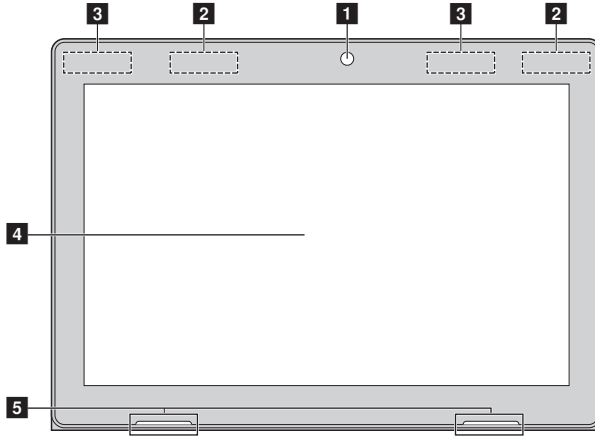

**Note:** The dashed areas indicate parts that are not visible externally.

- |          |   |   |
|----------|---|---|
| <b>1</b> | <b>Front camera</b>                             | Use the camera for video communication.                                       |
| <b>2</b> | <b>Wireless LAN antennas</b>                    | Connect to a wireless LAN adapter to send and receive wireless radio signals. |
| <b>3</b> | <b>Wireless WAN antennas (on select models)</b> | Connect to a wireless WAN adapter to send and receive wireless radio signals. |

**Note:** The GPS antenna is included here.

- |          |                           |  |
|----------|---------------------------|--|
| <b>4</b> | <b>Multi-touch screen</b> | Functions as the visual display as well as touchpad input. |
|----------|---------------------------|--|

**Note:** For details, see "Touch screen operation" on page 27.

- |          |                |                        |
|----------|----------------|------------------------|
| <b>5</b> | <b>Speaker</b> | Provides audio output. |
|----------|----------------|------------------------|

## Chapter 1. Getting to know your computer

### ■ Screen orientation

You can rotate the display panel to your preferred orientation. The orientation of the display automatically changes (alternating between portrait and landscape modes) depending on how you hold it.



### ■ ■ Left-side view

---



- 1** **Combo audio jack**      Connects to headsets.

**Notes:**

- The combo audio jack does not support conventional microphones.
- The recording function may not be supported if third-party headphones or headsets are connected, due to different industry standards.

## Chapter 1. Getting to know your computer

### ■ Connecting USB devices

You can connect a USB device to your computer by inserting its USB plug (Type A) into the USB port on your computer.

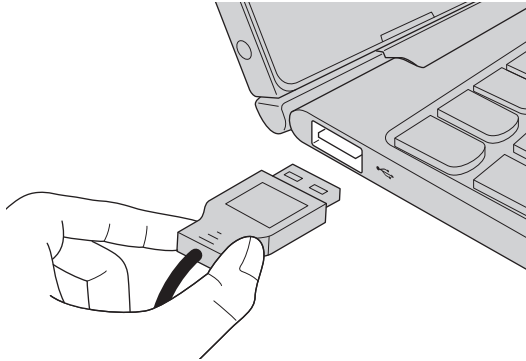

The first time you plug a USB device into a particular USB port on your computer, Windows automatically installs a driver for that device. After the driver has been installed, you can disconnect and reconnect the device without performing any additional steps.

**Note:** Typically, Windows detects a new device after it has been connected, and then installs the driver automatically. However, some devices may require you to install the driver before connecting. Check the documentation provided by the device's manufacturer before connecting the device.

Before disconnecting a USB storage device, make sure your computer has finished transferring data to that device. Click the **Safely Remove Hardware and Eject Media** icon in the Windows notification area to remove the device before disconnecting.

**Note:** If your USB device uses a power cord, connect the device to a power source before connecting it. Otherwise, the device may not be recognized.



### ■ ■ Right-side view

---



- 1 Power button** Press this button to turn on/off the computer.
- 2 Volume up/down button** Increases/decreases the volume level.
- 3 Type-C port** Type-C port supports:
  - USB 3.1
  - DP
  - PD (on select models)
- 4 AC power adapter jack** Connects to the AC power adapter.

### ■ Bottom view

---

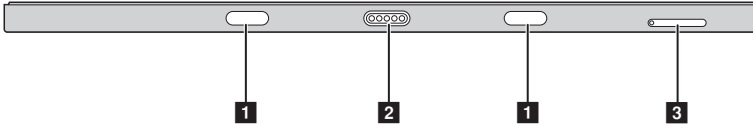

- 1 Tablet-keyboard dock latch** Attaches the tablet to the dock keeping the tablet secured in place.

**Note:** For details, see “Combination of tablet and keyboard dock” on page 15.

- 2 Keyboard dock connector** Connects the tablet to the keyboard dock.
- 3 Nano-SIM-card and microSD card tray** Accept micro SD card (not supplied) and Nano SIM card (not supplied).

**Notes:**

- Select models may not have the Nano SIM card slot, please refer to the actual product.
- For details, see “Using the Nano-SIM-card and microSD card tray” on page 6.

### ■ Using the Nano-SIM-card and microSD card tray

Your computer supports the following types of cards:

- Micro Secure Digital (SD) card
- Nano Subscriber Identity Module (SIM) card (on select models)

**Notes:**

- The card tray may have two slots for different types of cards. Insert only one card in one slot at a time.
- Select models may not have the Nano SIM card slot, please refer to the actual product.
- This card reader does not support SDIO devices (e.g., SDIO Bluetooth and so on.).
- The illustrations are for reference only, please refer to the actual product.

### Inserting card(s)

- 1 Turn off the tablet, and disconnect the AC adapter and any cable(s) from the tablet.
- 2 Insert a prying pin (not supplied) into the tiny hole on the card tray. Press firmly and push it straight in until the card tray pops out.

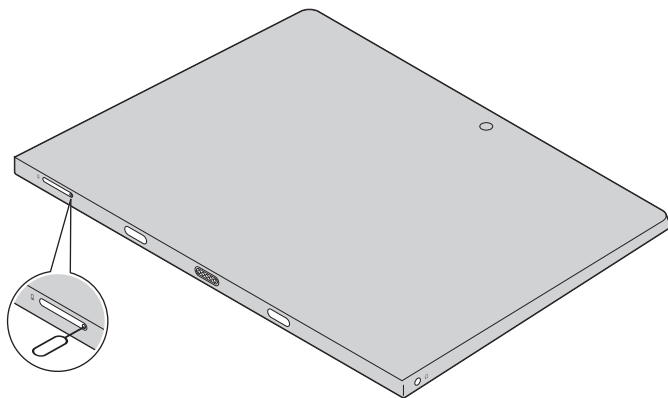

## Chapter 1. Getting to know your computer

- 3 Gently pull the card tray out of the card reader.

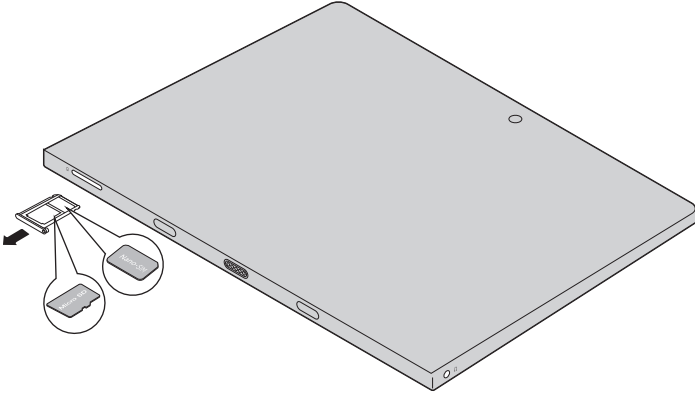

- 4 Put card(s) in the corresponding slot on the card tray.
- 5 Reinsert the card tray.

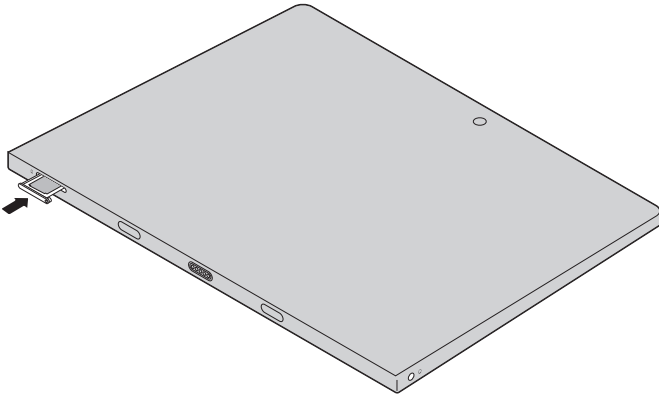

### Removing card(s)

- ① Turn off the tablet, and disconnect the AC adapter and any cable(s) from the tablet.
- ② Insert a prying pin into the tiny hole on the card tray. Press firmly and push it straight in until the card tray pops out.
- ③ Gently pull the card tray out of the card reader.
- ④ Remove card(s) from the card tray, then reinsert the card tray.

#### Notes:

- Do not insert or remove cards while the computer is turned on. Doing so may damage the card reader.
- Before removing the memory card, disable it by using the Windows safely remove hardware and eject media utility to avoid data corruption.

## ■ ■ Rear View

---

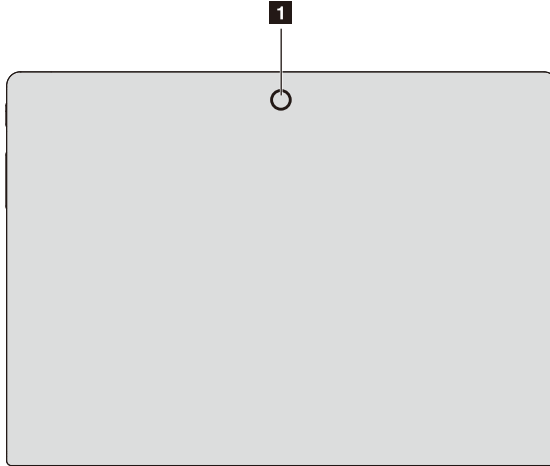

- 1** **Rear camera (on select models)** Use the camera for video communication or taking photos.

## ■ Keyboard dock top view (Optional)

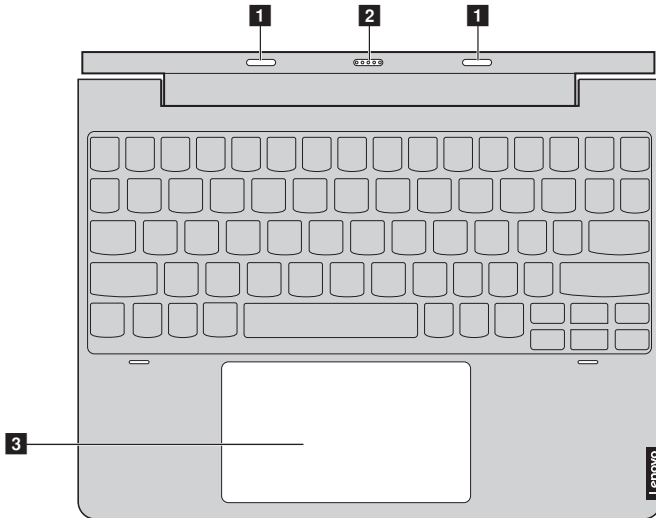

- 1 Tablet-keyboard dock latch** Attaches the tablet to the dock keeping the tablet secured in place.

**Note:** For details, see “Combination of tablet and keyboard dock” on page 15.

- 2 Keyboard dock connector** Connects the tablet to the keyboard dock.

- 3 Touch pad** The touch pad functions as a conventional mouse.

**Touch pad:** To move the pointer on the screen, slide your fingertip over the pad in the direction in which you want the pointer to move.

**Touch pad buttons:** The functions of the left/right side correspond to those of the left/right mouse button on a conventional mouse.

**Note:** You can enable/disable the touch pad by pressing **Fn** + (  Delete ).

## Chapter 1. Getting to know your computer

### ■ Function key combinations

Through the use of the function keys, you can change operational features instantly. To use this function, press and hold **Fn** **1**; then press one of the function keys **2**.

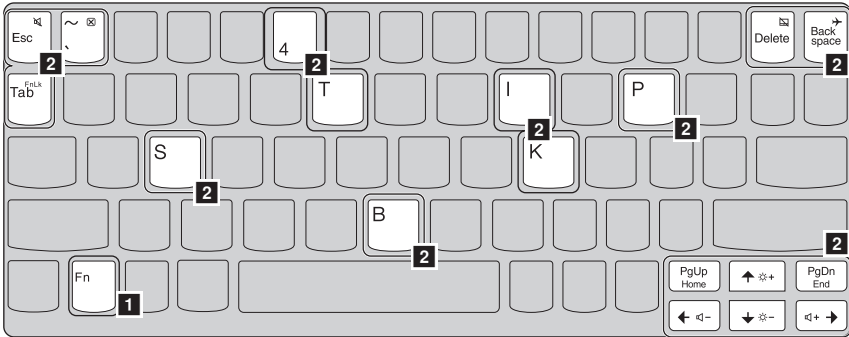

The following describes the features of each function key.

<b>Fn + Esc:</b>	Mutes/unmutes the sound.
<b>Fn + `:</b>	Closes the currently active window.
<b>Fn + Delete:</b>	Enables/disables the touchpad.
<b>Fn + Back space:</b>	Enables/disables Airplane mode.
<b>Fn + PgUp:</b>	Activates the home key function.
<b>Fn + PgDn:</b>	Activates the end key function.
<b>Fn + ↑:</b>	Increases the display brightness.
<b>Fn + ↓:</b>	Decreases the display brightness.
<b>Fn + ←:</b>	Decreases the volume level.
<b>Fn + →:</b>	Increases the volume level.
<b>Fn + B:</b>	Activates the break function.
<b>Fn + P:</b>	Activates the pause function.
<b>Fn + S:</b>	Activates the system request.



## Chapter 1. Getting to know your computer

<b>Fn + K:</b>	Enables/Disables the scroll lock.
<b>Fn + I:</b>	Activates the insert function.
<b>Fn + T:</b>	Activates the print screen function.
<b>Fn + 4:</b>	Activates the sleep mode.
<b>Fn + Tab:</b>	Activates the Magnifier Utility.

**Note:** Hidden Functions applied only on systems where applicable.

## Chapter 1. Getting to know your computer

### Keyboard dock left-side view (Optional)



**1** USB 2.0 port      Connects to USB devices.

### Keyboard dock right-side view (Optional)

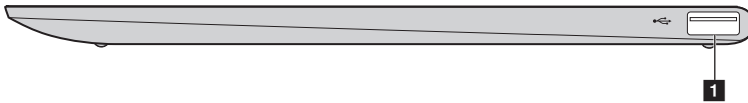

**1** USB 2.0 port      Connects to USB devices.

### ■ Combination of tablet and keyboard dock

The Lenovo ideapad D330-10IGM is not only a tablet. It can be combined with a keyboard dock and used as a notebook computer.

#### **Attaching the tablet**

Align the connector of the keyboard dock with the tablet and then attach the tablet in the direction shown by the arrow.

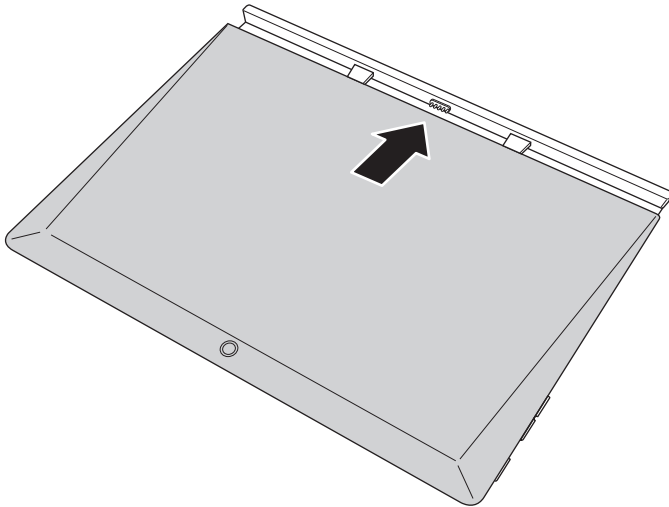

## Chapter 1. Getting to know your computer

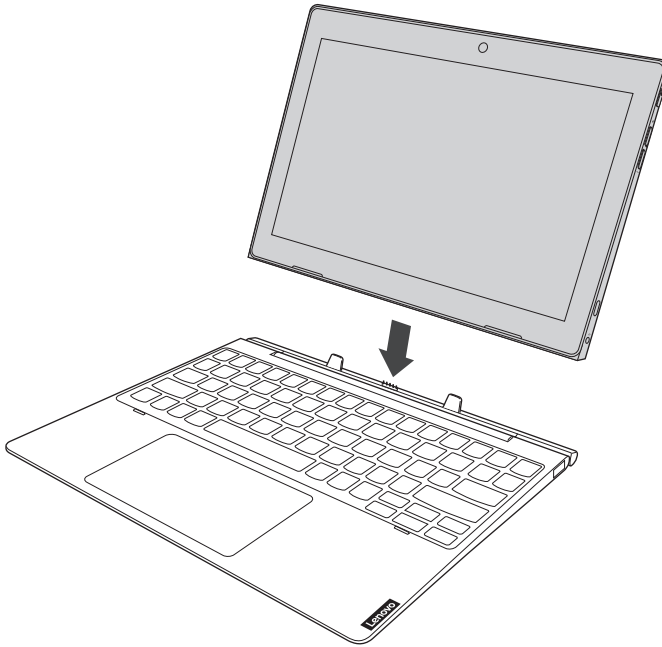

ⓘ **Attention:**

- Do *not* open the display panel beyond 135 degrees. When closing the display panel, be careful *not* to leave pens or any other objects in between the display panel and the keyboard. Otherwise, the display panel may be damaged.

### Detaching the tablet

Carefully detaching the tablet in the direction shown by the arrow.

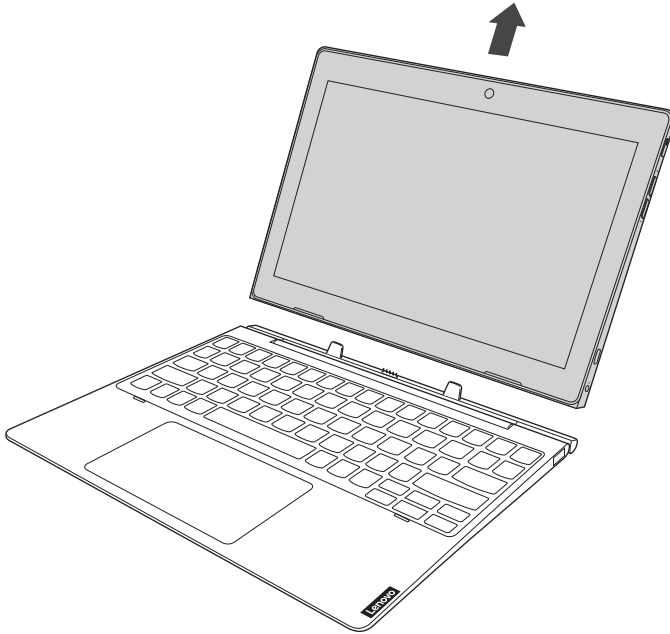

#### Notes:

- Be careful not to damage the connector when attaching or detaching the tablet.
- The illustrations above are for reference only, please refer to the actual product.

## Chapter 1. Getting to know your computer

### ■ ■ To use the Lenovo Active Pen (on select models)

Select model is equipped with the Lenovo Active Pen, to use it, refer to the following illustrations.

#### Functions

##### Writing

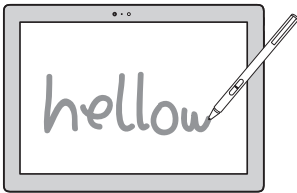

##### Displaying the function menu

Press and hold the upper button of the active pen when it approaches the display screen and the cursor appears.

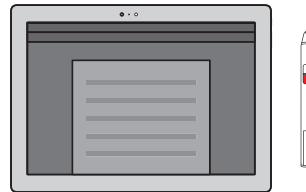

##### Right-clicking function

Press the upper button, then click on the touch screen.

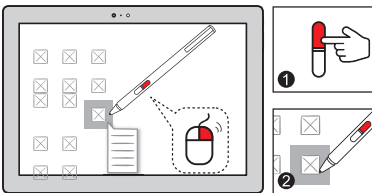

##### Erasing

Press the lower button when writing.

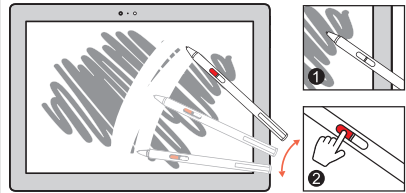

**Note:** The functions depend on the app preinstalled.

**Functions**

**To replace the battery**

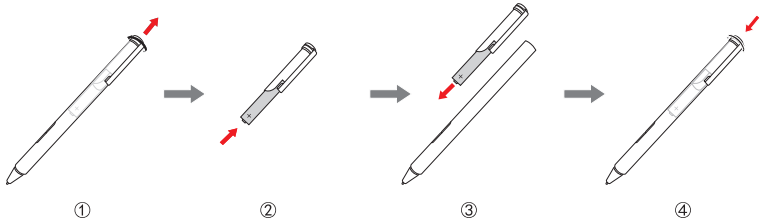

**Note:** Insert the battery by matching the + and – terminals on the battery to the + and – terminals in the battery compartment.

## ■ ■ To use the Lenovo Active Pen2 (on select models)

---

Select model is equipped with the Lenovo Active Pen2, it can be used as a Lenovo Active Pen. About the function of the Lenovo Active Pen, see page 18. Besides, more functions can be used after successful pairing.

### Pairing

**Press and hold the Bluetooth button for more than three seconds to enter pairing mode.**

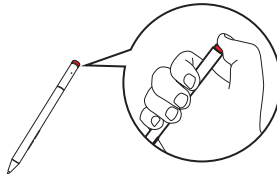

**Note:** Make sure to set the Bluetooth switch of your computer to On before pairing.

### Functions

#### **One-click function of the Bluetooth button**

Depends on the app preinstalled.



#### **Double-click function of the Bluetooth button**

Depends on the app preinstalled.





## To replace the battery

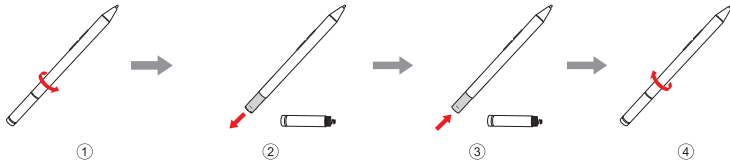

**Note:** Insert the battery by matching the + and – terminals on the battery to the + and – terminals in the battery compartment.

## To replace the rear Bluetooth module battery

When the battery is low, the red LED indicator will flash.



To replace the rear Bluetooth module battery:

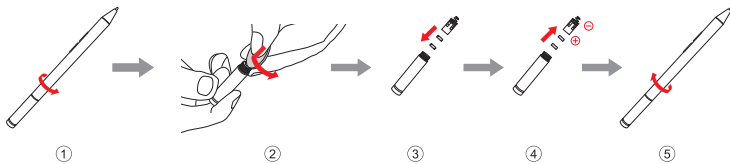

**Note:** Make sure to set the Bluetooth switch of your computer to On before pairing.



## Chapter 2. Starting to use Windows 10

The power button is on the Start menu, click it you can choose to shut down or restart the computer, or put the computer into sleep mode.

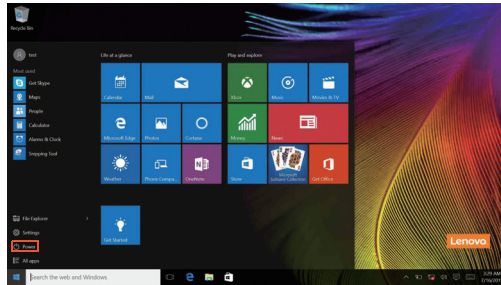

Through the Start menu, you can locate all the installed apps or view the frequently used apps.

### The ACTION CENTER

Select the ACTION CENTER icon  on the taskbar and the ACTION CENTER is displayed.

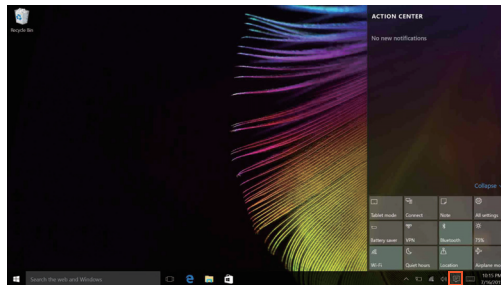

From the ACTION CENTER, you can examine important notifications from Windows and your apps. Moreover, you can change common settings quickly.

## Chapter 2. Starting to use Windows 10

### Task View in taskbar

In Windows 10, you can add a new desktop and switch between different desktops.

To add a new desktop, do the following:

- Click the Task View icon  in the taskbar area.

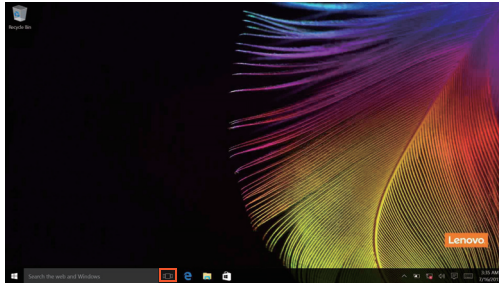

- Click New desktop.

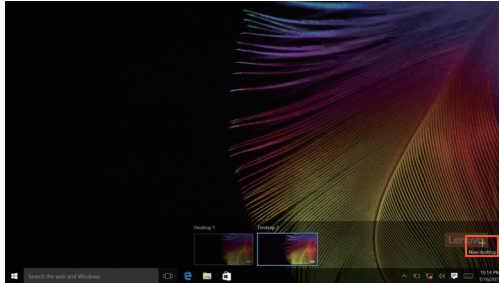

To switch between desktops, click the Task View icon , then select your desired desktop.

## ■ ■ Putting the computer to sleep or shutting it down

---

When you have finished working with your computer, you can put it to sleep or shut it down.

### ■ Putting your computer to sleep

If you will be away from your computer for only a short time, put the computer to sleep.

When the computer is in sleep mode, you can quickly wake it to resume use, bypassing the startup process.

To put the computer to sleep, do one of the following:

- Close the display lid.
- Move the cursor to the lower-left corner, and then select the Start button.

Select **Power**  → **Sleep**.

**Note:** Put your computer to sleep before you move it. Moving your computer while the hard disk drive is spinning can damage the hard disk, causing loss of data.

To wake up the computer, perform the following:

- Press any key on the keyboard.

## Chapter 2. Starting to use Windows 10

### ■ Shutting down the computer

If you are not going to use your computer for a long time, shut it down. To shut down your computer, do one of the following:

- Move the cursor to the lower-left corner, and then select the Start button. Select **Power**  → **Shut down**.

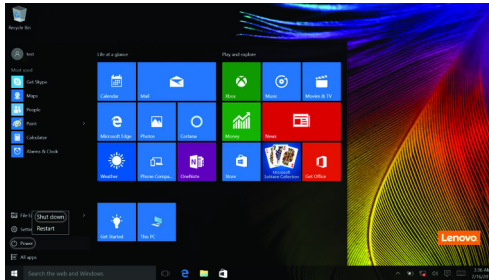

- Right-click the Start button in the lower-left corner and select **Shut down or sign out** → **Shut down**.

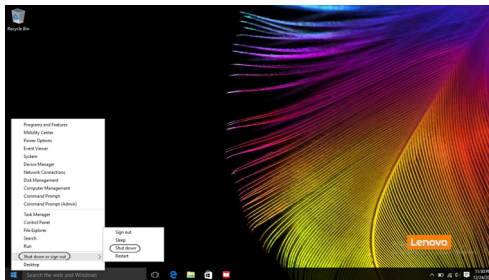



## ■ Touch screen operation



The display panel can accept inputs like a tablet, using the multi-touch screen, or like a traditional notebook computer, using the keyboard and touch pad.

### ■ Multi-touch gestures

You can touch the screen with one or more fingertips to perform a variety of tasks.

Frequently used gestures	Tasks performed
<p><b>Tap</b> Tap once on an item.</p> 	<p>Performs an action, such as starting an app, opening a link, or performing a command. Similar to left-clicking with a mouse.</p>
<p><b>Press and hold</b> Press your finger down and leave it there for a moment.</p> 	<p>Enables you to see detailed information before selecting an action. Can also open a menu with more options. Similar to right-clicking with a mouse.</p>

## Chapter 2. Starting to use Windows 10

Frequently used gestures	Tasks performed
<p><b>Zoom</b> Move two fingers together or apart while touching the screen.</p> 	<p>Zooms in and out on visual apps, such as pictures and maps. Can also jump to the beginning or end of a list.</p>
<p><b>Rotate</b> Place two or more fingers on an item and then turn your hand.</p> 	<p>Rotates an object (Note: Not all items can be rotated, depending upon the app.).</p>
<p><b>Slide</b> Drag your finger across the screen.</p> 	<p>Pans or scrolls through lists and pages. Can also move an object or be used to draw or write, depending upon the app. Similar to pressing and holding to pan and to scrolling with a mouse.</p>





Frequently used gestures	Tasks performed
<p data-bbox="160 288 232 316"><b>Swipe</b></p> <p data-bbox="160 319 572 375">Start from any edge of the screen, then swipe inwards toward the center.</p> 	<p data-bbox="637 288 997 316">Swiping in from the left edge can:</p> <ul data-bbox="637 319 1031 375" style="list-style-type: none"><li data-bbox="637 319 1031 375">• Bring in and open an app currently running in the background.</li></ul> <p data-bbox="637 679 1020 735">Swipe from the right edge can open the ACTION CENTER.</p>

### ■ ■ Connecting to a wireless network

#### Enabling wireless connection

To enable wireless functions, do one of the following:

- Click the ACTION CENTER icon  in the notification area, and then deselect **Airplane mode**.
- Press Fn +  to disable airplane mode.
- Click **Settings**  → **Network & Internet** → **Airplane mode** to open the network configuration page. Then toggle the airplane mode switch to **Off**.

#### Connecting to a wireless network

After wireless has been enabled, the computer will automatically scan for available wireless networks and display them in the wireless network list. To connect to a wireless network, click the network name in the list, and then click **Connect**.

**Note:** Some networks require a network security key or passphrase for connection. To connect to one of those networks, ask the network administrator or the Internet service provider (ISP) for the security key or passphrase.

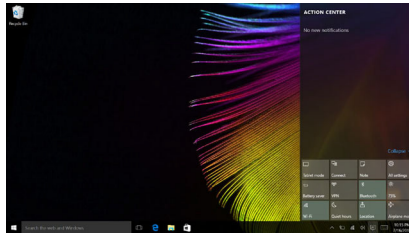

### ■ ■ Get help from Windows ---

If you have a problem with the operating system, see the Windows Get Started app. To open it, do the following:

- Move the cursor to the lower-left corner, and then select the Start button. Select **Get Started** from **All apps**.

# Chapter 3. Recovery system

## ■ Introduction

**Reset this PC** is a built-in recovery tool that enables users to restore their operating system to its original state. This preserves their data and important customizations, without the need to back up their data in advance.

The following **Reset this PC** features are available to users from multiple locations within Windows:

### **Keep my files**

Fixes software problems by reinstalling the factory default configuration. This preserves personal files, and deletes apps and settings.

### **Remove everything**

Prepares the computer for recycling or transfer of ownership. This reinstalls the factory default configuration and returns all user data and applications to the state of their original Out-of-Box Experience (OOBE).

## ■ Using Reset this PC

**Reset this PC** can be launched using one of the following methods:

- Volume up button + Power button:
  - Shut down the computer and wait for at least five seconds.
  - Press and hold the **volume up button** and then press the **Power button**, until the Novo Menu appears on the screen.
  - **Novo Menu** → **System Recovery** → **Troubleshoot** → **Reset this PC**.
- Windows PC settings:
  - **Windows PC settings** → **Update & security** → **Recovery** → **Reset this PC** → select **Start**.

For more instructions, see the Windows Help and Support file on your computer.

### **When I purchased my computer, it included a copy of Windows. How can I determine whether the copy of Windows is preinstalled by Lenovo?**

On the outside of the sales package of your computer, you should find a label containing configuration information for your computer. Check the printed string next to **OS**. If it contains **Windows** or **WIN**, the copy of Windows was preinstalled by Lenovo.

### **What is the Recovery Partition?**

If your computer is preinstalled with any version of Windows 10, the storage device of your computer contains a Recovery Partition. This partition contains the image file of the preinstalled Windows operating system. In cases of system failure, you can use the Lenovo OneKey Recovery system or the Windows Reset feature to restore the operating system to its factory status.

**Note:** The Recovery Partition is not assigned a drive letter and cannot be accessed through Windows File Explorer.

### **I uninstalled a preinstalled software, but there is no significant increase in the free drive space.**

The copy of Windows running on your computer may be Compact technology enabled. For computers with Compact technology enabled Windows, the majority of files needed for preinstalled software are installed on the Recovery Partition and won't be deleted through normal uninstallation.

### **What happens if I attempt to delete or modify the Recovery Partition?**

#### **⦿ Attention:**

- Do *not* delete or modify the Recovery Partition on a Compact technology enabled computer.

If the Recovery Partition is deleted or modified, you may not be able to restore Windows to the factory status. For computer models on which Compact technology is enabled, deleting the Recovery Partition may cause Windows to fail to start.

### **How can I determine whether the Windows running on my computer is Compact technology enabled?**

Compact technology is normally enabled on copies of Windows 10 Update running on SSD (or eMMC) -only computer models. To check your computer,

## Chapter 3. Recovery system

- 1 Right-click the Start button in the lower-left corner and select **Disk Management**.
- 2 The Disk Management program starts.

If **Wim Boot** is labeled on the Windows partition (as illustrated), Compact technology is enabled on your copy of Windows.



# Chapter 4. Troubleshooting

## ■ ■ Frequently asked questions

---

This section lists frequently asked questions by category.

### ■ Finding information

#### **What safety precautions should I follow when using my computer?**

The *Lenovo Safety and General Information Guide* which came with your computer contains safety precautions for using your computer. Read and follow all the precautions when using your computer.

#### **Where can I find the hardware specifications for my computer?**

You can find hardware specification for your computer on the printed flyers which came with your computer.

#### **Where can I find warranty information?**

For the warranty applicable to your computer, including the warranty period and type of warranty service, see the Lenovo limited warranty flyer that came with your computer.

### ■ Drivers

#### **Where can I find drivers for the various hardware devices of my computer?**

You can download the latest device drivers from the Lenovo consumer support website.

### ■ Getting help

#### **How can I contact the customer support center?**

See “Chapter 3. Getting help and service” of *Lenovo Safety and General Information Guide*.

### ■ ■ Troubleshooting

---

#### Display problems

When I turn on the computer, nothing appears on the screen.

- If the screen is blank, make sure that:
  - The AC power adapter is connected to the computer, and the power cord is plugged into a working electrical outlet.
  - The computer power is on. Press the Power button again for confirmation.
- If these items are set correctly, and the screen remains blank, have the computer serviced.

When I turn on the computer, only a white cursor appears on a blank screen.

- Restore backed-up files to your Windows environment or the entire contents of your hard disk to its original factory contents using Push-button reset. If you still see only the cursor on the screen, have the computer serviced.

The screen goes blank while the computer is on.

- Your power management is enabled. Perform the following to resume from sleep mode:
  - Press any key on the keyboard.

#### Sleep problems

The critical low-battery error message appears, and the computer immediately turns off.

- The battery power is getting low. Connect the AC power adapter to the computer.

The computer enters sleep mode immediately after Power-on.

- Make sure that:
  - The battery is charged.
  - The operating temperature is within the acceptable range. See “Chapter 2. Use and care Information” in the *Lenovo Safety and General Information Guide*.

**Note:** If the battery is charged and the temperature is within range, have the computer serviced.



The computer does not return from sleep mode and the computer does not work.

- If your computer is in sleep mode, connect the AC power adapter to the computer, then press the Windows button or the Power button.
- If the system still does not return from sleep mode, your system has stopped responding, and you cannot turn off the computer; reset the computer. Unsaved data may be lost. To reset the computer, press and hold the Power button for eight seconds or more. If the computer still does not reset, remove the AC power adapter.

### Display panel problems

The screen is blank.

- Do the following:
  - If you are using the AC power adapter or the battery, and the battery status indicator is on, press **Fn + ** to make the screen brighter.
  - If the power indicator is blinking, press the Power button to resume from sleep mode.
  - If the problem persists, follow the solution in the next problem “The screen is unreadable or distorted.”

The screen is unreadable or distorted.

- Make sure that:
  - The screen resolution and color quality are correctly set.
  - The monitor type is correct.

Incorrect characters appear on the screen.

- Is the operating system or programs installed correctly? If they are installed and configured correctly, have the computer serviced.

### Sound problems

No sound can be heard from the speakers even when the volume is turned up.

- Make sure that:
  - The Mute function is off.
  - The combo audio jack is not being used.
  - Speakers are selected as the playback device.

## Chapter 4. Troubleshooting

### Battery problems

Your computer shuts down before the battery status indicator shows empty.

-or-

Your computer operates after the battery status indicator shows empty.

- Recharge the battery.

### Other problems

Your computer does not respond.

- To turn off your computer, press and hold the Power button for eight seconds or more. If the computer still does not respond, remove the AC power adapter.
- Your computer might lock when it enters sleep mode during a communication operation. Disable the sleep timer when you are working on the network.

The connected external device does not work.

- Do *not* connect or disconnect any external device cables other than USB while the computer power is on. Otherwise, you might damage your computer.
- When using high power consumption external devices, such as an external USB optical drive, use an external device power adapter. Otherwise, the device may not be recognized, or the system may shut down as a result.

# Trademarks

The following terms are trademarks or registered trademarks of Lenovo in the United States, other countries, or both.

Lenovo

Microsoft and Windows are trademarks of Microsoft Corporation in the United States, other countries, or both.

Other company, products, or service names may be trademarks or service marks of others.

