

Dell™ XPS 18  
User's Manual



# Notes, Cautions, and Warnings



**NOTE:** A NOTE indicates important information that helps you make better use of your computer.



**CAUTION:** A CAUTION indicates potential damage to hardware or loss of data if instructions are not followed.



**WARNING:** A WARNING indicates a potential for property damage, personal injury, or death.

-----  
Information in this document is subject to change without notice.

© 2013 Dell Inc. All rights reserved.

Reproduction of these materials in any manner whatsoever without the written permission of Dell Inc. is strictly forbidden.

Trademarks used in this text: Dell™ the DELL logo, and XPS are trademarks of Dell Inc.; Microsoft®, and Windows® are either trademarks or registered trademarks of Microsoft Corporation in the United States and/or other countries.

Other trademarks and trade names may be used in this document to refer to either the entities claiming the marks and names or their products.

Dell Inc. disclaims any proprietary interest in trademarks and trade names other than its own.



# Contents

<b>1</b>	<b>Features</b> . . . . .	<b>6</b>
<b>2</b>	<b>Accessories</b> . . . . .	<b>10</b>
<b>3</b>	<b>Setting Up Your Computer</b> . . . . .	<b>12</b>
	Connect the Power Cable to the Power Adapter . . . . .	12
	Charge Your Computer . . . . .	13
	Insert an SD Card (optional) . . . . .	15
	Turning On Your Computer . . . . .	16
	Enable/Disable Wi-Fi . . . . .	18
	Connecting to a Network . . . . .	18
	Switch Networks . . . . .	18
<b>4</b>	<b>Using Your Computer</b> . . . . .	<b>19</b>
	Screen Orientation . . . . .	19
	Windows 8 Start Screen . . . . .	20
	Gestures . . . . .	21
	Using Headphones/Microphones . . . . .	26
	Removing the SD Card . . . . .	27
	Turning Off the Screen . . . . .	28
	Turning Off Your Computer . . . . .	28
	Managing Computer Settings . . . . .	29
<b>5</b>	<b>Synchronizing Your Computer</b> . . . . .	<b>31</b>

<b>6</b>	<b>Powered Stand (optional)</b> . . . . .	<b>32</b>
	Features . . . . .	32
	Using the Powered Stand . . . . .	34
	Dock Your Computer on the Powered Stand. . . . .	36
	Undocking Your Computer . . . . .	37
<b>7</b>	<b>Cleaning Your Computer</b> . . . . .	<b>38</b>
<b>8</b>	<b>Troubleshooting.</b> . . . . .	<b>39</b>
<b>9</b>	<b>Locating Your Service Tag and Express Service Code</b>	<b>43</b>
<b>10</b>	<b>Specifications</b> . . . . .	<b>44</b>

# Features

This section provides information about the features available on your computer.

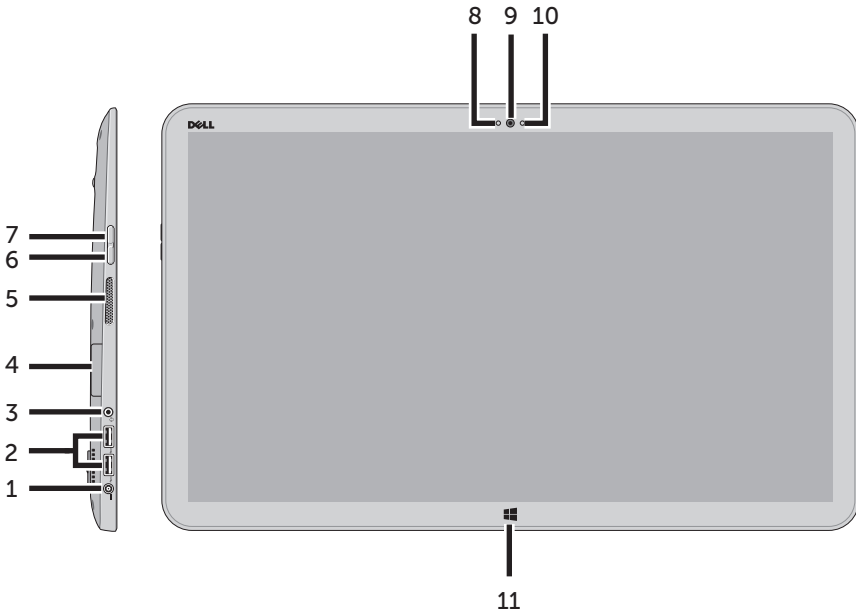

Feature	Functionality
1 Power-adaptor port	Connect the supplied power adapter to provide power to the computer and charge the battery.
2 USB 3.0 ports (2)	Connect USB devices for transferring or synchronizing data, music, photos, videos, contacts, and so on.
3 Audio port (3.5 mm)	Connect headphones, microphones, and other audio equipment to listen to stereo sound, record audio, or make calls.
4 SD-card slot	Full-sized SD-card slot.
5 Left speaker	Provides audio output for video and music playback.

<b>Feature</b>	<b>Functionality</b>
<b>6</b> Volume-down button	<ul style="list-style-type: none"><li>• Press to decrease the volume by one level.</li><li>• Press and hold to continuously decrease the volume.</li></ul>
<b>7</b> Volume-up button	<ul style="list-style-type: none"><li>• Press to increase the volume by one level.</li><li>• Press and hold to continuously increase the volume.</li></ul>
<b>8</b> Camera-status light	Turns on when camera is active.
<b>9</b> Front-facing camera	<ul style="list-style-type: none"><li>• Capture a front-view picture or record videos.</li><li>• Make video calls with web applications, such as Skype.</li></ul>
<b>10</b> Ambient-light sensor	Automatically adjusts the brightness of the display's backlight based on surrounding light levels.
<b>11</b> Windows button	<ul style="list-style-type: none"><li>• Press to access/show the Windows Start screen.</li><li>• Press for quick access to the most recently used application or most recently viewed screen.</li></ul>

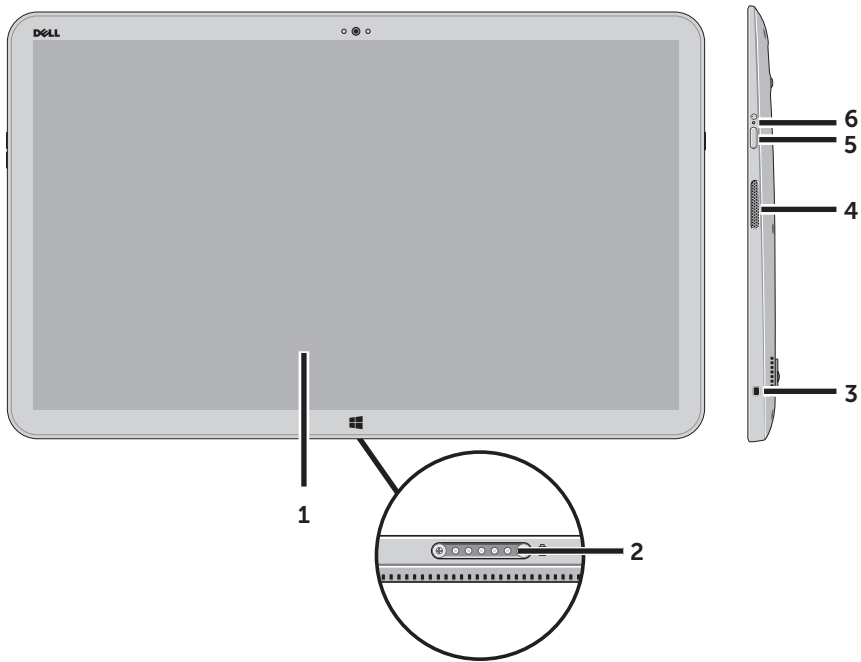

Feature	Functionality
<b>1</b> Touchscreen display	Touch the display to use on-screen controls including buttons, menu items, and the on-screen keyboard.
<b>2</b> Docking port	Connect to a Dell Powered Stand (optional).
<b>3</b> Noble lock port	Allows you to secure your computer using a Noble lock.
<b>4</b> Right speaker	Provides audio output for video and music playback.
<b>5</b> Power and sleep/wake button	Press and release to turn your computer on or off.
<b>6</b> Power/Battery-status indicator	Indicates the power/battery charge status. (see <a href="#">battery status table</a> )



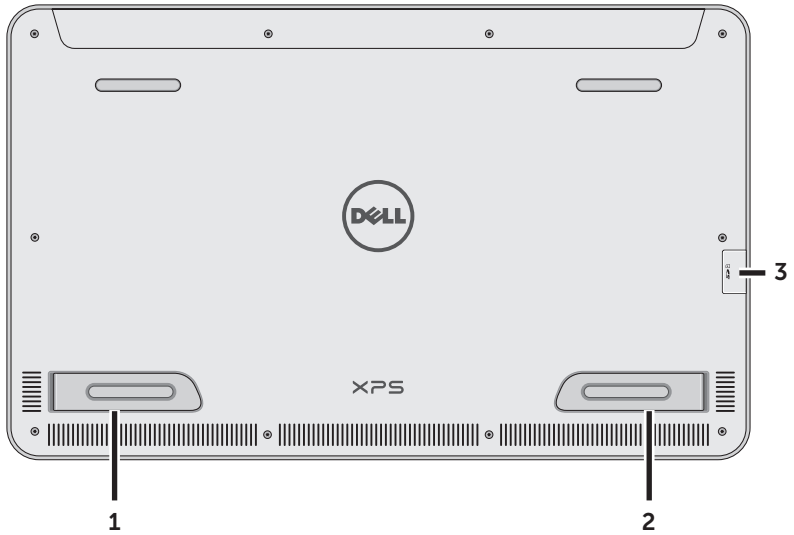

Feature	Functionality
<b>1</b> Right foot <b>CAUTION:</b> Not for use in portrait mode	Fold outwards to allow your computer to stand upright, fold inwards to allow your computer to lay flat.
<b>2</b> Left foot <b>CAUTION:</b> Not for use in portrait mode	Fold outwards to allow your computer to stand upright, fold inwards to allow your computer to lay flat.
<b>3</b> SD-card slot	Full-sized SD-card slot.

# Accessories

Your computer package includes the following accessories:

- **Power adapter and cable** — Provides power to your computer and charges the battery.



- **USB to ethernet adapter (optional)** — Allows you to connect a RJ45 (network) cable to your computer using a USB port.



- **Powered stand (optional)** — Allows your computer to be placed upright with adjustable viewing angles and battery charging capabilities.



- **Wireless keyboard and mouse (optional)** - Inputs text and controls the cursor.



 **NOTE:** The keyboard and mouse are already paired to your computer if you ordered the keyboard and mouse along with your computer. If you purchased the keyboard and mouse separately, or if you need to pair them again, see [Pairing the Wireless Keyboard and Mouse](#).

# Setting Up Your Computer

This section provides information about setting up your computer for first use.



**WARNING:** Before you begin any of the procedures in this section, read the safety information that shipped with your computer. For additional best practices information, see [www.dell.com/regulatory\\_compliance](http://www.dell.com/regulatory_compliance).

## Connect the Power Cable to the Power Adapter



# Charge Your Computer

**CAUTION:** Charge the battery in an environmental temperature between 0 °C and 40 °C (32 °F and 104 °F).

**CAUTION:** Use only the supplied power adapter and power cable to charge your computer. Using unauthorized power adapters or power cables may severely damage to your computer.

**NOTE:** Your computer *cannot* be charged through a USB cable.

**NOTE:** The battery is not fully charged when you first receive it.

**NOTE:** You receive your computer in shipping mode to prevent it from accidentally turning on during shipping. To turn on your computer for the first time, connect the power adapter and then press the power button.

- 1 Connect the power adapter to your computer.

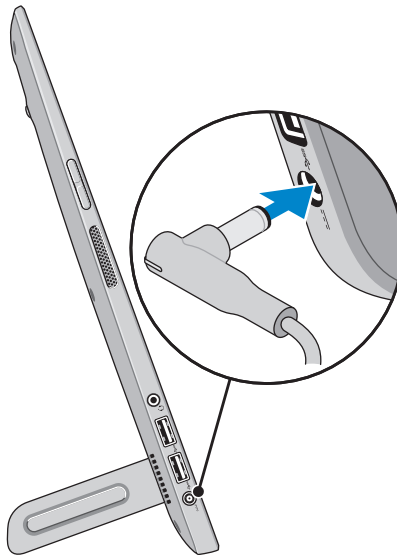

- 2 Connect the power adapter into an electrical outlet and charge your computer until the battery is fully charged.

**NOTE:** A completely discharged battery takes 4-5 hours to charge fully while the computer is turned off.







**NOTE:** The battery charge light on the right side of your computer turns off once the battery is fully charged.

You can check the charge/power status of your computer by checking the light on the side of your computer or the icon on the screen when your computer is turned on:

**Battery-charge indicator located on the right side of your computer:**

Power state	Battery with no power adapter	Power adapter and battery fully charged	Power adapter and battery is charging
S0/S1 (ON)	Solid white	Solid white	Solid amber
S3 (Sleep)	Slow blinking white	Slow blinking white	Slow blinking amber
S4/S5 (Hibernate or OFF)	OFF	OFF	Solid amber
Low battery	Fast blinking amber	Fast blinking amber	Fast blinking amber

**Battery icon displayed on the screen:**

Battery icon	Description
	Battery is fully charged
	Battery is charging
	Computer is running on battery power and the battery is discharging.
	Computer is plugged in, and either no battery is detected, or the battery isn't working correctly.
	Battery is low
	Battery is critically low

 **NOTE:** You can check exact battery charge level by booting to the operating system.

## Insert an SD Card (optional)

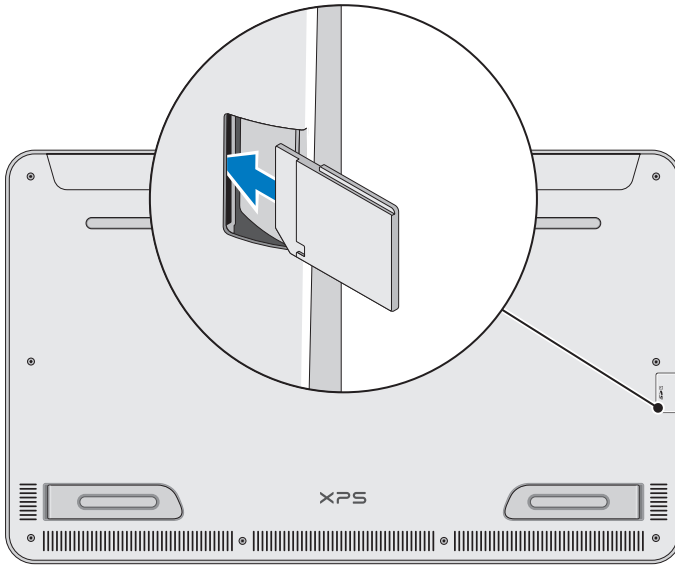

- 1 Make sure the orientation of the SD card is correct so that the pins on the card are facing the rear when inserted.
- 2 Push the slot cover down.
- 3 Push the SD card into the spring-loaded slot until it is locked firmly into place.



**NOTE:** The SD-card slot is compatible with Standard-Capacity (SDSC), High-Capacity (SDHC), the eXtended-Capacity (SDXC) storage cards, Memory Stick, Memory Stick Pro, MMC, and xD, with a maximum storage capacity of 2 TB.

# Turning On Your Computer

 **CAUTION:** Use your computer in an ambient temperature between 0 °C and 35 °C (32 °F and 95 °F).

1 Press and release the **Power and Sleep/Wake** button .

 **NOTE:** After the button is pressed, there is a slight delay before your computer turns on or off.

2 Complete all steps for the initial setup of Windows including Personalize, Settings, Sign in.

3 Enable security on the Security & Dell Updates page.

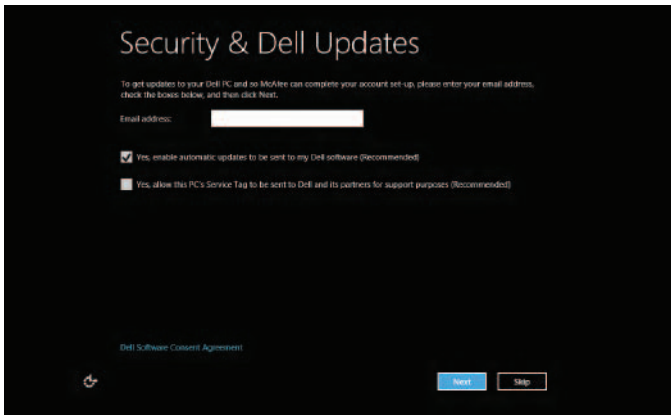

4 Configure wireless settings (optional).

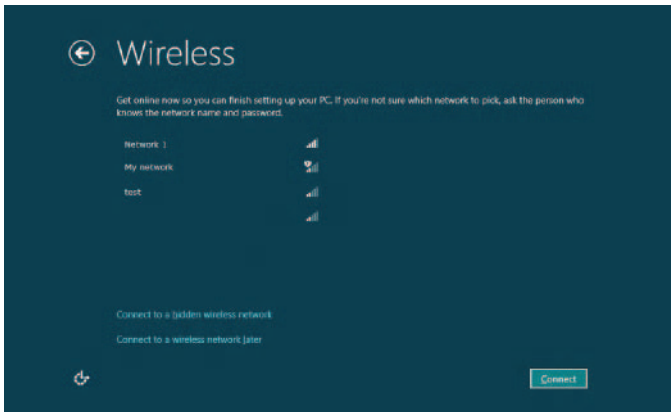



## 5 Complete initial setup of Windows.

Your computer is ready for use when the Windows Start screen is displayed.



**NOTE:** A lock screen may be displayed when your computer wakes up from a sleep state.





**NOTE:** If the login screen is not enabled, the Start screen appears after you swipe-up on the lock screen.

## Enable/Disable Wi-Fi

- 1 Swipe from the right edge of the display to access Charms.
- 2 Touch **Settings**  → **Change PC settings** → **Wireless**.
- 3 Move the slider to the right to enable Wi-Fi. Move the Wi-Fi slider to the left to disable Wi-Fi.

## Connecting to a Network

- 1 Swipe from the right edge of the display to access Charms.
- 2 Touch **Settings**  → **Available**  → Select an available network → **Connect**.

## Switch Networks



**NOTE:** If you need to connect to another network later, access Charms →  and select the network you want to connect to.

# Using Your Computer





## Screen Orientation

For optimal viewing experience, the screen orientation changes automatically to portrait or landscape format depending on your computer's orientation. Automatic screen rotation is enabled by default.



**NOTE:** Some applications may not support automatic screen rotation.



### Enabling/Disabling automatic screen rotation

- 1 Swipe from the right edge of the display to access Charms.
- 2 Touch **Settings**  → **Screen** .
- 3 Touch  or  to toggle automatic screen rotation.



# Windows 8 Start Screen

The Windows 8 Start screen displays a list of default and custom Live Tiles, which act as shortcuts to various installed applications.

Live Tiles on your Start screen update in real time with information on news, sports, weather, stocks, social networks, and so on. The tile-based user interface gives you direct access to your most recently used applications, emails, photos, music, videos, contacts, social media updates, and frequently viewed websites. You can pin desired or favorite applications as Live Tiles to customize the Start screen.

 **NOTE:** You can add or remove Live Tiles by using Pin  or Unpin  options.

## Accessing the Start screen

- Press the **Windows** button .
- Swipe from the right edge of the display to access Charms, and then touch the **Start** icon .

 **NOTE:** The **Start** icon  in the Charms sidebar and the Start button  on your computer have the same functionality.

## Getting more information on Windows 8

Touch the Getting Started With Windows tile on the Start screen to get more information about the features of Windows 8.

