

Intel® Desktop Board DQ35MP Product Guide

Order Number: D90042-004

Revision History

Revision	Revision History	Date
-001	First release of the Intel® Desktop Board DQ35MP Product Guide	May 2007
-002	Second release of the Intel® Desktop Board DQ35MP Product Guide	January 2008
-003	Third release of the Intel® Desktop Board DQ35MP Product Guide	February 2008
-004	Fourth release of the Intel® Desktop Board DQ35MP Product Guide	March 2008

If an FCC declaration of conformity marking is present on the board, the following statement applies:

FCC Declaration of Conformity

This device complies with Part 15 of the FCC Rules. Operation is subject to the following two conditions: (1) this device may not cause harmful interference, and (2) this device must accept any interference received, including interference that may cause undesired operation.

For questions related to the EMC performance of this product, contact:

Intel Corporation, 5200 N.E. Elam Young Parkway, Hillsboro, OR 97124
1-800-628-8686

This equipment has been tested and found to comply with the limits for a Class B digital device, pursuant to Part 15 of the FCC Rules. These limits are designed to provide reasonable protection against harmful interference in a residential installation. This equipment generates, uses, and can radiate radio frequency energy and, if not installed and used in accordance with the instructions, may cause harmful interference to radio communications. However, there is no guarantee that interference will not occur in a particular installation. If this equipment does cause harmful interference to radio or television reception, which can be determined by turning the equipment off and on, the user is encouraged to try to correct the interference by one or more of the following measures:

- Reorient or relocate the receiving antenna.
- Increase the separation between the equipment and the receiver.
- Connect the equipment to an outlet on a circuit other than the one to which the receiver is connected.
- Consult the dealer or an experienced radio/TV technician for help.

Any changes or modifications to the equipment not expressly approved by Intel Corporation could void the user's authority to operate the equipment.

Tested to comply with FCC standards for home or office use.

Canadian Department of Communications Compliance Statement

This digital apparatus does not exceed the Class B limits for radio noise emissions from digital apparatus set out in the Radio Interference Regulations of the Canadian Department of Communications.

Le présent appareil numérique n'émet pas de bruits radioélectriques dépassant les limites applicables aux appareils numériques de la classe B prescrites dans le Règlement sur le brouillage radioélectrique édicté par le ministère des Communications du Canada.

Disclaimer

INFORMATION IN THIS DOCUMENT IS PROVIDED IN CONNECTION WITH INTEL® PRODUCTS. NO LICENSE, EXPRESS OR IMPLIED, BY ESTOPPEL OR OTHERWISE, TO ANY INTELLECTUAL PROPERTY RIGHTS IS GRANTED BY THIS DOCUMENT. EXCEPT AS PROVIDED IN INTEL'S TERMS AND CONDITIONS OF SALE FOR SUCH PRODUCTS, INTEL ASSUMES NO LIABILITY WHATSOEVER, AND INTEL DISCLAIMS ANY EXPRESS OR IMPLIED WARRANTY, RELATING TO SALE AND/OR USE OF INTEL PRODUCTS INCLUDING LIABILITY OR WARRANTIES RELATING TO FITNESS FOR A PARTICULAR PURPOSE, MERCHANTABILITY, OR INFRINGEMENT OF ANY PATENT, COPYRIGHT OR OTHER INTELLECTUAL PROPERTY RIGHT. Intel products are not intended for use in medical, life saving, or life sustaining applications. Intel may make changes to specifications and product descriptions at any time, without notice.

Desktop Board DQ35MP may contain design defects or errors known as errata which may cause the product to deviate from published specifications. Current characterized errata are available on request.

Contact your local Intel sales office or your distributor to obtain the latest specifications and before placing your product order.

Copies of documents which have an ordering number and are referenced in this document, or other Intel literature, may be obtained from Intel Corporation by going to the World Wide Web site at: <http://www.intel.com/> or by calling 1-800-548-4725.

Intel and the Intel logo are trademarks of Intel Corporation in the United States and other countries.

* Other names and brands may be claimed as the property of others.

Copyright © 2007-2008, Intel Corporation. All rights reserved.

Preface

This Product Guide gives information about board layout, component installation, BIOS update, and regulatory requirements for Intel® Desktop Board DQ35MP.

Intended Audience

The Product Guide is intended for technically qualified personnel. It is not intended for general audiences.

Use Only for Intended Applications

All Intel Desktop Boards are evaluated as Information Technology Equipment (I.T.E.) for use in personal computers (PC) for installation in homes, offices, schools, computer rooms, and similar locations. The suitability of this product for other PC or embedded non-PC applications or other environments, such as medical, industrial, alarm systems, test equipment, etc., may not be supported without further evaluation by Intel.

Document Organization

The chapters in this Product Guide are arranged as follows:

- 1 Desktop Board Features: a summary of product features
- 2 Installing and Replacing Desktop Board Components: instructions on how to install the Desktop Board and other hardware components
- 3 Updating the BIOS: instructions on how to update the BIOS
- 4 Configuring for RAID (Intel® Matrix Storage Technology): information about configuring your system for RAID.
- 5 Configuring for Intel® Rapid Recover Technology: information about configuring your system for Intel Rapid Recover Technology
- A Error Messages and Indicators: information about BIOS error messages and beep codes
- B Regulatory Compliance: safety and EMC regulations and product certifications

Conventions

The following conventions are used in this manual:



CAUTION

Cautions warn the user about how to prevent damage to hardware or loss of data.



NOTE

Notes call attention to important information.

Terminology

The table below gives descriptions of some common terms used in the product guide.

Term	Description
GB	Gigabyte (1,073,741,824 bytes)
GHz	Gigahertz (one billion hertz)
KB	Kilobyte (1024 bytes)
MB	Megabyte (1,048,576 bytes)
Mbit	Megabit (1,048,576 bits)
MHz	Megahertz (one million hertz)

Contents

1 Desktop Board Features

Supported Operating Systems.....	11
Desktop Board Components.....	12
Processor.....	14
Main Memory.....	14
Intel® Q35 Express Chipset	15
Intel Q35 Graphics Subsystem.....	16
Intel® GMA 3100 Graphics Controller.....	16
Audio Subsystem	17
Legacy Input/Output (I/O) Controller	18
LAN Subsystem	18
RJ-45 LAN Connector LEDs.....	19
Intel® Active Management Technology (Intel® AMT)	19
Intel AMT Status Indicator	20
Hi-Speed USB 2.0 Support	21
Enhanced IDE Interface	21
Serial ATA.....	21
Serial ATA RAID	21
Intel® Rapid Recover Technology	22
Expandability.....	22
BIOS	22
Serial ATA and IDE Auto Configuration.....	22
PCI* and PCI Express* Auto Configuration	22
Security Passwords.....	23
Hard Disk Drive Passwords.....	23
Hard Disk Drive Password Feature During BIOS POST.....	24
Trusted Platform Module (TPM)	24
Hardware Management Features	24
Hardware Monitoring and Fan Speed Control	25
Chassis Intrusion.....	25
Power Management Features	25
ACPI.....	26
Hardware Support	26
Power Connectors	26
Fan Headers	26
LAN Wake Capabilities.....	27
Instantly Available PC Technology.....	27
+5 V Standby Power Indicator.....	28
Wake from USB	28
PME# Signal Wake-up Support.....	29
WAKE# Signal Wake-up Support	29
ENERGY STAR* Capable	29
Speaker.....	29
Battery	29
Real-Time Clock.....	29

2 Installing and Replacing Desktop Board Components

Before You Begin	31
Installation Precautions.....	32
Prevent Power Supply Overload	32
Observe Safety and Regulatory Requirements.....	32
Installing the I/O Shield	33
Installing and Removing the Desktop Board	34
Installing and Removing a Processor	35
Installing a Processor	35
Installing the Processor Fan Heat Sink	38
Connecting the Processor Fan Heat Sink Cable.....	39
Removing the Processor	40
Installing and Removing Memory.....	40
Guidelines for Dual Channel Memory Configuration.....	41
Two or Four DIMMs	41
Three DIMMs	42
Installing DIMMs	43
Removing DIMMs.....	45
Installing and Removing a PCI Express x16 Card	46
Installing a PCI Express x16 Card	46
Removing the PCI Express x16 Card.....	47
Connecting the IDE Cable.....	48
Connecting the Serial ATA (SATA) Cables	50
Connecting to the Internal Headers	51
Connecting to the HD Audio Link Header.....	52
Installing a Front Panel Audio Solution for Intel® High Definition Audio	52
Connecting to the Chassis Intrusion Header.....	53
Connecting to the Serial Port Header	53
Connecting to the Alternate Front Panel Power LED Header.....	54
Connecting to the Front Panel Header.....	54
Connecting to the USB 2.0 Headers.....	55
Connecting to the Audio System.....	55
Connecting Chassis Fan and Power Supply Cables.....	56
Connecting Chassis Fan Cables	56
Connecting Supply Power Cables	57
Setting the BIOS Configuration Jumper	58
Clearing or Changing Passwords.....	60
Clearing BIOS Security Passwords.....	60
Clearing or Changing Hard Disk Drive Passwords.....	61
Replacing the Battery	61

3 Updating the BIOS

Updating the BIOS with the Intel® Express BIOS Update Utility.....	67
Updating the BIOS with the ISO Image BIOS Update File or the Iflash Memory Update Utility	68
Obtaining the BIOS Update File	68
Updating the BIOS with the ISO Image BIOS Update File	68
Updating the BIOS with the Iflash Memory Update Utility	69
Recovering the BIOS.....	70

4	Configuring for RAID (Intel® Matrix Storage Technology)	
	Configuring the BIOS for Intel Matrix Storage Technology	71
	Creating Your RAID Set.....	71
	Loading the Intel Matrix Storage Technology RAID Drivers and Software.....	72
	Setting Up a “RAID Ready” System.....	72
5	Configuring for Intel® Rapid Recover Technology	
	Enabling Intel Rapid Recover Technology.....	73
	Creating a Recovery Volume.....	74
	Creating a Recovery Volume Using the RAID Option ROM	74
	Creating a Recovery Volume Using the Intel Matrix Storage Console	74
	Disk Synchronization Mode	75
	Mounting the Recovery Disk	75
A	Error Messages and Indicators	
	BIOS Beep Codes.....	77
	BIOS Error Messages.....	77
B	Regulatory Compliance	
	Safety Standards	79
	Place Battery Marking	79
	European Union Declaration of Conformity Statement.....	80
	Product Ecology Statements	81
	Recycling Considerations	81
	Lead-Free Desktop Board.....	83
	EMC Regulations	85
	Ensure Electromagnetic Compatibility (EMC) Compliance.....	86
	Product Certifications.....	87
	Board-Level Certification Markings	87
	Chassis and Component Certifications.....	88

Figures

1.	Desktop Board DQ35MP Components	12
2.	LAN Connector LEDs	19
3.	Intel AMT Status Indicator	20
4.	Standby Power Indicator.....	28
5.	Installing the I/O Shield	33
6.	Desktop Board DQ35MP Mounting Screw Hole Locations.....	34
7.	Lift the Socket Lever	35
8.	Lift the Load Plate.....	36
9.	Remove the Protective Socket Cover	36
10.	Remove the Processor from the Protective Processor Cover	37
11.	Install the Processor	37
12.	Close the Load Plate	38
13.	Connecting the Processor Fan Heat Sink Cable to the Processor Fan Header	39
14.	Dual Channel Memory Configuration with Two DIMMs	41
15.	Dual Channel Memory Configuration with Four DIMMs.....	41
16.	Dual Channel Memory Configuration with Three DIMMs	42
17.	Use DDR2 DIMMs	43
18.	Installing a DIMM	44

19. Installing a PCI Express x16 Card	46
20. Removing a PCI Express x16 Card	47
21. Connecting the IDE Cable	49
22. Connecting a Serial ATA Cable	50
23. Internal Headers	51
24. Back Panel Audio Connectors	55
25. Location of the Chassis Fan Headers	56
26. Connecting Power Supply Cables	57
27. Location of the BIOS Configuration Jumper Block	58
28. Removing the Battery	66

Tables

1. Feature Summary	9
2. Desktop Board DQ35MP Components	13
3. LAN Connector LEDs	19
4. Intel AMT Status Indicator	20
5. HD Audio Link Header Signal Names	52
6. Front Panel Intel High Definition Audio Header Signal Names	52
7. Chassis Intrusion Header	53
8. Serial Port Header Signal Names	53
9. Alternate Front Panel Power LED Header	54
10. Front Panel Header	54
11. USB 2.0 Header Signal Names	55
12. Jumper Settings for the BIOS Setup Program Modes	59
13. Beep Codes	77
14. BIOS Error Messages	77
15. Safety Standards	79
16. Lead-Free Board Markings	84
17. EMC Regulations	85
18. Product Certification Markings	87

1 Desktop Board Features

This chapter briefly describes the features of Intel® Desktop Board DQ35MP. Table 1 summarizes the major features of the Desktop Board.

Table 1. Feature Summary

Form Factor	microATX (243.84 millimeters [9.60 inches] x 243.84 millimeters [9.60 inches])
Processor	Support for an Intel® processor in the LGA775 package
Main Memory	<ul style="list-style-type: none">• Four 240-pin, DDR2 1.8 V (only) SDRAM Dual Inline Memory Module (DIMM) sockets• 800/667 MHz single or dual channel DDR2 SDRAM interface• Support for up to 8 GB of system memory
Chipset	Intel® Q35 Express Chipset consisting of: <ul style="list-style-type: none">• Intel® Q35 Express Chipset Graphics and Memory Controller Hub (GMCH)• Intel® 82801IDO I/O Controller Hub (ICH9DO)
Graphics	<ul style="list-style-type: none">• Intel® Graphics Media Accelerator 3100 graphics controller• One PCI Express* x16 connector supporting PCI Express graphics cards
Audio	<ul style="list-style-type: none">• 4-channel (2 + 2) onboard audio subsystem featuring:<ul style="list-style-type: none">– Intel® High Definition Audio interface– RealTek* ALC268-GR audio codec• HD Audio Link header
LAN Support	Intel® 82566DM Gigabit (10/100/1000 Mb/s) Ethernet LAN controller
Expansion Capabilities	<ul style="list-style-type: none">• One PCI Express x16 connector• Two PCI Express x1 connectors• One PCI* connector
Legacy I/O Support	Legacy I/O Controller that provides one serial port via an onboard header
Peripheral Interfaces	<ul style="list-style-type: none">• Up to 12 USB 2.0 ports<ul style="list-style-type: none">– Six ports routed to the back panel– Six ports routed to three USB headers• Six Serial ATA (SATA) channels (3.0 Gb/s), via the ICH9DO, including one external SATA (eSATA) channel• One IDE interface with ATA-66/100 support for two devices

continued

Table 1. Feature Summary (continued)

Trusted Platform Module (TPM), revision 1.2	One TPM 1.2 device to enhance platform security
BIOS	<ul style="list-style-type: none"> • Intel® Platform Innovation Framework for extensible firmware interface • 32 Mbit symmetrical flash memory device • Support for SMBIOS • Intel® Rapid BIOS Boot • Intel® Express BIOS Update
Power Management	<ul style="list-style-type: none"> • Support for Advanced Configuration and Power Interface (ACPI) • Suspend to RAM (STR) • Wake on USB, PCI Express, LAN, and front panel • ENERGY STAR* capable
Hardware Management	<p>Hardware monitor with:</p> <ul style="list-style-type: none"> • Intel® Quiet System Technology fan speed control • Three fan sensing inputs used to monitor fan activity • Voltage sensing to detect out of range values
Intel® Active Management Technology (Intel® AMT)	Intel® AMT Specification 3.0 provides IT organizations tamper-resistant and persistent management capabilities

Related Links:

For more information about Desktop Board DQ35MP, including the Technical Product Specification (TPS), BIOS updates, and device drivers, go to:

<http://support.intel.com/support/motherboards/desktop/>

Supported Operating Systems

The Desktop Board supports the following operating systems:

- Microsoft Windows Vista* Ultimate
- Microsoft Windows Vista Enterprise
- Microsoft Windows Vista Business
- Microsoft Windows Vista Home Premium
- Microsoft Windows Vista Home Basic
- Microsoft Windows Vista Ultimate 64-bit edition
- Microsoft Windows Vista Enterprise 64-bit edition
- Microsoft Windows Vista Business 64-bit edition
- Microsoft Windows Vista Home Premium 64-bit edition
- Microsoft Windows Vista Home Basic 64-bit edition
- Microsoft Windows* XP Media Center Edition 2005
- Microsoft Windows XP Professional
- Microsoft Windows XP Professional x64 Edition
- Microsoft Windows XP Home

Desktop Board Components

Figure 1 shows the approximate location of the major components on Desktop Board DQ35MP.

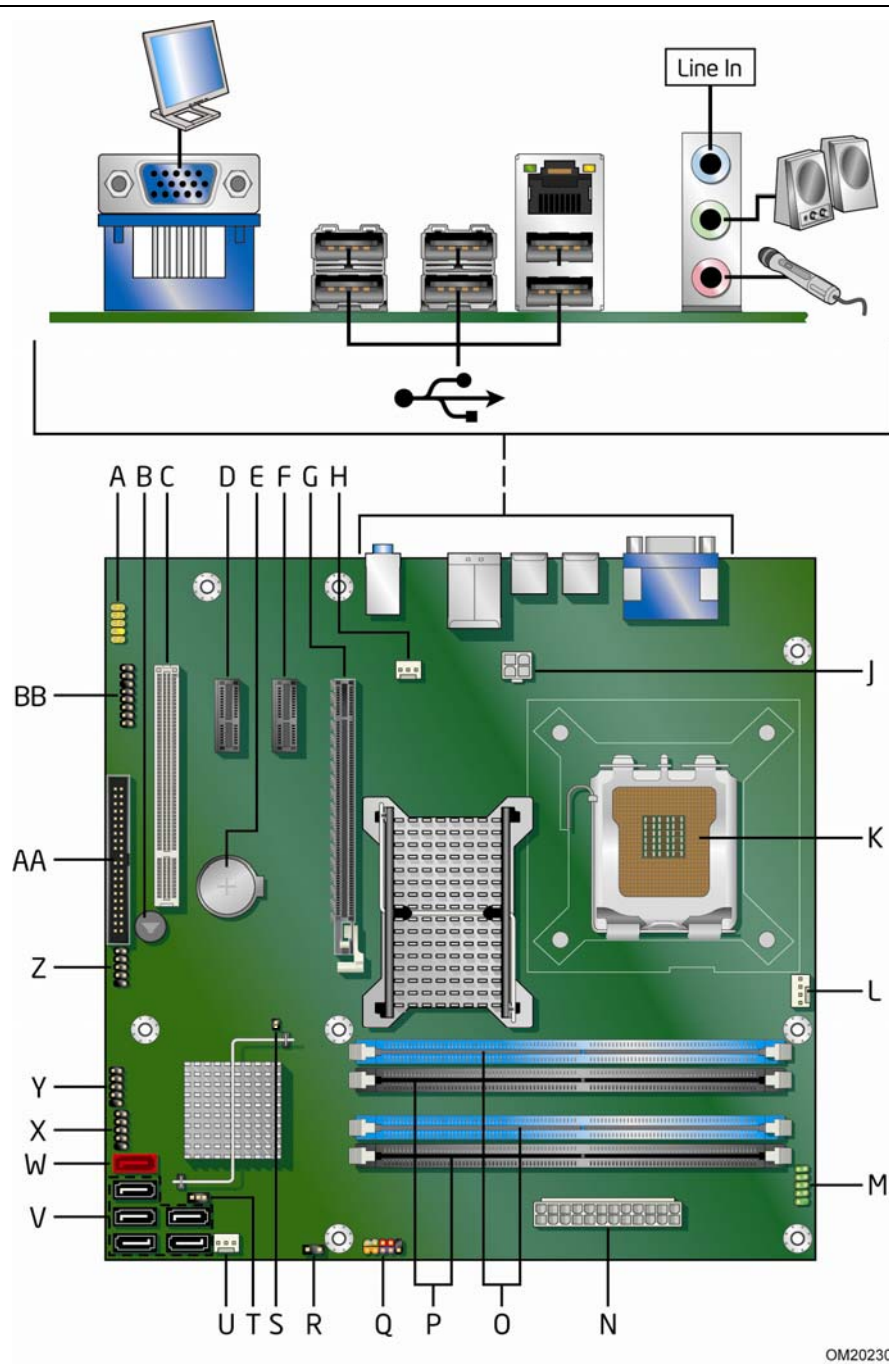

Figure 1. Desktop Board DQ35MP Components

Table 2. Desktop Board DQ35MP Components

Label	Description
A	Front panel audio header
B	Speaker
C	PCI bus connector
D	PCI Express x1 connector 2
E	Battery
F	PCI Express x1 connector 1
G	PCI Express x16 connector
H	Rear chassis fan header (3-pin)
I	Back panel connectors
J	12 V processor core voltage connector (2 x 2 pin)
K	Processor socket
L	Processor fan header (4-pin)
M	Serial header
N	Main power connector (2 x 12 pin)
O	DDR2 DIMM 0 sockets
P	DDR2 DIMM 1 sockets
Q	Front panel header
R	Alternate front panel power LED header
S	Chassis intrusion header
T	BIOS configuration jumper block
U	Front chassis fan header (3-pin)
V	Serial ATA connectors
W	External SATA (eSATA) connector
X	High-speed USB 2.0 header 2
Y	High-speed USB 2.0 header 3
Z	High-speed USB 2.0 header 1
AA	IDE connector
BB	High Definition Audio Link header

Processor



CAUTION

Failure to use an appropriate power supply and/or not connecting the 12 V (2 x 2 pin) power connector to the Desktop Board may result in damage to the board, or the system may not function properly.

Desktop Board DQ35MP supports an Intel processor in the LGA775 package. Processors are not included with the Desktop Board and must be purchased separately. The processor connects to the Desktop Board through the LGA775 socket.

Related Links:

Go to the following page or link for more information about:

- Instructions on installing or upgrading the processor, page 35 in Chapter 2
- Supported processors for Desktop Board DQ35MP, <http://www.intel.com/go/findCPU>

Main Memory



NOTE

To be fully compliant with all applicable Intel® SDRAM memory specifications, the board should be populated with DIMMs that support the Serial Presence Detect (SPD) data structure. If your memory modules do not support SPD, you will see a notification to this effect on the screen at power up. The BIOS will attempt to configure the memory controller for normal operation.

The Desktop Board supports the dual or single channel memory configurations defined below.

- Four 240-pin Double Data Rate 2 (DDR2) SDRAM Dual Inline Memory Module (DIMM) connectors with gold-plated contacts, 1.8 V only
- Support for:
 - Unbuffered, non-registered single or double-sided DIMMs
 - Non-ECC DDR2 memory
 - DIMM Type and Timings listed below:

Type	Timing
DDR2-800	5-5-5 or 6-6-6 only
DDR2-667	5-5-5 only
 - Serial Presence Detect (SPD) memory only
 - Memory configurations listed below:
 - Up to 2.0 GB utilizing 256 Mb technology
 - Up to 4.0 GB utilizing 512 Mb or 1 Gb technology
 - Up to 8.0 GB utilizing 1 Gb technology

Related Links:

Go to the following links or pages for more information about:

- SDRAM specifications, <http://www.intel.com/technology/memory/>
- Installing memory, page 40 in Chapter 2
- Tested memory, <http://www.cmtlabs.com/mbsearch.asp> or http://www.intel.com/products/motherboard/index.htm?iid=HMPAGE+Header_2_Product_MB
- *PC Serial Presence Detect Specification*, http://www.intel.com/technology/memory/ddr/specs/dda8c16_32x64ag_a.pdf

Intel® Q35 Express Chipset

The Intel Q35 Express Chipset consists of the following devices:

- Intel Q35 Express Chipset Graphics and Memory Controller Hub (GMCH) with Direct Media Interface (DMI)
- Intel 82801IDO I/O Controller Hub (ICH9DO) with DMI

The GMCH component provides interfaces to the processor, memory, PCI Express bus, and the DMI interconnect. The component also provides integrated graphics capabilities supporting 3D, 2D, and display capabilities.

ICH9DO is a centralized controller for the board's I/O paths.

Related Links:

Go to the following link for more information about the Intel Q35 Express Chipset:

<http://developer.intel.com/products/chipsets/index.htm>

Intel Q35 Graphics Subsystem

The Intel Q35 Express Chipset contains two separate, mutually exclusive graphics options. Either the integrated Intel® Graphics Media Accelerator 3100 (Intel® GMA 3100) graphics controller is used or a PCI Express x16 add-in card can be used. When a PCI Express x16 add-in card is installed, the Intel GMA 3100 graphics controller is disabled.

Intel® GMA 3100 Graphics Controller

The Intel GMA 3100 graphics controller features the following:

- 400 MHz core frequency
- High quality texture engine:
 - DX9.0c* and OpenGL* 1.4 compliant
 - Hardware Pixel Shader 2.0
 - Vertex Shader Model 2.0
- 3D Graphics Rendering enhancements:
 - 1.6 dual texture GigaPixel/s maximum fill rate
 - 16-bit and 32-bit color
 - Vertex cache
- Video
 - Software DVD at 30 fps full screen
 - Dynamic Video Memory Technology (DVMT) supports up to 287 MB
- Display
 - Up to 2048 x 1536 at 75 Hz refresh (QXGA)
 - DDC2B compliant interface with Advanced Digital Display 2 card or Media Expansion Card (ADD2/MEC), support for TV-out/TV-in and DVI digital display connections



NOTE

A minimum of 512 MB of system memory is required in order for the Intel GMA 3100 graphics controller to operate properly.

Audio Subsystem

The onboard audio subsystem consists of the following:

- Intel® ICH9DO I/O controller hub
- RealTek ALC268-GR audio codec
- Back panel audio connectors
- Onboard audio headers:
 - Intel High Definition Audio front panel header
 - HD Audio Link header

The audio subsystem supports the following features:

- A signal-to-noise (S/N) ratio of ≤ 95 dB playback quality and ≤ 90 dB recording quality
- Independent stereo audio playback from back panel connectors and the Intel High Definition Audio front panel header

Related Links:

Go to the following link or pages for more information about:

- Audio drivers and utilities <http://support.intel.com/support/motherboards/desktop/>
- Installing the front panel audio solution, page 52
- The location of audio connectors, Figure 24 on page 55

Legacy Input/Output (I/O) Controller

The I/O controller features the following:

- One serial port interface via an onboard header
- Low pin count (LPC) interface
- Serial IRQ interface compatible with serialized IRQ support for PCI systems
- Intelligent power management, including a programmable wake up event interface
- PCI power management support

LAN Subsystem

The LAN subsystem includes:

- Intel ICH9DO
- Intel 82566DM Gigabit (10/100/1000 Mb/s) Ethernet LAN controller with support for:
 - Intel AMT
 - Alert Standard Format (ASF) 2.0
 - Virtual LAN driver support for Intel® Virtualization Technology (Intel® VT) partitions
- RJ-45 LAN connector with integrated status LEDs

The subsystem also features:

- CSMA/CD protocol engine
- LAN connect interface between ICH9DO and the LAN controller
- PCI bus power management

Related Links:

Go to the following link for information about LAN software and drivers:

<http://support.intel.com/support/motherboards/desktop>

RJ-45 LAN Connector LEDs

Two LEDs are built into the RJ-45 LAN connector located on the back panel (see Figure 2). These LEDs indicate the status of the LAN.

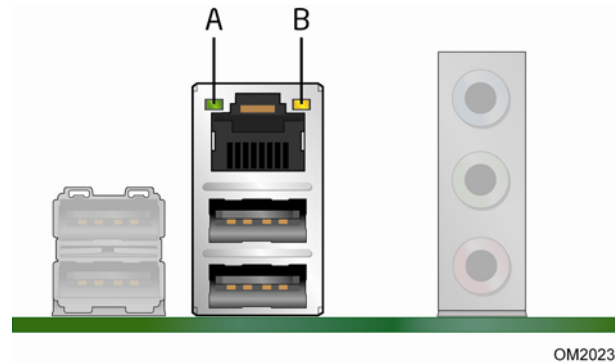

Figure 2. LAN Connector LEDs

Table 3 describes the LED states when the board is powered up and the LAN subsystem is operating.

Table 3. LAN Connector LEDs

LED	LED Color	LED State	Indicates
A	Green	Off	LAN link is not established
		On	LAN link is established
		Blinking	LAN activity is occurring
B	N/A	Off	10 Mb/s data rate
	Green	On	100 Mb/s data rate
	Yellow	On	1000 Mb/s data rate

Intel® Active Management Technology (Intel® AMT)

Intel AMT offers IT organizations tamper-resistant and persistent management capabilities. Intel AMT is a hardware-based solution that uses out of band communication to manage access to client systems in addition to offering encrypted and persistent asset management and remote diagnostics and/or recovery capabilities for networked platforms. With Intel AMT, IT organizations can easily get accurate platform information, and can perform remote updating, diagnostics, debugging and repair of a system, regardless of the state of the operating system or the power state of the system.

The Intel AMT subsystem consists of:

- ARC4 microcontroller embedded in the Intel Q35 Graphics and Memory Controller Hub (GMCH)
- ICH9DO (Intel® Management Engine function)
- Intel 82566DM Gigabit (10/100/1000 Mb/s) Ethernet LAN controller
- Channel A DIMM(s)
- BIOS/SPI Flash
- On-board Intel AMT status indicator



NOTE

Software with Intel AMT capability is required to take advantage of the Intel AMT platform management capabilities.

Related Links:

Go to the following link for information about Intel AMT and the availability of third-party software: <http://www.intel.com/go/iamt>

Intel AMT Status Indicator

The Intel AMT status indicator (red LED) shows the current state of the Intel Management Engine. Table 4 shows the states of the Intel Management Engine as indicated by the LED. Figure 3 shows the location of the Intel AMT status indicator.

Table 4. Intel AMT Status Indicator

LED State	Indicates
Off	Intel Management Engine is in the off state
On	Intel Management Engine is in the on state and fully functional
Blinking	Intel Management Engine is in the M1 state; system is out of band; Intel Management Engine is functional

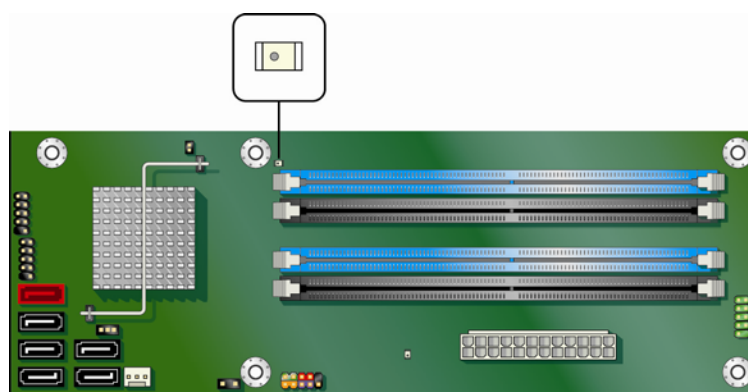

OM20258

Figure 3. Intel AMT Status Indicator

Hi-Speed USB 2.0 Support

The Desktop Board supports up to 12 USB 2.0 ports (six ports routed to the back panel and six ports routed to three internal headers) via ICH9DO. USB 2.0 ports are backward compatible with USB 1.1 devices. USB 1.1 devices will function normally at USB 1.1 speeds.

USB 2.0 support requires both an operating system and drivers that fully support USB 2.0 transfer rates. Disabling Hi-Speed USB in the BIOS reverts all USB 2.0 ports to USB 1.1 operation. This may be required to accommodate operating systems that do not support USB 2.0.

Enhanced IDE Interface

The board's IDE interface handles the exchange of information between the processor and peripheral devices such as hard disk drives and CD-ROM drives. The interface supports:

- Up to two IDE devices (such as hard drives)
- ATAPI-style devices (such as CD-ROM drives)
- Older PIO Mode devices
- Ultra DMA-33 and ATA-66/100 protocols

Serial ATA

The Desktop Board supports six Serial ATA channels (3.0 Gb/s) via ICH9DO, connecting one device per channel. One channel is configured as an eSATA channel.

Serial ATA RAID

The ICH9DO supports the following RAID (Redundant Array of Independent Drives) levels:

- RAID 0 - data striping
- RAID 1 - data mirroring
- RAID 0+1 (or RAID 10) - data striping and mirroring
- RAID 5 - distributed parity

For information on configuring your system for RAID using Intel® Matrix Storage Technology see Chapter 4.

Intel® Rapid Recover Technology

Intel Rapid Recover Technology enables fast and easy recovery of your data in the event of a hard drive failure. It allows you to maintain a complete copy of your primary or master drive onto a second hard drive, the recovery drive. If the master hard drive should fail, either from a mechanical failure or the result of a virus, recovery is as simple as booting from the recovery drive. The recovery drive can be attached to your system via any standard SATA or eSATA connection.

Intel Rapid Recover Technology also provides the added benefit of allowing the recovery drive to be mounted as a read-only volume so you can quickly copy files from the recovery drive when individual files need to be recovered.

For information on configuring your system for Intel Rapid Recover Technology see Chapter 5.

Expandability

For system expansion, the Desktop Board provides the following expansion slots:

- Two PCI Express x1 connectors
- One PCI Express x16 connector
- One PCI bus connector

BIOS

The BIOS provides the Power-On Self-Test (POST), the BIOS Setup program, the PCI/PCI Express and IDE auto-configuration utilities, and the video BIOS. The BIOS is stored in the Serial Peripheral Interface (SPI) Flash.

The BIOS can be updated by following the instructions on page 67 in Chapter 3.

Serial ATA and IDE Auto Configuration

If you install a Serial ATA or IDE device (such as a hard drive) in your computer, the auto-configuration utility in the BIOS automatically detects and configures the device for your computer. You do not need to run the BIOS Setup program after installing a Serial ATA or IDE device. You can override the auto-configuration options by specifying manual configuration in the BIOS Setup program.

PCI* and PCI Express* Auto Configuration

If you install a PCI/PCI Express add-in card in your computer, the PCI/PCI Express auto-configuration utility in the BIOS automatically detects and configures the resources (IRQs, DMA channels, and I/O space) for that add-in card. You do not need to run the BIOS Setup program after you install a PCI/PCI Express add-in card.

Security Passwords

The BIOS includes security features that restrict whether the BIOS Setup program can be accessed and who can boot the computer. A supervisor password and a user password can be set for the BIOS Setup and for booting the computer, with the following restrictions:

- The supervisor password gives unrestricted access to view and change all Setup options. If only the supervisor password is set, pressing <Enter> at the password prompt of Setup gives the user restricted access to Setup.
- If both the supervisor and user passwords are set, you must enter either the supervisor password or the user password to access Setup. Setup options are then available for viewing and changing depending on whether the supervisor or user password was entered.
- Setting a user password restricts who can boot the computer. The password prompt is displayed before the computer is booted. If only the supervisor password is set, the computer boots without asking for a password. If both passwords are set, you can enter either password to boot the computer.

For instructions on resetting the password, see Clearing BIOS Security Passwords on page 60.

Hard Disk Drive Passwords

The hard disk drive password security feature will lock a particular drive from read or write accesses until the hard disk drive password is entered at the startup prompt. Passwords are set in BIOS Setup under the "Security" heading, but do not interact with other system passwords.

There are two levels of hard disk drive passwords: Master and User. Both the Master and User hard disk drive passwords can be used to unlock a locked drive. Valid passwords are between two and eight characters.

The passwords function as follows:

- The User hard disk drive password will lock the drive and block read and write accesses to a hard disk upon each power cycle or reset.
- The Master hard disk drive password by itself will not lock the drive, but instead acts as an unlock override in the event that the User hard disk drive password is unavailable. Only the installation of the User hard disk drive password will cause a hard disk to be locked upon a system power cycle or reset.

For convenient support of S3 resume, the system BIOS will automatically unlock drives on resume from S3 and will not prompt for a hard disk drive password.



NOTE

The BIOS hard disk drive password security feature can only be used on ATA hard disks that support the ATA Security Mode feature set. It supports Serial ATA hard disk drives in IDE, AHCI, and RAID modes.

For instructions on resetting the password, see Clearing or Changing Hard Disk Drive Passwords on page 61.

Hard Disk Drive Password Feature During BIOS POST

During every BIOS POST execution, if a User hard disk drive password is present on the hard drive, POST execution will pause to prompt the user to enter the Master or User password:

```
Enter Hard Disk Drive Password:
```

Upon successful entry of the Master or User hard disk drive password, the system will continue with normal POST.

If the hard disk drive password is not correctly entered, the system will go back to the above prompt. The user will have three attempts to correctly enter the correct hard disk drive password. After the third unsuccessful attempt, the system will halt with the following message:

```
Hard Disk Drive Password Entry Error
```

The BIOS will then lock the drive from further activity, requiring a power-cycle to re-attempt hard disk drive password entry.

Trusted Platform Module (TPM)

The TPM 1.2 device is designed to enhance platform security above and beyond the capabilities of today's software by providing a protected space for key operations and other security critical tasks. Using both hardware and software, the TPM protects encryption and signature keys at their most vulnerable stages—operations when the keys are being used unencrypted in plain-text form. The TPM is specifically designed to shield unencrypted keys and platform authentication information from software-based attacks.

For information about enabling and activating the TPM, refer to the *Trusted Platform Module (TPM) Quick Reference Guide*.

Hardware Management Features

The hardware management features of Desktop Board DQ35MP enable the board to be compatible with the Wired for Management (WfM) specification. The board has several hardware management features including the following:

- Fan speed monitoring and control
- Thermal and voltage monitoring
- Chassis intrusion detection

Hardware Monitoring and Fan Speed Control

The features of the hardware monitoring and fan speed control include:

- Monitoring of power supply voltages to detect levels above and below acceptable values
- Intel Quiet System Technology fan speed control, delivering acoustically-optimized thermal management



NOTE

Memory must be installed in the Channel A, DIMM 0 socket to enable Intel Quiet System Technology.

- Fan speed controllers and sensors integrated into the ICH9DO
- Thermal sensors in the processor, GMCH, and ICH9DO, plus an onboard remote sensor



NOTE

The minimum thermal reporting threshold for the GMCH is 66 °C. The GMCH thermal sensor will display 66 °C until its temperature rises above this point.

- Thermally monitored closed-loop fan control, for all onboard fans, that can adjust fan speed or switch the fans off as needed

Chassis Intrusion

The board supports a chassis security feature that detects if the chassis cover has been removed. The security feature uses a mechanical switch on the chassis that can be connected to the chassis intrusion header on the Desktop Board. See Figure 23 on page 51 for the location of the chassis intrusion header.

Power Management Features

Power management is implemented at several levels, including:

- Software support through the Advanced Configuration and Power Interface (ACPI)
- Hardware support:
 - Power connectors
 - Fan headers
 - LAN wake capabilities
 - Instantly Available PC technology (Suspend to RAM)
 - +5 V standby power indicator
 - Wake from USB
 - Power Management Event signal (PME#) wakeup support
 - WAKE# signal wake-up support
- ENERGY STAR capable

ACPI

ACPI gives the operating system direct control over the power management and Plug and Play functions of a computer. The use of ACPI with the Desktop Board requires an operating system that provides full ACPI support.

Hardware Support

Power Connectors

ATX12V-compliant power supplies can turn off the computer power through system control. When an ACPI-enabled computer receives the correct command, the power supply removes all non-standby voltages.

When resuming from an AC power failure, the computer returns to the power state it was in before power was interrupted (either on or off). The computer's response can be set by using the Last Power State feature in the BIOS Setup program's Boot menu.

The Desktop Board has two power connectors. See Figure 26 on page 57 for the location of the power connectors.

Fan Headers

The function/operation of the fans is as follows:

- The fans are on when the computer is in the ACPI S0 state.
- The fans are off when the computer is in the ACPI S3, S4, or S5 state.
- Each fan header is wired to a tachometer input of the hardware monitoring and control device.
- All fan headers support closed-loop fan control that can adjust the fan speed or switch the fan on or off as needed.
- All fan headers have a +12 V DC connection.

The Desktop Board has a 4-pin processor fan header and two 3-pin chassis fan headers.

LAN Wake Capabilities



CAUTION

For LAN wake capabilities, the 5 V standby line for the power supply must be capable of delivering adequate +5 V standby current. Failure to provide adequate standby current when using this feature can damage the power supply.

LAN wake capabilities enable remote wake-up of the computer through a network. The LAN subsystem PCI bus network adapter monitors network traffic at the Media Independent Interface. Upon detecting a Magic Packet* frame, the LAN subsystem asserts a wake-up signal that powers up the computer. Depending on the LAN implementation, the board supports LAN wake capabilities with ACPI in the following ways:

- The PCI Express WAKE# signal
- The PCI bus PME# signal for PCI 2.3 compliant LAN designs
- By Ping
- Magic Packet
- The onboard LAN subsystem

Desktop Board DQ35MP supports waking the Intel Management Engine over the network. This can be enabled in the BIOS and allows Intel AMT to be remotely turned on through a wake packet generated by a management console application or a ping. The client system will be in a low power state until a management console alert requests Intel AMT functionality.

Instantly Available PC Technology



CAUTIONS

For Instantly Available PC technology, the 5 V standby line for the power supply must be capable of delivering adequate +5 V standby current. Failure to provide adequate standby current when using this feature can damage the power supply and/or effect ACPI S3 sleep state functionality.

Power supplies used with this Desktop Board must be able to provide enough standby current to support the standard Instantly Available (ACPI S3 sleep state) configuration. If the standby current necessary to support multiple wake events from the PCI and/or USB buses exceeds power supply capacity, the Desktop Board may lose register settings stored in memory.

Instantly Available PC technology enables the board to enter the ACPI S3 (Suspend-to-RAM) sleep state. While in the S3 sleep state, the computer will appear to be off. If the computer has a dual-colored power LED on the front panel, the sleep state is indicated by the LED turning amber. When signaled by a wake-up device or event, the computer quickly returns to its last known awake state.

The Desktop Board supports the *PCI Bus Power Management Interface Specification*. Add-in cards that support this specification can participate in power management and can be used to wake the computer.

+5 V Standby Power Indicator



CAUTION

If the AC power has been switched off and the standby power indicator is still lit, disconnect the power cord before installing or removing any devices connected to the board. Failure to do so could damage the board and any attached devices.

The Desktop Board's standby power indicator (green LED), shown in Figure 4, is lit when there is standby power still present on the board even when the computer appears to be off. For example, when this indicator is lit, standby power is still present at the memory module sockets and the PCI bus connectors.

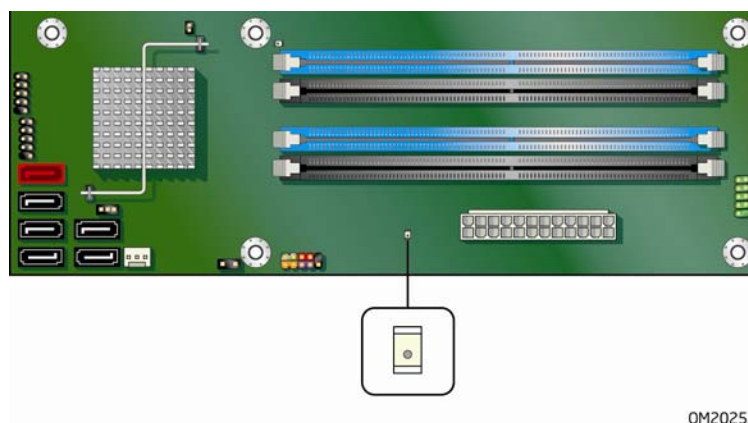

Figure 4. Standby Power Indicator

Related Links:

For more information on standby current requirements for the Desktop Board, refer to the Technical Product Specification by going to the following link, finding the product, and selecting Product Documentation from the left-hand menu:

<http://support.intel.com/support/motherboards/desktop/>

Wake from USB



NOTE

Wake from USB requires the use of a USB peripheral that supports Wake from USB.

USB bus activity wakes the computer from an ACPI S1 or S3 state.

PME# Signal Wake-up Support

When the PME# signal on the PCI bus is asserted, the computer wakes from an ACPI S1, S3, S4, or S5 state.

WAKE# Signal Wake-up Support

When the WAKE# signal on the PCI Express bus is asserted, the computer wakes from an ACPI S1, S3, S4, or S5 state.

ENERGY STAR* Capable

The US Department of Energy and the US Environmental Protection Agency have recently revised the ENERGY STAR requirements. Intel worked directly with these governmental agencies to define the new requirements. Currently, Intel Desktop Boards are capable of meeting the new ENERGY STAR requirements depending upon system configuration.

Related Links:

Go to the following link for information and recommendations concerning the new ENERGY STAR requirements: <http://www.intel.com/go/EnergyStar>

Speaker

A speaker is mounted on the Desktop Board. The speaker provides audible error code (beep code) information during the Power-On Self-Test (POST).

Battery

A battery on the Desktop Board keeps the values in CMOS RAM and the clock current when the computer is turned off. Go to page 61 for instructions on how to replace the battery.

Real-Time Clock

The Desktop Board has a time-of-day clock and 100-year calendar. The battery on the Desktop Board keeps the clock current when the computer is turned off.

2 Installing and Replacing Desktop Board Components

This chapter tells you how to:

- Install the I/O shield
- Install and remove the Desktop Board
- Install and remove a processor
- Install and remove memory
- Install and remove a PCI Express x16 card
- Connect the IDE and Serial ATA cables
- Connect to the internal headers
- Connect to the audio system
- Connect chassis fan and power supply cables
- Set the BIOS configuration jumper
- Clear passwords
- Replace the battery

Before You Begin



CAUTIONS

The procedures in this chapter assume familiarity with the general terminology associated with personal computers and with the safety practices and regulatory compliance required for using and modifying electronic equipment.

Disconnect the computer from its power source and from any telecommunications links, networks, or modems before performing any of the procedures described in this chapter. Failure to disconnect power, telecommunications links, networks, or modems before you open the computer or perform any procedures can result in personal injury or equipment damage. Some circuitry on the board can continue to operate even though the front panel power button is off.

Follow these guidelines before you begin:

- Always follow the steps in each procedure in the correct order.
- Set up a log to record information about your computer, such as model, serial numbers, installed options, and configuration information.
- Electrostatic discharge (ESD) can damage components. Perform the procedures described in this chapter only at an ESD workstation using an antistatic wrist strap and a conductive foam pad. If such a station is not available, you can provide some ESD protection by wearing an antistatic wrist strap and attaching it to a metal part of the computer chassis.

Installation Precautions

When you install and test the Intel Desktop Board, observe all warnings and cautions in the installation instructions.

To avoid injury, be careful of:

- Sharp pins on connectors
- Sharp pins on printed circuit assemblies
- Rough edges and sharp corners on the chassis
- Hot components (such as processors, voltage regulators, and heat sinks)
- Damage to wires that could cause a short circuit

Observe all warnings and cautions that instruct you to refer computer servicing to qualified technical personnel.

Prevent Power Supply Overload

Do not overload the power supply output. To avoid overloading the power supply, make sure that the calculated total current loads of all the modules within the computer is less than the output current rating of each of the power supplies output circuits.

Observe Safety and Regulatory Requirements

Read and adhere the instructions in this section and the instructions supplied with the chassis and associated modules. If you do not follow these instructions and the instructions provided by the chassis and module suppliers, you increase safety risk and the possibility of noncompliance with regional laws and regulations. If the instructions for the chassis are inconsistent with these instructions or the instructions for associated modules, contact the supplier's technical support to find out how you can ensure that your computer meets safety and regulatory requirements.

Related Links

For information about regulatory compliance, go to Appendix B on page 79.

Installing the I/O Shield

The Desktop Board comes with an I/O shield. When installed in the chassis, the shield blocks radio frequency transmissions, protects internal components from dust and foreign objects, and promotes correct airflow within the chassis.

Install the I/O shield before installing the Desktop Board in the chassis. Place the shield inside the chassis as shown in Figure 5. Press the shield into place so that it fits tightly and securely. If the shield does not fit, obtain a properly sized shield from the chassis supplier.

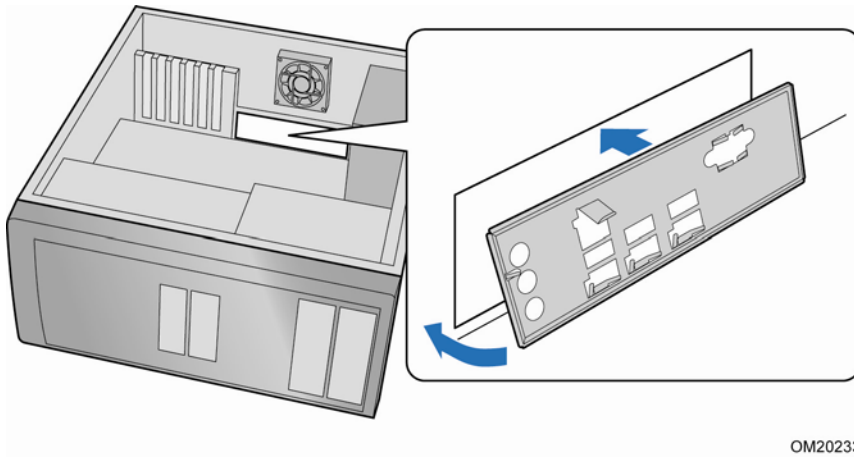

OM20233

Figure 5. Installing the I/O Shield

Installing and Removing the Desktop Board



CAUTION

Only qualified technical personnel should do this procedure. Disconnect the computer from its power source before performing the procedures described here. Failure to disconnect the power before you open the computer can result in personal injury or equipment damage.

Refer to your chassis manual for instructions on installing and removing the Desktop Board.

Figure 6 shows the location of the mounting screw holes for Desktop Board DQ35MP.

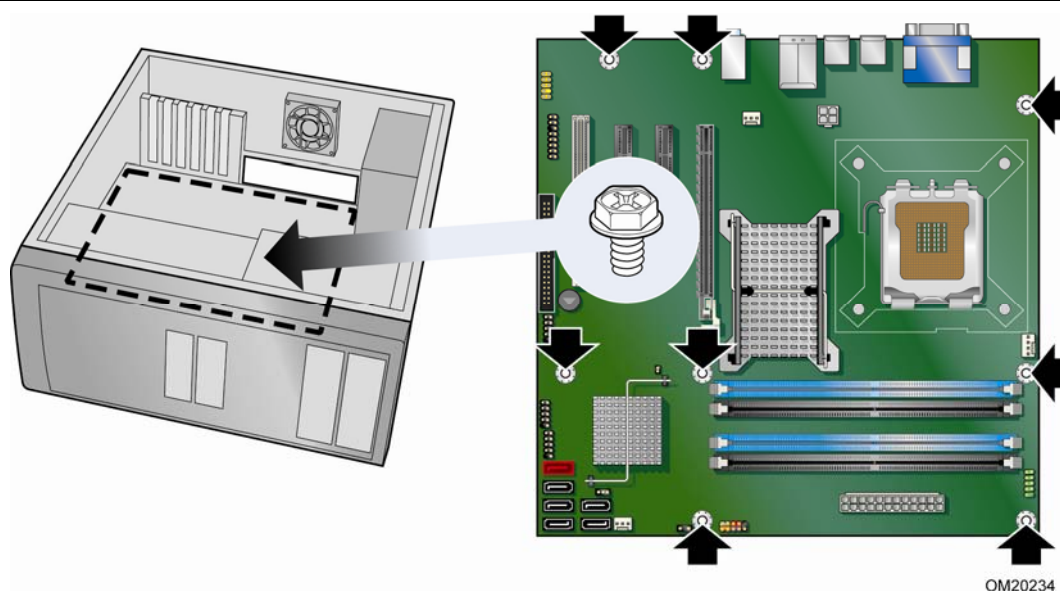

Figure 6. Desktop Board DQ35MP Mounting Screw Hole Locations

Installing and Removing a Processor

Instructions on how to install the processor to the Desktop Board are given below.

Installing a Processor



CAUTION

Before installing or removing the processor, make sure the AC power has been removed by unplugging the power cord from the computer; the standby power indicator should not be lit (see Figure 4 on page 28). Failure to do so could damage the processor and the board.

To install a processor, follow these instructions:

1. Observe the precautions in "Before You Begin" on page 31.
2. Open the socket lever by pushing the lever down and away from the socket (Figure 7, A and B).

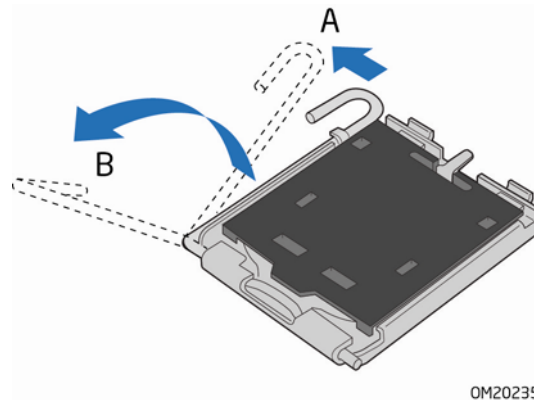

Figure 7. Lift the Socket Lever

3. Lift the load plate (Figure 8, A). Do not touch the socket contacts (Figure 8, B).

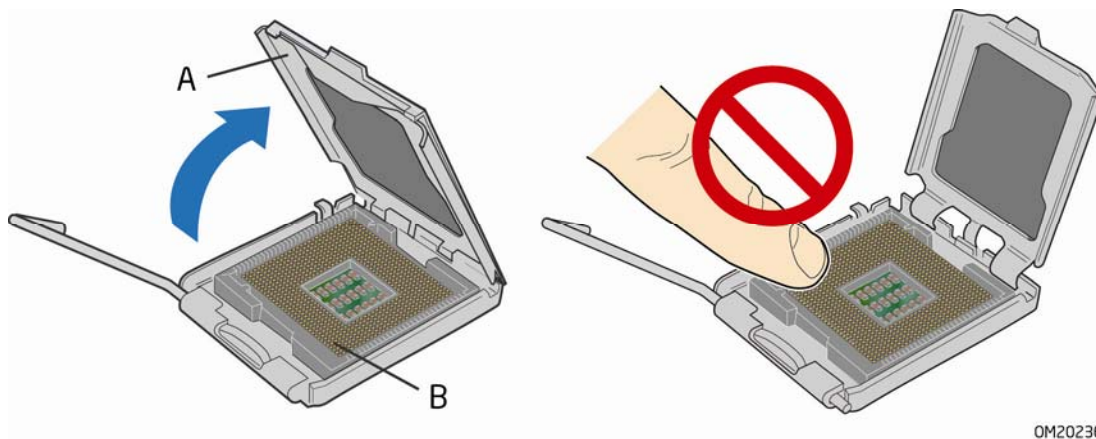

Figure 8. Lift the Load Plate

4. Remove the plastic protective socket cover from the load plate (Figure 9). Do not discard the protective socket cover. Always replace the socket cover if the processor is removed from the socket.

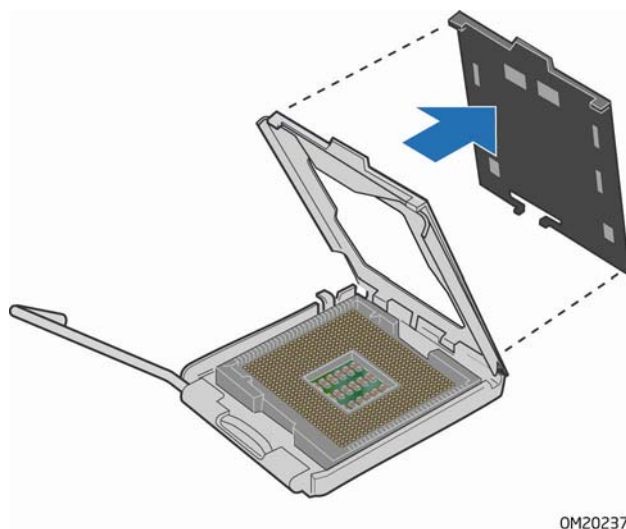

Figure 9. Remove the Protective Socket Cover

5. Remove the processor from the protective processor cover. Hold the processor only at the edges, being careful not to touch the bottom of the processor (see Figure 10). Do not discard the protective processor cover. Always replace the processor cover if the processor is removed from the socket.



OM20238

Figure 10. Remove the Processor from the Protective Processor Cover

6. Hold the processor with your thumb and index fingers oriented as shown in Figure 11. Make sure your fingers align to the socket cutouts (Figure 11, A). Align notches (Figure 11, B) with the socket (Figure 11, C). Lower the processor straight down without tilting or sliding it in the socket.

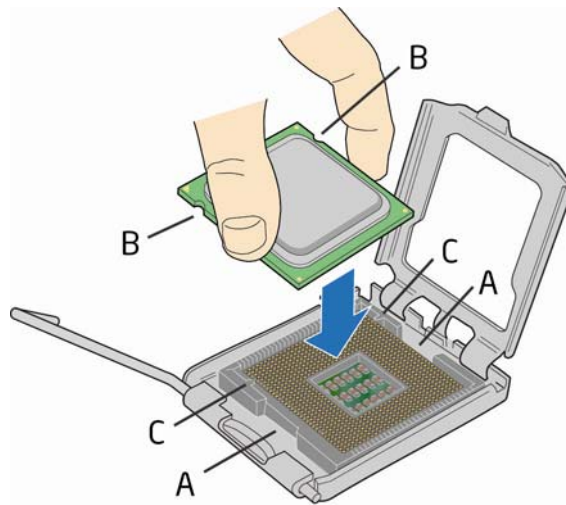

OM20239

Figure 11. Install the Processor

7. Pressing down on the load plate (Figure 12, A), close and engage the socket lever (Figure 12, B).

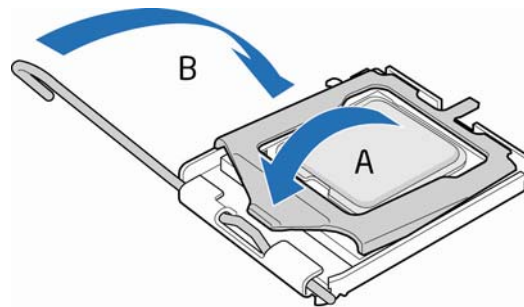

OM20240

Figure 12. Close the Load Plate

Installing the Processor Fan Heat Sink

Desktop Board DQ35MP has mounting holes for a processor fan heat sink. For instructions on how to attach the processor fan heat sink to the Desktop Board, refer to the boxed processor manual.

Connecting the Processor Fan Heat Sink Cable

Connect the processor fan heat sink cable to the 4-pin processor fan header (see Figure 13). A fan with a 4-pin connector as shown in Figure 13, A is recommended; however, a fan with a 3-pin connector (Figure 13, B) can be used. However, since the fan with a 3-pin connector cannot use the onboard fan control, the fan will always operate at full speed.

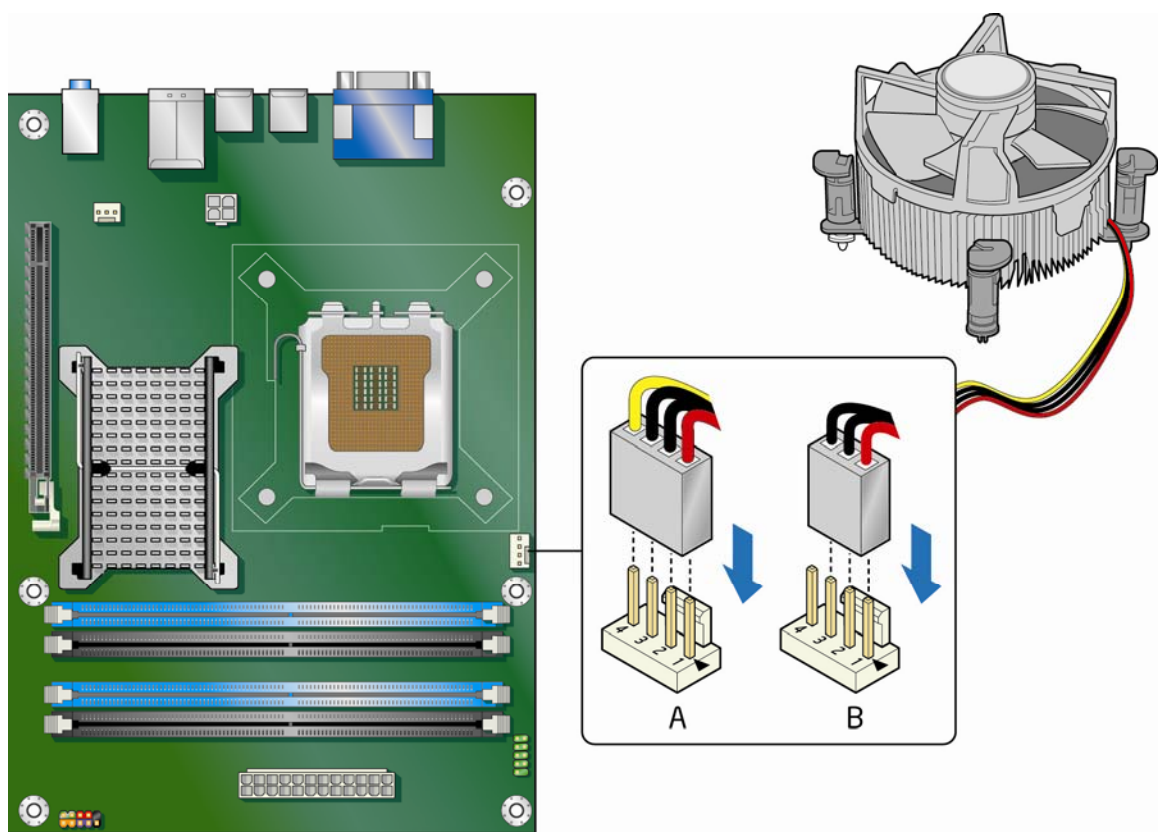

OM20253

Figure 13. Connecting the Processor Fan Heat Sink Cable to the Processor Fan Header

Removing the Processor

For instructions on how to remove the processor fan heat sink and processor, refer to the processor installation manual.

Installing and Removing Memory



NOTE

To be fully compliant with all applicable Intel SDRAM memory specifications, the board requires DIMMs that support the Serial Presence Detect (SPD) data structure.

Desktop board DQ35MP has four 240-pin DDR2 DIMM sockets arranged as DIMM 0 and DIMM 1 in both Channel A and Channel B.



NOTE

Regardless of the memory configuration used (dual or single channel), Channel A, DIMM 0 must always be populated. This is a requirement of the Intel Management Engine feature.

Guidelines for Dual Channel Memory Configuration

Before installing DIMMs, read and follow these guidelines for dual channel configuration.

Two or Four DIMMs

Install a matched pair of DIMMs equal in speed and size (see Figure 14) in DIMM 0 (blue) of channels A and B.

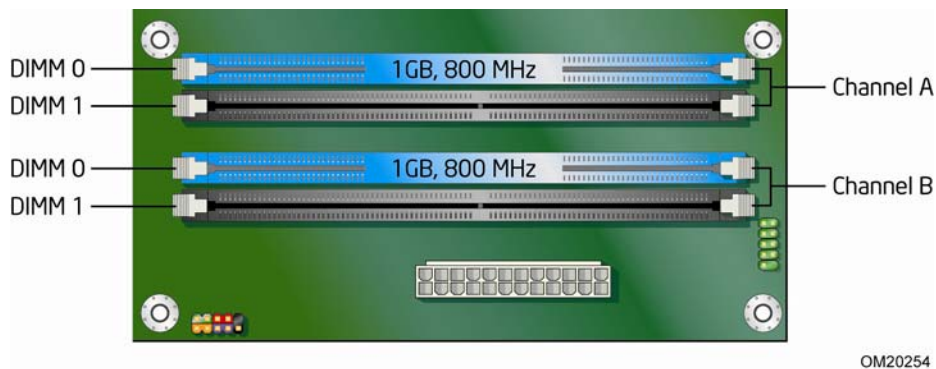

Figure 14. Dual Channel Memory Configuration with Two DIMMs

If additional memory is to be used, install another matched pair of DIMMs in DIMM 1 (black) in channels A and B (see Figure 15).

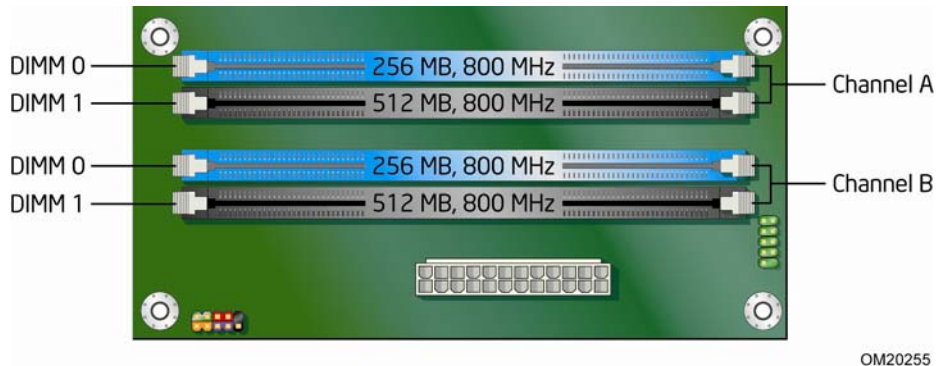

Figure 15. Dual Channel Memory Configuration with Four DIMMs

Three DIMMs

If you want to use three DIMMs in a dual-channel configuration, install a matched pair of DIMMs equal in speed and size in DIMM 0 (blue) and DIMM 1 (black) of channel A. Install a DIMM equal in speed and total size of the DIMMs installed in channel A in either DIMM 0 or DIMM 1 of channel B (see Figure 16).

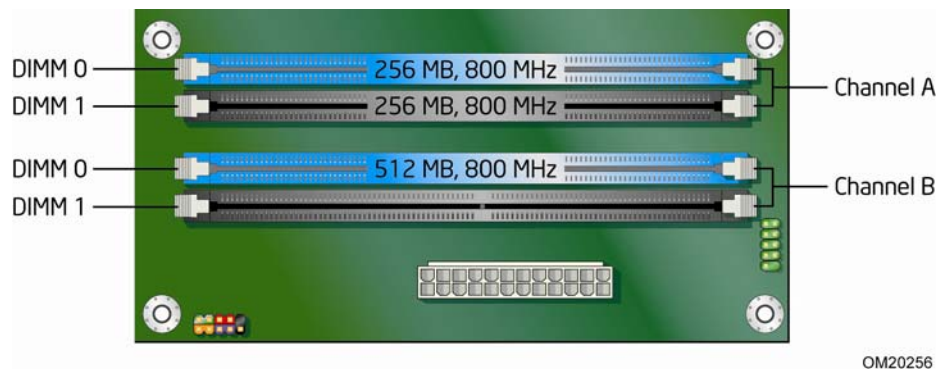

Figure 16. Dual Channel Memory Configuration with Three DIMMs



NOTE

All other memory configurations will result in single channel memory operation.

Installing DIMMs

To make sure you have the correct DIMM, place it on the illustration of the DDR2 DIMM in Figure 17. All the notches should match with the DDR2 DIMM.

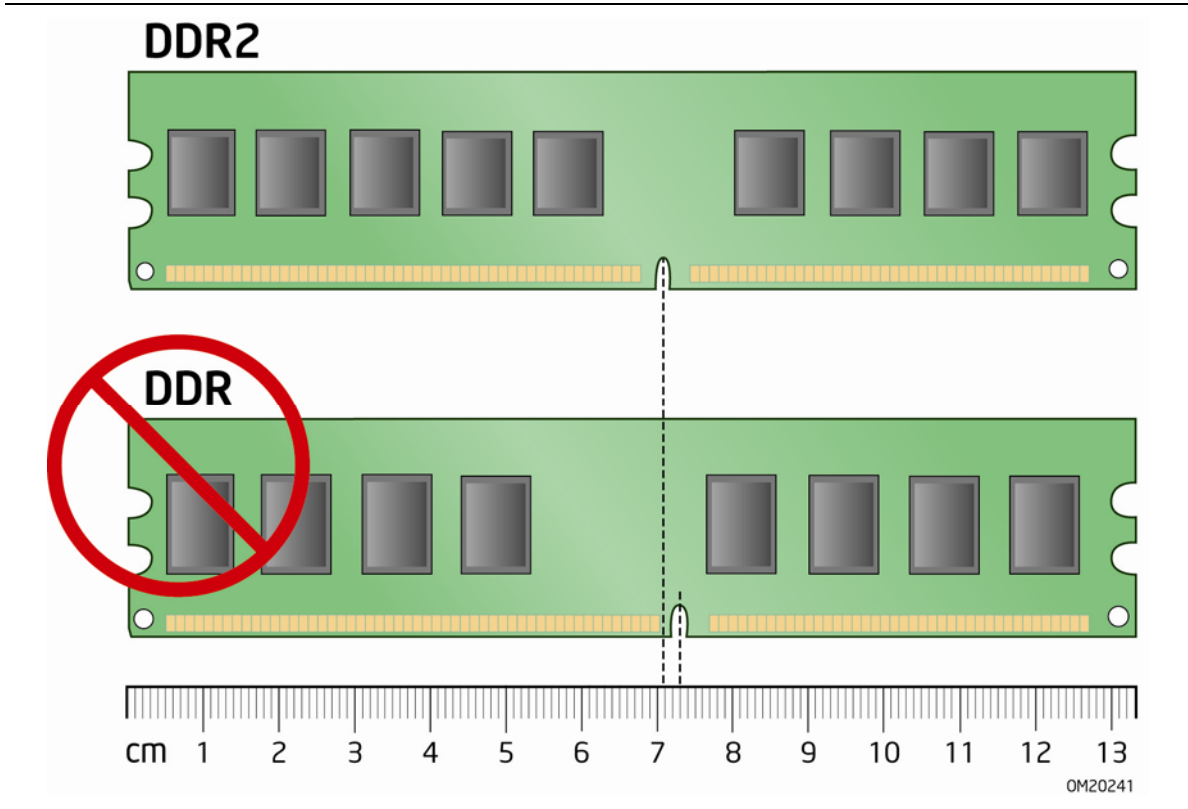

Figure 17. Use DDR2 DIMMs



NOTE

Memory must be installed in the Channel A, DIMM 0 socket to enable Intel Quiet System Technology.

To install a DIMM, follow these steps:

1. Observe the precautions in "Before You Begin" on page 31.
2. Turn off all peripheral devices connected to the computer. Turn off the computer and disconnect the AC power cord.
3. Remove the computer's cover and locate the DIMM sockets (see Figure 18).

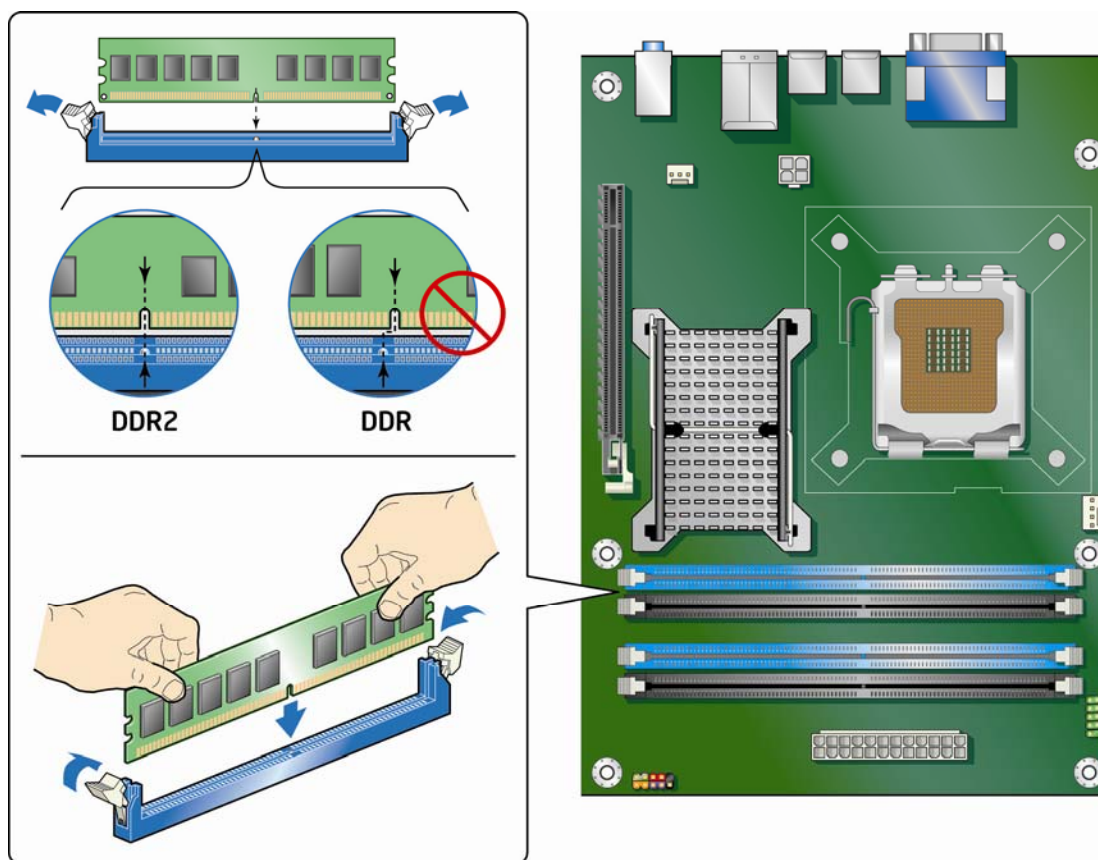

OM20242

Figure 18. Installing a DIMM

4. Make sure the clips at either end of the DIMM socket(s) are pushed outward to the open position.
5. Holding the DIMM by the edges, remove it from its anti-static package.
6. Position the DIMM above the socket. Align the small notch at the bottom edge of the DIMM with the keys in the socket (see inset in Figure 18).

7. Insert the bottom edge of the DIMM into the socket.
8. When the DIMM is inserted, push down on the top edge of the DIMM until the retaining clips snap into place. Make sure the clips are firmly in place.
9. Replace the computer's cover and reconnect the AC power cord.

Removing DIMMs

To remove a DIMM, follow these steps:

1. Observe the precautions in "Before You Begin" on page 31.
2. Turn off all peripheral devices connected to the computer. Turn off the computer.
3. Remove the AC power cord from the computer.
4. Remove the computer's cover.
5. Gently spread the retaining clips at each end of the DIMM socket. The DIMM pops out of the socket.
6. Hold the DIMM by the edges, lift it away from the socket, and store it in an anti-static package.
7. Reinstall and reconnect any parts you removed or disconnected to reach the DIMM sockets.
8. Replace the computer's cover and reconnect the AC power cord.

Installing and Removing a PCI Express x16 Card



CAUTION

When installing a PCI Express x16 card on the Desktop Board, ensure that the card is fully seated in the PCI Express x16 connector before you power on the system. If the card is not fully seated in the PCI Express connector, an electrical short may result across the PCI Express connector pins. Depending on the over-current protection of the power supply, certain Desktop Board components and/or traces may be damaged.

Installing a PCI Express x16 Card

1. Observe the precautions in "Before You Begin" on page 31.
2. Place the card in the PCI Express x16 connector (Figure 19, A) and press down on the card until it is completely seated in the connector and the card retention notch on the card snaps into place around the retention mechanism pin on the connector.
3. Secure the card's metal bracket to the chassis back panel with a screw (Figure 19, B).

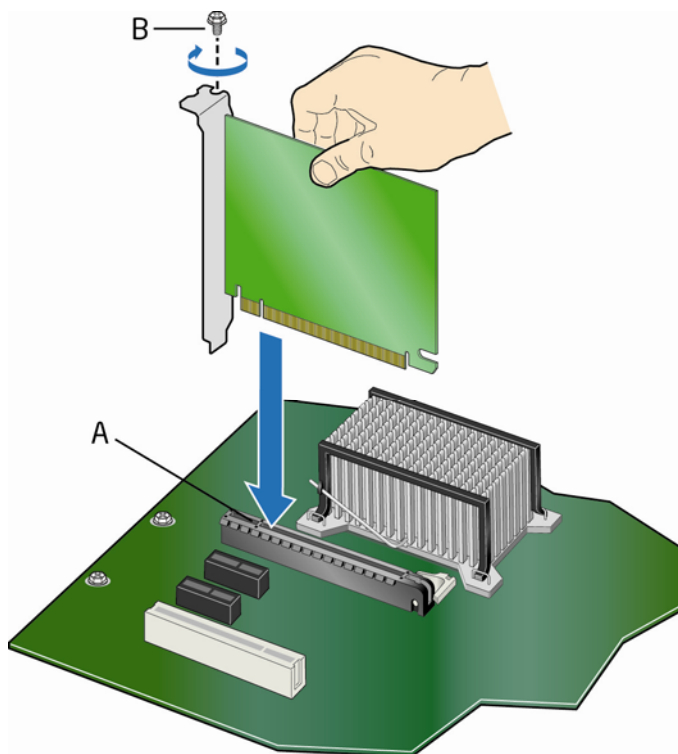

OM20243

Figure 19. Installing a PCI Express x16 Card

Removing the PCI Express x16 Card

Follow these instructions to remove the PCI Express x16 card from the connector:

1. Observe the precautions in "Before You Begin" on page 31.
2. Remove the screw (Figure 20, A) that secures the card's metal bracket to the chassis back panel.
3. Push the card ejector lever down using the tip of a pencil or similar tool (Figure 20, B) in the notch. This will release the card from the connector (C).
4. Pull the card straight up.

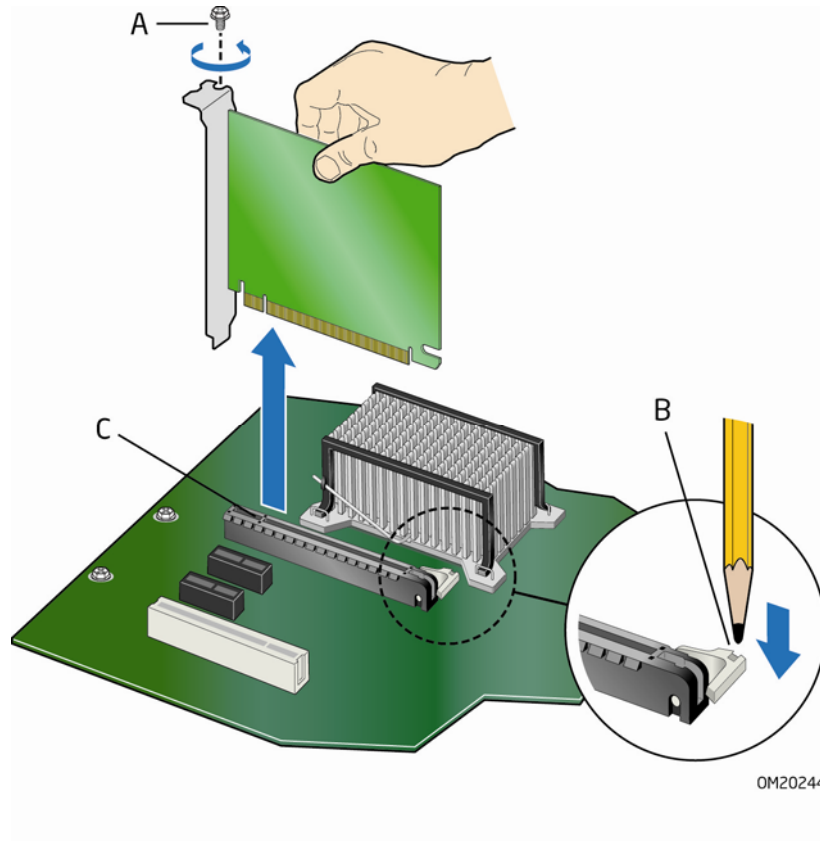

Figure 20. Removing a PCI Express x16 Card

Connecting the IDE Cable

The IDE cable can be used to connect two IDE drives to the Desktop Board. The cable supports the ATA-66/100 transfer protocol. Figure 21 shows the correct installation of the cable.



NOTES

ATA-66/100 compatible cables are backward compatible with drives using slower IDE transfer protocols. If an ATA-66/100 disk drive and a disk drive using any other IDE transfer protocol are attached to the same cable, the maximum transfer rate between the drives may be reduced to that of the slowest drive.

Do not connect an ATA device as a slave on the same IDE cable as an ATAPI master device. For example, do not connect an ATA hard drive as a slave to an ATAPI CD-ROM drive.

For correct function of the cable:

- Observe the precautions in "Before You Begin" on page 31.
- Attach the cable end with the single connector (blue) to the Intel Desktop Board (Figure 21, A).
- Attach the cable end with the two closely spaced connectors (gray and black) to the drives (Figure 21, B).

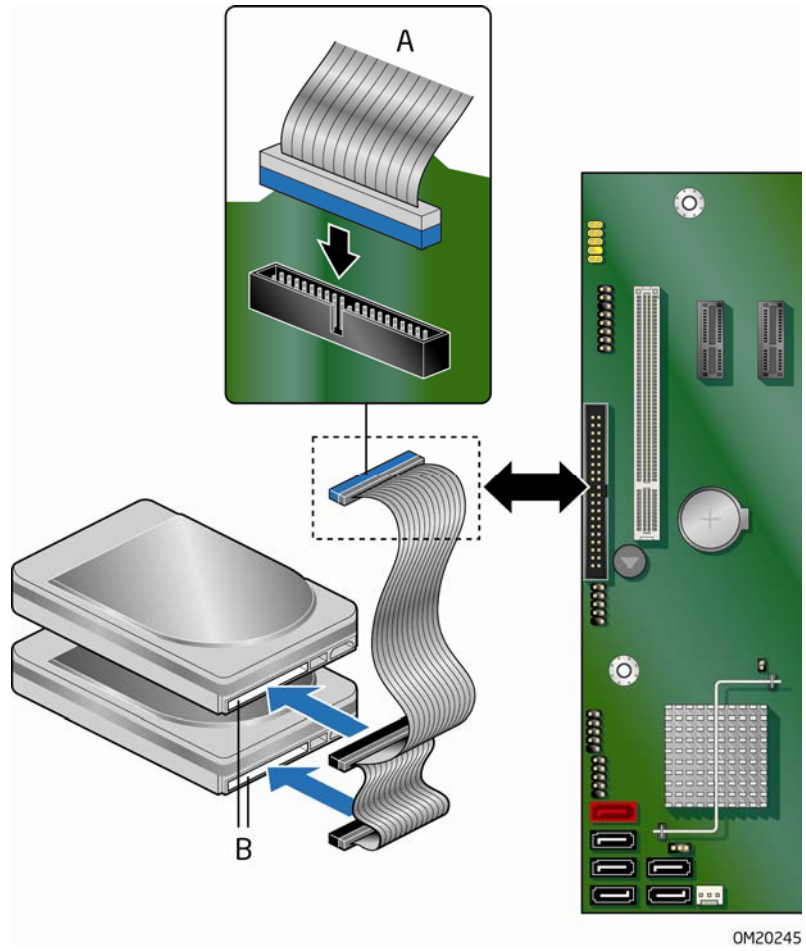

Figure 21. Connecting the IDE Cable

Connecting the Serial ATA (SATA) Cables

SATA cables support the Serial ATA protocol. Each cable can be used to connect a single internal SATA drive to the Desktop Board. For correct cable function:

1. Observe the precaution in "Before You Begin" on page 31.
2. Attach one end of the SATA cable to one of the black SATA connectors on the board (Figure 22, A) and attach the other end of the cable to the SATA drive (Figure 22, B).



NOTE

Do not attach an internal SATA drive to the red external SATA (eSATA) connector.

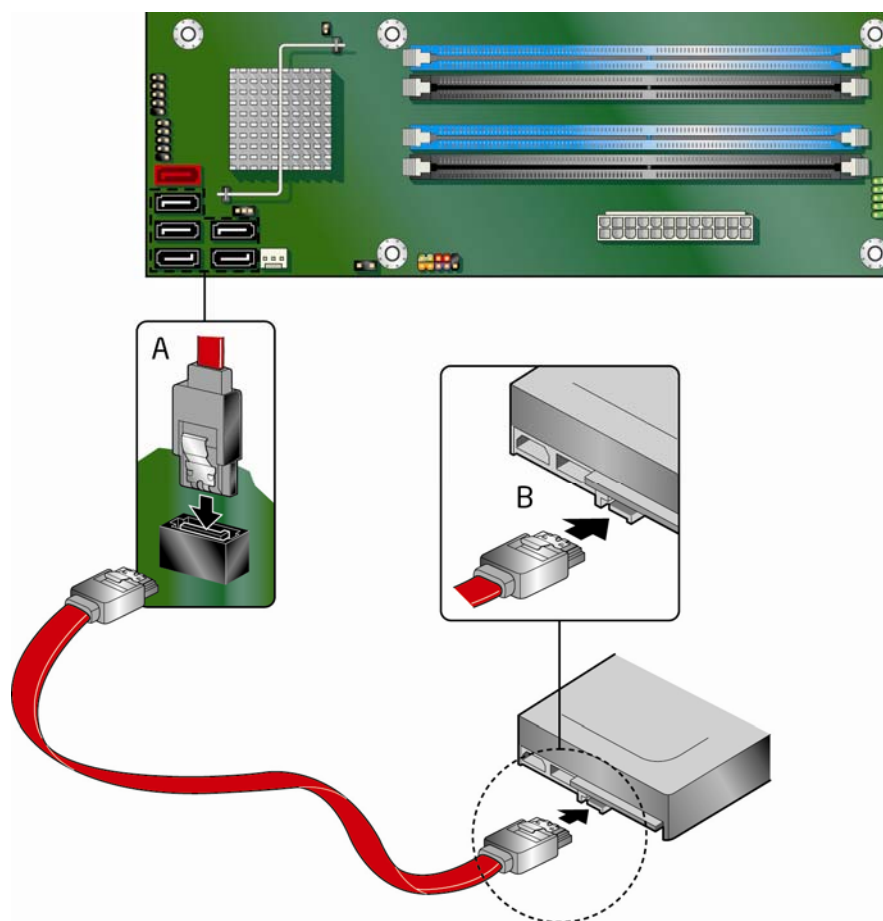

0M20246

Figure 22. Connecting a Serial ATA Cable

Connecting to the Internal Headers

Before connecting cables to the internal headers, observe the precautions in “Before You Begin” on page 31. Figure 23 shows the location of the internal headers.

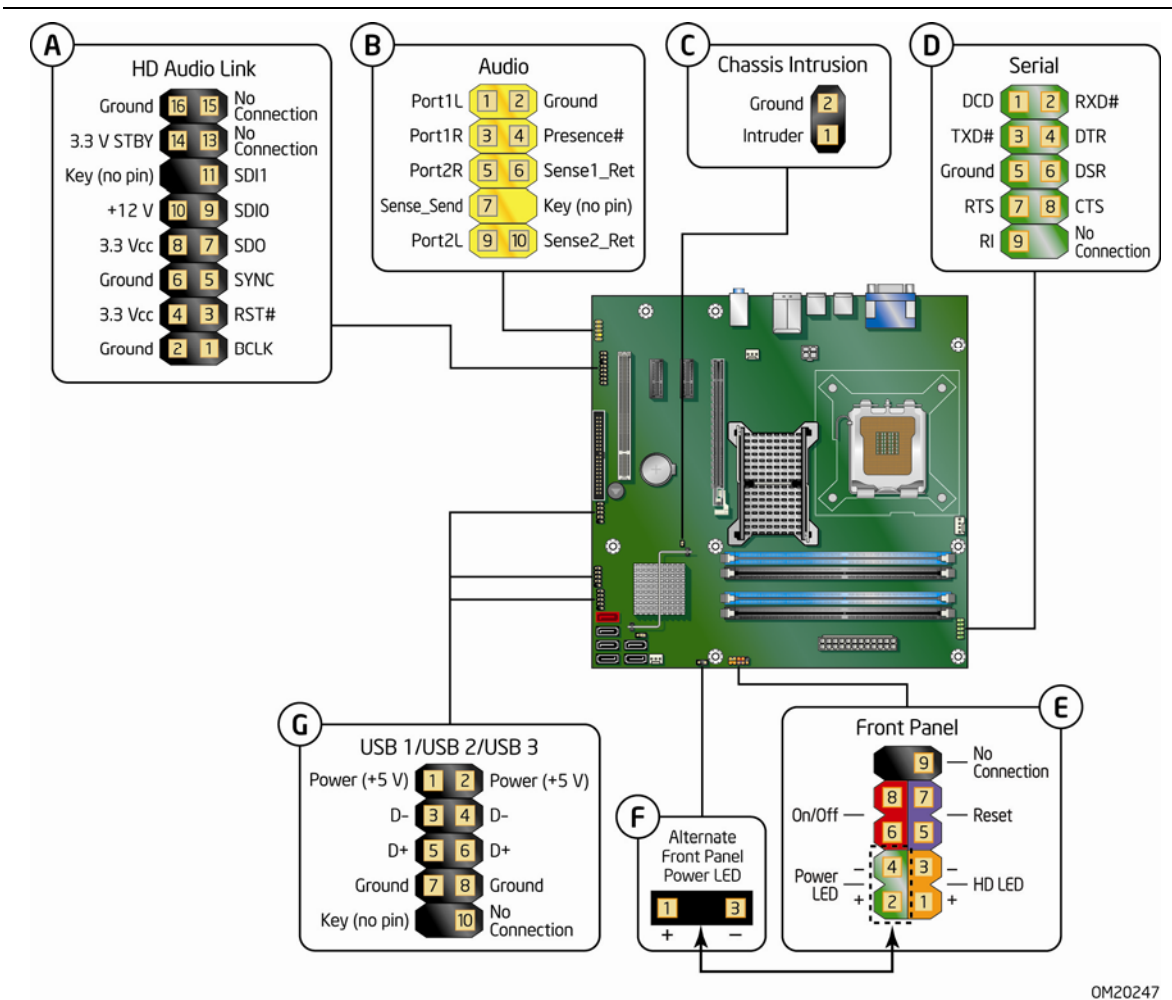

OM20247

Item	Description	Item	Description
A	HD Audio Link	E	Front Panel
B	Front Panel Audio	F	Alternate Front Panel Power LED
C	Chassis intrusion	G	USB 2.0 (3)
D	Serial Port		

Figure 23. Internal Headers

Connecting to the HD Audio Link Header

See Figure 23, A for the location of the HD Audio Link header. Table 5 shows the pin assignments for the header.

Table 5. HD Audio Link Header Signal Names

Pin	Signal Name	Pin	Signal Name
1	BCLK	2	Ground
3	RST#	4	3.3 Vcc
5	SYNC	6	Ground
7	SDO	8	3.3 Vcc
9	SDI0	10	+12 V
11	SDI1	12	Key
13	No Connection	14	3.3 V STBY
15	No Connection	16	Ground

Installing a Front Panel Audio Solution for Intel® High Definition Audio

Figure 23, B shows the location of the front panel audio header. Table 6 shows the pin assignments for the front panel audio header.

Table 6. Front Panel Intel High Definition Audio Header Signal Names

Pin	Signal Name	Pin	Signal Name
1	PORT 1L	2	GND
3	PORT 1R	4	PRESENCE#
5	PORT 2R	6	SENSE1_RETURN
7	SENSE_SEND	8	KEY (no pin)
9	PORT 2L	10	SENSE2_RETURN

To install the cable that connects the front panel audio solution to the front panel audio header, follow these steps:

1. Observe the precautions in "Before You Begin" on page 31.
2. Turn off all peripheral devices connected to the computer. Turn off the computer and disconnect the AC power cord.
3. Remove the cover.
4. Install a correctly keyed and shielded front panel audio cable.

Connecting to the Chassis Intrusion Header

Figure 23, C on page 51 shows the location of the chassis intrusion header. This header can be connected to a mechanical switch on the chassis to detect if the chassis cover is removed.

Table 7 shows the pin assignments for the chassis intrusion header.

Table 7. Chassis Intrusion Header

Pin	Description
1	Intruder
2	Ground

Connecting to the Serial Port Header

See Figure 23, D for the location of the serial port header. Table 8 shows the pin assignments for the header.

Table 8. Serial Port Header Signal Names

Pin	Signal Name	Pin	Signal Name
1	DCD	2	RXD#
3	TXD#	4	DTR
5	Ground	6	DSR
7	RTS	8	CTS
9	RI	10	No Connection

Connecting to the Alternate Front Panel Power LED Header

Figure 23, F on page 51 shows the location of the alternate front panel power LED header. Pins 1 and 3 of this header duplicate the signals on pins 2 and 4 of the front panel header. If your chassis has a three-pin power LED cable, connect it to this header.

Table 9 shows the pin assignments for the alternate front panel power LED header.

Table 9. Alternate Front Panel Power LED Header

Pin	Description	In/Out
1	Front panel green LED	Out
2	No pin	
3	Front panel yellow LED	Out

Connecting to the Front Panel Header

Before connecting to the front panel header, observe the precautions in "Before You Begin" on page 31. See Figure 23, E on page 51 for the location of the multi-colored front panel header.

Table 10 shows the pin assignments for the front panel header.

Table 10. Front Panel Header

Pin	Description	In/Out	Pin	Description	In/Out
Hard Drive Activity LED			Power LED		
1	Hard disk LED pull-up to +5 V	Out	2	Front panel green LED	Out
3	Hard disk active LED	Out	4	Front panel yellow LED	Out
Reset Switch			On/Off Switch		
5	Ground		6	Power switch	In
7	Reset switch	In	8	Ground	
Power			Not Connected		
9	Power	Out	10	No pin	

Connecting to the USB 2.0 Headers

Before connecting to the USB 2.0 headers, observe the precautions in "Before You Begin" on page 31. See Figure 23, G on page 51 for the location of the three USB 2.0 headers. Table 11 shows the pin assignments for each USB 2.0 header. Each USB header can be used to connect two USB devices.

Table 11. USB 2.0 Header Signal Names

USB Port A		USB Port B	
Pin	Signal Name	Pin	Signal Name
1	Power (+5 V)	2	Power (+5 V)
3	D-	4	D-
5	D+	6	D+
7	Ground	8	Ground
9	Key	10	No Connection

Note: USB ports may be assigned as needed.



NOTE

Computer systems that have an unshielded cable attached to a USB port might not meet FCC Class B requirements, even if no device or a low-speed USB device is attached to the cable. Use a shielded cable that meets the requirements for a full-speed USB device.

Connecting to the Audio System

After installing the RealTek audio driver from the Intel Express Installer DVD-ROM, the multi-channel audio feature can be enabled. Figure 24 shows the back panel audio connectors. The default connector assignments are shown in the table.

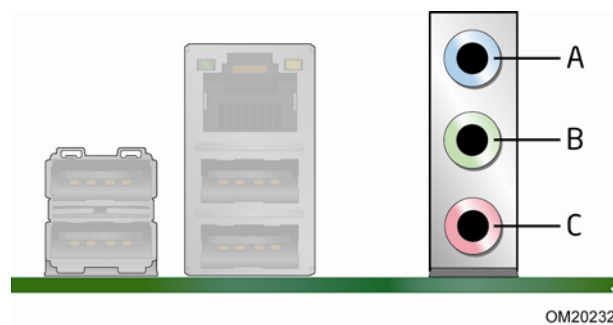

Item	Description
A	Audio line in
B	Audio line out
C	Mic in

Figure 24. Back Panel Audio Connectors



NOTE

The back panel audio line out connector is designed to power either headphones or amplified speakers only. Poor audio quality may occur if passive (non-amplified) speakers are connected to this output.

Connecting Chassis Fan and Power Supply Cables

Connecting Chassis Fan Cables

Connect chassis fan cables to the 3-pin chassis fan headers on the Desktop Board. Figure 25 shows the location of the chassis fan headers.

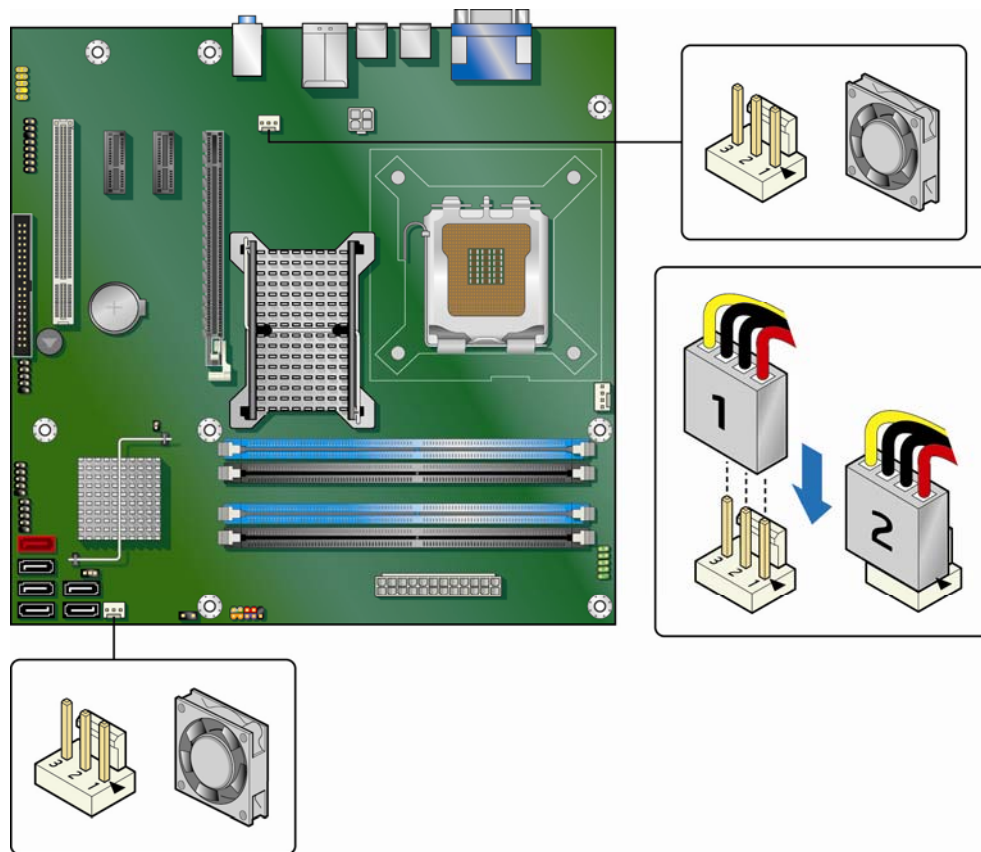

OM20248

Figure 25. Location of the Chassis Fan Headers

Connecting Supply Power Cables



CAUTION

Failure to use an appropriate power supply and/or not connecting the 12 V (2 x 2 pin) power connector to the Desktop Board may result in damage to the board or the system may not function properly.

The 2 x 12 pin main power connector on the Desktop Board is backwards compatible with ATX12V power supplies with 2 x 10 connectors. Figure 26 shows the location of the Desktop Board power connectors.

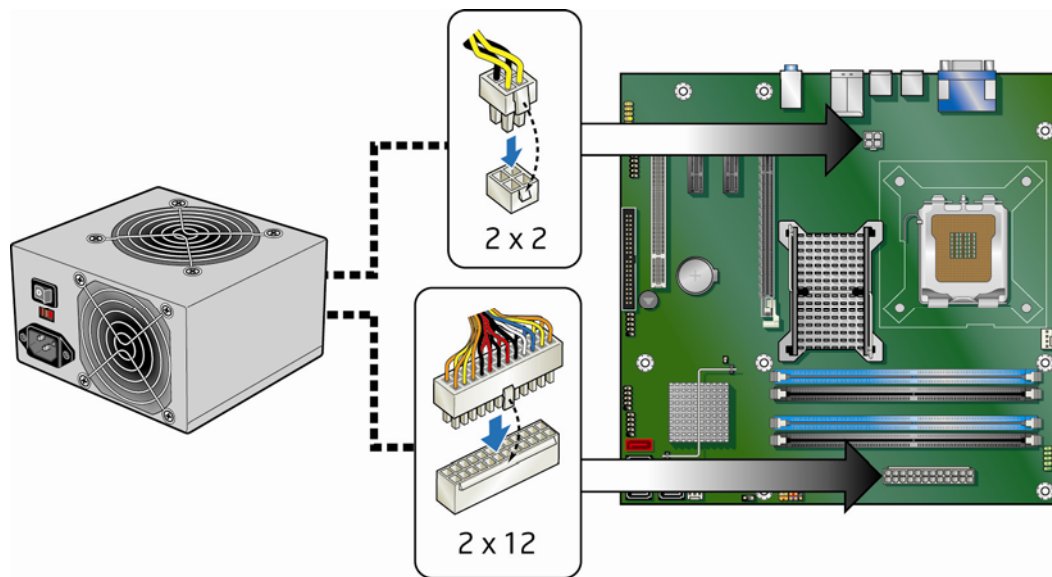

OM20249

Figure 26. Connecting Power Supply Cables

1. Observe the precautions in "Before You Begin" on page 31.
2. Connect the main power supply cable to the 2 x 12 pin connector.
3. Connect the 12 V processor core voltage power supply cable to the 2 x 2 pin connector.

Setting the BIOS Configuration Jumper



NOTE

Always turn off the power and unplug the power cord from the computer before moving the jumper. Moving the jumper with the power on may result in unreliable computer operation.

Figure 27 shows the location of the Desktop Board's BIOS configuration jumper block.

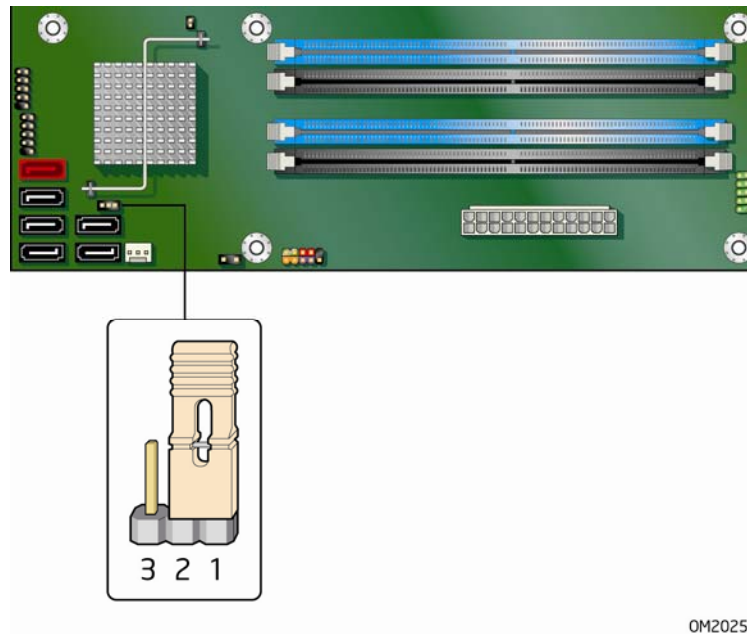



0M20250

Figure 27. Location of the BIOS Configuration Jumper Block

The three-pin BIOS jumper block enables all board configuration to be done in the BIOS Setup program. Table 12 shows the jumper settings for the BIOS Setup program modes.

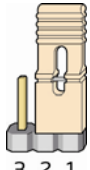
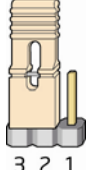
Table 12. Jumper Settings for the BIOS Setup Program Modes

Jumper Setting	Mode	Description
 <p>3 2 1</p>	Normal (default) (1-2)	The BIOS uses the current configuration and passwords for booting.
 <p>3 2 1</p>	Configure (2-3)	After the Power-On Self-Test (POST) runs, the BIOS displays the Maintenance Menu. Use this menu to clear passwords.
 <p>3 2 1</p>	Recovery (None)	The BIOS recovers data in the event of a failed BIOS update.

Clearing or Changing Passwords

This section describes how to clear or change the following passwords:

- BIOS security passwords (user and supervisor)
- Hard disk drive passwords (User and Master)

Clearing BIOS Security Passwords

This procedure assumes that the board is installed in the computer and the configuration jumper block is set to normal mode.

1. Observe the precautions in "Before You Begin" on page 31.
2. Turn off all peripheral devices connected to the computer. Turn off the computer. Disconnect the computer's power cord from the AC power source (wall outlet or power adapter).
3. Remove the computer cover.
4. Find the configuration jumper block (see Figure 27).
5. Place the jumper on pins 2-3 as shown below.

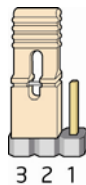

6. Replace the cover, plug in the computer, turn on the computer, and allow it to boot.
7. The computer starts the Setup program. Setup displays the Maintenance menu.
8. Use the arrow keys to select Clear Passwords. Press <Enter> and Setup displays a pop-up screen requesting that you confirm clearing the password. Select Yes and press <Enter>. Setup displays the maintenance menu again.
9. Press <F10> to save the current values and exit Setup.
10. Turn off the computer. Disconnect the computer's power cord from the AC power source.
11. Remove the computer cover.
12. To restore normal operation, place the jumper on pins 1-2 as shown below.

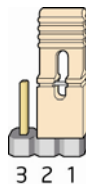

13. Replace the cover, plug in the computer, and turn on the computer.



NOTE

This method of clearing passwords will not clear User or Master hard disk drive passwords (see "Clearing or Changing Hard Disk Drive Passwords" below).

Clearing or Changing Hard Disk Drive Passwords

This section describes how to clear or change User and Master hard disk drive passwords. The procedures for clearing the passwords are as follows:

- **User Hard Disk Drive Passwords:**
If a valid User hard disk drive password has been entered and the user wishes to change or delete the password, the user must first enter the existing User hard disk drive password in BIOS Setup for security confirmation.
To delete an existing User hard disk drive password, the user can enter a blank password for the new password.
- **Master Hard Disk Drive Passwords:**
If a valid Master hard disk drive password has been entered and the user wishes to change or delete the password, the user must first enter the existing Master hard disk drive password in BIOS Setup for security confirmation.
To delete an existing Master hard disk drive password, the user can enter a blank password for the new password.

Replacing the Battery

A coin-cell battery (CR2032) powers the real-time clock and CMOS memory. When the computer is not plugged into a wall socket, the battery has an estimated life of three years. When the computer is plugged in, the standby current from the power supply extends the life of the battery. The clock is accurate to ± 13 minutes/year at 25 °C with 3.3 VSB applied.

When the voltage drops below a certain level, the BIOS Setup program settings stored in CMOS RAM (for example, the date and time) might not be accurate. Replace the battery with an equivalent one. Figure 28 on page 66 shows the location of the battery.



CAUTION

Risk of explosion if the battery is replaced with an incorrect type. Batteries should be recycled where possible. Disposal of used batteries must be in accordance with local environmental regulations.



PRECAUTION

Risque d'explosion si la pile usagée est remplacée par une pile de type incorrect. Les piles usagées doivent être recyclées dans la mesure du possible. La mise au rebut des piles usagées doit respecter les réglementations locales en vigueur en matière de protection de l'environnement.



FORHOLDSREGEL

Eksplussionsfare, hvis batteriet erstattes med et batteri af en forkert type. Batterier bør om muligt genbruges. Bortskaffelse af brugte batterier bør foregå i overensstemmelse med gældende miljølovgivning.



OBS!

Det kan oppstå eksplosjonsfare hvis batteriet skiftes ut med feil type. Brukte batterier bør kastes i henhold til gjeldende miljølovgivning.



VIKTIGT!

Risk för explosion om batteriet ersätts med felaktig batterityp. Batterier ska kasseras enligt de lokala miljövårdsbestämmelserna.



VARO

Räjähdysvaara, jos pariston tyyppi on väärä. Paristot on kierrätettävä, jos se on mahdollista. Käytetyt paristot on hävitettävä paikallisten ympäristömääräysten mukaisesti.



VORSICHT

Bei falschem Einsetzen einer neuen Batterie besteht Explosionsgefahr. Die Batterie darf nur durch denselben oder einen entsprechenden, vom Hersteller empfohlenen Batterietyp ersetzt werden. Entsorgen Sie verbrauchte Batterien den Anweisungen des Herstellers entsprechend.



AVVERTIMENTO

Esiste il pericolo di un esplosione se la pila non viene sostituita in modo corretto. Utilizzare solo pile uguali o di tipo equivalente a quelle consigliate dal produttore. Per disfarsi delle pile usate, seguire le istruzioni del produttore.



PRECAUCIÓN

Existe peligro de explosión si la pila no se cambia de forma adecuada. Utilice solamente pilas iguales o del mismo tipo que las recomendadas por el fabricante del equipo. Para deshacerse de las pilas usadas, siga igualmente las instrucciones del fabricante.



WAARSCHUWING

Er bestaat ontploffingsgevaar als de batterij wordt vervangen door een onjuist type batterij. Batterijen moeten zoveel mogelijk worden gerecycled. Houd u bij het weggooien van gebruikte batterijen aan de plaatselijke milieuwetgeving.



ATENÇÃO

Haverá risco de explosão se a bateria for substituída por um tipo de bateria incorreto. As baterias devem ser recicladas nos locais apropriados. A eliminação de baterias usadas deve ser feita de acordo com as regulamentações ambientais da região.



AŠCIAROŽNAŠĆ

Існуе рызыка выбуху, калі заменены акумулятар неправільнага тыпу. Акумулятары павінны, па магчымасці, перепрацоўвацца. Пазбаўляцца ад старых акумулятараў патрэбна згодна з мясцовым заканадаўствам па экалогіі.



UPOZORNĚNĚ

V pŕípade vŕměny baterie za nesprávnŕnŕ druh mŕže dojít k vŕbuchu. Je-li to moŕné, baterie by měly být recyklovány. Baterie je tŕeba zlikvidovat v souladu s místními pŕedpisy o ŕivotním pŕostŕedí.



Προσοχή

Υπάρχει κίνδυνος για έκρηξη σε περίπτωση που η μπαταρία αντικατασταθεί από μία λανθασμένου τύπου. Οι μπαταρίες θα πρέπει να ανακυκλώνονται όταν κάτι τέτοιο είναι δυνατό. Η απόρριψη των χρησιμοποιημένων μπαταριών πρέπει να γίνεται σύμφωνα με τους κατά τόπο περιβαλλοντικούς κανονισμούς.



VIGYAZAT

Ha a telepet nem a megfelelŕ típusú telepre cseréli, az felrobbanhat. A telepeket lehetőség szerint újra kell hasznosítani. A használt telepeket a helyi környezetvédelmi elŕírásoknak megfelelően kell kiselejtezni.



注意

異なる種類の電池を使用すると、爆発の危険があります。リサイクルが可能な地域であれば、電池をリサイクルしてください。使用後の電池を破棄する際には、地域の環境規制に従ってください。



AWAS

Risiko letupan wujud jika bateri digantikan dengan jenis yang tidak betul. Bateri sepatutnya dikitar semula jika boleh. Pelupusan bateri terpakai mestilah mematuhi peraturan alam sekitar tempatan.



OSTRZEŹENIE

Istnieje niebezpieczeństwo wybuchu w przypadku zastosowania niewłaściwego typu baterii. Zużyte baterie naleŕy w miarę moŕliwości utylizować zgodnie z odpowiednimi przepisami ochrony ŕrodowiska.



PRECAUŢIE

Risc de explozie, dacă bateria este înlocuită cu un tip de baterie necorespunzător. Bateriile trebuie reciclate, dacă este posibil. Depozitarea bateriilor uzate trebuie să respecte reglementările locale privind protecția mediului.



ВНИМАНИЕ

При использовании батареи несоответствующего типа существует риск ее взрыва. Батареи должны быть утилизированы по возможности. Утилизация батарей должна проводиться по правилам, соответствующим местным требованиям.



UPOZORNENIE

Ak batériu vymeníte za nesprávny typ, hrozí nebezpečenstvo jej výbuchu. Batérie by sa mali podľa možnosti vždy recyklovať. Likvidácia použitých batérií sa musí vykonávať v súlade s miestnymi predpismi na ochranu životného prostredia.



POZOR

Zamenjava baterije z baterijo drugačnega tipa lahko povzroči eksplozijo. Če je mogoče, baterije reciklirajte. Rabljene baterije zavržite v skladu z lokalnimi okoljevarstvenimi predpisi.



คำเตือน

ระวังการระเบิดที่เกิดจากเปลี่ยนแบตเตอรี่ผิดประเภท หากเป็นไปได้ ควรนำแบตเตอรี่ไปรีไซเคิล การทิ้งแบตเตอรี่ใช้แล้วต้องเป็นไปตามกฎข้อบังคับด้านสิ่งแวดล้อมของท้องถิ่น.



UYARI

Yanlış türde pil takıldığında patlama riski vardır. Piller mümkün olduğunda geri dönüştürülmelidir. Kullanılmış piller, yerel çevre yasalarına uygun olarak atılmalıdır.



ОСТОРОГА

Використовуйте батареї правильного типу, інакше існуватиме ризик вибуху. Якщо можливо, використані батареї слід утилізувати. Утилізація використаних батарей має бути виконана згідно місцевих норм, що регулюють охорону довкілля.



UPOZORNĚNÍ

V případě výměny baterie za nesprávný druh může dojít k výbuchu. Je-li to možné, baterie by měly být recyklovány. Baterie je třeba zlikvidovat v souladu s místními předpisy o životním prostředí.



ETTEVAATUST

Kui patareid asendatakse uue ebasobivat tüüpi patareiga, võib tekkida plahvatusoht. Tühjad patareid tuleb võimaluse korral viia vastavasse kogumispunkti. Tühjade patareide äraviskamisel tuleb järgida kohalikke keskkonnakaitse alaseid reegleid.



FIGYELMEZTETÉS

Ha az elemet nem a megfelelő típusúra cseréli, felrobbanhat. Az elemeket lehetőség szerint újra kell hasznosítani. A használt elemeket a helyi környezetvédelmi előírásoknak megfelelően kell kiselejtezni.



UZMANĪBU

Pastāv eksplozijas risks, ja baterijas tiek nomainītas ar nepareiza veida baterijām. Ja iespējams, baterijas vajadzētu nodot attiecīgos pieņemšanas punktus. Bateriju izmešanai atkritumos jānotiek saskaņā ar vietējiem vides aizsardzības noteikumiem.



DĒMESIO

Naudojant netinkamo tipo baterijas iřrenginys gali sprogti. Kai tik įmanoma, baterijas reikia naudoti pakartotinai. Panaudotas baterijas išmesti būtina pagal vietinius aplinkos apsaugos nuostatus.



ATTENZJONI

Riskju ta' splużjoni jekk il-batterija tinbidel b'tip ta' batterija mhux korrett. Il-batteriji għandhom jiġu riċiklati fejn hu possibbli. Ir-rimi ta' batteriji użati għandu jsir skond ir-regolamenti ambjentali lokali.



OSTRZEŻENIE

Ryzyko wybuchu w przypadku wymiany na baterie niewłaściwego typu. W miarę możliwości baterie należy poddać recyklingowi. Zużytych baterii należy pozbywać się zgodnie z lokalnie obowiązującymi przepisami w zakresie ochrony środowiska.

To replace the battery, follow these steps:

1. Observe the precautions in "Before You Begin" (see page 31).
2. Turn off all peripheral devices connected to the computer. Disconnect the computer's power cord from the AC power source (wall outlet or power adapter).
3. Remove the computer cover.
4. Locate the battery on the board (see Figure 28).
5. With a medium flat-bladed screwdriver, gently pry the battery free from its connector. Note the orientation of the "+" and "-" on the battery.
6. Install the new battery in the connector, orienting the "+" and "-" correctly.
7. Replace the computer cover.

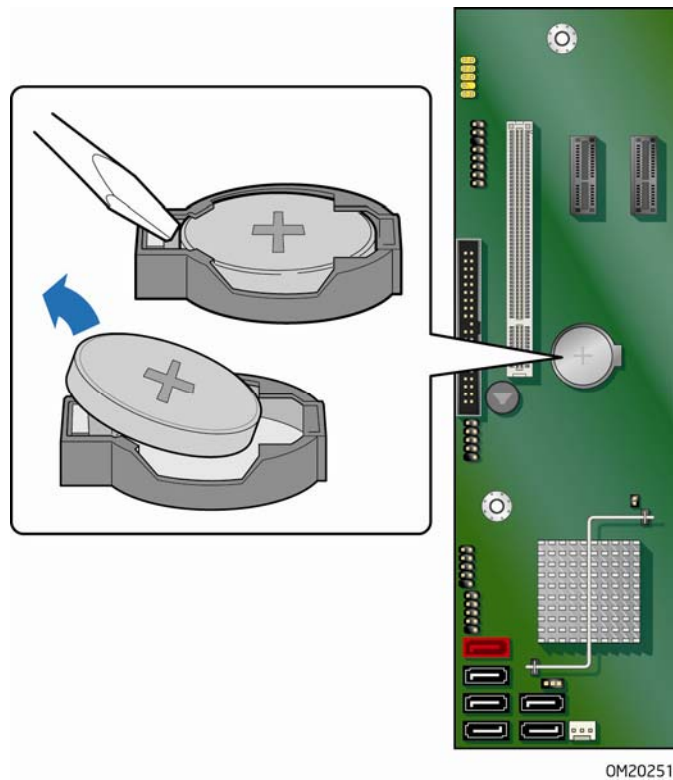

Figure 28. Removing the Battery

3 Updating the BIOS

The BIOS Setup program can be used to view and change the BIOS settings for the computer. You can access the BIOS Setup program by pressing the <F2> key after the Power-On Self-Test (POST) memory test begins and before the operating system boot begins.

This chapter tells you how to update the BIOS by either using the Intel Express BIOS Update utility or the Iflash Memory Update utility, and how to recover the BIOS if an update fails.

Updating the BIOS with the Intel® Express BIOS Update Utility

With the Intel Express BIOS Update utility you can update the system BIOS while in the Windows environment. The BIOS file is included in an automated update utility that combines the functionality of the Intel® Flash Memory Update Utility and the ease of use of Windows-based installation wizards.

To update the BIOS with the Intel Express BIOS Update utility:

1. Go to the Intel World Wide Web site:
<http://support.intel.com/support/motherboards/desktop/>
2. Navigate to the DQ35MP page, click "[view] Latest BIOS updates," and select the Express BIOS Update utility file.
3. Download the file to your hard drive. (You can also save this file to a removable USB device. This is useful if you are updating the BIOS for multiple identical systems.)
4. Close all other applications. This step is required. Your system will be rebooted at the last Express BIOS Update window.
5. Double-click the executable file from the location on your hard drive where it was saved. This runs the update program.
6. Follow the instructions provided in the dialog boxes to complete the BIOS update.

Updating the BIOS with the ISO Image BIOS Update File or the Iflash Memory Update Utility

You can use the information in this section to update the BIOS using either the Iflash Memory Update Utility or the ISO Image BIOS update file.

Obtaining the BIOS Update File

You can update to a new version of the BIOS by using the ISO Image BIOS update file (recommended), or Iflash BIOS update file.

The ISO Image BIOS update file is a standardized image of a bootable CD-ROM that can be used to create a bootable CD that will update the BIOS.

The Iflash BIOS update file is a compressed file that contains the files you need to update the BIOS. The Iflash BIOS update file contains:

- New BIOS file (including the Intel Management Engine Firmware Image)
- Intel® Integrator Toolkit Configuration File (optional)
- Intel Flash Memory Update Utility

You can obtain either of these files through your computer supplier or by navigating to the Desktop Board DQ35MP page on the Intel World Wide Web site at:

<http://support.intel.com/support/motherboards/desktop>

Navigate to the DQ35MP page, click "[view] Latest BIOS updates," and select the ISO Image BIOS Update or Iflash BIOS Update utility file.

Updating the BIOS with the ISO Image BIOS Update File

The ISO Image BIOS update allows for the update of an Intel® Desktop Board BIOS to the latest production release regardless of the operating system installed on the computer's hard drive and without the need to remove the BIOS configuration jumper. It requires a blank CD-R, a read/writeable CD drive, and software capable of uncompressing and writing the ISO image file to CD.

The image uses ISOLINUX* bootloader and automatically launches a script to upgrade the BIOS via the Iflash utility.

**CAUTION**

Do not interrupt the process or the system may not function properly.

Follow these instructions to upgrade the BIOS using the ISO Image BIOS file:

1. Download the ISO Image BIOS file.
2. Using software capable of uncompressing and writing an ISO image file to CD, burn the data to a blank CD.

**NOTE**

Copying the ISO Image BIOS file to CD will not work. The completed CD should contain multiple files and a directory.

3. Insert the CD that was created in the CD-ROM drive of the computer to be upgraded and boot the system.
4. When the "Press ENTER to continue booting from CD-ROM" prompt appears, press the Enter key. The system will boot from the hard drive if no key is pressed within 15 seconds.
5. At the "Welcome to the Intel Desktop Board BIOS Upgrade CD-ROM" page, press any key to confirm the BIOS upgrade operation.
6. Wait for the BIOS upgrade process to complete.

**CAUTION**

DO NOT POWER DOWN YOUR COMPUTER before the update is complete. The update may take up to 5 minutes.

Updating the BIOS with the Iflash Memory Update Utility

With the Iflash Memory update utility you can update the system BIOS from a bootable CD-ROM, bootable USB flash drive, or other bootable USB media. The utility available on the Intel World Wide Web site provides a simple method for creating a bootable CD-ROM that will automatically update your BIOS. The Iflash BIOS update files can also be extracted locally to your hard drive and copied to a bootable USB flash drive or other bootable USB media.

The Iflash Memory update utility allows you to:

- Update the BIOS and Intel Management Engine in flash memory
- Update the language section of the BIOS

**NOTE**

Review the instructions distributed with the update utility before attempting a BIOS update.



CAUTION

Do not interrupt the process or the system may not function properly.

1. Uncompress the BIOS update file and copy the .BIO file, IFLASH.EXE, and .ITK file (optional) to a bootable USB flash drive or other bootable USB media.
2. Configure the BIOS or use the F10 option during POST to boot to the USB device.
3. Manually run the IFLASH.EXE file from the USB device and manually update the BIOS.

Recovering the BIOS

It is unlikely that anything will interrupt the BIOS update; however, if an interruption occurs, the BIOS could be damaged. Due to BIOS size and recovery requirements, a CD-R or USB flash drive with the .BIO file in the root directory will be required.

Related Links:

For more information about updating the Intel Desktop Board BIOS or recovering from a BIOS update failure, go to:

<http://support.intel.com/support/motherboards/desktop/sb/CS-022312.htm>

4 Configuring for RAID (Intel® Matrix Storage Technology)



NOTE

Intel Matrix Storage Technology requires Microsoft Windows Vista or Microsoft Windows XP operating system and SATA hard drives.

Configuring the BIOS for Intel Matrix Storage Technology

1. Assemble your system and attach one or more SATA hard drives to the SATA connectors.
2. Enter system BIOS Setup by pressing the <F2> key after the Power-On-Self-Test (POST) memory tests begin.
3. Go to **Advanced** → **Drive Configuration** → **Configure SATA as**; ensure that **RAID** is selected.
4. Then save your settings by pressing <F10>.

Creating Your RAID Set

1. Upon re-boot, you will see the following Intel Matrix Storage Manager option ROM status message on the screen: Press <Ctrl-I> to enter the RAID Configuration Utility. Press <Ctrl-I> and enter the RAID Configuration Utility.
2. In the Intel Matrix Storage Manager option ROM Main Menu, select option #1: Create RAID Volume. Enter a volume name and press <Enter>. **NOTE:** The RAID Volume name must be in English alphanumeric ASCII characters.
3. Use the arrow keys to select RAID 0 or RAID 1 (if only two SATA drives are available), RAID 5 and RAID 10 (these options will only appear if three or four SATA drives are installed respectively). Press <Enter> once you have selected the RAID LEVEL.
4. Select the drives to be used in the RAID array (only if there are more than two drives available) and press <Enter>.
5. Select the strip size, if necessary, and press <Enter>.
6. Enter the size of the volume (if you enter less than the maximum volume size, you can then create a second RAID array on the remaining portion of your volume) and press <Enter>.
7. Finally, press <Enter> to **Create Volume**.
8. Exit the Option ROM user interface by pressing <Esc> or going to the EXIT option in the MAIN MENU.

Loading the Intel Matrix Storage Technology RAID Drivers and Software

1. Begin Windows Setup by booting from the Windows installation CD.
2. If you will be using Microsoft Windows XP, press <F6> at the beginning of Windows Setup to install a third-party SCSI or RAID driver. When prompted, insert the diskette labeled Intel Matrix Storage Technology RAID Driver into a USB floppy drive. Install the Intel® ICH9 SATA RAID Controller driver.
or
If you will be using Microsoft Windows Vista, follow the setup installation steps until you reach the section "Where do you want to install Windows?". Click on the "Load Drivers" option and insert the Intel Express Installer CD/DVD into your optical drive or insert the diskette labeled Intel Matrix Storage Technology RAID Driver into a USB floppy drive. Select to install the Intel ICH9 SATA RAID Controller driver.
3. Finish the Windows installation and install all necessary drivers.
4. Install the Intel Matrix Storage Console software via the Intel Express Installer CD/DVD included with your desktop board or after downloading it from the Internet at <http://support.intel.com/support/motherboards/desktop/>. The Intel Matrix Storage Console software can be used to manage the RAID configuration.

Setting Up a "RAID Ready" System

The Intel Matrix Storage Technology Console software offers the flexibility to upgrade from a single Serial ATA drive to RAID without reinstalling the operating system, when a second SATA hard drive is added to the system.

Follow the steps described in the headings from this section: "Configuring the BIOS for Intel Matrix Storage Technology" and "Loading the Intel Matrix Storage Technology RAID Drivers and Software".

Once additional SATA drives have been added, open the Intel Matrix Storage Technology Console Software and follow the directions to update to a RAID setup.

5 Configuring for Intel® Rapid Recover Technology

Intel Rapid Recover technology utilizes RAID 1 (mirroring) functionality to copy data from a designated master drive to a designated recovery drive. The master and recovery drives must span 100 percent of the available hard drive space of an array, and only one recovery volume can be present on a system.

You can select whether you want the master drive data to be copied to the recovery drive continuously or on request. When using the Continuous Update policy, changes made to the data on the master drive while the recovery drive is disconnected or offline are automatically copied to the recovery drive when it is reconnected.

When using the Update On Request policy, the master drive data can be restored to a previous state by copying the data on the recovery drive back to the master drive.

Enabling Intel Rapid Recover Technology



NOTE

Intel Rapid Recover Technology does not support RAID 5.

Intel Rapid Recover Technology can be Enabled or Disabled in the system BIOS menu. To enable Intel Rapid Recover Technology, complete following steps:

1. Enter the BIOS menu by pressing the <F2> key early during system POST.
2. Go to **Advanced** → **Drive Configuration**.
3. For the setting **Intel Rapid Recover Technology**, select to enable it.
4. For the setting **Configure SATA as**, ensure it is set to **RAID**.



CAUTION

*If **Configure SATA as** was previously not set to **RAID** and you already have an operating system installed, you must reinstall it. Follow the instructions in Chapter 5 to install the Intel Matrix Storage RAID driver during the operating system installation.*

5. Exit and save settings. Proceed to "Creating a Recovery Volume."

Creating a Recovery Volume

A recovery volume consists of two disks – a master disk and a recovery disk.

A recovery volume can be created with either the RAID Option ROM (OROM) or the Intel® Matrix Storage Console application.

Creating a Recovery Volume Using the RAID Option ROM

To create a recovery volume using the RAID OROM, complete the following steps:

1. Enter the RAID OROM by pressing the <Ctrl> and <I> keys simultaneously when prompted during system POST.
2. Under the **Create RAID** volume option, select the option to create a recovery volume.
3. Select the master disk and the recovery disk.



NOTE

The master disk size must be less than or equal to the recovery disk size.

The RAID OROM Recovery menu provides the following options:

1. Disable Continuous Update
2. Boot from Recovery Disk
3. Boot from Master Disk

Creating a Recovery Volume Using the Intel Matrix Storage Console

To create a recovery volume using the Intel Matrix Storage Console, the system must be configured in RAID mode with two drives. Boot the system into Microsoft Windows and open the Intel Matrix Storage Console application.

A recovery volume can be created in the Basic mode or the Advanced mode.

To create a recovery volume using the Basic mode, complete the following steps:

1. Select **Protect data using Intel® Rapid Recover Technology**.
2. A dialog box will pop up. Selecting **Yes** will start the volume creation process which can be monitored on the progress bar.

To create a recovery volume using the Advanced mode, complete the following steps:

1. Select **Advanced Mode** in the View menu.
2. Select **Create a Recovery Volume** in the Actions menu.
3. Select **Next** to continue.
4. Select the master disk and select **Next** to continue.
5. Select the recovery disk and select **Next** to continue.

6. Select the Update policy – **Continuous update** or **Update on request**.
7. Select **Finish** to complete the creation of the recovery volume.

The system will synchronize the master disk with the recovery disk once after the creation of the recovery volume.

Disk Synchronization Mode

There are two modes of updating or synchronizing the recovery disk with the master disk – either continuous update or manual update.

To change from Continuous Update mode to Update On Request mode using the Intel Matrix Storage Console, select the **Advanced mode** from the View menu, right-click on the recovery volume, and select **Disable Continuous Update**.

To change from Update On Request mode to Continuous update mode, complete the following steps:

1. Right-click on the recovery volume name and select **Modify Volume**.
2. Select **Next** on the **Modify Recovery Volume Wizard** dialog box to continue.
3. On the next screen, select **Continuous update**.
4. Select **Next** and then **Finish** to complete the operation.

Mounting the Recovery Disk



NOTE

Mounting the recovery disk will result in displaying the recovery disk in Microsoft Windows Explorer. The recovery disk contents will be write-protected to preserve data integrity with master disk.

To mount the mount the recovery disk, complete the following steps:

1. Make sure that the recovery volume is in **Update On Request** mode.
2. Then right-click on the recovery volume name and select **Access Recovery Drive Files**.
3. Select **OK** on the information dialog box.

The recovery disk will now be mounted and can be seen in Microsoft Windows Explorer.



NOTE

Individual files or folders can be copied from the recovery disk to the master disk. No write operations can be performed on the recovery disk.

To un-mount the recovery disk, complete the following steps:

1. In the Advanced mode, right-click on the recovery volume name.
2. Select **Access Recovery Drive Files**.
3. Select **OK** on the information dialog box.

The recovery disk is now un-mounted and reappears in Intel Matrix Storage Console.

A Error Messages and Indicators

Desktop Board DQ35MP reports POST errors in two ways:

- By sounding a beep code
- By displaying an error message on the monitor

BIOS Beep Codes

The BIOS also issues a beep code (one long tone followed by two short tones) during POST if the video configuration fails (a faulty video card or no card installed) or if an external ROM module does not properly checksum to zero. Table 13 lists the BIOS codes.

Table 13. Beep Codes

Beep	Description
3	No memory
Siren	Processor overheat (on reboot)

BIOS Error Messages

When a recoverable error occurs during the POST, the BIOS displays an error message describing the problem. Table 14 gives an explanation of the BIOS error messages.

Table 14. BIOS Error Messages

Error Message	Explanation
PROCESSOR_THERMAL_TRIP_ERROR	Processor was previously shutdown due to a thermal event (overheating).
MULTI_BIT_ECC_ERROR	The firmware has detected that a Multi-Bit ECC Error occurred.
SINGLE_BIT_ECC_ERROR	The firmware has detected that a Single-Bit ECC Error occurred.
CMOS_BATTERY_ERROR	The firmware has detected that a CMOS battery failure occurred.
CMOS_CHECKSUM_ERROR	The firmware has detected that a CMOS Checksum Error occurred.
CMOS_TIMER_ERROR	The firmware has detected that the system date/time has not been set.
MEMORY_SIZE_DECREASE_ERROR	The firmware has detected that the system memory has decreased.
INTRUDER_DETECTION_ERROR	The system chassis was opened.
SPD_TOLER_ERROR	SERIAL PRESENCE DETECT (SPD) device data missing or inconclusive. Properly programmed SPD device data is required for reliable operation.
MEM_OPTIMAL_ERROR	The installed amount of memory in Channel A is not equal to the amount of memory in Channel B. Maximum memory performance is achieved with equal amounts of memory installed in each channel.

B Regulatory Compliance

This appendix contains the following regulatory compliance information for Desktop Board DQ35MP:

- Safety standards
- European Union Declaration of Conformity statement
- Product Ecology statements
- Electromagnetic Compatibility (EMC) regulations
- Product certifications

Safety Standards

Desktop Board DQ35MP complies with the safety standards stated in Table 15 when correctly installed in a compatible host system.

Table 15. Safety Standards

Regulation	Title
UL 60950-1, First Edition	Information Technology Equipment – Safety - Part 1: General Requirements (USA and Canada)
EN 60950-1:2006, Second Edition	Information Technology Equipment – Safety - Part 1: General Requirements (European Union)
IEC 60950-1:2005, Second Edition	Information Technology Equipment – Safety - Part 1: General Requirements (International)

Place Battery Marking

There is insufficient space on this Desktop Board to provide instructions for replacing and disposing of the Lithium ion coin cell battery. For system safety certification, the statement below or an equivalent statement is required to be permanently and legibly marked on the chassis near the battery.



CAUTION

Risk of explosion if the battery is replaced with an incorrect type. Batteries should be recycled where possible. Disposal of used batteries must be in accordance with local environmental regulations.

Related Links

For information about replacing the battery, go to page 61.

European Union Declaration of Conformity Statement

We, Intel Corporation, declare under our sole responsibility that the product Intel® Desktop Board DQ35MP is in conformity with all applicable essential requirements necessary for CE marking, following the provisions of the European Council Directives 2004/108/EC (EMC Directive) and 2006/95/EC (Low Voltage Directive).

The product is properly CE marked demonstrating this conformity and is for distribution within all member states of the EU with no restrictions.



This product follows the provisions of the European Directives 2004/108/EC and 2006/95/EC.

Čeština Tento výrobek odpovídá požadavkům evropských směrnic 2004/108/EC a 2006/95/EC.

Dansk Dette produkt er i overensstemmelse med det europæiske direktiv 2004/108/EC & 2006/95/EC.

Dutch Dit product is in navolging van de bepalingen van Europees Directief 2004/108/EC & 2006/95/EC.

Eesti Antud toode vastab Euroopa direktiivides 2004/108/EC ja 2006/95/EC kehtestatud nõuetele.

Suomi Tämä tuote noudattaa EU-direktiivin 2004/108/EC & 2006/95/EC määräyksiä.

Français Ce produit est conforme aux exigences de la Directive Européenne 2004/108/EC & 2006/95/EC.

Deutsch Dieses Produkt entspricht den Bestimmungen der Europäischen Richtlinie 2004/108/EC & 2006/95/EC.

Ελληνικά Το παρόν προϊόν ακολουθεί τις διατάξεις των Ευρωπαϊκών Οδηγιών 2004/108/EC και 2006/95/EC.

Magyar E termék megfelel a 2004/108/EC és 2006/95/EC Európai Irányelv előírásainak.

Icelandic Þessi vara stenst reglugerð Evrópska Efnahags Bandalagsins númer 2004/108/EC & 2006/95/EC.

Italiano Questo prodotto è conforme alla Direttiva Europea 2004/108/EC & 2006/95/EC.

Latviešu Šis produkts atbilst Eiropas Direktīvu 2004/108/EC un 2006/95/EC noteikumiem.

Lietuvių Šis produktas atitinka Europos direktyvų 2004/108/EC ir 2006/95/EC nuostatas.

Malti Dan il-prodott hu konformi mal-provvedimenti tad-Direttivi Ewropej 2004/108/EC u 2006/95/EC.

Norsk Dette produktet er i henhold til bestemmelsene i det europeiske direktivet 2004/108/EC & 2006/95/EC.

Polski Niniejszy produkt jest zgodny z postanowieniami Dyrektyw Unii Europejskiej 2004/108/EC i 2006/95/EC.

Portuguese Este produto cumpre com as normas da Diretiva Europeia 2004/108/EC & 2006/95/EC.

Español Este producto cumple con las normas del Directivo Europeo 2004/108/EC & 2006/95/EC.

Slovensky Tento produkt je v súlade s ustanoveniami európskych direktív 2004/108/EC a 2006/95/EC.

Slovenščina Izdelek je skladen z določbami evropskih direktiv 2004/108/EC in 2006/95/EC.

Svenska Denna produkt har tillverkats i enlighet med EG-direktiv 2004/108/EC & 2006/95/EC.

Türkçe Bu ürün, Avrupa Birliği'nin 2004/108/EC ve 2006/95/EC yönergelerine uyar.

Product Ecology Statements

The following information is provided to address worldwide product ecology concerns and regulations.

Recycling Considerations

As part of its commitment to environmental responsibility, Intel has implemented the Intel® Product Recycling Program to allow retail consumers of Intel's branded products to return used products to selected locations for proper recycling.

Please consult http://www.intel.com/intel/other/ehs/product_ecology for the details of this program, including the scope of covered products, available locations, shipping instructions, terms and conditions, etc.

中文

作为其对环境责任之承诺的部分，英特尔已实施 Intel Product Recycling Program（英特尔产品回收计划），以允许英特尔品牌产品的零售消费者将使用过的产品退还至指定地点作恰当的重复使用处理。

请参考http://www.intel.com/intel/other/ehs/product_ecology了解此计划的详情，包括涉及产品之范围、回收地点、运送指导、条款和条件等。

Deutsch

Als Teil von Intels Engagement für den Umweltschutz hat das Unternehmen das Intel Produkt-Recyclingprogramm implementiert, das Einzelhandelskunden von Intel Markenprodukten ermöglicht, gebrauchte Produkte an ausgewählte Standorte für ordnungsgemäßes Recycling zurückzugeben.

Details zu diesem Programm, einschließlich der darin eingeschlossenen Produkte, verfügbaren Standorte, Versandanweisungen, Bedingungen usw., finden Sie auf der http://www.intel.com/intel/other/ehs/product_ecology

Español

Como parte de su compromiso de responsabilidad medioambiental, Intel ha implantado el programa de reciclaje de productos Intel, que permite que los consumidores al detalle de los productos Intel devuelvan los productos usados en los lugares seleccionados para su correspondiente reciclado.

Consulte la http://www.intel.com/intel/other/ehs/product_ecology para ver los detalles del programa, que incluye los productos que abarca, los lugares disponibles, instrucciones de envío, términos y condiciones, etc.

Français

Dans le cadre de son engagement pour la protection de l'environnement, Intel a mis en œuvre le programme Intel Product Recycling Program (Programme de recyclage des produits Intel) pour permettre aux consommateurs de produits Intel de recycler les produits usés en les retournant à des adresses spécifiées.

Visitez la page Web http://www.intel.com/intel/other/ehs/product_ecology pour en savoir plus sur ce programme, à savoir les produits concernés, les adresses disponibles, les instructions d'expédition, les conditions générales, etc.

日本語

インテルでは、環境保護活動の一環として、使い終わったインテルブランド製品を指定の場所へ返送していただき、リサイクルを適切に行えるよう、インテル製品リサイクルプログラムを発足させました。

対象製品、返送先、返送方法、ご利用規約など、このプログラムの詳細情報は、http://www.intel.com/intel/other/ehs/product_ecology (英語)をご覧ください。

Malay

Sebagai sebahagian daripada komitmennya terhadap tanggungjawab persekitaran, Intel telah melaksanakan Program Kitar Semula Produk untuk membenarkan pengguna-pengguna runcit produk jenama Intel memulangkan produk terguna ke lokasi-lokasi terpilih untuk dikitar semula dengan betul.

Sila rujuk http://www.intel.com/intel/other/ehs/product_ecology untuk mendapatkan butir-butir program ini, termasuklah skop produk yang dirangkumi, lokasi-lokasi tersedia, arahan penghantaran, terma & syarat, dsb.

Portuguese

Como parte deste compromisso com o respeito ao ambiente, a Intel implementou o Programa de Reciclagem de Produtos para que os consumidores finais possam enviar produtos Intel usados para locais selecionados, onde esses produtos são reciclados de maneira adequada.

Consulte o site http://www.intel.com/intel/other/ehs/product_ecology (em Inglês) para obter os detalhes sobre este programa, inclusive o escopo dos produtos cobertos, os locais disponíveis, as instruções de envio, os termos e condições, etc.

Russian

В качестве части своих обязательств к окружающей среде, в Intel создана программа утилизации продукции Intel (Product Recycling Program) для предоставления конечным пользователям марок продукции Intel возможности возврата используемой продукции в специализированные пункты для должной утилизации.

Пожалуйста, обратитесь на веб-сайт http://www.intel.com/intel/other/ehs/product_ecology за информацией об этой программе, принимаемых продуктах, местах приема, инструкциях об отправке, положениях и условиях и т.д.

Türkçe

Intel, çevre sorumluluğuna bağlılığının bir parçası olarak, perakende tüketicilerin Intel markalı kullanılmış ürünlerini belirlenmiş merkezlere iade edip uygun şekilde geri dönüştürmesini amaçlayan Intel Ürünleri Geri Dönüşüm Programı'nı uygulamaya koymuştur.

Bu programın ürün kapsamı, ürün iade merkezleri, nakliye talimatları, kayıtlar ve şartlar v.s dahil bütün ayrıntılarını öğrenmek için lütfen http://www.intel.com/intel/other/ehs/product_ecology web sayfasına gidin.

Lead-Free Desktop Board



This Desktop Board is a European Union Restriction of Hazardous Substances (EU RoHS Directive 2002/95/EC) compliant product. EU RoHS restricts the use of six materials. One of the six restricted materials is lead.

Intel Desktop Board DQ35MP is lead-free although certain discrete components used on the board contain a small amount of lead which is necessary for component performance and/or reliability. This Desktop Board is referred to as "Lead-free second level interconnect." The board substrate and the solder connections from the board to the components (second-level connections) are all lead-free.

China bans the same substances and has the same limits as EU RoHS; however it requires different product marking and controlled substance information. The required mark shows the Environmental Friendly Usage Period (EFUP). The EFUP is defined as the number of years for which controlled listed substances will not leak or chemically deteriorate while in the product.

Table 16 shows the lead-free board markings as they appear on the board and accompanying collateral.

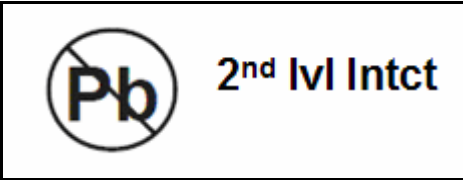
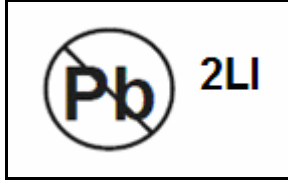
Table 16. Lead-Free Board Markings

Description	Mark
<p>Lead-Free 2nd Level Interconnect: This symbol is used to identify electrical and electronic assemblies and components in which the lead (Pb) concentration level in the Intel Desktop Board substrate and the solder connections from the board to the components (second-level interconnect) is not greater than 0.1% by weight (1000 ppm).</p>	<div style="text-align: center;">  <p>or</p>  <p>or</p>  </div>
<p>China RoHS/Environmentally Friendly Use Period Logo: This is an example of the symbol used on Intel Desktop Boards and associated collateral. The color of the mark may vary depending upon the application. The Environmental Friendly Usage Period (EFUP) for Intel Desktop Boards has been determined to be 10 years.</p>	<div style="text-align: center;">  </div>

EMC Regulations

Desktop Board DQ35MP complies with the EMC regulations stated in Table 17 when correctly installed in a compatible host system.

Table 17. EMC Regulations

Regulation	Title
FCC 47 CFR Part 15, Subpart B	Title 47 of the Code of Federal Regulations, Part 15, Subpart B, Radio Frequency Devices. (USA)
ICES-003 Issue 4 (Class B)	Interference-Causing Equipment Standard, Digital Apparatus. (Canada)
EN55022:2006 (Class B)	Limits and methods of measurement of Radio Interference Characteristics of Information Technology Equipment. (European Union)
EN55024:1998	Information Technology Equipment – Immunity Characteristics Limits and methods of measurement. (European Union)
EN55022:2006 (Class B)	Australian Communications Authority, Standard for Electromagnetic Compatibility. (Australia and New Zealand)
CISPR 22:2005 +A1:2005 +A2:2006 (Class B)	Limits and methods of measurement of Radio Disturbance Characteristics of Information Technology Equipment. (International)
CISPR 24:1997 +A1:2001 +A2:2002	Information Technology Equipment – Immunity Characteristics – Limits and Methods of Measurement. (International)
VCCI V-3/2007.04, V-4/2007.04, Class B	Voluntary Control for Interference by Information Technology Equipment (Japan)

Japanese Kanji statement translation: This is a Class B product based on the standard of the Voluntary Control Council for Interference from Information Technology Equipment (VCCI). If this is used near a radio or television receiver in a domestic environment, it may cause radio interference. Install and use the equipment according to the instruction manual.

この装置は、情報処理装置等電波障害自主規制協議会（VCCI）の基準に基づくクラスB情報技術装置です。この装置は、家庭環境で使用することを目的としていますが、この装置がラジオやテレビジョン受信機に近接して使用されると、受信障害を引き起こすことがあります。
取扱説明書に従って正しい取り扱いをして下さい。

Korean Class B statement translation: This is household equipment that is certified to comply with EMC requirements. You may use this equipment in residential environments and other non-residential environments.

이 기기는 가정용으로 전자파적합등록을 한 기기로서
주거지역에서는 물론 모든 지역에서 사용할 수 있습니다.

Ensure Electromagnetic Compatibility (EMC) Compliance

Before computer integration, make sure that the power supply and other modules or peripherals, as applicable, have passed Class B EMC testing and are marked accordingly.

Pay close attention to the following when reading the installation instructions for the host chassis, power supply, and other modules:

- Product certifications or lack of certifications
- External I/O cable shielding and filtering
- Mounting, grounding, and bonding requirements
- Keying connectors when mating the wrong connectors could be hazardous







If the power supply and other modules or peripherals, as applicable, are not Class B EMC compliant before integration, then EMC testing may be required on a representative sample of the newly completed computer.

Product Certifications

Board-Level Certification Markings

Desktop Board DQ35MP has the product certification markings shown in Table 18.

Table 18. Product Certification Markings

Description	Mark
UL joint US/Canada Recognized Component mark. Includes adjacent UL file number for Intel Desktop Boards: E210882.	
FCC Declaration of Conformity logo mark for Class B equipment. Includes Intel name and DQ35MP model designation.	
CE mark. Declaring compliance to European Union (EU) EMC directive and Low Voltage directive.	
Australian Communications Authority (ACA) C-tick mark. Includes adjacent Intel supplier code number, N-232.	
Japan VCCI (Voluntary Control Council for Interference) mark.	
S. Korea MIC (Ministry of Information and Communication) mark. Includes adjacent MIC certification number: CPU-DQ35MP (B).	
Taiwan BSMI (Bureau of Standards, Metrology and Inspections) mark. Includes adjacent Intel company number, D33025.	
Printed wiring board manufacturer's recognition mark. Consists of a unique UL recognized manufacturer's logo, along with a flammability rating (solder side).	V-0

Chassis and Component Certifications

Ensure that the chassis and certain components; such as the power supply, peripheral drives, wiring, and cables; are components certified for the country or market where used. Agency certification marks on the product are proof of certification. Typical product certifications include:

In Europe

The CE marking signifies compliance with all applicable European requirements. If the chassis and other components are not properly CE marked, a supplier's Declaration of Conformity statement to the European EMC directive and Low Voltage directive (as applicable), should be obtained. Additionally, other directives, such as the Radio and Telecommunications Terminal Equipment (R&TTE) directive may also apply depending on product features.

In the United States

A certification mark by a Nationally Recognized Testing Laboratory (NRTL) such as UL, CSA, or ETL signifies compliance with safety requirements. Wiring and cables must also be UL listed or recognized and suitable for the intended use. The FCC Class B logo for home or office use signifies compliance with electromagnetic interference (EMI) requirements.

In Canada

A nationally recognized certification mark such as CSA or cUL signifies compliance with safety requirements. The Industry Canada statement at the front of this product guide demonstrates compliance with Canadian EMC regulations.