

P4LA

Industrial motherboard

User's Manual

Edition: 1.00

2006/05/30



Copyright

Copyright 2006. All rights reserved. This document is copyrighted and all rights are reserved. The information in this document is subject to change without prior notice to make improvements to the products.

This document contains proprietary information and protected by copyright. No part of this document may be reproduced, copied, or translated in any form or any means without prior written permission of the manufacturer.

All trademarks and/or registered trademarks contains in this document are property of their respective owners.

Disclaimer

The company shall not be liable for any incidental or consequential damages resulting from the performance or use of this product.

The company does not issue a warranty of any kind, express or implied, including without limitation implied warranties of merchantability or fitness for a particular purpose.

The company has the right to revise the manual or include changes in the specifications of the product described within it at any time without notice and without obligation to notify any person of such revision or changes.

Trademark

All trademarks are the property of their respective holders.

Any questions please visit our website at <http://www.commell.com.tw>.

Packing List

Please check package component before you use our products.

Hardware:

P4LA industrial motherboard x 1

Cable Kit:

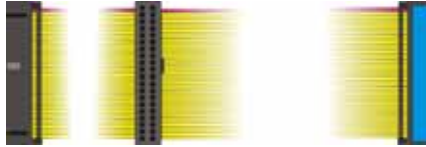

40-pin ATA100 IDE flat cable x 1



Serial ATA ribbon cable x 2

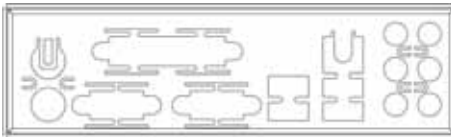

I/O Shield x 1

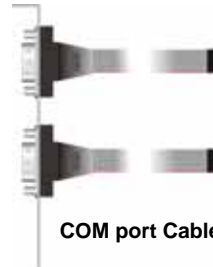

COM port Cable x 1



RAID drivers Disc for Windows 2000,
Windows XP and Windows Server 2003

Other Accessories:

Divers CD (including User's Manual) x 1

User's Manual x 1

Index

Chapter1 <Introduction>	7
1.1 <Product Overview>.....	7
1.2 <Product Specification>	8
1.3 <Component Placement>	10
1.4 <Block Diagram>.....	11
1.5 <Mechanical Drawing >.....	12
Chapter 2 <Hardware Setup>	13
2.1 <Connector Location>.....	13
2.2 <Jumper Reference>	14
2.3 <Connector Reference>.....	15
2.3.1 <Internal Connectors>	15
2.3.2 <External Connectors>	15
2.4 <CPU and Memory Setup>.....	16
2.4.1 <CPU installation>.....	16
2.4.2 <Memory installation>.....	17
2.5 <CMOS Setup>	18
2.6 <Enhanced IDE interface>	19
2.7 <Serial ATA installation>.....	20
2.8 <Floppy Installation>	21
2.9 <LAN installation>	22
2.10 <Audio Installation>.....	23
2.11 <Display Installation>	25
2.12 <USB Installation>.....	26
2.13 <Power and Fan Installation>	28
2.14 <GPIO interface>	30
2.15 <Serial Port>	31
2.16 <Switch and Indicator>.....	32

2.17 <Expansion Interface>	33
Chapter 3 <System Configuration>	35
3.1 <SATA configuration>	35
3.2 <SATA RAID Configuration>	38
3.3 <Audio Configuration>	42
3.4 <Video Memory Setup>	43
3.5 <Display Properties Setting>.....	45
Chapter 4 <BIOS Setup>.....	47
Appendix A <I/O Port Pin Assignment>	49
A.1 IDE Port	49
A.2 <Serial ATA Port>	49
A.3 <Floppy Port>	50
A.4 <IrDA Port>	50
A.5 <Serial Port>	51
A.6 <VGA Port>.....	51
A.7 <LAN Port>	52
A.8 <SMBus>	52
A.9 <LPT Port >.....	53
Appedix B <System Resources>	54
Appendix B <How to setting RS-422/485>	58
Appedix C <Flash BIOS>.....	59
C.1 BIOS Auto Flash Tool	59
C.2 Flash Method.....	59
Appendix D <Programming GPIO's>.....	60
Appendix E <What Dog timer Setting >.....	61
Contact Information	62

(This Page is Left for Blank)

Chapter1 <Introduction>

1.1 <Product Overview>

P4LA is the motherboard with last Intel desktop technology with industrial motherboard form factor. Based on Intel® 945G and ICH7R, the board integrates a new Pentium 4 processor 775-pin socket, DDR2 memory slot, Intel® Graphic Media Accelerator 950 technology, PCI express interface and Serial ATA II with RAID function for a powerful desktop system.

Intel® LGA775 processor

The Intel® Pentium 4 processor now comes with a new form factor with 775-pin PLGA package, for 533/800/1066MHz front-side-bus, 2MB L2 cache, and for 90nm manufacturing technology, the PLGA processor without pin header on solder side can make user installing the processor on the socket easier.

Intel® 945G and ICH7R chipset

The Intel 945G integrates DDR2 400/533/667MHz for memory, and Graphic Media Accelerator (GMA) 950 technology for new graphic engine. It can provide up to 224MB of frame buffer when you install over 256MB of system memory. The ICH7R integrates with up to 8 USB2.0 interfaces (8 ports for P4LA), and serial ATA II interface with RAID function.

One Marvell E8053

One Gigabit LAN with Marvell E8053, P4LA comes with a powerful network function for the system that requires large transfer data of NAS system or Server platform.

PCI-Express interface

P4LA integrates one x16, x4 and x1 PCI-Express interface, it can provide up to 8GB/s of bandwidth, which AGP 8x can only provide up to 2GB/s.

Multimedia interfaces

P4LA also integrates 7.1 channel HD audio, PCI-Express, PCI and ISA interface, for these flexible function, system integrator can built more powerful systems for many applications.

1.2 <Product Specification>

General Specification

Form Factor	Industrial motherboard
CPU	Intel® Pentium 4 /Pentium D/ Celeron D/ Core 2 Duo processor with LGA775 socket Package type: 775 pin PLGA Front side bus: 533/800/1066MT/s (133/200/266MHz x 4) Intel® Hyper-Threading Technology and Dual Core supported
Memory	4 x 240-pin DDR2 400/533/667MHz SDRAM up to 3GB Dual-Channel technology supported Unbuffered, none-ECC memory supported only
Chipset	Intel® 945G (Northbridge) and ICH7R (Southbridge)
BIOS	Phoenix-Award v6.00PG 4Mb PnP flash BIOS
Green Function	Power saving mode includes doze, standby and suspend modes. ACPI version 1.0 and APM version 1.2 compliant
Watchdog Timer	System reset programmable watchdog timer with 1 ~ 255 sec./min. of timeout value
Real Time Clock	Intel® ICH7R built-in RTC with lithium battery
Enhanced IDE	Enhanced IDE interface supports dual channels and up to 2 ATAPI devices at Ultra DMA100 One 40-pin IDE port onboard
Serial ATAI	Intel® ICH7R integrates 4 Serial ATA II interface RAID 0, 1,5,10 Intel Matrix Storage Technology supported

Multi-I/O Port

Chipset	Intel® 82801GR ICH7R with Winbond® W83627THG controller
Serial Port	Five internal RS-232 and one external RS-232 serial port
USB Port	Eight Hi-Speed USB 2.0 ports with 480Mbps of transfer rate
Parallel Port	One LPT port on rear I/O panel
Floppy Port	One Floppy port
IrDA Port	One IrDA compliant Infrared interface supports SIR
K/B & Mouse	External PS/2 keyboard and mouse ports on rear I/O panel
GPIO	One 12-pin Digital I/O connector with 8-bit programmable I/O interface
Smart Fan	One CPU fan connectors for fan speed controllable

VGA Display Interface

Chipset	Intel® 945G GMCH (Graphic Memory Controller Hub)
Core Frequency	400MHz
Memory	Intel® DVMT 3.0 with up to 224MB shared with system memory
Display Type	CRT, LCD monitor with analog display
Connector	External DB15 female connector on rear I/O panel

Ethernet Interface

Chipset	10/100/1000MT LAN interface with Marvell E8053
Type	10Base-T / 100Base-TX/1000Base-T, auto-switching Fast Ethernet Full duplex, IEEE802.3U compliant
Connector	one External RJ45 connectors with LED on rear I/O panel

Audio Interface

Chipset	Intel® ICH7R with Realtek® ALC880 codec Intel High Definition Audio compliance
Interface	7.1 channels sound output
Connector	External Audio phone jack for Line-out, Line-in, MIC-in, Surround, Center and Backsurround Onboard audio connector with pin header (built-in amplifier for speaker out) Onboard CD-IN and S/PDIF connector

Expansive Interface

PCI-Express	One x16 PCI-Express slot (compatible with x1 slot) One x4 PCI-Express slot One x1 PCI-Express slot Up to 8GB/s of transfer bandwidth Power supply: +3.3V, +12V
PCI	Four-PCI slot (32-bit, 33MHz) Power supply: +3.3V, +5V
ISA	One ISA slot

Power and Environment

Power Requirement	Standard ATX 24-pin (20-pin is compatible) power supply Additional +12V 8-pin(4-pin is compatible) power connector
Dimension	307mm x 244mm (L x W)
Temperature	Operating within 0 ~ 60°C (32 ~ 140°F) Storage within -20 ~ 85°C (-4 ~ 185°F)

Ordering Code

P4LA	Support Intel Pentium 4 LGA775 with DDRII, Onboard VGA, One Marvell Gigabit LAN ,8 x USB2.0, Realtek ALC880 HD Audio, 6 x COM Ports, GPIO, SATA, CF and ISA slot.
-------------	---

The specifications may be different as the actual production.

For further product information please visit the website at <http://www.commell.com.tw>

1.3 <Component Placement>

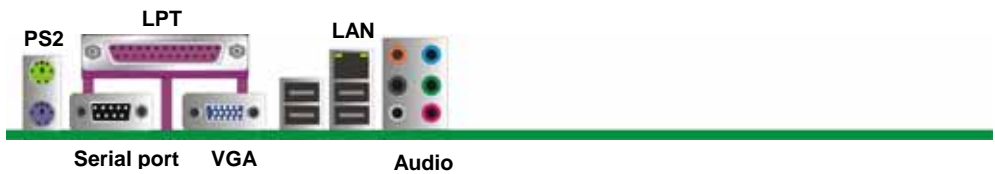
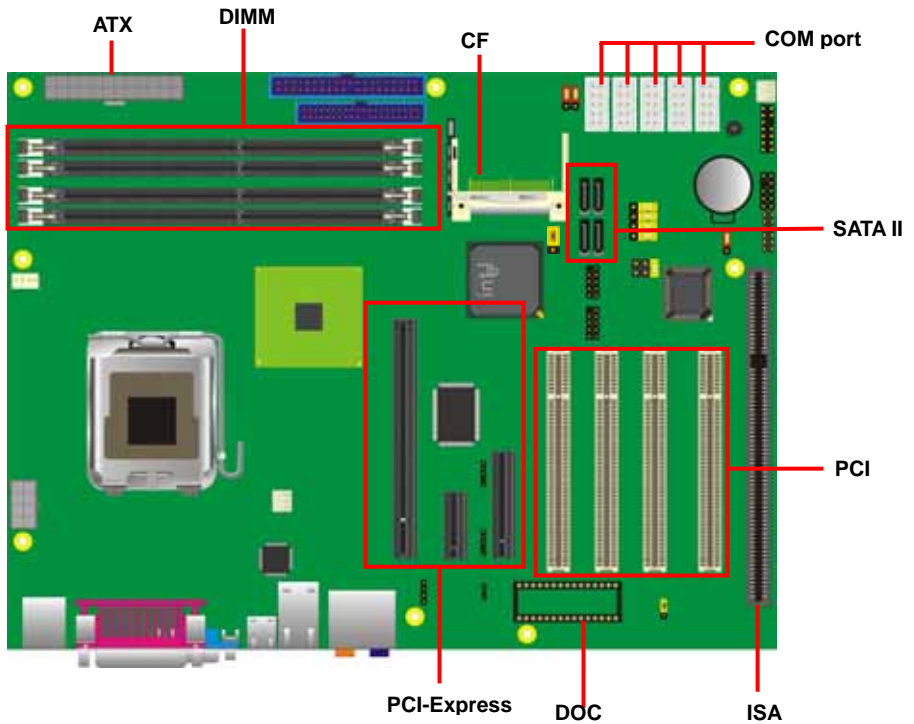

1.4 <Block Diagram>

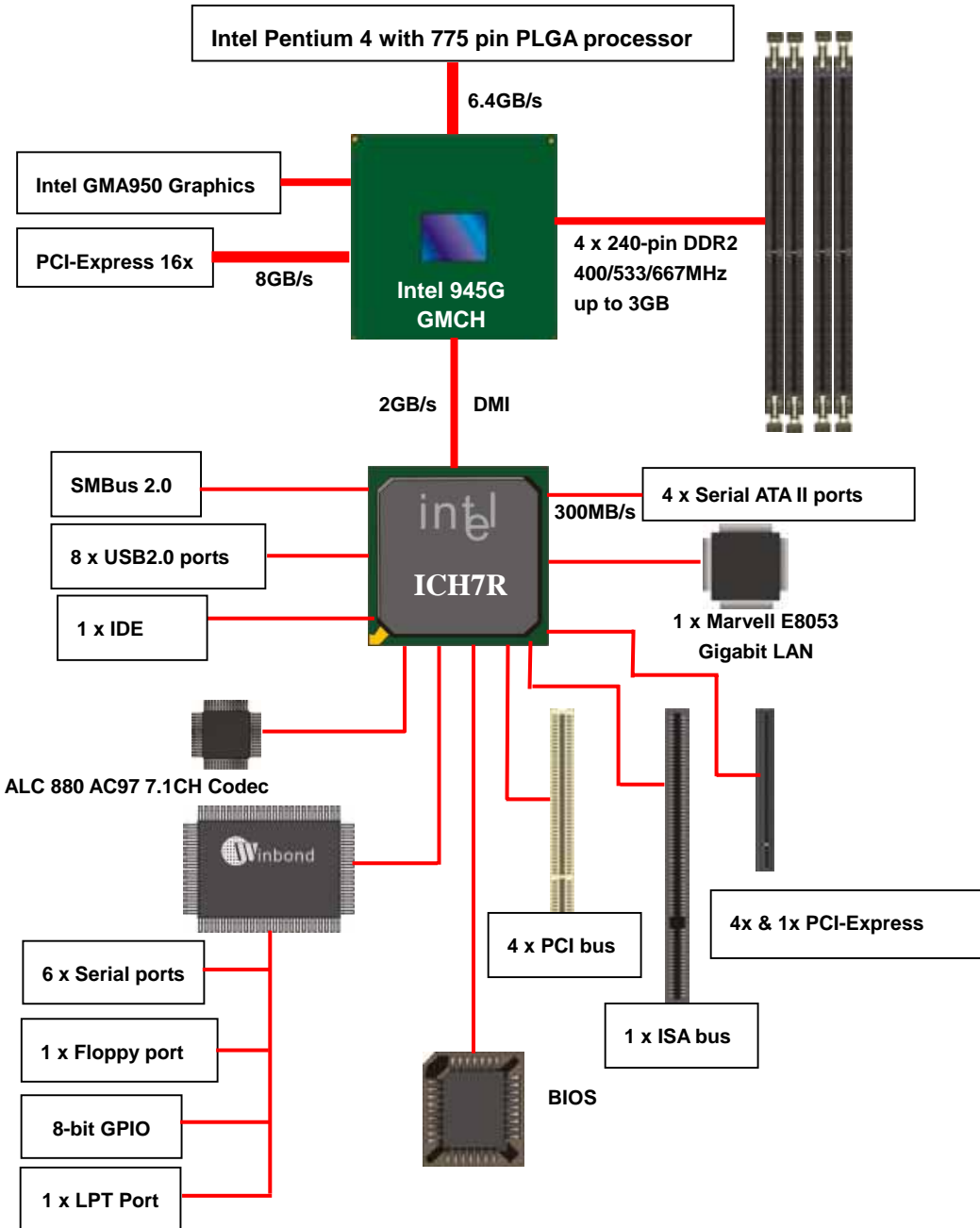

1.5 <Mechanical Drawing >



Chapter 2 <Hardware Setup>

2.1 <Connector Location>

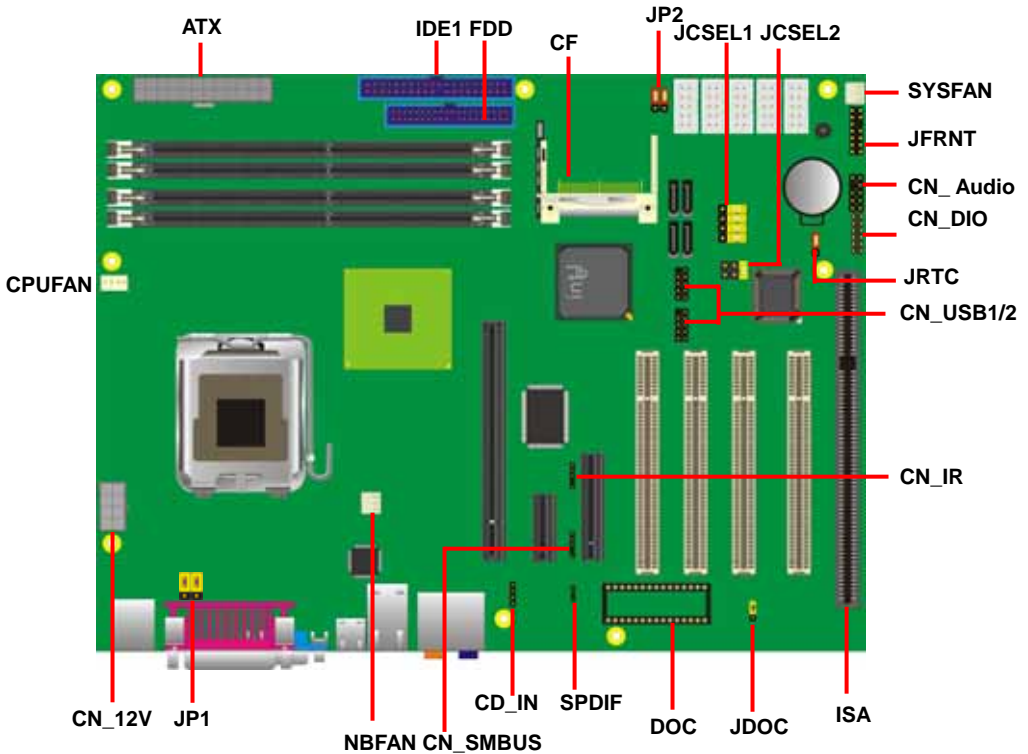

2.2 <Jumper Reference>

Jumper	Function
JRTC	CMOS Operating/Clear Setting
JCFSEL	Compact Flash Address Setting
JCSEL1	Setting RS232/422/485
JCSEL2	Setting RS232/422/485
JDOC	Setting address
JP1	Setting COM Port Voltage
JP2	Setting COM Port Voltage

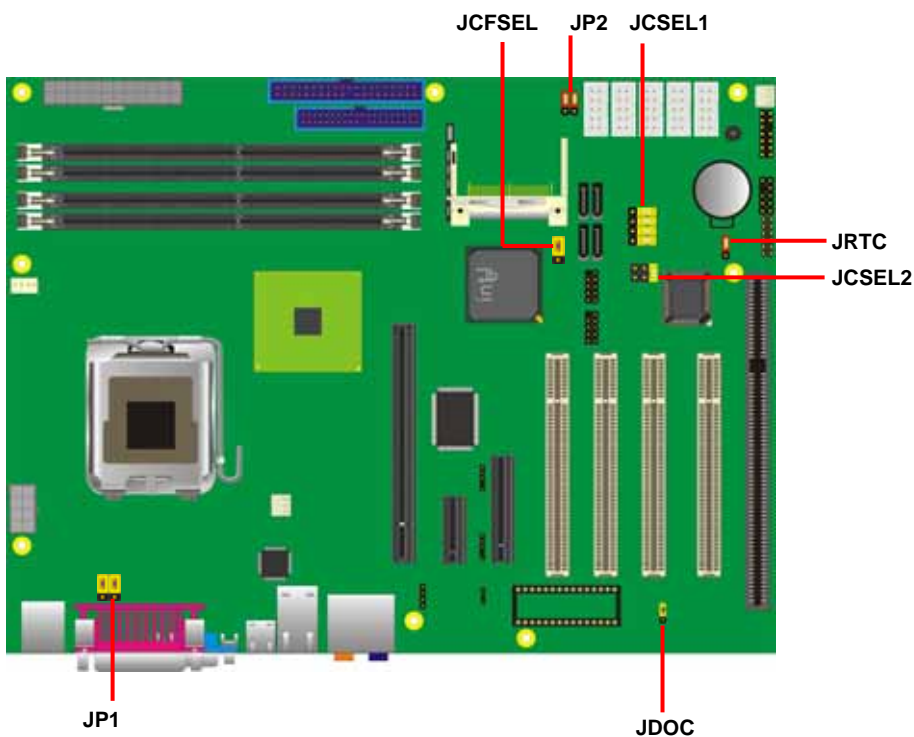

2.3 <Connector Reference>

2.3.1 <Internal Connectors>

Connector	Function	Remark
CPU	LGA775 CPU socket	Standard
DDRII1/2/3/4	240 -pin DDR2 SDRAM DIMM socket	Standard
IDE1	40-pin primary IDE connector	Standard
FDD	34-pin floppy connector	Standard
S_ATAII1/2/3/4	7-pin Serial ATA II connector	Standard
ATX	24-pin power supply connector	Standard
CN_12V	8-pin +12V additional power supply connector	Standard
CN_AUDIO	5 x 2-pin audio connector	Standard
CDIN	4-pin CD-ROM audio input connector	Standard
CN_DIO	6 x 2-pin digital I/O connector	Standard
CN_USB1/2	10-pin USB connector	Standard
CPUFAN	4-pin CPU cooler fan connector	Standard
SYSFAN	3-pin system cooler fan connector	Standard
NBFAN	3-pin Northbridge cooler fan connector	Standard
CN_IR	5-pin IrDA connector	Standard
CN_SMBUS	4-pin I ² C connector	Standard
JFRNT	14-pin front panel switch/indicator connector	Standard
SPDIF	Digital audio optical interface	Standard
DOC	32-pin DiskOnChip Socket	Standard

2.3.2 <External Connectors>

Connector	Function	Remark
VGA	DB15 VGA connector	Standard
USB	Dual USB Port	Standard
COM	DB7 Serial port connector	Standard
PS2	PS/2 Keyboard/Mouse connector	Standard
AUDIO	Audio connectors	Standard
USB_RJ45_A/B	Dual USB and RJ45 LAN connector	Standard

2.4 <CPU and Memory Setup>

2.4.1 <CPU installation>

P4LA has a LGA775 CPU socket onboard; please check following steps to install the processor properly.

Attention If P4LA need RMA, please Keep CPU socket cover on the CPU Socket.

Warring If CPU Socket internal Pin damage, We could not provide warranty.



Intel® Pentium 4 processor
Package type: 775 pin PLGA
L2 Cache: Up to 2M
FSB: 533/800/1066MHz (266MHz x 4)
Manufacturing: 90nm
Intel Hyper Threading Technology
And Dual core support

1. Lift this bar

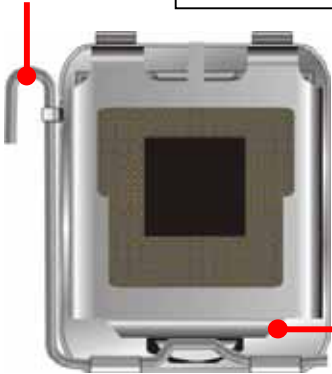

2. Uncover this plate



Check point

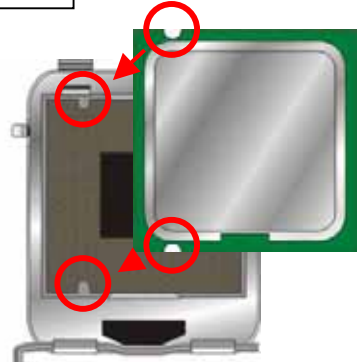

3. Place the CPU on the top of the pins



4. Lock this bar

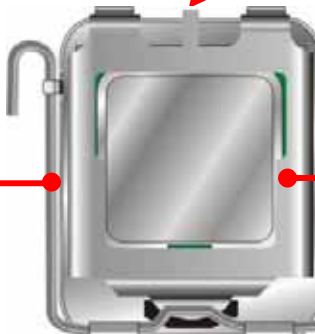

3. Cover this plate

Notice: Please place the CPU on the pins tenderly to avoid bending the pins

2.4.2 <Memory installation>

P4LA has Four 240-pin DDR2 DIMM support up to 3GB of memory capacity. The memory frequency supports 400/533/667MHz .Only Non-ECC memory is supported. **Dual-Channel technology** is supported while applying two same modules.

- DDRII4 (DIMM4)
- DDRII3 (DIMM3)
- DDRII2(DIMM2)
- DDRII1(DIMM1)

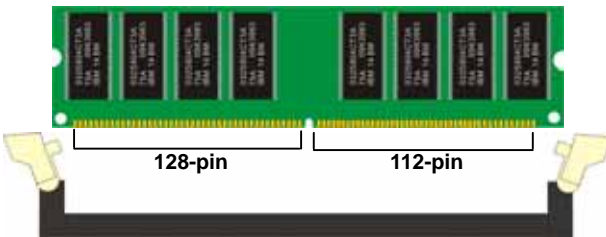
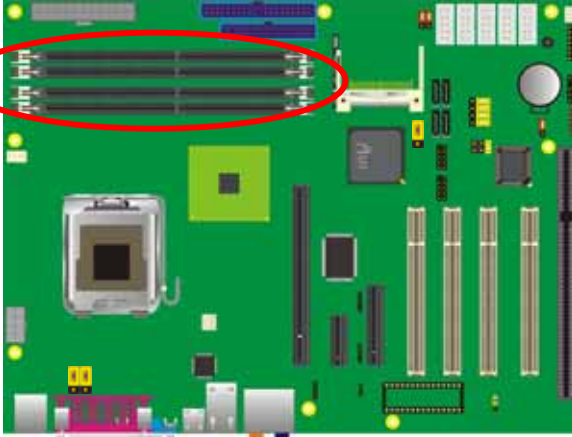

Please check the pin number to match the socket side well before installing memory module.

2.5 <CMOS Setup>

The board's data of CMOS can be setting in BIOS. If the board refuses to boot due to inappropriate CMOS settings, here is how to proceed to clear (reset) the CMOS to its default values.

Jumper: JRTC

Type: Onboard 3-pin jumper

JRTC	Mode
1-2	Clear CMOS
2-3	Normal Operation

Default setting

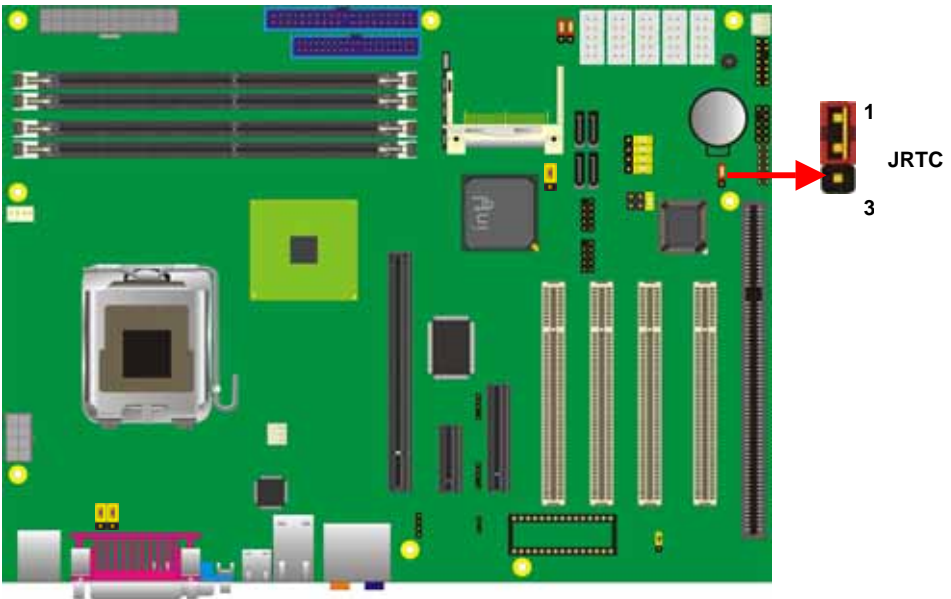

2.6 <Enhanced IDE interface>

The Intel® ICH7R (south bridge chip) supports one enhanced IDE interface, dual channel for two ATAPI devices with ATA100. Based on this function, **P4LA** has one 40-pin IDE connector with jumper selectable for pin-20 +5V supported.

The board supports 32-pin [DiskOnChip 2000](#) . The onboard 32-pin socket, DOC, supports DiskOnChip2000 single chip flash disk in 32-pin DIP JEDEC with jumper selectable address on jumper JDOC.

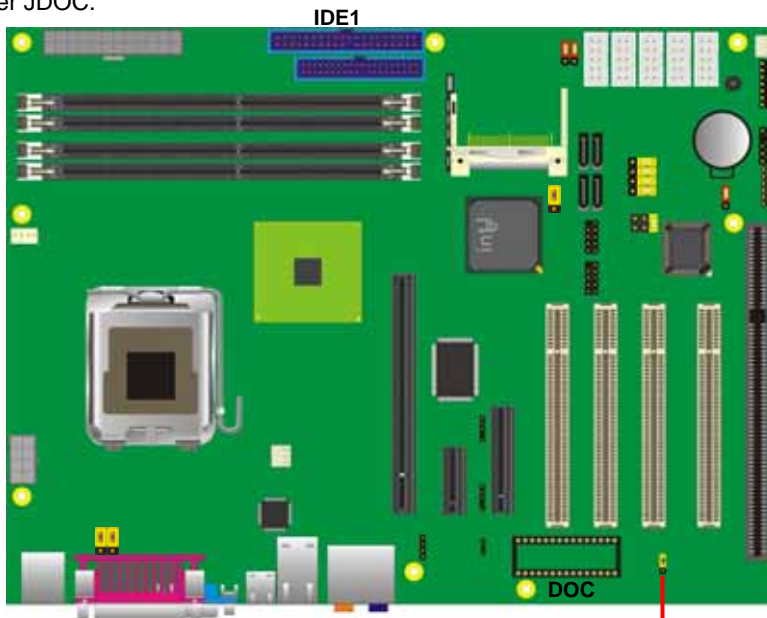

Jumper: **JDOC**

Type: onboard 3-pin header



JDOC	DiskOnChip Address
1-2	D800h
2-3	D000h

Default setting

Jumper: **JCFSEL**

Type: onboard 3-pin header



JCFSEL	Compact Flash Address Setting
1-2	Master
2-3	Slave

Default setting

2.7 <Serial ATA installation>

P4LA has four Serial ATA II interfaces with RAID function, the transfer rate of the Serial ATA II can be up to 300MB/s. Please go to <http://www.serialata.org/> for more about Serial ATA technology information. Based on Intel® ICH7R, it supports **Intel® Matrix Storage Technology** with combination of RAID 0,1,5 and 10. The main features of RAID on ICH7R are listed below:

1. Supports for up to RAID volumes on a single, two-hard drive RAID array.
2. Supports for two, two-hard drive RAID arrays on any of four Serial ATA ports.
3. Supports for Serial ATA ATAPI devices.
4. Supports for RAID spares and automatic rebuild.
5. Supports on RAID arrays, including NCQ and native hot plug.

For more information please visit Intel's official website.

For more about the system setup for Serial ATA, please check the chapter of SATA configuration.

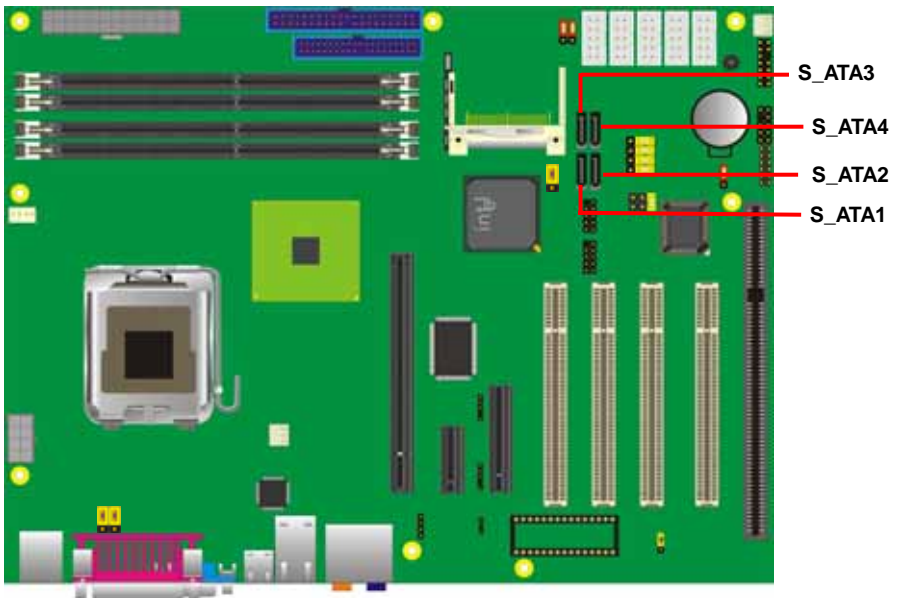

2.8 <Floppy Installation>

P4LA has one 34-pin floppy interface, it supports use floppy and powering from onboard, please follow up the steps below to install the device.

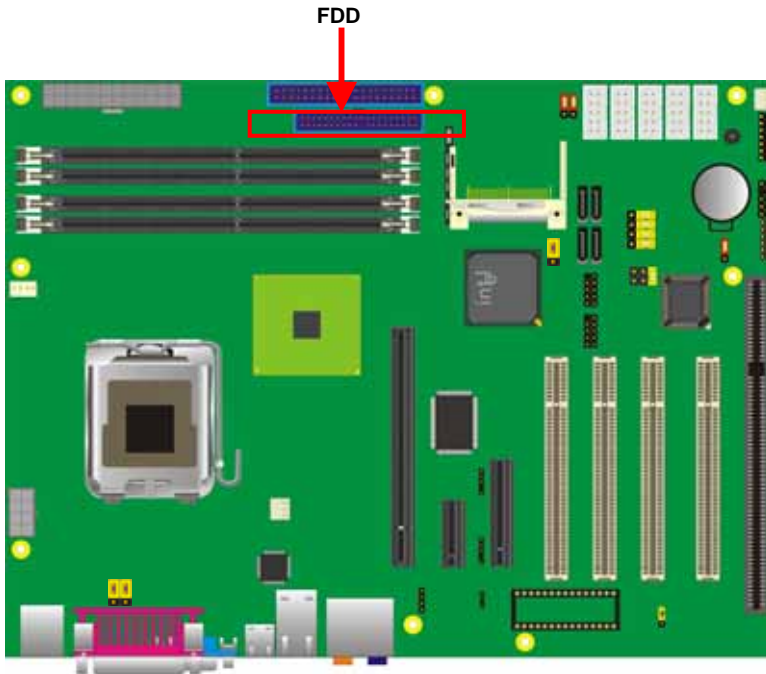

2.10 <Audio Installation>

The board integrates onboard audio interface with REALTEK ALC880 codec, with Intel next generation of audio standard as High Definition Audio, it offers more vivid sound and other advantages than former AC97 audio compliance.

The main specifications of ALC880 are:

- **High-performance DACs with 100dB S/N ratio**
- **8 DAC channels support 16/20/24-bit PCM format for 7.1 audio solution**
- **16/20/24-bit S/PDIF-OUT supports 44.1K/48K/96kHz sample rate**
- **Compatible with AC'97**
- **Meets Microsoft WHQL/WLP 2.0 audio requirements**

The board provides 7.1 channels audio phone jacks on rear I/O port, and amplified speaker out and Line-in/MIC-in ports for front I/O panel through optional cable.

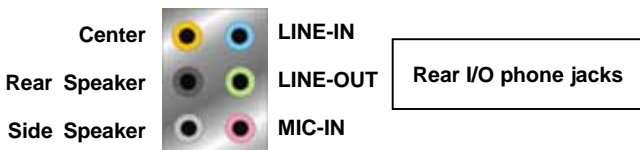
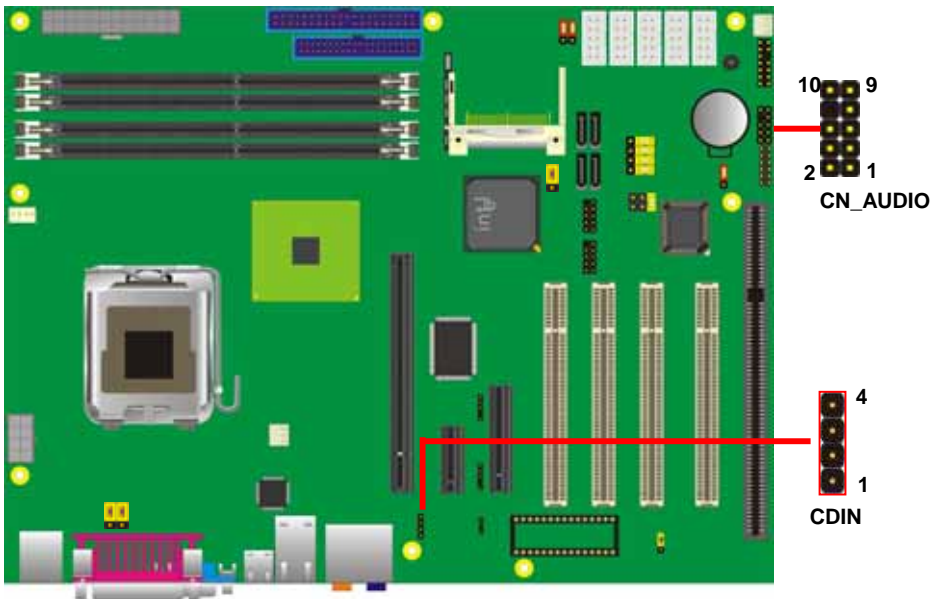

Connector: CN_AUDIO

Type: 10-pin (2 x 5) header (pitch = 2.00mm)

Pin	Description	Pin	Description
1	MIC_L	2	Ground
3	MIC_R	4	VCC
5	Front_R	6	MIC_JD
7	Sense	8	N/C
9	Front_L	10	Line_JD

Connector: CDIN

Type: 4-pin header (pitch = 2.54mm)

Pin	Description
1	CD – Left
2	Ground
3	Ground
4	CD – Right

Connector: SPDIF

Type: 4-pin header (pitch = 2.54mm)

Pin	Description
1	+5V
2	N/C
3	SPDIFO
4	Ground

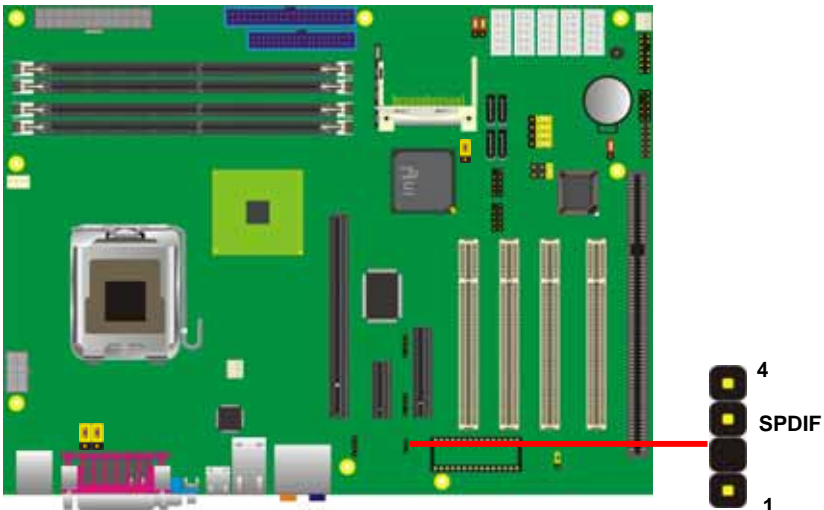

2.11 <Display Installation>

P4LA integrates with Intel® 945G GMCH for Intel Graphic Media Accelerator (GMA) 950 technology. It supports Intel® DVM (Dynamic Video Memory Technology) 3.0 for up to 224MB frame buffer size shared with system memory. With a 400MHz core and DirectX 9 and OpenGL acceleration, P4LA provides the powerful onboard graphics interface without additional graphic card. *(More information please visit Intel's website)*

For more information of configuring the frame buffer size, please check the chapter of video memory configuration.

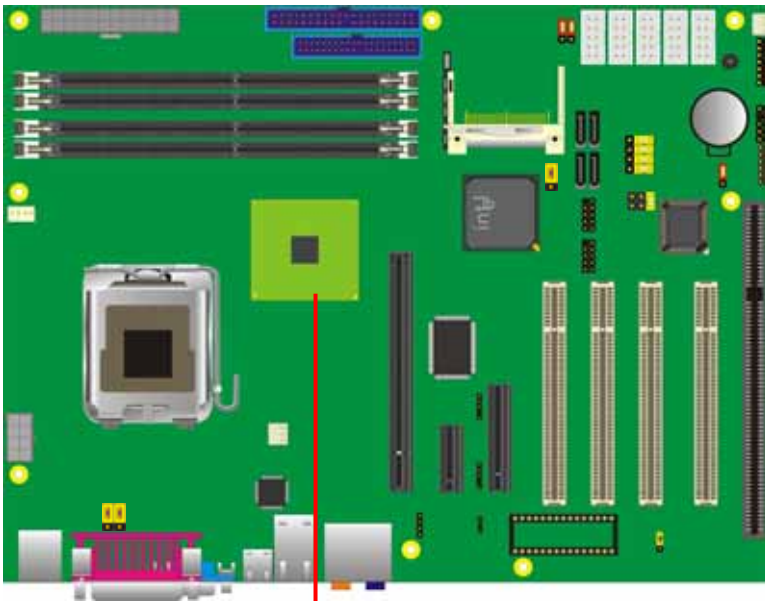

Intel 945G GMCH



VGA (DB15)

2.12 <USB Installation>

P4LA integrates eight USB2.0 ports. The specifications USB2.0 are listed below:

Interface	USB2.0
Controller	Intel ICH7R
Transfer Rate	Up to 480Mb/s

The Intel® ICH7R contains an Enhanced Host Controller Interface (EHCI) and four Universal Host Controller Interfaces (UHCI), it can determine whether your connected device is for USB1.1 or USB2.0, and change the transfer rate automatically.



USB

Connector: **CN_USB1/2**

Type: 10-pin (5 x 2) header for USB1/2 Ports

Pin	Description	Pin	Description
1	VCC	2	VCC
3	Data0-	4	Data1-
5	Data0+	6	Data1+
7	Ground	8	Ground
9	Ground	10	N/C

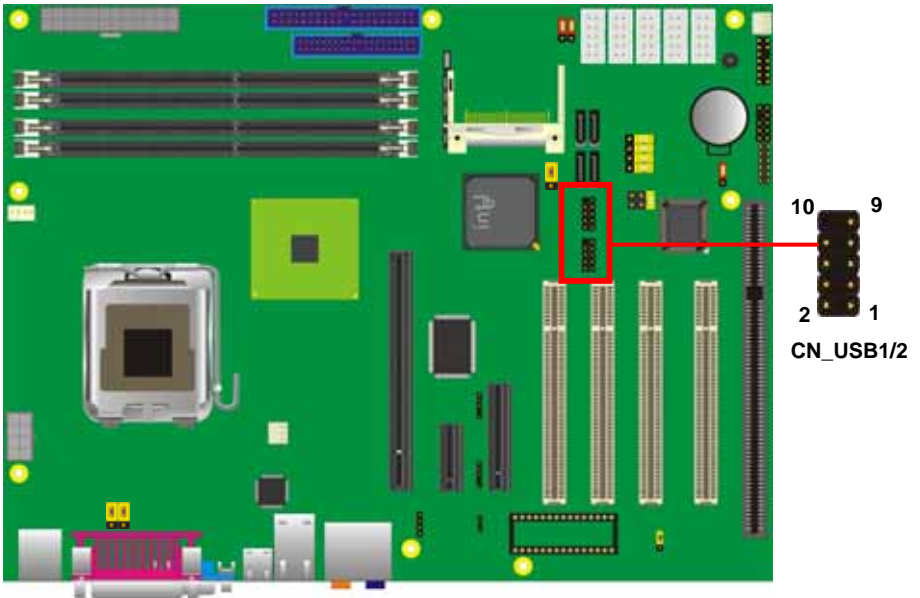

2.13 <Power and Fan Installation>

The P4LA provides a standard ATX power supply with **24-pin** ATX connector and additional 12V connector, and the board provides one **4-pin** fan connectors supporting smart fan for CPU cooler and two 3-pin cooler fan connectors for system and Northbridge chip. The 8-pin additional power connector is necessary for CPU powering; please connect this well before you finishing the system setup.

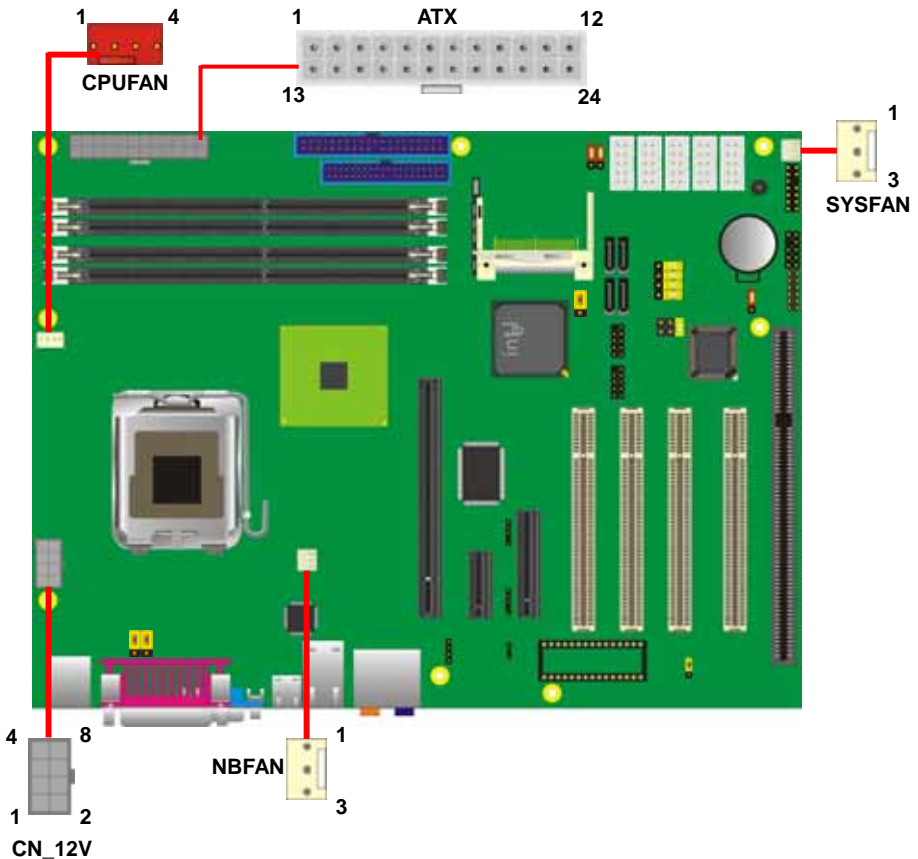

Connector: **ATX**

Type: 24-pin ATX power connector

PIN assignment			
1	3.3V	13	3.3V
2	3.3V	14	-12V
3	GND	15	GND
4	5V	16	PS_ON
5	GND	17	GND
6	5V	18	GND
7	GND	19	GND
8	PW_OK	20	-5V
9	5V_SB	21	5V
10	12V	22	5V
11	12V	23	5V
12	3.3V	24	GND

Connector: **CN_12V**

Type: 8-pin standard Pentium 4 additional +12V power connector

Pin	Description	Pin	Description
1	Ground	2	+12V
3	Ground	4	+12V
5	Ground	6	+12V
7	Ground	8	+12V

Connector: **CPUFAN**

Type: 4-pin fan wafer connector

Pin	Description	Pin	Description
1	Ground	2	+12V
3	Fan Speed Detection	4	Sense

Connector: **NBFAN, SYSFAN**

Type: 3-pin fan wafer connector

Pin	Description	Pin	Description	Pin	Description
1	Ground	2	+12V	3	Sense

2.14 <GPIO interface>

The board provides a programmable 8-bit digital I/O interface, and a SMBus (System management bus) interface for control panel application.

Connector: **CN_DIO**

Type: onboard 2 x 6-pin header, pitch=2.0mm

Pin	Description	Pin	Description
1	Ground	2	Ground
3	GP10	4	GP14
5	GP11	6	GP15
7	GP12	8	GP16
9	GP13	10	GP17
11	VCC	12	+12V

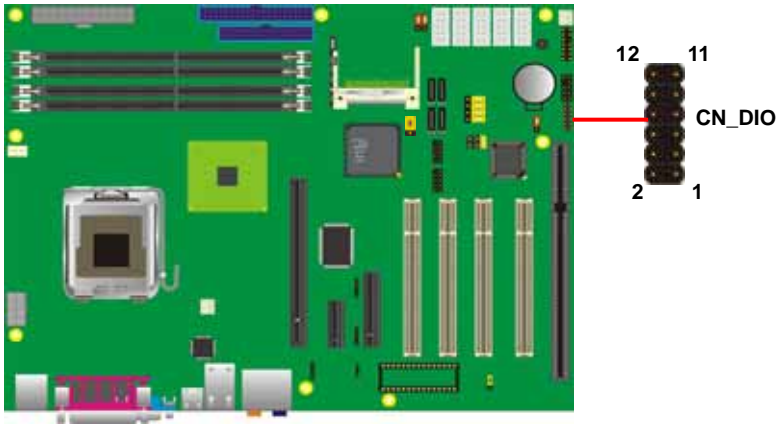

W83627THG	Assignment	CN_DIO
PIN 121	GPSA2/GP17	PIN 10
PIN 122	GPSB2/GP16	PIN 8
PIN 123	GPY1/GP15	PIN 6
PIN 124	GPY2/P16/GP14	PIN 4
PIN 125	GPX2/P15/GP13	PIN 9
PIN 126	GPX1/P14/GP12	PIN 7
PIN 127	GPSB1/P13/GP11	PIN 5
PIN 128	GPSA1/P12/GP10	PIN 3

2.15 <Serial Port>

The board has one RS232 serial ports on real I/O panel, and five onboard serial port .

COM2 Support RS232/422/485. Jump setting please refer to Page 57

Internal Serial port

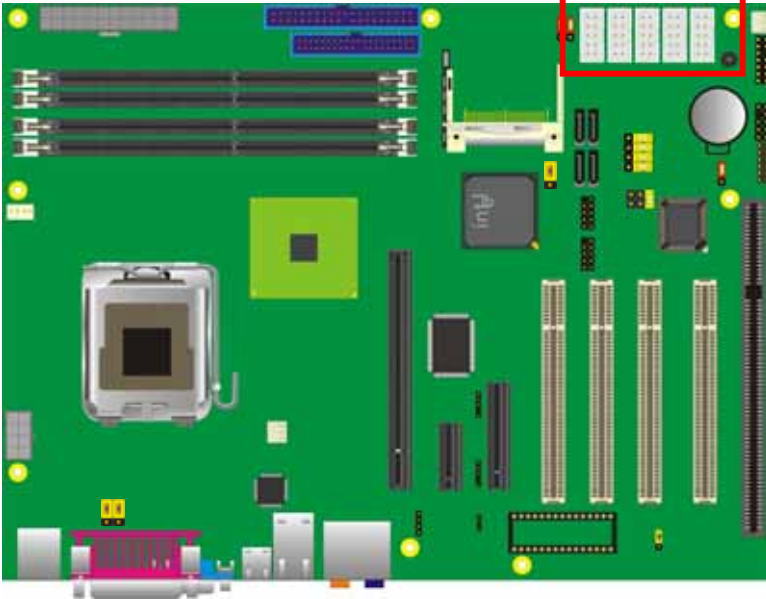

This Pin header provide +5V/+12V for COM1/COM2 Pin1,Pin 9.

Jumper: **JP1/2**

Type: onboard 6-pin header



Pin	Description	Pin	Description
1	VCC	2	+12V
3	COM1/2 pin1	4	COM1/2 pin9
5	MDCD1-	6	MR12-



External Serial port

2.16 <Switch and Indicator>

The **JFRNT** provides front control panel of the board, such as power button, reset and beeper, etc. Please check well before you connecting the cables on the chassis.

Connector: **JFRNT**

Type: onboard 14-pin (2 x 7) 2.54-pitch header

Function	Signal	PIN		Signal	Function
IDE LED	HDLED+	1	2	PWDLED+	Power LED
	HDLED-	3	4	N/C	
Reset	Reset+	5	6	PWDLED-	Speaker
	Reset-	7	8	SPKIN+	
N/C		9	10	N/C	
Power	PWRBT+	11	12	N/C	
Button	PWRBT-	13	14	SPKIN-	

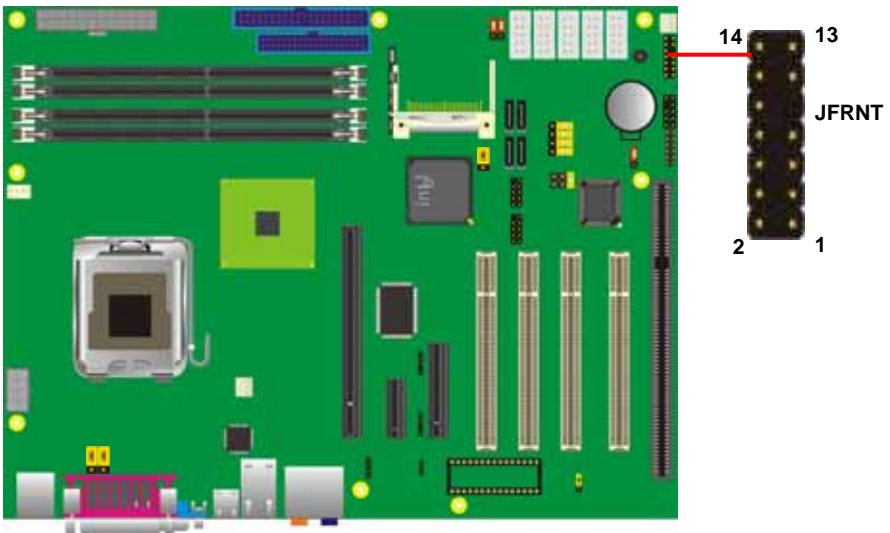

2.17 <Expansion Interface>

P4LA has one 16x , 4x and 1x PCI-Express slot .PCI-Express is the last expansion interface technology, for its serial data transfer scheme, each lane will be up to 500MB/s (duplex), and the 16x (16 lanes) can be up to 8GB/s more than 2GB/s as AGP 8x bus transfer rate. The 16x slot can be also for 1x compatible use.

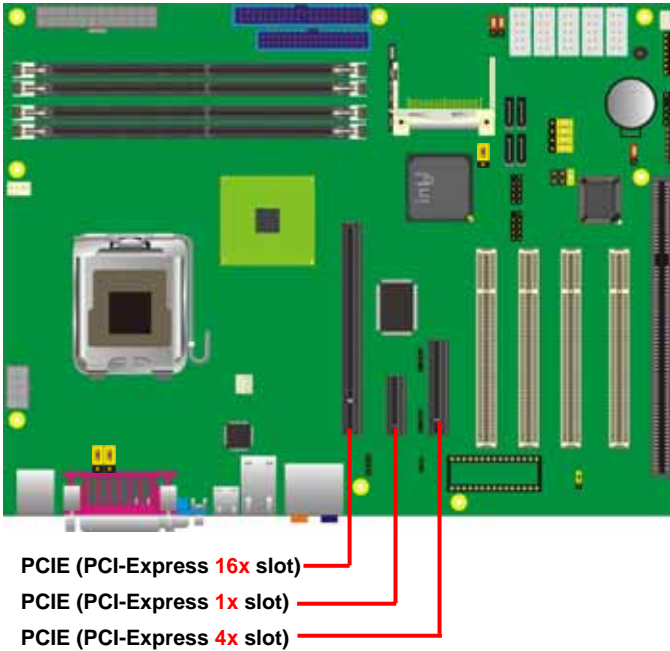

(This Page is Left for Blank)

Chapter 3 <System Configuration>

3.1 <SATA configuration>

Based on Intel® ICH7R Southbridge chip, the board supports 4 Serial ATA II ports; please follow the touring guide to setup your Serial ATA devices.

For **Windows 98/SE/ME**, Windows NT4.0 and DOS system, they only support up to 4 IDE devices including SATA devices, and Windows 2000/XP/Server2003 have no such limitation.

Operating System (Support Mode)	Parallel ATA	Serial ATA			
	Primary (2 Devices)	SATA1	SATA2	SATA3	SATA4
Windows 2000/XP (Enhance Mode)	○	○	○	○	○
Windows 98/ME/NT4.0					
Type 1 (Combine Mode)	○ (Primary)	X	○ (Secondary)	X	○ (Secondary)
Type 2 (Combine Mode)	○ (Secondary)	○ (Primary)	X	○ (Primary)	X
Type 3 (SATA only)	X	○ (Primary) (Master)	○ (Secondary) (Master)	○ (Primary) (Slave)	○ (Secondary) (Slave)

(Table 3.1.1)

The following BIOS setup screen shows how to setup your ATAPI devices with each mode.

SATA Mode:

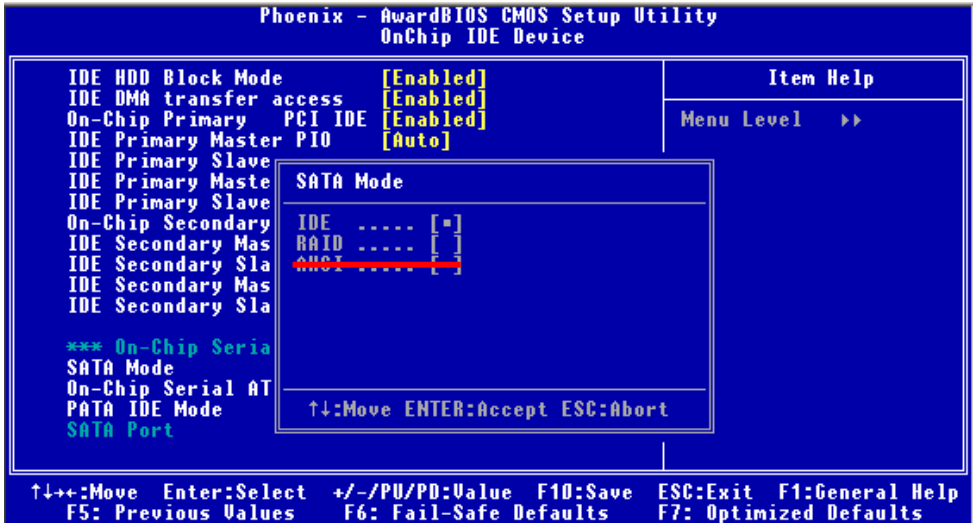

This option can let you select whether the Serial ATA hard drives would work under normal IDE mode or RAID mode. The RAID mode need more than one HDD is applied.

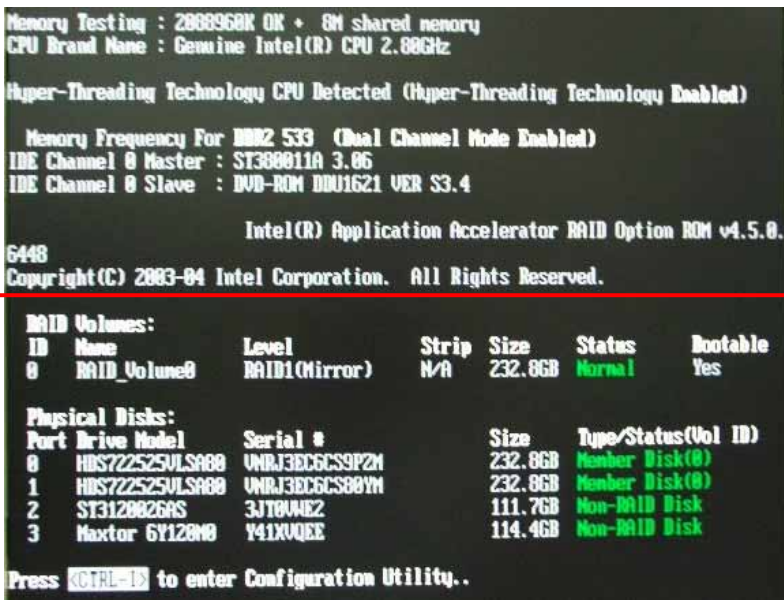

Once you enable the RAID mode, the boot-up screen would pop up the RAID configuration option for setup.

On-Chip Serial ATA mode:



This option can let you select operation modes of Serial ATA drives.

Disabled: To disable the onboard Serial ATA controller.

Auto: To allow the system select the optimized mode automatically.

Combined mode: PATA and SATA work as two channels for supporting two drives on each channel.

Enhanced mode: Max supported of the PATA and SATA for up to 6 drives.

SATA Only: To disable the PATA and only apply the SATA drives.

Notice: The Combined mode and Enhanced mode are supported depends on your operating system, please check **page35** for relative information.

3.2 <SATA RAID Configuration>

The board integrates Intel® ICH7R with RAID function for Serial ATA II drives, and supports the configurations below:

RAID 0 (Striping): Two hard drives operating as one drive for optimized data R/W performance. It needs two unused drives to build this operation.

RAID 1 (Mirroring): Copies the data from first drive to second drive for data security, and if one drive fails, the system would access the applications to the workable drive. It needs two unused drives or one used and one unused drive to build this operation. The second drive must be the same or larger size than first one.

RAID 5 (striping with parity)

A RAID 5 array contains three or more hard drives where the data is divided into manageable blocks called strips. Parity is a mathematical method for recreating data that was lost from a single drive, which increases fault-tolerance. The data and parity are striped across all the hard drives in the array. The parity is striped in a rotating sequence to reduce bottlenecks associated with the parity calculations.

RAID 10 (RAID 0+1)

A RAID 10 array uses four hard drives to create a combination of RAID levels 0 and 1. The data is striped across a two-drive array forming the RAID 0 component. Each of the drives in the RAID 0 array is then mirrored by a RAID 1 component.

Intel Matrix Storage Technology: This technology would allow you to use **RAID 0+1** mode on only two drives (4 drives needed on traditional RAID 0+1). It will create two partitions on each hard drive to simulate **RAID 0** and **RAID 1**. It also can let you modify the partition size without re-formatted.

For more information of Intel Matrix Storage Technology, please visit Intel's website.

If you need to install an operation system on the RAID set, please use the driver disk attached in the package when it informs you to obtain the RAID drivers.

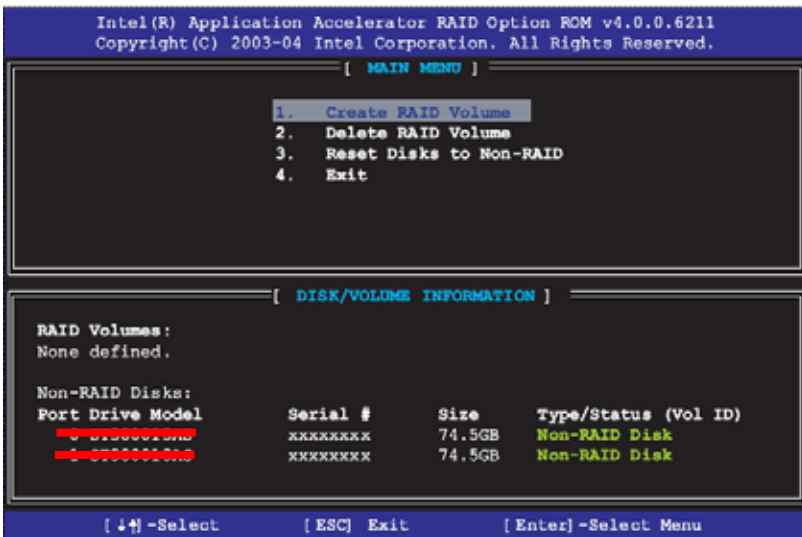

Please press <CTRL+I> to enter the RAID configuration menu.

You can setup the RAID under operation system for Microsoft® Windows XP SP1 or Windows 2000 SP4 version, please install the Intel® Application Accelerator Ver.4.5 later to support RAID configuration with Intel® Matrix Storage Technology.

1. After installing Intel Application Accelerator, please execute Intel® Storage Utility.

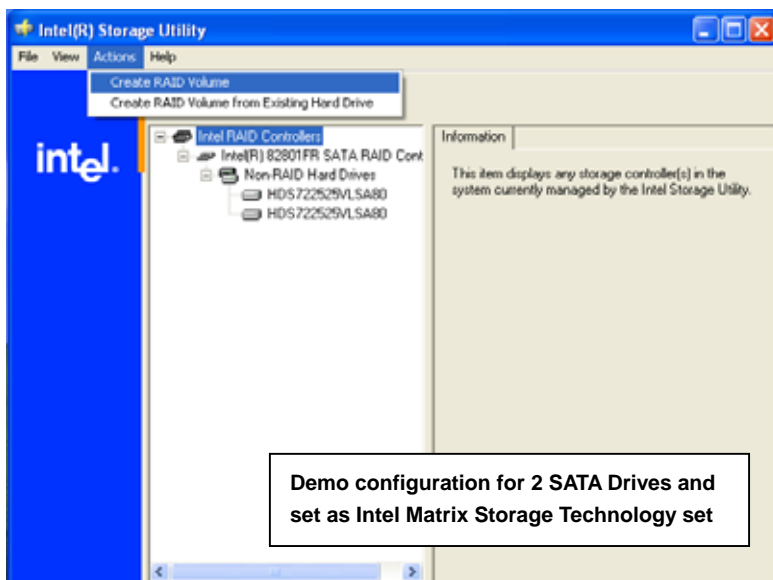

2. Select Actions to Create RAID Volume

Rename the Volume name

Select RAID Level as 0

Left as default

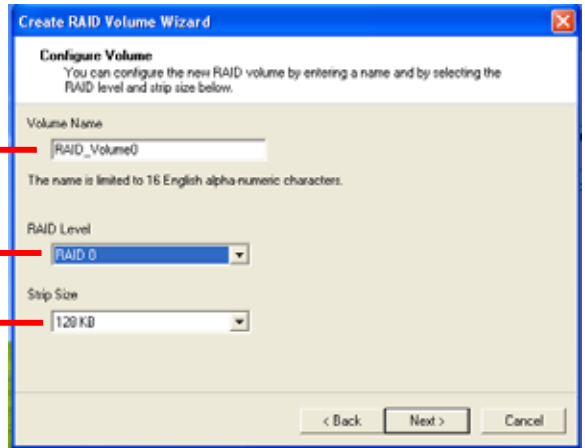

3. Please select two hard drives to prepare to set the RAID volume

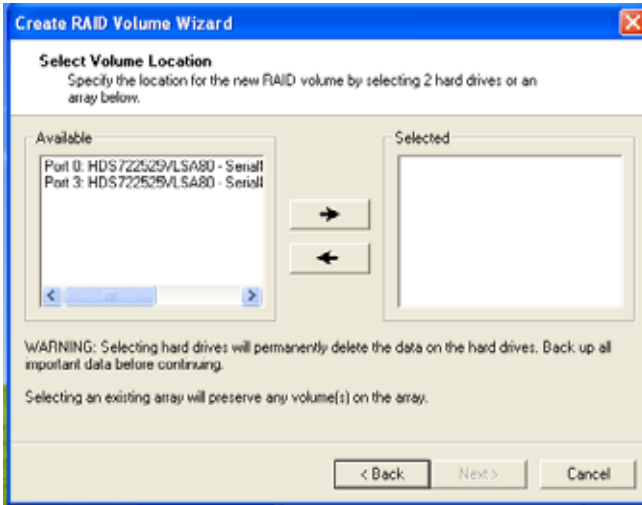

4. Specify the Volume size

Tune this bar to specify the volume size, if you specify the volume size lower than maximum, you can create a second volume for another RAID set. (Make RAID 0+1 on only two hard drives)

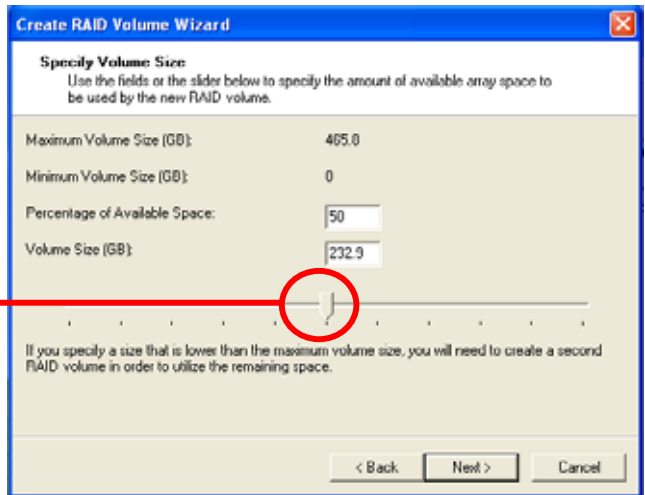

5. Repeat the step 1 to create second volume as RAID Level 1.



For other configuration set please click Help on tool bar.

3.3 <Audio Configuration>

The board integrates Intel® ICH7R with REALTEK® ALC880 codec. It can support 7.1 channel sound under system configuration. Please follow the steps below to setup your sound system.

1. Install REALTEK AC97 Audio driver.



2. Launch the control panel and Sound Effect Manager.
3. Select Speaker Configuration



4. Select the sound mode to meet your speaker system.

3.4 <Video Memory Setup>

Based on Intel® 945G chipset with GMA (Graphic Media Accelerator) 950, the board supports Intel® DVMT (Dynamic Video Memory Technology) 3.0, which would allow the video memory be triggered up to 224MB.

To support DVMT, you need to install the Intel GMA 950 Driver with supported OS.

BIOS Setup:

On-Chip Video Memory Size: This option combines three items below for setup.

On-Chip Frame Buffer Size:

This item can let you select video memory which been allocated for legacy VGA and SVGA graphics support and compatibility. The available option is **1MB** and **224MB**.

DVMT Memory Size:

This item can let you select a maximum size of dynamic amount usage of video memory, the system would configure the video memory depends on your application, this item is strongly recommend to be selected as **MAX DVMT**.



System Memory	On-Chip Frame Buffer Size	Fixed Memory Size	DVMT Memory Size	Total Graphic Memory
128MB~255MB	1MB	32MB	0MB	32MB
	1MB	0MB	32MB	32MB
	8MB	32MB	0MB	32MB
	8MB	0	32MB	32MB
256MB~511MB	1MB	64MB	0MB	64MB
	1MB	0	64MB	64MB
	1MB	128MB	0MB	128MB
	1MB	0	128MB	128MB
	1MB	64MB	64MB	128MB
	8MB	64MB	0MB	64MB
	8MB	0	64MB	64MB
	8MB	128MB	0MB	128MB
	8MB	0	128MB	128MB
	8MB	64MB	64MB	128MB
512MB upper	1MB	64MB	0	64MB
	1MB	0	64MB	64MB
	1MB	128MB	0	128MB
	1MB	0	128MB	128MB
	1MB	64MB	64MB	128MB
	1MB	0	224MB	224MB
	8MB	64MB	0	64MB
	8MB	0	64MB	64MB
	8MB	128MB	0	128MB
	8MB	0	128MB	128MB
	8MB	64MB	64MB	128MB
8MB	0	224MB	224MB	

Notice:

1. The On-Chip Frame Buffer Size would be included in the Fixed Memory.
2. Please select the memory size according to this table.

3.5 <Display Properties Setting>

Based on Intel 945G GMCH with GMA 950 (Graphic Media Accelerator), the board supports two DACs for display device as different resolution and color bit.

Please install the Intel Graphic Driver before you starting setup display devices.

1. Click right button on the desktop to lunch **display properties**

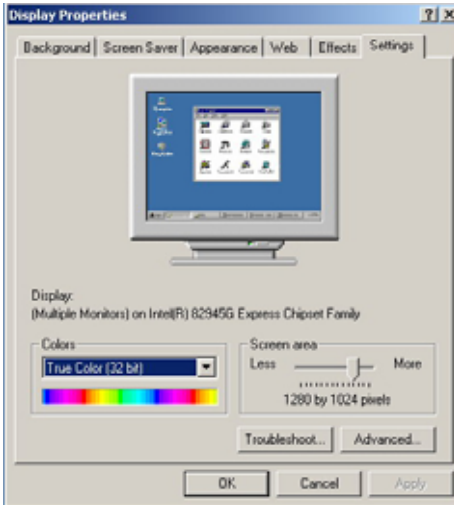

2. Click **Advanced** button for more specificity setup.

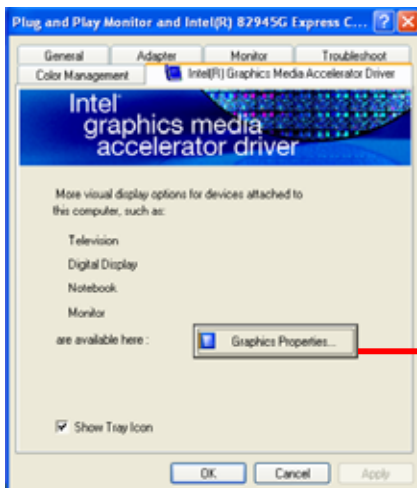

Click **Graphics Properties...** for advanced setup

3. This setup options can let you define each device settings.

Notice: The dual display needs PCIE-SDVO module to support more than one display devices.

Click **Digital Display** to setup the DVI monitor for Colors, and Resolution

Click **Monitor** to setup the CRT monitor for Colors, Resolution and Refresh Rate

Click **Extended Desktop** to setup the dual display mode as different screen display

Click **Intel® Dual Display Clone** to setup the dual display mode as same screen



Set the main display device here

Chapter 4 <BIOS Setup>

The motherboard uses the Award BIOS for the system configuration. The Award BIOS in the single board computer is a customized version of the industrial standard BIOS for IBM PC AT-compatible computers. It supports Intel x86 and compatible CPU architecture based processors and computers. The BIOS provides critical low-level support for the system central processing, memory and I/O sub-systems.

The BIOS setup program of the single board computer let the customers modify the basic configuration setting. The settings are stored in a dedicated battery-backed memory, NVRAM, retains the information when the power is turned off. If the battery runs out of the power, then the settings of BIOS will come back to the default setting.

The BIOS section of the manual is subject to change without notice and is provided here for reference purpose only. The settings and configurations of the BIOS are current at the time of print, and therefore they may not be exactly the same as that displayed on your screen.

To activate CMOS Setup program, press key immediately after you turn on the system. The following message "Press DEL to enter SETUP" should appear in the lower left hand corner of your screen. When you enter the CMOS Setup Utility, the Main Menu will be displayed as **Figure 4-1**. You can use arrow keys to select your function, press <Enter> key to accept the selection and enter the sub-menu.

Figure 4-1 CMOS Setup Utility Main Screen

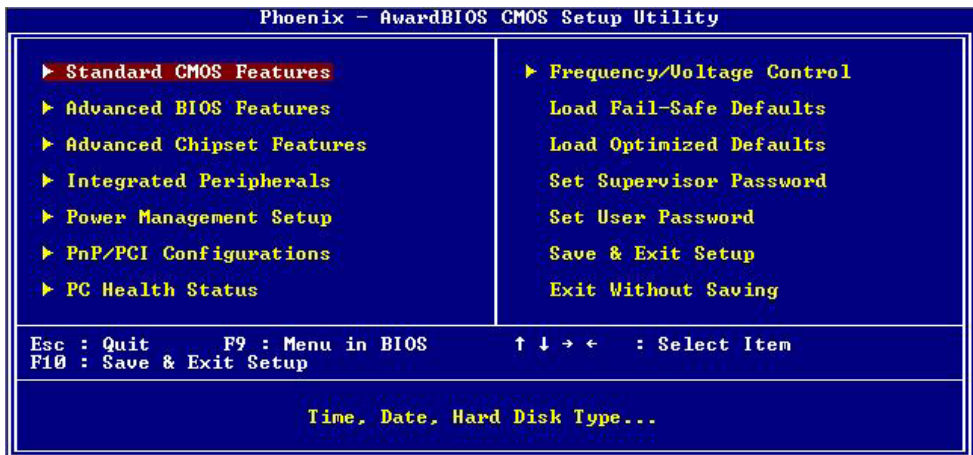

(This Page is Left for Blank)

Appendix A <I/O Port Pin Assignment>

A.1 IDE Port

Connector: IDE1

Type: 40-pin (20 x 2) box header



Pin	Description	Pin	Description
1	Reset	2	Ground
3	D7	4	D8
5	D6	6	D9
7	D5	8	D10
9	D4	10	D11
11	D3	12	D12
13	D2	14	D13
15	D1	16	D14
17	D0	18	D15
19	Ground	20	VCC
21	REQ	22	Ground
23	IOW-/STOP	24	Ground
25	IOR-/HDMARDY	26	Ground
27	IRDY/DDMARDY	28	IDE66#/IDE33
29	DACK-	30	Ground
31	IRQ	32	N/C
33	A1	34	CBLID
35	A0	36	A2
37	CS0 (MASTER CS)	38	CS1 (SLAVE CS)
39	LED ACT-	40	Ground

A.2 <Serial ATA Port>

Connector: S_ATA1/2/3/4

Type: 7-pin wafer connector

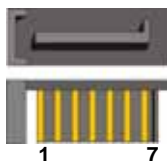

1	2	3	4	5	6	7
GND	RSATA_TXP1	RSATA_TXN1	GND	RSATA_RXN1	RSATA_RXP1	GND

A.3 <Floppy Port>

Connector: **FDD**

Type: 34-pin (2 x 17) 2.54-pitch header



Pin	Description	Pin	Description
1	Ground	2	DRIVE DENSITY SELECT 0
3	Ground	4	DRIVE DENSITY SELECT 1
5	Ground	6	N/C
7	Ground	8	INDEX-
9	Ground	10	MOTOR ENABLE A-
11	Ground	12	DRIVER SELECT B-
13	Ground	14	DRIVER SELECT A-
15	Ground	16	MOTOR ENABLE B-
17	Ground	18	DIRECTION-
19	Ground	20	STEP-
21	Ground	22	WRITE DATA-
23	Ground	24	WRITE GATE-
25	Ground	26	TRACK 0-
27	Ground	28	WRITE PROTECT-
29	Ground	30	READ DATA-
31	Ground	32	HEAD SELECT-
33	Ground	34	DISK CHANGE-

A.4 <IrDA Port>

Connector: **CN_IR**

Type: 5-pin header for SIR Ports

Pin	Description
1	VCC
2	N/C
3	IRRX
4	Ground
5	IRTX

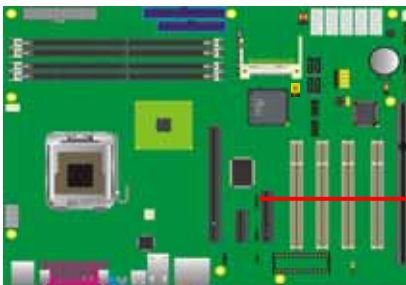

A.5 <Serial Port>

Connector: **COM1**

Type: 9-pin D-sub male connector on I/O Panel

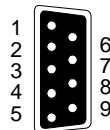

Pin	Description	Pin	Description
1	DCD	6	DSR
2	SIN	7	RTS
3	SO	8	CTS
4	DTR	9	RI
5	Ground		

Connector: **COM2/3/4/5/6**

Type: 9-pin D-sub male connector on bracket

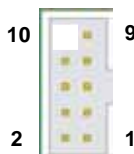

Pin	Description	Pin	Description
1	DCD-	6	DSR-
2	SIN-	7	RTS-
3	SO-	8	CTS-
4	DTR-	9	RI
5	Ground	10	N/C

A.6 <VGA Port>

Connector: **VGA**

Type: 15-pin D-sub female connector on I/O Panel

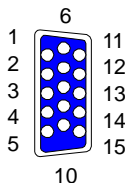

Pin	Description	Pin	Description	Pin	Description
1	RED	6	Ground	11	N/C
2	GREEN	7	Ground	12	5VCDA
3	BLUE	8	Ground	13	HSYNC
4	N/C	9	LVGA5V	14	VSYNC
5	Ground	10	Ground	15	5VCLK

A.7 <LAN Port>

Connector: **RJ45**

Type: RJ45 connector with LED on I/O Panel



Pin	1	2	3	4	5
Description	TRD0+	TRD0-	TRD1+	TRD1-	NC

Pin	6	7	8	9	10
Description	NC	TRD2+	TRD2-	TRD3+	TRD3-

A.8 <SMBus>

Connector: **CN_SMBUS**

Type: 4-pin SMBus connector

Pin	Description	Pin	Description
1	VCC	2	N/C
3	SMBDATA	4	SMBCLK
5	Ground		

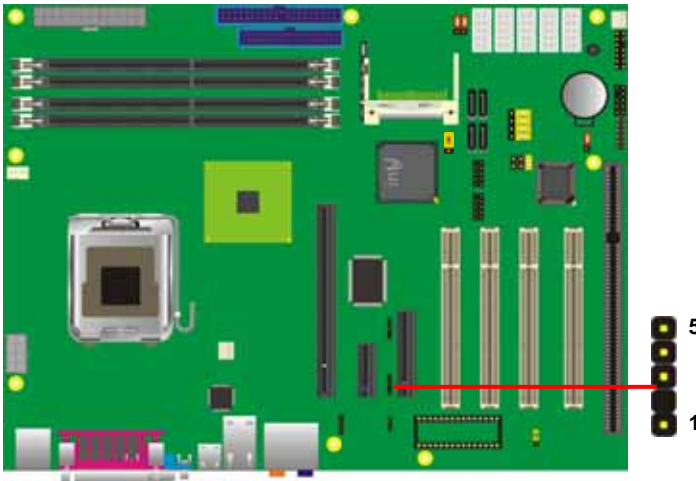

A.9 <LPT Port >



Connector : LPT

Type :26-Pin D-Sub female Connector on I/O Panel

Pin	Description	Pin	Description
1	-PSTB	2	PRO0
3	PRO1	4	PRO2
5	PRO3	6	PRO4
7	PRO5	8	PRO6
9	PRO7	10	ACK-
11	BUSY	12	PE
13	SLCT	14	AFD-
15	ERR-	16	INT-
17	SLIN-	18	Ground
19	Ground	20	I/O Ground
21	Ground	22	Ground
23	Ground	24	Ground
25	Ground	26	N/C

Appedix B <System Resources>

B1.<I/O Port Address Map>

[00000000 - 0000000F]	Direct memory access controller
[00000000 - 00000CF7]	PCI bus
[00000010 - 0000001F]	Motherboard resources
[00000020 - 00000021]	Programmable interrupt controller
[00000022 - 0000003F]	Motherboard resources
[00000040 - 00000043]	System timer
[00000044 - 0000005F]	Motherboard resources
[00000060 - 00000060]	Standard 101/102-Key or Microsoft Natural PS/2 Keyboard
[00000061 - 00000061]	System speaker
[00000062 - 00000063]	Motherboard resources
[00000064 - 00000064]	Standard 101/102-Key or Microsoft Natural PS/2 Keyboard
[00000065 - 0000006F]	Motherboard resources
[00000070 - 00000073]	System CMOS/real time clock
[00000074 - 0000007F]	Motherboard resources
[00000080 - 00000090]	Direct memory access controller
[00000091 - 00000093]	Motherboard resources
[00000094 - 0000009F]	Direct memory access controller
[000000A0 - 000000A1]	Programmable interrupt controller
[000000A2 - 000000BF]	Motherboard resources
[000000C0 - 000000DF]	Direct memory access controller
[000000E0 - 000000EF]	Motherboard resources
[000000F0 - 000000FF]	Numeric data processor
[000001F0 - 000001F7]	Primary IDE Channel
[00000274 - 00000277]	ISAPNP Read Data Port
[00000279 - 00000279]	ISAPNP Read Data Port
[000002E8 - 000002EF]	Communications Port (COM4)
[000002F8 - 000002FF]	Communications Port (COM2)
[00000378 - 0000037F]	Printer Port (LPT1)
[000003B0 - 000003BB]	Intel(R) 82945G Express Chipset Family
[000003C0 - 000003DF]	Intel(R) 82945G Express Chipset Family
[000003E8 - 000003EF]	Communications Port (COM3)
[000003F0 - 000003F5]	Standard floppy disk controller
[000003F6 - 000003F6]	Primary IDE Channel
[000003F7 - 000003F7]	Standard floppy disk controller
[000003F8 - 000003FF]	Communications Port (COM1)
[00000400 - 000004BF]	Motherboard resources

[000000F0 - 000000FF]	Numeric data processor
[000001F0 - 000001F7]	Primary IDE Channel
[00000274 - 00000277]	ISAPNP Read Data Port
[00000279 - 00000279]	ISAPNP Read Data Port
[000002E8 - 000002EF]	Communications Port (COM4)
[000002F8 - 000002FF]	Communications Port (COM2)
[00000378 - 0000037F]	Printer Port (LPT1)
[000003B0 - 000003BB]	Intel(R) 82945G Express Chipset Family
[000003C0 - 000003DF]	Intel(R) 82945G Express Chipset Family
[000003E8 - 000003EF]	Communications Port (COM3)
[000003F0 - 000003F5]	Standard floppy disk controller
[000003F6 - 000003F6]	Primary IDE Channel
[000003F7 - 000003F7]	Standard floppy disk controller
[000003F8 - 000003FF]	Communications Port (COM1)
[00000400 - 000004BF]	Motherboard resources
[000004D0 - 000004D1]	Motherboard resources
[00000500 - 0000051F]	Intel(R) 82801GB SMBus Controller - 27DA
[00000778 - 0000077B]	Printer Port (LPT1)
[00000800 - 0000087F]	Motherboard resources
[00000880 - 0000088F]	Motherboard resources
[00000A79 - 00000A79]	ISAPNP Read Data Port
[00000D00 - 0000FFFF]	PCI bus
[00009000 - 00009FFF]	Intel(R) 82801GB PCI Express Root Port - 27D6
[0000A000 - 0000AFFF]	Intel(R) 82801GB PCI Express Root Port - 27D4
[0000B000 - 0000BFFF]	Intel(R) 82801GB PCI Express Root Port - 27D2
[0000C000 - 0000CFFF]	Intel(R) 82801GB PCI Express Root Port - 27D0
[0000D000 - 0000DFFF]	Intel(R) 82801GB PCI Express Root Port - 27E2
[0000DE00 - 0000DEFF]	Marvell Yukon 88E8052 PCI-E ASF Gigabit Ethernet Controller
[0000E000 - 0000EFFF]	Intel(R) 82801GB PCI Express Root Port - 27E0
[0000F500 - 0000F50F]	Intel(R) 82801GB Serial ATA Storage Controllers - 27C0
[0000F600 - 0000F603]	Intel(R) 82801GB Serial ATA Storage Controllers - 27C0
[0000F700 - 0000F707]	Intel(R) 82801GB Serial ATA Storage Controllers - 27C0
[0000F800 - 0000F803]	Intel(R) 82801GB Serial ATA Storage Controllers - 27C0
[0000F900 - 0000F907]	Intel(R) 82801GB Serial ATA Storage Controllers - 27C0
[0000FA00 - 0000FA0F]	Intel(R) 82801GB Ultra ATA Storage Controllers - 27DF
[0000FB00 - 0000FB1F]	Intel(R) 82801GB USB Universal Host Controller - 27CB
[0000FC00 - 0000FC1F]	Intel(R) 82801GB USB Universal Host Controller - 27CA
[0000FD00 - 0000FD1F]	Intel(R) 82801GB USB Universal Host Controller - 27C9
[0000FE00 - 0000FE1F]	Intel(R) 82801GB USB Universal Host Controller - 27C8
[0000FF00 - 0000FF07]	Intel(R) 82945G Express Chipset Family

B2.<Memory Address Map>

[00000000 - 0009FFFF]	System board
[000A0000 - 000BFFFF]	Intel(R) 82945G Express Chipset Family
[000A0000 - 000BFFFF]	PCI bus
[000C0000 - 000DFFFF]	PCI bus
[000CAC00 - 000CBFFF]	System board
[000E0000 - 000EFFFF]	System board
[000F0000 - 000F7FFF]	System board
[000F8000 - 000FBFFF]	System board
[000FC000 - 000FFFFF]	System board
[00100000 - 3F6DFFFF]	System board
[3F6E0000 - 3F6FFFFF]	System board
[3F700000 - FEBFFFFF]	PCI bus
[D0000000 - DFFFFFFF]	Intel(R) 82945G Express Chipset Family
[E0000000 - EFFFFFFF]	Motherboard resources
[FD100000 - FD1FFFFF]	Intel(R) 82801GB PCI Express Root Port - 27D0
[FD400000 - FD4FFFFF]	Intel(R) 82801GB PCI Express Root Port - 27D0
[FD500000 - FD5FFFFF]	Intel(R) 82801GB PCI Express Root Port - 27E2
[FD600000 - FD6FFFFF]	Intel(R) 82801GB PCI Express Root Port - 27E2
[FD6FC000 - FD6FFFFF]	Marvell Yukon 88E8052 PCI-E ASF Gigabit Ethernet Controller
[FD700000 - FD7FFFFF]	Intel(R) 82801GB PCI Express Root Port - 27E0
[FD800000 - FD8FFFFF]	Intel(R) 82801GB PCI Express Root Port - 27E0
[FD900000 - FD9FFFFF]	Intel(R) 82801GB PCI Express Root Port - 27D6
[FDA00000 - FDAFFFFF]	Intel(R) 82801GB PCI Express Root Port - 27D6
[FDB00000 - FDBFFFFF]	Intel(R) 82801GB PCI Express Root Port - 27D4
[FDC00000 - FDCFFFFF]	Intel(R) 82801GB PCI Express Root Port - 27D4
[FDD00000 - FDDFFFFF]	Intel(R) 82801GB PCI Express Root Port - 27D2
[FDE00000 - FDEFFFFF]	Intel(R) 82801GB PCI Express Root Port - 27D2
[FDF00000 - FDF7FFFF]	Intel(R) 82945G Express Chipset Family
[FDF80000 - FDFBFFFF]	Intel(R) 82945G Express Chipset Family
[FDFF8000 - FDFFBFFF]	Microsoft UAA Bus Driver for High Definition Audio
[FDFFE000 - FDFFE3FF]	Intel(R) 82801GB Serial ATA Storage Controllers - 27C0
[FDFFF000 - FDFFF3FF]	Intel(R) 82801GB USB2 Enhanced Host Controller - 27CC
[FEC00000 - FEC0FFFF]	System board
[FED13000 - FED1DFFF]	System board
[FED20000 - FED8FFFF]	System board
[FEE00000 - FEE0FFFF]	System board
[FFB00000 - FFB7FFFF]	System board
[FFB80000 - FFBFFFFF]	Intel(r) 82802 Firmware Hub Device
[FFF00000 - FFFFFFFF]	System board

B3.<System IRQ & DMA Resources>

DMA :

- 2 Standard floppy disk controller
- 4 Direct memory access controller

IRQ :

- (ISA) 0 System timer
- (ISA) 1 Standard 101/102-Key or Microsoft Natural PS/2 Keyboard
- (ISA) 3 Communications Port (COM2)
- (ISA) 4 Communications Port (COM1)
- (ISA) 6 Standard floppy disk controller
- (ISA) 8 System CMOS/real time clock
- (ISA) 9 Microsoft ACPI-Compliant System
- (ISA) 10 Communications Port (COM3)
- (ISA) 11 Communications Port (COM4)
- (ISA) 12 PS/2 Compatible Mouse
- (ISA) 13 Numeric data processor
- (ISA) 14 Primary IDE Channel
- (PCI) 5 Intel(R) 82801GB SMBus Controller - 27DA
- (PCI) 16 Intel(R) 82801GB PCI Express Root Port - 27D0
- (PCI) 16 Intel(R) 82801GB PCI Express Root Port - 27E0
- (PCI) 16 Intel(R) 82801GB USB Universal Host Controller - 27CB
- (PCI) 16 Intel(R) 82945G Express Chipset Family
- (PCI) 16 Microsoft UAA Bus Driver for High Definition Audio
- (PCI) 17 Intel(R) 82801GB PCI Express Root Port - 27D2
- (PCI) 17 Intel(R) 82801GB PCI Express Root Port - 27E2
- (PCI) 17 Marvell Yukon 88E8052 PCI-E ASF Gigabit Ethernet Controller
- (PCI) 18 Intel(R) 82801GB PCI Express Root Port - 27D4
- (PCI) 18 Intel(R) 82801GB USB Universal Host Controller - 27CA
- (PCI) 19 Intel(R) 82801GB PCI Express Root Port - 27D6
- (PCI) 19 Intel(R) 82801GB USB Universal Host Controller - 27C9
- (PCI) 21 Intel(R) 82801GB Serial ATA Storage Controllers - 27C0
- (PCI) 23 Intel(R) 82801GB USB Universal Host Controller - 27C8
- (PCI) 23 Intel(R) 82801GB USB2 Enhanced Host Controller - 27CC

Appendix B <How to setting RS-422/485>

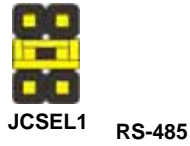

Appedix C <Flash BIOS>

C.1 BIOS Auto Flash Tool

The board is based on Award BIOS and can be updated easily by the BIOS auto flash tool. You can download the tool online at the address below:

<http://www.award.com>

<http://www.commell.com.tw/support/support.htm>

File name of the tool is "awdf flash.exe", it's the utility that can write the data into the BIOS flash ship and update the BIOS.

C.2 Flash Method

1. Please make a bootable floppy disk.
2. Get the last .bin files you want to update and copy it into the disk.
3. Copy awardflash.exe to the disk.
4. Power on the system and flash the BIOS. (Example: C:/ awardflash XXX.bin)
5. Re-star the system.

Any question about the BIOS re-flash please contact your distributors or visit the web-site at below:

<http://www.commell.com.tw/support/support.htm>T

Appendix D <Programming GPIO's>

The GPIO can be programmed with the MSDOS debug program using simple IN/OUT commands. The following lines show an example how to do this.

```

GPIO0.....GPIO7  bit0.....bit7
-o 2E 87                ;enter configuration
-o 2E 87
-o 2E 29
-o 2E 40                ;enale GPIO function
-o 2E 07
-o 2E 07                ;enable GPIO configuration
-o 2E F0
-o 2F xx                ;set GPIO as input/output; set '1' for input,'0' for
output
-o 2E F1
-o 2F xx                ;if set GPIO's as output,in this register its value can
                        be set

Optional :
-o 2E F2
-o 2F xx                ; Data inversion register ; '1' inverts the current valus
                        of the bits ,'0' leaves them as they are
-o 2E 30
-o 2F 01                ; active GPIO's

```

For further information ,please refer to Winbond W83627THF datasheet.

Appendix E <What Dog timer Setting >

The watchdog timer makes the system auto-reset while it stops to work for a period. The integrated watchdog timer can be setup as system reset mode by program.

Timeout Value Range

- 1 to 255
- Second or Minute

Program Sample

Watchdog timer setup as system reset with 5 second of timeout

```

2E, 87
2E, 87
2E, 07
2F, 08      Logical Device 8
2E, 30      Activate
2F, 01
2E, F5      Set as Second*
2F, 00
2E, F6      Set as 5
2F, 05

```

* Minute: bit 3 = 0; Second: bit 3 = 1

You can select Timer setting in the BIOS, after setting the time options, the system will reset according to the period of your selection.

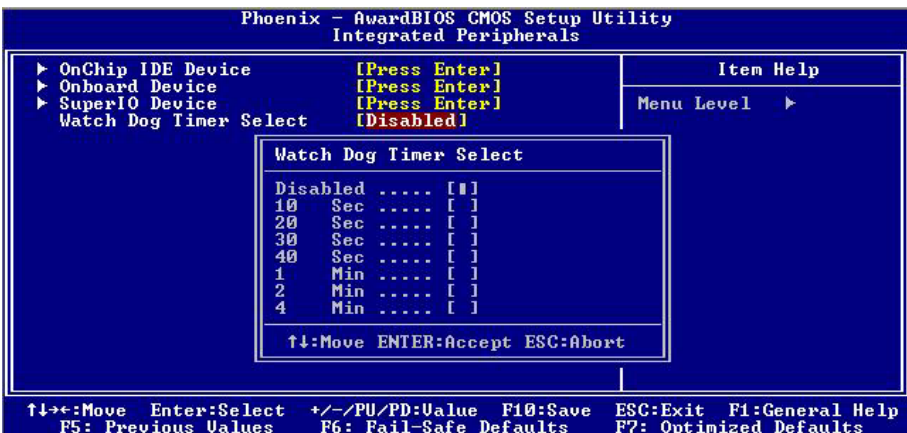

Contact Information

Any advice or comment about our products and service, or anything we can help you please don't hesitate to contact with us. We will do our best to support you for your products, projects and business.

Taiwan Commate Computer Inc.

Address	8F, No. 94, Sec. 1, Shin Tai Wu Rd., Shi Chih Taipei Hsien, Taiwan
TEL	+886-2-26963909
FAX	+886-2-26963911
Website	http://www.commell.com.tw
E-Mail	info@commell.com.tw (General Information) tech@commell.com.tw (Technical Support)

Commell is our trademark of industrial PC division