

TruVision NVR 10 User Manual

Copyright © 2015 United Technologies Corporation. All rights reserved.

Interlogix is part of UTC Building & Industrial Systems, a unit of United Technologies Corporation. All rights reserved

Trademarks and patents Trade names used in this document may be trademarks or registered trademarks of the manufacturers or vendors of the respective products.

Manufacturer Interlogix
2955 Red Hill Avenue, Costa Mesa, CA 92626-5923, USA

Authorized EU manufacturing representative:
UTC Fire & Security B.V.
Kelvinstraat 7, 6003 DH Weert, The Netherlands

FCC compliance **Class A:** This equipment has been tested and found to comply with the limits for a Class A digital device, pursuant to part 15 of the FCC Rules. These limits are designed to provide reasonable protection against harmful interference when the equipment is operated in a commercial environment. This equipment generates, uses, and can radiate radio frequency energy and, if not installed and used in accordance with the instruction manual, may cause harmful interference to radio communications. Operation of this equipment in a residential area is likely to cause harmful interference in which case the user will be required to correct the interference at his own expense.

Canada This Class A digital apparatus complies with Canadian ICES-003.

Cet appareil numérique de la classe A est conforme à la norme NMB-003 du Canada.

ACMA compliance **Notice!** This is a Class A product. In a domestic environment this product may cause radio interference in which case the user may be required to take adequate measures.

Certification   

EU directives **2004/108/EC (EMC directive):** Hereby, UTC Fire & Security declares that this device is in compliance or with the essential requirements and other relevant provisions of Directive 2004/108/EC.



2012/19/EU (WEEE directive): Products marked with this symbol cannot be disposed of as unsorted municipal waste in the European Union. For proper recycling, return this product to your local supplier upon the purchase of equivalent new equipment, or dispose of it at designated collection points. For more information see: www.recyclethis.info.



2006/66/EC (battery directive): This product contains a battery that cannot be disposed of as unsorted municipal waste in the European Union. See the product documentation for specific battery information. The battery is marked with this symbol, which may include lettering to indicate cadmium (Cd), lead (Pb), or mercury (Hg). For proper recycling, return the battery to your supplier or to a designated collection point. For more information see: www.recyclethis.info.

Contact information For contact information, see www.interlogix.com or www.utcssecurityproducts.eu

Content

	Important information	7
Chapter 1	Product introduction	8
	Product overview	8
	Default settings to access the device	8
Chapter 2	Physical installation	10
	Installation environment	10
	Unpacking the recorder and its accessories	10
	Back panel	11
	Monitor connections	12
	Rack mounting	12
Chapter 3	Getting started	14
	Powering on the recorder	14
	The startup wizard	15
Chapter 4	Operating instructions	19
	Controlling the recorder	19
	Using the front panel	19
	Using the mouse	22
	Using the IR remote control	23
	Menu overview	26
Chapter 5	Live view	29
	Description of live view	29
	Video output	30
	Live view mouse menu	30
	Single and multiview display mode	31
	Sequencing cameras	31
	Live view toolbar	32
	Digital zoom	33
	PTZ preset and tours	34
Chapter 6	Searching files	36
	Search video menu	36
	Search and play back recordings by time and video type	37
	Search and play back recordings by event	38
	Search bookmarked recordings	39
	Search snapshots	39
	Log search	40
Chapter 7	Playback functionality	41
	Playback mouse menu	43
	Instant playback	44

	24-hour playback	45
	Playback speed and skip time	45
	Playing back frame-by-frame	46
	Digital zoom in playback	47
	Creating bookmarks	47
Chapter 8	Archiving files	48
	Archiving files	48
	Create and archive video clips	50
	Playing back archived files on a PC	51
Chapter 9	Display settings	52
	Display settings	52
	Layout	53
Chapter 10	Camera setup	55
	IP camera status	55
	Camera recording settings	57
	PoE setup	59
	Snapshots	60
	Camera OSD	60
	Image settings	61
	Motion detection	62
	Privacy mask	64
	Camera tamper	65
	Restricted access camera	65
	VCA Setup	66
	Configure PTZ settings	67
	PTZ presets and tours	68
Chapter 11	Network settings	72
	Network settings	72
	PPPoE settings	74
	DDNS settings	75
	NTP server settings	76
	E-mail settings	77
	Configure an FTP server to store snapshots	78
	SNMP settings	78
	UPnP settings	79
	Network status	80
	Export network packet data	81
	Network statistics	81
Chapter 12	Recording	82
	Recording schedule	82
	Modify the instant replay duration	85
	Manual recording	85

Chapter 13	Alarm and event setup 86
	Set up alarm inputs 86
	Set up alarm outputs 87
	Manual trigger 88
	Buzzer settings 89
	Alarm notification types 89
	Detect video loss 90
	Alarm host setup 91
Chapter 14	Device management 92
	Time and date settings 92
	General recorder settings 94
	Configuration files 95
	Upgrade system firmware 96
	Holiday schedules 96
Chapter 15	Storage management 98
	HDD information 98
	Storage mode 99
	S.M.A.R.T. settings 101
	Bad sector detection 102
Chapter 16	User management 103
	Add a new user 103
	Customize a user's access privileges 104
	Local configuration settings 104
	Remote configuration settings 105
	Camera configuration settings 105
	Delete a user 106
	Modify a user 106
	Change the Admin password 107
Chapter 17	System information 108
	View system information 108
	Search the system log 111
Chapter 18	Using the web browser 114
	Windows 7 and Windows 8 users 114
	Access the web browser 115
	Mac Safari Browser users 115
	Plug-in installation 116
	Web browser live view 117
	Control a PTZ dome camera via the web browser 119
	Play back recorded video 120
	Search for event logs 121
	Configure the recorder via the browser 122

Appendix A	Specifications	126
Appendix B	Product Codes	129
Appendix C	Port forwarding information	130
	Seeking further assistance	130
Appendix D	Maximum pre-recording times	132
Appendix E	Default menu settings	134
Appendix F	TruVision Recorder Archiving Instructions	145
	Searching and playing back recorded video	145
	Exporting video recordings	146
	Exporting video recordings via TruVision Navigator	147
	Using TruVision Player	148
	Index	150

Important information

Advisory messages

Advisory messages alert you to conditions or practices that can cause unwanted results. The advisory messages used in this document are shown and described below.

WARNING: Warning messages advise you of hazards that could result in injury or loss of life. They tell you which actions to take or to avoid in order to prevent the injury or loss of life.

Caution: Caution messages advise you of possible equipment damage. They tell you which actions to take or to avoid in order to prevent the damage.

Note: Notes are used to point out important information that you should read.

Chapter 1

Product introduction

Product overview

The TruVision NVR 10 is a versatile, user-friendly embedded network video recorder (NVR) allowing end-users to record up to 16 cameras with a maximum total input bandwidth of 20/40/80 Mbps for 4, 8, and 16 channels, while providing integration with the UTC portfolio of security solutions, and offering a seamless product experience within the TruVision brand.

Its embedded PoE ports allow for a true plug and play setup for TruVision IP cameras where the recorder automatically assigns the IP camera with an IP address and sets it up at default configurations. Adding cameras was never easier.

Note: The non-PoE version of the NVR is not available in the Americas.

Its dual streaming functionality allows the user to set up different settings for recording and streaming video in live view mode using main and substreams.

The TruVision NVR 10 can be configured through the OSD, web browser, and TruVision Navigator via the SDK.

It can fully integrate with the license-free TruVision Navigator software, which is ideal for most commercial applications. TVN 10's easy and intuitive-to-use web browser interface enables remote configuration and secure viewing, searching, and playing back of video from computers connected via the Internet.

Note: Models are shipped with the power cords for their region.

Default settings to access the device

Default user names and passwords

See Table 1 below for the list of default user names and passwords. Go to Chapter 16 "User management" on page 103 for further information.

Table 1: Default user names and passwords

User	Description
Administrator	There can only be one administrator. The user name is admin. The name cannot be modified. The default password is 1234.
Operator	The default user name is "operator". The default password is 2222.
Guest	The default user name is "guest". The default password is 3333.

Note: The default passwords should be changed for security reasons.

Default network settings

The network settings are:

- IP address - 192.168.1.82
- Subnet mask - 255.255.255.0
- Gateway address - 192.168.1.1
- Ports:

When using the browser:

RTSP port: 554

HTTP port: 80

When using TruNav:

RTSP port: 554

Server/Client software port: 8000

Go to "Using the web browser" on page 114 for further information.

Chapter 2

Physical installation

This section describes how to install the recorder.

Installation environment

When installing your product, consider these factors:

- Ventilation
- Temperature
- Moisture
- Chassis load

Ventilation: Do not block any ventilation openings. Install in accordance with the manufacturer's instructions. Ensure that the location planned for the installation of the unit is well ventilated.

Temperature: Consider the unit's operating temperature (-10 to +55 °C, 14 to 131 °F) and noncondensing humidity specifications (10 to 90%) before choosing an installation location. Extremes of heat or cold beyond the specified operating temperature limits may reduce the life expectancy of the recorder. Do not install the unit on top of other hot equipment. Leave 44 mm (1.75 in.) of space between rack-mounted units.

Moisture: Do not use the unit near water. Moisture can damage the internal components. To reduce the risk of fire or electric shock, do not expose this unit to rain or moisture.

Chassis: Equipment weighing less than 15.9 kg (35 lb.) may be placed on top of the unit.

Unpacking the recorder and its accessories

When you receive the product, check the package and contents for damage, and verify that all items are included. There is an item list included in the package. If any of the items are damaged or missing, please contact your local supplier.

Items shipped with the product include:

- IR (infrared) remote control
- Two AAA batteries for the remote control
- AC power cords
- USB mouse
- Brackets
- Recorder
- CD with software and manuals
- *TruVision NVR 10 Quick Start Guide*
- *TruVision NVR 10 User Manual (on CD)*
- *TruVision Recorder Operator Guide (on CD)*

Back panel

The figures below show the back panel connections and describe each connector on a typical NVR 10 digital video recorder. Details may vary for specific models.

Before powering up the recorder, connect the cameras and a main monitor for basic operation. Once all required connections are done, enter the relevant data in the setup wizard (see page 15).

Note: For every hardwired alarm input, connect one wire to the input connection with the alarm number label and one wire to a ground connection (labeled G).

Figure 1: NVR 10 back panel connections

Four-channel model:

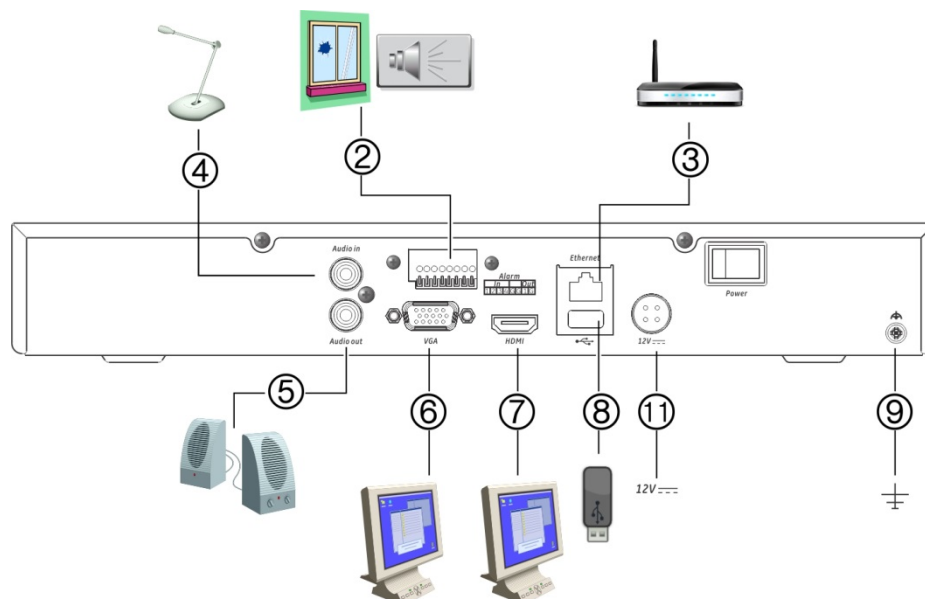

Eight-channel PoE model:

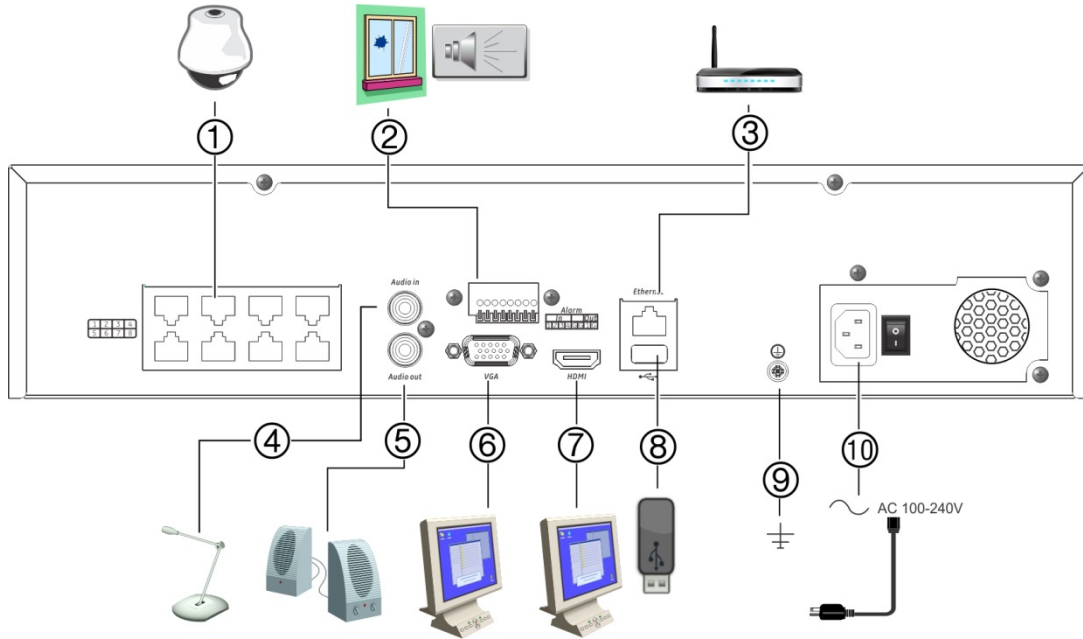

- | | |
|----------------------------------------------------------------------------------------------------------------------------------------------------------------------------------------------------------------------------------------------------------------------------------------------------------------------------------------------------------------------------------------|-----------------------------------------------------------------------------------------------------------------------------------------------------------------------------------------------------------------------------------------------------------------------------------------------------------------------------------------------------------------------------------------|
| <ol style="list-style-type: none"> 1. Embedded PoE ports to connect up to eight IP cameras (depending on model). 2. Connect up to four alarm inputs and one alarm relay output. 3. Connect to a network. 4. Connect an RCA connector for audio input 5. Connect to speakers for audio output. 6. Connect to a VGA monitor. | <ol style="list-style-type: none"> 7. Connect to an HDTV. The HDMI connection supports both digital audio and video. 8. Universal Serial Bus (USB 3.0) port. Connect to an additional device such as a USB mouse, CD/DVD burner or USB HDD. 9. Connect to ground. 10. Connect to a power cord. 11. Connect to a 12 VDC power supply. |
|----------------------------------------------------------------------------------------------------------------------------------------------------------------------------------------------------------------------------------------------------------------------------------------------------------------------------------------------------------------------------------------|-----------------------------------------------------------------------------------------------------------------------------------------------------------------------------------------------------------------------------------------------------------------------------------------------------------------------------------------------------------------------------------------|

Monitor connections

Connect the unit to a monitor via an appropriate cable with the VGA/HDMI connector. The recorder provides a 1 Vp-p CVBS signal. See Figure 1 on page 11 for connecting a monitor to a recorder.

The recorder supports up to 1280 × 1024 / 60 Hz resolution in VGA/HDMI. The monitor resolution should be at least 800 × 600. Adjust your monitor accordingly to this resolution.

Rack mounting

The TVNc models have a 1U desk-based chassis. They are not rack mountable.

The TVN models have a 1.5U desk-based chassis but can be easily rack-mountable with the purchase of the TVR-RK-1 rack-mount kit. Contact your local supplier to order the kit. See Figure 2 below.

Figure 2: TVN 10 rack-mount installation

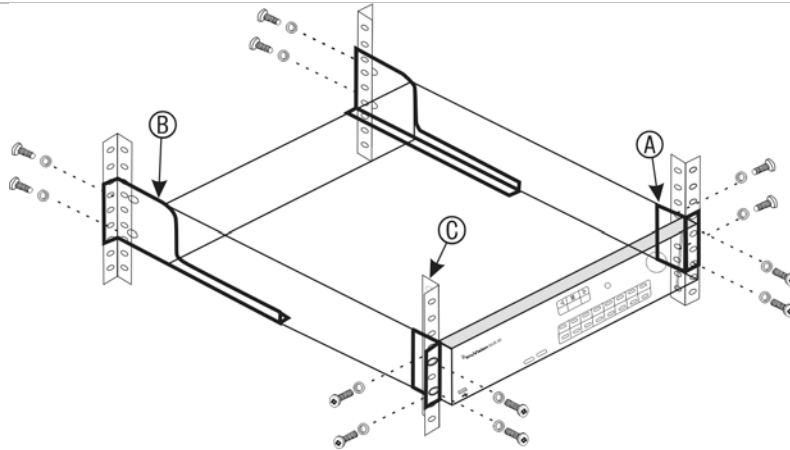

To install the racks:

1. Attach the two small front-rack mount ears (A) to the NVR. The screws are supplied.
2. Attach the two large rear support brackets (not supplied) to the rear rails (B).
3. Attach the NVR to the front rails (C). The screws are not supplied.

Chapter 3

Getting started

Powering on the recorder

Before starting the recorder, connect at least one monitor. Otherwise, you will not be able to see the user interface and operate the device.

The recorder auto-detects the video mode (PAL or NTSC) on startup.

It comes equipped with a universal power supply that will auto-sense 110/240 V, 60/50 Hz.

Note: It is recommended that an uninterruptible power supply (UPS) is used in conjunction with the device.

To turn on the recorder:

Turn on the recorder using the power switch on the back panel. Once it is powered up, the status LEDs on the front panel will light up.

To turn off the recorder:

1. In live view mode, right-click the mouse and click **Menu**. The main menu window appears.
2. From the menu toolbar, click **Shutdown**.
3. In the Shutdown popup menu, select **Shutdown**. Click **Yes** to confirm shutdown.
You will be requested to enter the Admin password.

To reboot the recorder:

1. In live view mode, right-click the mouse and click **Menu**. The main menu window appears.
2. Select the **Shutdown** icon.
3. In the Shutdown popup menu, select **Reboot**. Click **Yes** to confirm shutdown.
You will be requested to enter the Admin password.

The startup wizard

The recorder has an express installation wizard that lets you easily configure basic recorder settings when first used. It configures all cameras to default settings. The configuration of each camera and recorder can be customized as required.

By default the startup wizard will start once the recorder has loaded. It will walk you through some of the more important settings of your recorder.

Any changes you make to a setup configuration page are saved when you exit the page and return to the main wizard page.

Note: If you want to set up the recorder with default settings only, click **Next** in each screen until the end.

To use the Startup wizard:

1. To launch the startup wizard without rebooting the device, go to **Menu > Device Management > General Settings** and click 'Start wizard'.
2. Select the preferred language for the system and resolution from the dropdown list and then click **Next**.
3. Enable or disable the option to start the wizard automatically when the recorder is turned on. Click **Next**.
4. **User configuration:**

You can change the admin password and create additional users.

Mouse: Navigate to the Admin Password edit box. Click the box to display the virtual keyboard and enter the default admin password, 1234.

Front panel or remote control: Navigate to the Admin Password edit box using the navigation buttons. Press Enter on the front panel or remote control to display the virtual keyboard. Enter the default admin password, 1234.

No.	User Name	Level	User's MAC Address
1	admin	Admin	00:00:00:00:00:00
2	operator	Operator	00:00:00:00:00:00

Note: You must enter an admin password. To change the Admin password, check **New Admin password** and enter the new password and confirm it.

Caution: It is strongly recommended that you change the password of the administrator. Do not leave 1234 as the default password. Write it down in a safe place so that you do not forget it.

If you should forget the password to your recorder, contact your supplier with the serial number of your recorder to obtain a secure code to reset it.

Click **Next**.

5. Time and date configuration:

Select the desired time zone, date format, system time, and system date.

If Daylight saving time (DST) is required, check **Enable DST** and enter the desired summer and winter times.

Time Zone	(GMT-08:00) Pacific Time(U.S. & Canada)
Date Format	MM-DD-YYYY
Time Format	24-hour
System Date	10-22-2014
System Time	09:26:26
Enable DST	<input checked="" type="checkbox"/>
From	Mar 2nd Sun 2 : 00
To	Oct last Sun 2 : 00
DST Bias	60 Minutes

Apply

Previous Next Cancel

Note: The system time and date are visible on screen. However, they do not appear in recordings.

Click **Apply** and then **Next** to move to the next page or click **Previous** to return to the previous page.

6. Network configuration:

Configure your network settings such as the NIC type, IP address, subnet mask, and default gateway. Enter the preferred DNS server address as well as the alternate one to use.

NIC Type	10M/100M Self-adaptive
Enable DHCP	<input type="checkbox"/>
IPv4 Address	192 . 168 . 1 . 82
IPv4 Subnet Mask	255 . 255 . 255 . 0
IPv4 Default Gateway	192 . 168 . 1 . 1
Preferred DNS Server	
Alternate DNS Server	

UPnP Previous Next Cancel

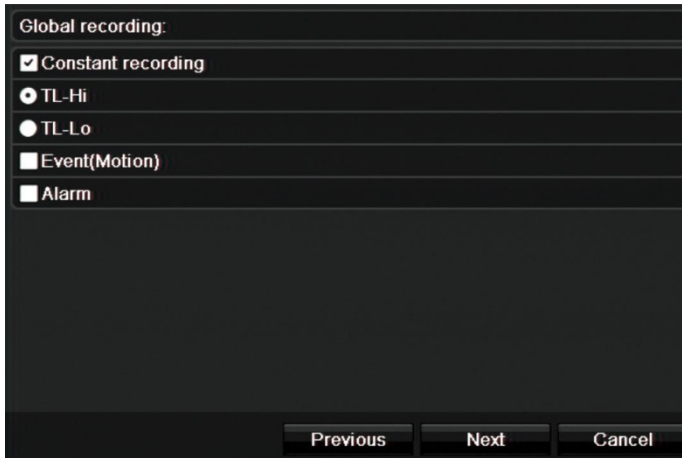

Check the **Constant Recording** checkbox for the recorder to record continuously all day. If left unchecked, the recorder will not record.

Check the desired time lapse check box, **TL-Hi** or **TL-Lo**.

To record motion detection events, check **Event (Motion)**.

To record alarm events, check **Alarm**.

Click **Next** to move to the next page, or **Previous** to return to the previous page.

Note: You can configure the recording parameters of each individual camera for the different recording schedules in the recording menu.

- When all the required changes have been entered, a summary page appears showing all the settings.

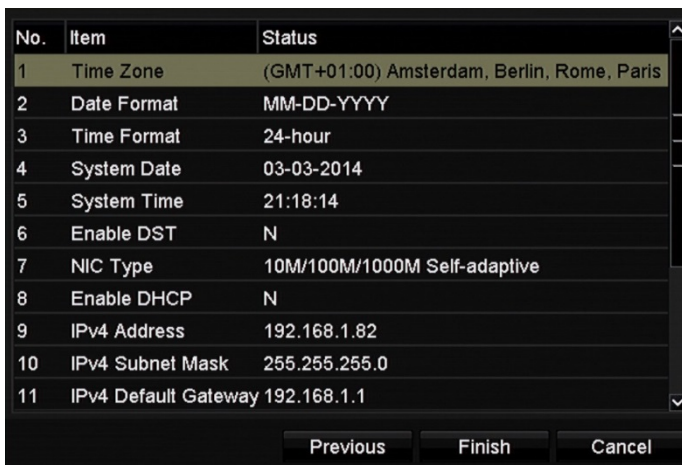

Click **Finish** to exit the Wizard. The recorder is now ready to use.

For a description of the recorder main menu, see “Menu overview” on page 26.

Caution: Important! Your TruVision device is delivered with default user name and password credentials for initial access, easy configuration and auto discovery. For security reasons, it is highly recommended to change the default credentials.

Chapter 4

Operating instructions

Controlling the recorder

There are several ways to control the recorder:

- Front panel control. See “Using the front pane” below.
- Mouse control. See “Using the mouse” on page 22.
- IR remote control. See “Using the IR remote control” on page 23.
- TVK-800 keypad (from TVK-800 firmware version 1.0i). Please refer to the user manual for more information.
- Web browser control (TruVision Navigator, TVRmobile). See Chapter 18 “Using the web browser” on page 114 for more information on using the web browser. Please refer to the TruVision Navigator and TVRmobile user manuals for more information.

You can use your preferred control method for any procedure, but in most cases we describe procedures using the mouse. Optional control methods are given only when they differ substantially from the mouse control methods.

Using the front panel

The function buttons on the front panel control can be used to operate most, but not all, of the main functions of the recorder. The LED indicators light up to alert you of various conditions. The functions available can be limited by setting passwords. See Figure 3 on page 20 for more information.

Figure 3: NVR 10 front panel

16-channel model:

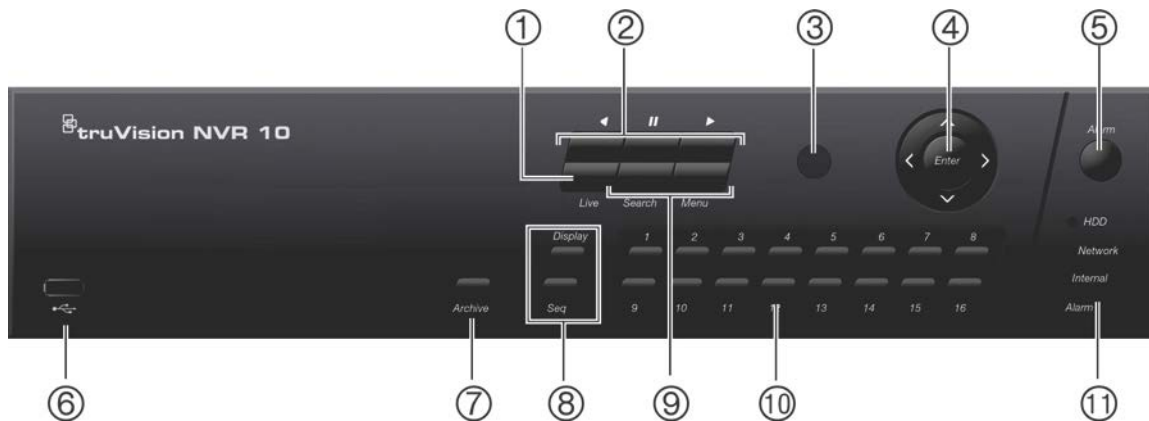



The controls on the front panel include:





Table 2: Front panel button description

Name	Description
1. Live view button	Switch to live view mode.
2. Playback buttons	See Table 3 on page 21 for a detailed description of all these buttons for different tasks. Reverse: In live view mode, use to play back the earliest video. In playback mode, playback a camera in the reverse direction. Pause: In live view mode, freeze the last image of the live display for all active cameras displayed. In playback mode, stop playback. Play: In live view mode, play 24-hour playback of the currently selected camera. In playback mode, play back a camera in the forward direction. In search mode, play back a selected video or view a snapshot.
3. IR receiver	Receiver for IR remote. To connect the remote control to the NVR, press the Device button, enter the device address, and press Enter.
4. Direction	The DIRECTION buttons are used to navigate between different fields and items in menus. In PTZ mode, it can control the movement of the PTZ camera.
Enter button	The ENTER button is used to confirm selection in any of the menu modes. See Table 3 on page 21 for a detailed description of these buttons by different tasks.
5. Alarm button	Use to manually acknowledge an alarm. In live view mode, contact the alarm recipient when an alarm/event is triggered.
6. USB Interfaces	Universal Serial Bus (USB) ports for additional devices such as a USB mouse, CD/DVD burner, and USB Hard Disk Drive (HDD).
7. Archive button	Press once to enter quick archive mode. Press twice to start archiving. If the flash drive has an LED, it will flash during archiving.

Name	Description
8. Display buttons	<p>See Table 3 below for a detailed description of all these buttons for different tasks.</p> <p>Display: In multiview mode, toggle through the various multiviews (full, quad, 1+5, 1+7, 9, and 16).</p> <p>In HDD information mode and user management mode delete a selected item. In PTZ mode, delete a selected key point. In Log Search mode, display the details of a log file in Log Search result.</p> <p>Seq: In Live View mode, start/stop sequencing cameras on the current monitor.</p>
9. Menu and Search buttons	<p>Menu: Enter/exit the main menu.</p> <p>Search: In live view, enter the advanced search menu.</p>
10. Numeric buttons	<p>Switch between different cameras in live, PTZ control or playback modes.</p> <p>Enter numerals 0 to 9 when using the virtual keyboard.</p>
11. Status LEDs	<p>HDD: A steady GREEN light indicates that the NVR is accessing the HDD in read or write operation. A steady RED light indicates HDD failure.</p> <p>Network: A steady GREEN light indicates that the NVR is currently connected to a network. No light indicates that the NVR is not connected to any network.</p> <p>Internal: A steady GREEN light indicates that the NVR is currently recording video/audio. A steady RED light indicates internal health failure.</p> <p>Alarm: A steady RED light indicates that there is a sensor Alarm In. A steady GREEN light indicates no alarm.</p>

Table 3: Front panel button functions by task

Task	Button	Button function
Live view mode	Direction	Press to cycle through channels.
	Enter	Press to show the PTZ control toolbar.
	 Reverse	Press to play the earliest video file of the current camera (upper-left video tile if in multiview mode).
	 Pause	Press to freeze the last image of the live display for all active cameras displayed.
	 Play	Press to play 24-hour playback of the current camera (upper-left video tile if in multiview mode).
	Live	Press to switch to live view mode.
	Seq	Press to start/stop sequencing cameras on the current monitor. Hold the Seq button for three seconds to start and stop sequencing.
Playback mode	Menu	Press to enter the main menu.
	Direction	The left and right buttons are used to speed up and slow down recorded video. The up and down buttons are used to jump recorded video forwards or backwards by 30 s.

Task	Button	Button function
	Enter	Press the button to pause the video. Press again to restart the video. In single-frame Playback mode, press to advance the video by a single frame.
	 Reverse	Press to play back a camera in reverse direction. In Picture Playback mode, view pictures in reverse direction.
	 Pause	In Playback mode, stop playback.
	 Play	In Playback mode, play back a camera in the forward direction.
Pause mode	Direction	The left and right buttons are used to jump recorded video forwards or backwards by one frame. The up and down buttons are used to jump recorded video forwards or backwards by one second.
PTZ control mode	Direction	Press to control the movement of the PTZ camera.
	Zoom +/-	Press to zoom in and out.
	Preset	Press Preset and a numeric button to call the specified preset.
	Tour	Press Tour and a numeric button to call the specified shadow tour.
	 Play	Press to do an auto tour.
	Display	Press to delete a selected key point from the PTZ Setting > More Settings> Tour > Key Point list.
Menu navigation	Direction	Press to navigate between different fields and items in menus.
	Menu	Enter/exit the main menu.
	Enter	Press to confirm the selection in any of the menu modes.

Using the mouse

The USB mouse provided with the recorder can be used to operate all the functions of the unit, unlike the front panel which has limited functionality. The USB mouse lets you navigate and make changes to settings in the user interface.

Connect the mouse to the recorder by plugging the mouse USB connector into the USB port on the back panel or the front panel. The mouse is immediately operational and the pointer should appear.

Note: Use a USB 2.0 mouse.

Move the pointer to a command, option, or button on a window. Click the left mouse button to enter or confirm a selection.

You can purchase a spare mouse by ordering part number TVR-MOUSE-1.

See Table 4 on page 23 for a description of the mouse buttons.

Table 4: Mouse buttons

Item	Description	
Left button	Single-Click	<p>Live view: Select a camera to display the live view toolbar.</p> <p>Menu: Select a component of a menu, such as a button or an input field. This is similar to pressing the Enter button on the remote/front panel controls.</p>
	Double-Click	<p>Live view: Switch between single screen and multi-screen mode in live/ playback mode.</p>
	Click and Drag	<p>Live view: Drag channel/time bar.</p> <p>PTZ control: Adjust pan, tilt and zoom.</p> <p>Tamperproof, privacy masking and motion detection functions: Select the target area.</p> <p>Digital zoom-in: Drag and select target area.</p>
Right button	Single-Click	<p>Live view: Display menu.</p> <p>Menu: Exit the current menu and return to higher level.</p>
Scroll-wheel	Scroll Up	<p>Live view: Return to the previous window.</p> <p>Menu: Move the selection to the previous item.</p>
	Scroll Down	<p>Live view: Move to the next window.</p> <p>Menu: Move the selection to the next item.</p>

Using the IR remote control

The recorder is supplied with an infrared (IR) remote control unit. Like the mouse, it can be used to operate all of the main functions of the unit.

The IR remote control can be programmed with a unique device ID address so that the controller will only be able to communicate with recorders with that address. No programming is necessary if using a single recorder.

The device ID address only applies when using a remote control and not when using a keypad.

You can purchase a replacement remote control by ordering part number TVR-REMOTE-1.

Figure 4: IR remote control

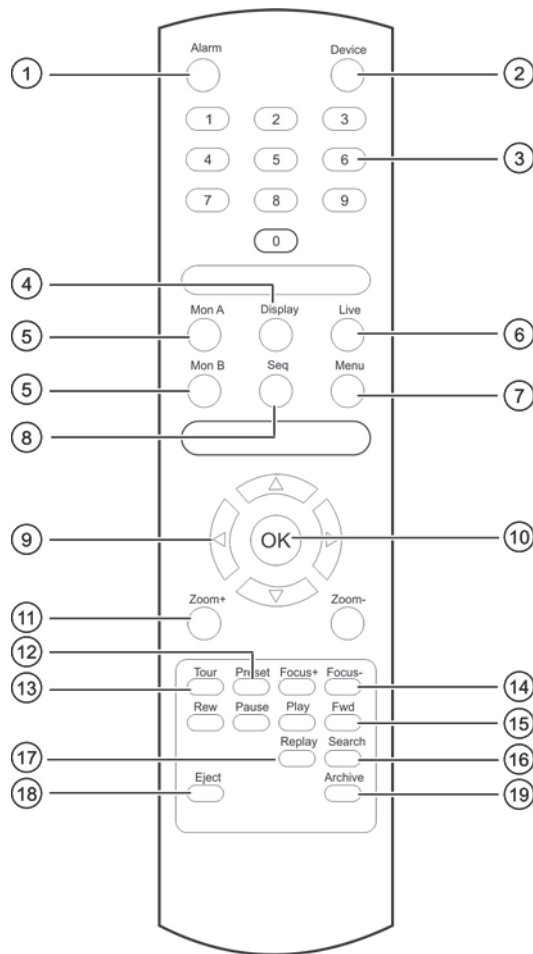

Item	Description
1. Alarm	Acknowledge an alarm.
2. Device	Enable/disable the IR remote control to control the recorder.
3. Numeric buttons	Select a camera, and enter a number in a menu option.
4. Display	Switch between the different multiview formats.
5. Mon A and Mon B	Switch between monitors A and B.
6. Live	Return to live view mode.
7. Menu	Activate the main menu.
8. Seq	Start /stop sequencing.
9. <, >, ^, v	In Menu mode: Use left or right arrow buttons to select and up or down arrow buttons to edit entry. In PTZ mode: Use to control PTZ. In Playback mode: Use to control playback speed.
10. OK	Confirm selection.
11. Zoom + and -	Use to control zoom of camera lens.
12. Preset	Enter preprogrammed three-digit code to call up a preset.
13. Tour	Enter preprogrammed three-digit code to call up shadow tour.

Item	Description
14. Focus + and -	Use to control focus of camera lens.
15. Playback control	Use to control playback (Rewind, Pause, Play, and Fast Forward).
16. Search	Open the Search menu.
17. Replay	Replay the selected file from the beginning.
18. Eject	Eject the CD or DVD disk.
19. Archive	Press once to enter quick archive mode. Press twice to start archiving.

Aim the remote control at the IR receiver located at the front of the unit to test operation.

To change the address of the remote control to the recorder:

1. Press the **Menu** button on the front panel or right-click the mouse and select the **Menu** button. The default display menu window appears.
2. Click **Device Management > General Settings**.
3. Check the remote control ID value. The default value is 255. This device address is valid for all IR controls.

Note: The recorder will respond to any remote control that has an address between 1 and 255.

4. On the remote control press the **Device** button.
5. Enter the device address value. It must be the same as that on the recorder.
6. Press the **OK** button on the remote control.

To place batteries into the IR remote control:

1. Remove the battery cover.
2. Insert the batteries. Make sure that the positive (+) and negative (-) poles are correctly placed.
3. Replace the battery cover.

Troubleshooting the remote control

If the IR remote control is not functioning properly, perform the following tests:

- Check the battery polarity.
- Check the remaining charge in the batteries.
- Check that the IR remote control sensor is not masked.

If the problem still exists, please contact your administrator.

Menu overview

The recorder has an intuitive structure that allows you to configure the unit's parameters quickly and efficiently. Each command icon displays a window that lets you edit a group of settings. Most menus are available only to system administrators.

The window is divided into three sections. The currently selected command icon and submenu item are highlighted in green. See Figure 5 below.

You must be in live view mode to access the main menu.

Figure 5: Menu structure

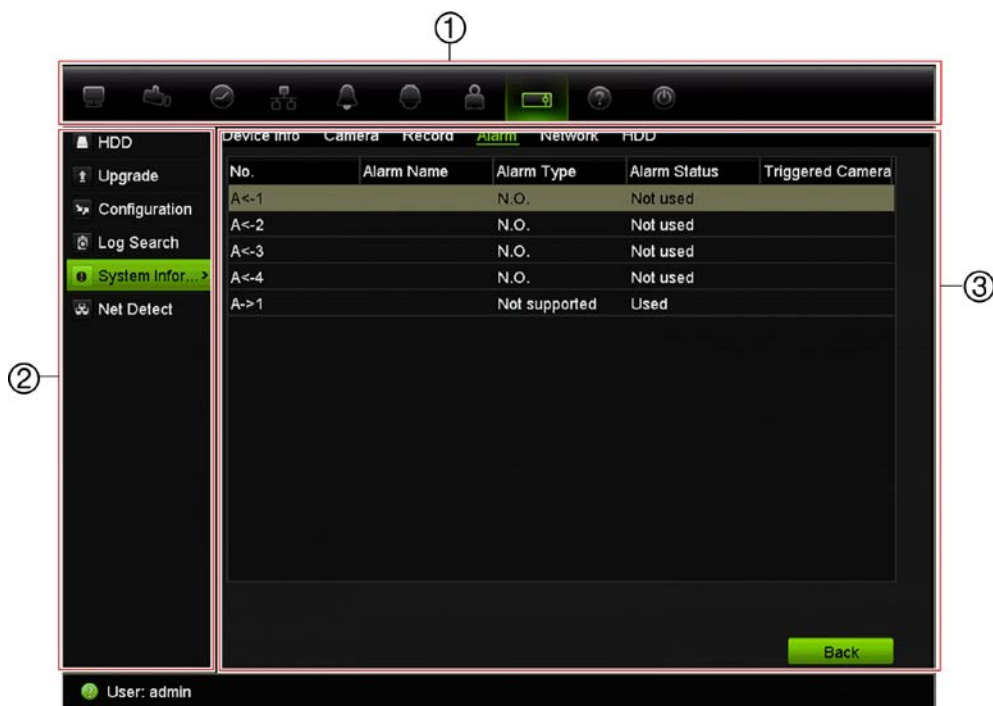











- Menu toolbar:** Setup options available for the selected menu function. Move the mouse over a command icon and click to select it. See Table 5 below for a description of the icons.
- Submenu panel:** Submenus for the selected menu function are displayed. Click an item to select it.
- Setup menu:** All the details for the selected submenu are displayed. Click a field to make changes.

Note: See Table 3 on page 20 for the description on how to access the menu options using the front panel.

Table 5: Description of the menu toolbar icons

Icon	Name	Description
	Display Settings	Configures display settings including video format, resolution, video output interface, dwell time, multiview format, and camera sequencing. See Chapter 9 "Display settings" on page 52.

Icon	Name	Description
	Camera Setup	Configures camera settings including snapshot resolution and quality, camera settings including OSD, privacy masking, tampering, restricted access, motion detection setup, PTZ setup, preset tours and show tours, V-stream encoding. See Chapter 10 "Camera setup" on page 55
	Network Settings	Configures standard network settings including IP address, email notifications, DDNS setup, and advanced network settings. See the Chapter 11 "Network settings" on page 72.
	Recording	Configures recording settings including instant replay duration, recording schedule, and manual recording. See Chapter 12 "Recording" on page 82.
	Alarm and Event Setup	Configures alarm settings including alarm input, alarm output, manual trigger, buzzer settings, alarm notifications, video loss, and alarm host setup. See Chapter 13 "Alarm and event setup" on page 86.
	Device Management	Configures system settings including system date and time, DST, language, menu timeout, import/export config files, firmware upgrade, holiday schedules, text insertion, and RS-232 settings. See Chapter 14 "Device management" on page 92.
	Storage Management	Configures HDD information, storage mode, S.M.A.R.T. settings, and bad sector detection. See Chapter 15 "Storage management" on page 98.
	User Management	Configures users, passwords, and access privileges. See Chapter 16 "User management" on page 103.
	System Information	Displays device information, camera setup information, recording setup information, alarm inputs information, alarm outputs information, network information, HDD information, and log search. See Chapter 17 "System information" on page 108.
	Help	Provides reference information to the various toolbars, menus, and keys within the interface.
	Shutdown	Provides access to logout, reboot, and shutdown options. See "Powering on the recorder" on page 14.

To access the main menu:

- In live view, press the **Menu** button on the remote control or front panel.
- Or -
Right-click the mouse and select **Menu** from the pop-up menu.
The main menu window appears. The Display Settings window appears by default.
- Click the required menu icon to display its submenu options. Modify the configuration parameters as required.
- Click **Apply** to save the settings.
- Click **Exit** to leave the menu setup and return to live view.







The soft keyboard

A keyboard will appear on-screen when you need to enter characters in a window option. Click a key to input that character.

Figure 6: The soft keyboard



Description of the keys in the soft keyboard:

	Switch to lowercase/uppercase
	Space
	Exit the soft keyboard
	Alphanumeric characters
	Backspace
	Punctuation
	Confirm selection

Exiting the main menu

Press the **Menu** button on the front panel to exit the current menu window and return to live view, or click **Exit** in a main menu, or right-click using the mouse.

Chapter 5

Live view







Description of live view

Live view mode is the normal operating mode of the unit where you watch live images from the cameras. The recorder automatically enters into live view mode once powered up. On the monitor you can see whether a recording is in progress and, if set up to do so, the current date and time, as well as the camera name.

Status information

Information on the system and camera status is displayed as icons on the main and auxiliary monitors. The camera status icons are shown for each camera. Each icon represents information on a specific item. These icons include:

Table 6: Description of the on-screen status icons

Icon	Description
	Indicates an alarm.
	Indicates that a camera channel is being recorded.
	Indicates a motion detection event.
 Video Loss	Indicates a video loss event.
	Indicates alarm and system notifications. Clicking the icon opens a window that lists the alarms and notifications.
	Indicates manual recording.
	Indicates that live view is locked from the front panel. Mouse actions are still allowed.

The recorder can display more than one icon at the same time. See “General recorder settings” on page 94 to display or hide these icons.

The system status is displayed on the front panel by the status LEDs.

Video output

The recorder automatically checks the monitor outputs used on startup.

If an HDMI monitor is used, it will be the main output. If HDMI and VGA monitors are both connected to the recorder, both will be main monitors; they will both show the same view.

Live view mouse menu

Many features of live view can be quickly accessed by placing the cursor on a live image and clicking the right-button of the mouse. The mouse menu appears (see Figure 7 below).

Figure 7: The mouse menu for the main monitor

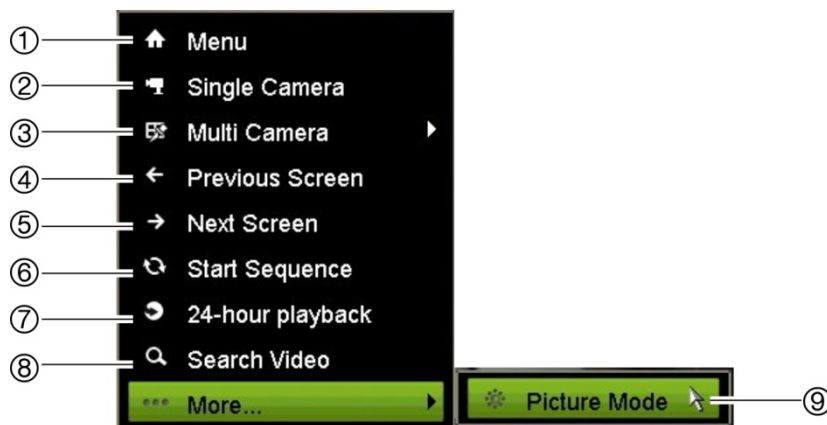

The list of commands available depends on which monitor is active; main or auxiliary (monitor B). See Table 7 below. The default settings of these commands are provided in the appendix under “Default menu settings” on page 134.

Table 7: Mouse menu for monitor A (main monitor)

	Name	Description
1.	Menu	Enter the Main menu.
2.	Single Camera	Switch to a full-screen view for the selected camera from the dropdown list. See “Single and multiview display ” on page 31 for more information.
3.	Multi Camera	Switch between the different multiview options from the dropdown list. See “Single and multiview display ” on page 31 for more information.
4.	Previous Screen	Displays the previous camera.

	Name	Description
5.	Next Screen	Displays the next camera.
6.	Start Sequence	Turn on sequence mode. The window automatically sequences between cameras. To set up the sequence dwell time, go to Menu > Display Settings > Display > Sequence Dwell Time and select a value.
7.	24-hour Playback	Playback the recorded video of the selected day from the selected camera. The current day is selected by default. See “24-hour playback” on page 45 for more information.
8.	Search Video	Enter the advanced video search menu. See “Search video menu” on page 36 for more information.
9.	Picture Mode	Select Standard, Bright, Soft, or Vivid mode to display.

Single and multiview display mode

The recorder has single and multiview formats. The number of multiview display modes available depends on the recorder model.

Single view display format	<p>Press the numeric button on the front panel to switch to the corresponding camera display. For example, press button 10 to view camera 10.</p> <p>-Or-</p> <p>Right-click the mouse and select Single Camera from the menu. Select the required camera from the list.</p>
Multiple view display format	<p>Press the Display button on the front panel to cycle through different display formats.</p> <p>-Or-</p> <p>Right-click the mouse and select Multi Camera from the menu. Select the desired multiview display layout.</p>

Sequencing cameras

The sequencing feature allows a camera to be displayed briefly on screen, before advancing to the next camera in the sequence list. Sequencing can only be done in single-view display mode.

The default sequence displays each camera in numerical order. However, each camera on the main and event monitors can have a pre-programmed dwell time and sequence order. See “Layout” on page 53 for more information.

Note: Dwell time must not be set to zero for sequencing to function.

Sequencing cameras using the front panel:

Select the camera where you want to start sequencing. Press the **Seq** button on the front panel to start sequencing. Press it again to stop sequencing.

Sequencing cameras using the mouse:

Select the camera where you want to start sequencing. Right-click the mouse and select **Start Sequence** to start the sequencing. Right-click again and select **Stop Sequence** to stop sequencing.









Live view toolbar



The live view toolbar in live view lets you quickly access regularly used commands. Position the cursor over a video image and left-click the mouse. The toolbar appears (see Figure 8 below).

Figure 8: Live view toolbar



Table 8: Description of the live view toolbar icons

Icon	Description
	Pause: Freeze the live image of the selected camera. Although the image pauses, time and date information does not. The system clock continues to run.
	Start Manual Recording: Start/stop manual recording. The icon is red when manual recording is enabled. See “Recording schedule” on page 82 for information on setting up this function.
	Instant Playback: Playback the recorded video from the last five minutes. If no recording is found, then there was no recording made in the last five minutes. Click the icon and select the desired camera. Click OK. See “Modify the instant replay duration” on page 85 For more information.
	Audio On: Enable/Disable audio output. The audio option must already have been setup in the Display menu.
	Snapshot: Capture a snapshot of a video image. The image is saved on the unit. See “Search snapshots” on page 39 for more information.
	PTZ Control: Enter PTZ control mode. See “Configure PTZ settings” on page 66 for more information.
	Digital Zoom: Enter digital zoom. See “Digital zoom” on page 33 for further information.
	Image Settings: Enter the image settings menu to modify the image lighting levels. There are two options:

Icon	Description
	<p>Preset Mode: These are preconfigured image lighting levels. Select one of the four options depending on current lighting conditions:</p> <ul style="list-style-type: none"> - <i>Standard:</i> Use in standard lighting situations. - <i>Indoor:</i> Use indoors. - <i>Dim Light:</i> Use when the light level is low. - <i>Outdoor:</i> Use when outdoors. The contrast and saturation values are high. <p>Customize: Modify brightness, contrast, saturation, and hue values. Click Restore to restore image settings to previous values.</p> <p>Click Restore to restore image settings to previous values. Click Default to return to default values.</p> <p>These settings can also be modified from the Camera Setup > Image menu (see page "Image settings" on page 61).</p>
	<p>Auxiliary Focus: Automatically focus the camera lens for the sharpest picture.</p>
	<p>Lens Initialization: Initialize the lens of a camera with a motorized lens, such as PTZ or IP cameras. This function helps to maintain lens focus accuracy over prolonged periods of time.</p>
	<p>Close Toolbar: Close the toolbar.</p>

Digital zoom

You can easily zoom in or out of a camera image in live view mode and playback using the digital zoom command. The zoom command magnifies the camera image four times. See Figure 9 below.

Figure 9: Digital zoom window





To quickly zoom in/out on a camera image:

1. Left-click the mouse on the desired camera. The live view toolbar appears.
2. Click the digital-zoom icon. The digital view window appears.
3. Left-click the mouse and drag the red square to the area of interest, or press the arrow buttons on the front panel to position the red square. The selected area is magnified.
4. To exit digital zoom, right-click the mouse.

PTZ preset and tours

When in live view you can quickly call up the list of existing presets, preset tours and shadow tours by using the front panel, remote control, mouse and keypad.

Front panel	Press Enter . PTZ control panel appears.
Mouse	Left-click the mouse on the desired camera image. The live view toolbar appears. Click the PTZ control icon  to enter PTZ mode. The PTZ control panel appears.
Remote control	Press the OK button. The PTZ control panel appears.
Keypad	Press the Enter  button on the keypad.

If the display was in multiview format, it changes to full-screen format for the selected camera. See Figure 10 below for a description of the PTZ control panel.

Figure 10: PTZ control panel

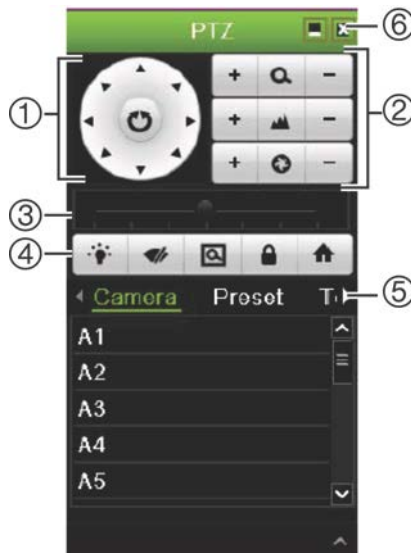







Table 9: Description of the PTZ control panel

Name	Description
1. Directional pad/auto-scan buttons	Controls the movements and directions of the PTZ. The center button is used to start auto-pan by the PTZ dome camera.

Name	Description
2. Zoom, focus, and iris	Adjusts zoom, focus and iris.
3. PTZ movement	Adjusts the speed of PTZ movement.
4. Toolbar	 Turns on/off camera light.
	 Turns on/off camera wiper.
	 Zoom area.
	 Centers the PTZ dome camera image. This command is not supported on all PTZ dome cameras.
	 Jumps to the home position.
5. Select PTZ command	Displays the desired function from the scroll bar: camera, preset, preset tour or shadow tour.
6. Exit	Exits the PTZ control panel.

To call up a preset:

1. In live view, left-click the mouse and select the PTZ control icon in the quick access toolbar. The PTZ control panel appears. Select the desired camera from the toolbar.

– Or –

On the front panel, select the desired camera and press **Enter** to call up the quick access toolbar. The PTZ control panel appears.

2. Scroll the toolbar to **Preset** and double-click the desired preset from the list. The camera immediately jumps to the preset position.

To call up a preset tour:

1. In live view, left-click the mouse and select the PTZ control icon in the live view toolbar. The PTZ control panel appears. Select the desired camera from the toolbar.

– Or –

On the front panel, select the desired camera and press **Enter** to call up the live view toolbar. The PTZ control panel appears.

2. Scroll the toolbar to **Tour** and double-click the desired preset tour from the list. The camera immediately carries out the preset tour movement.

To call up a shadow tour:

1. In live view left-click the mouse and select the PTZ Control icon in the live view toolbar. The PTZ control panel appears. Select the desired camera from the toolbar.

– Or –

On the front panel, select the desired camera and press **Enter** to call up the live view toolbar. The PTZ control panel appears.

2. Scroll the toolbar to **Shadow Tour** and double-click the shadow tour from the list. The camera immediately carries out the shadow tour movement.

Chapter 6

Searching files

This chapter describes how to search and playback recorded videos as well as search them by time, events, bookmarks, and snapshots.

Search video menu

You can easily search and play back recorded videos by time and date, events, bookmarks, and snapshots.

Figure 11: The Search menu

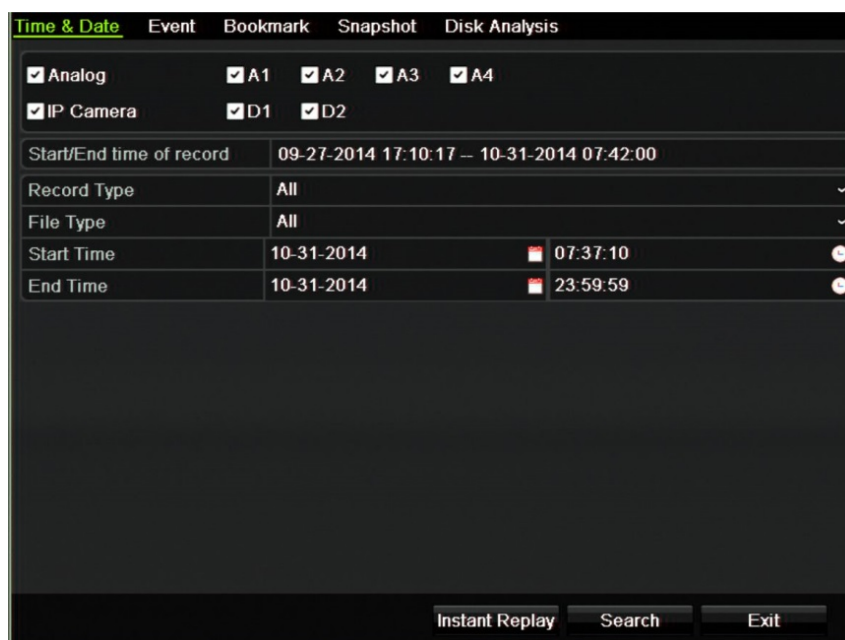

The Search window has five submenus that allow you to carry out different searches by theme:

Search type	Description
Time and date	Search all video by time and date of recording.
Event	Search only event recorded files. Files can be searched by alarm inputs, text insertion, or intelligent alarms.
Bookmark	Search recorded files with bookmarks.
Snapshot	Search snapshots.

Search results

A search will usually produce a list of recording files, which may extend to several pages. The files are listed by date and time. The most recent file is listed first. You can then select a file to play it back. See Figure 12 below for an example of a search. A recording file can be up to 1GB in size. Every day at midnight a new recording file is started, and each event is also stored as a separate recording file. For more details about how to archive multiple recording files, please reference the Archiving instructions in the appendices of the user manual.

Only one file can be played back at a time.

Figure 12: Example of a search result list

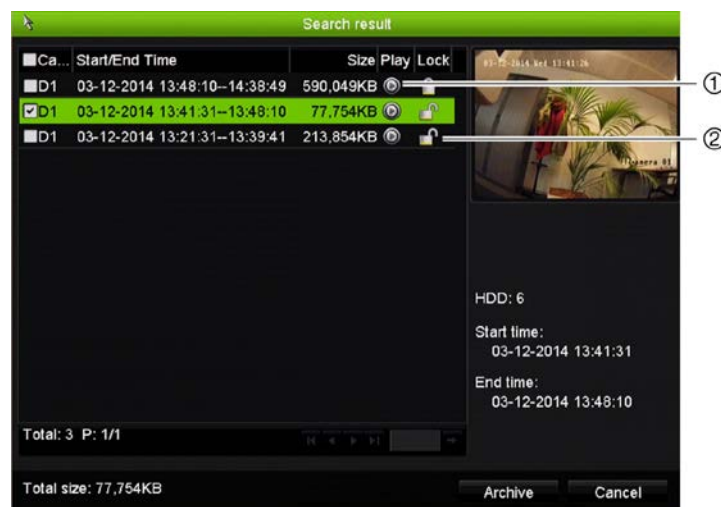

1. Click to playback the selected video.
2. Click to lock recording to prevent it from being overwritten.

Search and play back recordings by time and video type

You can search recorded video by time and video type, such as continuous recordings, alarms, and all recordings. Video can be played back simultaneously across several cameras.

To search archived video files:

1. In live view right-click the mouse on the desired video pane and select **Search Video**. The Search menu appears.
2. Select the desired cameras, record type, file type as well as start and end times of the recording.
3. Click **Search**. The list of search results appears.
4. Click  to play back the search results:

To immediately access archived footage:

1. In the Search menu, click the “Time & Date” tab.
2. Select the desired cameras, record type, file type as well as start and end times of the recording. Up to four cameras can be selected.
3. Click **Go**. The simultaneous playback of up to four cameras for the indicated time will start.

Search and play back recordings by event

You can search recorded video by event type: text insertion, intelligent alarms, and alarm input.

To play back search results:

1. In live view right-click the mouse on the desired video pane and select **Search Video**. The Search menu appears.
2. In the Search menu, click the “Event” tab.
3. Select the desired event type as well as start and end times of the recording.
4. Select the desired alarm inputs or channels.

If you selected “Intelligent Alarm” as the event type, select the required IP cameras.

5. Click **Search**. The list of search results appears.
6. Select the desired video from the list.
7. In the search results window, you can:
 - Click **Play** to playback the footage
 - Click **Archive** to archive results
 - Click **Details** to display more information about an event.

Note: You can modify the pre- and post-play periods of a recording.

Search bookmarked recordings

For information on creating bookmarks, see “Creating bookmarks” on page 47.

To search for a bookmark:

1. In live view right-click the mouse on the desired video pane and select **Search Video**. The Search menu appears.
2. In the Search menu, click the “Bookmark” tab.
3. Select the desired cameras as well as start and end times of the recording to be searched. Also select the type of bookmark to be searched.

If searching for customized bookmarks, enter a keyword from the bookmark name.

Click **Search**. The list of bookmarks appears.

4. Select the desired bookmark from the list.
5. Select a bookmark and do one of the following:
 - Click the **Edit** button to edit a bookmark’s name.
 - Or -
 - Click the **Delete** button to delete a bookmark.
 - Or -
 - Click the **Play** button to play back a bookmark.

Search snapshots

You can search video snapshots. See “Live view mouse menu” on page 30 on how to create snapshots.

To search for snapshots:

1. In live view right-click the mouse on the desired video pane and select **Search Video**. The Search menu appears.
2. In the Search menu, click the “Snapshot” tab.
3. Select the desired cameras as well as start and end times of the recording to be searched.
4. Click **Search**. The list of snapshots appears.
5. Select a snapshot to see it in the thumbnail window. Click its **Play**  button to see it in full-screen mode.
6. When in full-screen mode, move the cursor to the right edge of the window to see the complete list of snapshots found in the search. Click their Play buttons to see them in full-screen mode.

7. To see a slideshow of all the snapshots found, click the ► or ◀ buttons on the snapshot toolbar to sequence forwards or backwards through the shots.

Log search

You can open video footage from the results of a log search. Refer to “Search the system log” on page 111 for more information.

Chapter 7

Playback functionality

The recorder lets you quickly locate and play back recorded video. There are three ways to play back video:

- Instant playback of the most recently recorded video
- 24-hour playback of one day's recorded video
- Search video by specific time, events, bookmarks, or snapshots (see Chapter 6 "Searching files" on page 36 for further information)

The recorder continues to record the live view from a camera while simultaneously playing back video on that camera display. You must have the access privilege to play back recordings (see "Customize a user's access privileges" on page 104 for more information).

Figure 13: Playback window (24-hour playback shown)

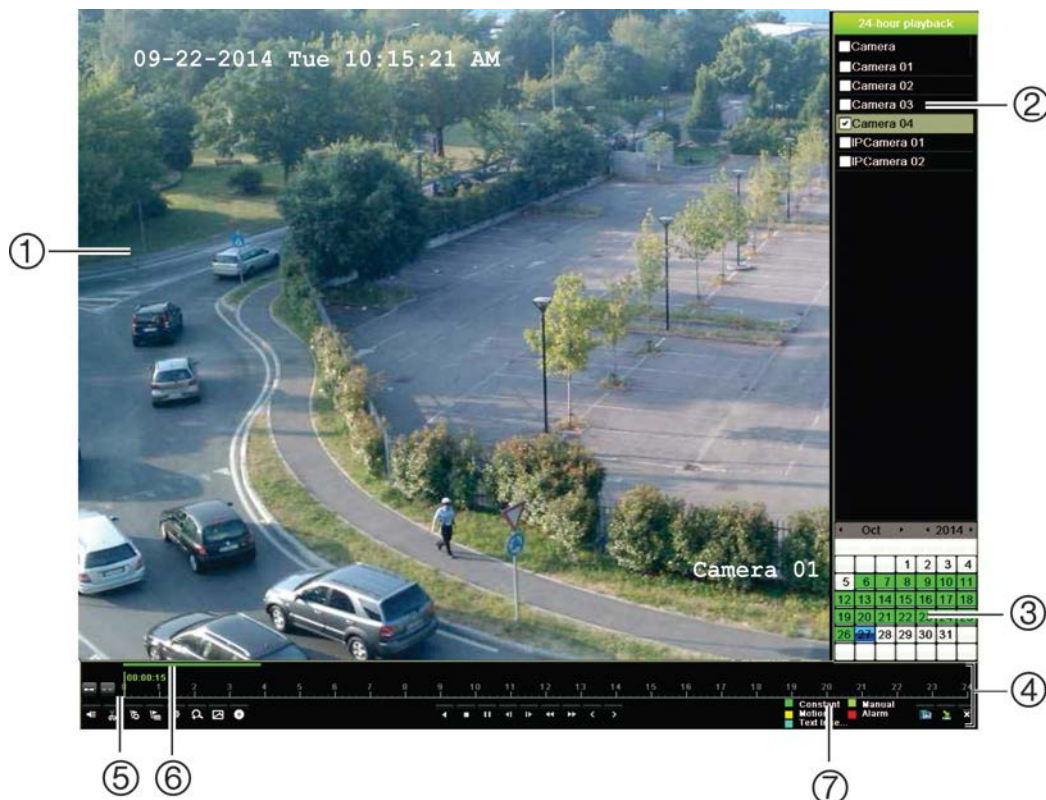

1. Playback viewer.
2. **Camera panel.** Select the cameras for playback. Move the mouse over the area to display the list of cameras available.
3. **Calendar panel.**
 Blue: Current date
 Green/Yellow/Red: Recordings available on the recorder.
4. **Playback control toolbar.** See Figure 14 below for more information.
5. **Time bar:** Time of actual playback. This is only displayed in 24-hour playback.
6. **24-hour recording progress bar:** This bar displays how much of the 24-hour period has been recorded.
7. **Recording type:** Description of the color coding of recording types that appear in the playback progress bar. Green indicates constant recording. Red indicates alarm recording. Yellow indicates motion recording. Pale green indicates manual recording. Pale blue indicates text insertion.

The playback control toolbar







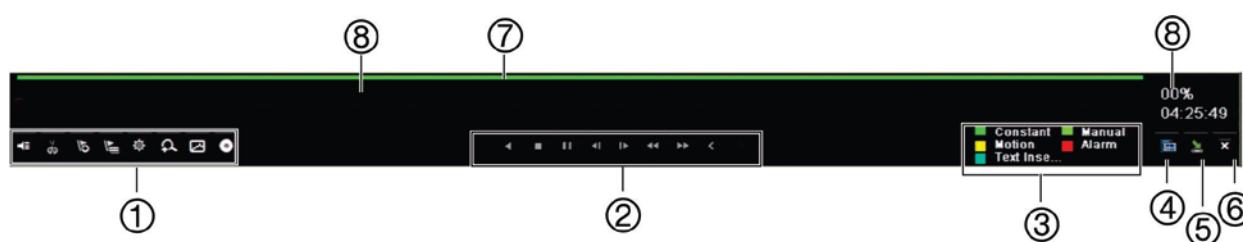

It is easy to manually control playback using the playback control toolbar. See Figure 14 below.

Note: The playback control toolbar does not appear for instant playback.

Figure 14: Playback control toolbar (Search playback example shown)



Item	Description
1.	Audio and video control toolbar: <ul style="list-style-type: none"> / Audio on/off. / Start/stop a video clip during playback. Sections of a recording can be saved to an external storage device. Add default bookmark. Add customized bookmark. Bookmark management. Click to see the list of bookmarks and their times. They can be renamed or deleted. Digital zoom. Click to enter the digital zoom function. Click again to exit. See “Digital zoom” on page 33 for more information. Archive files.
2.	Playback control toolbar: <ul style="list-style-type: none"> Reverse play the recording. Click again to pause. Stop playback. Time displayed is 00:00:00. Play recording. Fast forward playback by the configured skip time (default is 30 seconds).

Item	Description
	 Reverse playback by the configured skip time (default is 30 seconds).
	 Decrease playback speed: Options available are: ½ speed, ¼ speed, 1/8 speed, single frame.
	 Increase playback speed. Options available are: 2X speed, 4X speed, 8X speed, 32X speed.
	 Play previous file/day/event recording.
	 Play next file/day/event recording in the search result.
3.	Recording type: Description of the color coding of the five recording types that appear in the playback progress bar. Green indicates continuous recording. Yellow indicates motion detection. Blue indicates text insertion. Pale green indicates manual recording. Red indicates alarm recording.
4.	 Call up the Search window to search for recorded video files.
5.	 Hide the playback control toolbar.
6.	 For 24-hour playback mode, quit playback and return to live view. For playback from search mode, quit playback and return to the search window.
7.	Playback bar: This bar displays the playback recording. It indicates in color the type of recording. Constant recording is shown in the example above.
8.	Timeline: Allows you to jump forwards or backwards in time. The timeline moves left (oldest video) to right (newest video). Click a location on it for where you want playback to start. In 24-hour playback, the cursor shows the actual time. In search playback, the cursor is a ball. The actual playback time of the ball position and how much playback has already played are also displayed.

Playback mouse menu

You can quickly access playback options by placing the cursor on a playback image on-screen and clicking the right-button of the mouse. The playback pop-up menu appears (see Figure 15 below). The list of options available depends on the type of playback.

Figure 15: The playback pop-up menus

24-hour playback:



Search result playback:

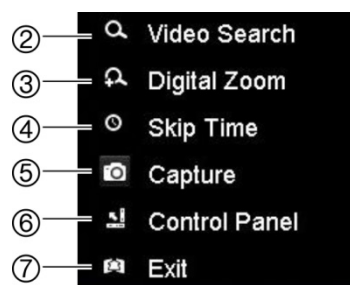



Name	Description
1. Camera	Select a camera for playback.
2. Video Search	Return to the Search window.
3. Digital Zoom	Enter the digital zoom function for the selected camera. See “Digital zoom in playback” on page 47 for more information.
4. Skip Time	Modify the playback skip time. See “Playback speed and skip time” on page 45 for more information.
5. Capture	Capture a snapshot of the video.
6. Control Panel	Hide or display the playback control toolbar.
7. Exit	Return to live view or video search.

Instant playback

Use the live view toolbar to perform instant replay of a predefined period (default time is five minutes). This can be useful to review an event that has just happened. Only one camera at a time can be selected.



You can modify the playback period in the Instant Replay Duration menu. See page 85 for further information.

To instantly replay recorded video:

1. In live view mode, left-click the mouse on the desired camera image. The live view toolbar appears. Click the Instant Playback icon .
2. Click the Channel icon  and select the desired camera from the drop-down list. Click **OK**.

Playback starts immediately. The Instant Playback scroll bar appears under the selected camera.



3. Click **Pause**  on the toolbar to pause playback.
Click **Play**  to restart playback.
Click **Stop**  to stop playback and return to live view.

24-hour playback

Use this option to access one day of video recordings for the selected camera. Playback starts at midnight and runs for the 24-hour period. 24-hour playback is shown in full-screen view. See Figure 14 on page 42 for a description of the playback control toolbar.

• Using the mouse:

1. In live view mode right-click the mouse on the desired camera image. In the mouse toolbar, click **24-hour Playback**.

The playback screen appears. By default, the camera is in full-screen mode.

2. To select more than one camera for synchronous playback or to select playback from a different day, move the mouse to the right edge of the screen. The camera list and calendar appear. Check the desired cameras and/or another day. Up to 8 cameras can be selected.

Playback starts immediately you have selected the camera and times.

Note: A message appears if there are no recordings found during this period.

3. Use the playback control toolbar to manually control playback.
4. Click **Exit**  to return to live view.

– Or –

Right-click the mouse and click **Exit** from the mouse menu to return to the previous window.

• Using the front panel:

1. Select the camera for playback and press the **Play** button. Playback from the selected camera starts immediately.

Note: Synchronous playback is only available using the mouse. If live view was showing multiview, only the camera in the top-left channel on screen will be played back.

2. To select a different camera for playback, press the numerical button of the desired camera.
3. Press **Live** to return to live view.

Playback speed and skip time

Use the direction buttons on the front panel to modify the playback speed, and to jump forwards or backwards.

The default skip time is 30 seconds. However, you can easily change it.

To set the playback skip time:



1. In playback mode, right-click the mouse and click **Skip Time** on the pop-up menu. The Skip Time menu appears.
2. Select a skip time between 10 and 300 seconds. The default skip time is 30 seconds.

To change the playback speed:

From the front panel:

Press the left and right buttons to speed up and slow down recorded video.

From the playback window using the mouse:

Click  and  to speed up and slow down recorded video.

To skip forwards or backwards during playback:

From the front panel:

Press the up and down buttons to jump recorded video forwards and backwards by a set skip time.

From the playback window using the mouse:

Click  and  to jump recorded video forwards and backwards by a set skip time.

— Or —

Click a location on the timeline for where you want playback to start.

Playing back frame-by-frame

You can play back a selected video at different speeds. This allows you to carefully examine an event frame-by-frame as it happens.

The current frame rate is shown on the right of the playback control toolbar.

To play back frame-by-frame:

• Using a mouse:

1. In playback mode click the **Speed Down**  button in the playback control toolbar until the speed changes to single frame.
2. Click the **Pause** button to advance the video frame by frame.

• Using the front panel:

1. In playback mode move the left direction button to left to scroll down through the speed changes until single frame.
2. Press **Enter** to advance the video frame by frame.

Digital zoom in playback

You can zoom in on an image during playback to see it in greater detail. There are two ways to perform digital zoom in playback.



To digitally zoom-in during playback:

1. In playback mode, right-click the mouse and select **Digital Zoom** in the pop-up menu.
— Or —
Click the Digital Zoom icon in the playback control toolbar.
The playback control toolbar disappears. The digital zoom window appears.
2. Left-click the mouse and drag the red square in the digital zoom window to the area of interest, or move the joystick on the front panel to position the red square. The selected area is magnified.
3. Right-click the mouse to quit the digital zoom mode and return to full-screen playback mode. The playback control toolbar reappears.

Creating bookmarks

You can bookmark the important scenes in a recorded file for later reference.

Bookmarks flag the start of a scene. Up to 64 bookmarks can be saved in a video file. There are two types of bookmarks:

- **Default bookmark** : All default bookmarks have the same generic name, "BOOKMARK".
- **Customized bookmark** : The bookmark is given a name for easy identification. The same name can be used for several bookmarks.

You can search both types.

To create a bookmark:

1. Open a 24-hour playback window or the playback window from a search result.
2. In the playback recording, click the timeline bar where you want the bookmark to be. The green time line jumps to this position. Click the button for the type of bookmark you want, and enter the bookmark name if required.

In the playback recording from a search, click the scroll bar where you want the bookmark to be. The scroll bar ball jumps to this position. Click the button for the type of bookmark you want, and enter the bookmark name if required. The bookmark is saved.

3. Click the bookmark management  button to see the list of bookmarks saved. The name of a bookmark can be edited. The bookmark can also be deleted.

Chapter 8

Archiving files

Archive recorded files on an external device such as USB flash drive, USB HDDs or a DVD burner. You must be in live view to archive video. Access to archive commands may require a password.

Before starting to archive files, ensure that you have the backup device connected to the recorder. It can be detected automatically by the recorder.

Note: The recorder supports USB DVD and USB HD on the front and back USB ports.

Archiving files

There are two ways to archive files:

Quick Archive button: Quick archive lets you archive recorded files quickly by using the Archive button on the front panel. The recorder then downloads all the recorded files on the unit to fill the available memory space on the media. This option is not available via the mouse.

Search results window: In many search results windows there is an “Archive” button. Click it to bring you to the archive window of the selected video in the search result.

Quick Archive

To archive recorded video using Quick Archive:

1. Insert the backup device into the recorder.
If using a USB memory drive, insert the device into the USB port on the front panel. If more than one media type is found, the USB device takes precedence over the others.
2. Press **Archive** on the front panel or remote control to open the quick archive window.
3. Click **Start** or press **Archive** on the front panel again. The unit starts to download all the files listed.

Note: If there is a capacity limitation on the backup device, only the most recent files will be backed up.

A message will appear to confirm when the download is complete.

Archive menu

You can insert a mini-USB hub to the USB port to attach a mouse for navigation or a USB drive for archiving. However, the unit may not support all types of USB hubs.

The Archive options available may depend on the type of backup device selected.

Figure 16: Example of an archive menu

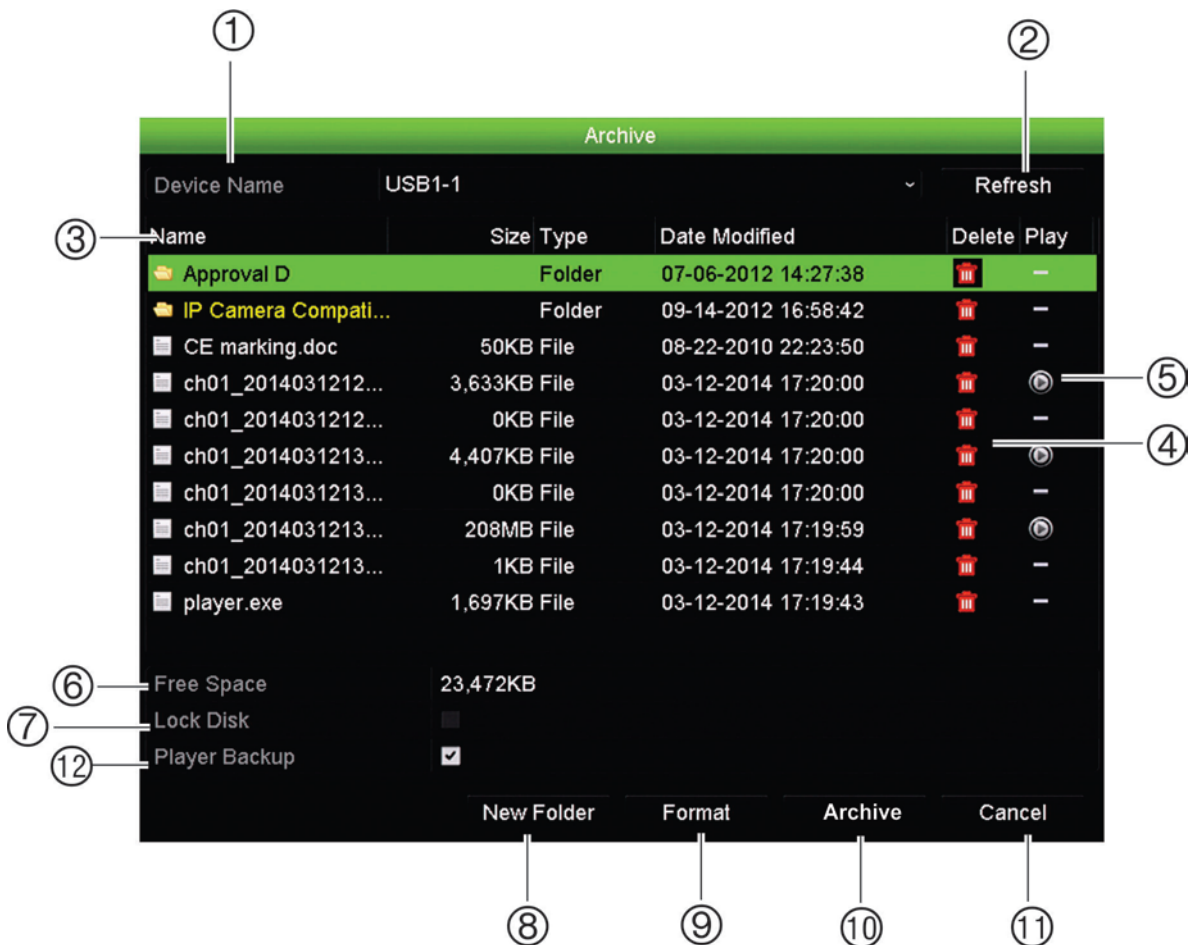

Function	Description
1. Device name	Select one of the storage media for archiving. If the backup device is not recognized: <ul style="list-style-type: none"> • Click the Refresh button • Reconnect device • Check for compatibility from vendor
2. Refresh	Refresh the search results if any parameters have been modified.
3. Name	Files found on the backup device are listed.
4. Delete	Click to delete a selected file from the backup device.

Function	Description
5. Play	Click to play selected file.
6. Free space	Free space available on the backup device is displayed.
7. Seal disc	Select to prevent other files being recorded onto the disc.
8. Include Player	Select to automatically include the Player tool when archiving files.
9. New folder	Create a new folder on the backup device. Files from the recorder can be archived to a specific folder.
10. Format	Format the USB/eSATA drive.
11. Archive	Start downloading selected files onto the backup device.
12. Cancel	Cancel search and return to previous menu.

To export recorded files to a backup device:

1. Connect the backup device to the recorder.

If using a USB memory drive, insert the device into the USB port on the front panel. If using a digital video disk (DVD) or eSATA drive, insert the disc into the DVD drive. If both media are found in the recorder, the USB device takes precedence over the DVD.

2. In live view mode press the **Search** button on the front panel or remote control.

- Or -

Right-click the mouse and select **Advanced Search**.

The Advanced Search window appears.

3. Select the cameras and search parameters required.
4. Click **Search**. The list of results appears.
5. Select the files to export.

Note: You can click the Play button to verify that the selected files are the files to export.

6. Click **Archive**. The Archive window appears.
7. Select the storage medium to export to from the drop-down list.
8. Click **Archive** to begin the backup process.



Create and archive video clips

You can save important scenes in a recorded file for later reference by creating video clips of selected portions of the file during playback. When an intruder, for example, crosses in front of several cameras you can save the video clip of the intruder's path across these cameras in a single file.

Up to 30 video clips can be made from a recording.

Note: This feature is only available using the mouse.

To export video clips during playback:

1. Connect the backup device to the recorder.
2. Search for the required files to play back. See “Search video menu” on page 36.
3. Select the file or files to play back and click **Play**. Playback starts immediately.
4. Click the playback timeline where you want the video clip to start and click the **Start Clipping**  button.
5. Click the playback timeline where you want the video clip to stop and click the **End Clipping**  button.
6. Repeat for additional clips.
7. Exit playback mode. A message appears asking if you want to save the video clips.
8. Click **Yes** to archive the clips. The Archive window appears.
Click **No** to exit and return to the search results window. The clips are not saved.
9. In the Archive window select from the drop-down list the backup device to be used.
10. Click **Archive**. File downloading starts.

Note: You can create a new folder for the video clips. Press the **New Folder** button and enter the folder name.

Playing back archived files on a PC

Use the standard file player software, TruVision Player, to play back the archived video on your PC. It is downloaded automatically from the recorder when archiving files onto a backup device.

Note that in some cases a limited file player is included in the recorder. If so, when opening the file player on your PC, the software will prompt a message stating that a full version of the player is available for download from our website.

Chapter 9

Display settings

Use the Display Settings menu to modify how the camera images appear on screen.

Display settings

Use the Display Settings menu to adjust the settings related to the local monitor output of the recorder, such as selecting the main and event monitors, multiview layout, display the monitor time bar, sequence dwell time options, and enable or disable the local audio output. See Figure 17 below.

Figure 17: Display Settings window

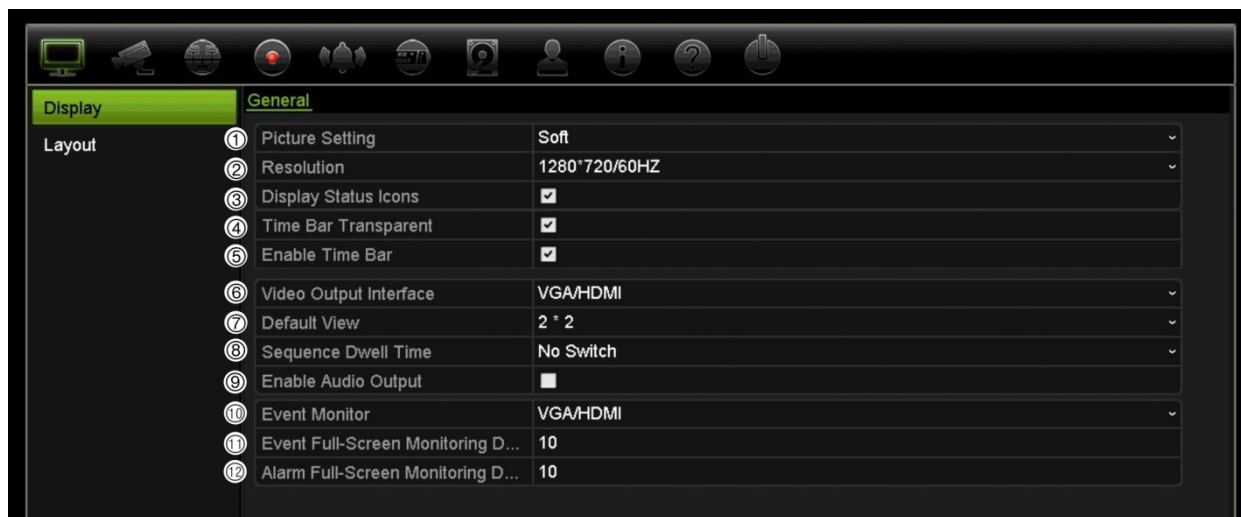

Table 10: Description of the Display setup window

Option	Description
1. Picture Setting	Define the desired output mode. Select one of the options from the drop-down list: Standard, Bright, Soft, or Vivid, and click Apply .

Option	Description
2. Resolution	Define the resolution of the selected monitor. Select one of the options from the drop-down list and click Apply . The selected resolution must be the same as that of the monitor.
3. Display Status Icons	Define whether the status icons are displayed. Default is Enable.
4. Timebar Transparent	Select the transparency of the monitor output time bar on screen relative to the background to make the time bar easier to read. Check the box to enable/disable. Default is Disable.
5. Enable Timebar	Select whether the monitor output time bar appears on screen. Check the box to enable/disable. Default is Enable.
6. Video Output Interface	Select the desired video output interface to apply: VGA/HDMI. Default is VGA/HDMI.
7. Default View	The factory default multiview format displays all channels (2x2 layout for the 4-channel NVR 10 and 4x4 layout for the 8/16-channel NVR 10).
8. Sequence Dwell Time	Set the length of time for which a camera image is displayed on the selected monitor before moving to the next camera during sequencing. Default is off ("No Switch").
9. Enable Audio Output	Select whether to hear audio from cameras in both live and playback mode. However, in order to be able to hear audio in playback, you must enable the audio output setting. Default is Disable. Check the box to enable/disable audio output.
10. Event Monitor	Select which monitor will be the event monitor showing full screen monitoring in case of events: HDMI/VGA. Default is HDMI/VGA.
11. Event Full Screen Monitoring Dwell Time	Set the length of time during which an image is displayed on the event monitor in full screen in case of an event. Default is 10 seconds.
12. Alarm Full Screen Monitoring Dwell Time	Set the length of time during which an image is displayed on the event monitor in full screen in case of an alarm. Default is 10 seconds.

Layout

The Layout window allows you to define the layout of each of the different views as they are shown when selecting the different live views or the sequencing order.

The cameras are sequenced in numeric order by default. You can change the order of the cameras for all monitors.

The camera order in the different views is consistent. This means that if Channel 2 is the first camera shown in the single camera view then it will also be the top left camera of the 4-channel view.

You can switch the channel of a camera with that of another camera in the system. This lets you, for example, have the images of camera 1 appear on channel 10, and the images of camera 10 appear on channel 1. This feature is useful when you want to watch the sequence of images from specific cameras so that they are next to each other on-screen.

See Figure 18 below. Each video tile displays both the order of the camera on screen and the camera number.

Figure 18: Camera layout window

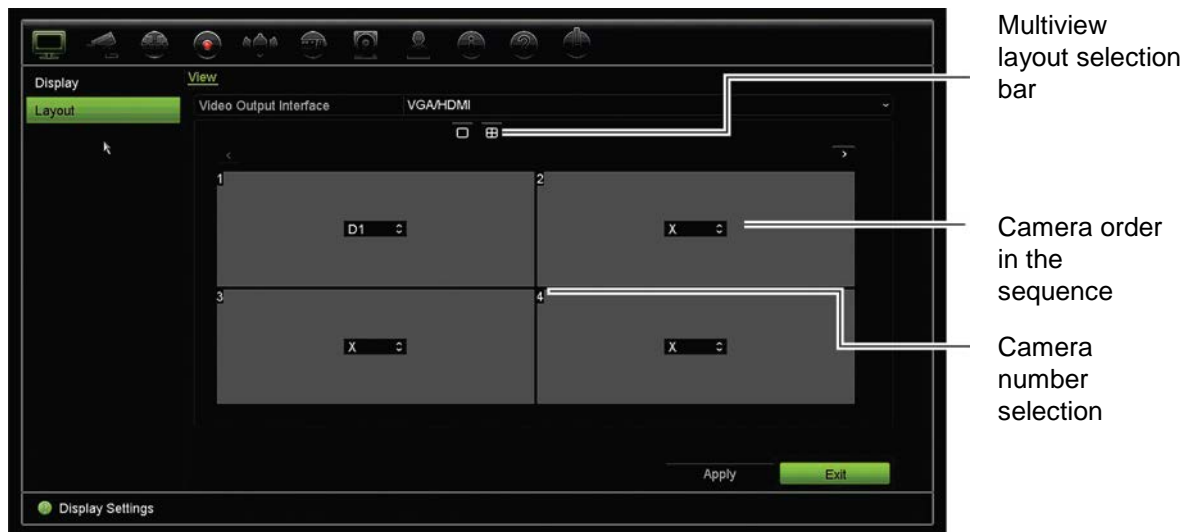

Chapter 10

Camera setup

Use the Camera Setup menu to configure IP cameras. You can also configure the camera status, OSD, snapshots, recording settings, image settings, PoE setup, motion detection, privacy masking, camera tampering, restrict access, PTZ configurations and VCA settings.

Note: Not all settings are available for IP cameras. For advanced IP camera settings, please consult the IP camera web browser interface.

Supported IP cameras

The NVR supports TruVision and UltraView IP cameras as well as TVE encoders. It supports a wide range of third party IP cameras through compliancy with the Onvif and PSIA standards for open camera communication.

IP camera status

The IP camera status menu allows you to add, edit and remove cameras to the recorder, as well as update the cameras' firmware.

Figure 19: IP camera window



Table 11: Description of the IP camera window

Option	Description
1. IP camera list	This shows the list of IP cameras added to the recorder. The camera information shown is: Camera No., Status, PoE port, Edit, Advanced Set, Live View, Camera Name, IP Camera Address, Manage Port, Protocol, Device Model, Serial Number, and Firmware.
2. Sync Password	Change the cameras password or Sync with the “admin” password.
3. Manual Add	Add the selected cameras from the search results list to the recorder system without modifying the camera configuration.
4. Device Search/Add	Search the network for available IP cameras. Add an IP camera to the recorder system.
5. Upgrade	Upgrade IP camera software. Insert USB flash drive in the recorder and select the upgrade file. The camera will automatically reboot once the software is upgraded.
6. Delete	Delete the selected IP camera from the list.
7. Refresh	Update the information displayed on a camera in the recorder device list.

To automatically add an IP camera:

1. From the menu toolbar, click **Camera Setup > IP Camera Status**.
2. Click **Device Search/Add** to search for any supported IP cameras located in the recorder LAN.

Note: To change an IP camera’s IP address prior to adding it to a recorder, in the device’s search/add pop-up window, click ‘Edit’ and enter the required IP address as well as the IP camera’s credentials to change its IP address.

3. Check the boxes of the cameras that you want to add to the recorder.
4. Click **Add** to add the selected cameras to the list of devices in the recorder. Click **Done** when complete in order to return to the main window.

The cameras are added to the end of the list of devices.

- To test if a camera connection is operational, select the desired camera from the list of devices connected to the recorder and click **Live**. A pop-up window should appear showing the camera's live view.

Note: If cameras still have default settings, they might have the same IP addresses. This creates an IP conflict. Use the Edit button to assign a different IP address to each camera. Before adding the IP camera to the recorder, use the Edit button to assign a different IP address to each camera. Ensure that for each camera to successfully connect the cameras.

To manually add an IP camera:

- From the menu toolbar, click **Camera Setup > IP Camera Status**.
- Click **Manual Add**. In the pop-up window, enter the camera details such as the IP camera address/domain, protocol, management port, user name and password. Click **OK**.

The camera is added to the end of the list of devices.

Note: Only one camera can be manually added at a time.

Camera recording settings

The camera recording settings allow you to define the configuration per camera per stream recording mode.

To configure recording settings:

- From the menu toolbar, click **Camera Recording Settings**.



- Select the camera you want to configure.

3. Configure the following recording settings (options available depend on the camera model):

- **Stream Record Mode:** Select one of the stream types to configure the recording parameters of that record mode: Mainstream (TL-Hi) (default), Mainstream (TL-Lo), Mainstream (Event), Mainstream (Alarm), or Substream.
- **Stream Type:** Select the type of stream to record, either video or video and audio.
- **Resolution:** Select the resolution of the recording. Options include: 1920*1080 (1080P), 1280*720 (HD720P), 960*576 (960H), 704*576 (4CIF), 640*480 (VGA), 352*288 (CIF).
- **Bitrate Type:** Select Variable (default) or Constant. If “Variable” is selected, the bandwidth can vary depending on video quality and the bandwidth required. If “Constant” is selected the video streaming is always at the maximum bit rate selected.
- **Video Quality:** Select the quality at which to record. If “Constant” is selected as the bit rate type, this option is unavailable.

If a low video quality is selected, the image quality is poorer and the bandwidth required is reduced thereby allowing recording over a longer period of time.

- **Frame Rate:** Select the recording frame rate.
- **Max. Bitrate mode:** Select the general (Default) or customized option.
- **Max. Bitrate (kbps):** If the customized maximum bit rate mode was selected, enter the value here. It must be between 32 and 4096 kbps. It is calculated from the frame rate and time required. Default is 1792.
- **Pre Event:** This is the time the camera starts recording before the event. Select the time in seconds from the list to start pre-recording before the event. Default is 5 seconds.

The maximum pre-recording times available depend on the constant bit rate. See “Maximum storage times” in the appendix.

- **Post Event:** This is the time the camera continues to record after the event. Select the time in seconds from the list to stop post-recording after the event. Default is 5 seconds.
- **Auto Delete (day):** Select the number of days after which recorded video from the specified camera is permanently deleted from the HDD. A “day” is defined as the 24-hour period from when the auto delete mode (ADM) was set.

The maximum number of days that can be set is 9999. However, the actual number of days permitted depends on the HDD capacity. If the value is set to ‘0’, the option is disabled. Default is disable.

- **Record Audio:** Enable to record sound with the images. Default is enable.

4. Click **Apply** to save the settings.

5. Click **Apply** to save the settings.

PoE setup

It is important when installing IP cameras to calculate the total power consumption required so that it is less than the power budget of the NVR switches. The NVR lets you easily track on-screen the current and remaining power consumption for all cameras directly connected to its switches. See Figure 20 below.

Figure 20: PoE power budget information on IP cameras



1. Select the PoE type required for each camera.
2. Dynamic tracking of the current PoE power consumption (blue), unallocated PoE power (white), and remaining allocated PoE power budget (green) shown.

The IP cameras will specify which type of PoE they require. You can set up each camera individually for no PoE, PoE-at, PoE-af, or 15 W. A PoE port can support up to 30 W maximum.

The NVR has a maximum of eight PoE ports, depending on the model. The total PoE power budget for the 4-channel NVR is 50 W, and that for the 8 and 16-channel NVRs is 120 W.

The PoE-af port can support between 0 and 15.4 W and the PoE-at port can support between 0 and 30 W. See Table 12 below for a description of the maximum number of IP cameras that can be connected depending on the PoE type used.

Table 12: Maximum number of IP cameras that can be connected by PoE power consumption

NVR	12.5 W	15 W	PoE-af	PoE-at
4-channel	4	-	3	1
8-channel	-	8	7	4
16-channel	-	8	7	4

To display the PoE power consumption information:

1. From the menu toolbar, click **Camera Management > Camera > PoE Setup**.
2. Select the PoE type required for each camera: No PoE, PoE-af, PoE-at, or 15.0 W.
3. Click **Apply** to save the settings and then click **Back** to return to live view.

Snapshots

You can define the image quality and resolution of snapshots for each camera. Snapshots can be taken at any time during live view or playback, or can be created when an alarm occurs and sent by email or sent to an FTP server.

To configure snapshots:

1. From the menu toolbar, click **Camera Setup > Snapshots**.
2. Select the desired camera.
3. Select the snapshot resolution from the drop-down list.
Select QCIF, CIF, 4CIF, or Maximum. Maximum is the maximum available resolution from the camera. For IP cameras, this is the resolution being recorded.
4. Select the snapshot quality from the drop-down list (low, medium or high).
5. Click **Apply** to save the settings.
6. To copy the settings to other cameras, click **Copy** and select the desired cameras. Click **OK**.
7. Click **Exit** to return to live view.

Camera OSD

The recorder lets you configure which information is displayed on-screen for each individual camera.

The on-screen display (OSD) settings appear in live view mode and include the camera name, time and date. They are part of the image and are therefore also recorded.

To configure the OSD settings:

1. From the menu toolbar, click **Camera Setup > Camera OSD**.



2. Enter a name for the camera (1), if required. The name can have up to 32 alphanumeric characters.
3. Check the **Display Name** (2), **Display Date** (3), and **Display Day** (4) boxes to display the camera name, date, and week.
4. Select a date format and a time format (5).
5. Select how you want the camera information displayed (6).
Select one of the options from the drop-down list. Default is non-transparent/non-flashing.
 - Transparent & Flashing
 - Transparent & Not flashing
 - Non-transparent & Flashing
 - Non-transparent & Not flashing
6. To change the size of the OSD font displayed, select one of the options from **OSD Font** (7).
7. There are two colored text boxes in the camera view window; one for the camera name (red box) and the other for the date/time (yellow box). Using the mouse, click and drag a text box to the display position (8).
8. To copy the settings to other cameras, click **Copy** and select the desired cameras. Click **OK**.
9. Click **Apply** to save the settings and then click **Exit** to return to live view.

Image settings

The Image tab allows you to adjust image settings for each individual camera channel.

You may need to adjust the camera image depending on the location background in order to get the best image quality.

The system has image settings for frequently encountered lighting conditions; Standard, Indoor, Dim Light and Outdoor. You can also manually adjust the brightness, contrast, saturation, hue and saturation values.

You can modify the digital noise reduction (DNR) value to improve image quality. This function removes image noise from a video signal, which can be more pronounced in low light conditions.

Note: These options can also be modified from the image settings button on the live view toolbar (see “Live view toolbar” on page 32).

To adjust display settings:

1. From the menu toolbar, click **Camera Setup > Image**.
2. Select the camera for which to adjust the video image settings (Standard, Indoor, Dim Light, or Outdoor).
3. Adjust the brightness, contrast, saturation, hue, sharpness and digital noise reduction values by dragging each scroll bar.

Click the **Default** button to return image setting values to the default position.

4. Click **Apply** to save the settings and then click **Exit** to return to live view.

Motion detection

The motion detection menu allows you to enable or disable motion detection for each camera, as well as create motion grids, set the sensitivity of the motion detection and link motion detection to a specific action.

To set up motion detection:

1. From the menu toolbar, click **Camera Setup > Motion**.
Areas covered by the red grid are sensitive to motion detection.
2. Select the camera to detect motion. Each camera must be set up individually.
3. Check **Enable Motion Detection**. If this is not enabled, motion will not be recorded.
4. Select the areas on-screen to be sensitive to motion.

Click and drag the mouse cursor across the window to deselect areas sensitive to motion detection.

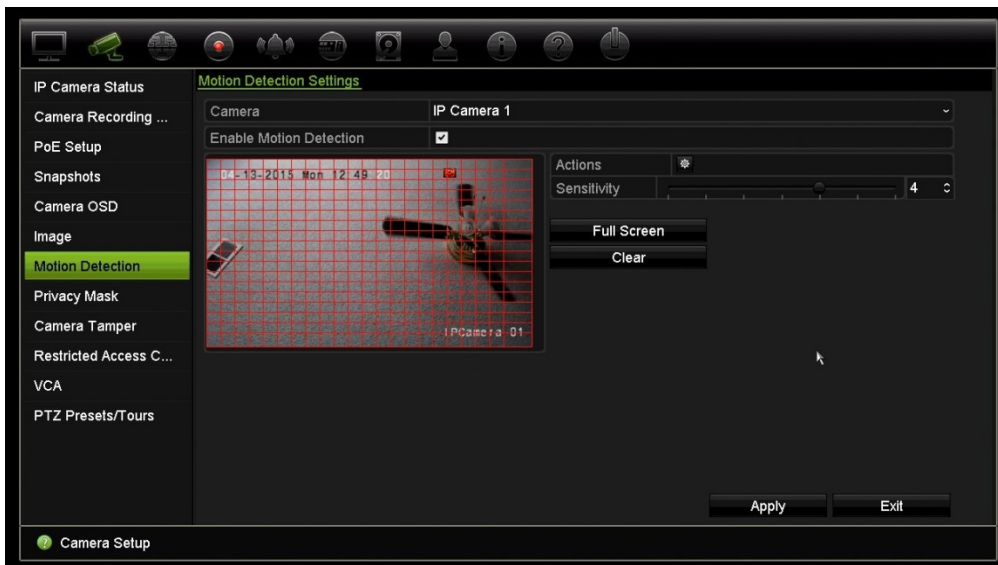

Click **Full Screen** to activate the whole screen or **Clear** to clear the screen.

5. Set the sensitivity level.

Drag the Sensitivity scroll bar to the desired sensitivity level. Default is 3.

6. Specify the target size.

In the Target Size option, specify how many grid squares must be activated before motion is detected. Enter a value between 0 and 255 squares. Default is 1 square.

7. Select the cameras that will start the motion recording schedule once motion is detected.

Click **Actions**. The Actions window appears. Click the **Trigger Channel** tab and select the cameras that will record when a motion alarm is triggered. Click **Apply** to save the settings.

8. Select the arming schedules for motion detection.

In the Actions window, click the **Arming Schedule** tab and select the day of the week and the time periods during the day when motion can be recorded. You can schedule up to eight time periods in a day. Default is 24 hours.

Click **Apply** to save the settings. Click **Copy** to copy the settings to other days of the week.

Note: Time periods defined cannot overlap.

9. Link the corresponding action to motion detection.

In the Actions window, click the **Actions** tab to define the method by which you want the recorder to notify you of the alarm (see page 89 for the list of alarm notification types available). “Notify Alarm Host” is the default selection. More than one option can be selected.

Click **Apply** to save settings.

10. Click **OK** to return to the motion detection settings window.

11. Click **Exit** to return to live view.

Privacy mask

You can define an area on screen to remain hidden from view and recording. For example, you can choose to block the view of a camera when overlooking residential premises. This hidden area is referred to as privacy masking. Privacy masking cannot be viewed in live view or recorded mode, and appears as a black area on the video image.

For IP cameras, the amount of privacy masks is determined by the amount supported by the camera.

To setup a privacy mask:

1. From the menu toolbar, click **Camera Setup > Privacy Mask**.
2. Select the camera for which to set up privacy masking.
3. Check the **Enable Privacy Mask** box to enable the feature.
4. Set up the mask area. Up to four areas can be set.

Using the mouse, click and drag a privacy-mask box in the camera view window over the desired area. You can set up to four areas for privacy masking. Masked areas are dimmed and outlined in four different colors. Click **Apply** to save settings.

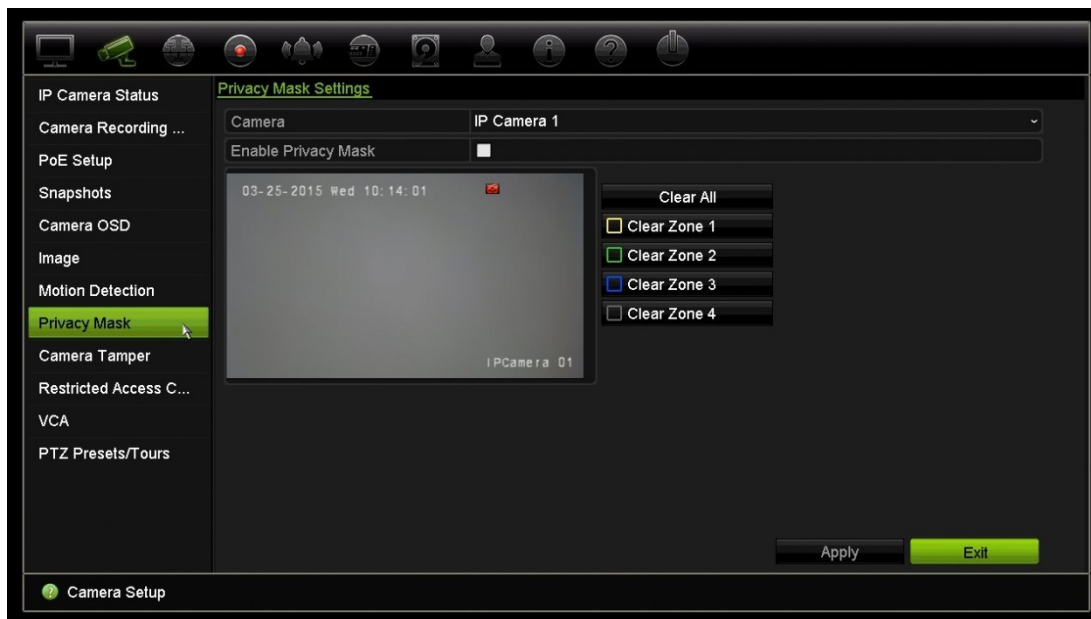

To delete a mask, check the desired mask and click **Clear** for that color mask.

5. To copy the settings to other cameras, click **Copy** and select the desired cameras. Click **OK**.
6. Click **Apply** to save the settings and then click **Exit** to return to live view.

Camera tamper

You can setup the recorder to alert you when the camera view has changed such as when someone has deliberately blocked the camera view by spraying paint on the lens or by moving the camera. Tampering detection only applies when the whole image is covered and all light is blocked. You cannot select a specific area of the camera screen to detect tampering.

Note: It is strongly recommended not to configure for video tampering when using PTZ dome cameras.

To set up video tampering detection:

1. From the menu toolbar, click **Camera Setup > Camera Tamper**.
2. Select a camera to configure for video loss detection.
3. Check the **Enable Tamper-proof** box to enable the feature.
4. Select the tamper detection sensitivity level by clicking the sensitivity scroll bar. Higher sensitivity is to the right of the bar.
5. Select the recording schedules for the tamper.

Click **Actions** and then select the **Arming Schedule** tab to select the day of the week and the time periods during the day when motion can be recorded. You can schedule up to eight time periods in a day. Default is 24 hours.

Click **Apply** to save the settings. Click **Copy** to copy the settings to other days of the week and holiday period.

Note: The time periods defined cannot overlap.

6. Select the response method to an external alarm.

Click **Actions** and then select the **Actions** tab to select the method by which you want the recorder to notify you of the alarm: Full-screen monitoring, Enable alarm audio, Notify alarm host, Send email, and Trigger alarm output. See page 89 for the list of alarm notification types.

Click **Apply** to save settings and then **OK** to return to the main window.

7. Click **Exit** to return to live view.

Restricted access camera

Restricted access cameras are cameras that are only visible to specific users.

There may be occasions when you want to control who can see a camera image on a local monitor, such as if there is a camera located in a changing room. The recorder lets you select which camera (or cameras) is not displayed on the local monitor unless the user is logged in and has permission to view the camera images. A restricted access camera is not displayed on screen when no user is logged in. Instead a person walking by sees a black screen. See Figure 21 below.

Figure 21: Example of a restricted access camera image

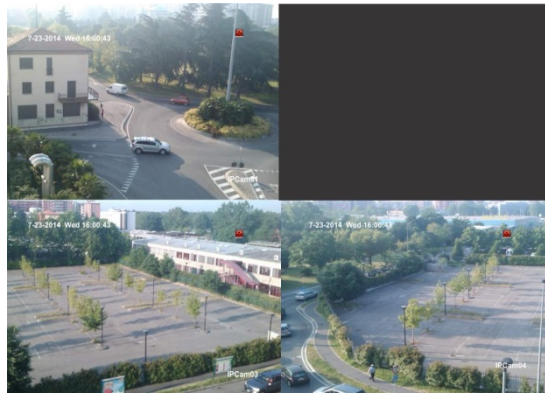

To set up a camera for a restricted access view:

1. From the menu toolbar, click **Camera Setup > Restricted Access Camera**.
2. Check which IP camera or cameras you want to have restricted access and click **Apply**.
3. Click **Exit** to return to live view.

VCA Setup

You can link actions to a VCA alarm from IP cameras that support this feature.

To setup VCA alarm actions:

1. From the menu toolbar, click **Camera Setup > VCA**.
2. Select the camera for which to set up the VCA alarm.
3. Check the **Enable VCA Alarm** box to enable the feature.
4. Click the **Actions** button to define which actions are required with the VCA events from each camera.

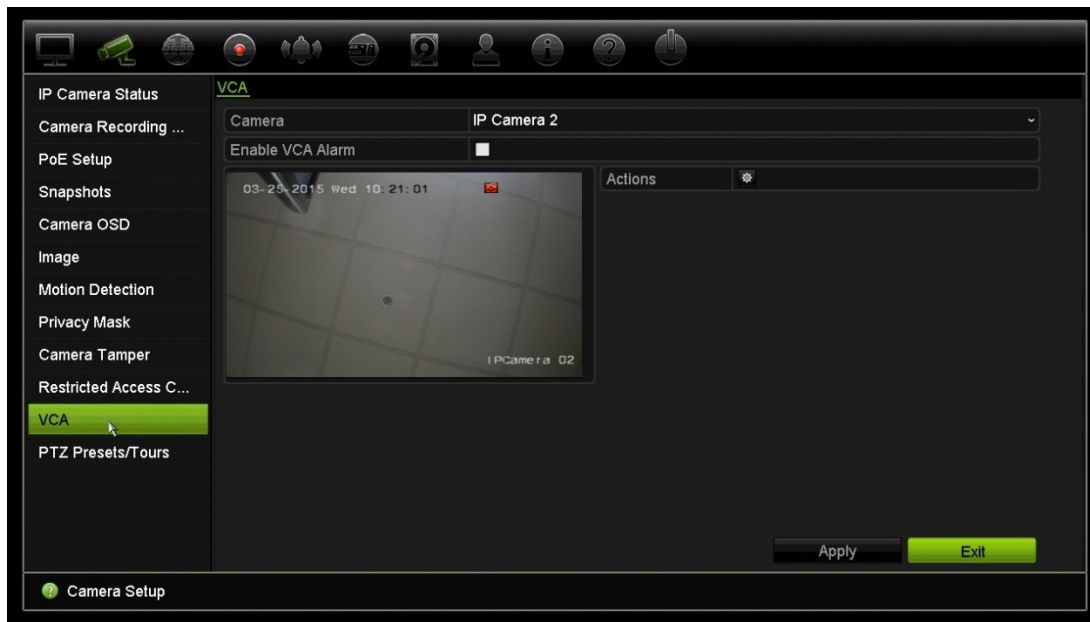

5. Click **Apply** to save the settings and then click **Exit** to return to live view.

Configure PTZ settings

Use the **PTZ Setup** menu to configure IP cameras.

Ensure that the PTZ dome cameras are correctly connected to the RS-485 port on the back panel.

Note: If a camera does not work correctly after configuring the recorder, check the parameters entered.

To configure PTZ dome camera settings:

1. Click the **PTZ Control** icon on the live view toolbar.
– Or –
From the menu toolbar, click **Camera Setup > PTZ Setup**.
2. Select the camera, baud rate, data bit, stop bit, parity, flow control, PTZ protocol and address for the camera. See Appendix E “Default menu settings” on page 134 for the default values.
Note: It is important to ensure that the settings correspond with those used in the PTZ camera.
3. Click **Copy** to copy the settings to another camera, if required, and select the cameras.
4. Click **Apply** to save the settings and then click **Exit** to return to live view.

PTZ presets and tours

Presets are previously defined locations of an PTZ dome camera. It allows you to quickly move the PTZ dome camera to a desired position. They are configured and modified from the Camera Setup > PTZ Presets/Tours window (see Figure 22 below).

Tours are series of presets. Shadow tours allow you to record the manual movement of a PTZ and follow the same tour at a later date.

Note: The PTZ dome camera used must be able to support a preset command.

Figure 22: PTZ configuration window



Table 13: Description of the PTZ configuration window

Name	Description
1. Save preset	Saves preset.
2. Call preset	Calls up pre-existing preset.
3. Shadow tour toolbar	Starts recording the shadow tour.
	Saves the shadow tour.
	Starts the selected shadow tour.
	Deletes the selected shadow tour.
4. Preset tour toolbar	Adds a step to a selected preset tour.
	Starts the selected preset tour.
	Stops the selected preset tour.
	Deletes all the preset tour steps.
	Scroll up the list.

Name	Description
	 Scroll down the list.

To set up a preset:

1. From the menu toolbar, click **Camera Setup > PTZ Preset/Tours**.
2. Use the directional, zoom, focus and iris buttons to position the camera in the desired preset location.
3. Check **Save Preset** and enter a preset number. The preset is enabled and stored in the camera.

If the desired preset number is larger than the 17 numbers listed, click [...]. The Preset window appears. Select a preset number from the dropdown list and click the **OK** button to save changes.

Note: Presets can be overwritten.

4. Click **Exit** to return to live view.

To call up a preset:

1. From the menu toolbar, click **Camera Setup > PTZ Preset/Tours**.
2. Check **Call Preset** and enter the preset number to call up. The camera immediately moves to that preset position.
3. Click **Exit** to return to live view.

To delete a preset:

1. From the menu toolbar, click **Camera Setup > PTZ Preset/Tours**.
2. From the preset list, select a preset number, and click  to delete the selected the preset.
3. Click **Exit** to return to live view.

To call up a preset tour:

1. From the menu toolbar, click **Camera Setup > PTZ Preset/Tours**.
2. Check **Call Preset** and enter the preset number to call up. The camera immediately moves to that preset position.
3. Click **Exit** to return to live view.

To set up a preset tour:

1. From the menu toolbar, click **Camera Setup > PTZ Preset/Tours**.
2. Select the preset tour number.
3. In the preset tour toolbar, click  to add a step to the preset tour. The Step window appears. Select the preset number, dwell time and speed of the step. Click **OK** to save the settings.

Note: A preset tour should have at least two presets.

- Repeat step 3 to configure other steps in the preset tour.



- In the preset tour toolbar, click to call up the preset tour.
- Click **Exit** to return to live view.

To call up a preset tour:

- Click the **PTZ Settings** icon on the menu toolbar and select **More Settings**.
- Select the desired preset tour from the list and click to start the tour. Click to stop the preset tour.
- Click **Back** to return to live view.

To delete a preset tour:

- From the menu toolbar, click **Camera Setup > PTZ Preset/Tours**.
- From the preset tour list, select a tour number and click to delete the selected the preset tour.

– Or –

In the preset tour toolbar, click to delete all the preset tours.

- Click **Exit** to return to live view.



To set up a shadow tour:

- From the menu toolbar, click **Camera Setup > PTZ Preset/Tours**.
- Select the shadow tour from the drop-down list.
- To record a new shadow tour, click and use the directional buttons on the PTZ control panel to move the camera along the desired path.
- Click to save the shadow tour.

Note: The shadow tour can be overwritten.

- Click **Exit** to return to live view.

To call up a shadow tour:

1. From the menu toolbar, click **Camera Setup > PTZ Preset/Tours**.
2. Select the shadow tour from the list and click  to start the tour. Click  to stop the shadow tour.
3. Click **Exit** to return to live view.

Chapter 11

Network settings

The Network settings menu allows you to manage all network related aspects of the recorder including general network settings, DDNS, NTP synchronization, email setup and FTP server setup.

Additionally, the Net Detect and Network statistics menus provide you with a useful and efficient tool to analyze the behavior of the recorder on the network.

You must correctly configure your recorder's network settings before using it over the network in order to:

- Connect IP cameras to it
- Connect to the recorder over the LAN
- Connect to the recorder over the internet

The recorder must have access to the internet when configuring the network settings.

Network settings

Note: As every network configuration may differ, please contact your Network Administrator or ISP to see if your recorder requires specific IP addresses or port numbers.

To configure general network settings:

1. From the menu toolbar, click **Network Settings > Network Settings**.

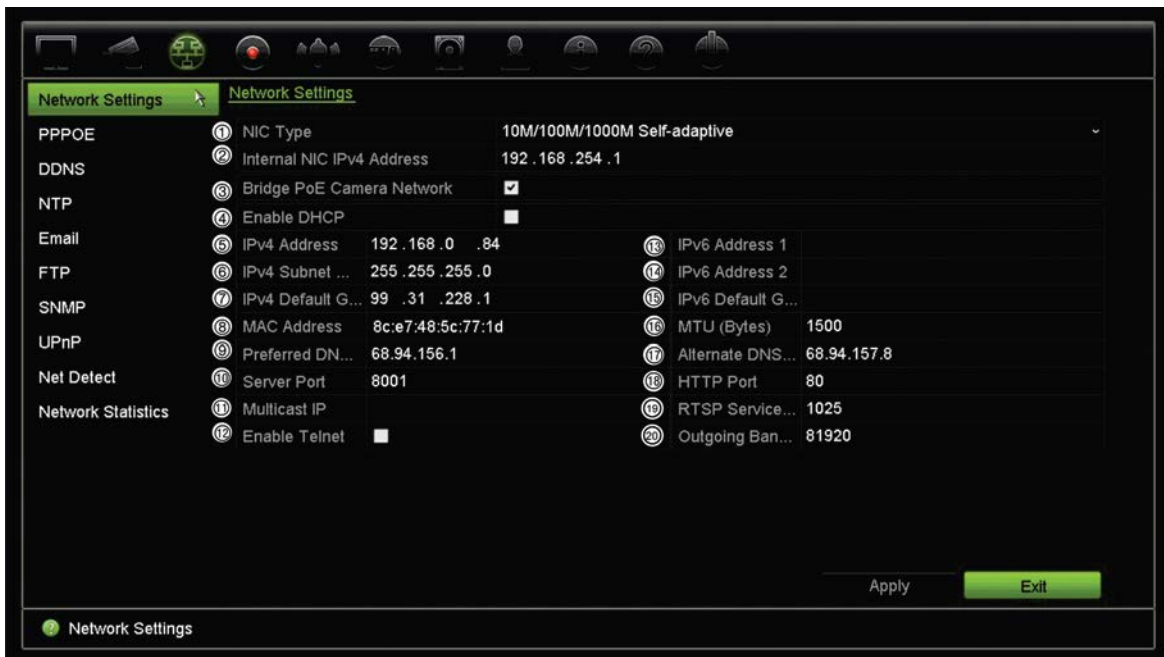

2. Enter the required settings:

Option	Description
1. NIC Type	<p>Network interface card (NIC) is a device used to connect the recorder to a network. Select the NIC type used from the drop-down list.</p> <p>Default value is 10/100M self-adaptive for the 4 channel recorder and 10/100/1000M self-adaptive for the 8 or 16 channel recorders.</p>
2. Internal NIC IPv4 Address	<p>Enter the internal NIC IPv4 address. This is the IP address of the recorder's internal network managing only the PoE port cameras. This is not the LAN IP address.</p> <p>Default value is 192.168.254.1.</p>
3. Bridge PoE Camera Network	<p>Check this box to enable the Bridge PoE Camera Network.</p> <p>Default value is Enable.</p>
4. Enable DHCP	<p>DHCP (Dynamic Host Configuration Protocol) is a protocol for assigning an IP address dynamically to a device each time it connects to a network.</p> <p>Check this box if you have a DHCP server running and want your recorder to automatically obtain an IP address and other network settings from that server. The DHCP server is typically available in your router.</p> <p>Default value is Disable.</p>
5. IPv4 Address	<p>Enter the IP address for the recorder. This is the LAN IP address of the recorder.</p> <p>Default value is 192.168.1.82.</p>
6. IPv4 Subnet Mask	<p>Enter the subnet mask for your network so the recorder will be recognized within the network.</p> <p>Default value is 255.255.255.0.</p>

Option	Description
7. IPv4 Default Gateway	Enter the IP address of your network gateway so the recorder will be recognized within the network. This is typically the IP address of your router. Consult your router user manual or contact your ISP to get the required information on your gateway. Default value is 192.168.1.1.
8. MAC Address	Displays the MAC address. The MAC address is a unique identifier of your recorder and it can not be changed.
9. Preferred DNS Server	Enter the preferred domain name server to use with the recorder. It must match the DNS server information of your router. Check your router's browser interface or contact your ISP for the information.
10. Server Port	Use the server port for remote client software access. The port range is between 1024 and 65535. Enter the server port value. The default value is 8000.
11. Multicast IP	Enter a D-class IP address between 224.0.0.0 to 239.255.255.255. Only specify this option if you are using the multicast function. Some routers prohibit the use of multicast function in case of a network storm.
12. Enable Telnet	For Technical Support purposes only. For security reasons, the Telnet port is disabled by default.
13. IPv6 Address 1	Enter the IPv6 address for the recorder. Default value is fe80::240:30ff:fe48:2975/64.
14. IPv6 Address 2	Enter the IPv6 address for the recorder.
15. IPv6 Default Gateway	Enter the IPv6 address of your network gateway so the recorder will be recognized within the network. This is typically the IP address of your router.
16. MTU (bytes)	Enter a value between 500 and 9676. Default is 1500.
17. Alternate DNS Server	Enter the alternate domain name server to use with the recorder.
18. HTTP Port	By default the HTTP port value is 80.
19. RTSP Service	The RTSP (Real Time Streaming Protocol) is a network control protocol designed for use in entertainment and communications systems to control streaming media servers. The default value is 1025.
20. Outgoing Bandwidth	Outgoing Bandwidth. The default value is 81920.

3. Click **Apply** to save the settings and **Exit** to return to live view.

PPPoE settings

Although not usually used, you can connect the recorder directly to a DSL modem. To do this, you need to select the PPPoE option in the network settings. Contact your ISP to get the user name and password.

To configure PPPoE settings:

1. From the menu toolbar, click **Network Settings > PPPoE**.
2. Check the enable PPPoE box.
3. Enter your user name and password and confirm the password.
4. Click **Apply** and manually reboot the recorder to save the settings.

DDNS settings

DDNS servers allow you to connect to your recorder using a fixed address. This fixed address needs to be registered with a DNS service. The DDNS setup menu allows you to enable or disable DDNS and to configure it using ezDDNS, No-IP or DynDNS.

Note: Some service providers block the default RTSP streaming port 554 used for video streaming, so if you are not receiving video images over the internet, you may need to change it to another value. See Appendix C “Port forwarding information” on page 137 for more information. See “Port forwarding information” in the appendix for more information.

There are three ways to set up a DDNS account:

- **ezDDNS:** A free-of-charge service included with your recorder and fully managed within the recorder interface
- **DynDNS:** A third-party service where users need to apply for a DynDNS account on the Dyn.com website.
- **No-IP:** A third-party service where users need to apply for a no-IP account on the no-ip.com website

Figure 23: ezDDNS setup window



Note: You cannot have two recorders with the same host name.

To set up DDNS:

1. From the menu toolbar, click **Network Settings > DDNS**.
2. Check the **Enable DDNS** box to enable this feature.
3. Select one of the DDNS types listed:

ezDDNS: Click the **Get URL** button. The URL address to access the unit is displayed. If no host name is specified, the DDNS will allocate one automatically.

The maximum length for the host name field is 64 characters. This limit does not include tvn-ddns.net. An example of a host name could be *max64chars.tvr-ddns.net*.

- Or -

DynDNS: Select **DynDNS** and enter the server address for DynDNS. In the recorder domain name field, enter the domain name obtained from the DynDNS web site. Then enter your user name and password registered in the DynDNS network.

For example:

Server address: members.dyndns.org

Domain: mycompanydvr.dyndns.org

User name: myname

Password: mypassword

- Or -

NO-IP: Enter server address (for example, dynupdate.no-ip.com). In the host name field, enter the host obtained from the NO-IP web site. Then enter the user name and password that are registered with the No-IP network.

4. Ask your ISP service provider for your DNS server address or look it up in the browser interface settings of your router.

Go to **Network Settings** and enter the preferred and alternate DNS server addresses as well as the default gateway address.

5. Click **Apply** to save the settings and click **Exit** to return to live view.

NTP server settings

A Network Time Protocol (NTP) server can also be configured on your recorder to keep the date and time current and accurate.

Note: If the device is connected to a public network, you should use a NTP server that has a time synchronization function, such as the server at the National Time Center (IP Address: 210.72.145.44) or europe.ntp.pool.org. If the device is setup in a more customized network, NTP software can be used to establish a NTP server used for time synchronization.

To set up an NTP server:

1. From the menu toolbar, click **Network Settings > NTP**.
2. Check the NTP box to enable feature. It is disabled by default.
3. Enter the NTP settings:
 - **Interval (min):** Time in minutes to synchronize with the NTP server. The value can be between 1 and 10080 minutes. Default is 60 minutes.
 - **NTP Server:** IP address of the NTP server.
 - **NTP Port:** Port of the NTP server.
4. Click **Apply** to save the settings and click **Exit** to return to live view.

E-mail settings

The recorder can send email notifications of alarms or notifications through the network.

Note: Ensure that the DNS address has been set up correctly beforehand.

To configure email settings:

1. From the menu toolbar, click **Network Settings > Email**.
2. Enter the required settings.

Option	Description
Enable Server Authentication	Check the box if your mail server requires authentication and enter the login user name and password.
User Name	If the mail server requires authentication, enter the login user name.
Password	If the mail server requires authentication, enter the login password.
SMTP Server	Enter the SMTP server's IP address.
SMTP Port	Enter the SMTP port. The default TCP/IP port for SMTP is 25.
Enable SSL	Check the box to enable SSL if it is required by the SMTP server. This feature is optional.
Sender	Enter the name of the sender of the email.
Sender's Address	Enter the sender's email address.
Select Receivers	Select an email recipient. Up to three receivers can be selected.
Receiver Name	Enter the name of the receiver of the email.
Receiver's Address	Enter the email address of the receiver.

Option	Description
Include Snapshot	Check the Attach JPEG File box if you want to send an email with attached alarm images.
Interval	Select an interval range in the Interval box. The interval range represents the time range in between the alarm images being sent. For example, if you set the interval range at two seconds, the second alarm image will be sent two seconds after the first alarm image

3. Click **Test** to the test email settings.

Note: We recommend that you test the email settings after entering values in the email window.

4. Click **Apply** to save the settings and click **Exit** to return to live view.

Note: We recommend that you test the email settings after entering values in the Email window.

Configure an FTP server to store snapshots

You can upload your snapshots to an FTP server for storage.

Note: It is not possible to stream video to an FTP site.

To configure the FTP server settings:

1. From the menu toolbar, click **Network Settings > FTP**.
2. Check the **Enable FTP** box.
3. Enter the FTP server information.
4. Select the directory to use (root, parent, or secondary). If Parent or Secondary were selected, select the desired options for them.
5. Click **Apply** to save the settings and click **Exit** to return to live view.

SNMP settings

SNMP is a protocol for managing devices on networks. When you enable SNMP in the menu, network management systems can retrieve recorder status information from the recorder via SNMP.

When you set the trap address and trap port in the recorder menu to the network management system's IP address and port number, and set up the network management system as trap receiver, trap notifications (such as startup) are sent from the recorder to the network management system.

Before configuring this function, you must first install the SNMP software.

To configure SNMP protocol settings:

1. From the menu toolbar, click **Network Settings > SNMP**.
2. Check the **Enable SNMP** box.
3. Enter the required settings.
4. Click **Apply** to save the settings and click **Exit** to return to live view.

UPnP settings

The recorder supports UPnP (Universal Plug and Play). This feature lets the recorder automatically configure its own port forwarding, if this feature is also enabled in the router.

You can select one of two methods to set up UPnP:

Automatic mapped type: The recorder automatically uses the free ports available that were set up in the Network Settings menu.

Manual mapped type: You enter the particular external port settings and IP addresses required to connect to the desired router (see Figure 24 below).

Figure 24: UPnP auto configuration screen

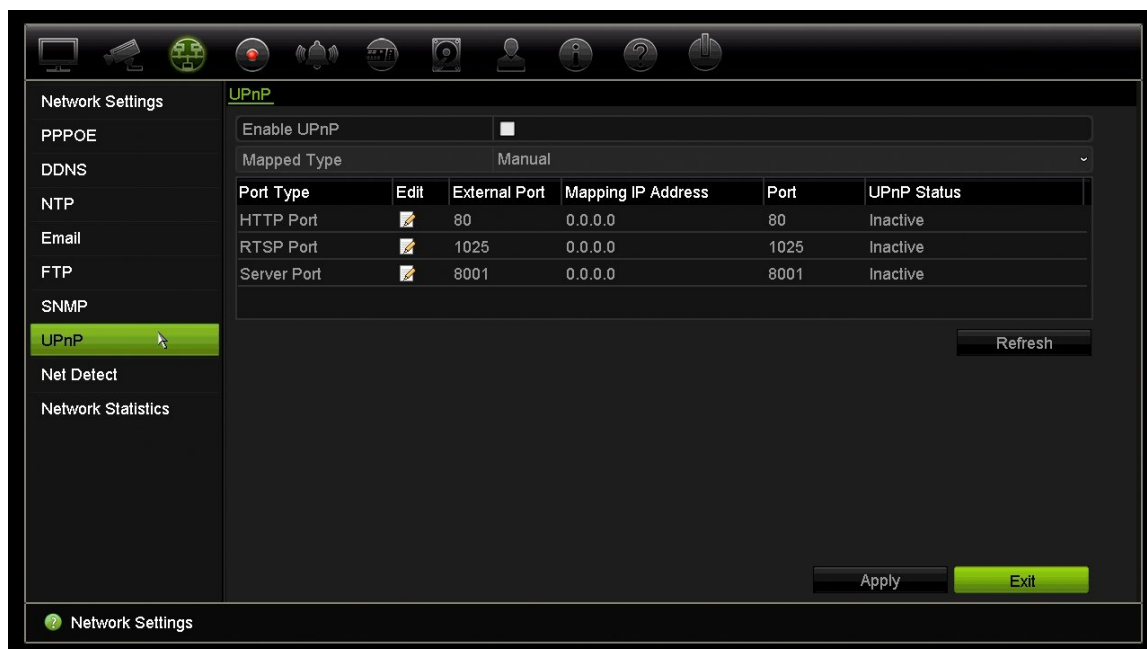

To enable UPnP:

1. Connect the recorder to the router.

Note: The router must support UPnP and this option must be enabled.

- From the menu toolbar, click **Network Settings > UPnP**.
- Check the **Enable UPnP** box.
- From **Mapped Type**, select Auto or Manual.

If **Manual** is selected, enter the external ports and IP addresses required. Click the **Edit** icon  to change the values.

- Click **Apply** to save the settings and click **Exit** to return to live view.

Network status

You can easily check network traffic in order to obtain information about the recorder such as its linking status, MAC address, MTU, sending/receiving rate, and NIC type.

The Network Detection window shows the network traffic between the recorder and your local network. However, the traffic between the plug and play cameras and the NVR 10 is not shown.

You can also check the network connection status by testing its delay and packet loss.

To check network traffic:

- From the menu toolbar, click **Network Settings > Net Detect**. The Traffic window appears. The information displayed is refreshed once a second.

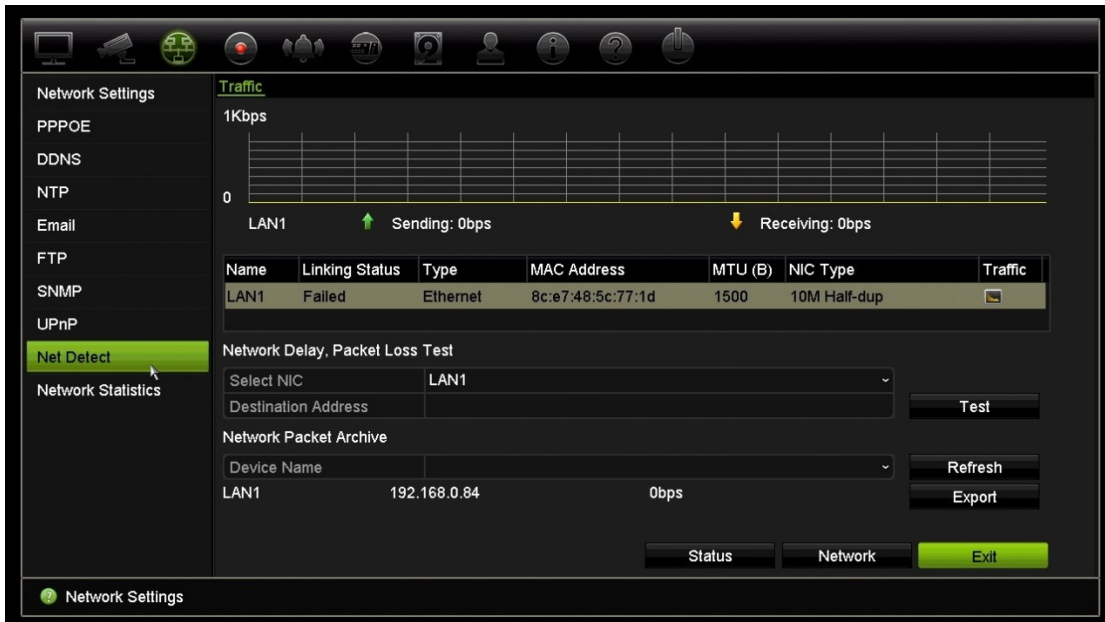

To check network delay and packet loss:

- From the menu toolbar, click **Network Settings > Net Detect**.
- Under the section “Network Delay, Packet Loss Test”, select the NIC to use and enter the destination address. Click **Test**.

The test result appears in a pop-up window.

3. If you need to check the current network parameters, click the **Network** button to get an overview. The current values for NIC type, DHCP, IPv4 address, IPv4 subnet mask, IPv4 default gateway are shown as well as the preferred DNS server and alternate DNS server if used.

The **NIC Type** and **Enable DHCP** options can be changed. Click **Apply** to save any changes made and then click **OK** to return to the main window.

4. Click **Exit** to return to live view.

To check network status:

1. When all the network parameters have been set, click the **Status** button to confirm that all parameters are operating correctly.

Export network packet data

When the recorder is connected to a network, you can export the captured data packet to a USB-flash drive, SATA/eSATA CD-RW and other local backup devices.

To export network packet data:

1. From the menu toolbar, click **Network Settings > Net Detect**.
2. Under the section "Network Packet Archive", click **Refresh** to get a list of the local backup devices available. Select one from the list.
3. Click **Export**. Up to 1M of data can be exported at a time.
4. Click **Exit** to return to live view.

Network statistics

You can easily check the bandwidth that is being used by remote live view and playback.

To check network statistics:

1. From the menu toolbar, click **Network Settings > Net Statistics**.
2. The latest information is displayed on the bandwidth used by remote live view and playback as well by Net Receive Idle and Net Send Idle. Click **Refresh** to update the information.
3. Click **Exit** to return to live view.

Chapter 12

Recording

Use the Recording menu to define the camera recording schedules, modify the instant playback duration, and to select the cameras for manual recording.

Recording schedule

Defining a recording schedule lets you specify when the recorder records video and which pre-defined settings are used. Each camera can be configured to have its own recording schedule.

The schedules are visually presented on a map for easy reference. See Figure 25 below for a description of the recording schedule window.

Note: If a camera is set up for continuous recording, it will still switch to event recording or alarm recording if motion, VCA or other events that are linked to that camera channel. This can be turned off in the individual action settings for each individual alarm if needed.

Figure 25: Description of the recording schedule window



1. **Camera.** Select a camera.
2. **Schedule time.** Represents the 24-hour cycle during which a schedule is selected.
3. **Schedule map.** There are eight days to select: Sunday (Sun), Monday (Mon), Tuesday (Tue), Wednesday (Wed), Thursday, (Thu), Friday (Fri), Saturday (Sat), and and Holiday (if enabled)..
4. **Recording type.** There are five types of recording to select, which are color-coded:
 - TL Time lapse (Green squares): Record of a specific day. Each green square in the timeline represents an hour in the 24-hour period.
 - TL-Hi (Dark green): High quality time lapse. Records high quality video.
 - TL-Lo (Bright green): Low quality time lapse. Records low quality video. This could be used, for example, for night recordings when few events or alarms are expected. Saving the video in low quality helps save resources on the HDD.
 - Event (Yellow): Records only events, such as motion detection and POS/ATM text insertion.
 - Alarm (Red): Records only alarms.
 - None (Grey): No recording during this period.
5. **Edit button.** Click to modify schedules and to copy schedules to other days of the week.
6. **Timeline.** There is a 24-hour time line for each day. Up to eight recording periods can be scheduled during the 24-hour period.
7. **Copy button.** Click to copy schedules between cameras.

Define a schedule from the recording schedule window

To set up a daily recording schedule:

1. Select a camera.
2. Check the **Enable Recording** box to indicate that video from this camera is to be recorded.
3. Click a record type in the legend to activate that record type. The cursor changes to a pen.
4. Drag the pen cursor across desired hours and days in the schedule overview to mark those times with that specific record mode. To mark areas with a different record type, click on a different record type to activate it.

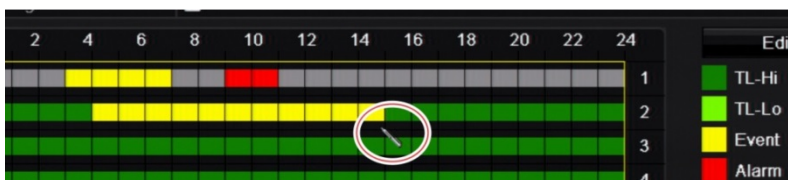

5. Click **Apply** to save the settings and **Exit** to return live view.

Define a schedule from the Edit menu

To set up a daily recording schedule:

1. From the menu toolbar, click **Recording > Recording Schedule**.
2. Select a camera.

3. Check the **Enable Recording** box.
4. Click **Edit**. The following window is displayed:

Edit			
Week		Mon	
All Day	<input checked="" type="checkbox"/>	Type	TL-Hi
Start/End Time	00:00-00:00	Type	TL-Hi
Start/End Time	00:00-00:00	Type	TL-Hi
Start/End Time	00:00-00:00	Type	TL-Hi
Start/End Time	00:00-00:00	Type	TL-Hi
Start/End Time	00:00-00:00	Type	TL-Hi
Start/End Time	00:00-00:00	Type	TL-Hi
Start/End Time	00:00-00:00	Type	TL-Hi

Copy Apply OK Cancel

5. Select the day of the week (1) for which you want to set up the schedule.
You can define a different schedule for each day of the week.
6. Set the start and end time for recording.
Define a time period by entering a start (left column) and end (right column) time. You can schedule up to eight time periods. Click All Day to record all day.
Note: Time periods defined cannot overlap.
7. Select a recording type.
This setting instructs the recorder to begin recording when an alarm is triggered. The recording type can be based on time and triggered by motion detection and/or an alarm. If set to TimeLapse (TL-Hi or TL-Lo), the recorder records continuously.
8. Click **Apply** to save settings.
9. Repeat steps 4 to 8 for other days of the week or to copy the schedule settings to another day.
To copy the current schedule settings to another day of the week, click **Copy**. Select the number of the day of the week to which to copy the schedule. Click **OK** to save changes and return to the Edit window.
10. Repeat steps 4 to 9 for the other cameras.
11. Click **Apply** to save the settings and **OK** to return to the schedule window.
The recording schedule window appears showing the schedule selected (see Figure 25 on page 82 for an example).

Modify the instant replay duration

The live view toolbar in live view lets you quickly replay recorded video for a preprogrammed period. You can easily change this preprogrammed time period. See page 32 for more information on the live view toolbar.

To modify the preprogrammed time of this instant replay, go to **Recording > General**. Select one of the times from the drop-down list (5, 10, 20, or 30 minutes) and click **Apply**. Default is 5 minutes.

Manual recording

The recorder lets you manually record video during live view. This can be useful if you know that the recorder is not currently recording and you see something of interest on a camera screen that should be recorded.

Once a manual recording is started, the recording continues until it is manually stopped. If an alarm occurs during a manual recording, the alarm recording has priority over the manual recording. If a scheduled recording is already in progress when a manual recording is started, it continues to record as scheduled.

You can check to see if a camera is recording manually by looking at the icon on the live view toolbar. The icon is red when manually recording. Default is off.

There are two ways to start and stop a manual recording:

- **Use the live view toolbar**

You can start/stop manual recording for each camera individually. Position the cursor over a camera image and left-click the mouse to display the live view toolbar. Click the manual record icon to start or stop manual recording. The icon is red when recording.

- **Use the configuration menu**

This option lets you select more than one camera at a time. Go to **Recording > Manual Recording** to access the manual recording menu and check the boxes of the cameras to start or stop manual recording.



Chapter 13

Alarm and event setup

This chapter describes the alarm and event setup menu and provides more information on the different types of alarms and connected responses. Information related to camera images is typically referred to as an event: Motion detection, VCA events, Text insertion. Alarms are all notifications related to either physical alarm inputs on recorders and cameras or anything that does not work as expected: device errors, network issues, and video loss.

Set up alarm inputs

The recorder can be configured to record when an alarm is triggered by an external alarm device (for example, PIR detector, dry contacts...). A inputs are marked A for analog and are physical inputs of the recorder. D inputs are marked as D for digital and are physical inputs on the IP cameras.

To set up external alarms:

1. From the menu toolbar, click **Alarm & Event Setup > Alarm Input**.



2. Select the alarm input number of a camera, which corresponds to the connector on the back panel of the recorder, and enter the name of the input, if required.
3. Select the alarm input type, NO (normally open) or NC (normally closed). Default is NO.

4. Check the **Enable Alarm Input** box and click **Actions** to set up the rules for the cameras to be triggered, their alarm schedules, method of alarm notification and PTZ linking function.

5. Select the cameras to be triggered when an external alarm is detected.

In the Actions window, click the **Trigger Channel** tab and then select the cameras to be triggered for recording when an alarm is detected. Click **Apply** to save the settings.

6. Select the recording schedules for the external alarm.

In the Actions window, click the **Arming Schedule** tab and select the day of the week and the time periods during the day when motion can be recorded. You can schedule up to eight time periods in a day. Default is 24 hours.

Click **Apply** to save the settings. Click **Copy** to copy these settings to other days of the week.

Note: The time periods defined cannot overlap.

7. Select the response method to an external alarm.

In the Actions window, click the **Actions** tab to define the method by which you want the recorder to notify you of the alarm. Select one or more of the six notification types. See “Alarm notification types” on page 89 for a description of these alarm notification methods.

Click **Apply** to save the settings.

8. Select the PTZ camera function required in response to an external alarm.

In the Actions window, click the **PTZ Linking** tab. Select the PTZ camera and enter the preset, preset tour or shadow tour that is triggered when the alarm is detected.



Click **Apply** to save the settings.

9. Click **OK** to return to the alarm input window.
10. Click **Exit** to return to live view.

Set up alarm outputs

You can connect the recorder to an alarm system, such as a siren or intrusion system, which is then activated when an alarm is triggered. You can select how long the alarm

signal remains active as well as schedule when alarm outputs can be triggered. A outputs are marked A for analog and are physical outputs of the recorder. D outputs are marked as D for digital and are physical outputs on the IP cameras.

To set up an alarm output:

1. From the menu toolbar, click **Alarm & Event Setup > Alarm Output**.
2. Select the alarm output.
3. Select a timeout option between 5 and 600 seconds or select “Manually Clear”.

The timeout setting lets you define how long an alarm signal remains active after the alarm has ended. If you select **Manually Clear**, the alarm signal remains active until it is manually acknowledged by pressing the alarm button on the front panel or remote control (see “Manual trigger” below).

4. Select the recording schedules for the alarm output.

Click the **Actions** button and select the day of the week and the time periods during the day when motion can be recorded. You can schedule up to eight time periods in a day. Default is 24 hours.

Click **Apply** to save the settings. Click **Copy** to copy the settings to other days of the week and holiday period.

Note: The time periods defined cannot overlap.

5. Click **OK** to return to the alarm output window.
6. Click **Copy** to copy these settings to other cameras, if required, and then click **Apply** to save the changes.
7. Click **Exit** to return to live view.

Manual trigger

The manual trigger menu allows you to manually trigger outputs of the recorder.

To trigger or clear alarm outputs manually:

1. From the menu toolbar, click **Alarm & Event Setup > Manual Trigger**.
2. Select the desired alarm output and click the following buttons:

Trigger / Clear: Trigger an alarm output or stop an alarm output. As there is only one alarm output available, the “Trigger All” button just triggers the one output.

Clear All: Stop all alarm outputs at once.

3. Click **Exit** to return to live view. The alarm is silenced.

- Or -

Press the **Alarm** button on the front panel or remote control. The alarm is silenced.

Buzzer settings

When an alarm is triggered by the system or a camera, the recorder can be set up to respond with a warning buzzer. The buzzer time is the time that it takes for the recorder to time-out the buzzer when a continuous alarm occurs. For example, when a physical alarm input is continuously triggered, the buzzer will time out after the time specified. Select **Alarm & Event Setup > Buzzer Settings** and select a buzzer time limit for the system and camera alarms. Select Mute, 5 s, 10 s, 20 s, 30 s, 60 s, 120 s, 240 s, or Constant. Default is mute.

Alarm notification types

When setting up the rules for alarm detection, you can specify how you want the recorder to notify you about an alarm or event. You can select more than one notification type.

Not all notifications types are available for all types of alarms.

You can quickly check the system status by looking at the status LEDs on the front panel.

The alarm notification types are:

- **Display Event Icon:** When an alarm is triggered in the system, an icon appears on screen to also alert you. See “Status information” on page 29 for further information.
- **Notification Type:** Select HDD Full, HDD Error, Network Disconnected, Duplicate IP Address Found, Illegal Login, Abnormal Record, and PoE Power Overload.
- **Enable Alarm Audio:** Triggers an audible *beep* when a notification or alarm is detected by the system or a camera.
- **Notify Alarm Host:** Sends a signal to TruVision Navigator or other software applications when an alarm or notification is detected.
- **Send Email:** Sends an email when an alarm or notification is detected. See “E-mail settings” on page 77 for information on how to configure the recorder to send an email.
- **Trigger Alarm Output:** Triggers an alarm output or multiple alarm outputs when a notification is detected for an external alarm. See “Types of system alarm notifications” on page 90 for information on configuring an alarm output.

To set up system notifications:

1. From the menu toolbar, click **Alarm & Event Setup > Notification**.
2. Select a system alarm notification type.
3. Check one or more response method: Display event icon, notification type, enable alarm audio, notify alarm host, send email, and trigger alarm output.

Note: The list of options available depends on the system alarm selected.

4. Repeat steps 2 and 3 for other system notification types.
5. Click **Apply** to save the settings.
6. Click **Exit** to return to live view.

Types of system alarm notifications

The different types of system alarm notifications are:

- **HDD Full:** All installed HDDs are full and will not record any more video.
- **HDD Error:** Errors occurred while files were being written to the HDD, there is no HDD installed, or the HDD had failed to initialize.
- **Network Disconnected:** Disconnected network cable.
- **Duplicate IP Address Found:** There is an IP address conflict with another system on the network.
- **Illegal Login:** Wrong user ID or password used.
- **Input/output Video Standard Mismatch:** Indicates a mismatch between camera settings and camera capabilities. For example, a camera channel set to 1080p while the recorder does not support that resolution.
- **Abnormal Record:** HDD cannot record any more files. This could be due to the overwrite option being disabled so recorded files are locked and cannot be deleted.
- **PoE Power Overload:** PoE power overload detected.

Detect video loss

Video may be lost if the camera develops a fault, is disconnected, or is damaged. You can set up the recorder to detect video loss and trigger a system notification.

To setup video loss detection:

1. From the menu toolbar, click **Alarm & Event Setup > Video Loss**.
2. Select a camera to configure for video loss detection.
3. Check the **Enable Video Loss Alarm** box to enable the feature.
4. Click the **Actions** button to enter the Actions window.
5. Set the arming schedule for detecting video loss.

Click the **Actions** tab and select the schedule of when you want video loss detection to be enabled. The schedule can be set for all week or any day of the week with up to 8 time periods per day. Click **Apply** to save the settings.

6. Select the alarm response method.

Click the **Arming Schedule** tab and select how you want the recorder to notify you of video loss. Select: Full-screen monitoring, enable alarm host, send email, and

trigger alarm host. See page “Types of system alarm notifications” on page 90 for the descriptions. Click **Apply** to save the settings.

7. Click **OK** to return to the main window
8. Click **Copy** to copy these settings to other cameras, if required, and then click **Apply** to save the changes.
9. Click **Exit** to return to live view.

Alarm host setup

If an alarm host is set, the recorder sends a signal to the host when an alarm is triggered. An example of an alarm host is the TruVision Navigator server. Note, that alarm host applications need to have the TruVision recorder SDK implemented in order to successfully receive notifications from the recorder.

To set up an alarm host:

1. From the menu toolbar, click **Alarm & Event Setup > Alarm Host Setup**.
2. Enter Alarm Host IP and Alarm Host Port values.

Alarm host IP represents the IP of the remote PC where the Network Video Surveillance software installed. The alarm host port value must be the same as software’s alarm monitor port. Up to three alarm hosts can be set. For each alarm host, the default port is 5001, 5002, and 5003.



3. Click **Apply** to save the settings.
4. Click **Exit** to return to live view.

Chapter 14

Device management

This chapter describes how to:

- Set up the time and date of the recorder
- Select the recorder language and set up general system parameters such as the device name, menu timeout period, and enable/disable password requirement
- Import/export configuration files
- Upgrade the firmware
- Set up holiday periods
- Enable text insertion
- Configure RS-232 settings

Time and date settings

You can set up the date and time that will appear on-screen as well as on time stamped recordings. The start and end time of daylight saving time (DST) in the year can also be set. DST is deactivated by default. See Figure 26 on page 93 for the Time settings screen.

Figure 26: Time and date settings window



Table 14: Description of the Time and Date settings window

Option	Description
1. Time Zone	Select a time zone from the list.
2. Date Format	Select the date format from the drop-down list. Default format is DD-MM-YYYY.
3. Time Format	Select either the 12-hour or 24-hour time format from the list. Default format is 24-hour format.
4. Display Day	Check to display the day of the week in the monitor time bar. Check the box to enable/disable. Default is Disable.
5. System Date	Enter the system date. Default date is the current date.
6. System Time	Enter the system time. Default time is the current time.
7. Auto DST Adjustment	Enable to activate DST is automatically. It depends on the time zone selected. Default is Disable.
8. Enable DST	Manually define DST. If this option is selected, the <i>Auto DST adjustment</i> option is disabled. Default is Disable. Click the check box to enable or disable daylight savings time (DST).
From	Enter the start date and time for daylight savings.
To	Enter the end date and time for daylight savings.
DST Bias	Set the amount of time to move DST forward from the standard time. Default is 60 minutes.

General recorder settings

Use the General Settings menu of Device Management to configure general recorder options.

See Figure 27 and Table 15 on page 94 for the general options available. The changes are immediately implemented once Apply is clicked to save the settings.

Figure 27: General settings of the recorder



Table 15: Description of the Monitor setup window: General settings

Option	Description
1. Language	Define the language of the system. Select the desired language from the drop-down list and click Apply . The language displayed changes immediately. Default is English.
2. Device Name	Define the recorder name. The default name is NVR 10. Click the edit box and enter the new name from the soft keyboard.
3. Remote Control ID	The device number to use for the recorder when linking the device to a remote control. The default value is 255.
4. Password Required	Define whether a login password is required to open the menu. Check the box to enable/disable and click Apply . Default is Disable.
5. Enable Wizard	Immediately start Wizard without rebooting the system. Check the box to enable/disable and click Apply . Default is Enable.

Option	Description
6. Start Wizard Now	Reboot the system immediately and start Wizard. Default is Disable.
7. Menu Timeout	Define the time in minutes after which the menu window reverts to live view mode. Select a time from the drop-down list, and click Apply. Menu timeout also applies to the system idle time after which a password will be required. Default value is 5 minutes.
8. Mouse Pointer Speed	Modify the speed of the mouse pointer. Adjust the scroll bar point to the desired level and click Apply. Default is the slowest of the four speeds.
9. Enable Front Panel Lock	When the system logs out, the front panel is automatically locked. When enabled, to unlock the front panel, press the Live button for 5 seconds. Default is Disable.

Configuration files

You can export and import configuration settings from the recorder. This is useful if you want to copy the configuration settings to another recorder, or if you want to make a backup of the settings.

Import and export files

Insert an external storage device in the recorder. Go to the **Device Management > Configuration Files** to import or export configuration settings. Click **Export** to export the recorder's configuration settings into an external storage device or click **Import** to import configuration settings after selecting a configuration file from the external storage device.

Restore default settings

The administrator can reset the recorder to the factory default settings. Network information such as IP address, subnet mask, gateway, MTU, NIC working mode, server port, and default route are not restored to factory default settings

To restore parameters to default factory settings:

1. From the menu toolbar, click **Device Management > Configuration Files**.

Note: Only the administrator can restore the default settings.

2. To restore all parameters to default factory settings:

Click the **Default** button. Enter the Admin password, click **OK**, and then click **Yes** to confirm that you want to restore all parameters to default.

— Or —

To restore all parameters, except network settings, to default factory settings:

Click the **Restore** button. Enter the Admin password, click **OK**, and then click **Yes** to confirm that you want to restore all parameters except network settings to default.

3. Click **OK** to confirm you want to restore default settings.

Upgrade system firmware

The firmware on the recorder can be updated using three methods:

- Via a USB device
- Via the recorder web browser
- Using TruVision Navigator. For further information, refer to the TruVision Navigator user manual.

The firmware upgrade file is labeled *TVN10.dav*.

To update the system firmware using a USB device:

1. Download the latest firmware from our web site at:
www.interlogix.com
- Or -
www.utcssecurityproductspages.eu/videoupgrades
2. Connect the USB device to the recorder.
3. From the menu toolbar, click **Device Management > Upgrade Firmware**.
The list of files on the USB is displayed.
4. Select the firmware file and click **Upgrade**. Click **Yes** to begin the upgrade process.
5. When the upgrade process is completed, reboot the recorder. The recorder does not reboot automatically.

Holiday schedules

It is possible to indicate holidays for which you can create a separate recording schedule. Once one or more holidays are created, a separate entry for holiday will be included in the recording schedule (refer to “Recording schedule” on page 82 of the manual)

To set up a holiday recording schedule:

1. From the menu toolbar, click **Device Management > Holiday**.
2. Select a holiday period from the list and click its **Edit** button to modify the settings. The Edit window appears.
3. Enter the name of the holiday period and click **Enable**.
4. Select whether the holiday period will be categorized by date, week, or month and then enter the start and end dates.
5. Click **Apply** to save the settings and then **OK** to return to the Edit window.
6. Repeat steps 2 to 5 for other holiday periods.
7. Click **Exit** to return to live view.

Chapter 15

Storage management

This chapter describes the content of the Storage Management menu, including HDD information, Storage Mode, S.M.A.R.T. settings as well as Bad sector detection.

HDD information

You can check the status of any of the installed HDDs on the recorder at any time.

To check the status of a HDD:

1. From the menu toolbar, click **Storage Management > HDD Information**.
2. Note the status of the HDDs listed under the Status column.

If the status is listed as Normal or Sleeping, the HDD is in working order. If it is listed as Abnormal and has already been initialized, the HDD needs to be replaced. If the HDD is Uninitialized, you need to initialize it before it can be used in the recorder. Refer to “Initialize a HDD” below for more information.

Note: The status information is also shown in the **System Information > HDD** window.

Initialize a HDD

The built-in HDD does not need to be initialized before it can be used. You can also re-initialize the HDD. However, all data on the HDD will be destroyed.

To initialize a HDD:

1. From the menu toolbar, click **Storage Management > HDD Information**.
2. Under the HDD Information tab, select the HDD to be initialized.
3. Click the **Initialize** button to begin initialization.

After the HDD has been initialized, the status of the HDD changes from Abnormal to Normal.

Overwrite a HDD

You can select how the recorder responds when the HDDs become full and there is no longer sufficient space to save new data. The overwrite option is enabled by default.

To enable overwrite when the HDDs are full:

1. From the menu toolbar, click **Storage Management > HDD Information**.
2. Enable **Overwrite**.

Caution: If the overwrite option is disabled and the quota management capacity for a channel is set to zero, the recordings on that channel can still be overwritten. To avoid this happening, set a quota level for the channel or use the group management mode.

3. Click **Apply** to save the settings.
4. Continue to configure the recorder or click **Exit** to return to live view.

Storage mode

To ensure an efficient use of the storage space available on HDDs, you can control an individual camera's storage capacity using HDD quota management. This function lets you allocate different storage capacities for both recordings and snapshots to each camera.

Note: If the overwrite function is enabled, the maximum capacity for both recordings and snapshots is set to zero by default.

To set the HDD quota for a camera:

1. From the menu toolbar, click **Storage Management > Storage Mode**.



2. Under the Mode option, select **Quota**.
3. Select a camera whose storage capacity you want to change and enter the values in GB for the maximum record capacity and snapshot capacities. The available quota space available is displayed on screen.
4. Click **Apply** to save the settings.
5. If you want to copy these values to other cameras, click **Copy** and select each camera individually. Click **OK**. Click **Apply** to save the settings.

Group HDDs

Your recorder can organize multiple HDDs into groups. Videos from specified channels can be set to be recorded onto a particular HDD group. You could, for example, save the records from a couple of high priority cameras to one HDD, and save the recordings from all the other cameras to another HDD.

To set up an HDD group:

1. From the menu toolbar, click **Storage Management > Storage Mode**.
2. Under **Mode**, select **Group**.
3. Under **Record on HDD Group**, select a number for the HDD group.
4. Check the channels to be added to this group.
Note: By default, all channels belong to HDD group 1.
5. Click **Apply** to save the settings.
6. Continue to configure the recorder or click **Exit** to return to live view.

Create HDD groups

If you have more than one HDD installed, you can change the behavior of a HDD by changing its property. It can be set to read-only or read/write (R/W). The storage mode must be set to *Group* before setting the HDD property.

A HDD can be set to read-only to avoid important recorded files from being overwritten when the HDD becomes full.

To change a HDD status property:

1. From the menu toolbar, click **Storage Management > HDD Information**.
2. Select the HDD whose property you want to change.
3. Click the **Edit** icon . The **Local HDD Settings** window appears.
Note: The Edit icon is only available if there are at least two HDDs installed.
4. Click the desired HDD property for the selected HDD: R/W or Read Only.
5. Click the group number for this HDD.
6. Click **Apply** to save and exit the window.

Note: Once set to read-only, the HDD cannot be used to save recorded files until it is set back to read/write (R/W). If the HDD that is currently being written to is set to read-only, the data is then recorded to the next HDD. If there is only one HDD present, setting it to read-only means the recorder cannot record.

Set up HDD sleep mode

You can set the HDD to enter standby mode, or sleep mode, after a period of inactivity. Sleep mode decreases the power consumption of a HDD.

To enable HDD sleep mode:

1. From the menu toolbar, click **Storage Management > Storage Mode**.
2. Check **Enable HDD Sleeping** to enable sleep mode. Default is Enable.
3. Click **Apply** to save the settings.
4. Continue to configure the recorder or click **Exit** to return to live view.

S.M.A.R.T. settings

S.M.A.R.T. (Self-Monitoring, Analysis and Reporting Technology) reports on a variety of hard drive attributes. It helps ensure that the HDD is functioning properly at all times while protecting video stored on the hard drive.

To view the S.M.A.R.T. information of a HDD:

1. From the menu toolbar, click **Storage Management > S.M.A.R.T. Settings**.
2. Select the HDD whose data you want to see. A detail listing of S.M.A.R.T. information is displayed.



S.M.A.R.T. Settings

Use when the disk has failed to self-evaluate.

HDD No. 2

Self-test Status: Not tested

Self-test Type: Short Test

S.M.A.R.T. *

Temperature (°C): 33

Power Up (days): 93

Self-evaluation: Pass

All-evaluation: Functional

S.M.A.R.T. Information

ID	Attribute Name	Status	Flags	Threshold	Value	Worst	Raw Value
0x1	Raw Read Error Rate	OK	2f	51	200	200	0
0x3	Spin Up Time	OK	27	21	174	173	4300
0x4	Start/Stop Count	OK	32	0	100	100	21
0x5	Reallocated Sector Count	OK	33	140	200	200	0
0x7	Seek Error Rate	OK	2e	0	200	200	0

Apply Exit

Storage Management

3. If you want to continue to use a HDD when the S.M.A.R.T. test has failed, check the box **Use when the disk has failed to self-evaluate**. Click **Apply** to save the settings.
4. Click **Exit** to return to live view.

Bad sector detection

You can improve the performance of your HDDs by ensuring that they have no bad sectors. Bad sectors can slow down an HDD when reading or writing data, for example.

Figure 28: Bad sector detection window



To detect bad sectors:

1. From the menu toolbar, click **Storage Management > Bad Sector Detection**.
2. Select the HDD you want to test.
3. Select whether you want to do a key area detection or a full detection, and click **Detect**.
4. The system checks the HDD. The color-coded result is displayed on screen. If there are bad sectors found, click **Error Info** to see a list of the errors found.
5. If required, click **Pause** to pause the test or **Cancel** to cancel it.
6. Click **Exit** to return to live view.

Chapter 16

User management

By default the recorder comes with three user accounts: an Administrator account, an Operator account and a Guest account. These accounts provide multiple levels of access and functionality. See Table 16 below for a description of the different user accounts.

Table 16: User accounts

User	Description
Administrator	<p>The administrator account includes extended menu with full access to all settings. The Administrator has the authority to add, delete or configure parameters for many of the system functions.</p> <p>There can only be one administrator.</p> <p>The user name is admin. The name cannot be modified.</p> <p>The default password is 1234.</p>
Operator	<p>The operator account includes reduced menu access to Video settings (inaccessible features are not visible).</p> <p>The default user name is "operator".</p> <p>The default password is 2222.</p>
Guest	<p>The guest account includes menu access with no programming possibilities (inaccessible features are not visible).</p> <p>The default user name is "guest".</p> <p>The default password is 3333.</p>

Note: The default passwords should be changed for security reasons.

Add a new user

Only a system administrator can create a user. You can add up to 16 new users.

To add new users:

1. From the menu toolbar, click **User Management**.
2. Click **Add** to enter the Add User window.
3. Enter the new user's name and password. Both the user name and password can have up to 16 alphanumeric characters.
4. Select the new user's access level: Operator or Guest. Default is Guest.
5. Enter the user's MAC address to let the user access the recorder from a remote computer with this MAC address.
6. Click **OK** to save the settings and return to the previous window.
7. Define the user's permissions.

Click the **Permission** button  for the new user. In the Permissions pop-up window check the required access privileges for local, remote and camera configuration. See "Customizing a user's access privileges" below for the permission descriptions for each group.

Click **Apply** to save the settings and **OK** to return to the previous window.

8. Click **Exit** to return to live view.

Customize a user's access privileges

Only an administrator can allocate access privileges to Operator and Guest users. The access privileges can be customized for each user's needs. The administrator's access privileges cannot be changed.

There are three types of privilege settings: Local Configuration, Remote Configuration, and Camera Configuration.

Note: Only the administrator can restore factory default settings.

Local configuration settings

By default, only the local information (log) management setting is enabled for both operators and guests.

- **Local Information (Log) Management:** Search and view logs of the recorder and view system information.
- **Local Parameter Settings:** Configure parameters and import the configuration from the recorder.
- **Local Camera Management:** Locally add, delete, and edit IP cameras.

- **Local Advanced Operation:** Access HDD management (including the initialization and modification of disk properties). Update system firmware as well as stop the I/O alarm output.
- **Local Shutdown/Reboot:** Shutdown or reboot the recorder.

Remote configuration settings

By default, only remote log search and two-way audio are enabled for operators, and only the remote log search is enabled for guests.

- **Remote Log Search:** Remotely view logs that are saved on the recorder.
- **Remote Parameter Settings:** Remotely configure parameters and import configuration.
- **Remote Camera Management:** Remotely enable and disable channels.
- **Remote Video Output Control:** For future use.
- **Two-Way Audio:** Use two-way audio between the remote client and the recorder.
- **Remote Alarm Control:** Remotely alert or control the relay output of the recorder. Alarm and notification settings must be configured properly to upload to host.
- **Remote Advanced Operation:** Remotely manage HDDs (initializing and setting properties for HDDs) as well as remotely update system firmware and clear the I/O alarm output.
- **Remote Shutdown/Reboot:** Remotely shutdown or reboot the recorder.

Camera configuration settings

By default, all IP cameras are enabled for operators for each of these settings. By default, the IP cameras are only enabled for local playback and remote playback for guests.

- **Local Live View:** Locally select and view live video.
- **Local Playback:** Locally play recorded files that are on the recorder.
- **Local Manual Operation:** Locally start/stop manual recording on any of the channels, snapshots, and video clips.
- **Local PTZ Control:** Locally control PTZ dome cameras.
- **Local Video Export:** Locally back up recorded files from any of the channels.
- **Remote Live View:** Remotely select and view live video over the network.
- **Remote Playback:** Remotely play and download recorded files that are on the recorder.

- **Remote Manual Operation:** Remotely start/stop manual recording on any of the channel.
- **Remote PTZ Control:** Remotely control PTZ dome cameras.
- **Remote Video Export:** Remotely backup recorded files from any channel.

To customize a user's access privileges:

1. Click the **User Management** icon in the menu toolbar to display its window.
2. Click the Permission button  for the user whose access privileges need to be changed. The Permissions pop-up window appears.
3. Click **Apply** to save the settings.
4. Click the **OK** button to return to the previous window.
5. Click **Exit** to return to live view.

Delete a user

Only a system administrator can delete a user.

To delete a user from the recorder:

1. Click the **User Management** icon in the menu toolbar to display its window.
2. Click the **Delete** button  for the user to be deleted.
3. Click **Yes** in the pop-up window to confirm deletion. The user is immediately deleted.
4. Click **Exit** to return to live view.

Modify a user

A user's name, password, access level and MAC address can be changed. Only a system administrator can modify a user.

To modify a user:

1. Click the **User Management** icon in the menu toolbar to display its window.
2. Click the Edit button  for the user whose details need to be changed. The Edit User pop-up window appears.
3. Edit the user information and click **OK** to save the settings and return to the previous window.
4. Click **Exit** to return to live view.

Change the Admin password

The administrator's password can be changed in the **User Management** menu.

To change the admin password:

1. Click the **User Management** icon in the menu toolbar to display its window.
2. Click the Edit button  for admin. The Edit User pop-up window appears.
3. Edit the current admin password and check the **Change Password** box.
4. Enter the new admin password and confirm it. Change the admin MAC address, if required. Click **OK** to save the settings and return to the previous window.
5. Click **Exit** to return to live view.

Chapter 17

System information

View system information

To view system information:

1. From the menu toolbar, click **System Information**.
2. To view device information, click **Device Info**.

You can view the device name, model, serial number, firmware version, and encoding version.

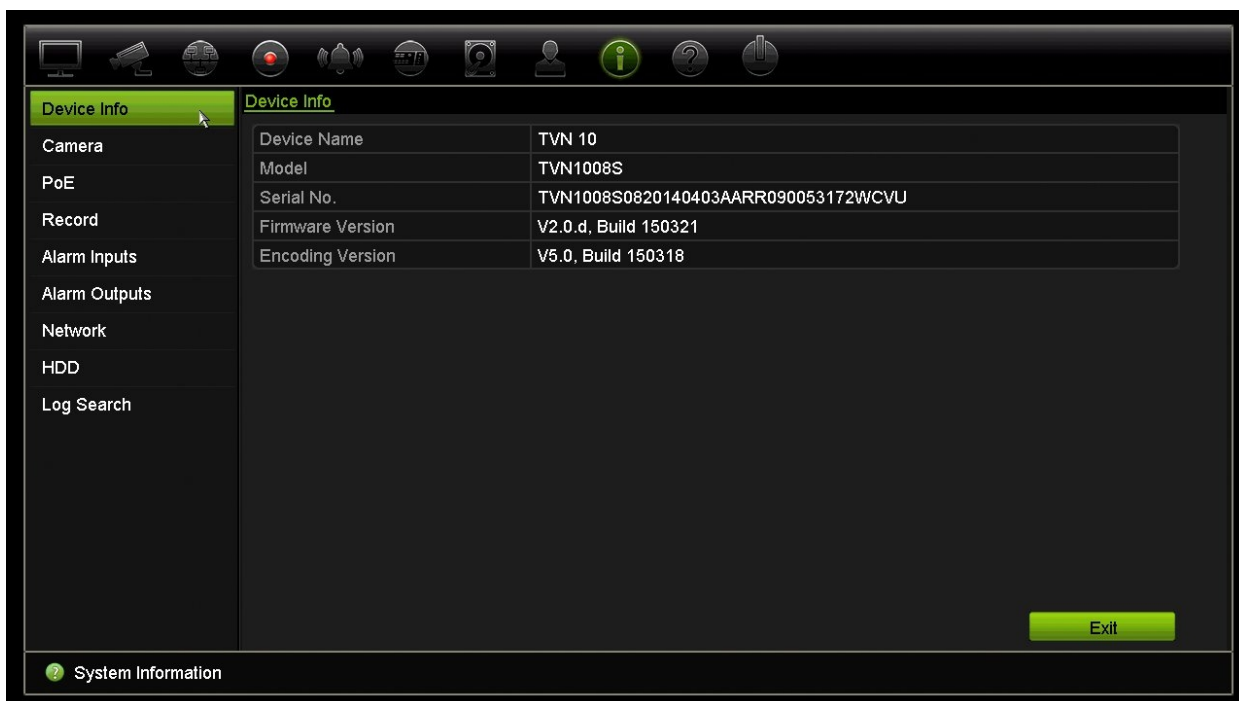

3. To view camera information, click **Camera**.

You can view the information on each camera: camera number, camera name, status, motion detection, tamper proof, video loss, preview link sum, and preview link information. Preview link sum shows the amount of remote applications that are

streaming video from this video channel. Preview link information shows you the IP addresses that are currently connected to this channel.

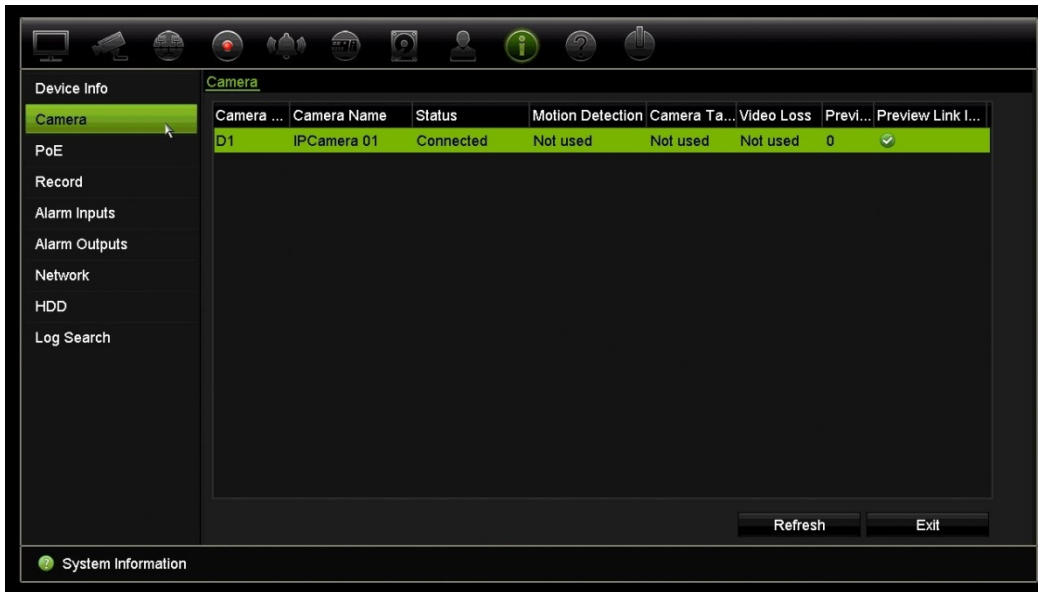

- To view record information, click **Record**.

You can view the camera number, recording status, stream type, active frame rate, active bit rate versus reserved bit rate (Kbps), active resolution, active record type, and active encoding parameters.

The “Preview Link Sum” shows the number of streams being viewed by the recorder. The “Preview Link Information” lists all the IP addresses of the streams viewed by the recorder.

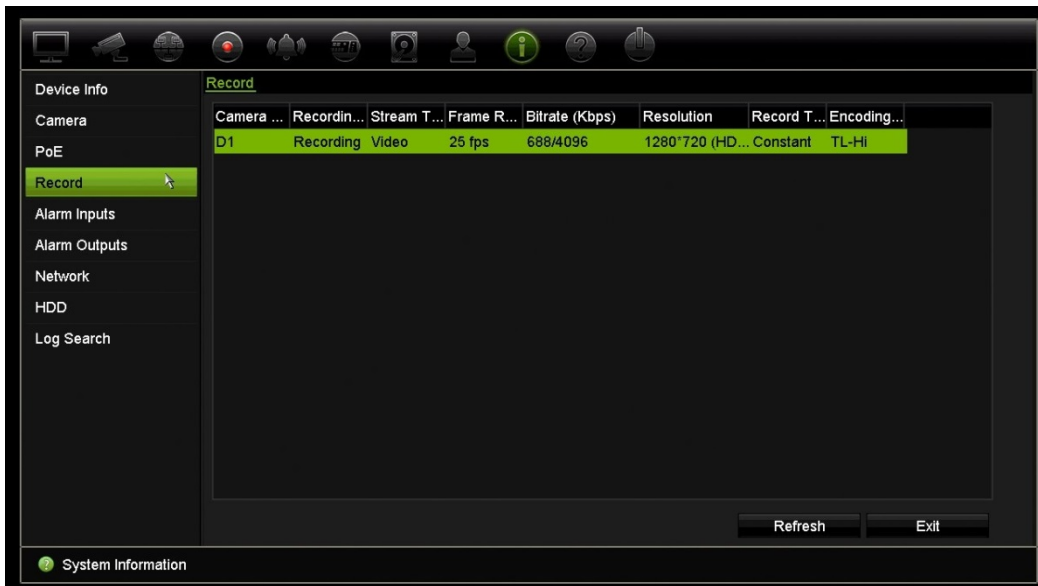

- To view alarm input information, click **Alarm Inputs**.

You can view the alarm input number, alarm name, alarm type, alarm status, and triggered camera.

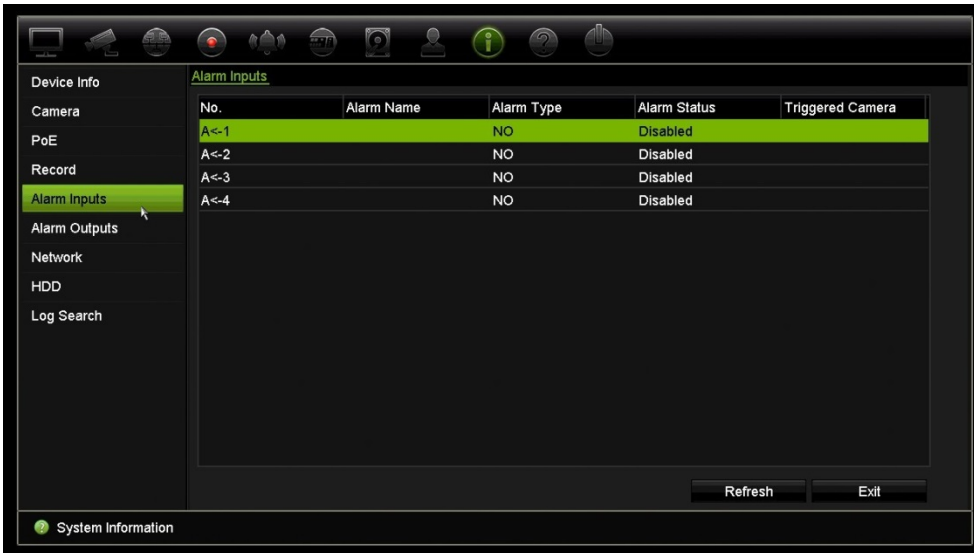

6. To view alarm output information, click **Alarm Outputs**.

You can view the alarm output number, alarm name, and alarm status.

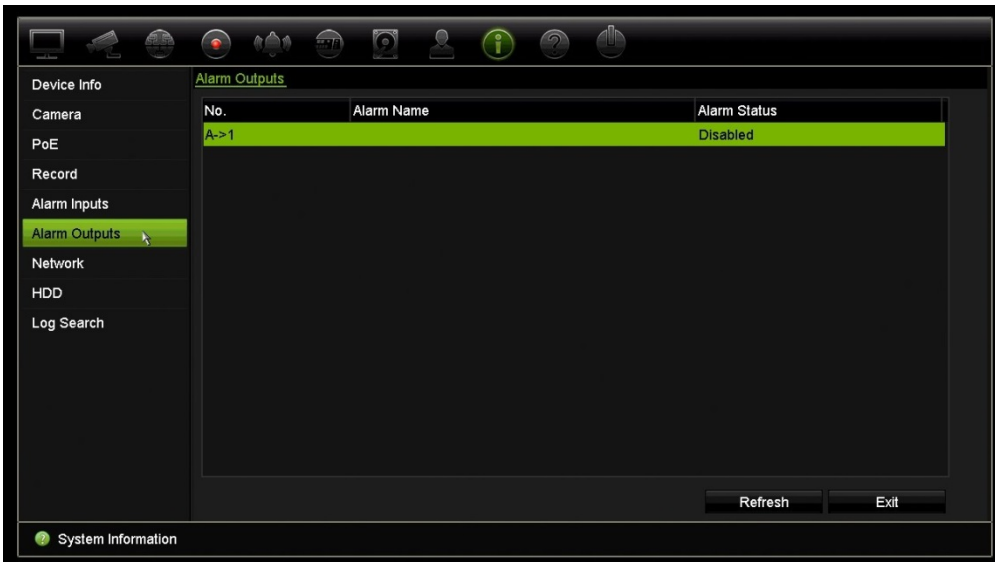

7. To view network information, click **Network**.

You can view the IPv4 address, IPv4 subnet mask, IPv4 default gateway, IPv6 address 1, IPv6 address 2, IPv6 default gateway, preferred DNS server, alternate DNS server, enable DHCP, enable PPPoE, PPPoE address, PPPoE subnet mask, PPPoE default gateway, MAC address, server port, HTTP port, multicast IP, RTSP service port, enable Telnet, and total bandwidth limit (Kbps).

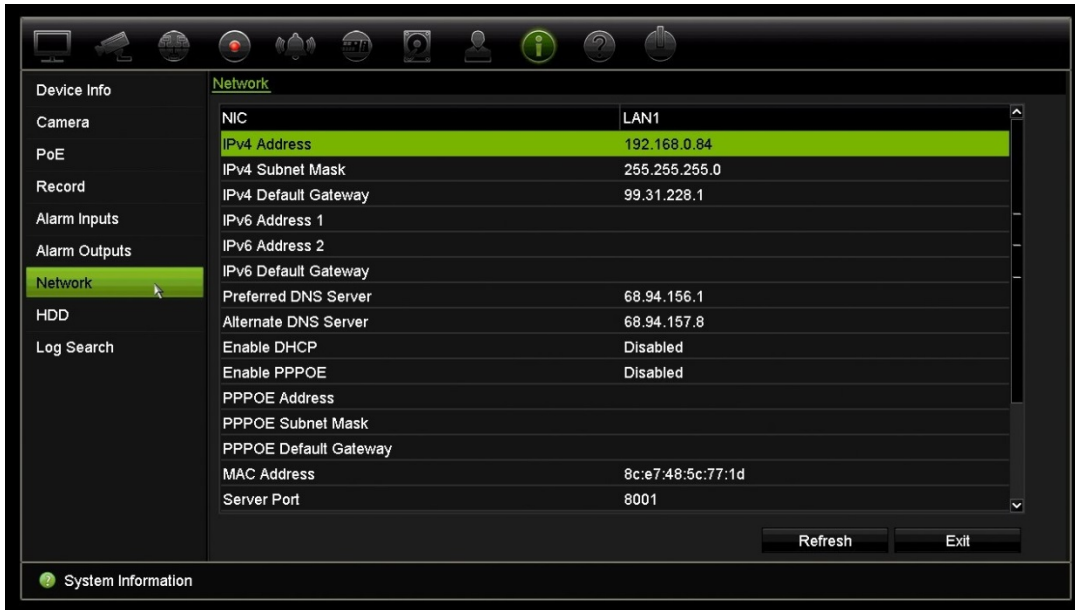

8. To view HDD information, click **HDD**.

You can view the HDD label, status, capacity, free space, property, type, and group.

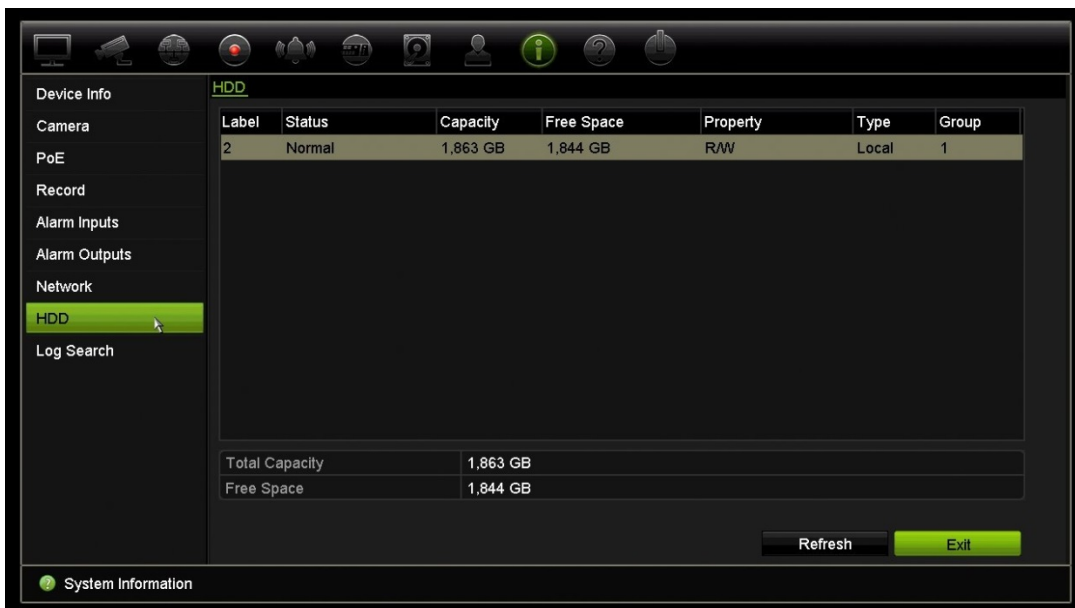

9. Click **Exit** to return to live view.

Search the system log

Many events of the recorder, such as operation, alarm and notification, are logged into the system logs. They can be viewed and exported at any time.

Up to 2000 log files can be viewed at once.

Log files can also be exported onto a USB device. The exported file is named according to the time it was exported. For example: 20140729124841logBack.txt.

Note: Connect the backup device, such as a USB flash drive, to the recorder before commencing the log search.

To search video from the system log:

1. From the menu toolbar, click **System Information > Log Search**.
2. Select the search start and end date and times.
3. Under **Event**, select an option from the drop-down list: All, Alarm, Notification, Operation, or Information.
4. From the **Type** list, select one of the options:

Event	Type
All	All
Alarm	All, Alarm Input, Alarm Output, Start Motion Detection, Stop Motion Detection, Start Camera Tamper, Stop Camera Tamper
Notification	All, Video Loss Alarm, Illegal Login, HDD Full, HDD Error, Duplicate IP Address Found, Network Disconnected, Abnormal Record, IP Camera Disconnected, IP Camera Address Conflicted, Input/Output Video Standard Mismatch, Record Buffer Overflow, Input/recording Resolution Mismatch, IP Camera Motion Analysis Exception
Operation	All, Power Up, Local: Shutdown, Abnormal Shutdown, Watchdog Reboot, Local: Restart, Local: Login, Local: Logout, Local: Configure Parameters, Local: Upgrade, Local: Start Manual Recording, Local: Stop Manual Recording, Local: PTZ Control, Local: Lock File, Local: Unlock File, Local: Trigger Alarm Output, Local: Initialize HDD, Local: Add IP Camera, Local: Delete IP Camera, Local: Set IP Camera, Local: Upgrade IP Camera Firmware, Local: Playback by File, Local: Playback by Time, Local: Playback by Snapshot file, Local: Export Config File, Local: Import Config File, Quick Snapshot, Playback Snapshot, Local: Restore Admin's Password, Local: Operate Bookmark, Local: Switch Output, Local: HDD Detect, Local: Delete HDD, Local: Restore Device Parameters, Remote: Shutdown, Remote: Reboot, Remote: Login, Remote: Logout, Remote: Configure Parameters, Remote: Upgrade, Remote: Start Manual Recording, Remote: Stop Manual Recording, Remote: PTZ Control, Remote: Lock File, Remote: Unlock File, Remote: Trigger Alarm Output, Remote: Initialize HDD, Remote: Add IP Camera, Remote: Delete IP Camera, Remote: Upgrade IP Camera Firmware, Remote: Playback by File, Remote: Playback by Time, Remote: Download by File, Remote: Download by Time, Remote: Export Config File, Remote: Import Config File, Remote: Export Record File, Remote: Export Snapshot File, Remote: Get Parameters, Remote: Get Working Status, Connect Transparent Channel, Disconnect Transparent Channel, Start Two-way Audio, Stop Two-way Audio, Remote: Alarm Arming, Remote: Alarm Disarming, Remote: Operate Bookmark, Remote: Delete HDD, Remote: Restore Device Parameters
Information	All, Local HDD Information, HDD S.M.A.R.T., Start Recording, Stop Recording, Delete Expired Record, System Running Status

5. Click the **Search** button. A list of results appears.



6. Select a file and click:

- **Details:** Displays information on the log or recording. For a recording, it lists such information as start time, type of event, local user, host IP address, parameter type, camera number, and gives a description on the types of events recorded and when record time was stopped.

- **Play:** Click to start playback of the selected recording.

- **Export:** Click to archive the selected file to a USB device. The export window appears.

7. Click **Exit** to return to live view.

Chapter 18

Using the web browser

This chapter describes how you can use the web browser interface to configure the device, play back recorded video, search through event logs, and control a PTZ dome camera. You can also specify settings on the web browser interface to optimize video playback and recording performance when operating in a low or limited bandwidth environment. Many of the browser configurations are similar to those done locally.

Windows 7 and Windows 8 users

Internet Explorer for Windows 7 and Windows 8 operating systems have increased security measures to protect your PC from any malicious software being installed. When using the recorder web browser interface, you can install ActiveX controls to connect and view video using Internet Explorer.

To have complete functionality of the web browser interface and the recorder player with Windows 7 and Windows 8, do the following:

- Run the Browser interface and the recorder player application as an administrator in your workstation
- Add the recorder's IP address to your browser's list of trusted sites

To add the recorder's IP address to Internet Explorer's list of trusted sites:

1. Open Internet Explorer.
2. Click **Tools**, and then **Internet Options**.
3. Click the Security tab, and then select the Trusted Sites icon.
4. Click **Sites**.
5. Clear the "Require server verification (https:) for all sites in this zone" box.
6. Enter the IP address or DDNS name in the "Add this website to the zone" field.
7. Click **Add**, and then click **Close**.
8. Click **OK** in the Internet Options dialog box.
9. Connect to the recorder for full browser functionality.

Access the web browser

To access the recorder, open the Microsoft Internet Explorer web browser and enter the IP address assigned to the recorder, as a web address. On the logon window, enter the default user ID and password.

Note: Only one recorder can be viewed per browser.

User ID: admin

Password: 1234

The default values for recorder network settings are:

- IP address - 192.168.1.82
- Subnet mask - 255.255.255.0
- Gateway address - 192.168.1.1
- Server port: 8000
- Ports:

When using the browser:

RTSP port: 554

HTTP port: 80

When using TruNav:

RTSP port: 554

Server/Client software port: 8000

For more information on port forwarding, see Appendix C “Port forwarding information” on page 130.

Mac Safari Browser users

For TruVision recorder browser functionality in Mac Safari browsers a plug-in must be installed.

System requirements

- Mac OS > 10.7
- Safari ≥ 8.0.5

Supported Recorders

- TVR12HD v1.0.i
- TVR44HD v1.0.c
- TVN10 v2.0.f
- TVN21 v3.0.b
- TVR42 v1.2.d
- TVR12 v1.2.c

Plug-in installation

1. Download the TruVision Mac Safari Browser Plug-In v1.0 file from the Interlogix web page. Navigate from the home page by clicking on *Video*, then *Recorders*. Select your recorder, click on the *Downloads* link. Scroll down to Software. Click on the download link.
2. Unzip the *UTCWebVideoPlugin.zip* file and extract the pkg file to your desktop.



3. Open the file by clicking open.
4. Follow the installation instructions.

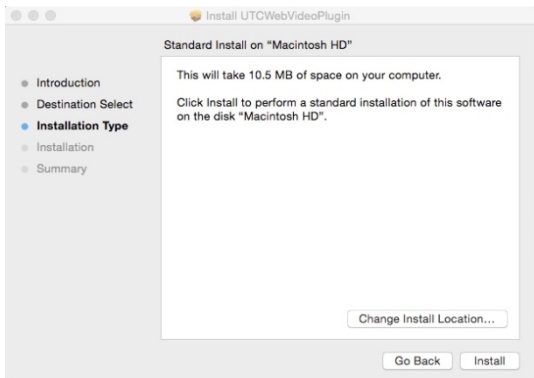
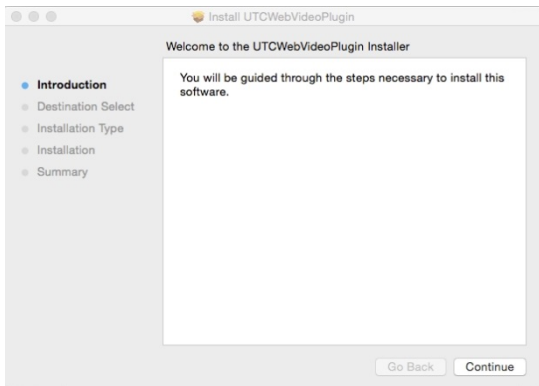

5. Enter the recorders Username and Password when requested.

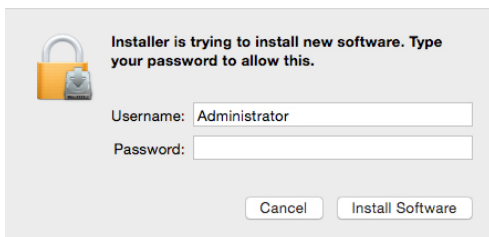

6. After a successful installation, close the installation dialog window.

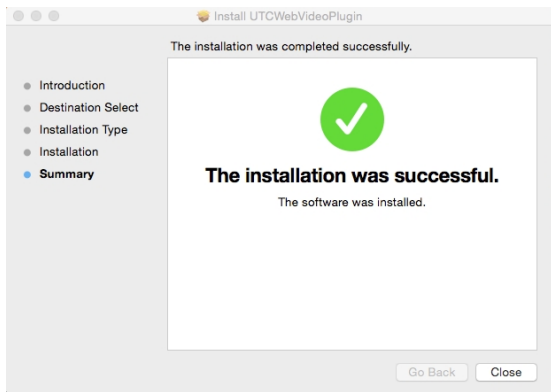

7. Open Safari and connect to any supported device.

Known limitations

- Only the Safari browser supported (not Chrome).
- Does not support bi-directional audio.
- Does not support text in.
- Does not support display of intelligent information of VCA events on the live view page.

Contact information

For contact information, go to www.interlogix.com, or www.utcssecurityproducts.eu





Web browser live view





The recorder web browser lets you view, record, and play back videos as well as manage all aspects of the recorder from any PC with Internet access. The browser's easy-to-use controls give you live view to all the recorder functions. See Figure 29 on page 118.

Figure 29: Live view in the web browser interface



Table 17: Description of live view in the web browser

Name	Description
1. Camera	Select the camera.
2. Menu toolbar	Lets you do the following: <ul style="list-style-type: none"> • View live video • Play back video • Search for event logs • Configure settings • Log out of the interface
3. Viewer	View live or playback video.
4. Display format	Define how you want video to be displayed in the viewer: Multiview or full-screen.
5. Video function toolbar	Lets you do the following in live view: <ul style="list-style-type: none">  Switch between mainstream and substream.  Start/stop all streaming from selected cameras.  Start recording from selected cameras.  Digital zoom.  Turn POS/ATM text insertion on/off.

Name	Description
	Take a video snapshot.
	View previous and next camera respectively.
	If viewing in multiview format, live view moves to the next group of cameras for the selected number of video tiles.
	Turn audio on/off
	Turn microphone on/off
6. PTZ panel	Hide/display the PTZ panel.

Control a PTZ dome camera via the web browser

The web browser interface lets you control the PTZ functions of a dome camera. Click a PTZ dome camera and use the PTZ controls on the interface to control the PTZ functions.

Figure 30: PTZ controls

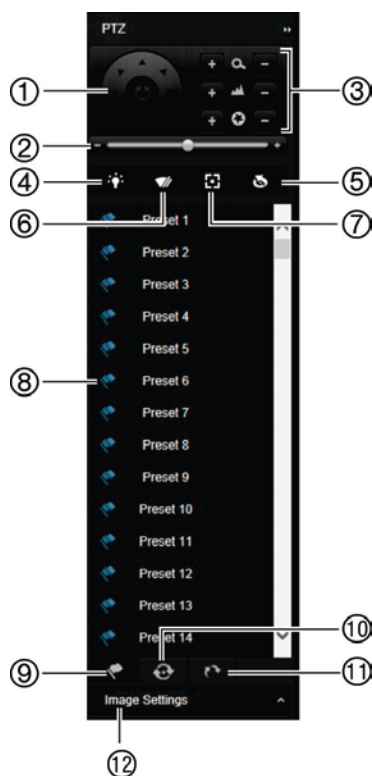







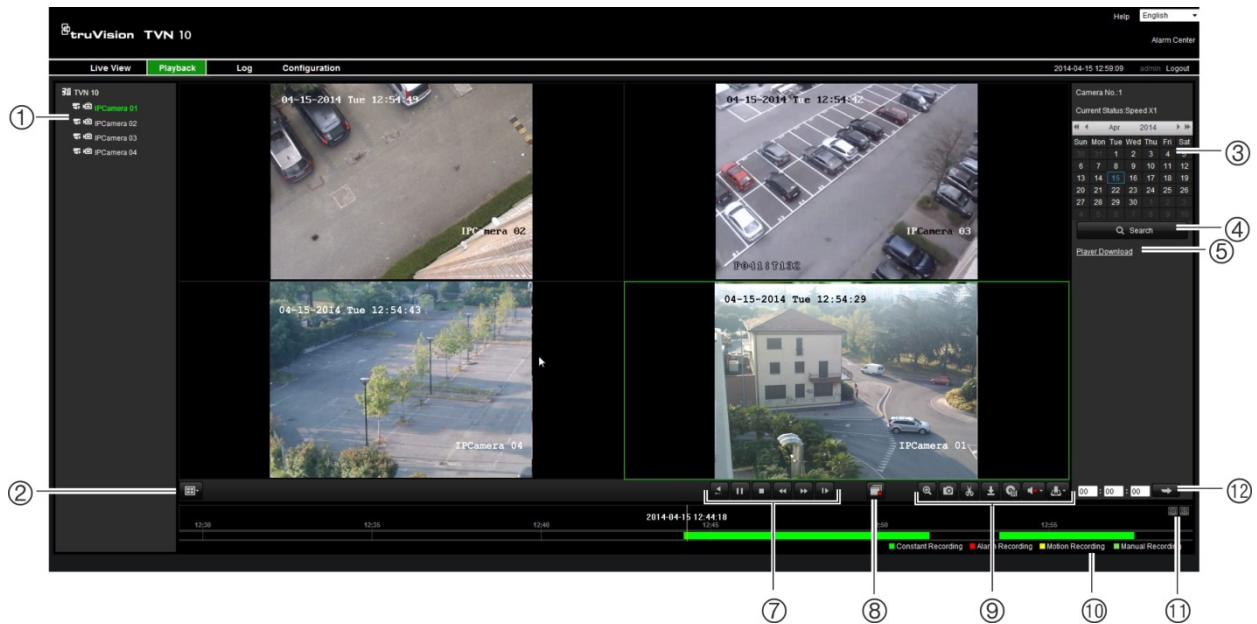

1. Directional pad/auto-scan buttons: Controls the movements and directions of the PTZ. Center button is used to start auto-pan by the PTZ dome camera.
2. Adjust speed of PTZ dome camera.
3. Adjust zoom, focus, and iris.
4. Turn on or off the camera light (if available on the camera).
5. Lens initialization: Initialize the lens of a camera with a motorized lens, such as PTZ or IP cameras. This function helps to maintain lens focus accuracy over prolonged periods of time.
6. Start or stop camera wiper (if available on the camera).
7. Auxiliary focus: Automatically focus the camera lens for the sharpest picture.
8. Start selected preset/tour/shadow tour (depending on function selected).
9. List presets available.
10. List preset tours available.
11. List shadow tours available.
12. Modify brightness, contrast, saturation, and hue values.







Play back recorded video

To search and play back recorded video, click Playback on the menu bar to display the Playback page shown in Figure 31 below.

Figure 31: Browser playback page



Item	Description
1.	Selected camera.
2.	Multiview: Select the desired multiview format.
3.	Calendar: Selected day is highlighted.
4.	Search: Click to start searching recorded files for the selected camera.
5.	Player Download: Click to download the Player application required to play back recordings.
6.	Timeline: The timeline moves from left (oldest video) to right (newest video). Click a location on the timeline to move the cursor to where you want playback to start.
7.	Playback control toolbar: <ul style="list-style-type: none">  Reverse: Click to reverse playback.  Play/pause: Play or pause playback.  Stop playback. Playback is stopped and the window changes to black.  Playback reverse: Click to scroll through the different speeds available: 1/8 speed, 1/4 speed, 1/2 speed, normal, X2 speed, X4 speed, and X8 speed. Current speed is displayed under the camera name on top right of window.  Playback forward: Click to scroll through the different speeds available: 1/8 speed, 1/4 speed, 1/2 speed, normal, X2 speed, X4 speed, and X8 speed. Current speed is displayed under the camera name on top right of window.  Single frame: Click to play back one frame at a time.
8.	 Stop all playback: Click to stop all cameras in playback.

Item	Description
9.	<p>Audio and video control toolbar:</p> <p> Digital Zoom: Access digital zoom.</p> <p> Capture: Capture a snapshot of the video.</p> <p> Start/stop Clipping: Start/stop video clip during playback. Sections of a recording are saved to a local computer folder.</p> <p> Download: Download video clips.</p> <p> Backup: Click to make back up of recorded files to save locally on the NVR. A list of the recorded files appears</p> <p> Audio On/Off: Click to enable/disable audio.</p> <p> Bookmark Management: Manage bookmarks.</p>
10.	Recording type: Description of the color coding of recording types that appear in the playback progress bar. Green indicates continuous recording. Red indicates alarm event recording. Yellow indicates motion recording. Pale green indicates manual recording.
11.	Digital Zoom: Zoom in and out of the selected camera image.
12.	Jump start: Enter a precise time in the box and click the Go To button to jump start the playback from this selected time.

Select a camera and a day to search from on the calendar displayed, and then click Search. The timeline below the page indicates video recorded for the specified day. The timeline also classifies by color the type of recording with each type.

Click and drag the marker across the timeline on where you want video playback to begin, and then click Play on the playback control toolbar. You can capture a snapshot of a video image, save the video playback, or download the recorded video.

Search for event logs

The recorder compiles a log of events, such as the start or end of video recording, recorder notifications, and alarms, through which you can easily search. Logs are categorized by the following types:

- **Alarm:** Includes motion detection, tamper detection, video tampering, and other alarm events
- **Notifications:** Includes system notifications such as video loss, HDD failures, and other system-related events
- **Operations:** Includes users access to the web interfaces and other operational events
- **Information:** Includes general information on the recorder actions, such as the start and end of video recording, etc.

To search for logs, click Log on the menu bar, select a log type, specify a date and time range, and then click Search. See Figure 32 on page 122 for an example of the results

of a log search. For further information on searching and viewing logs, go to “Search the system log” on page 111.

Figure 32: Results of a log search

No.	Log Time	Event	Type	Camera/Alarm/HDD No.	Local/Remote User	Remote Host IP
1	2014-11-14 14:54:50	Operation	Remote Logout		admin	192.168.222.101
2	2014-11-14 14:54:50	Operation	Remote Get Parameters		admin	192.168.222.101
3	2014-11-14 14:54:50	Operation	Remote Login		admin	192.168.222.101
4	2014-11-14 14:54:20	Operation	Remote Logout		admin	192.168.222.101
5	2014-11-14 14:54:20	Operation	Remote Get Parameters		admin	192.168.222.101
6	2014-11-14 14:54:20	Operation	Remote Login		admin	192.168.222.101
7	2014-11-14 14:48:45	Information	System Running State			0.0.0.0
8	2014-11-14 14:48:25	Information	System Running State			0.0.0.0
9	2014-11-14 14:48:59	Operation	Remote Get Parameters		admin	192.168.222.114
10	2014-11-14 14:48:58	Operation	Remote Get Parameters		admin	192.168.222.114
11	2014-11-14 14:48:20	Operation	Remote Logout		admin	192.168.222.101
12	2014-11-14 14:48:20	Operation	Remote Get Parameters		admin	192.168.222.101
13	2014-11-14 14:48:20	Operation	Remote Login		admin	192.168.222.101
14	2014-11-14 14:28:35	Information	System Running State			0.0.0.0
15	2014-11-14 14:28:25	Information	System Running State			0.0.0.0
16	2014-11-14 14:27:21	Information	HDD S.M.A.R.T.	2		0.0.0.0
17	2014-11-14 14:08:24	Information	System Running State			0.0.0.0
18	2014-11-14 14:08:14	Information	System Running State			0.0.0.0
19	2014-11-14 13:48:15	Information	System Running State			0.0.0.0
20	2014-11-14 13:48:05	Information	System Running State			0.0.0.0
21	2014-11-14 13:28:04	Information	System Running State			0.0.0.0
22	2014-11-14 13:27:54	Information	System Running State			0.0.0.0
23	2014-11-14 13:27:17	Information	HDD S.M.A.R.T.	2		0.0.0.0
24	2014-11-14 13:07:54	Information	System Running State			0.0.0.0
25	2014-11-14 13:07:44	Information	System Running State			0.0.0.0
26	2014-11-14 13:02:41	Operation	Remote Logout		admin	192.168.222.102
27	2014-11-14 13:02:41	Operation	Remote Get Parameters		admin	192.168.222.102
28	2014-11-14 13:02:41	Operation	Remote Login		admin	192.168.222.102
29	2014-11-14 12:47:45	Information	System Running State			0.0.0.0
30	2014-11-14 12:47:35	Information	System Running State			0.0.0.0
31	2014-11-14 12:27:34	Information	System Running State			0.0.0.0
32	2014-11-14 12:27:24	Information	System Running State			0.0.0.0
33	2014-11-14 12:27:15	Information	HDD S.M.A.R.T.	2		0.0.0.0
34	2014-11-14 12:07:24	Information	System Running State			0.0.0.0
35	2014-11-14 12:07:14	Information	System Running State			0.0.0.0
36	2014-11-14 11:47:54	Information	System Running State			0.0.0.0
37	2014-11-14 11:47:54	Information	System Running State			0.0.0.0
38	2014-11-14 11:28:01	Operation	Remote Playback by Time	All	admin	192.168.222.104
39	2014-11-14 11:27:13	Information	HDD S.M.A.R.T.	2		0.0.0.0

Configure the recorder via the browser

Click **Configuration** on the menu toolbar to display the configuration window. There are two ways to configure the recorder: Local and Remote.

Camera management

Camera configuration lets you define communication and network parameters such as protocol type, maximum file size, stream type and network transmission settings. You can also specify the directory locations for saving recorded and playback video, captured images, and downloaded files.

Remote configuration

See Figure 33 on page 123 for an example of the Configuration screen. See Table 18 on page 123 for an overview of the different browser menu functions. Please refer to the specific sections on the OSD menu functions for more information on configuring these functions.

Go to **Browser Configuration** to set up the browser parameters. See “Access the web browser” on page 115 for further information.

Note: The configuration settings defined remotely are different from those that can be defined locally.

Figure 33: Remote browser configuration window (System Information window shown)



Table 18: Description of remote configuration menus

Menu	Function	Description
Camera Setup	Camera Recording Settings	Define the general camera settings such as camera name, stream record mode, resolution, frame rate, audio recording, and pre and post event times. See “Camera recording settings” on page 57 for more information.
	Snapshots	Define the image quality of snapshots. See “Snapshots” on page 60 for further information.
	Camera OSD	Define which information is displayed on-screen. See “Camera OSD” on page 60 for further information.
	Motion Detection	Define motion detection parameters. See “Motion detection” on page 62 for more information.
	Privacy Mask	Define the on-screen privacy mask areas. See “Privacy mask” on page 64 for more information.
	Camera Tamper	Define the video tampering detection settings. See “Camera tamper” on page 65 for more information.
	Restricted Access Camera	Define the cameras whose images cannot be displayed by those not logged in. See “Restricted access camera” on page 65 for more information.
	VCA	You can define an area on screen to enable a VCA alarm.
PTZ Preset/Tours	Define and select PTZ Presets and Tours.SD	
Network Settings	Network Settings	Define the general network settings. See “Network settings” on page 72 for more information.
	PPPoE	Define the PPPoE settings. See “PPPoE settings” on page 74 for more information.
	DDNS	Define the DDNS settings. See “DDNS settings” on page 75 for more information.
	NTP	Define the NTP server settings. See “NTP server settings” on page 76 for more information.

Menu	Function	Description
	Email	Define the settings to send an e-mail. See "E-mail settings" on page 77 for more information.
	FTP	Define the FTP settings. See "Configure an FTP server to store snapshots" on page 78 for more information.
	SNMP	Define the SNMP settings. See "SNMP settings" on page 78 for more information.
	UPnP	Enable this function so that the recorder can automatically configure its own port forwarding. See "UPnP settings" on page 79 for more information.
	More Settings	Define a multicast IP as well as the server, HTTP, and RTSP ports. See page 72.
	Net Statistics	Check the bandwidth being used by remote live view and playback. See "Network statistics" on page 81 for more information.
Recording	Recording Schedule	Define the recording schedules. See "Recording schedule" on page 82 for more information.
	Manual Recording	Define which cameras can manually record. See "Manual recording" on page 85 for more information.
Alarm & Event Setup	Alarm Input	Define the alarm input parameters for when an external alarm is triggered. See "Set up alarm inputs" on page 86 for more information.
	Alarm Output	Define the response when an external alarm is triggered. See "Manual trigger" on page 88 for more information.
	Manual Trigger	Define the manually trigger outputs of the recorder. See "Manual trigger" on page 88 for further information.
	Buzzer Settings	Define the warning buzzer time. See "Buzzer settings" on page 89 for more information.
	Notifications	Define the notification parameters when irregular events occur, such as a HDD is full. See "Alarm notification types" on page 89 for more information.
	Video Loss	Define the video loss detection settings. See "Detect video loss" on page 90 for more information.
	Alarm Host Setup	Define the remote alarm host. See "Alarm host setup" on page 91 for more information.
Device Management	Time & Date Setting	Define time and date. See "Time and date" on page 92 for more information.
	General Settings	Define the general settings of the recorder such as language, device name, enable the wizard, menu timeout, and enable front panel lock. See "General recorder settings" on page 94 for more information.
	Configuration Files	Import/export configuration settings, restore default factory settings, and restart the recorder. See "Configuration files" on page 95 for more information.
	Upgrade Firmware	Upgrade the recorder firmware. See "Upgrade system firmware" on page 96 for more information.
	Holiday	Define how recordings occur during holiday periods. See

Menu	Function	Description
		"Holiday schedules" on page 96 for more information.
Storage Management	HDD Information	Define the HDD basic settings and initialize the HDD. See "HDD information" on page 98 and "Initialize a HDD" on page 98 for more information.
	Storage Mode	Define the storage mode of the HDD. See "Storage mode" on page 99 and "Group HDDs" on page 100 for more information.
	S.M.A.R.T. Settings	List the S.M.A.R.T. information on the HDD. See "S.M.A.R.T. settings" on page 101 for more information.
User Management	Users	Define, modify, and delete users. See Chapter 16 "User management" on page 103 for more information.
System Information	Device Info	Review the status of the device. See Chapter 17 "System information" on page 108 for more information.
	Camera	Review the status of the cameras. See Chapter 17 "System information" on page 108 for more information.
	Record	Review the status of the recordings. See Chapter 17 "System information" on page 108 for more information.
	Alarm Input	Review the status of the alarm inputs. See Chapter 17 "System information" on page 108 for more information.
	Alarm Output	Review the status of the alarm outputs. See Chapter 17 "System information" on page 108 for more information.
	Network	Review the status of the network. See Chapter 17 "System information" on page 108 for more information.

Appendix A

Specifications

	TVN 10	TVN 10c
Video & audio input		
IP camera input	8-ch / 16-ch	4-ch
Video compression	H.264, MJEG, MPEG-4	
Total bandwidth available	40/80 Mbps in	20 Mbps in
Maximum bandwidth per channel	16 Mbps	16 Mbps
Average bandwidth per channel	5 Mbps	5 Mbps
Bi-directional audio	1-ch, RCA (2.0 Vp-p, 1 kΩ)	
Viewing		
OSD viewing resolutions	1920 × 1080P / 60 Hz, 1600 × 1200 / 60 Hz, 1280 × 1024 / 60 Hz, 1280 × 720 / 60 Hz, 1024 × 768 / 60 Hz	
Remote viewing resolutions	Up to 5 MPX - depending on remote client capabilities	
HDMI & VGA output resolutions	1920 × 1080P / 60 Hz, 1600 × 1200 / 60 Hz, 1280 × 1024 / 60 Hz, 1280 × 720 / 60 Hz, 1024 × 768 / 60 Hz	
HDMI version	1.4	
Digital zoom	Up to 16X	
Playback		
Playback resolution	Up to 5 MPX	
Synchronous playback OSD	Up to 8-ch	
Synchronous playback web browser	Up to 4-ch	
Reverse playback OSD	Up to 1-ch	
Reverse playback browser	Up to 4-ch	
Recording		
Recording resolution	5MPX / 3MPX / Full HD 1080p, UXGA / HD 720p / VGA / 4CIF / DCIF / 2CIF / CIF / QCIF	
Internal SATA slots	2	1
Maximum capacity supported	4/6 TB	2 TB
Capacity per SATA drive	2/3 TB	1/2 TB

	TVN 10	TVN 10c
Recording modes	Time lapse High, Time lapse Low, Event, Alarm, Manual	
External storage	-	
Networking		
Network interface	1 RJ-45 10/100/1000 Mbps self-adaptive Ethernet interface	
ezDDNS	Yes	
DDNS	Yes	
Total viewing bandwidth available	80/80 Mbps out	40 Mbps out
Total viewing streams available	16/16 out	8 out
External Interface		
IP camera interface	8 PoE IP camera ports (optional)	4 PoE IP camera ports (optional)
PoE support	PoE-af / PoE-at	
PoE budget	Max. 120 W	Max. 52 W
Plug-&-Play functionality	Yes. Supported cameras only	
Serial interface	-	
USB interface	1 x USB 2.0 (front), 1 x USB 3.0 (back)	
Alarm interface	4 alarm in, 1 alarm out	
General		
Power supply	PoE Model: AC 100 to 240 VAC Non-PoE Model: 12 VDC	PoE Model: 48 VDC Non-PoE Model: 12 VDC
Power consumption (without HDD)	PoE Model: 180 W Non-PoE Model: 10 W	PoE Model: 65 W Non-PoE Model: 10 W
Operating temperature	-10 to +55 °C (14 to 131 °F)	
Relative humidity	10 to 90%	
Chassis	1.5U desk-based chassis	1U desk-based chassis
Dimensions (W x D x H)	Without front panel: 362 x 305 x 79 mm (14.25 x 12 x 3.11 in.) With front panel: 362 x 332 x 79 mm (14.25 x 13.07 x 3.11 in.)	Without front panel: 315 x 213 x 47 mm (12.4 x 8.4 x 3.11 in.) With front panel: 315 x 236.5 x 47 mm (12.4 x 9.3 x 3.11 in.)
Weight (without HDD)	≤ 8 kg (17.64 lb.)	
Operations		
Local	On screen display - VGA or HDMI	
Remote	Browser interface / TruVision Navigator / TVRmobile	
Browser requirements	IE 8, 9, 10, 11	
Software	TruVision Navigator 5.0 SP2 or later	
Mobile applications	TVRmobile 2.0 or later	
Integrated solutions	Advisor, OnGuard (planned), TruPortal (planned), MasterMind	

	TVN 10	TVN 10c
Supported devices		
Interlogix IP cameras	Consult IP camera compatibility chart	
Interlogiw IP encoders	TVE-400, TVE-800, TVE-1600	
Third party IP cameras	Onvif	

Appendix B

Product Codes

This is the TruVision™ NVR 10 (TVN 10) User Manual for the models listed below:

Table 1: Product codes

TVN-1004c-1T	TruVision NVR 10, 4 channels, 20 Mbps, 1TB
TVN-1004c-2T	TruVision NVR 10, 4 channels, 20 Mbps, 2TB
TVN-1004cS-1T	TruVision NVR 10, 4 channels, 4 channel PoE switch, 20 Mbps, 1TB
TVN-1004cS-2T	TruVision NVR 10, 4 channels, 4 channel PoE switch, 20 Mbps, 2TB
TVN-1008-2T	TruVision NVR 10, 8 channels, 40 Mbps, 2TB
TVN-1008-4T	TruVision NVR 10, 8 channels, 40 Mbps, 4TB
TVN-1008S-2T	TruVision NVR 10, 8 channels, 8 channel PoE switch, 40 Mbps, 2TB
TVN-1008S-4T	TruVision NVR 10, 8 channels, 8 channel PoE switch, 40 Mbps, 4TB
TVN-1016-3T	TruVision NVR 10, 16 channels, 80 Mbps, 3TB
TVN-1016-6T	TruVision NVR 10, 16 channels, 80 Mbps, 6TB
TVN-1016S-3T	TruVision NVR 10, 16 channels, 8 channel PoE switch, 80 Mbps, 3TB
TVN-1016S-6T	TruVision NVR 10, 16 channels, 8 channel PoE switch, 80 Mbps, 6TB

Appendix C

Port forwarding information

A router is a device that lets you share your internet connection between multiple computers. Most routers will not allow incoming traffic to the device unless you have configured them to forward the necessary ports to that device. By default our software and recorders require the following ports to be forwarded:

Note: Port forwarding may reduce the security of the computers on your network. Please contact your network administrator or a qualified network technician for further information.

Port: 80	HTTP protocol	Used to connect via IE browser.
Port: 8000	Client Software Port	Used to connect to video streams.
Port: 554	RTSP Port	Real time streaming protocol. Used to record video remotely.
Port: 1024	RTSP Port for 3G/4G	Use with mobile apps. Used for 3G/4G connection.

Note: It is recommended that the RTSP port 1024 should only be used when experiencing connection issues over a 3G/4G connection.

Seeking further assistance

Third-party assistance on configuring popular routers can be found at:

<http://www.portforward.com/>

<http://canyouseeme.org/>

<http://yougetsignal.com>

Note: These links are not affiliated with nor supported by Interlogix technical support.

Many router manufacturers also offer guides on their websites as well as including documentation with the product.

On most routers the brand and model number is located on or near the serial number sticker on the bottom of the device.

If you cannot find any information for your particular router, please contact your router manufacturer or internet service provider for further assistance.

Appendix D

Maximum pre-recording times

The maximum pre-recording time that can be selected depends on the bit rate. Frame rate, resolution and image quality do not impact time.

Note: This information only applies when the bit rate is set to Constant (see “Camera recording settings” on page 57 for more information).

Constant bit rate	Maximum pre-recording time (seconds)
32	30
48	30
64	30
80	30
96	30
128	30
160	30
192	30
224	30
256	30
320	30
384	30
448	30
512	30
640	30
768	30
896	30
1024	30
1280	25

Constant bit rate	Maximum pre-recording time (seconds)
1536	20
1792	15
2048	15
3072	10
4096	5

Appendix E

Default menu settings

Display Settings		
Display		
General		
		Picture Setting: Standard
		Resolution: (Null)
		Display Status Icons: Yes
		Time Bar Transparent: (Null)
		Enable Timebar: Yes
		Video Output Interface: VGA/HDMI
		Default View: 2*2 (for 4-ch models), 3*3 (for 8-ch models), and 4*4 (16-ch models)
		Sequence Dwell Time: No switch
		Enable Audio Output: No
		Event Monitor: VGA/HDMI
		Event Full-Screen Monitoring Dwell Time: 10
		Alarm Full-Screen Monitoring Dwell Time: 10
Layout		
		Video Output Interface: VGA/HDMI
Camera Setup		
IP Camera Status		
IP Camera		
		Camera No., Status, Edit, Advanced Set, Live View, Camera Name, IP Camera Address, Manage Port, Protocol, Device Model, Serial Number, and Firmware
Camera Recording Settings		
Record		
Camera: IP Camera 1		
		Record Stream Mode: Main Stream (TL-Hi)
		Stream Type: Video & Audio

		Resolution: 960*576 (960H)
		Bit Rate: Variable
		Video Quality: Medium
		Frame Rate: 12fps
		Max. Bitrate Mode: General
		Max Bitrate (Kbps): 2048
		Pre Event: 5 s
		Post Event: 5 s
		Auto Delete (day): 0
		Record Audio: Yes
		Record Audio: Yes
PoE Setup		
	PoE Setup	
		PoE type
		Dynamic tracking of the current PoE power consumption (blue), unallocated PoE power (white), and remaining allocated PoE power budget (green) shown. Snapshot quality: Medium
Snapshots		
	Snapshot	
		Camera: IP Camera 1
		Resolution: 352*288 (CIF)
		Snapshot quality: Medium
Camera OSD		
	Camera OSD Settings	
		Camera IP Camera 1
		Camera Name: IP Camera 01
		Display Name: Yes
		Display Date: Yes
		Display Day: Yes
		Date Format: MM-DD-YYYY
		Time Format: 12-hour
		Display Mode: Non-transparent & Not Flashing
Image		
	Image Settings	
		Camera: IP Camera 1
		Image Setting: Standard
		Brightness: 128
		Contrast: 128

	Hue: 128
Motion Detection	
	Motion Detection Settings
	Camera: IP Camera 1
	Enable Motion Detection: No
	Actions: Trigger Channel [camera-self]; Arming Schedule - All day for whole week; Actions: (Null)
	Sensitivity: 3
	Zone: Full Screen
Privacy Mask	
	Privacy Mask Settings
	Camera: IP Camera 1
	Enable Privacy Mask: No
	Clear All
	Clear Zone 1, 2, 3, 4: Null
Camera Tamper	
	Camera Tamper Settings
	Camera: Camera 1
	Enable Camera Tamper: No
	Actions: Arming Schedule - All day for whole week; Actions: (Null)
	Sensitivity: 0
	Clear
Restricted Access Camera	
	Restricted Access Camera Settings
	Select All: Null
VCA	
	VCA
	Camera: IP Camera 1
	Enable VCA Alarm: No
	Actions: Trigger Channel [camera-self]; Arming Schedule - All day for whole week; Actions: (Null)
PTZ Preset/Tours	
	Preset/Tours
	Camera: IP Camera 1
	Save Preset
	Call Preset
	Shadow Tour 1
	Preset Tour 1

Networking Settings

Network Settings

Network Settings

NIC Type: 10/100M/1000M Self-adaptive

Internal NIC Ipv4 Address: 192.168.254.1

Bridge PoE Camera Network: Yes

Enable DHCP: No

IPv4 address: 192.168.1.82

IPv4 Subnet Mask: 255.255.255.0

IPv4 Default Gateway: 192.168.1.1

IPv6 Address1: (Null)

IPv6 Address2: (Null)

IPv6 Address Gateway: (Null)

Mac Address: (It depends)

MTU: 1500

Preferred DNS Server: (Null)

Alternate DNS Server: (Null)

Server Port: 8000

HTTP Port: 80

Multicast IP: (Null)

RTSP Server Port: 554

Enable Telnet: No

Outgoing Bandwidth Limit (Kbps): 81920

PPPoE

PPPoE

Enable PPPOE: (Null)

User Name: (Null)

Password: (Null)

Confirm: (Null)

DDNS

DDNS

Enable DDNS: No

DDNS Type: ezDDNS

Server Address: www.tvr-ddns.net

Host Name: (Null)

NTP	
	NTP
	Enable NTP: No
	Interval (min): 60
	NTP Server: time.nist.gov
	NTP Port:123
Email	
	Email
	Enable Server Authentication: No
	User Name: (Null)
	Password: (Null)
	SMTP Server: (Null)
	SMTP Port: 25
	Enable SSL: Disable
	Sender: (Null)
	Sender's Email Address: (Null)
	Select Receiver: Receiver 1
	Receiver Name: (Null)
	Receiver's Address: (Null)
	Include Snapshot: Disable
	Interval: Disable
FTP	
	FTP
	Enable FTP: No
	FTP Server: (Null)
	FTP Port: 21
	User Name: (Null)
	Password: (Null)
	Directory: Use root directory
	Parent Directory: (Null)
	Secondary Directory: (Null)
	Secondary Directory: (Null)
SNMP	
	SNMP
	Enable SMNP: No
	SNMP Version:
	SNMP Port: 161
	Read Community: public

		Write Community: private
		Trap Address: (Null)
		Trap Port: 162
UPnP		
	UPnP	
		Enable UpnP: No
		Mapped Type: Auto
		Port Type: HTTP Port; RTSP Port ; Server Port
Net Detect		
	Traffic	
		Network Delay, Packet Loss Test: Select NIC, Destination Address
		Network Packet Archive: Device Name
		LAN1: 192.168.1.82
Network Statistics		
	Network Stat.	
		Type: Bandwidth
		IP Camera: 0bps
		Remote Live View: 0bps
		Remote Playback: 0bps
		Net Total Idle: 60Mbps
		Total Bandwidth Limit: 60Mbps
Recording		
	Recording Schedule	
	Recording	
		Camera: IP Camera 1
		Enable Recording: Enabled
		Schedule: All day for whole week TL-Hi
	General	
	General	
		Instant Replay Duration: 5 minutes
	Manual Recording	
	Manual Recording	
		Disable
Alarm & Event Setup		
	Alarm Input	
	Alarm Input	
		Alarm Input No.: A<-1

	Alarm Input Name: (Null)
	Type: NO
	Enable Alarm Input: Disable
	Actions: Trigger channel - No; Alarm schedule - All day for whole week; Rule (Null); PTZ link: (Null)
Alarm Output	
	Alarm Output
	Alarm Output No.: A<-1
	Alarm Output Name: (Null)
	Time Out: 5 s
	Actions: All day for whole week
Manual Trigger	
	Manual Alarm
	Trigger: none
Buzzer Settings	
	System Buzzer Time: Constant
	Camera Buzzer Time: Constant
Notifications	
	Notification
	Display Event Icon: Yes
	Notification Type: HDD Full
	Enable Alarm Audio: Disable
	Notify Alarm Host: Disable
	Send Email: Disable
	Trigger Alarm Output: Disable
Video Loss	
	Video Loss Settings
	Camera: IP Camera 1
	Enable Video Loss Alarm: Disable
	Actions: Arming Schedule - All day for whole week; Rule (Null);
Alarm Host Setup	
	Alarm Host Setup
	Alarm Host 1 IP: (Null)
	Alarm Host 1 Port: 5001
	Alarm Host 2 IP: (Null)
	Alarm Host 2 Port: 5001
	Alarm Host 3 IP: (Null)
	Alarm Host 3 Port: 5001

Device Management	
Time & Date Settings	
DST Settings	
	Time Zone: (GMT-08:00)
	Date Format: MM-DD-YYYY
	Time Format: 12-hour
	Display Day: Disable
	System Date: Current System Date
	System Time: Current System Time
	Auto DST Adjustment: Disable
	Enable DST: Disable
	From: Apr 1st Sun 2:00
	To: Oct last Sun 2:00
	DST Bias: 60 minutes
General Settings	
General	
	Language: English
	Device Name: NVR 10
	Remoter Control ID: 255
	Keypad Zone ID: 1
	Password Required : Disable
	Enable Wizard: Enable
	Start Wizard Now: Disable
	Menu Timeout: 5 Minutes
	Mouse Pointer Speed: Low
	Enable Front Panel Lock: Disable
Configuration Files	
Import/Export Config Files	
	Device Name: (Null)
Upgrade Firmware:	
Local Upgrade	
	Source: USB
	Device Name: (Null)
Holiday	
Holiday Settings	
	Status: All Disabled; Start Date: 1st. Jan; End Date: 1st Jan

Storage Management	
HDD Information	
	Label: Disable
	Total Capacity:
	Free Space:
	Overwrite: Enable
Storage Mode	
	Storage Mode
	Camera: IP Camera 1
	Mode: Group
	Record on HDD: 1
	Select All
	Enable HDD Sleeping: Yes
S.M.A.R.T Settings	
	S.M.A.R.T. Settings
	HDD No.:
	Self-test Status: Not Tested
	Self-test Type: Short Test
	S.M.A.R.T.:
	Temperature (°C):
	Power Up (days):
	Self-evaluation:
	All-evaluation: Functional
	S.M.A.R.T. Information : ID ; Attribute Name ; Status ; Flags ; Threshold ; Value ; Worst ; Raw Value
Bad Sector Detection	
	Bad Sector Detection
	HDD No.
	HDD Capacity: (Null)
	Block Capacity: (Null)
	Status: (Null)
	Error Count: (Null)
User Management	
Users	
	User Management
	operator: 4321
	guest: (Null)

System Information	
Device Info	
Device Info	Device Info
	Device Name
	Model: (Model number)
	Serial No.: (Model's serial number)
	Firmware Version:
	Encoding Version:
Camera	
Camera	Camera
	Camera No.; Camera Name; Status; Motion Detection; Camera Tamper, Video Loss; Preview
PoE	
PoE	PoE
	PoE Port; Channel Name; Camera Name; Status; Current PoE setting; Current PoE consumption; Peak PoE consumption
Record	
Record	Record
	Camera No.; Recording Status; Stream Type; Frame Rate; Bitrate (Kbps); Resolution; Record Type; Active Schedule
Alarm Inputs	
Alarm Inputs	Alarm Inputs
	No.; Alarm Name; Alarm Type; Alarm Status; Triggered Camera
Alarm Outputs	
Alarm Outputs	Alarm Outputs
	No.; Alarm Name; Alarm Status
Network	
Network	Network
	IPv4 Address:
	IPv4 Subnet Mask
	IPv4 Default Gateway
	IPv6 Address 1
	IPv6 Address 2
	IPv6 Default Gateway
	Preferred DNS Server
	Alternate DNS Server
	Enable DHCP

: Default menu settings

	Enable PPPOE
	PPPOE Address
	PPPOE Subnet Mask
	PPPOE Default Gateway
	MAC Address
	Server Port
	HTTP Port
	Multicast IP
	RTSP Service Port
	Enable Telnet
	Outgoing Bandwidth Limit (Kbps)
HDD	
	HDD
	Label; Status; Capacity; Free Space; Property; Type; Group
Log search	
	Log search
	Start Time:
	End Time:
	Event: All
	Type: All

Appendix F

TruVision Recorder

Archiving Instructions

Searching and playing back recorded video

1. In live view, press the **Search** button on the front panel.

– Or –

In live view, right-click the mouse to call up the mouse menu. Click **Search Video**.



Note: If you are not already logged into the recorder you will have to enter your username and password.

2. The search window appears. Select the desired cameras, record type, file type as well as the start and end times of the recording. A maximum of eight cameras can be selected.



3. Click the **Go** button.
4. The playback window appears. To change the speed and direction of playback:

Front panel: Press the left and right arrows on the front panel to speed up and slowdown playback. Press the **Playback** button to reverse playback.

Mouse: In the playback toolbar on the bottom of the window, click  and  buttons to speed up and slowdown playback. Click on the timeline to jump forwards or backwards in time.

Exporting video recordings

You can export a complete archive file that covers the entire period recorded (A), or you can clip one or more segments of interest in the file and just export the clips (B).

A. Archiving the entire video file

1. Search for the desired recorded video. See “Searching and playing back recorded video” on page 145.

2. Insert a CD/DVD or USB device in the recorder.

3. **Front panel:** Press the **Archive** button on the front panel during playback.

Mouse: Click the Archive  button in the playback window.

4. The Archive window appears. Under **Device Name**, select the storage media used for archiving.

5. Check **Include Player** (or **Player Backup** depending on the recorder model) to include the Player tool with the archived files.

6. Click **Archive** to export the currently selected video file.

Note: This will archive the recording file recording file currently being used.

B. Archiving clipped video files

You can export video that spans several recording files and/or days. The system automatically cuts the exported video files at midnight. If a recorded file runs over midnight, it will be cut into two files – pre and post-midnight. The clipped video will be exported as recording files.

You can clip the segments of a video file that are of interest to you and export those.

The exported video files can be merged in TruVision Player (see “Using TruVision Player” on page 148).

Using the front panel:

1. Find the footage required **before** midnight using the playback process (start and end times should not cross midnight).

2. Insert a CD/DVD or USB device in the recorder.

3. **Front panel:** Press the **Archive** button on the front panel during playback.

Mouse: Click the Archive  button in the playback window.

4. The Archive window appears. Under **Device Name**, select the storage media used for archiving.

5. Check **Include Player** (or **Player Backup** depending on the recorder model) to include the Player tool with the archived files.



6. Click **Archive** to export the currently selected video file.

Note: This will archive the recording file recording file currently being used.

7. Find the footage required **after** midnight (start and end times should not cross midnight).
8. Insert a CD/DVD or USB device in the recorder and select the storage media used from the menu.
9. Click **Archive** to export the currently selected video file.

Note: This will archive the recording file recording file currently being used.

Using the mouse:

1. During playback, locate the desired footage (the start and end times should cross midnight).
2. Click the **Start Clipping** button  at the start of the desired time that you want clip.
3. Fast forward or drag the time bar to the end of playback.
4. Click the **Stop Clipping** button .
5. Insert a CD/DVD or USB device in the recorder.
6. Click the **Archive** button. A pop-up box appears asking if you want to save the video clips. Click **Yes**.
7. The Clips Archive window appears listing all video clips saved. Select the desired clips and click **Archive**.
8. The Archive window appears. Under **Device Name**, select the storage media used for archiving.
9. Check **Include Player** (or **Player Backup** depending on the recorder model) to include the Player tool with the archived files.
10. Click **Archive** to export the currently selected video file.

Note: This will archive the recording file recording file currently being used.

Exporting video recordings via TruVision Navigator

TruVision Navigator allows you to export a single recording file per camera. Exported video files from TruVision Navigator need to be viewed using the TruVision export file tool.

1. In the playback window, drag the blue seek triangle in the Controller timeline to locate the desired time frame of the video segment.

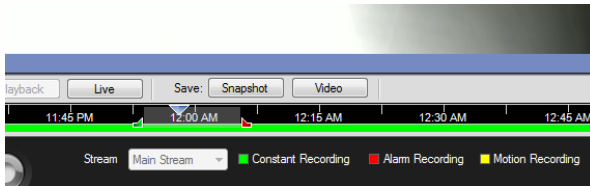

2. Slide the green and red markers of the video segment to adjust the time frame of the segment as required.

Note: The selected time frame can apply to multiple cameras.

3. Click the **Video** button to move the selected video segment to the Collector.
4. In the Collector, select the desired video thumbnails to export.
5. Click **Browse** and select the destination of the export file.

All selected video thumbnails will be exported as a single file.

6. Click the **Export Now** button.

Using TruVision Player

Playing back video using TruVision Player

You can include multiple files in the TruVision Player playlist. Double-click the desired video file from the list and click the **Start** button. When the first file finishes, the next file will automatically start.

Merging video files in TruVision Player

1. Add the exported video files to TruVision Player,
2. Click the menu icon  and select **Tool > Merge**.
3. The Merge window appears. Click **Add File** to add the files you want to merge onto a selected video file. Under **Output Setting**, select the video file to which you want to add the files.

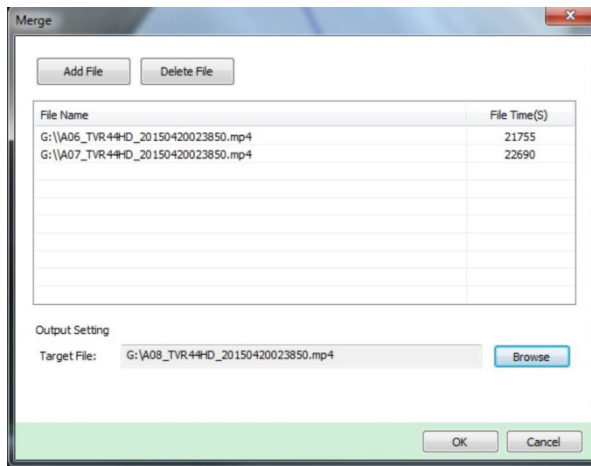

4. Click **OK**.

Index

A

- Alarm notifications
 - types, 89
 - video tampering, 65
- Alarm outputs
 - manually acknowledging, 88
- Archiving
 - exporting files to a backup device, 49
 - quick archive, 48
 - video clips, 50

B

- Back panel description, 11
- Bad sector detection, 102
- Bookmarks
 - create, 47
 - playback, 47
 - saving, 47
 - types, 47
- Brightness
 - modify, 62

C

- Cameras
 - layout, 53
- Contrast
 - modify, 62

D

- Daily schedules
 - recording, 83
- Date
 - configure display, 92
- DDNS settings, 75
- Default settings
 - restore, 95
- Digital zoom
 - description, 33
 - playback, 42
 - playback, 43
- Digital zoom in playback, 47
- DST, 92

E

- Email notifications, 77
- Event logs
 - search remotely, 121
- Export configuration settings, 95
- External alarm
 - set up, 86

F

- Factory default settings
 - restore, 95
- Firmware
 - update, 96
- Frame-by-frame playback, 46
- Front panel
 - button functions by task, 20, 21
- Front panel description, 20
- Front panel lock, 95
- FTP server settings, 78

H

- HDD
 - check status, 98
 - grouping, 100
 - initialize, 98
 - properties, 100, 101
- Holiday schedules
 - recording, 96

I

- Import configuration settings, 95
- Instant playback, 44
- IP camera
 - status, 55
 - supported, 55

L

- Language
 - change GUI language, 94
- Live view mouse menu, 30
- Live view toolbar, 32
- Login password, 94

M

- MacSafari browser, 115
- Main menu
 - accessing, 26
 - description, 26
 - icon descriptions, 26
- Manual recording, 85
- Menu timeout
 - change time, 94
- Monitors
 - change output mode, 94
 - connecting, 12
- Motion detection, 62
- Mouse pointer speed
 - change, 94
- Multiview display mode, 31

N

- Network packet data
 - exporting, 81
- Network settings
 - general set up, 72
- Network settings for browser, 115
- Network status, 80
- Network traffic
 - checking, 80
- Notifications
 - alarm types, 89
 - external alarms, 86
- NTP server, 77

O

- OSD settings, 61

P

- Password
 - change admin password, 107
 - change user password, 106
 - enable/disable login password, 94
- Playback
 - 24-hour playback, 45
 - bookmarks, 47
 - change playback speed, 46
 - instant playback, 44
 - playing back archived files, 51
 - pop-up menu description, 43
 - search by event, 38
 - search by time, 38
 - search by video type, 38
 - skip time, 45
 - snapshots, 39
 - web browser, 120
- Playback control panel
 - description, 42
- Playback control toolbar
 - quick access, 43

Player

- using for playback, 51
- Power up and down recorder, 14
- PPPoE settings, 74
- Preset
 - calling up, 35
- Preset tour
 - call up, 70
 - calling up, 35
- Preset tours
 - set up, 69
- Presets
 - call up, 69
 - selecting, setting up and deleting, 68
 - set up, 69
- Privacy mask, 64
- PTZ control panel
 - description, 34
- PTZ dome cameras
 - control remotely, 119
- PTZ settings, 67

R

- Recorder address
 - change, 94
- Recorder name
 - change, 94
- Recording schedules
 - daily, 83
 - defining, 82
- Remote control
 - connect to the recorder, 25
 - description, 23
- Resolution
 - change monitor resolution setup, 94
- Restricted access, 65

S

- S.M.A.R.T. information on a HDD, 101
- Saturation
 - modify, 62
- Search
 - bookmarks, 47
 - recordings by event, 38
 - snapshots, 39
 - system logs, 111
- Sequencing cameras, 31
- Setup wizard
 - using, 15
- Shadow tour
 - call up, 71
- Shadow tour tour
 - calling up, 35
- Shadow tours
 - set up, 70
- Single view display mode, 31
- Skip time
 - playback, 45

- quick access, 43
- Snapshots
 - capture remotely, 120
 - configure settings, 60
 - playback, 39
 - recording settings, 59
 - upload to FTP server, 78
- SNMP protocol settings, 78
- Soft keyboard, 28
- Status icons
 - enable/disable display, 94
- System information
 - view, 108
- System logs
 - playback, 111
 - search, 111

- Wizard
 - enable/disable, 94

T

- Tamper
 - detect video tampering, 65
- Time
 - configure display, 92

U

- UPnP settings, 79
- User privileges
 - camera configuration, 105
 - local configuration, 104
 - remote configuration, 105
- Users
 - adding a new user, 103
 - customizing user privileges, 104
 - deleting a user, 106
 - modify user information, 106, 107

V

- VCA setup, 66
- Video format
 - PAL/NTSC, 14
- Video loss
 - set up detect, 90
- Video output
 - change manually, 94
- Video search menu, 36

W

- Warning buzzer
 - modify, 89
- Web browser
 - accessing, 115
 - camera management, 122
 - control PTZ dome camera, 119
 - remote configuration of recorder, 122
 - search and play back recorded video, 120
 - search event logs, 121
 - video snapshot, 120

