



TruVision DVR 12HD User Manual

Copyright © 2015 United Technologies Corporation. All rights reserved.

Interlogix is part of UTC Building & Industrial Systems, a unit of United Technologies Corporation. All rights reserved

Trademarks and patents Trade names used in this document may be trademarks or registered trademarks of the manufacturers or vendors of the respective products.

Manufacturer Interlogix
2955 Red Hill Avenue, Costa Mesa, CA 92626-5923, USA

Authorized EU manufacturing representative:
UTC Fire & Security B.V.
Kelvinstraat 7, 6003 DH Weert, The Netherlands

FCC compliance Class A: This equipment has been tested and found to comply with the limits for a Class A digital device, pursuant to part 15 of the FCC Rules. These limits are designed to provide reasonable protection against harmful interference when the equipment is operated in a commercial environment. This equipment generates, uses, and can radiate radio frequency energy and, if not installed and used in accordance with the instruction manual, may cause harmful interference to radio communications. Operation of this equipment in a residential area is likely to cause harmful interference in which case the user will be required to correct the interference at his own expense.

Canada This Class A digital apparatus complies with Canadian ICES-003.

Cet appareil numérique de la classe A est conforme à la norme NMB-003 du Canada.

ACMA compliance **Notice!** This is a Class A product. In a domestic environment this product may cause radio interference in which case the user may be required to take adequate measures.

Certification   

EU directives **2004/108/EC (EMC directive):** Hereby, UTC Fire & Security declares that this device is in compliance or with the essential requirements and other relevant provisions of Directive 2004/108/EC.



2012/19/EU (WEEE directive): Products marked with this symbol cannot be disposed of as unsorted municipal waste in the European Union. For proper recycling, return this product to your local supplier upon the purchase of equivalent new equipment, or dispose of it at designated collection points. For more information see: www.recyclethis.info.

2006/66/EC (battery directive): This product contains a battery that cannot be disposed of as unsorted municipal waste in the European Union. See the product documentation for specific battery information. The battery is marked with this symbol, which may include lettering to indicate cadmium (Cd), lead (Pb), or mercury (Hg). For proper recycling, return the battery to your supplier or to a designated collection point. For more information see: www.recyclethis.info.

Contact information For contact information, see www.interlogix.com or www.utcssecurityproducts.eu

Content

	Important information	7
Chapter 1	Product introduction	8
	Product overview	8
	Default settings to access the device	8
Chapter 2	Physical installation	10
	Installation environment	10
	Unpacking the recorder and its accessories	10
	Back panel	11
	Monitor connections	13
	Rack mounting	13
Chapter 3	Getting started	15
	Powering on the recorder	15
	The startup wizard	16
Chapter 4	Operating instructions	20
	Controlling the recorder	20
	The front panel description	20
	Using the mouse	24
	Using the IR remote control	25
	Menu overview	27
Chapter 5	Live view	30
	Description of live view	30
	Video output	31
	Live view mouse menu	31
	Single and multiview display mode	33
	Sequencing cameras	33
	Live view toolbar	33
	Digital zoom	35
	PTZ preset and tours	35
Chapter 6	Playback functionality	38
	Overview of the playback view	38
	Playback mouse menu	41
	Instant playback	42
	24-hour playback	42
	Playback speed and skip time	43
	Playing back frame-by-frame	44
	Digital zoom in playback	45
	Create bookmarks	45

Chapter 7	Searching files 46 Search video menu 46 Search for motion events in playback 47 Search and play back recordings by time and video type 48 Search and playback recordings by event 49 Search bookmarked recordings 49 Search snapshots 50 Log search 51 Disk analysis 51
Chapter 8	Archiving files 52 Archiving files 52 Create and archive video clips 54 Playing back archived files on a PC 55
Chapter 9	Display settings 56 Display settings 56 Layout 57
Chapter 10	Camera setup 59 Analog camera setup 60 IP camera status 61 Camera recording settings 62 Snapshots 64 Camera OSD 65 Image settings 66 Motion detection 66 Privacy mask 68 Camera tamper 69 Restricted access camera 69 Configure PTZ settings 70 PTZ presets and tours 71 V-stream encoding 74
Chapter 11	Network settings 76 Network settings 76 PPPoE settings 78 DDNS settings 79 NTP server settings 80 E-mail settings 81 Configure an FTP server to store snapshots 82 SNMP settings 82 UPnP settings 83 Network status 83 Export network packet data 85 Network statistics 85

Chapter 12	Recording 86
	Recording schedule 86
	Modify the instant replay duration 88
	Manual recording 89
Chapter 13	Alarm and event setup 90
	Set up alarm inputs 90
	Set up alarm outputs 91
	Manual trigger 92
	Buzzer settings 92
	Alarm notification types 93
	Detect video loss 94
	Remote alarm host setup 95
Chapter 14	Device management 96
	Time and date settings 96
	General recorder settings 98
	Configuration files 99
	Upgrade system firmware 100
	Holiday schedules 100
	Text insertion 101
Chapter 15	Storage management 104
	HDD information 104
	Storage mode 105
	S.M.A.R.T. settings 107
	Bad sector detection 108
Chapter 16	User management 110
	Add a new user 110
	Customize a user's access privileges 111
	Local configuration settings 111
	Remote configuration settings 112
	Camera configuration settings 112
	Delete a user 113
	Modify a user 113
	Change the Admin password 114
Chapter 17	System information 115
	View system information 115
	Search the system log 118
Chapter 18	Using the web browser 121
	Windows 7 and Windows 8 users 121
	Access the web browser 122
	Web browser live view 122
	Control a PTZ dome camera via the web browser 124
	Play back recorded video 125

	Search for event logs	126
	Configure the recorder via the browser	127
	Text overlay	130
Appendix A	Specifications	132
Appendix B	PTZ protocols	134
Appendix C	Port forwarding information	135
	Seeking further assistance	135
Appendix D	Connect a PTZ dome camera	137
	Configuring the PTZ protocols for Interlogix cameras	137
Appendix E	KTD-405 keypad	141
	Supported firmware	141
	Wiring the keypad	141
	Setting the keypad to work with the recorder	142
	Recorder and keypad functions	143
	Operating the keypad	144
	Recorder mapping to the KTD-405 keypad	145
	Controlling a camera	147
	Connecting a KTD-405 keypad and dome camera to the recorder	148
Appendix F	Maximum pre-recording times	150
Appendix G	Supported PTZ commands	152
Appendix H	Default menu settings	154
	Index	166

Important information

Advisory messages

Advisory messages alert you to conditions or practices that can cause unwanted results. The advisory messages used in this document are shown and described below.

WARNING: Warning messages advise you of hazards that could result in injury or loss of life. They tell you which actions to take or to avoid in order to prevent the injury or loss of life.

Caution: Caution messages advise you of possible equipment damage. They tell you which actions to take or to avoid in order to prevent the damage.

Note: Note messages advise you of the possible loss of time or effort. They describe how to avoid the loss. Notes are also used to point out important information that you should read.

Chapter 1

Product introduction

Product overview

This recorder is a full featured and scalable tribrid digital video recording system that can store, display, search, export and manage video from up to 16 analog, HD analog, or IP cameras. It provides integration with the UTC portfolio of security solutions, and offers a seamless product experience within the TruVision brand.

The recorder can fully integrate with the license-free TruVision Navigator software, which is ideal for the most commercial applications. Its easy and intuitive-to-use web browser interface enables remote configuration and secure viewing, searching, and playing back of video from computers connected via the Internet.

Note: Models are shipped with the power cords for their region.

Default settings to access the device

Default user names and passwords

See Table 1 on page 9 for the list of default user names and passwords. Go to Chapter 16 “User management” on page 110 for further information.

Table 1: Default user names and passwords

User	Description
Administrator	There can only be one administrator. The user name is admin. The name cannot be modified. The default password is 1234.
Operator	The default user name is "operator". The default password is 2222.
Guest	The default user name is "guest". The default password is 3333.

Note: The default passwords should be changed for security reasons.

Default network settings

The network settings are:

- IP address - 192.168.1.82
- Subnet mask - 255.255.255.0
- Gateway address - 192.168.1.1
- Ports:

When using the browser:

RTSP port: 554

HTTP port: 80

When using TruNav:

RTSP port: 554

Server/Client software port: 8000

Go to "Using the web browser" on page 121 for further information.

Chapter 2

Physical installation

This section describes how to install the recorder.

Installation environment

When installing your product, consider these factors:

- Ventilation
- Temperature
- Moisture
- Chassis load

Ventilation: Do not block any ventilation openings. Install in accordance with the manufacturer's instructions. Ensure that the location planned for the installation of the unit is well ventilated.

Temperature: Consider the unit's operating temperature (-10 to +55 °C, 14 to 131 °F) and noncondensing humidity specifications (10 to 90%) before choosing an installation location. Extremes of heat or cold beyond the specified operating temperature limits may reduce the life expectancy of the recorder. Do not install the unit on top of other hot equipment. Leave 44 mm (1.75 in.) of space between rack-mounted DVR units.

Moisture: Do not use the unit near water. Moisture can damage the internal components. To reduce the risk of fire or electric shock, do not expose this unit to rain or moisture.

Chassis: Equipment weighing less than 15.9 kg (35 lb.) may be placed on top of the unit.

Unpacking the recorder and its accessories

When you receive the product, check the package and contents for damage, and verify that all items are included. There is an item list included in the package. If any of the items are damaged or missing, please contact your local supplier.

Items shipped with the product include:

- IR (infrared) remote control
- Two AAA batteries for the remote control
- AC power cords
- USB mouse
- Recorder
- CD with software and manuals
- *TruVision DVR 12HD Quick Start Guide*
- *TruVision DVR 12HD User Manual* (on CD)
- *TruVision Recorder Operator Guide* (on CD)

Back panel

The figures below show the back panel connections and describe each connector on a typical TVR 12HD digital video recorder. Details may vary for specific models.

Before powering up the recorder, connect the cameras and a main monitor for basic operation. Once all required connections are done, enter the relevant data in the setup wizard (see page 16).

Figure 1: TVR 12HD back panel connections (16-channel model shown)

Four-channel model:

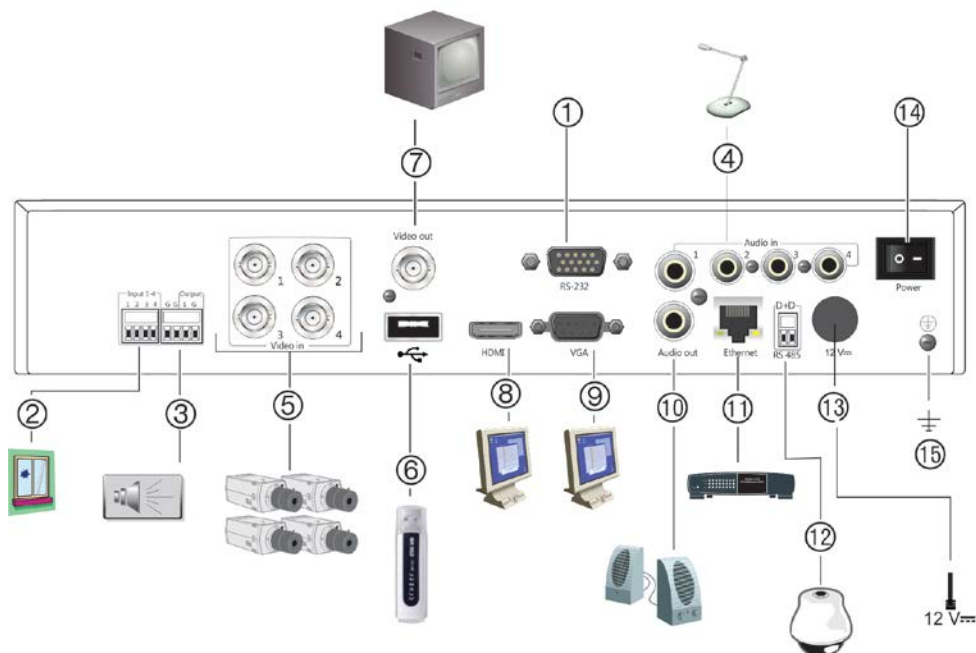

16-channel model:

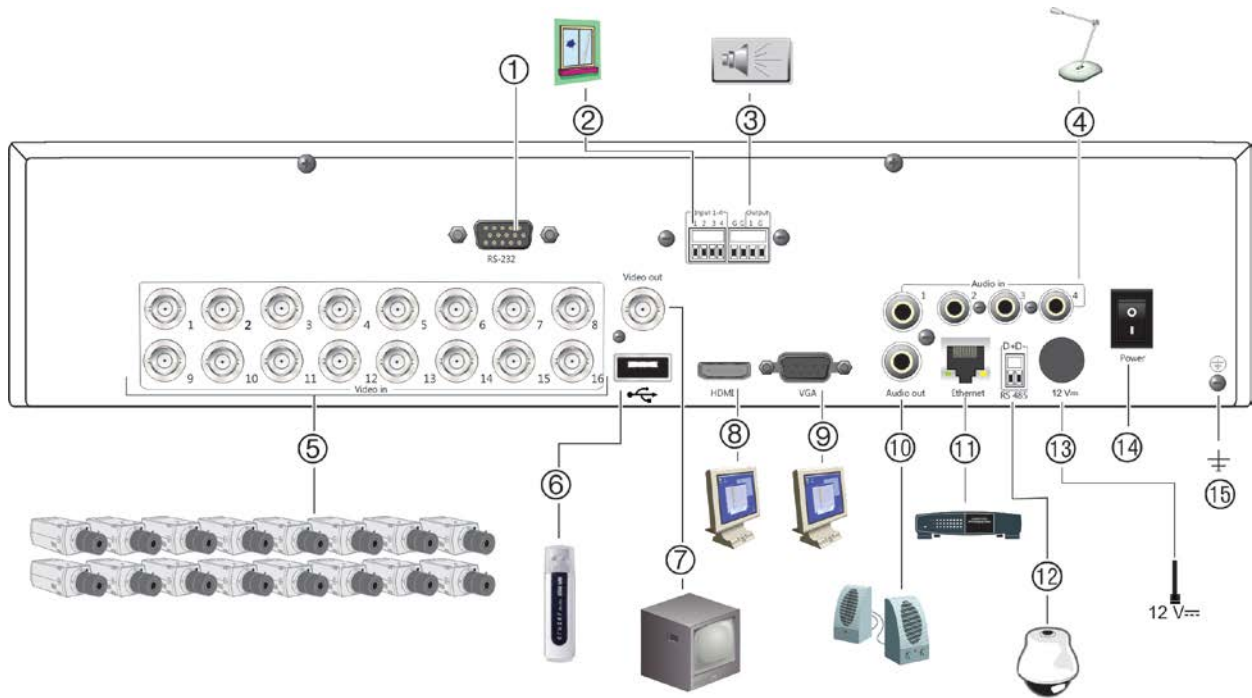

Description	Use	Specification
1. RS-232 input	Text insertion for point-of-sale and ATM devices. Also used by technical support. See “Configuring the RS-232 port” on page 102 for more information.	
2. Four alarm inputs	Connect physical alarms such as detectors, push buttons, etc.	
3. One alarm output	Connect physical alarm outputs such as siren, flash, relay.	
4. One audio input	Connect microphone for bi-directional audio (not recorded)	RCA jack, 315 mV, 40 kohms. Unbalanced. Line-level audio requires amplification.
5. Up to 16 BNC-type connectors	Connect up to 16 analog cameras to BNC connectors (depends on the recorder model)	
6. USB 2.0 port	Connect a mouse, CD/DVD burner or HDD.	The recorder supports both a USB mouse and a USB HD on the front and back USB ports.
7. BNC monitor output	Connect one event CCTV monitor.	1 Vp-p BNC signal.
8. HDMI monitor output	Connect to a HDTV. The HDMI connection supports both digital audio and video.	
9. VGA monitor output	Connect to a VGA monitor.	

	Description	Use	Specification
10.	One audio output	Connect to speakers for audio output.	RCA jack, 315mV, 600 ohms. Unbalanced. Line-level audio requires amplification.
11.	10/100/1000 RJ-45 network interface	Connect to a network.	
12.	One RS-485 port	Connect a RS-485 device such as a PTZ camera or a keypad.	D+: Connect to the RS-485 A connection on the dome camera or keypad. D-: Connect to the RS-485 B connection on the dome camera or keypad. Each PTZ camera must be set up individually. For information on configuring PTZ dome camera settings, see "Configure PTZ settings" on page 70.
13.	12 VDC PSU connector	Connect a PSU.	The PSU is shipped with the recorder.
14.	Power switch	Turn the recorder on/off.	
15.	Ground	Connect to ground.	

Monitor connections

Connect a monitor to one of the recorder's outputs (BNC/VGA/HDMI). The recorder provides a 1 Vp-p CVBS signal. See Figure 1 on page 11 for connecting a monitor to a recorder.

The recorder supports up to 1280 × 1024 / 60 Hz resolution in VGA/HDMI. The monitor resolution should be at least 800 × 600. Adjust your monitor accordingly to this resolution.

Rack mounting

TVR 1204cHD is 1U & non rack mountable. TVR 1208/16HD is 1.5U and is rack mountable using the rack mount ears delivered with the product. See Figure 6 below.

Figure 2: Rack-mount installation

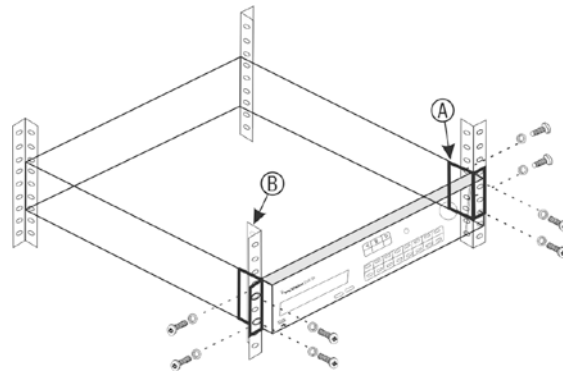

To install the racks:

1. Attach the two small front-rack mount ears (A) to the recorder (supplied).
2. Attach the recorder to the front rails (B) (screws not supplied).

Chapter 3

Getting started

Powering on the recorder

Before starting the recorder, connect at least one monitor. Otherwise, you will not be able to see the user interface and operate the device.

The recorder auto-detects the video mode (PAL or NTSC) on startup.

It comes equipped with a universal power supply that will auto-sense 110/240 V, 60/50 Hz.

Note: It is recommended that an uninterruptible power supply (UPS) is used in conjunction with the device.

To turn on the recorder:

Turn on the recorder using the power switch on the back panel. Once it is powered up, the status LEDs on the front panel will light up.

To turn off the recorder:

1. In live view mode, right-click the mouse and click **Menu**. The main menu window appears.
2. From the menu toolbar, click **Shutdown**.
3. In the Shutdown popup menu, select **Shutdown**. Click **Yes** to confirm shutdown.
You will be requested to enter the Admin password.

To reboot the recorder:

1. In live view mode, right-click the mouse and click **Menu**. The main menu window appears.
2. Select the **Shutdown** icon.
3. In the Shutdown popup menu, select **Reboot**. Click **Yes** to confirm shutdown.
You will be requested to enter the Admin password.

The startup wizard

The recorder has an express installation wizard that lets you easily configure basic recorder settings when first used. It configures all cameras to default settings. The configuration of each camera and recorder can be customized as required.

By default the startup wizard will start once the recorder has loaded. It will walk you through some of the more important settings of your recorder.

Any changes you make to a setup configuration page are saved when you exit the page and return to the main wizard page.

Note: If you want to set up the recorder with default settings only, click **Next** in each screen until the end.

To use the Startup wizard:

1. To launch the startup wizard without rebooting the device, go to **Menu > Device Management > General Settings** and click 'Start wizard'.
2. Select the preferred language for the system and resolution from the dropdown list and then click **Next**.
3. Enable or disable the option to start the wizard automatically when the recorder is turned on. Click **Next**.
4. **User configuration:**

You can change the admin password and create additional users.

Mouse: Navigate to the Admin Password edit box. Click the box to display the virtual keyboard and enter the default admin password, 1234.

Front panel or remote control: Navigate to the Admin Password edit box using the navigation buttons. Press Enter on the front panel or remote control to display the virtual keyboard. Enter the default admin password, 1234.

No.	User Name	Level	User's MAC Address
1	admin	Admin	00:00:00:00:00:00
2	operator	Operator	00:00:00:00:00:00

Note: You must enter an admin password. To change the Admin password, check **New Admin password** and enter the new password and confirm it.

Caution: It is strongly recommended that you change the password of the administrator. Do not leave 1234 as the default password. Write it down in a safe place so that you do not forget it.

If you should forget the password to your recorder, contact your supplier with the serial number of your recorder to obtain a secure code to reset it.

Click **Next**.

5. Time and date configuration:

Select the desired time zone, date format, system time, and system date.

If Daylight saving time (DST) is required, check **Enable DST** and enter the desired summer and winter times.

Time Zone	(GMT-08:00) Pacific Time(U.S. & Canada)
Date Format	MM-DD-YYYY
Time Format	24-hour
System Date	10-22-2014
System Time	09:26:26
Enable DST	<input checked="" type="checkbox"/>
From	Mar 2nd Sun 2 : 00
To	Oct last Sun 2 : 00
DST Bias	60 Minutes

Apply

Previous Next Cancel

Note: The system time and date are visible on screen. However, they do not appear in recordings.

Click **Apply** and then **Next** to move to the next page or click **Previous** to return to the previous page.

6. Network configuration:

Configure your network settings such as the NIC type, IP address, subnet mask, and default gateway. Enter the preferred DNS server address as well as the alternate one to use.

NIC Type	10M/100M Self-adaptive
Enable DHCP	<input type="checkbox"/>
IPv4 Address	192 . 168 . 1 . 82
IPv4 Subnet Mask	255 . 255 . 255 . 0
IPv4 Default Gateway	192 . 168 . 1 . 1
Preferred DNS Server	
Alternate DNS Server	

UPnP Previous Next Cancel

Click **Next** to move to the next page, or **Previous** to return to the previous page.

7. HDD management:

The hard drives are initialized at the factory. However if you wish to clear all data, click **Initialize** to initialize the HDD and **Next** to move to the next page, or **Previous** to return to the previous page.

8. Adding IP cameras:

Note: You must disable analog cameras before adding IP cameras.

Click **Search** to find any available IP cameras.

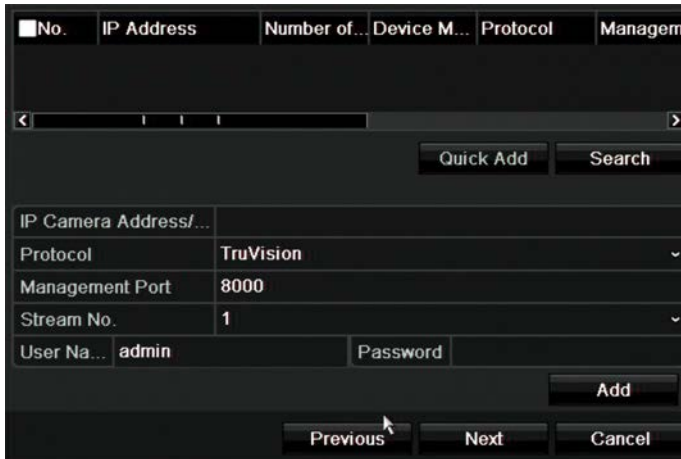

There are two ways to add an IP camera to the recorder system:

Manually: Enter the IP address of the IP camera to be added. Select the appropriate protocol, stream number and management port and then enter User name and Admin password, and then click the **Add** button. Click, **Next** to move to the next page.

Automatically: Select the desired IP cameras from the search results list. Click **Quick Add** to add the selected cameras to the recorder system without modifying the camera configuration. The search list will display all supported IP cameras that are located on the LAN.

Click **Next** to move to the next page, or **Previous** to return to the previous page.

9. Recording configuration:

Configure your recording settings as required. The settings apply to all cameras connected to the recorder.

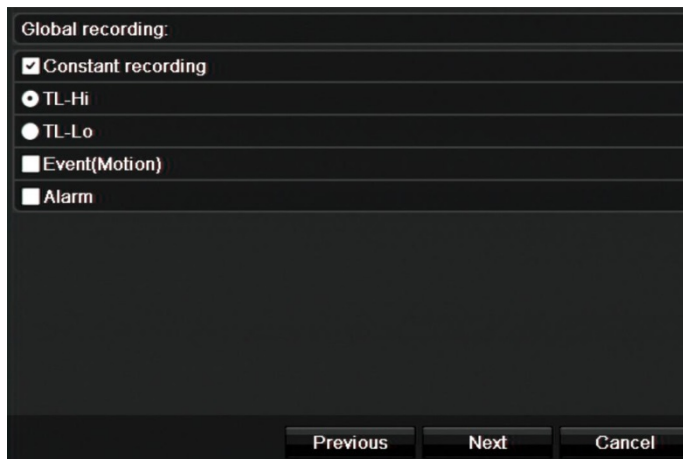

Check the **Constant Recording** checkbox for the recorder to record continuously all day. If left unchecked, the recorder will not record.

Check the desired time lapse check box, **TL-Hi** or **TL-Lo**.

To record motion detection events, check **Event (Motion)**.

To record alarm events, check **Alarm**.

Click **Next** to move to the next page, or **Previous** to return to the previous page.

Note: You can configure the recording parameters of each individual camera for the different recording schedules in the recording menu.

- When all the required changes have been entered, a summary page appears showing all the settings.



Click **Finish** to exit the Wizard. The recorder is now ready to use.

For a description of the recorder main menu, see “Menu overview” on page 27.

Chapter 4

Operating instructions

Controlling the recorder

There are several ways to control the recorder:

- Front panel control. See “The front panel description” below.
- Mouse control. See “Using the mouse” on page 24.
- IR remote control. See “Using the IR remote control” on page 25.
- KTD-405 keypad control. See Appendix E “KTD-405 keypad” on page 141 for more information.
- TVK-800 keypad (from TVK-800 firmware version 1.0i). Please refer to the user manual for more information.
- Web browser control (TruVision Navigator, TVRmobile). See Chapter 18 “Using the web browser” on page 121 for more information on using the web browser. Please refer to the TruVision Navigator and TVRmobile user manuals for more information.

You can use your preferred control method for any procedure, but in most cases we describe procedures using the mouse. Optional control methods are given only when they differ substantially from the mouse control methods.

The front panel description

The function buttons on the front panel control can be used to operate most, but not all, of the main functions of the recorder. The LED indicators light up to alert you of various conditions. The functions available can be limited by setting passwords. See Figure 9 on page 21 for more information.

Figure 3: TVR 12HD front panel

4-channel model:

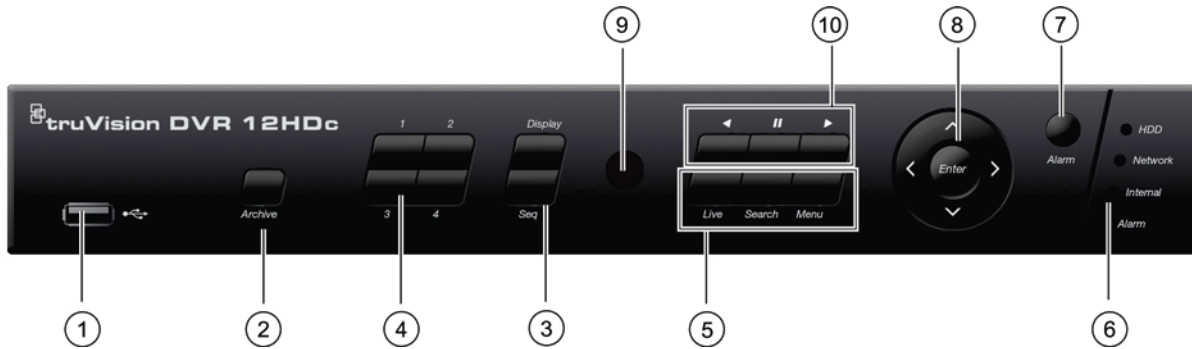

16-channel model:

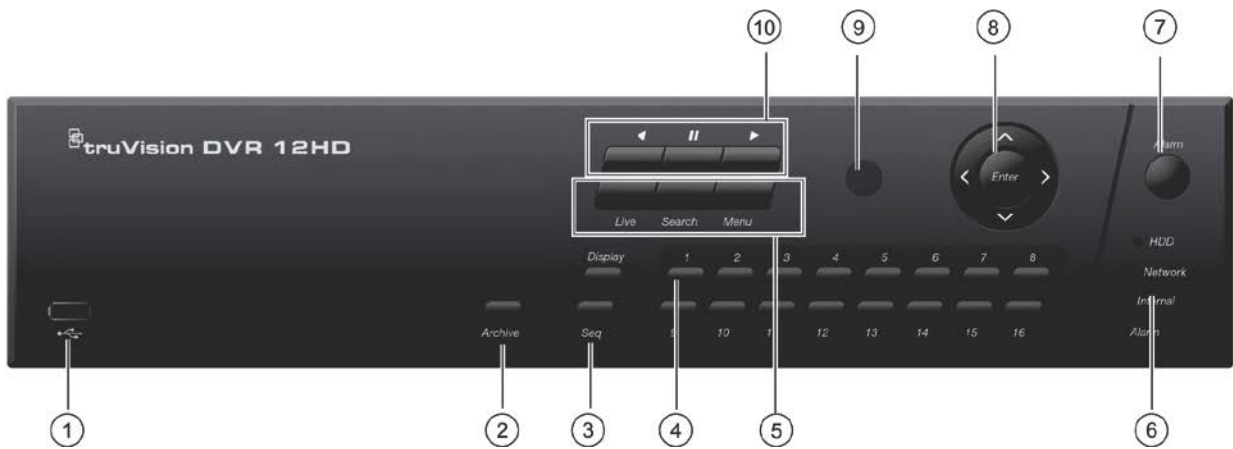

The controls on the front panel include:

Name	Description
1. USB 2.0 port	Use the USB port to archive video, upgrade firmware, use a USB mouse or connect a USB CD/DVD burner.
2. Archive button	Press once to enter quick archive mode. Press twice to start archiving. If the USB stick has an LED, it will flash during archiving.
3. Display and Seq buttons	Press Display to toggle through the various views (single and multiviews). Press Seq to start/stop sequencing in live view mode.
4. Channel buttons	Switch between different cameras in live view, PTZ control or playback modes. Use the soft keyboard to enter numerals 0 to 9.











	Name	Description
5.	Live, Menu and Search buttons	<p>Live: Switch to live view mode.</p> <p>Press and hold for five seconds to lock live view. No actions can be carried out from the front panel during this time. Mouse actions are still allowed. Live view remains locked until the button is pressed again for five seconds.</p> <p>Menu: Enter/exit the main menu.</p> <p>Search: Enter the advanced search menu.</p>
6.	Status LEDs	<p>HDD: A steady GREEN light indicates that the recorder is accessing the HDD in read or write operation. A steady RED light indicates HDD failure.</p> <p>Network: A steady GREEN light indicates that the recorder is currently connected to a network. No light indicates that the recorder is not connected to any network.</p> <p>Internal: A steady GREEN light indicates that the recorder is currently recording video/audio. A steady RED light indicates internal health failure.</p> <p>Alarm: A steady RED light indicates that there is a sensor Alarm In. A steady GREEN light indicates no alarm.</p>
7.	Alarm button	Use to manually acknowledge an alarm.
8.	Enter and arrows buttons	<p>Use to select options in a menu and to control playback. Press for Enter.</p> <p>Live view mode: Press Enter to enter/exit PTZ mode. Press the left/right arrow buttons to scroll between the cameras.</p> <p>Menu mode: To enter the menu toolbar, keep pressing the left arrow button until the first menu icon is selected. Then press the left/right arrow buttons to select a menu icon. To select a menu option in the submenu panel or setup menu, press the arrow buttons left/right and up/down to position cursor in the menu window. Press for Enter. See Figure 12 on page 27.</p> <p>Playback mode: Press the left/right arrow buttons to slow down or speed up playback. Press the up/down arrow buttons to jump forwards or backwards by 30 seconds. Press Enter to stop/start playback.</p> <p>PTZ mode: Press the arrow buttons to control the movement of the PTZ dome camera.</p>
9.	IR receiver	Receiver for IR remote.
10.	Playback buttons	<p> Reverse: Press to jump back to the oldest available video and start the playback.</p> <p> Pause: Press to pause playback.</p> <p> Play: Press to start 24-hour playback of the currently selected camera. If you are in multiview format, only the camera shown in the top-left corner of the multiview is played back.</p>

Table 2: Front panel button functions by task

Task	Button	Button function
Live view mode	Direction	Press to cycle through channels.
	Enter	Press to show the PTZ control toolbar.
	 Reverse	Press to play the earliest video file of the current camera (upper-left video tile if in multiview mode).
	 Pause	Press to freeze the last image of the live display for all active cameras displayed.
	 Play	Press to play 24-hour playback of the current camera (upper-left video tile if in multiview mode).
	Live	Press to switch to live view mode.
	Seq	Press to start/stop sequencing cameras on the current monitor. Hold the Seq button for three seconds to start and stop sequencing.
	Menu	Press to enter the main menu.
Playback mode	Direction	The left and right buttons are used to speed up and slow down recorded video. The up and down buttons are used to jump recorded video forwards or backwards by 30 s.
	Enter	Press the button to pause the video. Press again to restart the video. In single-frame Playback mode, press to advance the video by a single frame.
	 Reverse	Press to play back a camera in reverse direction. In Picture Playback mode, view pictures in reverse direction.
	 Pause	In Playback mode, stop playback.
	 Play	In Playback mode, play back a camera in the forward direction.
Pause mode	Direction	The left and right buttons are used to jump recorded video forwards or backwards by one frame. The up and down buttons are used to jump recorded video forwards or backwards by one second.
PTZ control mode	Direction	Press to control the movement of the PTZ camera.
	Zoom +/-	Press to zoom in and out.
	Preset	Press Preset and a numeric button to call the specified preset.
	Tour	Press Tour and a numeric button to call the specified shadow tour.
	 Play	Press to do an auto tour.
	Display	Press to delete a selected key point from the PTZ Setting > More Settings> Tour > Key Point list.
Menu navigation	Direction	Press to navigate between different fields and items in menus.
	Menu	Enter/exit the main menu.

Task	Button	Button function
	Enter	Press to confirm the selection in any of the menu modes.

Using the mouse

The USB mouse provided with the recorder can be used to operate all the functions of the unit, unlike the front panel which has limited functionality. The USB mouse lets you navigate and make changes to settings in the user interface.

Connect the mouse to the recorder by plugging the mouse USB connector into the USB port on the back panel or the front panel. The mouse is immediately operational and the pointer should appear.

Note: Use a USB 2.0 mouse.

Move the pointer to a command, option, or button on a window. Click the left mouse button to enter or confirm a selection.

You can purchase a spare mouse by ordering part number TVR-MOUSE-1.

See Table 6 below for a description of the mouse buttons.

Table 3: Mouse buttons

Item	Description	
Left button	Single-Click	<p>Live view: Select a camera to display the live view toolbar.</p> <p>Menu: Select a component of a menu, such as a button or an input field. This is similar to pressing the Enter button on the remote/front panel controls.</p>
	Double-Click	<p>Live view: Switch between single screen and multi-screen mode in live/ playback mode.</p>
	Click and Drag	<p>Live view: Drag channel/time bar.</p> <p>PTZ control: Adjust pan, tilt and zoom.</p> <p>Tamperproof, privacy masking and motion detection functions: Select the target area.</p> <p>Digital zoom-in: Drag and select target area.</p>
Right button	Single-Click	<p>Live view: Display menu.</p> <p>Menu: Exit the current menu and return to higher level.</p>
Scroll-wheel	Scroll Up	<p>Live view: Return to the previous window.</p> <p>Menu: Move the selection to the previous item.</p>
	Scroll Down	<p>Live view: Move to the next window.</p> <p>Menu: Move the selection to the next item.</p>

Using the IR remote control

The recorder is supplied with an infrared (IR) remote control unit. Like the mouse, it can be used to operate all of the main functions of the unit.

The IR remote control can be programmed with a unique device ID address so that the controller will only be able to communicate with recorders with that address. No programming is necessary if using a single recorder.

The device ID address only applies when using a remote control and not when using a keypad.

You can purchase a replacement remote control by ordering part number TVR-REMOTE-1.

Figure 4: IR remote control

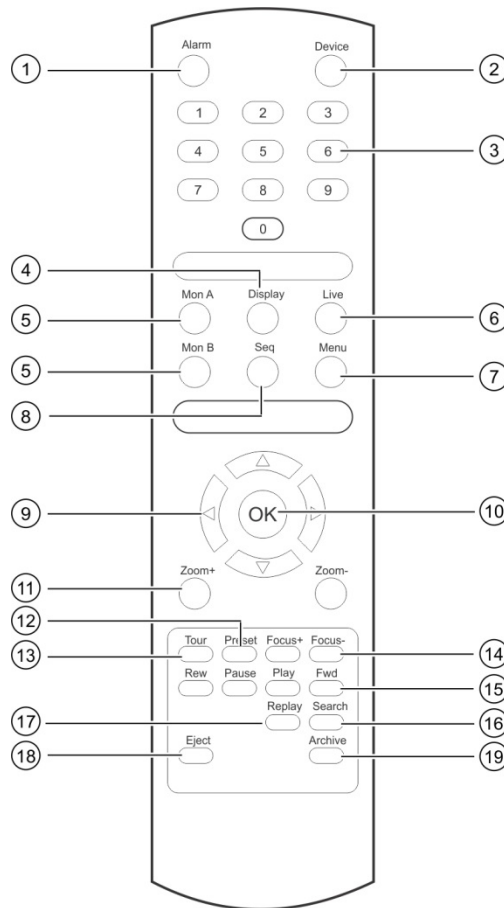

Item	Description
1. Alarm	Acknowledge an alarm.
2. Device	Enable/disable the IR remote control to control the recorder.
3. Numeric buttons	Select a camera, and enter a number in a menu option.
4. Display	Switch between the different multiview formats.
5. Mon A and Mon B	Switch between monitors A and B.
6. Live	Return to live view mode.

Item	Description
7. Menu	Activate the main menu.
8. Seq	Start /stop sequencing.
9. <, >, ^, v	In Menu mode: Use left or right arrow buttons to select and up or down arrow buttons to edit entry. In PTZ mode: Use to control PTZ. In Playback mode: Use to control playback speed.
10. OK	Confirm selection.
11. Zoom + and -	Use to control zoom of camera lens.
12. Preset	Enter preprogrammed three-digit code to call up a preset.
13. Tour	Enter preprogrammed three-digit code to call up shadow tour.
14. Focus + and -	Use to control focus of camera lens.
15. Playback control	Use to control playback (Rewind, Pause, Play, and Fast Forward).
16. Search	Open the Search menu.
17. Replay	Replay the selected file from the beginning.
18. Eject	Eject the CD or DVD disk.
19. Archive	Press once to enter quick archive mode. Press twice to start archiving.

Aim the remote control at the IR receiver located at the front of the unit to test operation.

To change the address of the remote control to the recorder:

1. Press the **Menu** button on the front panel or right-click the mouse and select the **Menu** button. The default display menu window appears.
2. Click **Device Management > General Settings**.
3. Check the remote control ID value. The default value is 255. This device address is valid for all IR controls.

Note: The recorder will respond to any remote control that has an address between 1 and 255.

4. On the remote control press the **Device** button.
5. Enter the device address value. It must be the same as that on the recorder.
6. Press the **OK** button on the remote control.

To place batteries into the IR remote control:

1. Remove the battery cover.
2. Insert the batteries. Make sure that the positive (+) and negative (-) poles are correctly placed.
3. Replace the battery cover.

Troubleshooting the remote control

If the IR remote control is not functioning properly, perform the following tests:

- Check the battery polarity.
- Check the remaining charge in the batteries.
- Check that the IR remote control sensor is not masked.

If the problem still exists, please contact your administrator.

Menu overview

The recorder has an intuitive structure that allows you to configure the unit's parameters quickly and efficiently. Each command icon displays a window that lets you edit a group of settings. Most menus are available only to system administrators.

The window is divided into three sections. The currently selected command icon and submenu item are highlighted in green. See Figure 12 below.

You must be in live view mode to access the main menu.



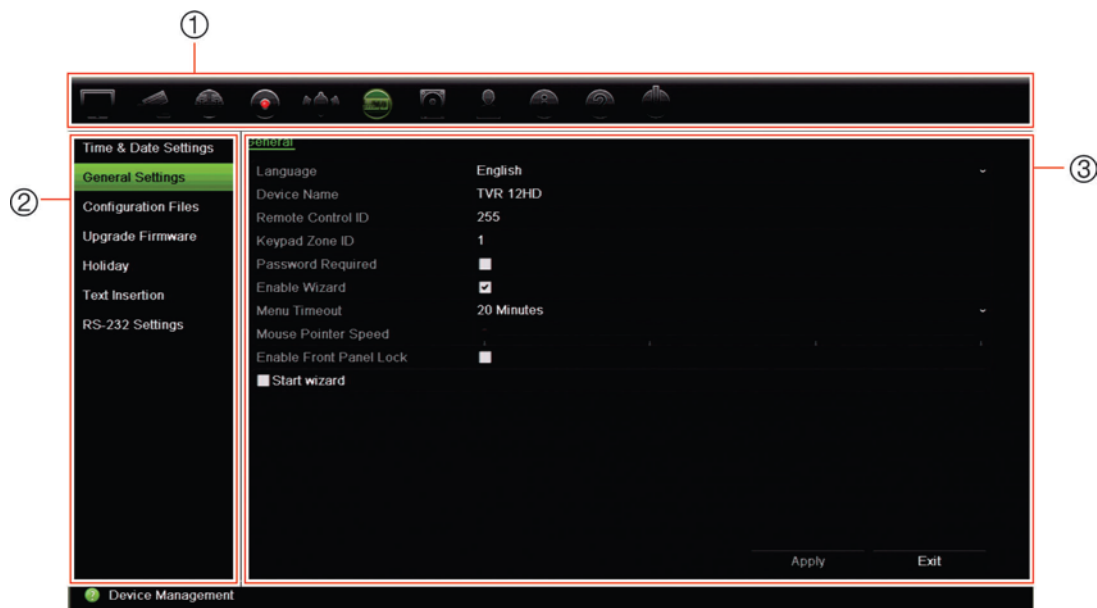







Figure 5: Menu structure



1. **Menu toolbar:** Setup options available for the selected menu function. Move the mouse over a command icon and click to select it. See Table 4 below for a description of the icons.
2. **Submenu panel:** Submenus for the selected menu function are displayed. Click an item to select it.
3. **Setup menu:** All the details for the selected submenu are displayed. Click a field to make changes.

Note: See Table 2 on page 21 for the description on how to access the menu options using the front panel.

Table 4: Description of the menu toolbar icons

Icon	Name	Description
	Display Settings	Configures display settings including video format, resolution, video output interface, dwell time, multiview format, and camera sequencing. See Chapter 9 “Display settings” on page 56.
	Camera Setup	Configures analog and IP cameras, snapshot resolution and quality, camera settings including OSD, privacy masking, tampering, restricted access, motion detection setup, PTZ setup, preset tours and show tours, V-stream encoding. See Chapter 10 “Camera setup” on page 59
	Network Settings	Configures standard network settings including IP address, email notifications, DDNS setup, and advanced network settings. See the Chapter 11 “Network settings” on page 76.
	Recording	Configures recording settings including instant replay duration, recording schedule, and manual recording. See Chapter 12 “Recording” on page 86.
	Alarm and Event Setup	Configures alarm settings including alarm input, alarm output, manual trigger, buzzer settings, alarm notifications, video loss, and alarm host setup. See Chapter 13 “Alarm and event setup” on page 90.
	Device Management	Configures system settings including system date and time, DST, language, menu timeout, import/export config files, firmware upgrade, holiday schedules, text insertion, and RS-232 settings. See Chapter 14 “Device management” on page 96.
	Storage Management	Configures HDD information, storage mode, S.M.A.R.T. settings, and bad sector detection. See Chapter 15 “Storage management” on page 104.
	User Management	Configures users, passwords, and access privileges. See Chapter 16 “User management” on page 110.
	System Information	Displays device information, camera setup information, recording setup information, alarm inputs information, alarm outputs information, network information, HDD information, and log search. See Chapter 17 “System information” on page 115.
	Help	Provides reference information to the various toolbars, menus, and keys within the interface.
	Shutdown	Provides access to logout, reboot, and shutdown options. See “Powering on the recorder” on page 15.

To access the main menu:

1. In live view, press the **Menu** button on the remote control or front panel.

- Or -

Right-click the mouse and select **Menu** from the pop-up menu.

The main menu window appears. The Display Settings window appears by default.

2. Click the required menu icon to display its submenu options. Modify the configuration parameters as required.
3. Click **Apply** to save the settings.
4. Click **Exit** to leave the menu setup and return to live view.

The soft keyboard

A keyboard will appear on-screen when you need to enter characters in a window option. Click a key to input that character.

Figure 6: The soft keyboard



Description of the keys in the soft keyboard:

	Switch to lowercase/uppercase
	Space
	Exit the soft keyboard
	Alphanumeric characters
	Backspace
	Punctuation
	Confirm selection

Exiting the main menu

Press the **Menu** button on the front panel to exit the current menu window and return to live view, or click **Exit** in a main menu.

Chapter 5

Live view







Description of live view

Live view mode is the normal operating mode of the unit where you watch live images from the cameras. The recorder automatically enters into live view mode once powered up. On the monitor you can see whether a recording is in progress and, if set up to do so, the current date and time, as well as the camera name.

Status information

Information on the system and camera status is displayed as icons on the main and auxiliary monitors. The camera status icons are shown for each camera. Each icon represents information on a specific item. These icons include:

Table 5: Description of the on-screen status icons

Icon	Description
	Indicates an alarm.
	Indicates that a camera channel is being recorded.
	Indicates a motion detection event.
 Video Loss	Indicates a video loss event.
	Indicates alarm and system notifications. Clicking the icon opens a window that lists the alarms and notifications.
	Indicates manual recording.
	Indicates that live view is locked from the front panel. Mouse actions are still allowed.

The recorder can display more than one icon at the same time. See “General settings” on page 98 to display or hide these icons.

The system status is displayed on the front panel by the status LEDs.

Video output

The recorder automatically checks the monitor outputs used on startup. If more than one monitor is connected, it then defines which monitor is the main monitor and which is the event monitor. The event monitor is used to display detected events such as motion. Only one monitor can be controlled at a time.

If a HDMI monitor is used, it will be the main output. If HDMI and VGA monitors are both connected to the recorder, both will be main monitors; they will both show the same view.

See “Controlling live view” on page 31 for more information on setting up the monitors.

Monitor A is the main monitor. When an alarm or motion is detected, the camera with the alarm/motion event is displayed on monitor B. When there are multiple alarm or motion events, the camera images are sequenced on monitor B.

Live view mouse menu

Many features of live view can be quickly accessed by placing the cursor on a live image and clicking the right-button of the mouse. The mouse menu appears (see Figure 14 below).

Figure 7: The mouse menu for the main monitor

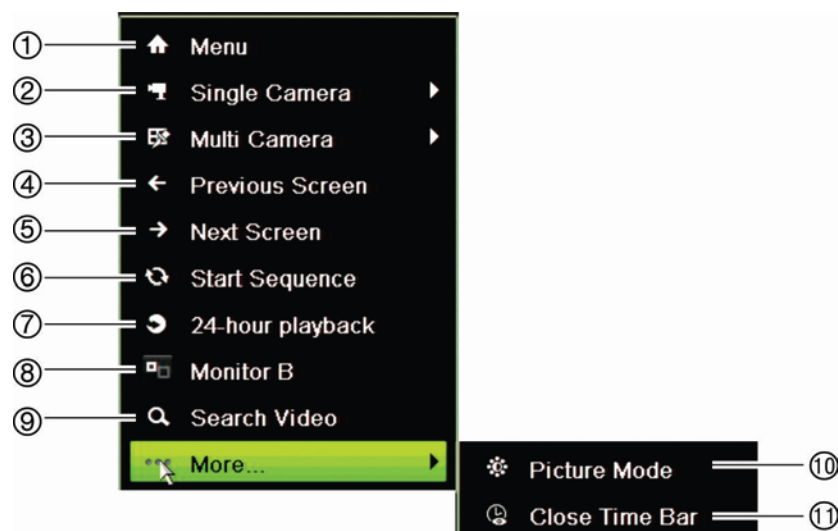

The list of commands available depends on which monitor is active; main or auxiliary (monitor B). See Table 6 on page 32. The default settings of these commands are provided in the appendix under “Default menu settings” on page 154.

Table 6: Mouse menu for monitor A (main monitor)

	Name	Description
1.	Menu	Enter the Main menu. This option is not available from monitor B.
2.	Single Camera	Switch to a full-screen view for the selected camera from the dropdown list. See “Single and multiview display ” on page 33 for more information.
3.	Multi Camera	Switch between the different multiview options from the dropdown list. See “Single and multiview display ” on page 33 for more information.
4.	Previous Screen	Displays the previous camera.
5.	Next Screen	Displays the next camera.
6.	Start Sequence	Turn on sequence mode. The window automatically sequences between cameras. To set up the sequence dwell time, go to Menu > Display Settings > Display > Sequence Dwell Time and select a value.
7.	24-hour Playback	Playback the recorded video of the selected day from the selected camera. The current day is selected by default. See “24-hour playback” on page 42 for more information.
8.	Monitor B	Switch between monitors A (main) and B (event).
9.	Advanced Search	Enter the advanced video search menu. See “Searching recorded video” on page 43 for more information.
10.	Picture Mode	Select Standard, Bright, Soft, or Vivid mode to display.
11.	Close Time Bar	Open/close the time bar.

Table 7: Mouse menu for monitor B (event monitor)

	Name	Description
1.	Single Camera	Switch to a full-screen view for the selected camera from the dropdown list.
2.	Multi Camera	Switch between the different multiview options from the dropdown list.
3.	Previous Screen	Displays the previous camera.
4.	Next Screen	Displays the next camera.
5.	24-hour Playback	Playback the recorded video of the selected day from the selected camera. The current day is selected by default. See “24-hour playback” on page 42 for more information.
6.	Monitor A	Switch between monitors A (main) and B (event).

Single and multiview display mode

The recorder has single and multiview formats. The number of multiview display modes available depends on the recorder model.

Single view display format	<p>Press the numeric button on the front panel to switch to the corresponding camera display. For example, press button 10 to view camera 10.</p> <p>-Or-</p> <p>Right-click the mouse and select Single Camera from the menu. Select the required camera from the list.</p>
Multiple view display format	<p>Press the Display button on the front panel to cycle through different display formats.</p> <p>-Or-</p> <p>Right-click the mouse and select Multi Camera from the menu. Select the desired multiview display layout.</p>

Sequencing cameras

The sequencing feature allows a camera to be displayed briefly on screen, before advancing to the next camera in the sequence list. Sequencing can only be done in single-view display mode.

The default sequence displays each camera in numerical order. However, each camera on the main and event monitors can have a pre-programmed dwell time and sequence order. See “Layout” on page 57 for more information.

Note: Dwell time must not be set to zero for sequencing to function.

Sequencing cameras using the front panel:

Select the camera where you want to start sequencing. Press the **Seq** button on the front panel to start sequencing. Press it again to stop sequencing.

Sequencing cameras using the mouse:

Select the camera where you want to start sequencing. Right-click the mouse and select **Start Sequence** to start the sequencing. Right-click again and select **Stop Sequence** to stop sequencing.











Live view toolbar



The live view toolbar in live view lets you quickly access regularly used commands. Position the cursor over a video image and left-click the mouse. The toolbar appears (see Figure 16 on page 34).

Figure 8: Live view toolbar



Table 8: Description of the live view toolbar icons

Icon	Description
	Pause: Freeze the live image of the selected camera. Although the image pauses, time and date information does not. The system clock continues to run.
	Start Manual Recording: Start/stop manual recording. The icon is red when manual recording is enabled. See “Recording schedule” on page 86 for information on setting up this function.
	Instant Playback: Playback the recorded video from the last five minutes. If no recording is found, then there was no recording made in the last five minutes. Click the icon and select the desired camera. Click OK. See “Modify the instant replay duration” on page 88 For more information.
	Audio On: Enable/Disable audio output. The audio option must already have been setup in the Display menu.
	Snapshot: Capture a snapshot of a video image. The image is saved on the unit. See “Slideshow of snapshots” on page 47 for more information.
	PTZ Control: Enter PTZ control mode. See “Configuring PTZ settings” on page 70 for more information.
	Digital Zoom: Enter digital zoom. See “Digital zoom” on page 35 for further information.
	Image Settings: Enter the image settings menu to modify the image lighting levels. There are two options: Preset Mode: These are preconfigured image lighting levels. Select one of the four options depending on current lighting conditions: <ul style="list-style-type: none"> - <i>Standard:</i> Use in standard lighting situations. - <i>Indoor:</i> Use indoors. - <i>Dim Light:</i> Use when the light level is low. - <i>Outdoor:</i> Use when outdoors. The contrast and saturation values are high. Customize: Modify brightness, contrast, saturation, and hue values. Click Restore to restore image settings to previous values. Click Restore to restore image settings to previous values. Click Default to return to default values. These settings can also be modified from the Camera Setup > Image menu (see page “Image settings” on page 66.
	Show Text: Display inserted text on screen. The color of the text can be changed: Black, white, or pink.
	Auxiliary Focus: Automatically focus the camera lens for the sharpest picture.

Icon	Description
	Lens Initialization: Initialize the lens of a camera with a motorized lens, such as PTZ or IP cameras. This function helps to maintain lens focus accuracy over prolonged periods of time.
	Close Toolbar: Close the toolbar.

Digital zoom

You can easily zoom in or out of a camera image in live view mode and playback using the digital zoom command. The zoom command magnifies the camera image four times. See Figure 17 below.

Figure 9: Digital zoom window





To quickly zoom in/out on a camera image:

1. Left-click the mouse on the desired camera. The live view toolbar appears.
2. Click the digital-zoom icon. The digital view window appears.
3. Left-click the mouse and drag the red square to the area of interest, or press the arrow buttons on the front panel to position the red square. The selected area is magnified.
4. To exit digital zoom, right-click the mouse.

PTZ preset and tours

When in live view you can quickly call up the list of existing presets, preset tours and shadow tours by using the front panel, remote control, mouse and keypad.

Front panel	Press Enter . PTZ control panel appears.
Mouse	Left-click the mouse on the desired camera image. The live view toolbar appears. Click the PTZ control icon  to enter PTZ mode. The PTZ control panel appears.
Remote control	Press the OK button. The PTZ control panel appears.
Keypad	Press the Enter  button on the keypad. For further information on using the KTD-405 keypad, see Appendix E “KTD-405 keypad” on page 141.

If the display was in multiview format, it changes to full-screen format for the selected camera. See Figure 10 below for a description of the PTZ control panel.

Figure 10: PTZ control panel

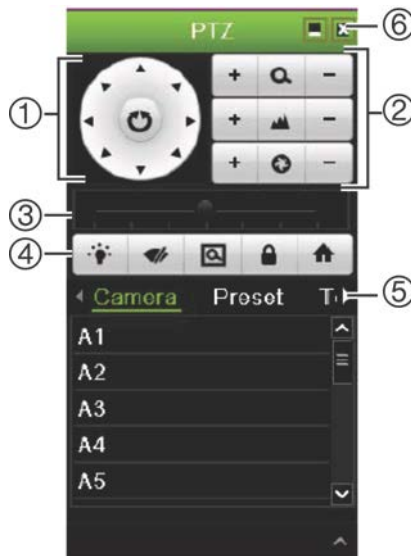







Table 9: Description of the PTZ control panel

Name	Description
1. Directional pad/auto-scan buttons	Controls the movements and directions of the PTZ. The center button is used to start auto-pan by the PTZ dome camera.
2. Zoom, focus, and iris	Adjusts zoom, focus and iris.
3. PTZ movement	Adjusts the speed of PTZ movement.
4. Toolbar	 Turns on/off camera light.
	 Turns on/off camera wiper.
	 Zoom area.
	 Centers the PTZ dome camera image. This command is not supported on all PTZ dome cameras.
	 Jumps to the home position.
5. Select PTZ command	Displays the desired function from the scroll bar: camera, preset, preset tour or shadow tour.
6. Exit	Exits the PTZ control panel.

To call up a preset:

1. In live view, left-click the mouse and select the PTZ control icon in the quick access toolbar. The PTZ control panel appears. Select the desired camera from the toolbar.

– Or –

On the front panel, select the desired camera and press **Enter** to call up the quick access toolbar. The PTZ control panel appears.

2. Scroll the toolbar to **Preset** and double-click the desired preset from the list. The camera immediately jumps to the preset position.

To call up a preset tour:

1. In live view, left-click the mouse and select the PTZ control icon in the live view toolbar. The PTZ control panel appears. Select the desired camera from the toolbar.

– Or –

On the front panel, select the desired camera and press **Enter** to call up the live view toolbar. The PTZ control panel appears.

2. Scroll the toolbar to **Tour** and double-click the desired preset tour from the list. The camera immediately carries out the preset tour movement.

To call up a shadow tour:

1. In live view left-click the mouse and select the PTZ Control icon in the live view toolbar. The PTZ control panel appears. Select the desired camera from the toolbar.

– Or –

On the front panel, select the desired camera and press **Enter** to call up the live view toolbar. The PTZ control panel appears.

2. Scroll the toolbar to **Shadow Tour** and double-click the shadow tour from the list. The camera immediately carries out the shadow tour movement.

Chapter 6

Playback functionality

The recorder lets you quickly locate and play back recorded video. There are four ways to play back video:

- Instant playback of the most recently recorded video
- 24-hour playback of one day's recorded video
- Search video by specific time, events, motion detection, bookmarks, or snapshots (see Chapter 7 "Searching files" on page 46 for further information)

The recorder continues to record the live view from a camera while simultaneously playing back video on that camera display. You must have the access privilege to play back recordings (see "Customize a user's access privileges" on page 111 for more information).

Overview of the playback view

It is easy to manage playback from the playback window.

The playback video can be set up to display a time/date stamp for evidentiary purposes (see "Camera OSD" on page 65).

The playback windows for 24-hour playback and for the results of a search are slightly different.

Figure 11: Playback window (24-hour playback shown)

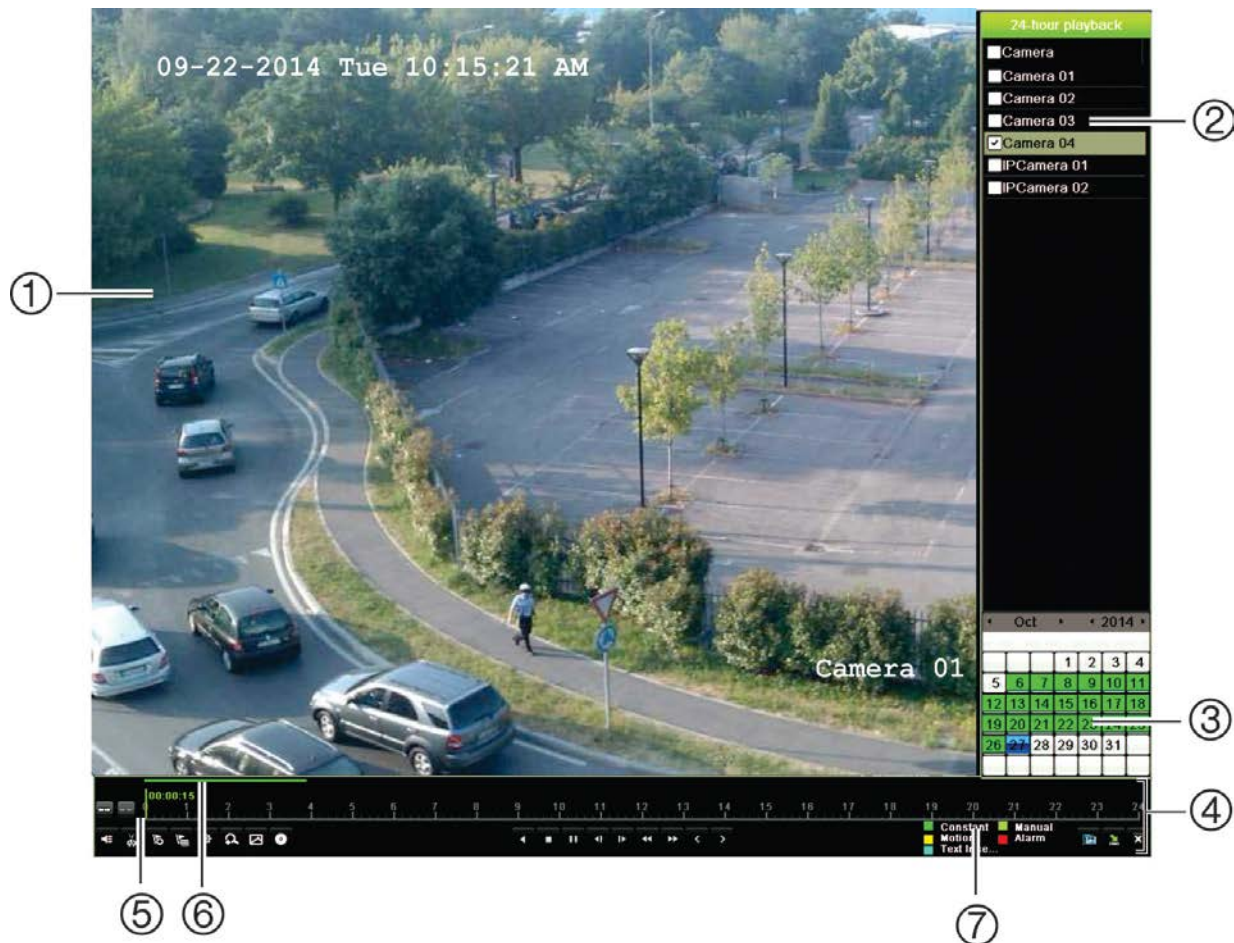

1. Playback viewer.
2. **Camera panel.** Select the cameras for playback. Move the mouse over the area to display the list of cameras available.
3. **Calendar panel.**
Blue: Current date
Green/Yellow/Red: Recordings available on the recorder.
4. **Playback control toolbar.** See Figure 12 on page 40 for more information.
5. **Time bar:** Time of actual playback. This is only displayed in 24-hour playback.
6. **24-hour recording progress bar:** This bar displays how much of the 24-hour period has been recorded.
7. **Recording type:** Description of the color coding of recording types that appear in the playback progress bar. Green indicates constant recording. Red indicates alarm recording. Yellow indicates motion recording. Pale green indicates manual recording. Pale blue indicates text insertion.

The playback control toolbar

It is easy to manually control playback using the playback control toolbar. See Figure 12 on page 40 below.

Note: The playback control toolbar does not appear for instant playback.

Figure 12: Playback control toolbar (Search playback example shown)

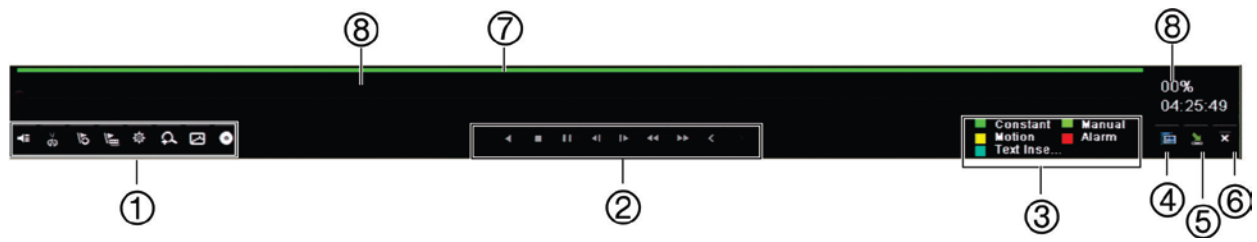

Item	Description
1.	<p>Audio and video control toolbar:</p> <ul style="list-style-type: none"> / Audio on/off. / Start/stop a video clip during playback. Sections of a recording can be saved to an external storage device. Add default bookmark. Add customized bookmark. Bookmark management. Click to see the list of bookmarks and their times. They can be renamed or deleted. Digital zoom. Click to enter the digital zoom function. Click again to exit. See “Digital zoom in playback” on page 45 for more information. Smart search for motion detection. Click to enter the motion search view. Archive files.
2.	<p>Playback control toolbar:</p> <ul style="list-style-type: none"> Reverse play the recording. Click again to pause. Stop playback. Time displayed is 00:00:00. Play recording. Fast forward playback by the configured skip time (default is 30 seconds). Reverse playback by the configured skip time (default is 30 seconds). Decrease playback speed: Options available are: ½ speed, ¼ speed, 1/8 speed, single frame. Increase playback speed. Options available are: 2X speed, 4X speed, 8X speed, 32X speed. Play previous file/day/event recording. Play next file/day/event recording in the search result.
3.	<p>Recording type: Description of the color coding of the five recording types that appear in the playback progress bar. Green indicates continuous recording. Yellow indicates motion detection. Blue indicates text insertion. Pale green indicates manual recording. Red indicates alarm recording.</p>
4.	<ul style="list-style-type: none"> Call up the Search window to search for recorded video files.
5.	<ul style="list-style-type: none"> Hide the playback control toolbar.

Item	Description
6.	 For 24-hour playback mode, quit playback and return to live view. For playback from search mode, quit playback and return to the search window.
7.	Playback bar: This bar displays the playback recording. It indicates in color the type of recording. Constant recording is shown in the example above.
8.	Timeline: Allows you to jump forwards or backwards in time. The timeline moves left (oldest video) to right (newest video). Click a location on it for where you want playback to start. In 24-hour playback, the cursor shows the actual time. In search playback, the cursor is a ball. The actual playback time of the ball position and how much playback has already played are also displayed.

Playback mouse menu

You can quickly access playback options by placing the cursor on a playback image on-screen and clicking the right-button of the mouse. The playback pop-up menu appears (see Figure 13 below). The list of options available depends on the type of playback.

Figure 13: The playback pop-up menus

24-hour playback:

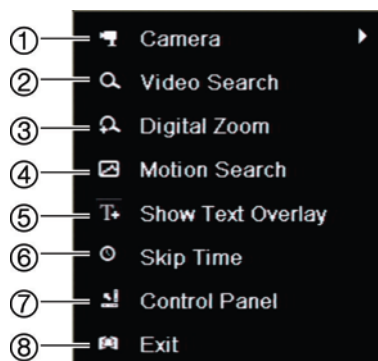

Search result playback:

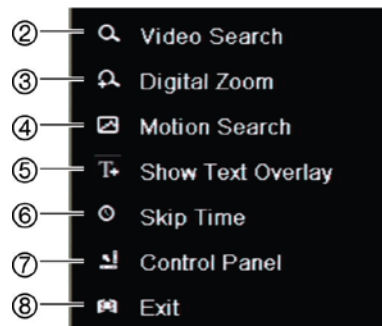



Name	Description
1. Camera	Select a camera for playback.
2. Video Search	Return to the Search window.
3. Digital Zoom	Enter the digital zoom function for the selected camera. See “Digital zoom in playback” on page 45 for more information.
4. Motion Search	Enter the motion search window. See “Search for motion events in playback” on page 47 for more information.
5. Show Text Overlay	Hide or display text overlay. This option is only available via the browser. See “Text overlay” on page 130 for more information.
6. Skip Time	Modify the playback skip time. See “Playback speed and skip time” on page 43 for more information.
7. Control Panel	Hide or display the playback control toolbar.
8. Exit	Return to live view or video search.

Instant playback

Use the live view toolbar to perform instant replay of a predefined period (default time is five minutes). This can be useful to review an event that has just happened. Only one camera at a time can be selected.



You can modify the playback period in the Instant Replay Duration menu. See page 88 for further information.

To instantly replay recorded video:

1. In live view mode, left-click the mouse on the desired camera image. The live view toolbar appears. Click the Instant Playback icon .
2. Click the Channel icon  and select the desired camera from the drop-down list. Click **OK**.

Playback starts immediately. The Instant Playback scroll bar appears under the selected camera.



3. Click **Pause**  on the toolbar to pause playback.
Click **Play**  to restart playback.
Click **Stop**  to stop playback and return to live view.

24-hour playback

Use this option to access one day of video recordings for the selected camera. Playback starts at midnight and runs for the 24-hour period. 24-hour playback is shown in full-screen view. See Figure 13 on page 41 for a description of the playback control toolbar.

• Using the mouse:

1. In live view mode right-click the mouse on the desired camera image. In the mouse toolbar, click **24-hour Playback**.

The playback screen appears. By default, the camera is in full-screen mode.

2. To select more than one camera for synchronous playback or to select playback from a different day, move the mouse to the right edge of the screen. The camera list and calendar appear. Check the desired cameras and/or another day. Up to 8 cameras can be selected.

Playback starts immediately you have selected the camera and times.

Note: A message appears if there are no recordings found during this period.

3. Use the playback control toolbar to manually control playback.
4. Click **Exit**  to return to live view.

– Or –

Right-click the mouse and click **Exit** from the mouse menu to return to the previous window.

• Using the front panel:

1. Select the camera for playback and press the **Play** button. Playback from the selected camera starts immediately.

Note: Synchronous playback is only available using the mouse. If live view was showing multiview, only the camera in the top-left channel on screen will be played back.

2. To select a different camera for playback, press the numerical button of the desired camera.
3. Press **Live** to return to live view.

Playback speed and skip time

Use the direction buttons on the front panel to modify the playback speed, and to jump forwards or backwards.

The default skip time is 30 seconds. However, you can easily change it.

To set the playback skip time:



1. In playback mode, right-click the mouse and click **Skip Time** on the pop-up menu. The Skip Time menu appears.
2. Select a skip time between 10 and 300 seconds. The default skip time is 30 seconds.

To change the playback speed:

From the front panel:

Press the left and right buttons to speed up and slow down recorded video.

From the playback window using the mouse:

Click  and  to speed up and slow down recorded video.

To skip forwards or backwards during playback:

From the front panel:

Press the up and down buttons to jump recorded video forwards and backwards by a set skip time.

From the playback window using the mouse:

Click  and  to jump recorded video forwards and backwards by a set skip time.

— Or —

Click a location on the timeline for where you want playback to start.

Playing back frame-by-frame

You can play back a selected video at different speeds. This allows you to carefully examine an event frame-by-frame as it happens.

The current frame rate is shown on the right of the playback control toolbar.

To play back frame-by-frame:

• Using a mouse:

1. In playback mode click the **Speed Down**  button in the playback control toolbar until the speed changes to single frame.
2. Click the **Pause** button to advance the video frame by frame.

• Using the front panel:

1. In playback mode move the left direction button to left to scroll down through the speed changes until single frame.
2. Press **Enter** to advance the video frame by frame.

Digital zoom in playback

You can zoom in on an image during playback to see it in greater detail. There are two ways to perform digital zoom in playback.



To digitally zoom-in during playback:

1. In playback mode, right-click the mouse and select **Digital Zoom** in the pop-up menu.
— Or —
Click the Digital Zoom icon in the playback control toolbar.
The playback control toolbar disappears. The digital zoom window appears.
2. Left-click the mouse and drag the red square in the digital zoom window to the area of interest, or move the joystick on the front panel to position the red square. The selected area is magnified.
3. Right-click the mouse to quit the digital zoom mode and return to full-screen playback mode. The playback control toolbar reappears.

Create bookmarks

You can bookmark the important scenes in a recorded file for later reference.

Bookmarks flag the start of a scene. Up to 64 bookmarks can be saved in a video file. There are two types of bookmarks:

- **Default bookmark** : All default bookmarks have the same generic name, "BOOKMARK".
- **Customized bookmark** : The bookmark is given a name for easy identification. The same name can be used for several bookmarks.

You can search both types.

To create a bookmark:

1. Open a 24-hour playback window or the playback window from a search result.
2. In the playback recording, click the timeline bar where you want the bookmark to be. The green time line jumps to this position. Click the button for the type of bookmark you want, and enter the bookmark name if required.

In the playback recording from a search, click the scroll bar where you want the bookmark to be. The scroll bar ball jumps to this position. Click the button for the type of bookmark you want, and enter the bookmark name if required. The bookmark is saved.

3. Click the bookmark management  button to see the list of bookmarks saved. The name of a bookmark can be edited. The bookmark can also be deleted.

Chapter 7

Searching files

This chapter describes how to search and playback recorded videos as well as search them by time, events, bookmarks, and snapshots.

Search video menu

You can easily search and play back recorded videos by time and date, events, bookmarks, and snapshots. Recordings from both analog and IP cameras are searched.

Figure 14: The Search menu

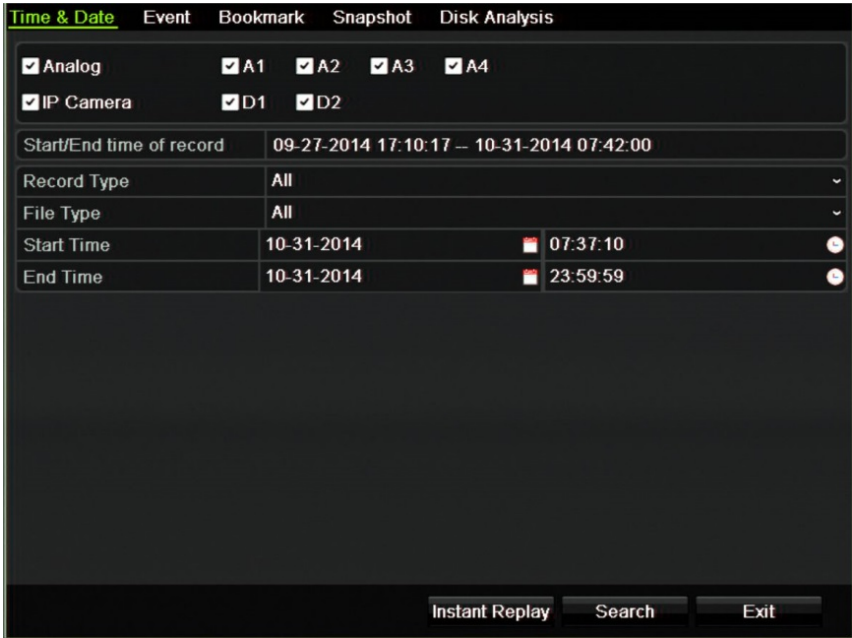

The Search window has five submenus that allow you to carry out different searches by theme:

Search type	Description
Time and date	Search all video by time and date of recording.
Event	Search only event recorded files. Files can be searched by alarm inputs, motion detection, text insertion, or intelligent alarms.
Bookmark	Search recorded files with bookmarks.
Snapshot	Search snapshots.
Disk analysis	The recorder can run a disk analysis to get a broader sense of the video data stored on the HDD. This video data can include alarms, events, video Loss, and more. Recorded video cannot be retrieved from this window.

Search results

A search will usually produce a list of files, which may extend to several pages. The files are listed by date and time. The most recent file is listed first. You can then select a file to play it back. See Figure 15 on page 47 for an example of a search.

Only one file can be played back at a time.

Figure 15: Example of a search result list

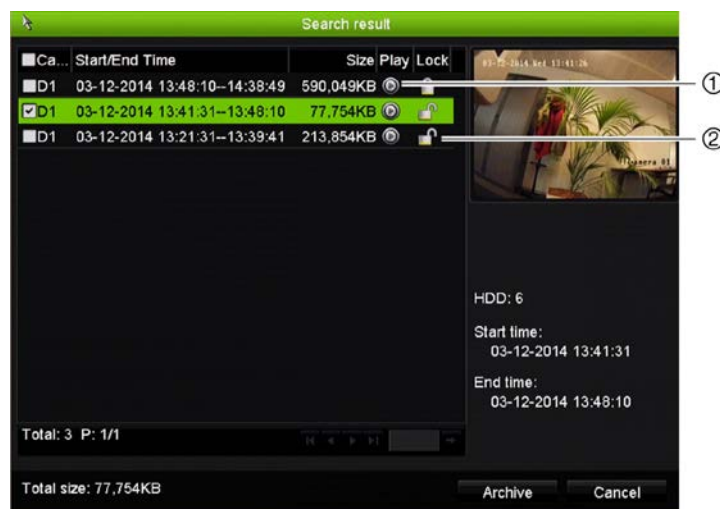

1. Click to playback the selected video.
2. Click to lock recording to prevent it from being overwritten.

Search for motion events in playback

1. In playback mode, click the 'Smart' icon . The motion search view opens.
2. In the motion search view, mark the area in which the recorder needs to search for motion. Use the motion search toolbar to select full screen (1), remove full screen selection (2), start motion search (3) and exit motion search (4).

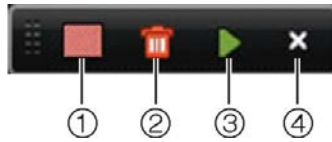

3. Click  to retrieve the motion events.

The standard playback view opens, containing all recordings for the period of time selected. Motion events are shown in blue in the time bar. Click on the time bar to skip from one motion event to the next.

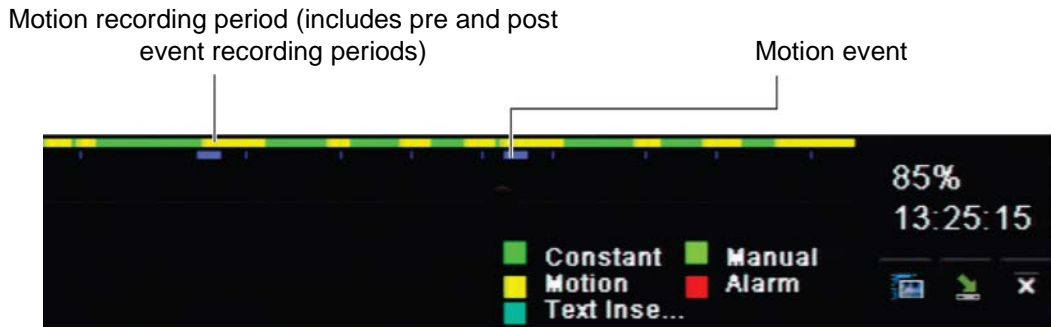

Search and play back recordings by time and video type

You can search recorded video by time and video type, such as continuous recordings, motion, alarms, and all recordings. Video can be played back simultaneously across several cameras.

To search archived video files:

1. In live view right-click the mouse on the desired video pane and select **Search Video**. The Search menu appears.
2. Select the desired cameras, record type, file type as well as start and end times of the recording.
3. Click **Search**. The list of search results appears.
4. Click  to play back the search results:

To immediately access archived footage:

1. In the Search menu, click the “Time & Date” tab.
2. Select the desired cameras, record type, file type as well as start and end times of the recording. Up to four cameras can be selected.
3. Click **Go**. The simultaneous playback of up to four cameras for the indicated time will start.

To search for motion:

1. In the “Time & Date” search menu, select the desired camera (1 camera), record type, file type as well as start and end times of the recording. Only one camera can be selected.
2. Click **Motion Search**. The motion search view opens.
3. In the motion search view, mark the area in which the recorder needs to search for motion. Use the motion search toolbar to select full screen, remove full screen selection, start motion search and exit motion search.
4. Click  to retrieve the motion events.

The standard playback view opens, containing all recordings for the period of time selected. Motion events are shown in blue in the time bar. Click on the time bar to skip from one motion event to the next.

Search and playback recordings by event

You can search recorded video by event type: motion, text insertion, intelligent alarms, and alarm input.

To play back search results:

1. In live view right-click the mouse on the desired video pane and select **Search Video**. The Search menu appears.
2. In the Search menu, click the “Event” tab.
3. Select the desired event type as well as start and end times of the recording.
4. Select the desired alarm inputs or channels.

If you selected “Intelligent Alarm” as the event type, select the required IP cameras.

5. Click **Search**. The list of search results appears.
6. Select the desired video from the list.
7. In the search results window, you can:
 - Click **Play** to playback the footage
 - Click **Archive** to archive results
 - Click **Details** to display more information about an event.

Note: You can modify the pre- and post-play periods of a recording.

Search bookmarked recordings

For information on creating bookmarks, see “Create bookmarks” on page 45.

To search for a bookmark:

1. In live view right-click the mouse on the desired video pane and select **Search Video**. The Search menu appears.
2. In the Search menu, click the “Bookmark” tab.
3. Select the desired cameras as well as start and end times of the recording to be searched. Also select the type of bookmark to be searched.

If searching for customized bookmarks, enter a keyword from the bookmark name. Click **Search**. The list of bookmarks appears.

4. Select the desired bookmark from the list.
5. Select a bookmark and do one of the following:
Click the **Edit** button to edit a bookmark’s name.
- Or -
Click the **Delete** button to delete a bookmark.
- Or -
Click the **Play** button to play back a bookmark.

Search snapshots

You can search video snapshots. See “Live view mouse menu” on page 31 on how to create snapshots.

To search for snapshots:

1. In live view right-click the mouse on the desired video pane and select **Search Video**. The Search menu appears.
2. In the Search menu, click the “Snapshot” tab.
3. Select the desired cameras as well as start and end times of the recording to be searched.
4. Click **Search**. The list of snapshots appears.
5. Select a snapshot to see it in the thumbnail window. Click its **Play**  button to see it in full-screen mode.
6. When in full-screen mode, move the cursor to the right edge of the window to see the complete list of snapshots found in the search. Click their Play buttons to see them in full-screen mode.
7. To see a slideshow of all the snapshots found, click the ► or ◀ buttons on the snapshot toolbar to sequence forwards or backwards through the shots.

Log search

You can open video footage from the results of a log search. Refer to “Search the system log” on page 118 for more information.

Disk analysis

The recorder can run a disk analysis to get a broader sense of the video data stored on the HDD. This video data can include alarms, events, video loss, and more. However, you cannot access video for playback.

Chapter 8

Archiving files

Archive recorded files on an external device such as USB flash drive, USB HDDs or a DVD burner. You must be in live view to archive video. Access to archive commands may require a password.

Before starting to archive files, ensure that you have the backup device connected to the recorder. It can be detected automatically by the recorder.

Note: The recorder supports USB DVD and USB HD on the front and back USB ports.

Archiving files

There are two ways to archive files:

Quick Archive button: Quick archive lets you archive recorded files quickly by using the Archive button on the front panel. The recorder then downloads all the recorded files on the unit to fill the available memory space on the media. This option is not available via the mouse.

Search results window: In many search results windows there is an “Archive” button. Click it to bring you to the archive window of the selected video in the search result.

Quick Archive

To archive recorded video using Quick Archive:

1. Insert the backup device into the recorder.
If using a USB memory drive, insert the device into the USB port on the front panel. If more than one media type is found, the USB device takes precedence over the others.
2. Press **Archive** on the front panel or remote control to open the quick archive window.
3. Click **Start** or press **Archive** on the front panel again. The unit starts to download all the files listed.

Note: If there is a capacity limitation on the backup device, only the most recent files will be backed up.

A message will appear to confirm when the download is complete.

Archive menu

You can insert a mini-USB hub to the USB port to attach a mouse for navigation or a USB drive for archiving. However, the unit may not support all types of USB hubs.

The Archive options available may depend on the type of backup device selected.

Figure 16: Example of an archive menu

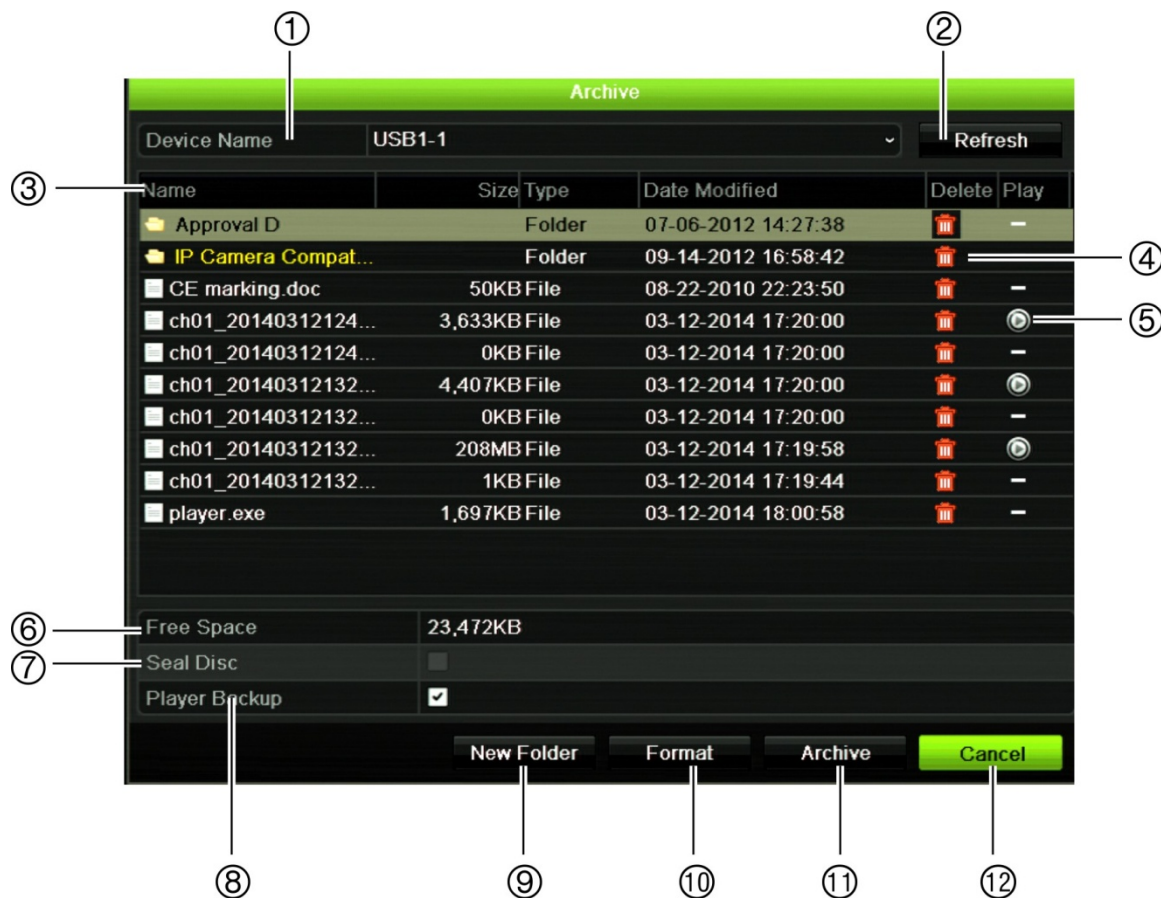

Function	Description
1. Device name	Select one of the storage media for archiving. If the backup device is not recognized: <ul style="list-style-type: none"> Click the Refresh button Reconnect device Check for compatibility from vendor
2. Refresh	Refresh the search results if any parameters have been modified.
3. Name	Files found on the backup device are listed.
4. Delete	Click to delete a selected file from the backup device.
5. Play	Click to play selected file.

Function	Description
6. Free space	Free space available on the backup device is displayed.
7. Seal disc	Select to prevent other files being recorded onto the disc.
8. Include Player	Select to automatically include the Player tool when archiving files.
9. New folder	Create a new folder on the backup device. Files from the recorder can be archived to a specific folder.
10. Format	Format the USB/eSATA drive.
11. Archive	Start downloading selected files onto the backup device.
12. Cancel	Cancel search and return to previous menu.

To export recorded files to a backup device:

1. Connect the backup device to the recorder.

If using a USB memory drive, insert the device into the USB port on the front panel. If using a digital video disk (DVD) or eSATA drive, insert the disc into the DVD drive. If both media are found in the recorder, the USB device takes precedence over the DVD.

2. In live view mode press the **Search** button on the front panel or remote control.

- Or -

Right-click the mouse and select **Advanced Search**.

The Advanced Search window appears.

3. Select the cameras and search parameters required.

4. Click **Search**. The list of results appears.

5. Select the files to export.

Note: You can click the Play button to verify that the selected files are the files to export.

6. Click **Archive**. The Archive window appears.

7. Select the storage medium to export to from the drop-down list.

8. Click **Archive** to begin the backup process.



Create and archive video clips

You can save important scenes in a recorded file for later reference by creating video clips of selected portions of the file during playback. When an intruder, for example, crosses in front of several cameras you can save the video clip of the intruder's path across these cameras in a single file.

Up to 30 video clips can be made from a recording.

Note: This feature is only available using the mouse.

To export video clips during playback:

1. Connect the backup device to the recorder.
2. Search for the required files to play back. See “Searching recorded video” on page 43.
3. Select the file or files to play back and click **Play**. Playback starts immediately.
4. Click the playback timeline where you want the video clip to start and click the **Start Clipping**  button.
5. Click the playback timeline where you want the video clip to stop and click the **End Clipping**  button.
6. Repeat for additional clips.
7. Exit playback mode. A message appears asking if you want to save the video clips.
8. Click **Yes** to archive the clips. The Archive window appears.
Click **No** to exit and return to the search results window. The clips are not saved.
9. In the Archive window select from the drop-down list the backup device to be used.
10. Click **Archive**. File downloading starts.

Note: You can create a new folder for the video clips. Press the **New Folder** button and enter the folder name.

Playing back archived files on a PC

Use the standard file player software, TruVision Player, to play back the archived video on your PC. It is downloaded automatically from the recorder when archiving files onto a backup device.

Note that in some cases a limited file player is included in the recorder. If so, when opening the file player on your PC, the software will prompt a message stating that a full version of the player is available for download from our website.

Chapter 9

Display settings

Use the Display Settings menu to modify how the camera images appear on screen.

Display settings

Use the Display Settings menu to adjust the settings related to the local monitor output of the recorder, such as selecting the main and event monitors, multiview layout, display the monitor time bar, sequence dwell time options, and enable or disable the local audio output. See Figure 17 below.

Figure 17: Display Settings window

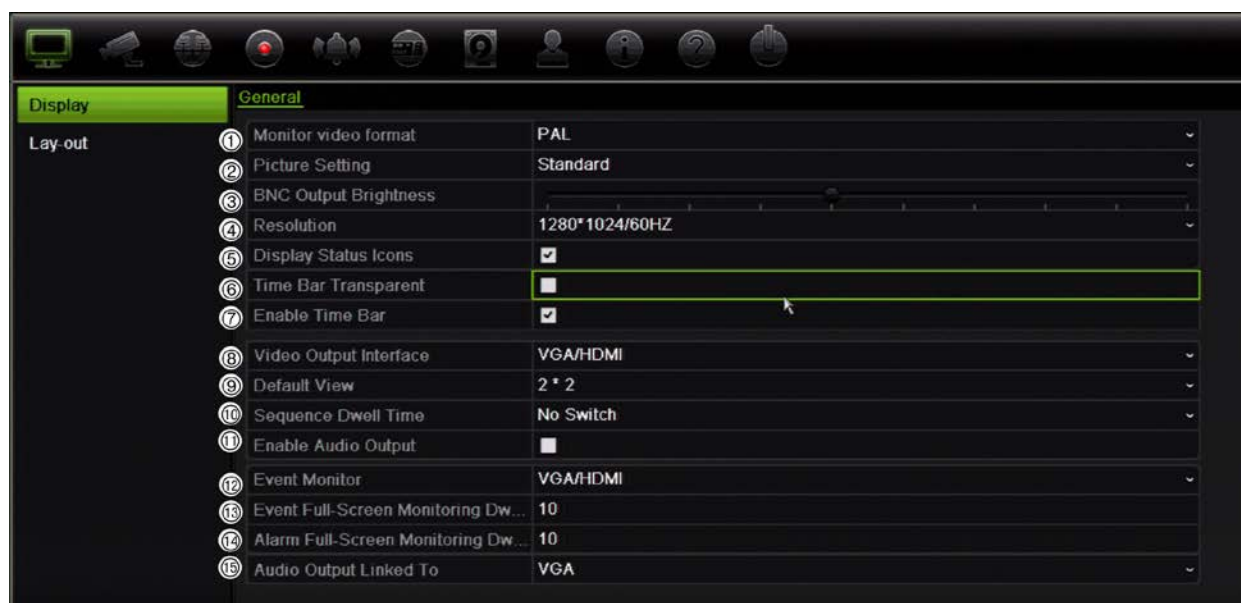

Table 10: Description of the Display setup window

Option	Description
1. Monitor Video Format	The recorder can support NTSC or PAL video output. The video standard used is auto detected but can be manually changed. Modify the video standard used to PAL or NTSC, and click Apply .

Option	Description
2. Picture Setting	Define the desired output mode. Select one of the options from the drop-down list: Standard, Bright, Soft, or Vivid, and click Apply .
3. BNC Output Brightness	Modify the video output brightness. Adjust the scroll bar point to the desired level and click Apply .
4. Resolution	Define the resolution of the selected monitor. Select one of the options from the drop-down list and click Apply . The selected resolution must be the same as that of the monitor.
5. Display Status Icons	Define whether the status icons are displayed. Default is Enable.
6. Timebar Transparent	Select the transparency of the monitor output time bar on screen relative to the background to make the time bar easier to read. Check the box to enable/disable. Default is Disable.
7. Enable Timebar	Select whether the monitor output time bar appears on screen. Check the box to enable/disable. Default is Enable.
8. Video Output Interface	Select the desired video output interface to apply: Main BNC or VGA/HDMI. Default is VGA/HDMI.
9. Default View	The factory default multiview format displays all channels (2x2 layout for the 4-channel TVR 12HD and 4x4 layout for the 8/16-channel TVR 12HD).
10. Sequence Dwell Time	Set the length of time for which a camera image is displayed on the selected monitor before moving to the next camera during sequencing. Default is off ("No Switch").
11. Enable Audio Output	Select whether to hear audio from cameras in both live and playback mode. However, in order to be able to hear audio in playback, you must enable the audio output setting. Default is Disable. Check the box to enable/disable audio output.
12. Event Monitor	Select which monitor will be the event monitor showing full screen monitoring in case of events: HDMI/VGA, or Main BNC. Default is Main analog.
13. Event Full Screen Monitoring Dwell Time	Set the length of time during which an image is displayed on the event monitor in full screen in case of an event. Default is 10 seconds.
14. Alarm Full Screen Monitoring Dwell Time	Set the length of time during which an image is displayed on the event monitor in full screen in case of an alarm. Default is 10 seconds.
15. Audio Output Linked to	Select from which monitor (Main BNC or VGA) audio can be heard.

Layout

The Layout window allows you to define the layout of each of the different views as they are shown when selecting the different live views or the sequencing order.

The cameras are sequenced in numeric order by default. You can change the order of the cameras for all monitors.

The camera order in the different views is consistent. This means that if Channel 2 is the first camera shown in the single camera view then it will also be the top left camera of the 4-channel view.

You can switch the channel of a camera with that of another camera in the system. This lets you, for example, have the images of camera 1 appear on channel 10, and the images of camera 10 appear on channel 1. This feature is useful when you want to watch the sequence of images from specific cameras so that they are next to each other on-screen.

See Figure 18 below. Each video tile displays both the order of the camera on screen and the camera number.

Figure 18: Camera layout window

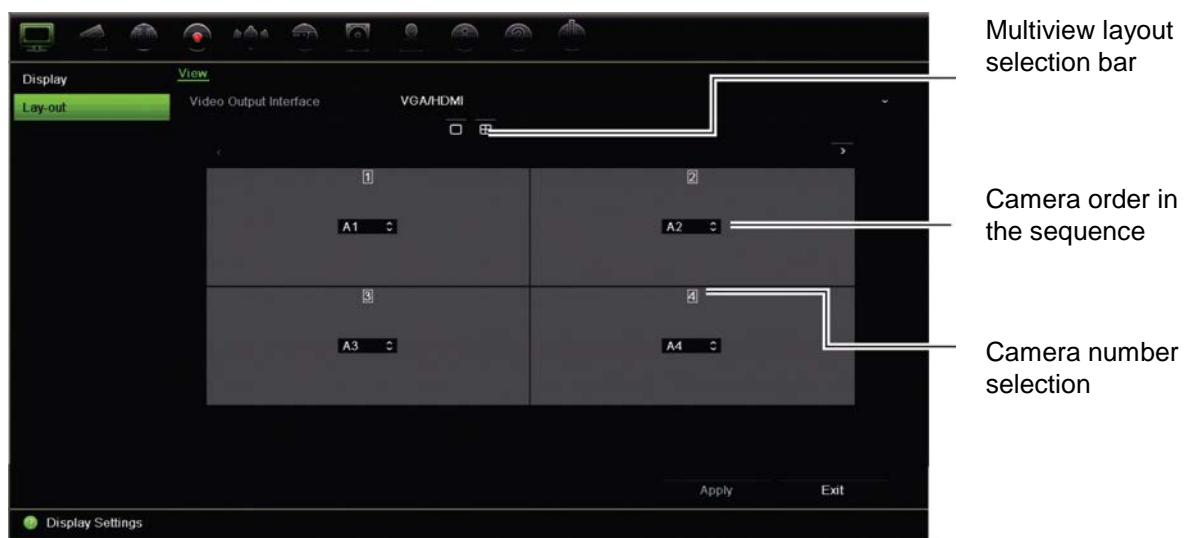

Chapter 10

Camera setup

Use the Camera Setup menu to configure analog and IP cameras. You can also configure the camera OSD, snapshots, recording settings, motion detection, privacy masking, camera tampering, PTZ configurations and V-stream settings.

Note: Not all settings are available for IP cameras. For advanced IP camera settings, please consult the IP camera web browser interface.

See Table 11 below for an overview of the maximum analog/IP camera configuration by recorder model.

Table 11: Maximum analog/IP camera configuration by recorder model

Mix of analog and IP cameras					
Up to 16 channels		Up to 8 channels		Up to 4 channels	
Analog	IP	Analog	IP	Analog	IP
16	0	8	0	4	0
15	1	7	1	3	1
14	2	6	2	2	2
13	3	5	3		
12	4	4	4		
11	5				
10	6				
9	7				
8	8				

Supported IP cameras

The recorder supports the following IP cameras:

- HD-TVI technology cameras (HD and Full HD)
- Standard analog cameras
- TruVision IP cameras at HD and full HD resolution

Analog camera setup

The recorder can support up to 16 cameras depending on the model, which can be a mix of analog and IP cameras. By default, all camera channels in the recorder are analog. You need to disable analog cameras in order to add IP cameras. However, at least half of the camera channels will always be analog.

You can quickly see an overview of all the analog cameras and their status in the **Analog Camera Overview** screen (see Figure 19 below). The number of cameras displayed depends on the recorder model. You can also select a camera to live view the image.

When an analog camera is enabled or disabled, the system must reboot for the changes to take effect.

Figure 19: Overview of analog cameras window (4-channel recorder model shown)

List of all the analog channels (number depends on recorder model).

Click to live view the selected analog camera.



Disable an analog camera in order to add an IP camera.

The last half of the analog cameras cannot be disabled.

To enable or disable an analog camera:

1. From the menu toolbar, click **Camera Setup > Analog Camera Overview**.
2. In the Status section, check the boxes of the cameras that you want to enable. Uncheck those you want to disable in order to add an IP camera.
3. Click **Apply** to save the changes.
4. A pop-up message will appear asking if you want to reboot the system. Click **Yes**.

IP camera status

The IP camera status menu allows you to add, edit and remove cameras to the recorder, as well as update the cameras' firmware.

The maximum number of IP cameras that can be connected depends on the number of analog cameras enabled. Only up to half of the recorder channels can be IP cameras.

You may need to disable an analog camera to add an IP camera.

Figure 20: IP camera window



Table 12: Description of the IP camera window

Option	Description
1. IP camera list	This shows the list of IP cameras added to the recorder. The camera information shown is: Camera No., Status, Edit, Advanced Set, Live View, Camera Name, IP Camera Address, Manage Port, Protocol, Device Model, Serial Number, and Firmware.
2. Manual Add	Add the selected cameras from the search results list to the recorder system without modifying the camera configuration.
3. Device Search/Add	Search the network for available IP cameras. Add an IP camera to the recorder system.
4. Upgrade	Upgrade IP camera software. Insert USB flash drive in the recorder and select the upgrade file. The camera will automatically reboot once the software is upgraded.
5. Delete	Delete the selected IP camera from the list.
6. Refresh	Update the information displayed on a camera in the recorder device list.

To automatically add an IP camera:

1. From the menu toolbar, click **Camera Setup > IP Camera Status**.
2. Click **Device Search/Add** to search for any supported IP cameras located in the recorder LAN.
3. Check the boxes of the cameras that you want to add to the recorder.
4. Click **Add** to add the selected cameras to the list of devices in the recorder. Click **Done** when complete in order to return to the main window.

The cameras are added to the end of the list of devices.

5. To test if a camera connection is operational, select the desired camera from the list of devices connected to the recorder and click **Live**. A pop-up window should appear showing the camera's live view.

Note: If cameras still have default settings, they might have the same IP addresses. This creates an IP conflict. Use the Edit button to assign a different IP address to each camera. Ensure that for each camera to successfully connect the cameras.

To manually add an IP camera:

1. From the menu toolbar, click **Camera Setup > IP Camera Status**.
2. Click **Manual Add**. In the pop-up window, enter the camera details such as the IP camera address/domain, protocol, management port, user name and password. Click **OK**.

The camera is added to the end of the list of devices.

Note: Only one camera can be manually added at a time.

Camera recording settings

Ensure that the HDD has been installed and initialized before configuring the recording settings. See chapter "Storage management" on page 104 for more information.

To configure recording settings:

1. From the menu toolbar, click **Camera Recording Settings**.



2. Select the camera you want to configure.
3. Configure the following recording settings (options available depend on the camera model):
 - **Stream Record Mode:** Select one of the stream types to configure the recording parameters of that record mode: Mainstream (TL-Hi) (default), Mainstream (TL-Lo), Mainstream (Event), Mainstream (Alarm), or Substream.
 - **Stream Type:** Select the type of stream to record, either video or video and audio.
 - **Resolution:** Select the resolution of the recording. Options include: 1920*1080 (1080P), 1280*720 (HD720P), 960*576 (960H), 704*576 (4CIF), 640*480 (VGA), 352*288 (CIF).
 - **Bitrate Type:** Select Variable (default) or Constant. If “Variable” is selected, the bandwidth can vary depending on video quality and the bandwidth required. If “Constant” is selected the video streaming is always at the maximum bit rate selected.
 - **Video Quality:** Select the quality at which to record. If “Constant” is selected as the bit rate type, this option is unavailable.
 If a low video quality is selected, the image quality is poorer and the bandwidth required is reduced thereby allowing recording over a longer period of time.
 - **Frame Rate:** Select the recording frame rate.
 - **Max. Bitrate mode:** Select the general (Default) or customized option.

- **Max. Bitrate (kbps):** If the customized maximum bit rate mode was selected, enter the value here. It must be between 32 and 4096 kbps. It is calculated from the frame rate and time required. Default is 1792.
- **Pre Event:** This is the time the camera starts recording before the event. Select the time in seconds from the list to start pre-recording before the event. Default is 5 seconds.

The maximum pre-recording times available depend on the constant bit rate. See “Maximum storage times” in the appendix.

- **Post Event:** This is the time the camera continues to record after the event. Select the time in seconds from the list to stop post-recording after the event. Default is 5 seconds.
- **Auto Delete (day):** Select the number of days after which recorded video from the specified camera is permanently deleted from the HDD. A “day” is defined as the 24-hour period from when the auto delete mode (ADM) was set.

The maximum number of days that can be set is 9999. However, the actual number of days permitted depends on the HDD capacity. If the value is set to ‘0’, the option is disabled. Default is disable.

- **Record Audio:** Enable to record sound with the images. Default is enable.
4. Click **Apply** to save the settings.
 5. If you want to save these parameters to another camera, click **Copy** and select the camera in the pop-up window that appears. Click **OK** and return to the main window.
 6. Click **Apply** to save the settings.

Snapshots

You can define the image quality and resolution of snapshots for each camera. Snapshots can be taken at any time during live view or playback, or can be created when an alarm occurs and sent by email or sent to an FTP server.

To configure snapshots:

1. From the menu toolbar, click **Camera Setup > Snapshots**.
2. Select the desired camera.
3. Select the snapshot resolution from the drop-down list.

Select QCIF, CIF, 4CIF, or Maximum. Maximum is the maximum available resolution from the camera. For analog cameras, this is the maximum available resolution in the camera. For IP cameras, this is the resolution being recorded.

4. Select the snapshot quality from the drop-down list (low, medium or high).
5. Click **Apply** to save the settings.

6. To copy the settings to other cameras, click **Copy** and select the desired cameras. Click **OK**.
7. Click **Exit** to return to live view.

Camera OSD

The recorder lets you configure which information is displayed on-screen for each individual camera.

The on-screen display (OSD) settings appear in live view mode and include the camera name, time and date. They are part of the image and are therefore also recorded.

To configure the OSD settings:

1. From the menu toolbar, click **Camera Setup > Camera OSD**.



2. Enter a name for the camera (1), if required. The name can have up to 32 alphanumeric characters.
3. Check the **Display Name** (2), **Display Date** (3), and **Display Day** (4) boxes to display the camera name, date, and week.
4. Select a date format and a time format (5).
5. Select how you want the camera information displayed (6).

Select one of the options from the drop-down list. Default is non-transparent/non-flashing.

- Transparent & Flashing
- Transparent & Not flashing
- Non-transparent & Flashing
- Non-transparent & Not flashing

6. To change the size of the OSD font displayed, select one of the options from **OSD Font (7)**.
7. There are two colored text boxes in the camera view window; one for the camera name (red box) and the other for the date/time (yellow box). Using the mouse, click and drag a text box to the display position (8).
8. To copy the settings to other cameras, click **Copy** and select the desired cameras. Click **OK**.
9. Click **Apply** to save the settings and then click **Exit** to return to live view.

Image settings

The Image tab allows you to adjust image settings for each individual camera channel. You may need to adjust the camera image depending on the location background in order to get the best image quality.

The system has image settings for frequently encountered lighting conditions; Standard, Indoor, Dim Light and Outdoor. You can also manually adjust the brightness, contrast, saturation, hue and saturation values.

You can modify the digital noise reduction (DNR) value to improve image quality. This function removes image noise from a video signal, which can be more pronounced in low light conditions.

Note: These options can also be modified from the image settings button on the live view toolbar (see “Live view toolbar” on page 33).

To adjust display settings:

1. From the menu toolbar, click **Camera Setup > Image**.
2. Select the camera for which to adjust the video image settings (Standard, Indoor, Dim Light, or Outdoor).
3. Adjust the brightness, contrast, saturation, hue, sharpness and digital noise reduction values by dragging each scroll bar.
Click the **Default** button to return image setting values to the default position.
4. Click **Apply** to save the settings and then click **Exit** to return to live view.

Motion detection

The motion detection menu allows you to enable or disable motion detection for each camera, as well as create motion grids, set the sensitivity of the motion detection and link motion detection to a specific action.

To set up motion detection:

1. From the menu toolbar, click **Camera Setup > Motion**.

Areas covered by the red grid are sensitive to motion detection.

2. Select the camera to detect motion. Each camera must be set up individually.
3. Check **Enable Motion Detection**. If this is not enabled, motion will not be recorded.
4. Select the areas on-screen to be sensitive to motion.

Click and drag the mouse cursor across the window to deselect areas sensitive to motion detection.

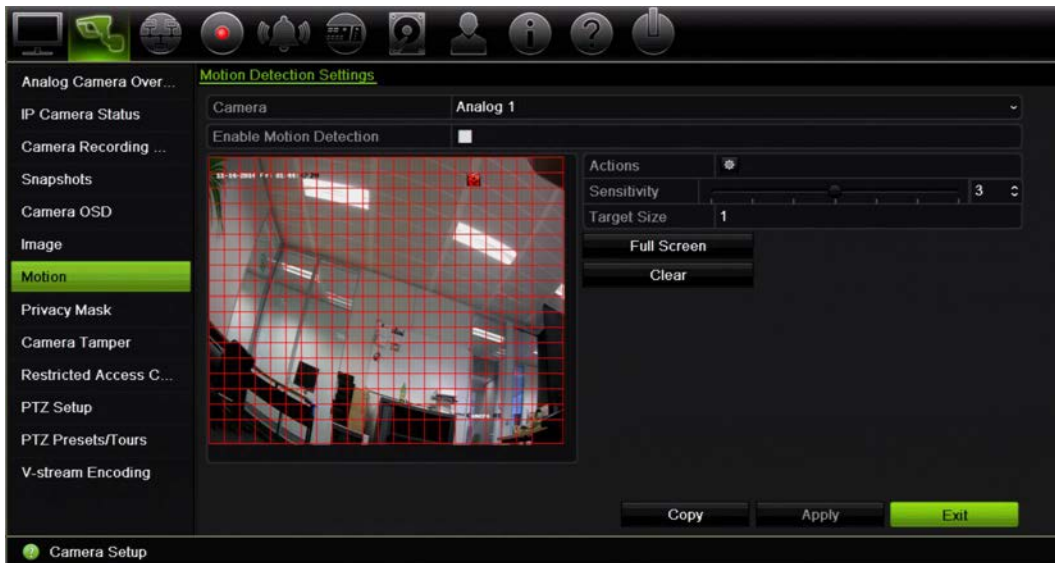

Click **Full Screen** to activate the whole screen or **Clear** to clear the screen.

5. Set the sensitivity level.

Drag the Sensitivity scroll bar to the desired sensitivity level. Default is 3.

6. Specify the target size.

In the Target Size option, specify how many grid squares must be activated before motion is detected. Enter a value between 0 and 255 squares. Default is 1 square.

7. Select the cameras that will start the motion recording schedule once motion is detected.

Click **Actions**. The Actions window appears. Click the **Trigger Channel** tab and select the cameras that will record when a motion alarm is triggered. Click **Apply** to save the settings.

8. Select the arming schedules for motion detection.

In the Actions window, click the **Arming Schedule** tab and select the day of the week and the time periods during the day when motion can be recorded. You can schedule up to eight time periods in a day. Default is 24 hours.

Click **Apply** to save the settings. Click **Copy** to copy the settings to other days of the week.

Note: Time periods defined cannot overlap.

9. Link the corresponding action to motion detection.

In the Actions window, click the **Actions** tab to define the method by which you want the recorder to notify you of the alarm (see page 93 for the list of alarm notification types available). “Notify Alarm Host” is the default selection. More than one option can be selected.

Click **Apply** to save settings.

10. Click **OK** to return to the motion detection settings window.

11. Click **Exit** to return to live view.

Privacy mask

You can define an area on screen to remain hidden from view and recording. For example, you can choose to block the view of a camera when overlooking residential premises. This hidden area is referred to as privacy masking. Privacy masking cannot be viewed in live view or recorded mode, and appears as a black area on the video image.

Up to four privacy masks can be defined for one analog camera. For IP cameras, the amount of privacy masks is determined by the amount supported by the camera.

To setup a privacy mask:

1. From the menu toolbar, click **Camera Setup > Privacy Mask**.
2. Select the camera for which to set up privacy masking.
3. Check the **Enable Privacy Mask** box to enable the feature.
4. Set up the mask area. Up to four areas can be set.

Using the mouse, click and drag a privacy-mask box in the camera view window over the desired area. You can set up to four areas for privacy masking. Masked areas are dimmed and outlined in four different colors. Click **Apply** to save settings.



To delete a mask, check the desired mask and click **Clear** for that color mask.

5. To copy the settings to other cameras, click **Copy** and select the desired cameras. Click **OK**.

- Click **Apply** to save the settings and then click **Exit** to return to live view.

Camera tamper

You can setup the recorder to alert you when the camera view has changed such as when someone has deliberately blocked the camera view by spraying paint on the lens or by moving the camera. Tampering detection only applies when the whole image is covered and all light is blocked. You cannot select a specific area of the camera screen to detect tampering.

Note: It is strongly recommended not to configure for video tampering when using PTZ dome cameras.

To set up video tampering detection:

- From the menu toolbar, click **Camera Setup > Camera Tamper**.
- Select a camera to configure for video loss detection.
- Check the **Enable Tamper-proof** box to enable the feature.
- Select the tamper detection sensitivity level by clicking the sensitivity scroll bar. Higher sensitivity is to the right of the bar.
- Select the recording schedules for the tamper.

Click **Actions** and then select the **Arming Schedule** tab to select the day of the week and the time periods during the day when motion can be recorded. You can schedule up to eight time periods in a day. Default is 24 hours.

Click **Apply** to save the settings. Click **Copy** to copy the settings to other days of the week and holiday period.

Note: The time periods defined cannot overlap.

- Select the response method to an external alarm.

Click **Actions** and then select the **Actions** tab to select the method by which you want the recorder to notify you of the alarm: Full-screen monitoring, Enable alarm audio, Notify alarm host, Send email, and Trigger alarm output. See page 93 for the list of alarm notification types.

Click **Apply** to save settings and then **OK** to return to the main window.

- Click **Exit** to return to live view.

Restricted access camera

Restricted access cameras are cameras that are only visible to specific users.

There may be occasions when you want to control who can see a camera image on a local monitor, such as if there is a camera located in a changing room. The recorder

lets you select which camera (or cameras) is not displayed on the local monitor unless the user is logged in and has permission to view the camera images. A restricted access camera is not displayed on screen when no user is logged in. Instead a person walking by sees a black screen. See Figure 21 below.

Figure 21: Example of a restricted access camera image



To set up a camera for a restricted access view:

1. From the menu toolbar, click **Camera Setup > Restricted Access Camera**.
2. Check which analog camera or cameras you want to have restricted access and click **Apply**.
3. Click **Exit** to return to live view.

Configure PTZ settings

Use the **PTZ Setup** menu to configure only analog PTZ dome cameras. Each analog camera must be set up individually. The cameras must be configured before they can be used.

Ensure that the PTZ dome cameras are correctly connected to the RS-485 port on the back panel.

Note: If a camera does not work correctly after configuring the recorder, check the parameters entered.

To configure PTZ dome camera settings:

1. Click the **PTZ Control** icon on the live view toolbar.
– Or –
From the menu toolbar, click **Camera Setup > PTZ Setup**.
2. Select the camera, baud rate, data bit, stop bit, parity, flow control, PTZ protocol and address for the camera. See Appendix H “Default menu settings” on page 154 for the default values.

Note: It is important to ensure that the settings correspond with those used in the PTZ camera.

3. Click **Copy** to copy the settings to another camera, if required, and select the cameras.
4. Click **Apply** to save the settings and then click **Exit** to return to live view.

PTZ presets and tours

Presets are previously defined locations of an analog PTZ dome camera. It allows you to quickly move the PTZ dome camera to a desired position. They are configured and modified from the Camera Setup > PTZ Presets/Tours window (see Figure 22 below).

Tours are series of presets. Shadow tours allow you to record the manual movement of a PTZ and follow the same tour at a later date.









Note: The PTZ dome camera used must be able to support a preset command. See Appendix G “Supported PTZ commands” on page 152 for the complete list of PTZ commands available by camera protocol.

Figure 22: PTZ configuration window



Table 13: Description of the PTZ configuration window

Name	Description
1. Save preset	Saves preset.
2. Call preset	Calls up pre-existing preset.
3. Shadow tour toolbar	 Starts recording the shadow tour.

Name	Description
	 Saves the shadow tour.
	 Starts the selected shadow tour.
	 Deletes the selected shadow tour.
4. Preset tour toolbar	 Adds a step to a selected preset tour.
	 Starts the selected preset tour.
	 Stops the selected preset tour.
	 Deletes all the preset tour steps.
	 Scroll up the list.
	 Scroll down the list.

To set up a preset:

1. From the menu toolbar, click **Camera Setup > PTZ Preset/Tours**.
2. Use the directional, zoom, focus and iris buttons to position the analog camera in the desired preset location.
3. Check **Save Preset** and enter a preset number. The preset is enabled and stored in the camera.

If the desired preset number is larger than the 17 numbers listed, click [...]. The Preset window appears. Select a preset number from the dropdown list and click the **OK** button to save changes.

Note: Presets can be overwritten.

4. Click **Exit** to return to live view.

To call up a preset:

1. From the menu toolbar, click **Camera Setup > PTZ Preset/Tours**.
2. Check **Call Preset** and enter the preset number to call up. The camera immediately moves to that preset position.
3. Click **Exit** to return to live view.

To delete a preset:

1. From the menu toolbar, click **Camera Setup > PTZ Preset/Tours**.
2. From the preset list, select a preset number, and click  to delete the selected the preset.
3. Click **Exit** to return to live view.

To call up a preset tour:

1. From the menu toolbar, click **Camera Setup > PTZ Preset/Tours**.
2. Check **Call Preset** and enter the preset number to call up. The camera immediately moves to that preset position.
3. Click **Exit** to return to live view.

To set up a preset tour:

1. From the menu toolbar, click **Camera Setup > PTZ Preset/Tours**.
2. Select the preset tour number.
3. In the preset tour toolbar, click  to add a step to the preset tour. The Step window appears. Select the preset number, dwell time and speed of the step. Click **OK** to save the settings.



Note: A preset tour should have at least two presets.

4. Repeat step 3 to configure other steps in the preset tour.



5. In the preset tour toolbar, click  to call up the preset tour.
6. Click **Exit** to return to live view.

To call up a preset tour:

1. Click the **PTZ Settings** icon on the menu toolbar and select **More Settings**.
2. Select the desired preset tour from the list and click  to start the tour. Click  to stop the preset tour.
3. Click **Back** to return to live view.

To delete a preset tour:



1. From the menu toolbar, click **Camera Setup > PTZ Preset/Tours**.
2. From the preset tour list, select a tour number and click  to delete the selected the preset tour.

– Or –

In the preset tour toolbar, click  to delete all the preset tours.

3. Click **Exit** to return to live view.



To set up a shadow tour:

1. From the menu toolbar, click **Camera Setup > PTZ Preset/Tours**.
2. Select the shadow tour from the drop-down list.
3. To record a new shadow tour, click  and use the directional buttons on the PTZ control panel to move the camera along the desired path.
4. Click  to save the shadow tour.

Note: The shadow tour can be overwritten.

5. Click **Exit** to return to live view.

To call up a shadow tour:

1. From the menu toolbar, click **Camera Setup > PTZ Preset/tours**.
2. Select the shadow tour from the list and click  to start the tour. Click  to stop the shadow tour.
3. Click **Exit** to return to live view.

V-stream encoding

The V-stream shows all camera channels within one camera tile. V-stream is only available for remote use with the browser interface, mobile application, TruVision Navigator or third party software implementation.

This feature is particularly useful if you have limited bandwidth available on a remote location but still want to be able to view all camera tiles at once.

Note: It is not recommended to use the V-stream feature when a CVBS monitor is used as a main monitor because the CVBS main monitor and the V-stream use the same output.

To enable V-streaming:

1. Click the **Display Settings > V-stream Encoding**.
2. Check **Enable V-stream Encoding**.
3. Select the desired settings for frame rate and maximum bit rate (Kbps).
4. Click **Apply** to save the settings and **Exit** to return to live view.

To configure V-streaming:

The V-stream shows video on the recorder's BNC output.

1. Click the **Display Settings > Display > Video Output Interface** and select **Main BNC**.
2. Under **Default View**, select the desired view format.

3. Under **Sequence Dwell Time**, select the desired camera sequence mode.

Note: Sequencing can only be done in single-view display mode.

4. Click the **Display Settings > Layout > Video Output Interface** and select **Main BNC**.
5. Select the desired sequence order of the cameras.
6. Click **Apply** to save the settings and **Exit** to return to live view.

Chapter 11

Network settings

The Network settings menu allows you to manage all network related aspects of the recorder including general network settings, DDNS, NTP synchronization, email setup and FTP server setup.

Additionally, the Net Detect and Network statistics menus provide you with a useful and efficient tool to analyze the behavior of the recorder on the network.

You must correctly configure your recorder's network settings before using it over the network in order to:

- Connect IP cameras to it
- Connect to the recorder over the LAN
- Connect to the recorder over the internet

The recorder must have access to the internet when configuring the network settings.

Network settings

Note: As every network configuration may differ, please contact your Network Administrator or ISP to see if your recorder requires specific IP addresses or port numbers.

To configure general network settings:

1. From the menu toolbar, click **Network Settings > Network Settings**.



2. Enter the required settings:

Option	Description
1. NIC Type	<p>Network interface card (NIC) is a device used to connect the recorder to a network. Select the NIC type used from the drop-down list.</p> <p>Default value is 10/100M self-adaptive for the 4 channel recorder and 10/100/1000M self-adaptive for the 8 or 16 channel recorders.</p>
2. Enable DHCP	<p>DHCP (Dynamic Host Configuration Protocol) is a protocol for assigning an IP address dynamically to a device each time it connects to a network.</p> <p>Check this box if you have a DHCP server running and want your recorder to automatically obtain an IP address and other network settings from that server. The DHCP server is typically available in your router.</p> <p>Default value is Disable.</p>
3. IPv4 Address	<p>Enter the IP address for the recorder.</p> <p>Default value is 192.168.1.82.</p>
4. IPv4 Subnet Mask	<p>Enter the subnet mask for your network so the recorder will be recognized within the network.</p> <p>Default value is 255.255.255.0.</p>
5. IPv4 Default Gateway	<p>Enter the IP address of your network gateway so the recorder will be recognized within the network. This is typically the IP address of your router. Consult your router user manual or contact your ISP to get the required information on your gateway.</p> <p>Default value is 192.168.1.1.</p>
6. IPv6 Address 1	<p>Enter the IPv6 address for the recorder. This is the IP address of the local network to which the recorder is connected.</p> <p>Default value is fe80::240:3dff:fe7e:926f/64</p>
7. IPv6 Address 2	<p>When the recorder is connected to an external network (such as the internet), the second IPv6 address is automatically assigned.</p>

Option	Description
8. IPv6 Default Gateway	Enter the IPv6 address of your network gateway so the recorder will be recognized within the network. This is typically the IP address of your router.
9. MAC Address	Displays the MAC address. The MAC address is a unique identifier of your recorder and it can not be changed.
10. MTU (bytes)	Enter a value between 500 and 9676. Default is 1500.
11. Preferred DNS Server	Enter the preferred domain name server to use with the recorder. It must match the DNS server information of your router. Check your router's browser interface or contact your ISP for the information.
12. Alternate DNS Server	Enter the alternate domain name server to use with the recorder. It must match the DNS server information of your router. Check your router's browser interface or contact your ISP for the information.
13. Server Port	Use the server port for remote client software access. The port range is between 1024 and 65535. Enter the server port value. The default value is 8000.
14. HTTP Port	Use the HTTP port for remote internet browser access. Enter the HTTP port value, which can be any port number that is not occupied. The default value is 80.
15. Multicast IP	Enter a D-class IP address between 224.0.0.0 to 239.255.255.255. Only specify this option if you are using the multicast function. Some routers prohibit the use of multicast function in case of a network storm.
16. RTSP Service Port	The RTSP (Real Time Streaming Protocol) is a network control protocol designed for use in entertainment and communications systems to control streaming media servers. Enter the RTSP port value, which can be between 1 to 65535. The default value is 554.
17. Enable Telnet	For Technical Support purposes only. For security reasons, the Telnet port is disabled by default.
18. Total Bandwidth Limit (Kbps)	The total outgoing bandwidth limit is a threshold you can set to limit the amount of outgoing bandwidth that is being handled by the recorder.

19. Click **Apply** to save the settings and **Exit** to return to live view.

PPPoE settings

Although not usually used, you can connect the recorder directly to a DSL modem. To do this, you need to select the PPPoE option in the network settings. Contact your ISP to get the user name and password.

To configure PPPoE settings:

1. From the menu toolbar, click **Network Settings > PPPoE**.
2. Check the enable PPPoE box.
3. Enter your user name and password and confirm the password.

4. Click **Apply** and manually reboot the recorder to save the settings.

DDNS settings

DDNS servers allow you to connect to your recorder using a fixed address. This fixed address needs to be registered with a DNS service. The DDNS setup menu allows you to enable or disable DDNS and to configure it using ezDDNS, No-IP or DynDNS.

Note: Some service providers block the default RTSP streaming port 554 used for video streaming, so if you are not receiving video images over the internet, you may need to change it to another value. See Appendix C “Port forwarding information” on page 137 for more information. See “Port forwarding information” in the appendix for more information.

There are three ways to set up a DDNS account:

- **ezDDNS:** A free-of-charge service included with your recorder and fully managed within the recorder interface
- **DynDNS:** A third-party service where users need to apply for a DynDNS account on the Dyn.com website.
- **No-IP:** A third-party service where users need to apply for a no-IP account on the no-ip.com website

Figure 23: ezDDNS setup window

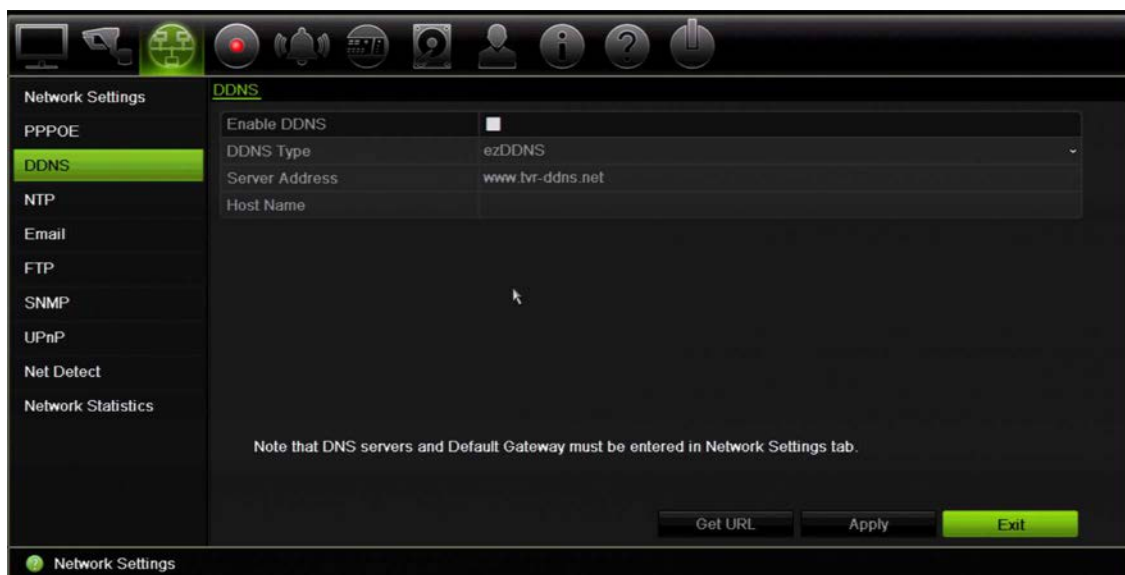

Note: You cannot have two recorders with the same host name.

To set up DDNS:

1. From the menu toolbar, click **Network Settings > DDNS**.
2. Check the **Enable DDNS** box to enable this feature.

3. Select one of the DDNS types listed:

ezDDNS: Click the **Get URL** button. The URL address to access the unit is displayed. If no host name is specified, the DDNS will allocate one automatically.

The maximum length for the host name field is 64 characters. This limit does not include tvn-ddns.net. An example of a host name could be *max64chars.tvr-ddns.net*.

- Or -

DynDNS: Select **DynDNS** and enter the server address for DynDNS. In the recorder domain name field, enter the domain name obtained from the DynDNS web site. Then enter your user name and password registered in the DynDNS network.

For example:

Server address: members.dyndns.org

Domain: mycompanydvr.dyndns.org

User name: myname

Password: mypassword

- Or -

NO-IP: Enter server address (for example, dynupdate.no-ip.com). In the host name field, enter the host obtained from the NO-IP web site. Then enter the user name and password that are registered with the No-IP network.

4. Ask your ISP service provider for your DNS server address or look it up in the browser interface settings of your router.

Go to **Network Settings** and enter the preferred and alternate DNS server addresses as well as the default gateway address.

5. Click **Apply** to save the settings and click **Exit** to return to live view.

NTP server settings

A Network Time Protocol (NTP) server can also be configured on your recorder to keep the date and time current and accurate.

Note: If the device is connected to a public network, you should use a NTP server that has a time synchronization function, such as the server at the National Time Center (IP Address: 210.72.145.44) or europe.ntp.pool.org. If the device is setup in a more customized network, NTP software can be used to establish a NTP server used for time synchronization.

To set up an NTP server:

1. From the menu toolbar, click **Network Settings > NTP**.
2. Check the NTP box to enable feature. It is disabled by default.

3. Enter the NTP settings:
 - **Interval (min):** Time in minutes to synchronize with the NTP server. The value can be between 1 and 10080 minutes. Default is 60 minutes.
 - **NTP Server:** IP address of the NTP server.
 - **NTP Port:** Port of the NTP server.
4. Click **Apply** to save the settings and click **Exit** to return to live view.

E-mail settings

The recorder can send email notifications of alarms or notifications through the network.

Note: Ensure that the DNS address has been set up correctly beforehand.

To configure email settings:

1. From the menu toolbar, click **Network Settings > Email**.
2. Enter the required settings.

Option	Description
Enable Server Authentication	Check the box if your mail server requires authentication and enter the login user name and password.
User Name	If the mail server requires authentication, enter the login user name.
Password	If the mail server requires authentication, enter the login password.
SMTP Server	Enter the SMTP server's IP address.
SMTP Port	Enter the SMTP port. The default TCP/IP port for SMTP is 25.
Enable SSL	Check the box to enable SSL if it is required by the SMTP server. This feature is optional.
Sender	Enter the name of the sender of the email.
Sender's Address	Enter the sender's email address.
Select Receivers	Select an email recipient. Up to three receivers can be selected.
Receiver Name	Enter the name of the receiver of the email.
Receiver's Address	Enter the email address of the receiver.
Include Snapshot	Check the Attach JPEG File box if you want to send an email with attached alarm images.
Interval	Select an interval range in the Interval box. The interval range represents the time range in between the alarm images being sent. For example, if you set the interval range at two seconds, the second alarm image will be sent two seconds after the first alarm image

3. Click **Test** to the test email settings.

Note: We recommend that you test the email settings after entering values in the email window.

4. Click **Apply** to save the settings and click **Exit** to return to live view.

Note: We recommend that you test the email settings after entering values in the Email window.

Configure an FTP server to store snapshots

You can upload your snapshots to an FTP server for storage.

Note: It is not possible to stream video to an FTP site.

To configure the FTP server settings:

1. From the menu toolbar, click **Network Settings > FTP**.
2. Check the **Enable FTP** box.
3. Enter the FTP server information.
4. Select the directory to use (root, parent, or secondary). If Parent or Secondary were selected, select the desired options for them.
5. Click **Apply** to save the settings and click **Exit** to return to live view.

SNMP settings

SNMP is a protocol for managing devices on networks. When you enable SNMP in the menu, network management systems can retrieve recorder status information from the recorder via SNMP.

When you set the trap address and trap port in the recorder menu to the network management system's IP address and port number, and set up the network management system as trap receiver, trap notifications (such as startup) are sent from the recorder to the network management system.

Before configuring this function, you must first install the SNMP software.

To configure SNMP protocol settings:

1. From the menu toolbar, click **Network Settings > SNMP**.
2. Check the **Enable SNMP** box.
3. Enter the required settings.
4. Click **Apply** to save the settings and click **Exit** to return to live view.

UPnP settings

The recorder supports UPnP (Universal Plug and Play). This feature lets the recorder automatically configure its own port forwarding, if this feature is also enabled in the router.

You can select one of two methods to set up UPnP:

Automatic mapped type: The recorder automatically uses the free ports available that were set up in the Network Settings menu.

Manual mapped type: You enter the particular external port settings and IP addresses required to connect to the desired router (see Figure 24 below).

Figure 24: UPnP auto configuration screen

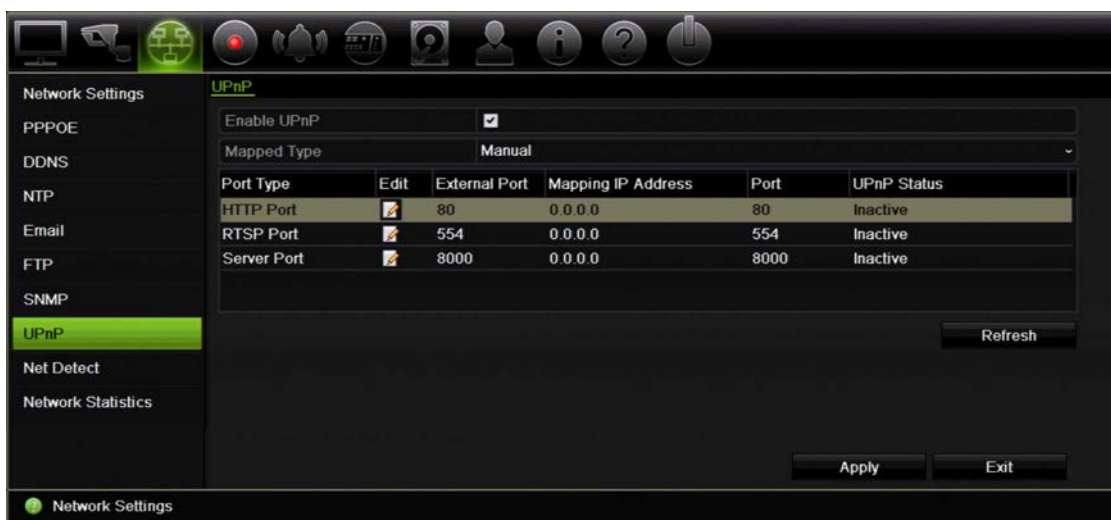

To enable UPnP:

1. Connect the recorder to the router.

Note: The router must support UPnP and this option must be enabled.

2. From the menu toolbar, click **Network Settings > UPnP**.
3. Check the **Enable UPnP** box.
4. From **Mapped Type**, select Auto or Manual.

If **Manual** is selected, enter the external ports and IP addresses required. Click the **Edit** icon to change the values.

5. Click **Apply** to save the settings and click **Exit** to return to live view.

Network status

You can easily check network traffic in order to obtain information about the recorder such as its linking status, MAC address, MTU, sending/receiving rate, and NIC type.

The Network Detection window shows the network traffic between the recorder and your local network. However, the traffic between the plug and play cameras and the TVR 12 is not shown.

You can also check the network connection status by testing its delay and packet loss.

To check network traffic:

1. From the menu toolbar, click **Network Settings > Net Detect**. The Traffic window appears. The information displayed is refreshed once a second.



To check network delay and packet loss:

1. From the menu toolbar, click **Network Settings > Net Detect**.
2. Under the section “Network Delay, Packet Loss Test”, select the NIC to use and enter the destination address. Click **Test**.

The test result appears in a pop-up window.

3. If you need to check the current network parameters, click the **Network** button to get an overview. The current values for NIC type, DHCP, IPv4 address, IPv4 subnet mask, IPv4 default gateway are shown as well as the preferred DNS server and alternate DNS server if used.

The **NIC Type** and **Enable DHCP** options can be changed. Click **Apply** to save any changes made and then click **OK** to return to the main window.

4. Click **Exit** to return to live view.

To check network status:

1. When all the network parameters have been set, click the **Status** button to confirm that all parameters are operating correctly.

Export network packet data

When the recorder is connected to a network, you can export the captured data packet to a USB-flash drive, SATA/eSATA CD-RW and other local backup devices.

To export network packet data:

1. From the menu toolbar, click **Network Settings > Net Detect**.
2. Under the section “Network Packet Archive”, click **Refresh** to get a list of the local backup devices available. Select one from the list.
3. Click **Export**. Up to 1M of data can be exported at a time.
4. Click **Exit** to return to live view.

Network statistics

You can easily check the bandwidth that is being used by remote live view and playback.

To check network statistics:

1. From the menu toolbar, click **Network Settings > Net Stat..**
2. The latest information is displayed on the bandwidth used by remote live view and playback as well by Net Receive Idle and Net Send Idle. Click **Refresh** to update the information.
3. Click **Exit** to return to live view.

Chapter 12

Recording

Use the Recording menu to define the camera recording schedules, modify the instant playback duration, and to select the cameras for manual recording.

Recording schedule

Defining a recording schedule lets you specify when the recorder records video and which pre-defined settings are used. Each camera can be configured to have its own recording schedule.

The schedules are visually presented on a map for easy reference. See Figure 25 below for a description of the recording schedule window.

Figure 25: Description of the recording schedule window



1. **Camera.** Select a camera.
2. **Schedule time.** Represents the 24-hour cycle during which a schedule is selected.
3. **Schedule map.** There are eight days to select: Sunday (Sun), Monday (Mon), Tuesday (Tue), Wednesday (Wed), Thursday (Thu), Friday (Fri), Saturday (Sat), and and Holiday (if enabled)..
4. **Recording type.** There are five types of recording to select, which are color-coded:

- TL Time lapse (Green squares): Record of a specific day. Each green square in the timeline represents an hour in the 24-hour period.
 - TL-Hi (Dark green): High quality time lapse. Records high quality video.
 - TL-Lo (Bright green): Low quality time lapse. Records low quality video. This could be used, for example, for night recordings when few events or alarms are expected. Saving the video in low quality helps save resources on the HDD.
 - Event (Yellow): Records only events, such as motion detection and POS/ATM text insertion.
 - Alarm (Red): Records only alarms.
 - None (Grey): No recording during this period.
5. **Edit button.** Click to modify schedules and to copy schedules to other days of the week.
 6. **Timeline.** There is a 24-hour time line for each day. Up to eight recording periods can be scheduled during the 24-hour period.
 7. **Copy button.** Click to copy schedules between cameras.

Define a schedule from the recording schedule window

To set up a daily recording schedule:

1. Select a camera.
2. Check the **Enable Recording** box to indicate that video from this camera is to be recorded.
3. Click a record type in the legend to activate that record type. The cursor changes to a pen.
4. Drag the pen cursor across desired hours and days in the schedule overview to mark those times with that specific record mode. To mark areas with a different record type, click on a different record type to activate it.

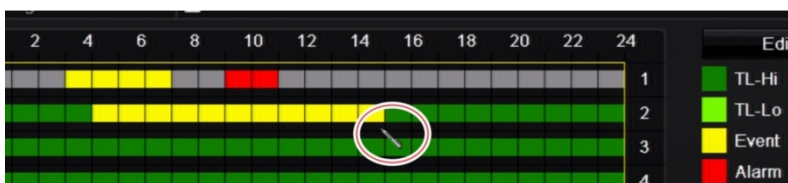

5. Click **Apply** to save the settings and **Exit** to return live view.

Define a schedule from the Edit menu

To set up a daily recording schedule:

1. From the menu toolbar, click **Recording > Recording Schedule**.
2. Select a camera.
3. Check the **Enable Recording** box.
4. Click **Edit**. The following window is displayed:

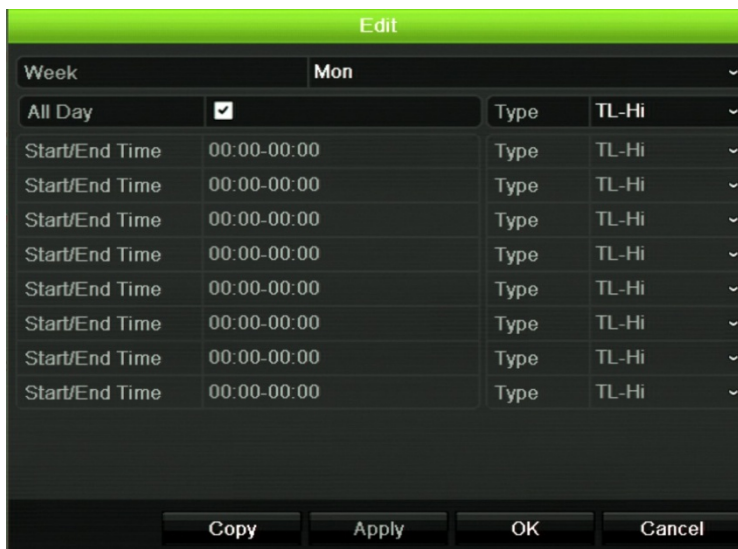

5. Select the day of the week (1) for which you want to set up the schedule.
You can define a different schedule for each day of the week.
6. Set the start and end time for recording.
Define a time period by entering a start (left column) and end (right column) time. You can schedule up to eight time periods. Click All Day to record all day.
Note: Time periods defined cannot overlap.
7. Select a recording type.
This setting instructs the recorder to begin recording when an alarm is triggered. The recording type can be based on time and triggered by motion detection and/or an alarm. If set to TimeLapse (TL-Hi or TL-Lo), the recorder records continuously.
8. Click **Apply** to save settings.
9. Repeat steps 4 to 8 for other days of the week or to copy the schedule settings to another day.
To copy the current schedule settings to another day of the week, click **Copy**. Select the number of the day of the week to which to copy the schedule. Click **OK** to save changes and return to the Edit window.
10. Repeat steps 4 to 9 for the other cameras.
11. Click **Apply** to save the settings and **OK** to return to the schedule window.
The recording schedule window appears showing the schedule selected (see Figure 25 on page 86 for an example).

Modify the instant replay duration

The live view toolbar in live view lets you quickly replay recorded video for a preprogrammed period. You can easily change this preprogrammed time period. See page 33 for more information on the live view toolbar.

To modify the preprogrammed time of this instant replay, go to **Recording > General**. Select one of the times from the drop-down list (5, 10, 20, or 30 minutes) and click **Apply**. Default is 5 minutes.

Manual recording

The recorder lets you manually record video during live view. This can be useful if you know that the recorder is not currently recording and you see something of interest on a camera screen that should be recorded.

Once a manual recording is started, the recording continues until it is manually stopped. If an alarm occurs during a manual recording, the alarm recording has priority over the manual recording. If a scheduled recording is already in progress when a manual recording is started, it continues to record as scheduled.

You can check to see if a camera is recording manually by looking at the icon on the live view toolbar. The icon is red when manually recording. Default is off.

There are two ways to start and stop a manual recording:

- **Use the live view toolbar**

You can start/stop manual recording for each camera individually. Position the cursor over a camera image and left-click the mouse to display the live view toolbar. Click the manual record icon to start or stop manual recording. The icon is red when recording.

- **Use the configuration menu**

This option lets you select more than one camera at a time. Go to **Recording > Manual Recording** to access the manual recording menu and check the boxes of the cameras to start or stop manual recording.



Chapter 13

Alarm and event setup

This chapter describes the alarm and event setup menu and provides more information on the different types of alarms and connected responses.

Set up alarm inputs

The recorder can be configured to record when an alarm is triggered by an external alarm device (for example, PIR detector, dry contacts...).

To set up external alarms:

1. From the menu toolbar, click **Alarm & Event Setup > Alarm Input**.



2. Select the alarm input number of a camera, which corresponds to the connector on the back panel of the recorder, and enter the name of the input, if required.
3. Select the alarm input type, NO (normally open) or NC (normally closed). Default is NO.
4. Check the **Enable Alarm Input** box and click **Actions** to set up the rules for the cameras to be triggered, their alarm schedules, method of alarm notification and PTZ linking function.
5. Select the cameras to be triggered when an external alarm is detected.

In the Actions window, click the **Trigger Channel** tab and then select the cameras to be triggered for recording when an alarm is detected. Only analog cameras can be selected. Click **Apply** to save the settings.

6. Select the recording schedules for the external alarm.

In the Actions window, click the **Arming Schedule** tab and select the day of the week and the time periods during the day when motion can be recorded. You can schedule up to eight time periods in a day. Default is 24 hours.

Click **Apply** to save the settings. Click **Copy** to copy these settings to other days of the week.

Note: The time periods defined cannot overlap.

7. Select the response method to an external alarm.

In the Actions window, click the **Actions** tab to define the method by which you want the recorder to notify you of the alarm. Select one or more of the six notification types. See “Alarm notification types” on page 93 for a description of these alarm notification methods.

Click **Apply** to save the settings.

8. Select the PTZ camera function required in response to an external alarm.

In the Actions window, click the **PTZ Linking** tab. Select the PTZ camera and enter the preset, preset tour or shadow tour that is triggered when the alarm is detected.



Click **Apply** to save the settings.

9. Click **OK** to return to the alarm input window.
10. Click **Exit** to return to live view.

Set up alarm outputs

You can connect the recorder to an alarm system, such as a siren or intrusion system, which is then activated when an alarm is triggered. You can select how long the alarm signal remains active as well as schedule when alarm outputs can be triggered.

To set up an alarm output:

1. From the menu toolbar, click **Alarm & Event Setup > Alarm Output**.
2. Select the alarm output.

3. Select a timeout option between 5 and 600 seconds or select “Manually Clear”.

The timeout setting lets you define how long an alarm signal remains active after the alarm has ended. If you select **Manually Clear**, the alarm signal remains active until it is manually acknowledged by pressing the alarm button on the front panel or remote control (see “Triggering or clearing alarm outputs manually” below).

4. Select the recording schedules for the alarm output.

Click the **Actions** button and select the day of the week and the time periods during the day when motion can be recorded. You can schedule up to eight time periods in a day. Default is 24 hours.

Click **Apply** to save the settings. Click **Copy** to copy the settings to other days of the week and holiday period.

Note: The time periods defined cannot overlap.

5. Click **OK** to return to the alarm output window.
6. Click **Copy** to copy these settings to other cameras, if required, and then click **Apply** to save the changes.
7. Click **Exit** to return to live view.

Manual trigger

The manual trigger menu allows you to manually trigger outputs of the recorder.

To trigger or clear alarm outputs manually:

1. From the menu toolbar, click **Alarm & Event Setup > Manual Trigger**.
2. Select the desired alarm output and click the following buttons:

Trigger / Clear: Trigger an alarm output or stop an alarm output. As there is only one alarm output available, the “Trigger All” button just triggers the one output.

Clear All: Stop all alarm outputs at once.

3. Click **Exit** to return to live view. The alarm is silenced.

- Or -

Press the **Alarm** button on the front panel or remote control. The alarm is silenced.

Buzzer settings

When an alarm is triggered by the system or a camera, the recorder can be set up to respond with a warning buzzer. You can modify the time during which the warning buzzer sounds for both system and camera alarm. Select **Alarm & Event Setup > Buzzer Settings** and select a buzzer time limit for the system and camera alarms. Select Mute, 5 s, 10 s, 20 s, 30 s, 60 s, 120 s, 240 s, or Constant. Default is mute.

Alarm notification types

When setting up the rules for alarm detection, you can specify how you want the recorder to notify you about an alarm or event. You can select more than one notification type.

Not all notification types are available for all types of alarms.

You can quickly check the system status by looking at the status LEDs on the front panel.

The alarm notification types are:

- **Full-screen Monitoring:** When an alarm is triggered, the monitor (VGA or HDMI) displays an image in live view mode. For alarms that are triggered simultaneously, images display one at a time every 10 seconds (default dwell time). You can set a different dwell time using the Dwell Time setting under the Display Settings>Layout window. When the alarm stops, cycling of the images stops and you return to live view mode. This alarm option must be selected for each channel where it is required.
- **Enable Alarm Audio:** Triggers an audible *beep* when a notification or alarm is detected by the system or a camera.
- **Notify Alarm Host:** Sends a signal to TruVision Navigator or other software applications when an alarm or notification is detected.
- **Send Email:** Sends an email when an alarm or notification is detected. See “E-mail settings” on page 81 for information on how to configure the recorder to send an email.
- **Upload Snapshots to FTP:** Capture the image when an alarm is triggered and upload the picture to NAS or FTP server.
- **Trigger Alarm Output:** Triggers an alarm output or multiple alarm outputs when a notification is detected for an external alarm. See “Types of system alarm notifications” on page 94 for information on configuring an alarm output.
- **Display Event Icon:** When an alarm is triggered in the system, an icon appears on screen to also alert you. See “Status information” on page 30 for further information.
- **Event Priority:** Define the priority between a text insertion event and a motion alarm if both are triggered at the same time. Default is a motion alarm (Text In < Motion).

To set up system notifications:

1. From the menu toolbar, click **Alarm & Event Setup > Notification**.
2. Select a system alarm notification type.
3. Check one or more response method: Display event icon, event priority, enable alarm audio, notify alarm host, send email, and trigger alarm output.

Note: The list of options available depends on the system alarm selected.

4. Repeat steps 2 and 3 for other system notification types.

5. Click **Apply** to save the settings.
6. Click **Exit** to return to live view.

Types of system alarm notifications

The different types of system alarm notifications are:

- **HDD Full:** All installed HDDs are full and will not record any more video.
- **HDD Error:** Errors occurred while files were being written to the HDD, there is no HDD installed, or the HDD had failed to initialize.
- **Network Disconnected:** Disconnected network cable.
- **Duplicate IP Address Found:** There is an IP address conflict with another system on the network.
- **Illegal Login:** Wrong user ID or password used.
- **Input/output Video Standard Mismatch:** I/O video standards do not match.
- **Abnormal Record:** HDD cannot record any more files. This could be due to the overwrite option being disabled so recorded files are locked and cannot be deleted.

Detect video loss

Video may be lost if the camera develops a fault, is disconnected, or is damaged. You can set up the recorder to detect video loss and trigger a system notification.

To setup video loss detection:

1. From the menu toolbar, click **Alarm & Event Setup > Video Loss**.
2. Select a camera to configure for video loss detection.
3. Check the **Enable Video Loss Alarm** box to enable the feature.
4. Click the **Actions** button to enter the Actions window.
5. Set the arming schedule for detecting video loss.

Click the **Actions** tab and select the schedule of when you want video loss detection to be enabled. The schedule can be set for all week or any day of the week with up to 8 time periods per day. Click **Apply** to save the settings.

6. Select the alarm response method.

Click the **Arming Schedule** tab and select how you want the recorder to notify you of video loss. Select: Full-screen monitoring, enable alarm host, send email, and trigger alarm host. See page “Types of system alarm notifications” above for the descriptions. Click **Apply** to save the settings.

7. Click **OK** to return to the main window

8. Click **Copy** to copy these settings to other cameras, if required, and then click **Apply** to save the changes.
9. Click **Exit** to return to live view.

Remote alarm host setup

If a remote alarm host is set, the recorder sends a signal to the host when an alarm is triggered. The remote alarm host must have the TruVision Navigator server software installed.

To set up a remote alarm host:

1. From the menu toolbar, click **Alarm & Event Setup > Alarm Host Setup**.
2. Enter Alarm Host IP and Alarm Host Port values.

Alarm host IP represents the IP of the remote PC where the Network Video Surveillance software installed. The alarm host port value must be the same as software's alarm monitor port. Up to three alarm hosts can be set. For each alarm host, the default port is 5001, 5002, and 5003.



3. Click **Apply** to save the settings.
4. Click **Exit** to return to live view.

Chapter 14

Device management

This chapter describes how to:

- Set up the time and date of the recorder
- Select the recorder language and set up general system parameters such as the device name, menu timeout period, and enable/disable password requirement
- Import/export configuration files
- Upgrade the firmware
- Set up holiday periods
- Enable text insertion
- Configure RS-232 settings

Time and date settings

You can set up the date and time that will appear on-screen as well as on time stamped recordings. The start and end time of daylight saving time (DST) in the year can also be set. DST is deactivated by default. See Figure 20 on page 97 for the Time settings screen.

Figure 26: Time and date settings window



Table 14: Description of the Time and Date settings window

Option	Description
1. Time Zone	Select a time zone from the list.
2. Date Format	Select the date format from the drop-down list. Default format is DD-MM-YYYY.
3. Time Format	Select either the 12-hour or 24-hour time format from the list. Default format is 24-hour format.
4. Display Week	Check to display the day of the week in the monitor time bar. Check the box to enable/disable. Default is Disable.
5. System Date	Enter the system date. Default date is the current date.
6. System Time	Enter the system time. Default time is the current time.
7. Auto DST Adjustment	Enable to activate DST is automatically. It depends on the time zone selected. Default is Disable.
8. Enable DST	Manually define DST. If this option is selected, the <i>Auto DST adjustment</i> option is disabled. Default is Disable. Click the check box to enable or disable daylight savings time (DST).
From	Enter the start date and time for daylight savings.
To	Enter the end date and time for daylight savings.
DST Bias	Set the amount of time to move DST forward from the standard time. Default is 60 minutes.

General recorder settings

Use the General Settings menu of Device Management to configure general recorder options.

See Figure 27 and Table 14 on page 98 for the general options available. The changes are immediately implemented once Apply is clicked to save the settings.

Figure 27: General settings of the recorder



Table 15: Description of the Monitor setup window: General settings

Option	Description
1. Language	<p>Define the language of the system.</p> <p>Select the desired language from the drop-down list and click Apply. The language displayed changes immediately.</p> <p>Default is English.</p>
2. Device Name	<p>Define the recorder name. The default name is TVR 12HD.</p> <p>Click the edit box and enter the new name from the soft keyboard.</p>
3. Remote Control ID	<p>The device number to use for the recorder when linking the device to a remote control. The default value is 255.</p>
4. Keypad Zone ID	<p>Each recorder in a daisy chain must have a unique zone ID so that it can be controlled by a RS-485 wired keypad. This is not required when using IP keypads.</p> <p>The default value is 1.</p>
5. Password Required	<p>Define whether a login password is required to open the menu.</p> <p>Check the box to enable/disable and click Apply.</p> <p>Default is Disable.</p>
6. Enable Wizard	<p>Immediately start Wizard without rebooting the system.</p> <p>Check the box to enable/disable and click Apply.</p> <p>Default is Enable.</p>

Option	Description
7. Menu Timeout	Define the time in minutes after which the menu window reverts to live view mode. Select a time from the drop-down list, and click Apply. Default value is 5 minutes.
8. Mouse Pointer Speed	Modify the speed of the mouse pointer. Adjust the scroll bar point to the desired level and click Apply. Default is the slowest of the four speeds.
9. Enable Front Panel Lock	When the system logs out, the front panel is automatically locked. When enabled, to unlock the front panel, press the Live button for 5 seconds. Default is Disable.
10. Start Wizard	Reboot the system immediately and start Wizard. Default is Disable.

Configuration files

You can export and import configuration settings from the recorder. This is useful if you want to copy the configuration settings to another recorder, or if you want to make a backup of the settings.

Import and export files

Insert an external storage device in the recorder. Go to the **Device Management > Configuration Files** to import or export configuration settings. Click **Export** to export the recorder's configuration settings into an external storage device or click **Import** to import configuration settings after selecting a configuration file from the external storage device.

Restore default settings

The administrator can reset the recorder to the factory default settings. Network information such as IP address, subnet mask, gateway, MTU, NIC working mode, server port, and default route are not restored to factory default settings

To restore parameters to default factory settings:

1. From the menu toolbar, click **Device Management > Configuration Files**.

Note: Only the administrator can restore the default settings.

2. To restore all parameters to default factory settings:

Click the **Default** button. Enter the Admin password, click **OK**, and then click **Yes** to confirm that you want to restore all parameters to default.

— Or —

To restore all parameters, except network settings, to default factory settings:

Click the **Restore** button. Enter the Admin password, click **OK**, and then click **Yes** to confirm that you want to restore all parameters except network settings to default.

3. Click **OK** to confirm you want to restore default settings.

Upgrade system firmware

The firmware on the recorder can be updated using three methods:

- Via a USB device
- Via the recorder web browser
- Using TruVision Navigator. For further information, refer to the TruVision Navigator user manual.

The firmware upgrade file is labeled *TVR12HD.dav*.

To update the system firmware using a USB device:

1. Download the latest firmware from our web site at:
www.interlogix.com
- Or -
www.utcssecurityproductspages.eu/videoupgrades
2. Connect the USB device to the recorder.
3. From the menu toolbar, click **Device Management > Upgrade Firmware**.
The list of files on the USB is displayed.
4. Select the firmware file and click **Upgrade**. Click **Yes** to begin the upgrade process.
5. When the upgrade process is completed, reboot the recorder. The recorder does not reboot automatically.

Holiday schedules

It is possible to indicate holidays for which you can create a separate recording schedule. Once one or more holidays are created, a separate entry for holiday will be included in the recording schedule (refer to “Recording schedule” on page 86 of the manual)

To set up a holiday recording schedule:

1. From the menu toolbar, click **Device Management > Holiday**.
2. Select a holiday period from the list and click its **Edit** button to modify the settings.
The Edit window appears.

3. Enter the name of the holiday period and click **Enable**.
4. Select whether the holiday period will be categorized by date, week, or month and then enter the start and end dates.
5. Click **Apply** to save the settings and then **OK** to return to the Edit window.
6. Repeat steps 2 to 5 for other holiday periods.
7. Click **Exit** to return to live view.

Text insertion

Text insertion lets you insert or display text from a point-of-sale (POS), automated teller machine (ATM) or other systems on the video display of the recorder. The text is saved and time-stamped together with the video. You can then search the text for specific video clips. The text is can be enabled or disabled during live view and playback.

The recorder supports POS and ATM text insertion via text insertion accessories connected to the RS-232 port of the recorder.

To set up text insertion:

1. Set up the RS-232 port for appropriate interface, Probridge or ATS/Challenger.
2. From the menu toolbar, click **Device Management > Text Insertion**.



3. Check **Enable Text Insertion**.
4. Under **Access Device**, select the access device from the drop-down list. Only ATM/POS is listed.
5. Under **Access Mode**, select Probridge or Forcefield.

Note: Forcefield is used with the Challenger intrusion panel.
6. If Probridge is selected, under “Start String” enter a repeating word that appears on each cash transaction receipt and that is followed by the information you want to record. An example could be the word “Date”. The text shown will only be the text as of this start string.

7. Click **Apply** to save the settings.
8. Continue to configure the recorder or click **Exit** to return to live view.

It is important to take into account that different ATM, POS and other text generating devices use different protocols. For this reason, please consult your local technical support or sales representative for more information.

Configure the RS-232 port

Use the RS-232 menu under **Device Management** to configure the RS-232 parameters such as baud rate, data bit, stop bit, parity, flow control, and interface.

Figure 28: RS-232 setup window



Table 16: Description of the RS-232 settings window

Option	Description
1. Baud Rate	This is a measure of the speed of data transmission. Default is 115200.
2. Data Bit	A bit is the smallest unit of data in a serial communication message. A data bit is the bit carrying the information, as opposed to the start bit and the stop bit. Default is 8.
3. Stop Bit	Stop bits mark the end of a transmission of a serial communication message. Default is 1.
4. Parity	The method used to detect errors in the number of bits being transmitted. Default is None.
5. Flow Ctrl	Flow control is the process by which data transfer is regulated so that it does not arrive too quickly for the receiving process. Default is None.

Option	Description
6. Interface	<p>Select one of the three ways the RS-232 port can be used:</p> <p>ProBridge: POS and ATM text insertion supported via the ProBridge accessory connected to the RS-232 port. See “Text insertion” on page 101 for more information.</p> <p>Challenger: NTP time sync supported to foreign device over the RS-232 port.</p> <p>Technical Support: Console mode.</p>

Chapter 15

Storage management

This chapter describes the content of the Storage Management menu, including HDD information, Storage Mode, S.M.A.R.T. settings as well as Bad sector detection.

HDD information

You can check the status of any of the installed HDDs on the recorder at any time.

To check the status of a HDD:

1. From the menu toolbar, click **Storage Management > HDD Information**.
2. Note the status of the HDDs listed under the Status column.

If the status is listed as Normal or Sleeping, the HDD is in working order. If it is listed as Abnormal and has already been initialized, the HDD needs to be replaced. If the HDD is Uninitialized, you need to initialize it before it can be used in the recorder. Refer to “Initializing HDDs” above for more information.

Note: The status information is also shown in the **System Information > HDD** window.

Initialize a HDD

The built-in HDD does not need to be initialized before it can be used. You can also re-initialize the HDD. However, all data on the HDD will be destroyed.

To initialize a HDD:

1. From the menu toolbar, click **Storage Management > HDD Information**.
2. Under the HDD Information tab, select the HDD to be initialized.
3. Click the **Initialize** button to begin initialization.

After the HDD has been initialized, the status of the HDD changes from Abnormal to Normal.

Overwrite a HDD

You can select how the recorder responds when the HDDs become full and there is no longer sufficient space to save new data. The overwrite option is enabled by default.

To enable overwrite when the HDDs are full:

1. From the menu toolbar, click **Storage Management > HDD Information**.
2. Enable **Overwrite**.

Caution: If the overwrite option is disabled and the quota management capacity for a channel is set to zero, the recordings on that channel can still be overwritten. To avoid this happening, set a quota level for the channel or use the group management mode.

3. Click **Apply** to save the settings.
4. Continue to configure the recorder or click **Exit** to return to live view.

Storage mode

To ensure an efficient use of the storage space available on HDDs, you can control an individual camera's storage capacity using HDD quota management. This function lets you allocate different storage capacities for both recordings and snapshots to each camera.

Note: If the overwrite function is enabled, the maximum capacity for both recordings and snapshots is set to zero by default.

To set the HDD quota for a camera:

1. From the menu toolbar, click **Storage Management > Storage Mode**.



2. Under the Mode option, select **Quota**.

3. Select a camera whose storage capacity you want to change and enter the values in GB for the maximum record capacity and snapshot capacities. The available quota space available is displayed on screen.
4. Click **Apply** to save the settings.
5. If you want to copy these values to other cameras, click **Copy** and select each camera individually. Click **OK**. Click **Apply** to save the settings.

Group HDDs

Your recorder can organize multiple HDDs into groups. Videos from specified channels can be set to be recorded onto a particular HDD group. You could, for example, save the records from a couple of high priority cameras to one HDD, and save the recordings from all the other cameras to another HDD.

To set up an HDD group:

1. From the menu toolbar, click **Storage Management > Storage Mode**.
2. Under **Mode**, select **Group**.
3. Under **Record on HDD Group**, select a number for the HDD group.
4. Check the channels to be added to this group.
Note: By default, all channels belong to HDD group 1.
5. Click **Apply** to save the settings.
6. Continue to configure the recorder or click **Exit** to return to live view.

Create HDD groups

If you have more than one HDD installed, you can change the behavior of a HDD by changing its property. It can be set to read-only or read/write (R/W). The storage mode must be set to *Group* before setting the HDD property.

A HDD can be set to read-only to avoid important recorded files from being overwritten when the HDD becomes full.

To change a HDD status property:

1. From the menu toolbar, click **Storage Management > HDD Information**.
2. Select the HDD whose property you want to change.
3. Click the **Edit** icon . The **Local HDD Settings** window appears.
Note: The Edit icon is only available if there are at least two HDDs installed.
4. Click the desired HDD property for the selected HDD: R/W or Read Only.
5. Click the group number for this HDD.
6. Click **Apply** to save and exit the window.

Note: Once set to read-only, the HDD cannot be used to save recorded files until it is set back to read/write (R/W). If the HDD that is currently being written to is set to read-only, the data is then recorded to the next HDD. If there is only one HDD present, setting it to read-only means the recorder cannot record.

Set up HDD sleep mode

You can set the HDD to enter standby mode, or sleep mode, after a period of inactivity. Sleep mode decreases the power consumption of a HDD.

To enable HDD sleep mode:

1. From the menu toolbar, click **Storage Management > Storage Mode**.
2. Check **Enable HDD Sleeping** to enable sleep mode. Default is Enable.
3. Click **Apply** to save the settings.
4. Continue to configure the recorder or click **Exit** to return to live view.

S.M.A.R.T. settings

S.M.A.R.T. (Self-Monitoring, Analysis and Reporting Technology) reports on a variety of hard drive attributes. It helps ensure that the HDD is functioning properly at all times while protecting video stored on the hard drive.

To view the S.M.A.R.T. information of a HDD:

1. From the menu toolbar, click **Storage Management > S.M.A.R.T. Settings**.
2. Select the HDD whose data you want to see. A detail listing of S.M.A.R.T. information is displayed.



3. If you want to continue to use a HDD when the S.M.A.R.T. test has failed, check the box **Use when the disk has failed to self-evaluate**. Click **Apply** to save the settings.
4. Click **Exit** to return to live view.

Bad sector detection

You can improve the performance of your HDDs by ensuring that they have no bad sectors. Bad sectors can slow down an HDD when reading or writing data, for example.

Figure 29: Bad sector detection window

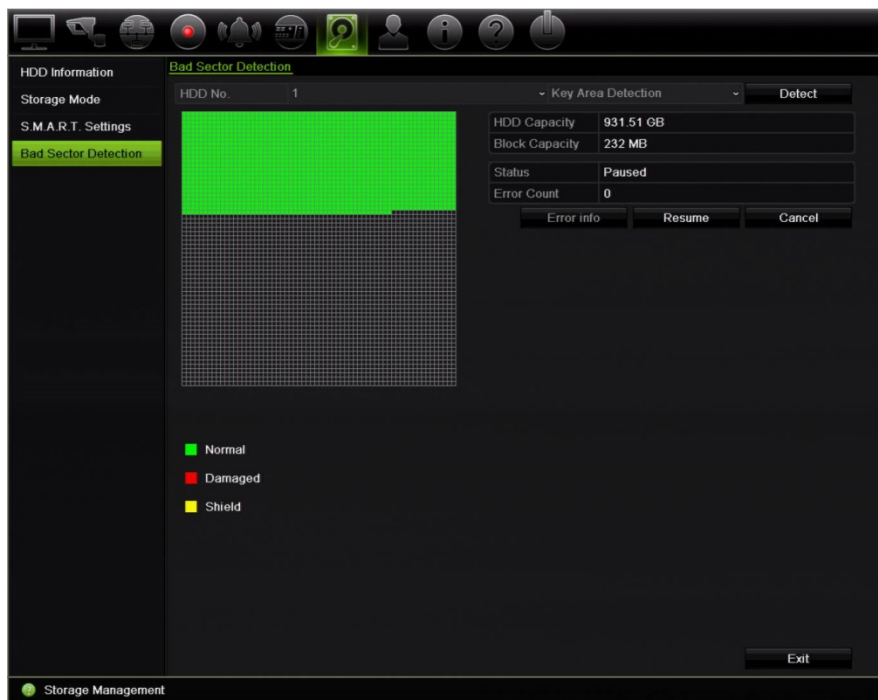

To detect bad sectors:

1. From the menu toolbar, click **Storage Management > Bad Sector Detection**.
2. Select the HDD you want to test.
3. Select whether you want to do a key area detection or a full detection, and click **Detect**.
4. The system checks the HDD. The color-coded result is displayed on screen. If there are bad sectors found, click **Error Info** to see a list of the errors found.
5. If required, click **Pause** to pause the test or **Cancel** to cancel it.
6. Click **Exit** to return to live view.

Chapter 16

User management

By default the recorder comes with three user accounts: an Administrator account, an Operator account and a Guest account. These accounts provide multiple levels of access and functionality. See Table 17 below for a description of the different user accounts.

Table 17: User accounts

User	Description
Administrator	<p>The administrator account includes extended menu with full access to all settings. The Administrator has the authority to add, delete or configure parameters for many of the system functions.</p> <p>There can only be one administrator.</p> <p>The user name is admin. The name cannot be modified.</p> <p>The default password is 1234.</p>
Operator	<p>The operator account includes reduced menu access to Video settings (inaccessible features are not visible).</p> <p>The default user name is "operator".</p> <p>The default password is 2222.</p>
Guest	<p>The guest account includes menu access with no programming possibilities (inaccessible features are not visible).</p> <p>The default user name is "guest".</p> <p>The default password is 3333.</p>

Note: The default passwords should be changed for security reasons.

Add a new user

Only a system administrator can create a user. You can add up to 16 new users.

To add new users:

1. From the menu toolbar, click **User Management**.
2. Click **Add** to enter the Add User window.
3. Enter the new user's name and password. Both the user name and password can have up to 16 alphanumeric characters.
4. Select the new user's access level: Operator or Guest. Default is Guest.
5. Enter the user's MAC address to let the user access the recorder from a remote computer with this MAC address.
6. Click **OK** to save the settings and return to the previous window.
7. Define the user's permissions.

Click the **Permission** button  for the new user. In the Permissions pop-up window check the required access privileges for local, remote and camera configuration. See "Customizing a user's access privileges" below for the permission descriptions for each group.

Click **Apply** to save the settings and **OK** to return to the previous window.

8. Click **Exit** to return to live view.

Customize a user's access privileges

Only an administrator can allocate access privileges to Operator and Guest users. The access privileges can be customized for each user's needs. The administrator's access privileges cannot be changed.

There are three types of privilege settings: Local Configuration, Remote Configuration, and Camera Configuration.

Note: Only the administrator can restore factory default settings.

Local configuration settings

By default, only the local information (log) management setting is enabled for both operators and guests.

- **Local Information (Log) Management:** Search and view logs of the recorder and view system information.
- **Local Parameter Settings:** Configure parameters and import the configuration from the recorder.
- **Local Camera Management:** Locally add, delete, and edit IP cameras.

- **Local Advanced Operation:** Access HDD management (including the initialization and modification of disk properties). Update system firmware as well as stop the I/O alarm output.
- **Local Shutdown/Reboot:** Shutdown or reboot the recorder.

Remote configuration settings

By default, only remote log search and two-way audio are enabled for operators, and only the remote log search is enabled for guests.

- **Remote Log Search:** Remotely view logs that are saved on the recorder.
- **Remote Parameter Settings:** Remotely configure parameters and import configuration.
- **Remote Camera Management:** Remotely enable and disable channels.
- **Remote Video Output Control:** For future use.
- **Two-Way Audio:** Use two-way audio between the remote client and the recorder.
- **Remote Alarm Control:** Remotely alert or control the relay output of the recorder. Alarm and notification settings must be configured properly to upload to host.
- **Remote Advanced Operation:** Remotely manage HDDs (initializing and setting properties for HDDs) as well as remotely update system firmware and clear the I/O alarm output.
- **Remote Shutdown/Reboot:** Remotely shutdown or reboot the recorder.

Camera configuration settings

By default, all analog cameras are enabled for operators for each of these settings. By default, the analog cameras are only enabled for local playback and remote playback for guests. IP cameras cannot be configured.

- **Local Live View:** Locally select and view live video.
- **Local Playback:** Locally play recorded files that are on the recorder.
- **Local Manual Operation:** Locally start/stop manual recording on any of the channels, snapshots, and video clips.
- **Local PTZ Control:** Locally control PTZ dome cameras.
- **Local Video Export:** Locally back up recorded files from any of the channels.
- **Remote Live View:** Remotely select and view live video over the network.
- **Remote Playback:** Remotely play and download recorded files that are on the recorder.

- **Remote Manual Operation:** Remotely start/stop manual recording on any of the channel.
- **Remote PTZ Control:** Remotely control PTZ dome cameras.
- **Remote Video Export:** Remotely backup recorded files from any channel.

To customize a user's access privileges:

1. Click the **User Management** icon in the menu toolbar to display its window.
2. Click the Permission button  for the user whose access privileges need to be changed. The Permissions pop-up window appears.
3. Click **Apply** to save the settings.
4. Click the **OK** button to return to the previous window.
5. Click **Exit** to return to live view.

Delete a user

Only a system administrator can delete a user.

To delete a user from the recorder:

1. Click the **User Management** icon in the menu toolbar to display its window.
2. Click the **Delete** button  for the user to be deleted.
3. Click **Yes** in the pop-up window to confirm deletion. The user is immediately deleted.
4. Click **Exit** to return to live view.

Modify a user

A user's name, password, access level and MAC address can be changed. Only a system administrator can modify a user.

To modify a user:

1. Click the **User Management** icon in the menu toolbar to display its window.
2. Click the Edit button  for the user whose details need to be changed. The Edit User pop-up window appears.
3. Edit the user information and click **OK** to save the settings and return to the previous window.
4. Click **Exit** to return to live view.

Change the Admin password

The administrator's password can be changed in the **User Management** menu.

To change the admin password:

1. Click the **User Management** icon in the menu toolbar to display its window.
2. Click the Edit button  for admin. The Edit User pop-up window appears.
3. Edit the current admin password and check the **Change Password** box.
4. Enter the new admin password and confirm it. Change the admin MAC address, if required. Click **OK** to save the settings and return to the previous window.
5. Click **Exit** to return to live view.

Chapter 17

System information

View system information

To view system information:

1. From the menu toolbar, click **System Information**.
2. To view device information, click **Device Info**.

You can view the device name, model, serial number, firmware version, and encoding version.



3. To view camera information, click **Camera**.

You can view the information on each camera: camera number, camera name, status, motion detection, tamper proof, video loss, preview link sum, and preview link information.



- To view record information, click **Record**.

You can view the camera number, recording status, stream type, active frame rate, active bit rate versus reserved bit rate (Kbps), active resolution, active record type, and active encoding parameters.

The “Preview Link Sum” shows the number of streams being viewed by the recorder. The “Preview Link Information” lists all the IP addresses of the streams viewed by the recorder.



- To view alarm input information, click **Alarm Inputs**.

You can view the alarm input number, alarm name, alarm type, alarm status, and triggered camera.



6. To view alarm output information, click **Alarm Outputs**.

You can view the alarm output number, alarm name, and alarm status.

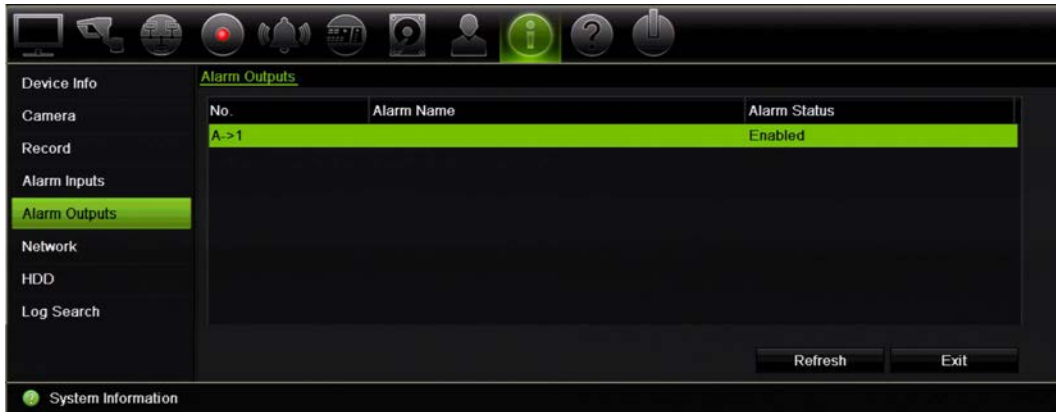

7. To view network information, click **Network**.

You can view the IPv4 address, IPv4 subnet mask, IPv4 default gateway, IPv6 address 1, IPv6 address 2, IPv6 default gateway, preferred DNS server, alternate DNS server, enable DHCP, enable PPPoE, PPPoE address, PPPoE subnet mask, PPPoE default gateway, MAC address, server port, HTTP port, multicast IP, RTSP service port, enable Telnet, and total bandwidth limit (Kbps).



8. To view HDD information, click **HDD**.

You can view the HDD label, status, capacity, free space, property, type, and group.



9. Click **Exit** to return to live view.

Search the system log

Many events of the recorder, such as operation, alarm and notification, are logged into the system logs. They can be viewed and exported at any time.

Up to 2000 log files can be viewed at once.

Log files can also be exported onto a USB device. The exported file is named according to the time it was exported. For example: 20140729124841logBack.txt.

Note: Connect the backup device, such as a USB flash drive, to the recorder before commencing the log search.

To search video from the system log:

1. From the menu toolbar, click **System Information > Log Search**.
2. Select the search start and end date and times.
3. Under **Event**, select an option from the drop-down list: All, Alarm, Notification, Operation, or Information.
4. From the **Type** list, select one of the options:

Event	Type
All	All
Alarm	All, Alarm Input, Alarm Output, Start Motion Detection, Stop Motion Detection, Start Camera Tamper, Stop Camera Tamper
Notification	All, Video Loss Alarm, Illegal Login, HDD Full, HDD Error, Duplicate IP Address Found, Network Disconnected, Abnormal Record, IP Camera Disconnected, IP Camera Address Conflicted, Input/Output Video Standard Mismatch, Record Buffer Overflow, Input/recording Resolution Mismatch, IP Camera Motion Analysis Exception
Operation	All, Power Up, Local: Shutdown, Abnormal Shutdown, Watchdog Reboot, Local: Restart, Local: Login, Local: Logout, Local Configure Parameters, Local: Upgrade, Local: Start Manual Recording, Local: Stop Manual Recording, Local: PTZ Control, Local: Lock File, Local: Unlock File, Local: Trigger Alarm Output, Local: Initialize HDD, Local: Add IP Camera, Local: Delete IP Camera, Local: Set IP Camera, Local: Upgrade IP Camera Firmware, Local: Playback by File, Local: Playback by Time, Local: Playback by Snapshot file, Local: Export Config File, Local: Import Config File, Quick Snapshot, Playback Snapshot, Local: Restore Admin's Password, Local: Operate Bookmark, Local: Switch Output, Local: HDD Detect, Local: Delete HDD, Local: Restore Device Parameters, Remote: Shutdown, Remote: Reboot, Remote: Login, Remote: Logout, Remote: Configure Parameters, Remote: Upgrade, Remote: Start Manual Recording, Remote: Stop Manual Recording, Remote: PTZ Control, Remote: Lock File, Remote: Unlock File, Remote: Trigger Alarm Output, Remote: Initialize HDD, Remote: Add IP Camera, Remote: Delete IP Camera, Remote: Upgrade IP Camera Firmware, Remote: Playback by File, Remote: Playback by Time, Remote: Download by File, Remote: Download by Time, Remote: Export Config File, Remote: Import Config File, Remote: Export Record File, Remote: Export Snapshot File, Remote: Get Parameters, Remote: Get Working Status, Connect Transparent Channel, Disconnect Transparent Channel, Start Two-way Audio, Stop Two-way Audio, Remote: Alarm Arming, Remote: Alarm Disarming, Remote: Operate Bookmark, Remote: Delete HDD, Remote: Restore Device Parameters
Information	All, Local HDD Information, HDD S.M.A.R.T., Start Recording, Stop Recording, Delete Expired Record, System Running Status

5. Click the **Search** button. A list of results appears.



6. Select a file and click:

- **Details:** Displays information on the log or recording. For a recording, it lists such information as start time, type of event, local user, host IP address, parameter type, camera number, and gives a description on the types of events recorded and when record time was stopped.

- **Play:** Click to start playback of the selected recording.

- **Export:** Click to archive the selected file to a USB device. The export window appears.

7. Click **Exit** to return to live view.

Chapter 18

Using the web browser

This chapter describes how you can use the web browser interface to configure the device, play back recorded video, search through event logs, and control a PTZ dome camera. You can also specify settings on the web browser interface to optimize video playback and recording performance when operating in a low or limited bandwidth environment. Many of the browser configurations are similar to those done locally.

Windows 7 and Windows 8 users

Internet Explorer for Windows 7 and Windows 8 operating systems have increased security measures to protect your PC from any malicious software being installed. When using the recorder web browser interface, you can install ActiveX controls to connect and view video using Internet Explorer.

To have complete functionality of the web browser interface and the recorder player with Windows 7 and Windows 8, do the following:

- Run the Browser interface and the recorder player application as an administrator in your workstation
- Add the recorder's IP address to your browser's list of trusted sites

To add the recorder's IP address to Internet Explorer's list of trusted sites:

1. Open Internet Explorer.
2. Click **Tools**, and then **Internet Options**.
3. Click the Security tab, and then select the Trusted Sites icon.
4. Click **Sites**.
5. Clear the "Require server verification (https:) for all sites in this zone" box.
6. Enter the IP address or DDNS name in the "Add this website to the zone" field.
7. Click **Add**, and then click **Close**.
8. Click **OK** in the Internet Options dialog box.
9. Connect to the recorder for full browser functionality.

Access the web browser

To access the recorder, open the Microsoft Internet Explorer web browser and enter the IP address assigned to the recorder, as a web address. On the logon window, enter the default user ID and password.

Note: Only one recorder can be viewed per browser.

User ID: admin

Password: 1234

The default values for recorder network settings are:

- IP address - 192.168.1.82
- Subnet mask - 255.255.255.0
- Gateway address - 192.168.1.1
- Server port: 8000
- Ports:

When using the browser:

RTSP port: 554

HTTP port: 80

When using TruNav:

RTSP port: 554

Server/Client software port: 8000

For more information on port forwarding, see Appendix C “Port forwarding information” on page 135.

Web browser live view

The recorder web browser lets you view, record, and play back videos as well as manage all aspects of the recorder from any PC with Internet access. The browser’s easy-to-use controls give you live view to all the recorder functions. See Figure 30 on page 123.

Figure 30: Live view in the web browser interface

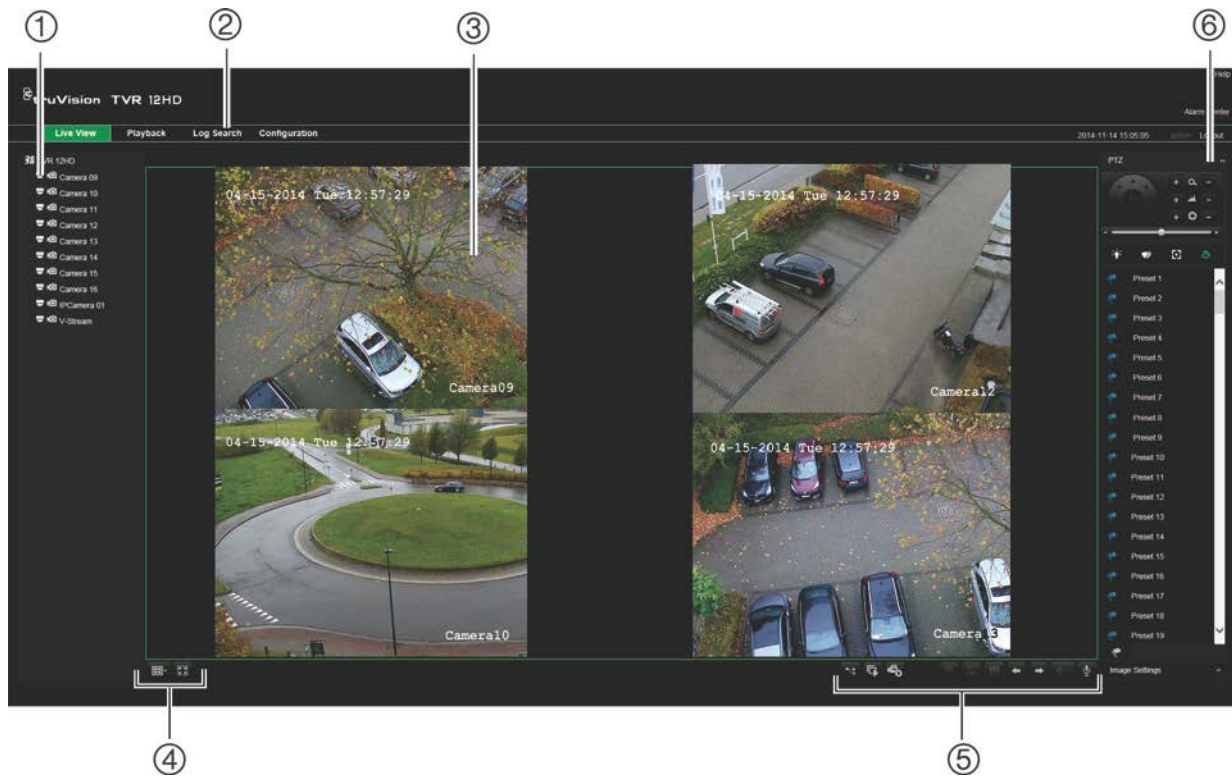











Table 18: Description of live view in the web browser

Name	Description
1. Camera	Select the camera.
2. Menu toolbar	Lets you do the following: <ul style="list-style-type: none"> • View live video • Play back video • Search for event logs • Configure settings • Log out of the interface
3. Viewer	View live or playback video.
4. Display format	Define how you want video to be displayed in the viewer: Multiview or full-screen.
5. Video function toolbar	Lets you do the following in live view: <ul style="list-style-type: none">  Switch between mainstream and substream.  Start/stop all streaming from selected cameras.  Start recording from selected cameras.  Digital zoom.  Turn POS/ATM text insertion on/off.

Name	Description
	Take a video snapshot.
	View previous and next camera respectively.
	If viewing in multiview format, live view moves to the next group of cameras for the selected number of video tiles.
	Turn audio on/off
	Turn microphone on/off
6. PTZ panel	Hide/display the PTZ panel.

Control a PTZ dome camera via the web browser

The web browser interface lets you control the PTZ functions of a dome camera. Click a PTZ dome camera and use the PTZ controls on the interface to control the PTZ functions.

Figure 31: PTZ controls

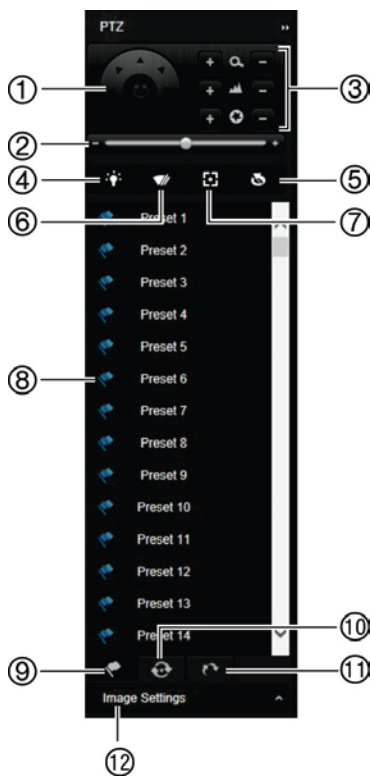

1. Directional pad/auto-scan buttons: Controls the movements and directions of the PTZ. Center button is used to start auto-pan by the PTZ dome camera.
2. Adjust speed of PTZ dome camera.
3. Adjust zoom, focus, and iris.
4. Turn on or off the camera light (if available on the camera).
5. Lens initialization: Initialize the lens of a camera with a motorized lens, such as PTZ or IP cameras. This function helps to maintain lens focus accuracy over prolonged periods of time.
6. Start or stop camera wiper (if available on the camera).
7. Auxiliary focus: Automatically focus the camera lens for the sharpest picture.
8. Start selected preset/tour/shadow tour (depending on function selected).
9. List presets available.
10. List preset tours available.
11. List shadow tours available.
12. Modify brightness, contrast, saturation, and hue values.







Play back recorded video









To search and play back recorded video, click Playback on the menu bar to display the Playback page shown in Figure 32 below.

Figure 32: Browser playback page



Description

1. Selected camera.
2. **Calendar:** Selected day is highlighted.
3. **Search:** Click to start searching recorded files for the selected camera.
4. **Display format:** Click to change the display format in the viewer: single view or multiview display.
5. **Timeline:** The timeline moves left (oldest video) to right (newest video). Click a location on the timeline to move the cursor to where you want playback to start.
6. **Playback control toolbar:**
 -  **Reverse:** Click to reverse playback.
 -  **Start/stop:** Start or stop playback.
 -  **Stop playback.** Timeline jumps back to 00:00:00 time (midnight) of the previous day.
 -  **Speed down:** Click to scroll through the different speeds available: single frame, 1/8 speed, 1/4 speed, 1/2 speed, normal, X2 speed, X4 speed, X8 speed, maximum speed. Current speed is displayed under the camera name on top right of window.
 -  **Speed up:** Click to scroll through the different speeds available: single frame, 1/8 speed, 1/4 speed, 1/2 speed, normal, X2 speed, X4 speed, X8 speed, maximum speed. Current speed is displayed under the camera name on top right of window.
 -  **Single frame:** Click to play back one frame at a time.
7.  **Stop streaming:** Stop streaming from all cameras.

Description	
8.	Audio and video control toolbar:
	Digital Zoom. Access digital zoom. See “Digital zoom in playback” on page 45 for further information.
	Text insertion: Click to enable/disable POS/ATM text display in playback.
	Snapshot: Capture a snapshot of the video.
	Video clips: Start/stop video clip during playback. Sections of a recording can be saved to an external storage device.
	Download: Download video clips.
	Backup: Click to make back up of recorded files to save locally on the recorder. A list of the recorded files appears
	Audio: Click to enable/disable audio.
	Bookmark management: Manage bookmarks.
9.	Jump start: Enter a precise time in the box and click the Go To button to jump start the playback to this selected time.
10.	Type of recording:
	Dark green: Indicates video recorded based on the recording schedule defined.
	Red: Indicates video recorded triggered by an alarm event.
	Yellow: Indicates video recorded triggered by motion detection.
	Blue: Indicates video recorded triggered by a POS/ATM text recording.
	Pale green: Indicates manually recorded video.

Select a camera and a day to search from on the calendar displayed, and then click Search. The timeline below the page indicates video recorded for the specified day. The timeline also classifies by color the type of recording with each type.

Click and drag the marker across the timeline on where you want video playback to begin, and then click Play on the playback control toolbar. You can capture a snapshot of a video image, save the video playback, or download the recorded video.

Search for event logs

The recorder compiles a log of events, such as the start or end of video recording, recorder notifications, and alarms, through which you can easily search. Logs are categorized by the following types:

- **Alarm:** Includes motion detection, tamper detection, video tampering, and other alarm events
- **Notifications:** Includes system notifications such as video loss, HDD failures, and other system-related events
- **Operations:** Includes users access to the web interfaces and other operational events

- **Information:** Includes general information on the recorder actions, such as the start and end of video recording, etc.

To search for logs, click Log on the menu bar, select a log type, specify a date and time range, and then click Search. See Figure 33 below for an example of the results of a log search. For further information on searching and viewing logs, go to “Search the system log” on page 118.

Figure 33: Results of a log search

No.	Log Time	Event	Type	Camera/Alarm/HDD No.	Local/Remote User	Remote Host IP
1	2014-11-14 14:54:50	Operation	Remote Logout		admin	192.168.222.101
2	2014-11-14 14:54:50	Operation	Remote Get Parameters		admin	192.168.222.101
3	2014-11-14 14:54:50	Operation	Remote Login		admin	192.168.222.101
4	2014-11-14 14:54:20	Operation	Remote Logout		admin	192.168.222.101
5	2014-11-14 14:54:20	Operation	Remote Get Parameters		admin	192.168.222.101
6	2014-11-14 14:54:20	Operation	Remote Login		admin	192.168.222.101
7	2014-11-14 14:48:45	Information	System Running State			0.0.0.0
8	2014-11-14 14:48:35	Information	System Running State			0.0.0.0
9	2014-11-14 14:48:35	Operation	Remote Get Parameters		admin	192.168.222.114
10	2014-11-14 14:48:58	Operation	Remote Get Parameters		admin	192.168.222.114
11	2014-11-14 14:48:20	Operation	Remote Logout		admin	192.168.222.101
12	2014-11-14 14:48:20	Operation	Remote Get Parameters		admin	192.168.222.101
13	2014-11-14 14:48:20	Operation	Remote Login		admin	192.168.222.101
14	2014-11-14 14:28:35	Information	System Running State			0.0.0.0
15	2014-11-14 14:28:25	Information	System Running State			0.0.0.0
16	2014-11-14 14:27:21	Information	HDD S.M.A.R.T.	2		0.0.0.0
17	2014-11-14 14:26:24	Information	System Running State			0.0.0.0
18	2014-11-14 14:08:14	Information	System Running State			0.0.0.0
19	2014-11-14 13:46:15	Information	System Running State			0.0.0.0
20	2014-11-14 13:48:05	Information	System Running State			0.0.0.0
21	2014-11-14 13:28:04	Information	System Running State			0.0.0.0
22	2014-11-14 13:27:54	Information	System Running State			0.0.0.0
23	2014-11-14 13:27:17	Information	HDD S.M.A.R.T.	2		0.0.0.0
24	2014-11-14 13:07:54	Information	System Running State			0.0.0.0
25	2014-11-14 13:07:44	Information	System Running State			0.0.0.0
26	2014-11-14 13:02:41	Operation	Remote Logout		admin	192.168.222.102
27	2014-11-14 13:02:41	Operation	Remote Get Parameters		admin	192.168.222.102
28	2014-11-14 13:02:41	Operation	Remote Login		admin	192.168.222.102
29	2014-11-14 12:47:45	Information	System Running State			0.0.0.0
30	2014-11-14 12:47:35	Information	System Running State			0.0.0.0
31	2014-11-14 12:27:54	Information	System Running State			0.0.0.0
32	2014-11-14 12:27:24	Information	System Running State			0.0.0.0
33	2014-11-14 12:27:15	Information	HDD S.M.A.R.T.	2		0.0.0.0
34	2014-11-14 12:07:24	Information	System Running State			0.0.0.0
35	2014-11-14 12:07:14	Information	System Running State			0.0.0.0
36	2014-11-14 11:47:14	Information	System Running State			0.0.0.0
37	2014-11-14 11:47:04	Information	System Running State			0.0.0.0
38	2014-11-14 11:28:01	Operation	Remote Playback by Time	A9	admin	192.168.222.104
39	2014-11-14 11:27:13	Information	HDD S.M.A.R.T.	2		0.0.0.0

Configure the recorder via the browser

Click **Configuration** on the menu toolbar to display the configuration window. There are two ways to configure the recorder: Local and Remote.

Camera management

Camera configuration lets you define communication and network parameters such as protocol type, maximum file size, stream type and network transmission settings. You can also specify the directory locations for saving recorded and playback video, captured images, and downloaded files.

Remote configuration

See Figure 34 on page 128 for an example of the Configuration screen. See Table 19 on page 128 for an overview of the different browser menu functions. Please refer to the specific sections on the OSD menu functions for more information on configuring these functions.

Menu	Function	Description
		information.
	V-stream Encoding	Define the v-stream parameters. See “V-stream encoding” on page 74 for more information.
Network Settings	Network Settings	Define the general network settings. See “Network settings” on page 76 for more information.
	PPPoE	Define the PPPoE settings. See “PPPoE settings” on page 78 for more information.
	DDNS	Define the DDNS settings. See “DDNS settings” on page 79 for more information.
	NTC	Define the NTC server settings. See “NTP server settings” on page 80 for more information.
	Email	Define the settings to send an e-mail. See “E-mail settings” on page 81 for more information.
	FTP	Define the FTP settings. See “Configure an FTP server to store snapshots” on page 82 for more information.
	SNMP	Define the SNMP settings. See “SNMP settings” on page 82 for more information.
	UPnP	Enable this function so that the recorder can automatically configure its own port forwarding. See “UPnP settings” on page 83 for more information.
	More Settings	Define a multicast IP as well as the server, HTTP, and RTSP ports. See page 76.
	Net Statistics	Check the bandwidth being used by remote live view and playback. See “Network statistics” on page 85 for more information.
Recording	Recording Schedule	Define the recording schedules. See “Recording schedule” on page 86 for more information.
	Manual Recording	Define which cameras can manually record. See “Manual recording” on page 89 for more information.
Alarm & Event Setup	Alarm Input	Define the alarm input parameters for when an external alarm is triggered. See “Set up alarm inputs” on page 90 for more information.
	Alarm Output	Define the response when an external alarm is triggered. See “Manual trigger” on page 92 for more information.
	Manual Trigger	Define the manually trigger outputs of the recorder. See “Manual trigger” on page 92 for further information.
	Buzzer Settings	Define the warning buzzer time. See “Buzzer” on page 92 for more information.
	Notifications	Define the notification parameters when irregular events occur, such as a HDD is full. See “Alarm notification types” on page 93 for more information.
	Video Loss	Define the video loss detection settings. See “Detect video loss” on page 94 for more information.
	Alarm Host Setup	Define the remote alarm host. See “Remote alarm host setup” on page 95 for more information.

Menu	Function	Description
Device Management	Time & Date Setting	Define time and date. See “Time and date” on page 96 for more information.
	General Settings	Define the general settings of the recorder such as language, device name, enable the wizard, menu timeout, and enable front panel lock. See “General recorder settings” on page 98 for more information.
	Configuration Files	Import/export configuration settings, restore default factory settings, and restart the recorder. See “Configuration files” on page 99 for more information.
	Upgrade Firmware	Upgrade the recorder firmware. See “Upgrade system firmware” on page 100 for more information.
	Holiday	Define how recordings occur during holiday periods. See “Holiday schedules” on page 100 for more information.
	Text Insertion	Define access device, access mode, and start string. See “Text insertion” on page 101 for more information.
	RS-232 Settings	Define the RS-232 parameters. See “Configure the RS-232 port” on page 102 for more information.
Storage Management	HDD Information	Define the HDD basic settings and initialize the HDD. See “HDD information” on page 104 and “Initialize a HDD” on page 104 for more information.
	Storage Mode	Define the storage mode of the HDD. See “Storage mode” on page 105 and “Group HDDs” on page 106 for more information.
	S.M.A.R.T. Settings	List the S.M.A.R.T. information on the HDD. See “S.M.A.R.T. settings” on page 107 for more information.
User Management	Users	Define, modify, and delete users. See Chapter 16 “User management” on page 110 for more information.
System Information	Device Info	Review the status of the device. See Chapter 17 “information” on page 115 for more information.
	Camera	Review the status of the cameras. See Chapter 17 “System information” on page 115 for more information.
	Record	Review the status of the recordings. See Chapter 17 “System information” on page 115 for more information.
	Alarm Input	Review the status of the alarm inputs. See Chapter 17 “System information” on page 115 for more information.
	Alarm Output	Review the status of the alarm outputs. See Chapter 17 “System information” on page 115 for more information.
	Network	Review the status of the network. See Chapter 17 “System information” on page 115 for more information.

Text overlay

You can add up to four lines of text on screen via the browser. This option can be used, for example, to display emergency contact details. By default these lines of text are positioned along the top of the screen. The strings follow each other consecutively.

Note: This option is not available via the recorder.

To add on-screen overlay text:

1. Click the **Configuration** tab in the browser toolbar and then select **Camera Settings > Text Overlay**.
2. Select the desired camera.
3. Check the string box **1** for the first line of text.
4. Enter the text for string 1 in the column alongside. Up to 44 alphanumeric characters can be used.
5. Repeat steps 3 and 4 for each extra line of text, selecting the next string number.
6. Click **Save**.

Appendix A

Specifications

	TVR 1204HD	TVR 1208HD	TVR 1216HD
Video & audio input			
Video compression	H.264		
Analog video input	4-ch, BNC (1.0 Vp-p, 75 Ω), PAL /NTSC self- adaptive	8-ch, BNC (1.0 Vp-p, 75 Ω), PAL /NTSC self- adaptive	16-ch, BNC (1.0 Vp-p, 75 Ω), PAL /NTSC self- adaptive
Audio compression	G711u		
Audio input	4-ch, RCA (2.0 Vp-p, 1 kΩ)		
Two-way audio	1-ch (reduplicated with audio input 1), RCA (2.0 Vp-p, 1 kΩ)		
Video & audio output			
HDMI output	1-ch, Resolution: 1920 × 1080P / 60 Hz, 1280 × 1024 / 60 Hz, 1280 × 720 / 60 Hz, 1024 × 768 / 60 Hz		
VGA output	1-ch, Resolution: 1920 × 1080P / 60 Hz, 1280 × 1024 / 60 Hz, 1280 × 720 / 60 Hz, 1024 × 768 / 60 Hz		
Analog output	1-ch, BNC (1.0 Vp-p, 75 Ω), Resolution: PAL: 704 × 576; NTSC: 704 × 480		
Video loop output	4-ch	8-ch	16-ch
Encoding resolution	Main stream: 1080P (non-real time) / 720P / VGA / WD1 / 4CIF / CIF Substream: WD1 (non-real time) / 4CIF (non-real time) / CIF / QCIF / QVGA		
Video bit rate	32 Kbps to 6 Mbps		
Audio output	1-ch, RCA		
Audio bit rate	64 Kbps		
Dual-stream	Support (Sub-stream at CIF: 6 fps, QCIF: 25 fps (PAL) / 30 fps (NTSC))		
Stream type	Video, Video & Audio		
Playback resolution	4CIF / 2CIF / CIF / QCIF		
Synchronous playback	4-ch	8-ch	16-ch

	TVR 1204HD	TVR 1208HD	TVR 1216HD
Hard disk			
SATA	1 SATA interface		2 SATA interfaces
Capacity	Up to 4TB capacity for each disk		
External interface			
Network interface	1 RJ45 10M / 100M self-adaptive Ethernet interface		1 RJ45 10M / 100M / 1000M self-adaptive Ethernet interface
Serial interface	1 RS-232 interface (for ProBridge, Challenger, Technical Support); 1 RS-485 interface (for PTZ control or KTD405 keyboard control)		
USB interface	2, USB 2.0		
Alarm in	4		
Alarm out	1		
Miscellaneous			
Power supply	12 VDC		
Power consumption (without HDD or DVD-R/W)	≤ 15 W	≤ 20 W	≤ 20 W
Operating temperature	-10 to +55 °C (14 to 131 °F)		
Relative humidity	10 to 90%		
Chassis	1U chassis		380 mm 1chassis
Dimensions (W x H x D)	315 x 242 x 45 mm (12.4 x 9.5 x 1.8 in.)		380 x 290 x 48 mm (15.0 x 11.4 x 1.9 in.)
Weight	≤ 1.5 kg (3.3 lb.)		≤ 2 kg (4.4 lb.)

Appendix B

PTZ protocols

Interlogix-485

Interlogix-422

KALATEL

DSCP

HIKVISION

Honeywell

INFINOVA

KTD-348

LG MULTIX

LILIN

Appendix C

Port forwarding information

A router is a device that lets you share your internet connection between multiple computers. Most routers will not allow incoming traffic to the device unless you have configured them to forward the necessary ports to that device. By default our software and recorders require the following ports to be forwarded:

Note: Port forwarding may reduce the security of the computers on your network. Please contact your network administrator or a qualified network technician for further information.

Port: 80	HTTP protocol	Used to connect via IE browser.
Port: 8000	Client Software Port	Used to connect to video streams.
Port: 554	RTSP Port	Real time streaming protocol. Used to record video remotely.
Port: 1024	RTSP Port for 3G/4G	Use with mobile apps. Used for 3G/4G connection.

Note: It is recommended that the RTSP port 1024 should only be used when experiencing connection issues over a 3G/4G connection.

Seeking further assistance

Third-party assistance on configuring popular routers can be found at:

<http://www.portforward.com/>

<http://canyouseeme.org/>

<http://yougetsignal.com>

Note: These links are not affiliated with nor supported by Interlogix technical support.

Many router manufacturers also offer guides on their websites as well as including documentation with the product.

On most routers the brand and model number is located on or near the serial number sticker on the bottom of the device.

If you cannot find any information for your particular router, please contact your router manufacturer or internet service provider for further assistance.

Appendix D

Connect a PTZ dome camera

Any PTZ dome camera can be controlled as the recorder is doing the PTZ protocol translation. However, this setup provides only limited dome configuration. See Figure 4 below for how to connect a PTZ camera to the recorder.

Figure 35: Connecting a PTZ dome camera to the recorder for control over the network

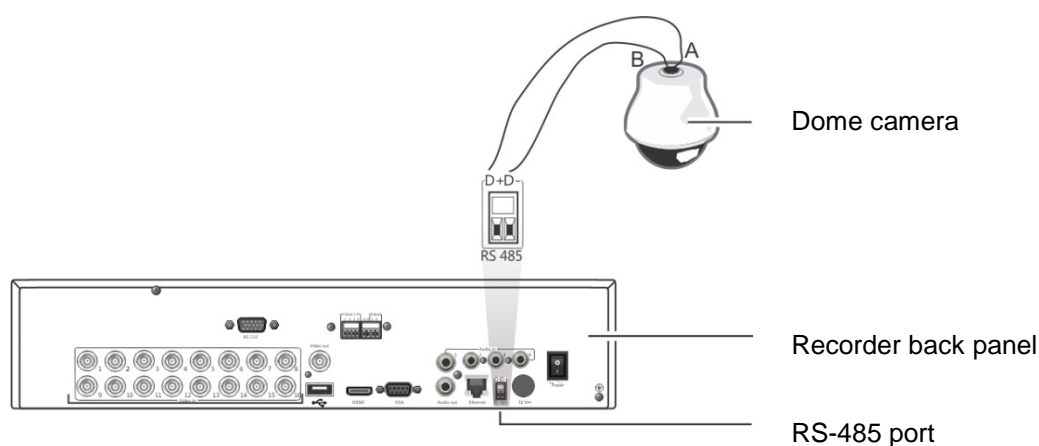

Configuring the PTZ protocols for Interlogix cameras

Before the PTZ dome cameras are assembled in their housings, set their protocol and address DIP switches for the recorder. See Table 20 on page 138 for different Interlogix PTZ dome camera settings.

If you are using PTZ dome cameras from another company, please refer to their configuration instructions.

Table 20: PTZ protocols for Interlogix cameras

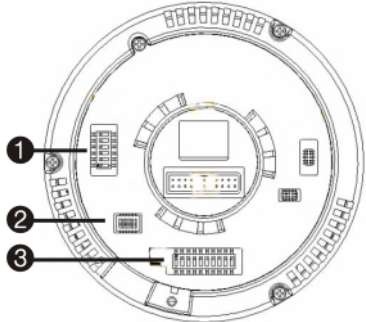
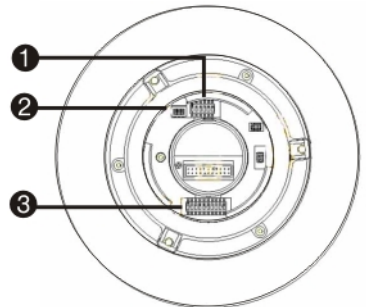
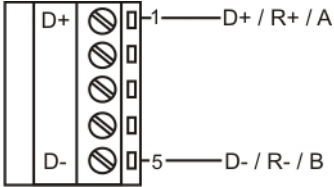
Camera	Switch setting	
TruVision Mini PTZ 12X: Indoor Dome	Protocol DIP switches:	
	<ul style="list-style-type: none"> RS-485 (on recorder): 000000 RS-422 (on I/O box): 100000 	
	RS-485 communication DIP switches:	110000
	Camera ID DIP switches:	Select the camera ID DIP switch address as required
	RS-422/RS-485 data connector:	
		
	<ol style="list-style-type: none"> 1. Protocol DIP switches 2. RS-485 communication DIP switches 3. Camera ID DIP switches 	
TruVision Mini PTZ 12X: Outdoor Dome	Protocol DIP switches:	
	<ul style="list-style-type: none"> RS-485 (on recorder): 000000 RS-422 (on I/O box): 100000 	
	RS-485 communication DIP switches:	110000
	Camera ID DIP switches:	Select the camera ID DIP switch address as required.
	RS-422/RS-485 data connector:	
		
	<ol style="list-style-type: none"> 1. Protocol DIP switches 2. RS-485 communication DIP switches 3. Camera ID DIP switches 	
		

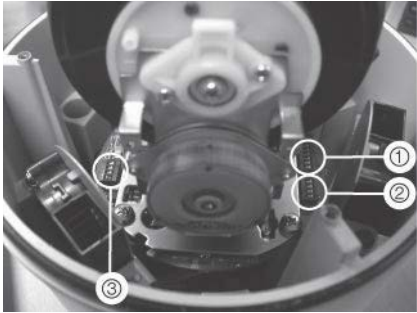
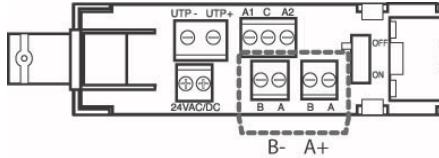
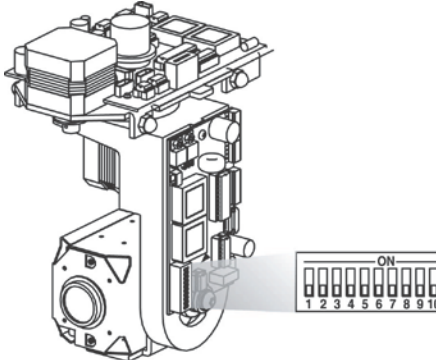
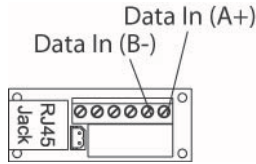
Camera	Switch setting		
TruVision Dome 16X PTZ	Protocol switches:	0111	 <p>1. Address switches; 2. Baud switches; 3. Protocol switches</p>
	<ul style="list-style-type: none"> • RS-485 (on recorder): • RS-422 (on I/O box): 	1111	
	Address switches:	Select the camera ID DIP switch address as required.	
	Baud rate:	0000 = 9600 bps 0011 = 4800 bps	
	RS-422/RS-485 data connector:		
CyberDome	Protocol switches:	NA	
	Address switches:	Select the camera ID DIP switch address as required.	
	RS-485 data connector:		

Camera	Switch setting
UltraView PTZ	<p>Protocol switches:</p> <ul style="list-style-type: none"> RS-485 (on recorder): 01000 RS-422 (on I/O box): 10000 <hr/> <p>Address switches: Select the address switch address as required.</p>

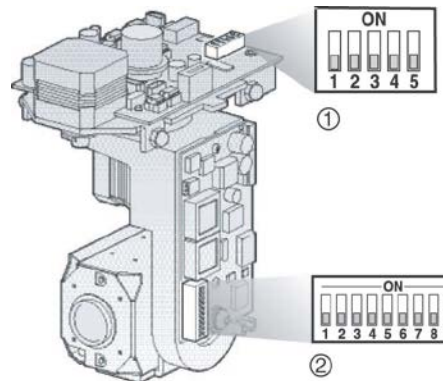

1. Protocol switches;
2. Address switches

RS-422/RS-485 data connector:

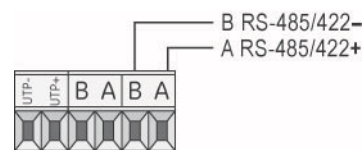

Legend	<p>Protocol switches: 1</p> <ul style="list-style-type: none"> RS-485 on recorder): RS-422 (on I/O box): <p>Address switches: Select the camera ID DIP switch address as required.</p>
--------	--

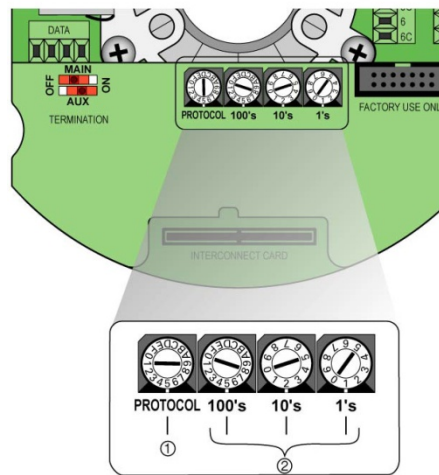

RS-422/RS-485 data connector:

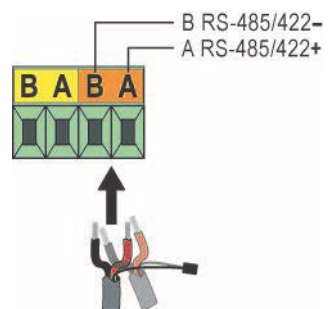

Appendix E

KTD-405 keypad

Supported firmware

TVR 12XX-YYY firmware	1.0i or higher
KTD-405U (-2DU) keypad firmware:	1.4.00

Note: XXX represents the number of video channels.

YYY represents the recorder storage configuration such as 1T = 1 TB, etc.

Wiring the keypad

Connect the RS-485 bus of the KTD-405 I/O box to the recorder keypad terminal port.

Table 21: Keypad and recorder connections

KTD-405 I/O box	TVR 12 connection
RS-485 A	D+
RS-485 B	D-

Figure 36: Keypad and recorder connections

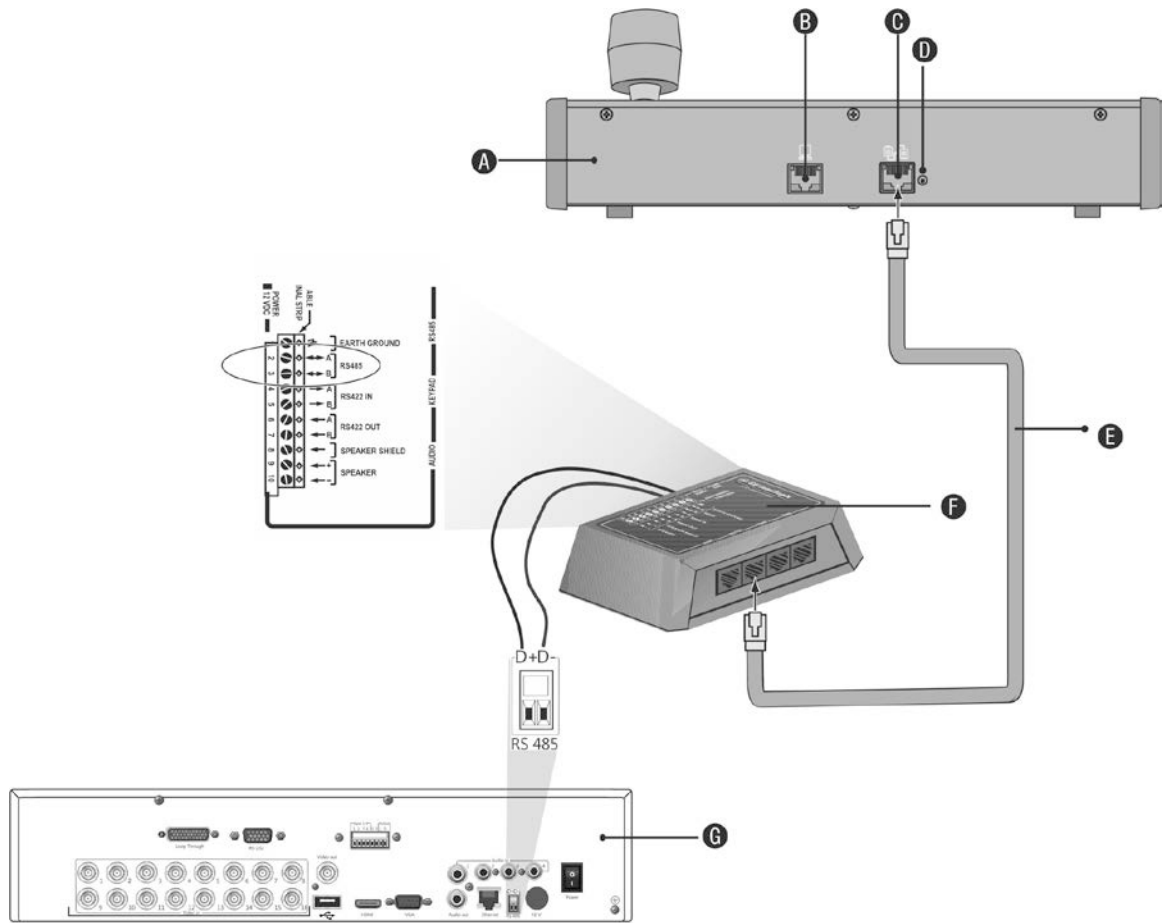

- A. KTD-405 keypad
- B. RS-232 programming port
- C. RS-485 and RS-422 in/out
- D. RS-485 termination switch
- E. RJ45 cable control (use the cable provided with the equipment)
- F. I/O box
- G. Recorder back panel

See “Connecting a KTD-405 keypad and dome camera to the recorder” on page 148 for information on how to connect both a keypad and dome camera to the recorder.

Setting the keypad to work with the recorder

The keypad must be in zone mode to connect correctly with the recorder.

Further information on connecting and programming the KTD-405 keypad can be found in the user manual.

To set the keypad in zone mode:

1. Log into the keypad using the Admin password. Hold down the Enter button (↵) until a beep sounds and then enter the following code: 1 4 7 6. Push the **seq** button to confirm.

2. Scroll through the menus with the **▶** button until this menu appears:

```
OPERATING MODE:
DIGIPLEX
```

3. Change *Operating Mode* to *Zone* by moving the joystick down.
4. Quit the menu by pressing the **seq** button. The display will show, for example:

```
ZONE --ZONE TITLE
CAMERA --MONITOR
```

5. To connect it to the recorder, press the **zone** button and enter the ID number of the recorder. The default value is "1".
6. To configure the recorder zone ID number, at the recorder enter the Monitor screen by selecting **Display Mode Settings** in the main menu and select Monitor. Under Zone ID, enter the zone ID value. The default value is "1".

Note: The zone ID value must be identical for the recorder and keypad.

The recorder is now connected to the KTD-405 keypad.

Recorder and keypad functions

The KTD-405U acts as a recorder control keypad when connected to the recorder. The keypad mimics many of the functions available from the front panel of the recorder.

Unavailable recorder functions

The following TVR 12 functions are unavailable when using the keypad to control the recorder:

- Export video
- -Shadow tour
- Select motion detection or tampering zones
- Archive records
- Capture video

If these functions are required, it is recommended to use a mouse in conjunction with the keypad as all recorder functions will then be available.

Unavailable keypad functions

The following keypad buttons are unavailable when using the keypad to control the recorder:

Figure 37: Unavailable keypad buttons

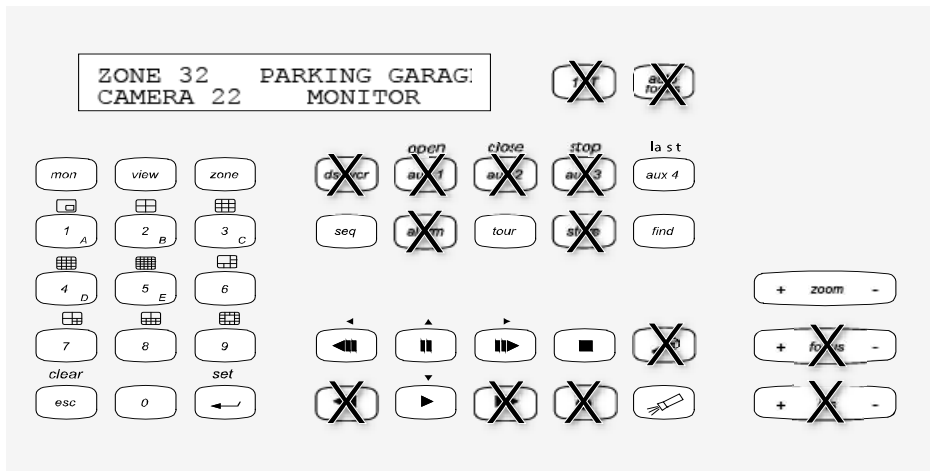

DSC/VCR	Autofocus	● (Record mode)
Aux 1	Alarm	Store
Aux 2	Iris +/-	▶▶ Fast forward
Aux 3	Focus +/-	◀◀ Fast backward
Aux 4	🔍 (Magnification)	
Ist		

Operating the keypad

You can navigate the recorder menus using the keypad buttons and joystick. However, not all maneuvers are available using the joystick.

See Table 22 on page 145 for the description of the recorder keypad mapping when using the KTD-405 keypad series. See Figure 38 above for a list of the keypad functions that are unavailable when connected to the recorder.

Example 1: To enter your password in the login window using the keypad

1. In live view mode, press **esc** to activate the Login window.
2. Press and hold **esc** and then press the arrow buttons (⏴ **down**, ⏵ **up**, ⏴ **left**, ⏵ **right**) to move the cursor to the Password edit box. Once in the password box, release **esc**.
3. Press **Enter** (↵) to activate the soft keyboard.
4. Press and hold **esc** and then press the arrow buttons to reach the first digit of the password. Release **esc** and press **Enter** (↵) to select the digit.
Or move the joystick to the first digit of the password and press **Enter** (↵).
5. Repeat steps 2 to 4 for each digit of the password.

6. Move the cursor to the Enter button on the soft keyboard and press **Enter** (↵) on the KTD-405 keypad to quit the soft keyboard.
7. Press and hold **esc** and then press the arrow buttons to navigate the cursor to activate OK button on the Login screen.
8. Press ↵. The main menu appears.









Example 2: To modify a menu option using the keypad







1. In the main menu press and hold **esc** and then press the arrow buttons to navigate to the desired menu icon (for example, Display Mode Settings).
2. Press **esc** and  to go to **Display Mode Settings** menu.
3. Press **Zoom +** or **Zoom -** to scroll to the menu tab, **More Settings**.
4. When in the desired menu window, press and hold **esc** and then press the arrow buttons to navigate the cursor to the option, **Menu Timeout**.
5. Press ↵ to activate the dropdown menu.
6. Press and hold **esc** and then press the up/down arrow buttons to navigate to the desired option.
7. Press ↵ to select the option.
8. Press and hold **esc** and then press the up/down arrow buttons to navigate to **Apply**. Press ↵ to select it. Then navigate to **Back** to return to live view.

Instead of the arrow buttons, you can also use the joystick on the keyboard.

Recorder mapping to the KTD-405 keypad

Table 22: Recorder mapping to the KTD-405 keypad

Task	Keypad action	Further information
• Menu mode		
Call up or exit menu	In live view, press esc .	To log out the menu: go to the Power Manager menu and select Logout.
Move through the menus	Press and hold esc and then press the arrow buttons or use the joystick.	 Down ,  Up ,  Left ,  Right
Move between menu tabs	Press seq to switch between menu tabs.	
Navigate to a menu option	Press and hold esc and then press the arrow buttons or use the joystick.	 Down ,  Up ,  Left ,  Right
Select a character or menu option	Press Enter (↵).	Note. If you press esc before pressing Enter , you quit the menu without saving any changes. It is the same as Cancel.
Select the zone ID	Press zone to connect the keypad to the recorder.	

Task	Keypad action	Further information
• Live view mode		
Call up a single camera	Press 0 to 9 and then press Enter (↵).	Using the numeric buttons 0 to 9 , enter the number of the camera and then press Enter (↵).
Call up multiview screens	Press view and then press button 5 to scroll through the next available multiview screen.	
Sequence through cameras	Press the seq button to scroll through the cameras in full screen.	
Switch to next/previous camera	Move the joystick to the right (= next camera), or the left (=previous camera).	
Switch between monitor A and monitor B	Press the mon button and button 1 to switch to monitor A. Press the mon button and button 2 to switch to monitor B.	
Manually acknowledge an alarm	Press Alarm .	
• PTZ functions		
Enter PTZ mode	In live view mode, press Enter (↵).	It is possible that you first need to login before you can access the PTZ mode.
PTZ functions (Up, Down, Left, Right, Zoom in, Zoom out)	Move the joystick to move the dome up, down, left and right Press zoom+ and zoom- .	KTD-405U: Turn the knob on the joystick to zoom in/zoom out. KTD-405-2DU: Press the zoom+ and zoom- buttons.
Leave PTZ mode	Press esc .	
• Playback functions		
Search for recorded video	Press  .	Once password is entered, the Advanced Search menu appears.
24-hour playback	Press  when in full screen.	24-hour playback of the currently selected camera.
Stop playback	Press  to stop playback and return to live view mode.	
Pause playback	Press  to pause playback. Press  to restart.	
Select one of the files in the search result screen	Press enter (↵) and move the joystick to the desired file. Press  to start playback.	

Task	Keypad action	Further information
Change playback speed	Press and hold esc and then press the left/right arrow buttons or move the joystick to the left/right.	
Jump 30 seconds forwards or backwards during playback	Press and hold esc and then press the up/down arrow buttons or move the joystick to the left/right.	

Controlling a camera

When setting up and controlling your cameras in zone mode, refer to Table 23 below for the list of default PTZ addresses associated with a zone ID. This value is automatically populated in the system. You can modify the PTZ address in the PTZ menu to meet customer requirements (see “Configuring PTZ settings” on page 70).

Table 23: Default PTZ camera addresses by zone ID

Camera input	Zone ID of TVR 12															
	1	2	3	4	5	6	7	8	9	10	11	12	13	14	15	16
1	0	32	64	96	128	160	192	224	256	288	320	352	384	416	448	480
2	1	33	65	97	129	161	193	225	257	289	321	353	385	417	449	481
3	2	34	66	98	130	162	194	226	258	290	322	354	386	418	450	482
4	3	35	67	99	131	163	195	227	259	291	323	355	387	419	451	483
5	4	36	68	100	132	164	196	228	260	292	324	356	388	420	452	484
6	5	37	69	101	133	165	197	229	261	293	325	357	389	421	453	485
7	6	38	70	102	134	166	198	230	262	294	326	358	390	422	454	486
8	7	39	71	103	135	167	199	231	263	295	327	359	391	423	455	487
9	8	40	72	104	136	168	200	232	264	296	328	360	392	424	456	488
10	9	41	73	105	137	169	201	233	265	297	329	361	393	425	457	489
11	10	42	74	106	138	170	202	234	266	298	330	362	394	426	458	490
12	11	43	75	107	139	171	203	235	267	299	331	363	395	427	459	491
13	12	44	76	108	140	172	204	236	268	300	332	364	396	428	460	492
14	13	45	77	109	141	173	205	237	269	301	333	365	397	429	461	493
15	14	46	78	110	142	174	206	238	270	302	334	366	398	430	462	494
16	15	447	79	111	143	175	207	239	271	303	335	367	399	431	463	495
17	16	48	80	112	144	176	208	240	272	304	336	368	400	432	464	496
18	17	49	81	113	145	177	209	241	273	305	337	369	401	433	465	497
19	18	50	82	114	146	178	210	242	274	306	338	370	402	434	466	498
20	19	51	83	115	147	179	211	243	275	307	339	371	403	435	467	499

Camera input	Zone ID of TVR 12															
	1	2	3	4	5	6	7	8	9	10	11	12	13	14	15	16
21	20	52	84	116	148	180	212	244	276	308	340	372	404	436	468	500
22	21	53	85	117	149	181	213	245	277	309	341	373	405	437	469	501
23	22	54	86	118	150	182	214	246	278	310	342	374	406	438	470	502
24	23	55	87	119	151	183	215	247	279	311	343	375	407	439	471	503
25	24	56	88	120	152	184	216	248	280	312	344	376	408	440	472	504
26	25	57	89	121	153	185	217	249	281	313	345	377	409	441	473	505
27	26	58	90	122	154	186	218	250	282	314	346	378	410	442	474	506
28	27	59	91	123	155	187	219	251	283	315	347	379	411	443	475	507
29	28	60	92	124	156	188	220	252	284	316	348	380	412	444	476	508
30	29	61	93	125	157	189	221	253	285	317	349	381	413	445	477	509
31	30	62	94	126	158	190	222	254	286	318	350	382	414	446	478	510
32	31	63	95	127	159	191	223	255	287	319	351	383	415	447	479	511

Connecting a KTD-405 keypad and dome camera to the recorder

Use the input/output box that is supplied with the keypad to connect the KTD-405 keypad to the recorder.

As the KTD-405 keypad uses full duplex data communication, you cannot connect the both keypad and a dome camera directly to the recorder from the RS-485 port as this could cause problems on the bus. If both devices are required, it is recommended that you use the keypad's RS-422 connection to connect the dome camera and the keypad's RS-485 connection to connect the recorder. See Figure 5 as well as Table 4 and Table 5 below.

Note: These connections only work with UTC PTZ protocols (see Appendix B "PTZ protocols" on page 134). If you are using another manufacturer's PTZ protocol, it is not possible to connect both a keypad and dome camera to the recorder.

Figure 38: Connecting a PTZ dome camera and KTD-405 keypad to the recorder

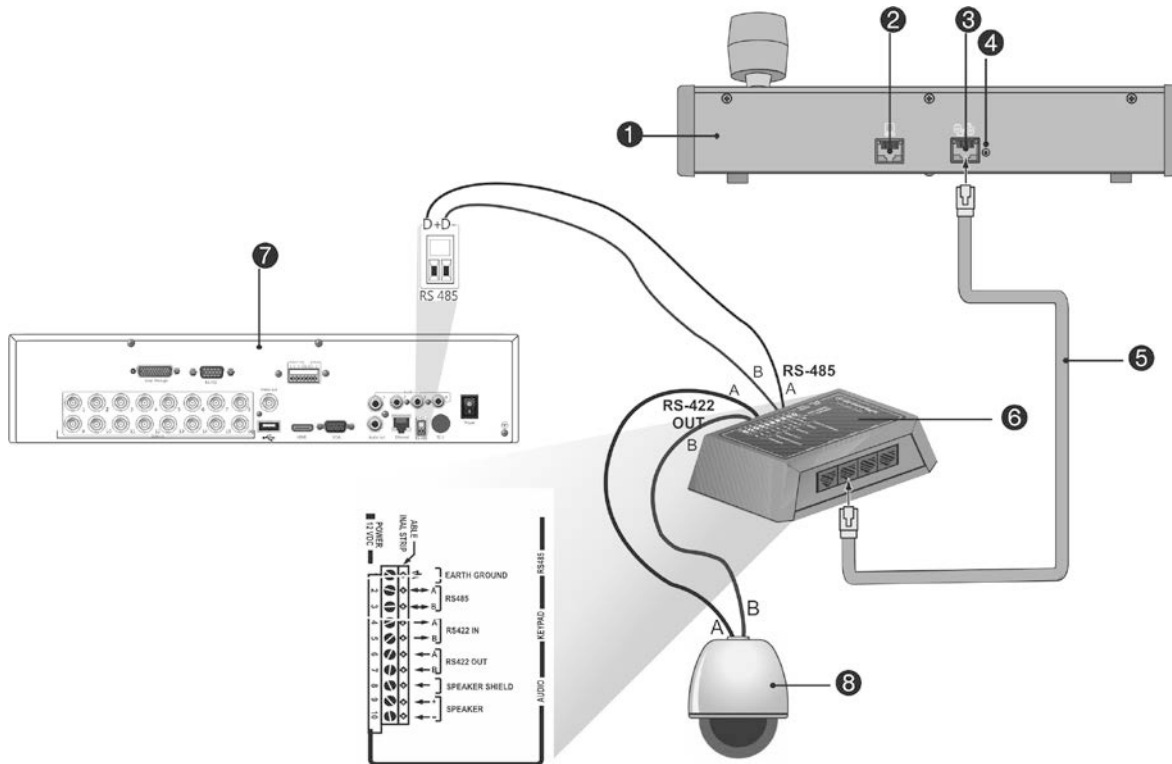

- 1. KTD-405 keypad
- 2. RS-232 programming port
- 3. RS-485 and RS-422 in/out
- 4. RS-485 termination switch
- 5. RJ45 cable control (use the cable provided with the equipment)
- 6. I/O box
- 7. Recorder back panel
- 8. Dome camera

Table 24: UTC PTZ protocol settings

Dome: RS-422 protocol	TVR 12: Interlogix RS-485
-----------------------	---------------------------

See Table 5 below for the bus addresses to consider when connecting a both keypad and dome camera to the recorder.

Table 25: Bus addresses

Recorder bus address	Recorder video inputs	PTZ address range
1	1-32	00-31
2	1-32	32-63
3	1-32	64-95
4	1-32	96-127
5	1-32	128-159
6	1-32	160-191
7	1-32	192-223
8	1-32	224-255

Appendix F

Maximum pre-recording times

The maximum pre-recording time that can be selected depends on the bit rate. Frame rate, resolution and image quality do not impact time.

Note: This information only applies when the bit rate is set to Constant (see “Initializing the recording settings” on page 62 for more information).

Constant bit rate	Maximum pre-recording time (seconds)
32	30
48	30
64	30
80	30
96	30
128	30
160	30
192	30
224	30
256	30
320	30
384	30
448	30
512	30
640	30
768	30
896	30
1024	30
1280	25

Constant bit rate	Maximum pre-recording time (seconds)
1536	20
1792	15
2048	15
3072	10
4096	5

Appendix G

Supported PTZ commands

Table 26: Supported PTZ commands by camera protocols (Part 1)

Protocol	PTZ command												
	Tilt up	Tilt down	Pan left	Pan right	Left up	Left down	Right up	Right down	Auto pan	Zoom +	Zoom -	Focus +	Focus -
Interlogix-485	Y	Y	Y	Y	N	N	N	N	N	Y	Y	Y	Y
Interlogix-422	Y	Y	Y	Y	N	N	N	N	N	Y	Y	Y	Y
KALATEL	Y	Y	Y	Y	N	N	N	N	N	Y	Y	Y	Y
DSCP	Y	Y	Y	Y	N	N	N	N	N	Y	Y	Y	Y
HIKVISION	Y	Y	Y	Y	Y	Y	Y	Y	Y	Y	Y	Y	Y
Honeywell	Y	Y	Y	Y	N	N	N	N	N	Y	Y	Y	Y
INFINOVA	Y	Y	Y	Y	N	N	N	N	N	Y	Y	Y	Y
KTD-348	Y	Y	Y	Y	N	N	N	N	N	Y	Y	Y	Y
LG MULTIX	Y	Y	Y	Y	N	N	N	N	N	Y	Y	Y	Y
LILIN	Y	Y	Y	Y	N	N	N	N	N	Y	Y	Y	Y
PANASONIC_CS850	Y	Y	Y	Y	N	N	N	N	N	Y	Y	Y	Y
PELCO-D	Y	Y	Y	Y	Y*	Y*	Y*	Y*	Y	Y	Y	Y	Y
PELCO-P	Y	Y	Y	Y	Y*	Y*	Y*	Y*	Y	Y	Y	Y	Y
PHILIPS	Y	Y	Y	Y	N	N	N	N	N	Y	Y	Y	Y
PHILIPS-3	Y	Y	Y	Y	N	N	N	N	N	Y	Y	Y	Y
SAE	Y	Y	Y	Y	N	N	N	N	N	Y	Y	Y	Y
Samsung	Y	Y	Y	Y	N	N	N	N	N	Y	Y	Y	Y
Siemens	Y	Y	Y	Y	N	N	N	N	N	Y	Y	Y	Y
SONY-EVI-D30/31	Y	Y	Y	Y	N	N	N	N	N	N	N	N	N
SONY-EVI-D70	Y	Y	Y	Y	N	N	N	N	N	N	N	N	N
SONY-EVI-D100/P	Y	Y	Y	Y	N	N	N	N	N	N	N	N	N
TECHWIN	Y	Y	Y	Y	N	N	N	N	N	N	N	N	N

Protocol	PTZ command												
	Tilt up	Tilt down	Pan left	Pan right	Left up	Left down	Right up	Right down	Auto pan	Zoom +	Zoom -	Focus +	Focus -
VICON	Y	Y	Y	Y	N	N	N	N	N	Y	Y	Y	Y
YOULI	Y	Y	Y	Y	N	N	N	N	N	Y	Y	Y	Y

*: Hikvision only.

Table 27: Supported PTZ commands by camera protocols (Part 2)

Protocol	PTZ command										
	Iris+	Iris-	Light	Wiper	Zoom area	Center	Menu	Preset	Tour	Shadow tour	
Interlogix-485	Y	Y	N	N	N	N	N	Y	N	Y	
Interlogix-422	Y	Y	N	N	N	N	N	Y	N	Y	
KALATEL	Y	Y	N	N	N	N	N	Y	N	Y	
DSCP	Y	Y	N	N	N	N	N	Y	N	Y	
HIKVISION	Y	Y	N	N	Y	Y	Y	Y	Y	Y	
Honeywell	Y	Y	N	N	N	N	N	N	N	N	
INFINOVA	Y	Y	N	N	N	N	N	Y	N	Y	
KTD-348	Y	Y	N	N	N	N	N	Y	N	Y	
LG MULTIX	Y	Y	N	N	N	N	N	Y	Y	Y	
LILIN	Y	Y	N	N	N	N	N	N	N	N	
PANASONIC_CS850	Y	Y	N	N	N	N	N	Y	N	Y	
PELCO-D	Y	Y	Y**	Y#	N	N	N	Y	Y	Y	
PELCO-P	Y	Y	N	N	N	N	N	Y	Y	Y	
PHILIPS	Y	Y	N	N	N	N	N	N	N	N	
PHILIPS-3	Y	Y	N	N	N	N	N	N	N	N	
SAE	Y	Y	N	N	N	N	N	Y	Y	Y	
Samsung	Y	Y	N	N	N	N	N	Y	N	Y	
Siemens	Y	Y	N	N	N	N	N	Y	N	Y	
SONY-EVI-D30/31	N	N	N	N	N	N	N	N	N	N	
SONY-EVI-D70	N	N	N	N	N	N	N	N	N	N	
SONY-EVI-D100/P	N	N	N	N	N	N	N	N	N	N	
TECHWIN	Y	Y	N	N	N	N	N	Y	N	N	
VICON	Y	Y	N	N	N	N	N	N	N	N	
YOULI	Y	Y	N	N	N	N	N	Y	N	N	

** : Aux. 2

: Aux. 1

Appendix H

Default menu settings

Display Settings	
Display	
General	
	Monitor Video Format: NTSC/PAL. Auto detect at booting.
	Picture Setting: Standard
	BNC Output Brightness: (Null)
	Resolution: (Null)
	Display Status Icons: Yes
	Time Bar Transparent: (Null)
	Enable Timebar: Yes
	Video Output Interface: VGA/HDMI
	Default View: 2*2 (for 4-ch models), 3*3 (for 8-ch models), and 4*4 (16-ch models)
	Sequence Dwell Time: No switch
	Enable Audio Output: No
	Event Monitor: VGA/HDMI
	Event Full-Screen Monitoring Dwell Time: 10
	Alarm Full-Screen Monitoring Dwell Time: 10
	Audio Output Linked To: VGA
Layout	
	Video Output Interface: VGA/HDMI
Camera Setup	
Analog Camera Overview	
Analog	
	Camera Number: (Null)
	Camera Name: (Null)
	Status: (Null)
	Live View: (Null)

IP Camera Status	
IP Camera	Camera No., Status, Edit, Advanced Set, Live View, Camera Name, IP Camera Address, Manage Port, Protocol, Device Model, Serial Number, and Firmware
Camera Recording Settings	
Record	Camera Name: Analog 1 Record Stream Mode: Main Stream (TL-Hi) Stream Type: Video & Audio Resolution: 960*576 (960H) Bit Rate: Variable Video Quality: Medium Frame Rate: 12fps Max. Bitrate Mode: General Max Bitrate (Kbps): 2048 Pre Event: 5 s Post Event: 5 s Auto Delete (day): 0 Record Audio: Yes
Snapshots	
Snapshot	Camera: Analog 1 Resolution: 352*288 (CIF) Snapshot quality: Medium
Camera OSD	
Camera OSD Settings	Camera: Analog 1 Camera Name: Camera 01 Display Name: Yes Display Date: Yes Display Day: Yes Date Format: MM-DD-YYYY Time Format: 12-hour Display Mode: Non-transparent & Not Flashing OSD font: 32*32

Image	
	Image Settings
	Camera: Analog 1
	Image Setting: Standard
	Brightness: 128
	Contrast: 128
	Saturation: 128
	Hue: 128
	Sharpness: 1
	Digital Noise: 2
Motion Detection	
	Motion Detection Settings
	Camera: Analog 1
	Enable Motion Detection: No
	Actions: Trigger Channel [camera-self]; Arming Schedule - All day for whole week; Actions: (Null)
	Sensitivity: 3
	Target size: 1
	Zone: Full Screen
Privacy Mask	
	Privacy Mask Settings
	Camera: Analog 1
	Enable Privacy Mask: No
	Zone: (Null)
Camera Tamper	
	Camera Tamper Settings
	Camera: Analog 1
	Enable Camera Tamper: No
	Actions: Arming Schedule - All day for whole week; Actions: (Null)
	Sensitivity: 0
Restricted Access Camera	
	Restricted Access Camera Settings
	Cameras: (Null)
PTZ Setup	
	Settings
	Camera: Analog 1
	Baud Rate: 9600
	Date Bit: 8

		Stop Bit: 1
		Parity: None
		Flow Ctrl: None
		PTZ Protocol: Interlogix-485
		Address: 0 to 15 for camera 1 to 16
PTZ Preset/Tours		
	Preset/Tours	
		Camera: Analog 1
V-stream Encoding		
	V-stream Encoding	
		Enable V-stream Encoding: Yes
		Frame Rate: 12fps
		Max. Bitrate (Kbps): 1024
Networking Settings		
Network Settings		
	Network Settings	
		NIC Type: 10/100M Self-adaptive
		Enable DHCP: No
		IPv4 address: 192.168.1.82
		IPv4 Subnet Mask: 255.255.255.0
		IPv4 Default Gateway: 192.168.1.1
		IPv6 Address1: (Null)
		IPv6 Address2: (Null)
		IPv6 Address Gateway: (Null)
		Mac Address: (It depends)
		MTU: 1500
		Preferred DNS Server: (Null)
		Alternate DNS Server: (Null)
		Server Port: 8000
		HTTP Port: 80
		Multicast IP: (Null)
		RTSP Server Port: 554
		Enable Telnet: No
		Total Bandwidth Limit (Kbps): 61440
PPPoE		
	PPPoE	
		Enable PPPoE: Disable
		User Name: (Null)

		Password: (Null)
		Confirm: (Null)
DDNS		
	DDNS	
		DDNS: Disable
		DDNS Type: ezDDNS
		Server Address: www.tvr-ddns.net
		Host Name: (Null)
NTP		
	NTP	
		Enable NTP: Disable
		Interval (min): 60
		NTP Server: time.nist.gov
		NTP Port:123
Email		
	Email	
		Enable Server Authentication: Disable
		User Name: (Null)
		Password: (Null)
		SMTP Server: (Null)
		SMTP Port: 25
		Enable SSL: Disable
		Sender: (Null)
		Sender's Email Address: (Null)
		Select Receiver: Receiver 1
		Receiver Name: (Null)
		Receiver's Address: (Null)
		Include Snapshot: Disable
		Interval: Disable
FTP		
	FTP	
		Enable FTP: Disable
		FTP Server: (Null)
		FTP Port: 21
		User Name: (Null)
		Password: (Null)
		Directory: Use root directory
		Parent Directory: (Null)

		Secondary Directory: (Null)
		Secondary Directory: (Null)
SNMP		
	SNMP	
		Enable SNMP: Disable
		SNMP Version:
		SNMP Port: 161
		Read Community: public
		Write Community: private
		Trap Address: (Null)
		Trap Port: 162
UPnP		
	UPnP	
		Enable UPnP: Disable
		Mapped Type: Auto
		Port Type: HTTP Port; RTSP Port ; Server Port
Net Detect		
	Traffic	
		Name:LAN1
		Network Delay, Packet Loss Test: Select NIC, Destination Address
		Network Packet Archive: Device Name
		LAN1: 192.168.1.82
Network Statistics		
	Network Stat.	
		Type: Bandwidth
		IP Camera: 0bps
		Remote Live View: 0bps
		Remote Playback: 0bps
		Net Total Idle: 60Mbps
		Total Bandwidth Limit: 60Mbps
Recording		
	Recording Schedule	
	Recording	
		Camera: Analog 1
		Enable Recording: Enabled
		Schedule: All day for whole week TL-Hi

General	
General	Instant Replay Duration: 5 minutes
Manual Recording	
Manual Recording	Analog: Disable
Alarm & Event Setup	
Alarm Input	
Alarm Input	Alarm Input No.: A<-1
	Alarm Input Name: (Null)
	Type: NO
	Enable Alarm Input: Disable
	Actions: Trigger channel - No; Alarm schedule - All day for whole week; Rule (Null); PTZ link: (Null)
Alarm Output	
Alarm Output	Alarm Output No.: A->1
	Alarm Output Name: (Null)
	Time Out: 5 s
	Actions: All day for whole week
Manual Trigger	
Manual Alarm	Trigger: none
Buzzer Settings	
System Buzzer Time: Constant	
Camera Buzzer Time: Constant	
Notifications	
Notification	Display Event Icon: Enable
	Event Priority: Text In < Motion
	Notification Type: HDD Full
	Enable Alarm Audio: Disable
	Notify Alarm Host: Disable
	Send Email: Disable
	Trigger Alarm Output: Disable

Video Loss	
Video Loss Settings	
	Camera: Analog 1
	Enable Video Loss Alarm: Disable
	Actions: Arming Schedule - All day for whole week; Rule (Null);
Alarm Host Setup	
Alarm Host Setup	
	Alarm Host 1 IP: (Null)
	Alarm Host 1 Port: 5001
	Alarm Host 2 IP: (Null)
	Alarm Host 2 Port: 5001
	Alarm Host 3 IP: (Null)
	Alarm Host 3 Port: 5001
Device Management	
Time & Date Settings	
DST Settings	
	Time ZoneⓈGMT-08:00) Pacific Time(U.S. & Canada)
	Date Format: MM-DD-YYYY
	Time Format: 12-hour
	Display Day: Disable
	System Date: Current System Date
	System Time: Current System Time
	Auto DST Adjustment: Disable
	Enable DST: Disable
	From: Apr 1st Sun 2:00
	To: Oct last Sun 2:00
	DST Bias: 60 minutes
General Settings	
General	
	Language: English
	Device Name: TVR 12HD
	Remoter Control ID: 255
	Keypad Zone ID: 1
	Password Required : Disable
	Enable Wizard: Enable
	Start Wizard Now: Disable
	Menu Timeout: 5 Minutes

	Mouse Pointer Speed: Low
	Enable Front Panel Lock: Disable
Configuration Files	
	Import/Export Config Files
	Device Name: (Null)
Upgrade Firmware:	
	Local Upgrade
	Source: USB
	Device Name: (Null)
Holiday	
	Holiday Settings
	Status: All Disabled; Start Date: 1st. Jan; End Date: 1st Jan
Text Insertion	
	Text Insertion
	Enable Text Insertion: Disable
	Access Device: ATM/POS
	Access Mode: Probridge
	Start String: (Null)
RS-232 Settings	
	RS-232 Settings
	Baud Rate: 115200
	Data Bit: 8
	Stop Bit: 1
	Parity: None
	Flow Ctrl: None
	Interface: ProBridge
Storage Management	
	HDD Information
	Label: Disable
	Total Capacity:
	Free Space:
	Overwrite: Enable
Storage Mode	
	Storage Mode
	Mode: Quota
	Camera: Analog 1
	Used Record Capacity:

	Used Snapshot Capacity:
	HDD Capacity (GB):
	Max Record Capacity (GB):
	Max Snapshot Capacity (GB):
S.M.A.R.T.	
	Use when the disk has failed to self-evaluate: Disable
	HDD No.:
	Self-test Status: Not Tested
	Self-test Type: Short Test
	S.M.A.R.T.:
	Temperature (°C):
	Power Up (days):
	Self-evaluation:
	All-evaluation: Functional
	S.M.A.R.T. Information : ID ; Attribute Name ; Status ; Flags ; Threshold ; Value ; Worst ; Raw Value
Bad Sector Detection	
	HDD No.: (Null)
	HDD Capacity: (Null)
	Block Capacity: (Null)
	Status: (Null)
	Error Count: (Null)
User Management	
Users	
User Management	
	admin:1234
	operator: 4321
	guest: (Null)
System Information	
Device Info	
System Information	
	Device Name: TVR 12HD
	Model: (Model number)
	Serial No.: (Model's serial number)
	Firmware Version:
	Encoding Version:

Camera	Camera	Camera No.; Camera Name; Status; Motion Detection; Camera Tamper, Video Loss; Preview
Record	Record	Camera No.; Recording Status; Stream Type; Frame Rate; Bitrate (Kbps); Resolution; Record Type; Active Schedule
Alarm Inputs	Alarm Inputs	No.; Alarm Name; Alarm Type; Alarm Status; Triggered Camera
Alarm Outputs	Alarm Outputs	No.; Alarm Name; Alarm Status
Network	Network	NIC: IPv4 Address: IPv4 Subnet Mask IPv4 Default Gateway IPv6 Address 1 IPv6 Address 2 IPv6 Default Gateway Preferred DNS Server Alternate DNS Server Enable DHCP Enable PPPOE PPPOE Address PPPOE Subnet Mask PPPOE Default Gateway MAC Address Server Port HTTP Port Multicast IP
HDD	HDD	Label; Status; Capacity; Free Space; Property; Type; Group

Log search	
Log search	
	Start Time:
	End Time:
	Event: All
	Type: All

Index

A

Alarm notifications

- external alarms, 90
- types, 93
- video loss, 94
- video tampering, 69
- warning buzzer, 92

Alarm outputs

- manually acknowledging, 92

Archiving

- exporting files to a backup device, 53
- quick archive, 52
- video clips, 54

B

Back panel description, 11

Bad sector detection, 108

Bookmarks

- create, 45
- playback, 45
- saving, 45
- types, 45

Brightness, contrast and saturation

- modifying, 66

C

Cameras

- configure PTZ dome cameras, 70
- layout, 57
- privacy mask, 68

D

Daily schedules

- recording, 87

Date

- configuring display, 96

DDNS settings, 79

Default settings

- restore, 99

Digital zoom

- description, 35
- playback, 39
- playback, 41

- web browser, 126

Digital zoom in playback, 45

Disk analysis

- searching recorded video, 51

DST, 96

E

Email notifications

- set up, 81

Event logs

- searching remotely, 126

Export configuration settings, 99

External alarm

- setting up to record when triggered, 90

F

Factory default settings

- restore, 99

Firmware

- update, 100

Frame-by-frame playback, 44

Front panel

- button functions by task, 23

Front panel description, 21

Front panel lock, 99

FTP server settings, 82

H

HDD

- checking status, 104
- grouping, 106
- initializing, 104
- properties, 106, 107

Holiday schedules

- recording, 100

I

Import configuration settings, 99

Instant playback, 42

IP camera

- maximum configuration, 59
- status, 61
- supported, 59

K

- KTD-405 keypad
 - accessing recorder functions, 144
 - connecting the keypad to the recorder, 148
 - controlling a camera, 147
 - firmware supported, 141
 - set up in zone mode, 142
 - set up recorder device address, 142
 - wiring, 141

L

- Language
 - change GUI language, 98
- Live mode
 - configuring time and date display, 96
- Live view mode
 - digital zoom, 35
- Live view toolbar, 33
- Login password, 98

M

- Main menu
 - accessing, 27
 - description, 27
 - icon descriptions, 27
- Manual recording, 89
- Menu timeout
 - change time, 98
- Monitors
 - change output mode, 98
 - connecting, 13
 - video outputs, 31
- Motion detection, 66
- Mouse pointer speed
 - change, 98
- Mouse pop-up menu, 31

N

- Network packet data
 - exporting, 85
- Network settings
 - general set up, 76
- Network settings for browser, 122
- Network status, 83
- Network traffic
 - checking, 83
- Notifications
 - alarm types, 93
 - external alarms, 90
- NTP server, 80

O

- OSD settings, 65

P

- Password
 - change admin password, 114
 - change user password, 113
 - enable/disable login password, 98
- Playback
 - 24-hour playback, 42
 - bookmarks, 45
 - change playback speed, 44
 - instant playback, 42
 - playing back archived files, 55
 - pop-up menu description, 41
 - search by event, 49
 - search by time, 48
 - search by video type, 48
 - search results, 47
 - skip time, 43
 - snapshots, 50
 - using the web browser, 125
- Playback control panel
 - description, 39
- Playback control toolbar
 - quick access, 41
- Player
 - using for playback, 55
- Power up and down recorder, 15
- PPPoE settings, 78
- Preset tour
 - calling up, 37
- Preset tours
 - setting up, 73
- Presets
 - calling up, 72
 - quick access, 36
 - selecting, setting up and deleting, 71
 - setting up, 72
- Privacy mask, 68
- PTZ control panel
 - description, 36
- PTZ dome cameras
 - configure, 70
 - connecting dome cameras to the recorder, 13
 - control remotely, 124
- PTZ protocols
 - assign, 70
 - configuring Interlogix cameras, 137

R

- Recorder address
 - change, 98
- Recorder name
 - change, 98
- Recording
 - recording schedules, 86
- Recording schedules
 - daily, 87, 100
 - defining, 86
- Remote alarm host settings, 95

Remote control
connect to the recorder, 26
description, 25

Resolution
change monitor resolution setup, 98

Restricted access, 69

RS-232 port
configuring, 102

S

S.M.A.R.T. information on a HDD, 107

Search
bookmarks, 45
recordings by event, 49
snapshots, 50
system logs, 118

Sequencing cameras, 33

Setup wizard
using, 16

Shadow tours
quick access, 36

Skip time
playback, 43
quick access, 41

Snapshots
capture remotely, 125
playback, 50
recording settings, 64
upload to FTP server, 82

SNMP protocol settings, 82

Soft keyboard, 29

Status icons
enable/disable display, 98

System information
view, 115

System logs
playback, 118
search, 118

T

Tampering
detecting video tampering, 69

Text insertion
via the browser, 101

Text overlay, 130

Time
configuring display, 96

U

User privileges
camera configuration, 112
local configuration, 111
remote configuration, 112

Users
adding a new user, 110
customizing user privileges, 111
deleting a user, 113

modify user information, 113, 114

V

Video format
PAL/NTSC, 15

Video loss
setting up detection, 94

Video output
change manually, 98

Video outputs, 31

Video search menu, 46

Video tampering
setting up to detect, 69

V-stream encoding, 74

W

Warning buzzer
modifying, 92

Web browser
accessing, 122
camera management, 127
control PTZ dome camera, 124
digital zoom, 126
remote configuration of recorder, 127
search event logs, 126
searching and playing back recorded video,
125
text insertion, 101
video snapshot, 125

Wizard
enable/disable, 98

