

# Concord 5" TouchScreen Installation Sheet

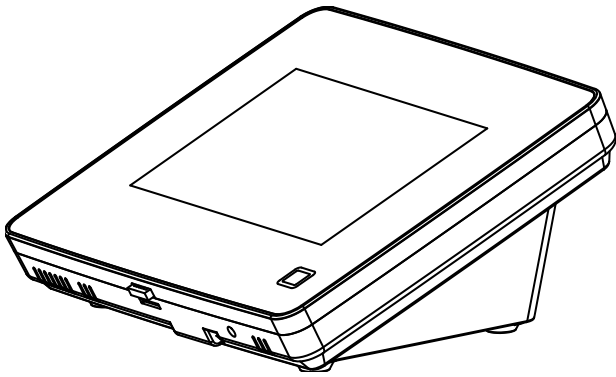

## Description

Concord 5" TouchScreen, model 60-924-3-C4TS5, features a 5-inch color LCD screen with a graphical user interface designed to control basic functionality of Concord 4, version 4.5 or later.

Multiple touch screens can be added to each Concord panel. An internal speaker provides system status beeps for trouble and alarm indications.

The touch screen provides a convenient option for the following system operations:

- Easily obtain home/building status using At-A-Glance (AAG) sensor status.
- Arm the system (doors, windows, motion sensors, and property).
- Disarm the system.
- Activate a panic alarm to call the central monitoring station in a non-medical emergency.

## Equipment

- Alphanumeric keypad (for panel and end user programming)
- 4-conductor, 18 to 22-gauge wire
- #6 screws and anchors (included)
- Super bus power supply (optional), PN 600-1019

## Tools

- 2.5mm flat-blade screwdriver
- #2 Phillips screwdriver
- Drill and drill bits for opening wallboard (3/16- and 1/2-inch bits)

## Safety information

**IMPORTANT SAFETY INFORMATION. READ ENCLOSED WARNINGS AND SAFETY INFORMATION.**

- ⚠ **WARNING!** Disconnect panel power before servicing.
- ⚠ **CAUTION:** Use static electricity precautions when handling electronic components.

## Installation guidelines

The touch screen can be the primary interface to the panel or it can act as auxiliary interface working in conjunction with alphanumeric keypads (such as Interlogix P/N 600-1070-E or 60-983).

- The touch screen is not listed to UL Fire Standards and may not be programmed for use with a Fire System in California per CSFM Regulations.
- Mount the touch screen in an environmentally-controlled area (32°F to 120°F/0°C to 49°C).
- Do not exceed the maximum available power given in the panel. Refer to the total system power and guideline section in Concord installation instructions. See Table 1 for touch screen power usage and Table 2 for maximum wire length between touch screen and panel.
- Depending on system loading, multiple touch screens can be installed on a Concord 4 system. See the examples in Table 3 and Table 4.

**Table 1: Touch Screen Power Usage**

Current (mA)	Conditions
400	Maximum alarm current with the buzzer sounding and the touch screen illuminated from a button press
100	Typical operation
40	Power saving mode (no panel AC power)

**Table 2: Maximum SuperBus Lengths**

Wire gauge (shielded or unshielded)	Max. touch screen wire length between touch screen and panel
22	120 feet

**Table 3: Example – Basic Concord 4 system with two Concord 5” TouchScreens and one alphanumeric keypad**

Device	Part #	Number used	Alarm current draw	Available Power
Concord 4				1000 mA
Concord 5” Touch Screen	60-924-3-C4TS5	2	800 mA	
ATP 1000	60-983	1	110 mA	
Total				90 mA remaining

**Table 4: Example - Concord 4 system with four Concord 5” TouchScreens, one ADC modem, and one panel voice module (Note: SB 2000 power supply is needed in this configuration)**

Device	Part #	Number used	Alarm current draw	Available Power
Concord 4				1000 mA
SB2000 voice only module	60-836	1	600 mA	
Concord 5” Touch Screen	60-924-3-C4TS	1	400 mA	
				0 mA remaining
SB2000 Power Supply	600-1019	1		2000 mA
ADC LTE Modem	600-1053-LTEAT	1	125 mA	
Concord 5” Touch Screen	60-924-3-C4TS5	4	1600 mA	
Total				875 mA remaining

## Preparation

### To begin

1. Separate the touch screen and the mounting base from the preassembled desktop stand. Remove the desktop stand by holding the touch screen unit with one hand and prying the desktop stand at the removal tab marking until it separates (Figure 1) with the other.

**Figure 1: Desktop stand removal**

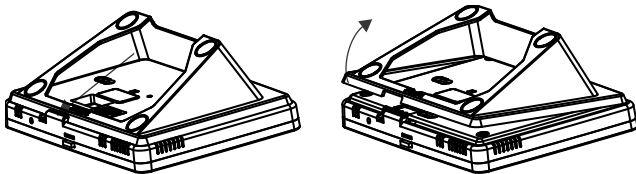

2. Remove the touch screen from the mounting base pressing the opening button on the bottom of the touch screen (as shown in Figure 2). In case the parts stick to each other, try to separate them by inserting a small screwdriver into the opening slot beneath the protruding opening button (Figure 2).

**Figure 2: Opening slot**

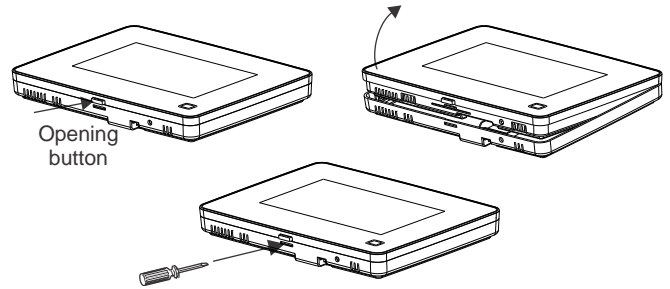

## Wall mounting

1. If the unit is to be installed and used on surface utilizing the desktop stand, skip to step 9.
- Wall mounting uses only the mounting base; the desktop stand is not used.
2. Hold the base on the wall at the desired mounting location and mark the mounting holes and bus wire drop.
3. At the mounting hole locations, drill 3/16-inch holes into the wall for plastic anchors.
4. At the bus wire drop opening, drill a 1/2-inch hole into the wall.
5. Push the two plastic anchors into the drilled holes and tighten screws within a quarter-inch of the anchors.
6. Feed the bus wiring through the backside of the bus wire drop in the mounting base (Figures 3 and 4).

**Figure 3: Wire access in mounting base**

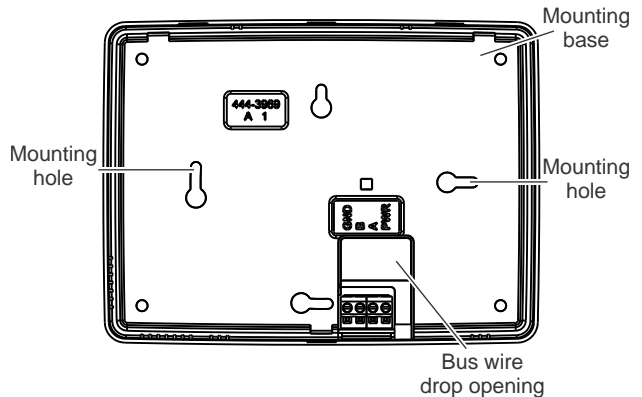
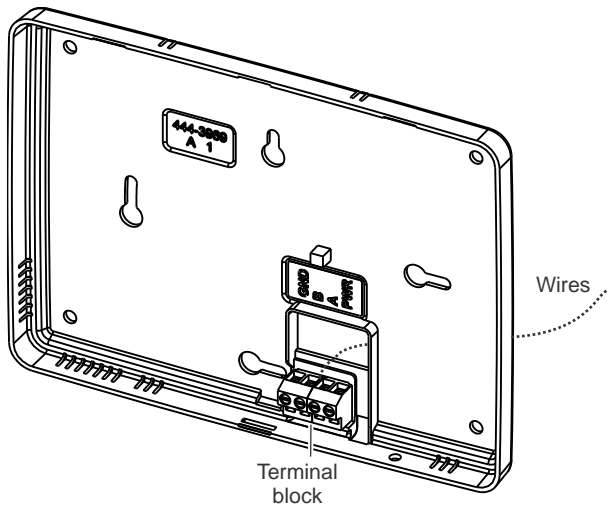

Figure 4: Bus Wire Routing Wall Mount



7. Hang the base using the screws, level the base, and tighten the screws.
8. Feed any extra bus wire back into wall. Bus wires should not protrude outside of the bus wire drop opening.

## Surface, desktop mounting

If the unit is to be wall mounted, skip to step 11.

9. Feed the bus wiring through the desktop stand from the backside forward, and then feed the wire through the backside of the bus wire drop in the mounting base (see Figure 5).

Figure 5: Bus Wire Routing Surface Desktop Mount

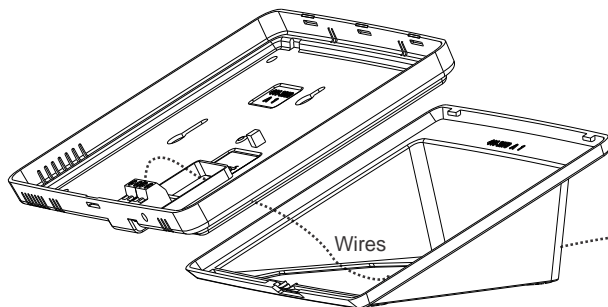

10. Reattach the desktop stand to the mounting base.

## Wiring and final assembly

11. For either mounting, now connect the bus wires to the 4-position terminal block (Figure 6).

Figure 6: Connecting the touch screen

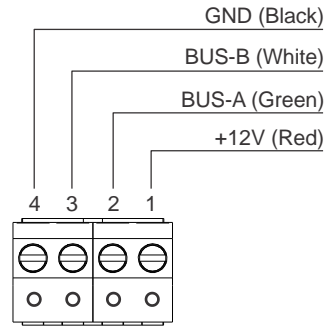

12. To reattach the touch screen to the mounting base (which is mounted either to a wall or is attached to the desktop stand sitting on a surface), angle the top of the touch screen into the tab hooks on the top of the mounting base and swing the bottom of the touch screen into the lower part of the mounting base until you hear an audible click.

**Note:** If necessary, use a soft cloth to clear smudges on the touch screen. Do not use glass cleaner.

## Power up and bus communication

Follow the steps below for powering up the panel and for verifying that the TouchScreen and other products like an alphanumeric keypad are properly communicating with each other.

**Note:** On power up, the panel scans the bus for connected devices, assigns a unit number to each bus device, and automatically adds the device ID number of each bus device.

1. Verify that all wiring between the panel, touch screen, and alphanumeric keypad is correct.
2. Connect the panel battery and restore AC power.

The alphanumeric keypad briefly shows *SCANNING BUS DEVICES*, then displays date and time.

**Note:** Emergency button program changes can only be completed within two minutes of initial power up of touch screen.

## Installer Programming

The Concord 5" TouchScreen has a keypad emulation mode that allows installer/dealer code access to panel programming and configuration.

To access, press the Settings icon  on the Main screen and the Settings screen appears.

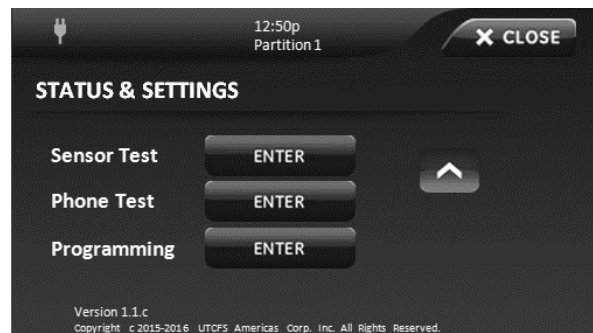

Press and hold the Enter button for approximately five seconds. The following screen will appear:



The emulated keypad works and functions the same as the 600-1070-E keypad. To enter programming mode press 8, followed by a valid installer or master code, 0, 0.

For additional details on programming with the touchscreen, see *Concord 5 in TouchScreen Quick Operation Guide*.

To exit programming, press the “Exit “ button or press and hold the top white bar where info is displayed.

### Verifying touch screen bus enrollment and panel programming touch screen options

Enter programming emulation mode as described above. For more information on alphanumeric touch pad operation, refer to the Concord 4 Installation Manual.

1. Go to the Bus Device Programming section in Concord (System Programming / Security / Accessory Modules / Bus Devices (shortcut 10,000 for unit ID 0).

The display shows the lowest device address and it's ID.

This example shows what a device address display may look like:

```
UNIT - ID
02110185*
```

\* The 8-digit SuperBus ID number is also located on a label on the back of the alphanumeric keypad.

2. Cycle through all bus device addresses until the alphanumeric keypad appears.
3. To program the following touch screen options, choose the touch screen bus device address.

### Change ID

With this menu, change the bus device ID number when replacing a defective bus device.

#### To change a device ID:

1. With the display showing the desired bus device, press #, #.  
The display shows `DEVICE ID` (current ID).
2. Enter the ID of the new bus device.  
The display flashes the entered selection. Press # and the display shows the new setting.

3. Exit programming mode.
4. Remove AC and battery power from the panel.
5. Replace the defective bus device with a new one.
6. Apply AC and battery power to the panel.

### Partition assignment

With this menu, assign bus devices to work in the desired partition.

#### To assign bus devices to partitions:

1. With the display showing the desired bus device, press #.
2. Press A or B until the display shows `DEVICE PTN` and then press #. The display shows `PARTITION ASSIGN`.
3. Press 1 to 6 to select the desired partition.  
The display flashes the entered selection.
4. Press # and the display shows the new setting.

### Status beeps

Option not used with touch screen. Touch screen status beeps can be changed in the touch screen settings menu.

### Key beeps

Option not used with touch screen. Touch screen key beeps can be changed in the touch screen settings menu.

## Panel sensor text programming guidelines

### Programming for touch screen At-A-Glance (AAG) icons

For best results, do not program sensor names that contain a combination of the words Door, Window, and/or Motion.

The designator words Door, Window, or Motion should be programmed within the first three words of the sensor text sequence. If not, the wrong AAG association may occur.

**Door** - Sensor names must contain “Door” (item number 50). When programming a name for a sensor, enter 50 and the word Door is added to the text. These sensors should be a sensor group that requires a restoral.

**Window** - Sensor names must contain “Window” (item number 183). When programming a name for a sensor, enter 183 and the word Window is added to the text. These sensors should be a sensor group that requires a restoral.

**Motion** - Sensor names must contain “Motion” (item number 119). When programming a name for a sensor, enter 119 and the word Motion is added to the text. These sensors should be a sensor group that does not require a restoral.

**Property** - Any sensor that does not contain the words Door, Window, or Motion. They may be a restoral or non-restoral sensor.

If a sensor contains the AAG keyword of Door, Window, or Motion, but the sensor appears in the Property AAG when tripped, the name of the sensor is too long. The AAG keyword needs to be moved closer to the start of the sensor name.

## TouchScreen setting options

Touch the Settings icon  on the Home screen and the Settings screen appears.

### Setting options

With the Setting options, adjust the touch screen's features.

Typical status indicators (excluding light screen):

- Gold - A button is selected.
- Blue - Buttons not selected.

Use the scroll bar to see all of the options (below):

**Event History** - Touch the Related Show button to view system events.

**Direct Bypass** - Touch the Related button to bypass a sensor.

**Panel Status** - Touch the Related Show button to display the status of the security system.

**Change Partition** - Touch the Related button to change partitions.

**Chime** - Touch the On or Off button to toggle the touch screen chime feature on or off. This feature will enable this touch screen to beep when a certain door opens. Consult the dealer regarding which doors or windows are programmed to chime when opened. Refer to the security panel documentation for information on this feature.

**Keypress Volume** - Touch the arrow buttons to adjust this touch screen's keypress volume level. The siren sounds are not controlled by this setting.

**Beep Volume** - Touch the arrow buttons to adjust this touch screen's beep volume level. The siren sounds are not controlled by this setting.

**Brightness** - Touch the arrow buttons to adjust the brightness level of this touch screen's screen.

**Default screen** - Use this feature to set this touch screen's screen saver mode. Select Blank to have the screen and LED go dark after a period of inactivity. Otherwise, the default will be the Home screen and the screen will always be lit.

The touch screen will automatically blank daily at 2:00 AM for 60 minutes.

**Calibration** – The touch screen typically does not need to be calibrated. However, if the touch screen buttons do not respond correctly, touch the Show button to access the Calibration screen. To calibrate the touch screen, touch the + icons in the corners of the screen using a soft, fine point.

**Help** - Touch the Help button to access the Help menu, which displays a list of help topic buttons. Touch the buttons for information on a given topic.



**Set Date/Time** - Touch the related button to access the Date/Time menu.

**Code Required Access** - Touch the On or Off buttons to toggle this feature. When turned on, it will require a user access code to be entered for most touch screen functions. With code required access, not all icons will be displayed.

**Note:** If this device (or any other keypad) is located in areas that are less secure such as a garage which is not monitored, be sure Quick Exit is programmed to off.

**Emergency Keys (Default on)** - Touch the On or Off buttons to toggle this feature. There will be a prompt to enter a code. Installer or dealer code must be used. When turned on, the Emergency button appears. When turned off, the Emergency button does not appear.

**Fire Key (Default off)** - Touch the On or Off buttons to toggle this feature. There will be a prompt to enter a code. Installer or dealer code must be used.

The fire emergency key will show that the fire key is active. If the fire emergency option is on, the  button appears under the fire button. If the emergency option is off, the button does not appear if the  button is pressed.

**Note:** The Emergency keys and Fire key programming options appear only within two minutes of initial power up or if the touch screen is reset.

### Status LED

The touch screen has an LED that indicates power and sleep mode status at a glance. Table 5 explains LED behavior.

Table 5: Status LED

LED	System status
Solid blue (while backlights are on)	Primary power present
Fading blue	Primary power failure
Off	Screen saver active

### Operation

Refer to *Concord 5 in TouchScreen User Guide* for basic touch screen operation information.

Refer to the panel documentation for complete Concord 4 programming and operation information.

### Emergency button

Touch the  button and an Emergency screen appears. Depending on the system, two or three buttons (the Panic and Police buttons or the Panic, Police, and Fire buttons) may appear. Select the appropriate button.

An emergency alarm initiated by mistake can be canceled by touching the  button and entering your user access code within 30 seconds.

**Note:** The fire panic cannot be canceled.

## Testing

Test the touch screen operation by arming/disarming the system, activating the touch screen panics, and bypassing sensors to verify correct operation.

**Note:** Contact the central monitoring station before activating alarms to avoid dispatching local police and fire departments.

Refer to the panel User Manual for complete system operating instructions.

**Note:** Test system at least once per week.

**Note:** Each control unit shall indicate that the system is intended to be checked by a qualified technical at least every 3 years.

## Troubleshooting

Problem	Actions/Solutions
Doesn't power up (no display and no beeps when screen is pressed)	<p>Check for correct wiring connections at touch screen and panel terminals.</p> <p>Make sure panel battery is connected correctly and panel transformer is plugged in.</p> <p>Make sure panel transformer is not plugged in to an electrical outlet controlled by a switch. Relocate transformer to an unswitched outlet location if necessary.</p>
Icons not visible	<p>Try touching the touch screen (if screen saver option is on). Adjust Brightness level. Disable the screen saver option.</p>
No sound coming from speakers	<p>Check Status beeps volume and Keypress volume levels in settings. Check for correct wiring connections at touch screen and panel terminals.</p>
Sensors named as door/window/motion are displaying under Property icon	<p>The name of the sensor is too long. Place door/window/motion earlier in the name or shorten the name.</p>
Touch screen has red icon (offline)	<p>This icon is displayed if a touch screen has incurred some form of communication and/or hardware failure. Check for correct bus wiring connections (green and white wires) at touch screen and panel terminals. If wired correctly and the failure message persists, the failed touch screen must be deleted from the touch screen panel and rescanned. If error messages continue even after the failed device has been removed, it is possible that the failed device is a different touch screen. In that case, delete all screens from the Concord and remove them from the Concord's bus, and re-scan bus devices.</p>
AAG motion icon continually shows sensor is open	<p>Must use non-restoral groups such as motion group 15 or 17. Using restoral groups may result in a continuously red AAG motion icon.</p>
Can both door and motion text be used in a sensor?	<p>Not recommended.</p>
Degraded or inhibited touch screen functionality	<p>Check wiring.</p> <p>Confirm wire length is not exceeding 120 ft (22 gauge).</p> <p>Re-calibrate touch screen.</p>

Problem	Actions/Solutions
Trouble condition not displayed under status	<p>Refer to event buffer in touch screen and/or view full status on alphanumeric keypad.</p> <p>If a Concord 5" TouchScreen has a problem and the touch screen is reset, the following is not displayed as part of status:</p> <ul style="list-style-type: none"> <li>Aux low battery</li> <li>Aux power trouble</li> </ul>

## Specifications

Compatibility	Concord 4 Version 4.5 or later
Power requirements	12 VDC nominal
Current consumption:	
Maximum alarm current	400 mA
Typical operation	100 mA
Power saving mode (no panel AC power)	40 mA
Operating temperature	32 to 120°F (0 to +49°C)
Storage temperature	-4 to +140°F (-20 to +60°C)
Maximum relative humidity	85% noncondensing
Dimensions (L x W x D)	6.7 × 5.0 × 0.8 in. (170 × 127 × 20 mm)

## Regulatory Information

Manufacturer	UTC Fire & Security Americas Corporation, Inc. 2995 Red Hill Ave, Costa Mesa, CA 92626, USA
--------------	--

Warnings and Disclaimers	<p>THESE PRODUCTS ARE INTENDED FOR SALE TO AND INSTALLATION BY QUALIFIED PROFESSIONALS. UTC FIRE &amp; SECURITY CANNOT PROVIDE ANY ASSURANCE THAT ANY PERSON OR ENTITY BUYING ITS PRODUCTS, INCLUDING ANY "AUTHORIZED DEALER" OR "AUTHORIZED RESELLER", IS PROPERLY TRAINED OR EXPERIENCED TO CORRECTLY INSTALL FIRE AND SECURITY RELATED PRODUCTS.</p>
--------------------------	---



For more information on warranty disclaimers and product safety information, please check <https://firesecurityproducts.com/policy/product-warning/> or scan the QR code.

FCC and Industry Canada Compliance	<p>This equipment has been tested and found to comply with the limits for a Class B digital device, pursuant to part 15 of the FCC Rules. These limits are designed to provide reasonable protection against harmful interference in a residential installation. This equipment generates uses and can radiate radio frequency energy and, if not installed and used in accordance with the instructions, may cause harmful interference to radio communications.</p> <p>However, there is no guarantee that interference will not occur in a particular installation. If this equipment does cause harmful interference to radio or television reception, which can be determined by turning the equipment off and on, the user is encouraged to try to correct the interference by one or more of the following</p>
------------------------------------	---

---

measures:

- Reorient or relocate the receiving antenna.
- Increase the separation between the equipment and receiver.
- Connect the equipment into an outlet on a circuit different from that to which the receiver is connected.
- Consult the dealer or an experienced radio/TV technician for help.

This Class B digital apparatus complies with Canadian ICES-003.

Cet appareil numérique de la classe B est conforme à la norme NMB-003 du Canada.

---

Conforms to:	UL 985 Household Fire Warning System Units
	UL 1023 Household Burglar-Alarm System Units
	UL1610 Central Station Burglar-Alarm Units (Commercial Burglary)
	ULC C1023 Preliminary Standard for Household Burglar Alarm
	ULC S545 Standard For Residential Fire Warning System Control Units

---

## Warranty Information

MANUFACTURER HEREBY DISCLAIMS ALL WARRANTIES AND REPRESENTATIONS, WHETHER EXPRESS, IMPLIED, STATUTORY OR OTHERWISE INCLUDING (BUT NOT LIMITED TO) ANY WARRANTIES OF MERCHANTABILITY OR FITNESS FOR A PARTICULAR PURPOSE WITH RESPECT TO ITS CONCORD 4 PRODUCTS AND RELATED SOFTWARE. MANUFACTURER FURTHER DISCLAIMS ANY OTHER IMPLIED WARRANTY UNDER THE UNIFORM COMPUTER INFORMATION TRANSACTIONS ACT OR SIMILAR LAW AS ENACTED BY ANY STATE.

(USA only) SOME STATES DO NOT ALLOW THE EXCLUSION OF IMPLIED WARRANTIES, SO THE ABOVE EXCLUSION MAY NOT APPLY TO YOU. THIS WARRANTY GIVES YOU SPECIFIC LEGAL RIGHTS AND YOU MAY ALSO HAVE OTHER LEGAL RIGHTS THAT VARY FROM STATE TO STATE.

MANUFACTURER MAKES NO REPRESENTATION, WARRANTY, COVENANT OR PROMISE THAT ITS SECURITY PRODUCTS AND/OR RELATED SOFTWARE (I) WILL NOT BE HACKED, COMPROMISED AND/OR CIRCUMVENTED; (II) WILL PREVENT, OR PROVIDE ADEQUATE WARNING OR PROTECTION FROM, BREAK-INS, BURGLARY, ROBBERY, FIRE; OR (III) WILL WORK PROPERLY IN ALL ENVIRONMENTS AND APPLICATIONS.

## Contact Information

For general information, see [www.interlogix.com](http://www.interlogix.com). For customer/technical support, see [www.interlogix.com/customer-support](http://www.interlogix.com/customer-support) or call +1 855 286 8889.

© 2018 UTC Fire & Security Americas Corporation, Inc. Interlogix is part of UTC Building and Industrial Systems, a unit of United Technologies Corporation. All rights reserved.

