

70 Series

Mobile Computer

CK70, CK71, CN70, CN70e



User's Manual

Intermec Technologies Corporation

Worldwide Headquarters
6001 36th Ave.W.
Everett, WA 98203
U.S.A.

www.intermec.com

The information contained herein is provided solely for the purpose of allowing customers to operate and service Intermec-manufactured equipment and is not to be released, reproduced, or used for any other purpose without written permission of Intermec Technologies Corporation.

Information and specifications contained in this document are subject to change without prior notice and do not represent a commitment on the part of Intermec Technologies Corporation.

© 2010 by Intermec Technologies Corporation. All rights reserved.

The word Intermec, the Intermec logo, Norand, ArciTech, Beverage Routebook, CrossBar, dcBrowser, Duratherm, EasyADC, EasyCoder, EasySet, Fingerprint, i-gistics, INCA (under license), Intellitag, Intellitag Gen2, JANUS, LabelShop, MobileLAN, Picolink, Ready-to-Work, RoutePower, Sabre, ScanPlus, ShopScan, Smart Mobile Computing, SmartSystems, TE 2000, Trakker Antares, and Vista Powered are either trademarks or registered trademarks of Intermec Technologies Corporation.

There are U.S. and foreign patents as well as U.S. and foreign patents pending.

Wi-Fi is a registered certification mark of the Wi-Fi Alliance.

Microsoft, Windows, and the Windows logo are registered trademarks of Microsoft Corporation in the United States and/or other countries.

Bluetooth is a trademark of Bluetooth SIG, Inc., U.S.A.

This product includes software developed by the OpenSSL Project for use in the OpenSSL Toolkit (www.openssl.org).

This product includes cryptographic software written by Eric Young (EAY@cryptsoft.com).

This product uses Regex++, Index software during its operational phases. The owner of Regex++ has granted use of the software to anyone provided such use is accompanied by the following copyright and permission notice:

Regex++, Index. (Version 3.31, 16th Dec 2001)

Copyright © 1998-2001 Dr John Maddock

Permission to use, copy, modify, distribute and sell this software and its documentation for any purpose is hereby granted without fee, provided that the above copyright notice appear in all copies and that both that copyright notice and this permission notice appear in supporting documentation. Dr John Maddock makes no representations about the suitability of this software for any purpose. It is provided "as is" without express or implied warranty.

Contents

Before You Begin	ix
Safety Information	ix
Global Services and Support	ix
Warranty Information	ix
Web Support	ix
Telephone Support	x
Service Location Support	x
Who Should Read This Manual	x
Related Documents	xi
Patent Information	xii

1 Using the Computer 1

About the 70 Series Mobile Computers	2
Overview of 70 Series Features	4
About the Status LEDs	5
70 Series Accessories	7
About the Battery	8
Charging the Battery	9
Changing the Battery	9
About Battery Status	12
About Battery Life and Conservation	13
About the Keypad	14
Entering Characters on the QWERTY Keypad	19
Entering Characters on the Numeric Keypad	20
Entering Characters on the CK70 and CK71 Keypads	21
About the Power Button	21
About the Intermec Dashboard Button	23
Configuring the Screen Backlight	23
Adjusting the Volume	23
Reading Bar Codes	24
Inserting a microSD Card	26
Transferring Files To and From Your PC	31

2	Understanding the User Interface and Intermec Applications	33
	About the User Interface	34
	About the Home Screen	34
	Interacting With the Screen	35
	Title Bar Status Icons	36
	Aligning the Screen	39
	About Intermec Applications	39
	Applications Available on the Mobile Computer	40
	Applications You Can Download to the Mobile Computer	41
3	Using the Phone	45
	About the Phone	46
	Activating the UMTS Phone	46
	Activating the CDMA Phone	48
	Starting the Activation Wizard	49
	Turning the Phone On and Off	49
	Making a Phone Call	50
	Making an Emergency Phone Call	50
4	Using the Camera	51
	About the Color Camera	52
	Taking a Picture	52
	Recording a Video	53
	Saving Pictures and Videos to an SD Card	53
5	Using GPS	55
	About the Integrated GPS on Your Computer	56
	Using the GPSID Installed on the Computer	56
	Improving GPS Performance on the Computer	58

6	Configuring the Computer	59
	How to Configure the Computer	60
	Using Intermec Settings on the Computer	60
	Starting Intermec Settings	61
	About the Structure of Intermec Settings	61
	Navigating in Intermec Settings	65
	Configuring ProfileSettings With Intermec Settings	66
	Restoring Default Settings	66
	Hiding Menu Items in Intermec Settings	67
	Using Intermec Settings Remotely With SmartSystems Foundation	67
	About Network Communications	68
	Configuring 802.11b/g Radio Communications	68
	Configuring Ethernet Communications	69
	Configuring Bluetooth Communications	69
	About Serial and USB Communications	73
	Creating an ISP Connection	74
	Creating a VPN Server Connection	75
	About Wireless Security	76
	Choosing Between Microsoft and Funk Security	77
	Loading a Certificate	88
	Disabling Security	90
7	Managing the Computer	91
	Managing the Computer in Your Network	92
	Managing the Computer Using SmartSystems	92
	Managing the Computer Using Third-Party Software	93
	Developing and Installing Applications	93
	Packaging Your Application	94
	Choosing a Target Location	94
	Installing Applications Using SmartSystems Foundation Console	94
	Installing Applications Using Microsoft ActiveSync	95
	Installing Applications Using a Storage Card	95
	Installing Applications Using the FTP Server	96
	Launching Applications Automatically	96

Contents

Updating the System Software	97
Updating Multiple Computers Using SmartSystems Console	98
Updating Individual Mobile Computers	99

8 Troubleshooting and Maintaining the Computer 101

About the Intermec Dashboard	102
------------------------------------	-----

Troubleshooting Your Mobile Computer.....	103
Troubleshooting the Wi-Fi Connection	103
Troubleshooting 802.1x Security	104
Checking 802.11 Network Status.....	105
Troubleshooting Reading Bar Codes.....	107
Troubleshooting Operating the Computer	109

Calling Product Support.....	110
Finding Your Configuration Number.....	111
Finding Your Operating System Version	111

Resetting the Computer	111
Rebooting the Computer	111
Cold Booting the Computer	112
Clean Booting the Computer	113

Cleaning the Computer.....	114
----------------------------	-----

A Specifications and Default Settings 115

Physical and Environmental Specifications.....	116
CN70 Physical Dimensions	116
CN70e Physical Dimensions	116
CK70 Physical Dimensions	116
CK71 Physical Dimensions	116
Environmental Specifications	116
Power and Electrical Specifications	117
Operating System.....	117
Hardware	117
Back Accessory Interface Pin-outs	117
Touch Screen Specifications	118
Standard Communications	118
Wireless LAN	118

Regulatory Approvals	118
Bar Code Symbologies.....	119
Imager Reading Distances	119
Default Configuration	128
Data Collection.....	128
Symbology Option Settings.....	129
Imager Settings	129
Decode Security Settings	130
Communications	130
Device Settings	131

Before You Begin

This section provides you with safety information, technical support information, and sources for additional product information.

Safety Information

Your safety is extremely important. Read and follow cautions in this document before handling and operating Intermec equipment. You can be seriously injured, and equipment and data can be damaged if you do not follow the safety cautions.

This section explains how to identify and understand cautions and notes that are in this document.



A caution alerts you to an operating procedure, practice, condition, or statement that must be strictly observed to prevent equipment damage or destruction, or corruption or loss of data.



Note: Notes either provide extra information about a topic or contain special instructions for handling a particular condition or set of circumstances.

Global Services and Support

Warranty Information

To understand the warranty for your Intermec product, visit the Intermec web site at www.intermec.com and click **Support > Returns and Repairs > Warranty**.

Disclaimer of warranties: The sample code included in this document is presented for reference only. The code does not necessarily represent complete, tested programs. The code is provided “as is with all faults.” All warranties are expressly disclaimed, including the implied warranties of merchantability and fitness for a particular purpose.

Web Support

Visit the Intermec web site at www.intermec.com to download our current manuals (in PDF).

Before You Begin

Visit the Intermec technical knowledge base (Knowledge Central) at www.intermec.com and click **Support** > **Knowledge Central** to review technical information or to request technical support for your Intermec product.

Telephone Support

In the U.S.A. and Canada, call **1-800-755-5505**.

Outside the U.S.A. and Canada, contact your local Intermec representative. To search for your local representative, from the Intermec web site, click **About Us** > **Contact Us**.

Service Location Support

For the most current listing of service locations, click **Support** > **Returns and Repairs** > **Repair Locations**.

For technical support in South Korea, use the after service locations listed below:

Awoo Systems

102-1304 SK Ventium

522 Dangjung-dong

Gunpo-si, Gyeonggi-do Korea, South 435-776

Contact: Mr. Sinbum Kang

Telephone: +82-31-436-1191

Email: mjyun@awoo.co.kr

IN Information System PTD LTD

6th Floor

Daegu Venture Center Bldg 95

Shinchun 3 Dong

Donggu, Daegu City, Korea

E-mail: jmyou@idif.co.kr or korlim@gw.idif.co.kr

Who Should Read This Manual

This manual is written for the person who is responsible for installing, configuring, and maintaining the 70 Series Mobile Computer.

This manual provides you with information about the features of the 70 Series mobile computer, and how to install, configure, operate, maintain, and troubleshoot it.

Before you work with the 70 Series mobile computer, you should be familiar with your network and general networking terms, such as IP address.

Related Documents

This is a list of related Intermec documents.

- ***Intermec Settings Command Reference Manual***
- ***Intermec Developer Library (IDL) Resource Kit Developer's Guide***

The Intermec web site at www.intermec.com contains our documents (as PDF files) that you can download for free.

To download documents

- 1** Visit the Intermec web site at www.intermec.com.
- 2** Click the **Products** tab.
- 3** Using the **Products** menu, navigate to your product page. For example, to find the CN50 computer product page, click **Computers > Handheld Computers > CN70**.
- 4** Click the **Manuals** tab.

If your product does not have its own product page, click **Support > Manuals**. Use the **Product Category** field, the **Product Family** field, and the **Product** field to help you locate the documentation for your product.

Patent Information

Product is covered by one or more of the following patents:

4882476; 4894523; 4953113; 4961043; 4970379; 4988852; 5019699;
5021642; 5038024; 5081343; 5095197; 5144119; 5144121; 5182441;
5187355; 5187356; 5195183; 5216233; 5216550; 5195183; 5195183;
5218191; 5227614; 5233172; 5241488; 5243602; 5258606; 5278487;
5288985; 5308966; 5322991; 5331136; 5331580; 5342210; 5349678;
5359185; 5371858; 5373478; 5389770; 5397885; 5410141; 5414251;
5416463; 5442167; 5464972; 5468947; 5468950; 5477044; 5486689;
5488575; 5500516; 5502297; 5504367; 5508599; 5514858; 5530619;
5534684; 5536924; 5539191; 5541419; 5548108; 5550362; 5550364;
5565669; 5567925; 5568645; 5572007; 5576529; 5592512; 5594230;
5598007; 5608578; 5616909; 5619027; 5627360; 5640001; 5657317;
5659431; 5671436; 5672860; 5684290; 5719678; 5729003; 5742041;
5761219; 5764798; 5777308; 5777309; 5777310; 5786583; 5793604;
5798509; 5798513; 5804805; 5805807; 5811776; 5811777; 5818027;
5821523; 5828052; 5831819; 5834753; 5834749; 5837987; 5841121;
5842070; 5844222; 5854478; 5862267; 5869840; 5873070; 5877486;
5878395; 5883492; 5883493; 5886338; 5889386; 5892971; 5895906;
5898162; 5902987; 5902988; 5912452; 5923022; 5936224; 5949056;
5969321; 5969326; 5969328; 5979768; 5986435; 5987192; 5987499;
5992750; 6003775; 6012640; 6016960; 6018597; 6024289; 6034379;
6036093; 6039252; 6064763; 6075340; 6095422; 6097839; 6102289;
6102295; 6109528; 6119941; 6128414; 6138915; 6149061; 6149063;
6152370; 6155490; 6158661; 6164542; 6164545; 6173893; 6195053;
6234393; 6234395; 6244512; 6249008; 6328214; 6330975; 6345765;
6356949; 6367699; 6375075; 6375076; 6375344; 6431451; 6435411;
6484944; 6488209; 6497368; 6532152; 6538413; 6539422; 6621942;
6641046; 6681994; 6687403; 6688523; 6732930

There may be other U.S. and foreign patents pending.

1

Using the Computer

This chapter introduces the 70 Series Mobile Computers with Windows® Mobile® 6.5. Use this chapter to learn about the basic features and functions of the each computer, as well as the available accessories for it.

About the 70 Series Mobile Computers

The ergonomically designed Intermec 70 Series Mobile Computers are built on the Microsoft® Windows® Mobile 6.5 operating system. They are lightweight, easy-to-use, and run most software developed for the Windows Mobile platform, including standalone, client-server, and browser-based applications.

The 70 Series family of computers consists of four different models: the CN70, CN70e, CK70 and CK71. The CN70 and CN70e have the same features except that the CN70e offers extended environmental specifications and a larger keypad for data-intensive applications. The CK70 and CK71 have most of the same features, but the CK71 offers a choice of imager options and does not offer phone support. Throughout this manual, all versions of the mobile computer are referred to as 70 Series unless information is specific to a particular model of computer.

In most of the user's manual, pictures of the CN70 and CK70 represent the four models of the 70 Series computers.

CN70 Front View

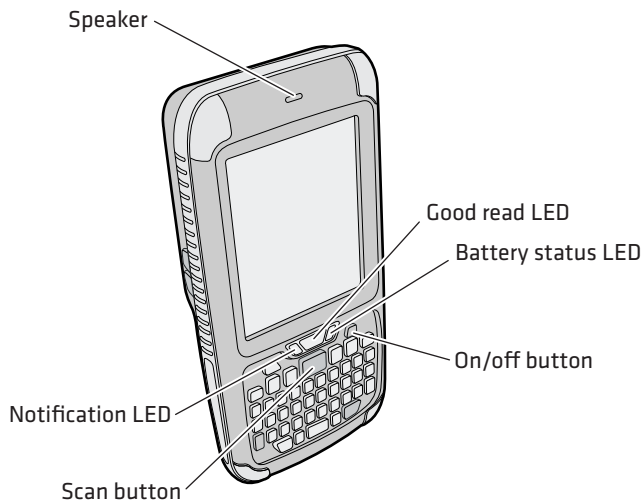

CN70 Back View

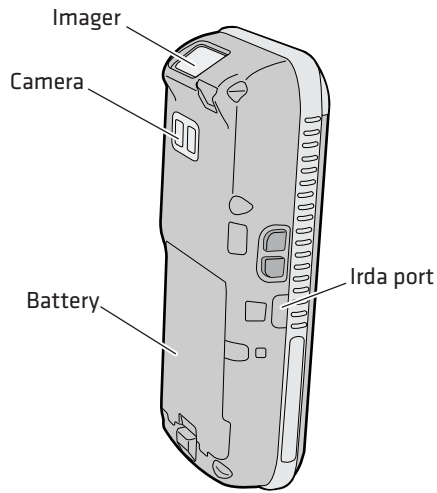

CK70 Front View



CK70 Back View

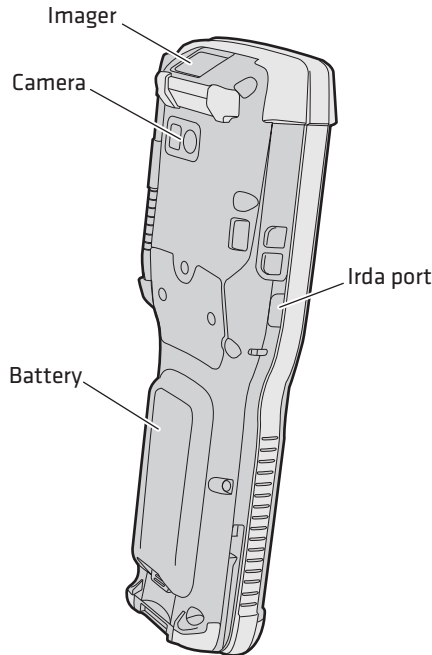

Overview of 70 Series Features

The 70 Series includes these standard features:

- EA30 area imager that can read bar codes and capture signatures
- (CK71 only) Choice of EA30, EX25, or EV12 imagers
- Multi-processor architecture with 256 MB DRAM and 1G Flash
- CDMA or UMTS capability (not available on CK71)
- 802.11a/b/g/n and Bluetooth® radios
- Embedded GPS radio
- 5-megapixel color camera
- Customer-accessible microSD slot for memory cards up to 32 GB
- Customer-accessible SIM card slot
- IrDA port with speeds up to 4 MB/s



The 70 Series Mobile Computers with an IEEE 802.11a/b/g/n radio installed is Wi-Fi® certified for interoperability with other 802.11a/b/g/n wireless LAN devices.

About the Status LEDs

Use the following illustrations and table to understand the status LEDs on your 70 Series computer. Not every 70 Series computer has all six status LEDs. For example, the QWERTY versions of the CN70 and CN70e do not have a Green key status LED.

Location of the CN70 Status LEDs

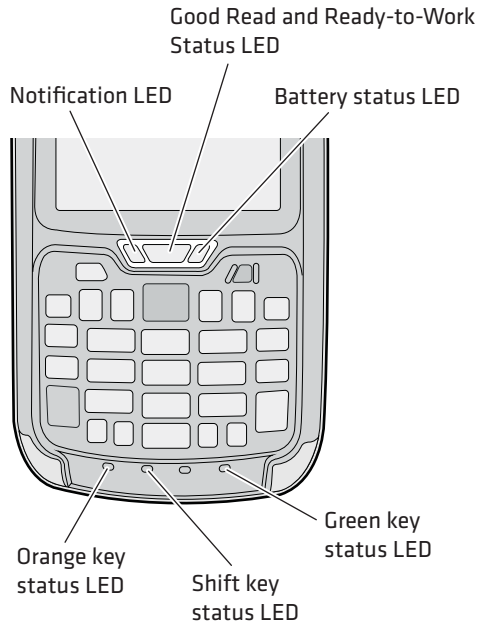

Location of the CK70 Status LEDs

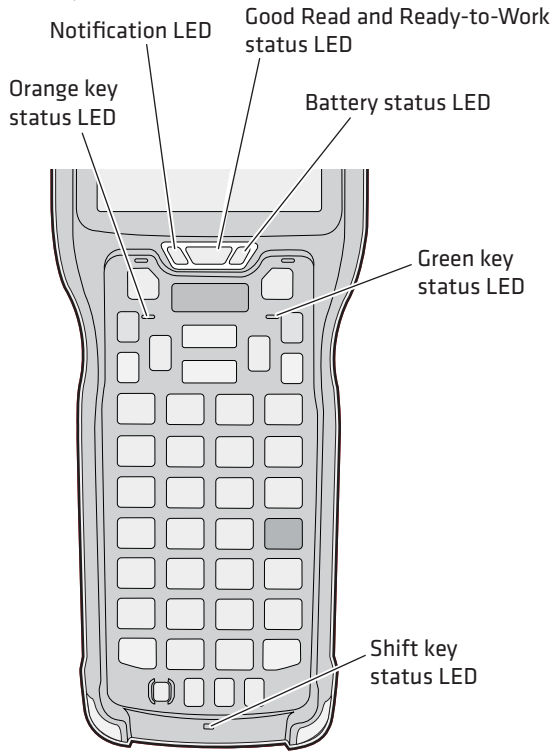

Status LED Descriptions

LED	Color	Description
Notification	Amber	The computer is notifying you of a pending alarm or message.
Good Read	Green	The computer successfully decoded a bar code.
Ready-to-Work	Blue	Intermec Terminal Emulator (ITE) is running and connected to the host or the computer is in a healthy state.
	Blinking blue	ITE is running but not connected to the host or your computer is in an unhealthy state.
Battery		See “About Battery Status” on page 12.
Key Status	Green	The Green function key is enabled.
	Orange	The Orange function key is enabled.
Shift	Red	The Shift key is enabled.

70 Series Accessories

The 70 Series computer ships with a battery. All other accessories are sold and ordered separately. For help, contact your local Intermec sales representative.

CN70 Accessories

Accessory	Description
CN70/CN70e Battery (Model 1000AB01)	This battery provides main power to the CN70 and CN70e.
CK70/CK71 Battery (Model 1001AB01)	This battery provides main power to the CK70 and CK71.
Desktop Stand	Use the desktop stand hold the 70 Series computer on your desk or a stable surface.
DEX/UCS Snap-On Adapter (Model 1000AA04)	Use this adapter to receive and send serial communications through a DEX/UCS connection.
DX1 Desktop Dock	Use the desktop dock with the: <ul style="list-style-type: none"> • 70 Series cup to charge the battery while it is installed in the computer. • 70 Series battery cup to charge the battery.
DX2 Dual Base and DX4 Quad Base	Use these charger bases with the: <ul style="list-style-type: none"> • 70 Series cup to charge two or four batteries while they are installed in the computer. • 70 Series battery cup to charge two or four batteries.
Ethernet Snap-On Adapter (Model 1000AA01)	Use the Ethernet adapter to be able to connect the computer to an Ethernet network.
Handstrap Replacement Kit	You can order and install a replacement handstrap.
Holster	Use the holster to store the computer when you need your hands free.

Accessory	Description
Magstripe Reader Snap-On Adapter (Model 1000AA06)	Use the magnetic stripe reader to be able to read magnetic cards with the computer.
RS-232 Snap-On Adapter (Model 1000AA03)	Use the RS-232 adapter to convert the connector on the bottom of the computer to a serial connector.
Scan Handle	Use the scan handle to provide better ergonomics to the computer for high-volume scanning applications.
Tethered Stylus Replacement Kit	You can order and install a replacement stylus.
USB Snap-On Adapter (Model 1000AA07)	Use this adapter to convert the bottom connector of the computer to a USB connector.
Vehicle Holder	Use the vehicle holder to hold your computer while you are using it in a vehicle.
Vehicle Power Adapter (Models 9002AX01 and 9002AX02)	Use the vehicle power adapter to provide power to the computer from your vehicle. You can choose from a 3-pin or Hirose style connector.
Vocollect Snap-On Adapter (Model 1000AA05)	Use this adapter to be able to use the Vocollect voice solution in your warehouse.

About the Battery

The 70 Series computer uses a battery pack as its main power source:

- Model 1000AB01 for the CN70 and CN70e
- Model 1001AB01 for the CK70 and CK71



The battery used in this device may present a fire or chemical burn hazard if it is mistreated. Do not disassemble it, heat it above 100°C (212°F) or incinerate it. Dispose of used batteries promptly. Keep away from children.



Note: If the computer is not using external power and you remove the battery pack, the computer goes into a power off state and then cold boots.

Charging the Battery

You need to fully charge the battery before using your computer for the first time.

To charge the battery:

- Use one of the charging accessories listed in the next table.

70 Series Charging Accessories

Charging Accessory	Charging Time
Snap-on adapters	4 hours
DX1 desktop dock and computer cup	6 hours
DX1 desktop dock and battery cup	6 hours
DX2 or DX4 base and computer cup	6 hours
DX2 or DX4 base and battery cup	6 hours
CN70, CN70e, CK70, and CK71 Vehicle Power Adapter	?? hours

Changing the Battery

If your battery power is low, you need to either charge the battery in the computer, or replace it with a charged battery.



Note: The computer resets when you remove the battery.

To change the battery:

- 1 Save your files and close any open applications.
- 2 Press the **Power** button to suspend the computer.
- 3 Disconnect the handstrap from the computer.

Removing the Handstrap From a CN70 or CN70e

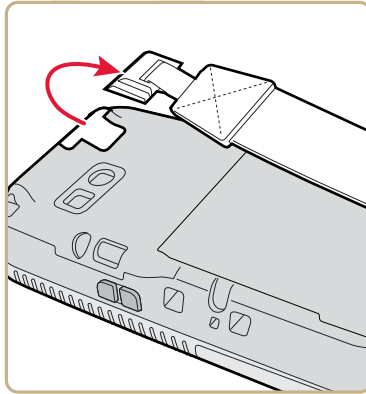

Removing the Handstrap From a CK70 or CK71

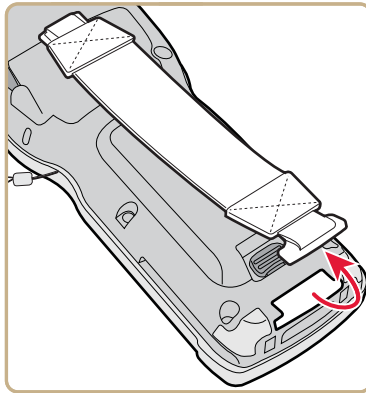

4 Remove the battery.

- On the CN70 or CN70e, push the battery release toward the bottom of the computer until the battery releases and then lift it away from the computer.

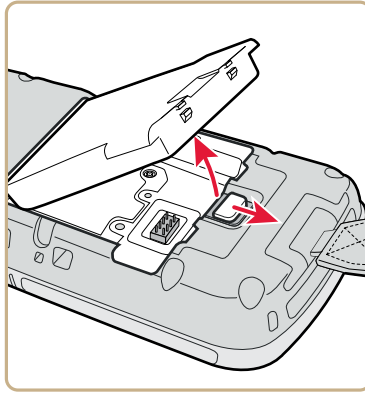

- On the CK70 or CK71, push the battery release toward the top of the computer until the battery releases and then lift it away from the computer.

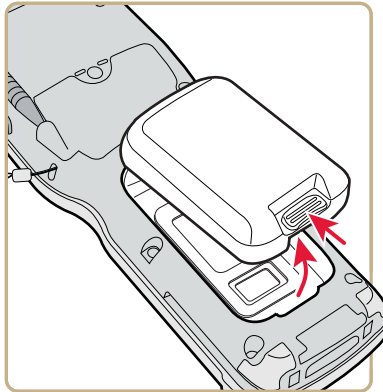







- 5 Insert the top end of a fully charged battery into the computer, and press down firmly on the bottom of the battery. Make sure that the battery release tab is fully engaged.

About Battery Status

Use the battery icon on the Title bar to see the power status of your battery. If you want more detailed information on your battery such as usage time or voltage, use the Intermec Dashboard. For more information on the Dashboard, see [“About the Intermec Dashboard” on page 102.](#)

Understanding the Battery Icon Status

Battery Icon	Status
	Battery is fully charged.
	Battery has a high charge.
	Battery has a medium charge. You should be able to work for several more hours before changing batteries.
	Battery is low. You need to charge or replace the battery soon.
	Battery is critically low. You need to replace the battery now.
	Battery is charging.
	The battery is not installed.

You can also use the battery status LED to see the charging status of your battery.

Location of the Battery Status LED



Understanding the Battery Status LED

LED State	Description
Steady green	The computer is connected to a charger and the battery is more than 95% charged.
Blinking red	The battery is low. The computer goes into Suspend mode. Charge or replace the battery.

LED State	Description
Steady red	The computer is connected to a charger and the battery is charging.
Steady amber	There is a battery error. The battery may be outside the allowable charging temperature or you may need to replace it.
Off	The computer is not on external power and the battery is operating normally.

About Battery Life and Conservation

Batteries that are stored outside the computer for long periods of time slowly discharge. Intermec recommends storing the battery in a charger to maintain battery performance.

Battery Conservation Tips

When You Want To:	Do This to Save Battery Power:
Use the computer and the Low Battery status icon appears or the Battery light comes on.	<ul style="list-style-type: none"> • Connect the computer to an external power source. • Or, save your data and press the Power button. After the computer turns off, remove the battery and insert a fully charged battery.
Stop using the computer for 5 minutes or longer.	Make sure that the low battery icon is not on the screen and the Battery LED is not on. Press and hold the Power button for about 2 seconds to suspend the computer.
Store the computer for more than a day.	<p>If you are storing the computer for a few days, like over the weekend, install a charged battery or connect the computer to a power source.</p> <p>If you are storing the computer for longer, remove and charge the battery, and then store both the battery and computer in a cool location. If you store the battery for several months, recharge the battery to keep it at peak performance.</p>
Store the battery outside the computer.	Store the batteries in a charger.

About the Keypad

The CN70 comes with either a QWERTY keypad or a numeric keypad. The CN70e comes with either a QWERTY numeric keypad or numeric function keypad. The keypad on the CN70 computers is light-sensitive. In low light conditions, the keypad automatically lights up.

CN70 QWERTY Keypad

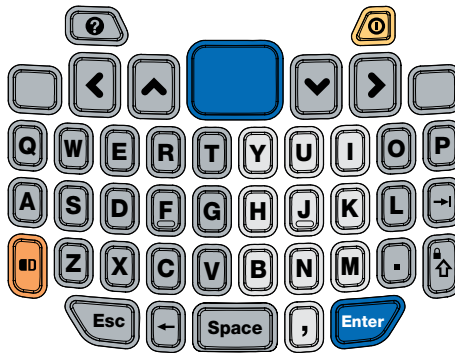

CN70 Numeric Keypad

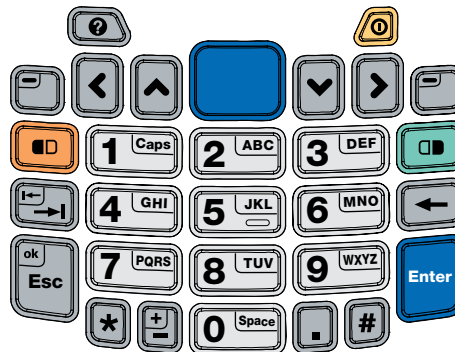

CN70e QWERTY Numeric Keypad



CN70e Numeric Function Keypad



The CK70 comes with either an alpha keypad or an alphanumeric keypad. The CK71 comes with either a numeric function keypad or an alphanumeric keypad. The keypad on the computers is light-sensitive. In low light conditions, the keypad automatically lights up.

CK70 Alpha Keypad





CK70 Alphanumeric Keypad



CK71 Numeric Function Keypad

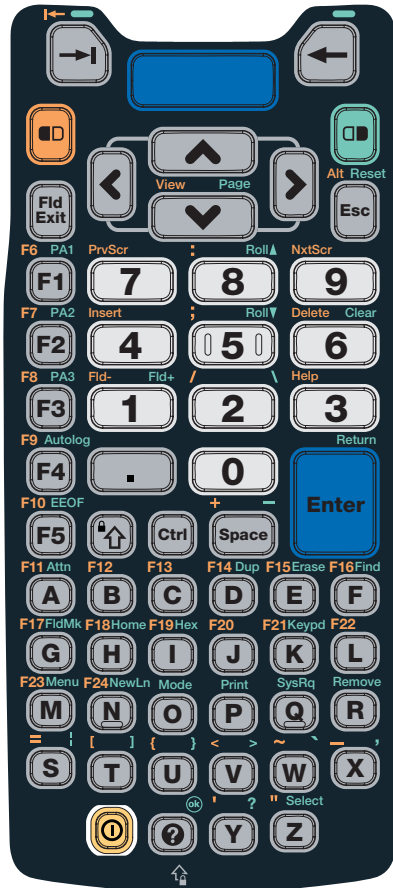

CK71 Alphanumeric Keypad**Entering Characters on the QWERTY Keypad**

You need to use the orange modifier key  and the Shift key  to access all characters and functions on the QWERTY keypad.

To type a character:

- Press the key for that character.

To type a character or access a function on the overlay:

- Press  and then press the key for the character or function.



To only type characters or access functions on the overlay:

- Press  twice to lock the orange modifier key to stay on, and then press the keys for the characters or functions.

To type a single uppercase letter:

- Press  and then the letter key.



To type all uppercase letters:

Press   to turn on Caps Lock, and then press the letter keys.

You can still type orange modifier characters by pressing  and then the key for that character.

To turn off Caps Lock, press .

Entering Characters on the Numeric Keypad

You need to use the orange modifier key  and the green modifier key  to access all characters and functions on the Numeric keypad.

To type a character or access a function printed in orange on the overlay:

- Press  and then press the key for the character or function.









To type a character or access a function printed in green on the overlay:

- Press  and then press the key for the character or function.



To type letters in the upper right corner of a key:

- Press  and then press the key one to three times depending on the position of the letter.

For example, in the upper right corner of the  key there are the letters “ABC”:

- To type “c”, press    .
- To type “C,” press   and then press   .

To only type letters:

- Press   to lock the green modifier key, and then press the key one to four times depending on the position of the letter.

While the green modifier key is locked, press  to toggle between only uppercase and lowercase letters.

To unlock the green modifier key, press .



Note: If uppercase letters are enabled and you unlock the green modifier key, you may need to press to type lowercase letters.

Entering Characters on the CK70 and CK71 Keypads

You need to use the orange modifier key , the green modifier key , and the Shift or Caps Lock key to access all characters and functions on the Alpha, Alphanumeric, and Numeric Function keypads.

To type a character or access a function printed in orange on the overlay or in the upper left corner of a key:

- Press and then press the key for the character or function.

To type a character or access a function printed in green on the overlay:

- Press and then press the key for the character or function.

To type a single uppercase letter:

- Press and then the letter key.

To type all uppercase letters:

Press to turn on Caps Lock, and then press the letter keys.

You can still type orange or green modifier characters by pressing or and then the key for that character.

To turn off Caps Lock, press .

About the Power Button

When you press the **Power** button, a dialog appears asking how you want the button to function in the future. If you accept the default settings by doing nothing, the computer will suspend (phone is on).

The Power Button Options Screen

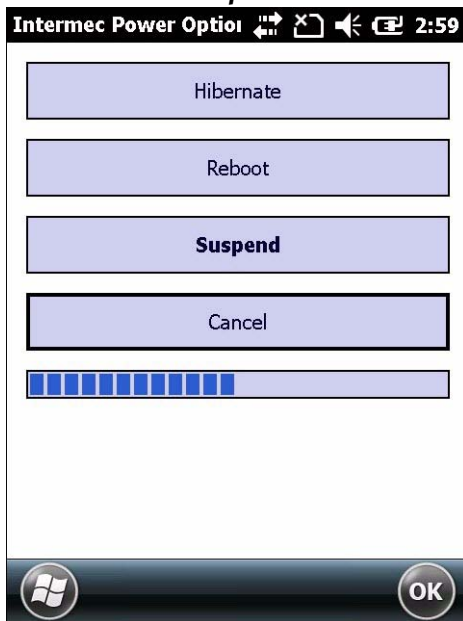

Use the following table to understand the Intermec Power Options.

Intermec Power Options

Option	Description
Hibernate	The computer powers off all radios and internal devices not involved in saving the system state.
Reboot	The computer shuts down and restarts.
Suspend	The computer powers off all radios and internal devices not involved in saving the system state, but the phone stays on to receive calls (default).
Cancel	The Power Options selection is cancelled.

The Intermec Power Options screen is customizable. You can use Intermec Settings to determine which options are available to end users, the timeout until the default choice is selected, or to disable the the Power Options screen. For more information on customizing the screen using Intermec Settings, see [“Using Intermec Settings on the Computer” on page 60](#) or see the *Intermec Settings Command Reference Manual*.

About the Intermec Dashboard Button

If the Ready-to-Work light blinks, your computer may be experiencing a problem. Press the Intermec Dashboard button (🔍) to launch the Intermec Dashboard application to see troubleshooting and status information.

For more information on Intermec Dashboard, see [“About the Intermec Dashboard” on page 102](#).

Configuring the Screen Backlight

You can turn on the backlight to see the screen better, or you can turn off the backlight to help conserve battery power.

By default, the computer goes into Screen Off mode when there is no activity. Screen Off mode turns off the backlight and display. Press a key or tap the screen to resume activity.



To configure the backlight:

- 1 Tap the battery icon at the top of the screen, and then tap the battery icon on the horizontal scroll menu.
- 2 With **Turn off backlight if device is not used for** checked, select the timeout value (30 seconds, or 1 to 5 minutes).

Adjusting the Volume

You can adjust the computer volume for your needs and your environment. The volume includes sounds you hear when you tap the screen or read bar codes with the imager. You can set the volume to off, very low, low, medium, high, very high (default), or vibrate.

To adjust the volume:

- 1 Tap the Volume icon at the top of the screen, and then tap the volume icon on the horizontal scroll menu.
- 2 Use your stylus or the  and  keys to adjust the volume slider to the volume you want, select **Vibrate**, or select **Off**.

You can also use the buttons on the right side of the computer to adjust the volume:

- The upper button increases the volume.
- The lower button decreases the volume.

Reading Bar Codes

The 70 Series computer ships with an internal imager. Depending on the imager model in your computer, you can read 1D and 2D bar code symbologies, composite symbologies, and postal codes.

You also connect the 70 Series computer to:

- cordless scanners, such as the SF51 and SR61 through Bluetooth communications. For help, see **“Connecting to a Bluetooth Scanner” on page 70**.
- tethered scanners, such as the SR30, SR60, and SR61T through the RS-232 adapter (Model 1000AA03).



Note: When the Pictures & Videos application is running, you cannot use the imager.

To read a bar code:

- 1** Enable only the bar code symbologies that you need.
- 2** Use Intermec Settings to choose the predefined imager mode that best suits your environment:

Predefined Mode	For Scanning
1D	Only 1D labels.
1D and 2D Standard	(Default) All types of bar code labels.
1D and 2D Bright Environment	In high ambient light, such as outdoors in the sunshine.
1D and 2D Reflective Surface	Glossy labels.

Predefined Mode	For Scanning
Custom	In conditions that require customized settings. For complete information about these settings, commands, and parameters, see the <i>Intermec Settings Command Reference Manual</i> .

- 3 Point the imager window at the bar code label, and hold the computer steady a few inches from the label.
- 4 Press the **Scan** button. The laser pointer and illumination beam or frame appear.

Scanning With the EA30 Imager

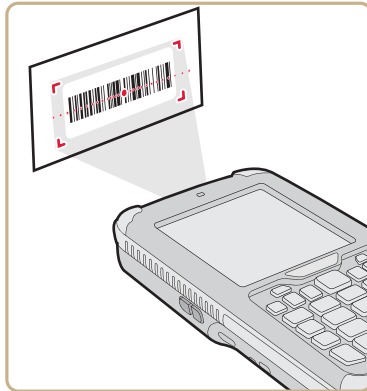

- 5 Use the laser pointer as a guide and aim toward the middle of the bar code. Make sure that the illumination beam or frame covers the bar code you are trying to decode.

When the computer successfully reads a bar code label, you hear a high beep, and the Good Read LED turns on briefly.

- 6 Release the **Scan** button.

Inserting a microSD Card

You can use a microSD™ card to increase file storage and install software. The 70 Series computers support an optional 32 GB maximum capacity microSD card.



Note: The computer resets when you remove the battery.

To install a microSD card on a CN70 or CN70e:

- 1 Press the **Power** button to turn off the computer.
- 2 Remove the battery.
- 3 Remove the two Phillips screws and open the card access door.

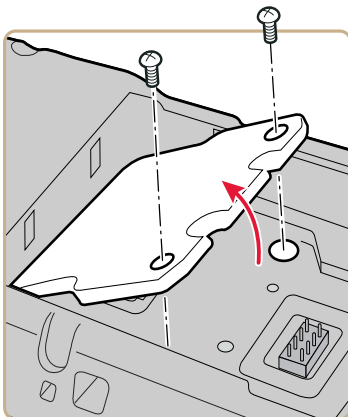

- 4 Slide the SIM card door to the left to unlock it and open the door.

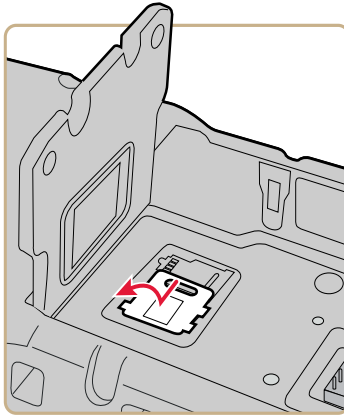

- 5 Slide the microSD card door towards the top of the computer to unlock it and open the door.

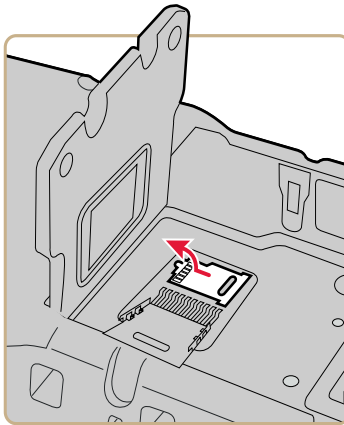

- 6 Slide the microSD card into place.

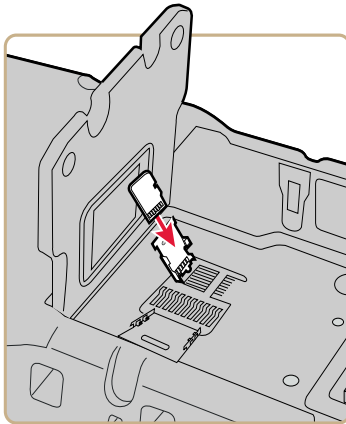

- 7 Close the microSD card door and slide it towards the bottom of the computer to lock it in place.
- 8 Close the SIM card door and slide it to the right to lock it in place.
- 9 Close the card access door and replace the two screws.
- 10 Install the battery. Press down firmly on the bottom of the battery, and make sure that the battery release tab is fully engaged.
- 11 Press the **Power** button. The computer cold boots.

To install a microSD card on a CK70 or CK71:

- 1 Press the **Power** button to turn off the computer.
- 2 Remove the two screws that attach the interface adapter cover to the back of the computer.

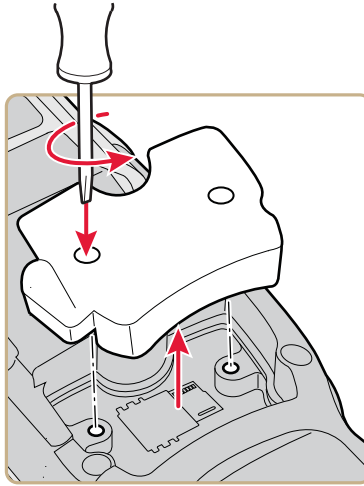

- 3** Slide the SIM card door to the left to unlock it and open the door.

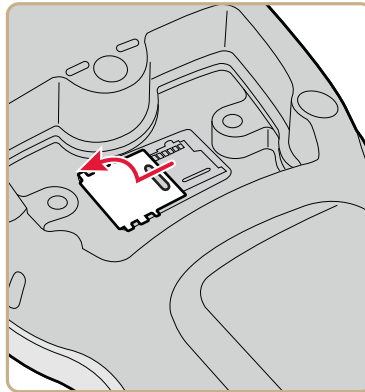

- 4** Slide the microSD card door towards the top of the computer to unlock it and open the door.

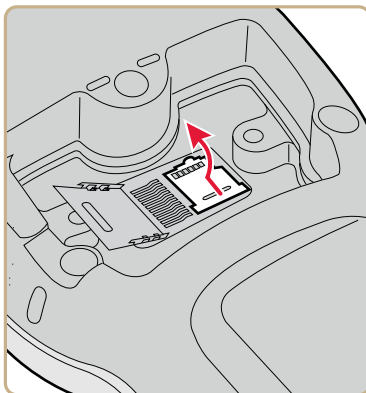

- 5** Slide the microSD card into place.

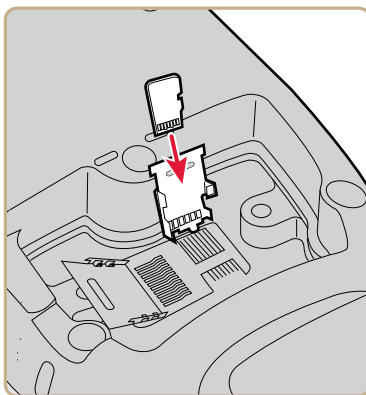

- 6** Close the microSD card door and slide it towards the bottom of the computer to lock it in place.
- 7** Close the SIM card door and slide it to the right to lock it in place.
- 8** Replace the interface adapter cover and attach with the two screws removed in Step 2.
- 9** Install the battery. Press down firmly on the bottom of the battery, and make sure that the battery release tab is fully engaged.
- 10** Press the **Power** button. The computer cold boots.

Transferring Files To and From Your PC

You can use Microsoft ActiveSync (Windows XP or earlier) or Windows Mobile Device Center (Windows Vista or Windows 7) to establish a connection between your computer and a PC. After you connect to your PC, you can transfer files, synchronize files, remotely debug, and perform other device management activities. ActiveSync and Windows Mobile Device Center are a free applications available from the Microsoft web site at www.windowsmobile.com/getstarted.

To establish an ActiveSync partnership between your computer and a PC, you need to physically connect your computer to your PC using these accessories:

- USB snap-on adapter (Model 1000AA07)
- USB cable

To transfer files to and from your PC:

- 1 Download ActiveSync from the Microsoft web site and install ActiveSync on your PC.
- 2 Follow the onscreen instructions to establish a partnership. When the partnership is established, the Microsoft ActiveSync screen appears on your PC.

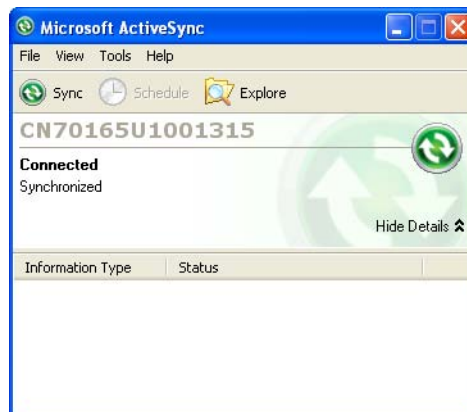

2

Understanding the User Interface and Intermec Applications

Use this chapter to learn about the Windows® Mobile® 6.5 user interface and how to interact with the screen. You can also use this chapter to learn about the Intermec applications on your computer, as well as additional Intermec applications you can download.

About the User Interface

The user interface for the Microsoft® Windows® Mobile 6.5 operating system is different from previous versions of Windows. The interface is touch-friendly and easier to navigate. Use the following sections to understand how to interact with Windows Mobile 6.5.

About the Home Screen

When you turn on your mobile computer, the Home screen is the first screen that appears. The Home screen contains three navigation bars: the Title bar, the horizontal scroll bar, and the Tile bar.

The Windows Mobile 6.5 Home Screen

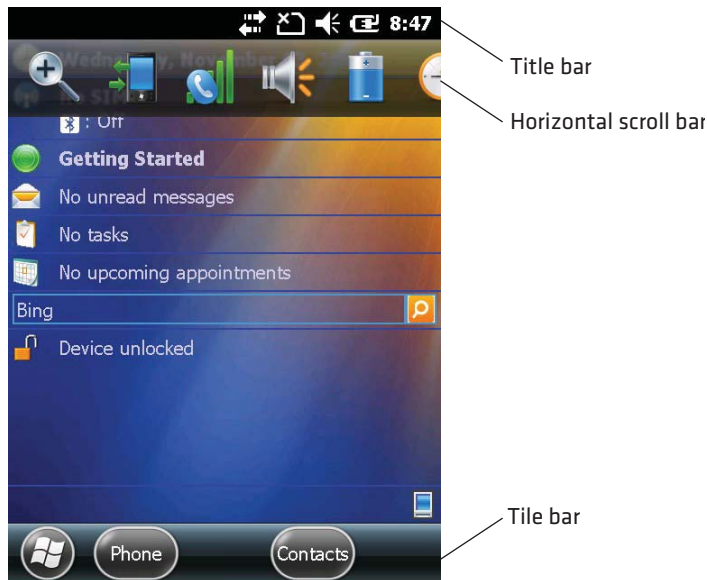

Use the Title bar icons to view the current status of information such as signal strength and battery power remaining. For more information on the Title bar icons, see **“Title Bar Status Icons”** on the next page.

A horizontal scroll bar appears when you tap an icon in the Title bar. This horizontal scroll bar makes it easy to access the applications associated with the Tile bar icons. The horizontal scroll bar also contains a magnifier which improves the touch experience by making parts of the screen large enough to access with your finger.

The horizontal scroll bar also replaces tabs within Windows screens and allows for easier navigation.

Clock & Alarms Screen With Horizontal Scroll Bar

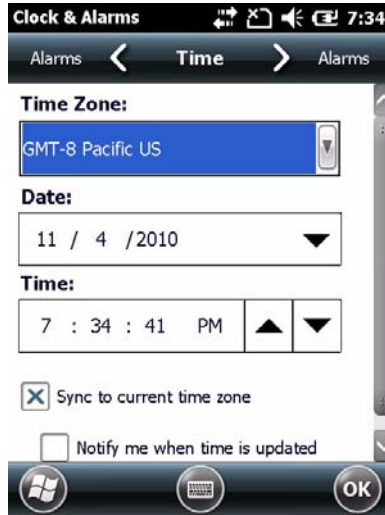

Use the Tile bar to navigate between screens and within applications. The icons available on the Tile bar change depending on the application you are using.

Interacting With the Screen



The Windows Mobile 6.5 interface supports the use of gestures with the finger or stylus to move around the screen. The table below explains the supported gestures.



















Gesture	Description
Tap	Represents the left click of a mouse.
Double Tap	Represents the left double-click of a mouse.
Hold	Represents the right click of a mouse when you press and hold on the screen and a context menu appears.
Flick	Initiates scrolling in the direction (horizontal or vertical) the finger or stylus moves across the screen.
Pan	Press and hold on the screen and then drag in any direction.



















Title Bar Status Icons







Clickable icons in the Title bar immediately show you the status of your network, your phone, the volume, the battery, and the time. Use the following table to understand what the icons mean.

Title Bar Status Icon Descriptions

Icon	Description
	You have a new notification.
	You have a new text message.
	You have a new e-mail message.
	You have a new instant message.
	You missed a call.
	The speakerphone is on.
	The phone is roaming.
	An alarm is set.
	The microphone is on.
	An internet call is in progress.
	A Bluetooth headset is detected.
	An ActiveSync connection has been established.
	There was a problem with the ActiveSync synchronization.
	An ActiveSync synchronization is in progress over USB.
	A UMTS network is available.
	Connecting to a UMTS network.

Icon	Description
	A UMTS connection is active.
	A 3G+ network is available.
	An EDGE network is available.
	Connecting to an EDGE network.
	An EDGE connection is active.
	A GPRS network is available.
	Connecting to a GPRS network.
	A GPRS connection is active.
	An HSDPA network is available.
	Connecting to an HSDPA network.
	An HSDPA connection is active.
	Bluetooth is on.
	Wi-Fi is on but not connected, and no networks are detected.
	Wi-Fi is not connected to a network, and other networks are detected.
	Other wireless networks are detected.
	Connected to a wireless network.
	Synchronizing through a Wi-Fi connection.
	Connected to a wireless network, and other networks are detected.
	Information about a new wireless network is available.

Icon	Description
	A network connection is active.
	A network connection is inactive.
	The phone has maximum signal strength.
	The phone has no signal.
	The phone capability is off.
	The phone has no service.
	The phone is searching for service.
	Data is being transferred.
	A voice call is in progress.
	A voice call is on hold.
	There is no SIM card present in the computer.
	The volume is off and the phone is set to vibrate.
	The volume is on.
	The volume is off.
	The battery has a full charge.
	The battery has a high charge.
	The battery has a medium charge.
	The battery has a low charge.
	The battery has a very low charge.

Icon	Description
	The battery is attached to external power and is charging.
	No battery is installed in the computer.
	Call forwarding is on.
	Voice mail is off.
	GPS locator is off.
	GPS locator is on.

Aligning the Screen

You may need to align your screen if you tap on one area and it registers in a different part of the screen.

To align the screen:

- 1) Tap **Start (t)** > **Settings** > **System** > **Screen**.**
- 2) Follow the prompts on the screen to complete the alignment.**

Make sure you only use the stylus to complete the alignment process.







About Intermec Applications



Intermec provides many useful applications to help you configure, troubleshoot, and connect your computer to other devices and networks. You can also download additional applications from Intermec to help you use all of the features your 70 Series computer includes.

Applications Available on the Mobile Computer

Use this table to understand some of the Intermec applications available on your computer.

Intermec Applications Available on the Mobile Computer

Icon	Application	Description
	ProfileSettings	Use ProfileSettings to easily configure the computer for a specific use. You can choose predefined values for the Camera, Power, and Scanning. To apply a profile setting: <ul style="list-style-type: none"> • Tap the Profile Setting you want to use. You will see a message that changes are saved and a check mark appears next to your choice. . For more information on modifying ProfileSettings options, see “Configuring ProfileSettings With Intermec Settings” on page 66.
	ISpyWiFi	Use ISpyWiFi to check your 802.11 status and diagnose what is wrong with the connection. For more information, see “Checking 802.11 Network Status” on page 105.
	iGPS	You can use the iGPS application to improve the performance of GPS on your computer. For more information, see “Improving GPS Performance on the Computer” on page 58.
	Wireless Center	Use the Wireless Center to turn radios (WiFi, Bluetooth, phone) on and off and configure settings for each radio.
	Bluetooth Audio	Use the Bluetooth Audio application to connect to a Bluetooth headset or hands-free device. For more information, see “Connecting to a Bluetooth Audio Device” on page 73.
	Intermec Settings	Use Intermec Settings to configure your computer. You can use Intermec Settings to individually configure a computer or you can use it through SmartSystems to configure all of your computers. For more information, see “Using Intermec Settings on the Computer” on page 60.

Icon	Application	Description
	Wireless Scanning	Use the Wireless Scanning application to connect to a Bluetooth scanner. For more information, see “Connecting to a Bluetooth Scanner” on page 70.
	Wireless Printing	Use the Wireless Printing application to connect to a Bluetooth printer. For more information, see “Connecting to a Bluetooth Printer” on page 72.

Applications You Can Download to the Mobile Computer

You can download several Intermec applications from the website that extend the capabilities of your 70 Series computer. All of the applications listed below are available from the Intermec website. To find the application you want, go to **www.intermec.com > Support > Downloads** and then enter the information to find your 70 Series computer.

About SmartSystems Foundation

SmartSystems™ Foundation is an easy-to-use software platform that provides IT Administrators and Integrators a single, integrated portal for hands-free provisioning, deployment, and management of Intermec devices minimizing the effort spent on software upgrades, equipment monitoring, maintenance and trouble-shooting.

SmartSystems Foundation provides a consistent way to manage Intermec devices including mobile computers, RFID readers, printers and bar code scanners, located on-site or remote, to make the most of limited IT resources, and lower the total cost of ownership for Intermec data collection equipment. SmartSystems Foundation can be downloaded at no charge from the Intermec web site. For more information, visit **www.intermec.com\SmartSystems**.

About Features Demo

Intermec Features Demo provides a simple way to explore the key features of your mobile computer. You will find applications that demonstrate scanning, document imaging, image capture, printing, GPS functionality, and the digital compass. Many of the applications that are part of Features Demo also have separate full-featured versions that you can download and license for your computer.

About Intermec Launcher

Intermec Launcher 1.01 is a Microsoft® Windows® application, designed for Intermec mobile computers, that provides a platform from which other applications may be launched while attempting to provide a locked-down environment. You can configure Intermec Launcher for your specific application requirements. You can download and use Intermec Launcher for a 60-day evaluation period. After the evaluation period expires, you will need to purchase a license.

About Intermec Browser

Intermec Browser is a locked-down web application for your computer that is compatible with Microsoft™ Internet Explorer. You can configure Intermec Browser for your specific application requirements and design your own web pages. You can download and use Intermec Browser for a 60-day evaluation period. After the evaluation period expires, you will need to purchase a license.

About Intermec Connection Manager

Intermec Connection Manager is a software application and API interface that provides seamless network roaming for Intermec mobile computers configured with one or more wired or wireless technologies (Ethernet, 802.11, GPRS, CDMA). Intermec Connection Manager works in the background to automatically establish and maintain connections. You can download and use Intermec Connection Manager for a 60-day evaluation period. the evaluation period expires, you will need to purchase a license.

About Image Capture

The Intermec Image Capture application is provided for use on the 70 Series computers with an EA30 imager. Image capture provides a way for users to capture a high quality grayscale image with a mobile computer. Image Capture also allows you to change settings to provide the best image possible for the conditions present. You do not need to license Image Capture.

About eMDI

Intermec Enhanced Mobile Document Imaging Application (eMDI) is a professional document capture application that enables you to capture images of full page documents (8.5 x 11 or A4 paper sizes). You can transfer the images from your mobile computer to a PC or server. For more information, see the *[Intermec Enhanced Mobile Document Imaging User's Guide](#)*. You can download and use eMDI for a 60-day evaluation period. After the evaluation period expires, you will need to purchase a license.

3

Using the Phone

You can use the cell phone to send and receive telephone calls, as well as transmit data through cellular wide-area networks (WANs).

About the Phone

The 70 series mobile computer supports two types of cellular technology:

- CDMA
- UMTS

Phone features on the computer include a speaker and a microphone. You can also use a Bluetooth headset or hands-free kit. The default setting for the phone is enabled.

After you turn on the phone and activate service with your wireless carrier, you can customize the phone features and network settings. For more information, see the online help on your mobile computer.

Activating the UMTS Phone

You use a SIM card to activate the UMTS phone on your computer. You can purchase the SIM card from your network provider.



Note: The computer resets when you remove the battery.

To install the SIM card and activate the UMTS radio:

- 1** Press the **Power** button to turn off the computer.
- 2** Push the battery release tab forward until the battery releases, and lift the battery away from the computer.
- 3** Remove the two Phillips screws and open the card access door.

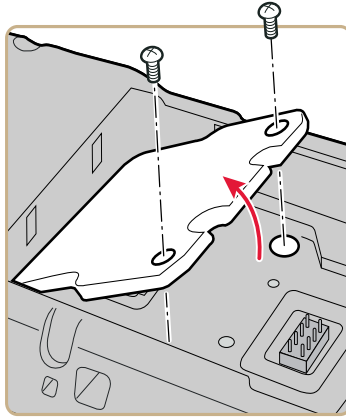

4 Slide the SIM card door to the left to unlock it and open the door.

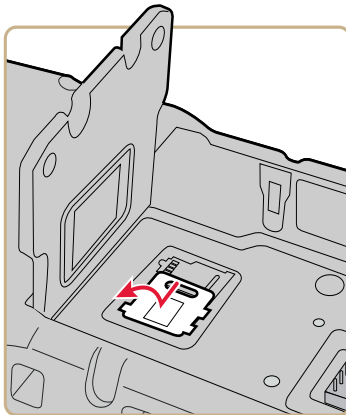

5 Slide the SIM card into the slot in the card access door.

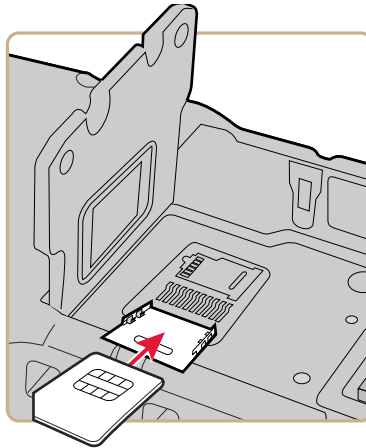

- 6 Close the SIM card door and slide it to the right to lock it in place.
- 7 Close the card access door and replace the two screws.
- 8 Install the battery. Press down firmly on the bottom of the battery, and make sure that the battery release tab is fully engaged.
- 9 Press the **Power** button. The computer cold boots.

Activating the CDMA Phone

To activate the CDMA radio module in your mobile computer, you need to contact your wireless carrier and set up an account for each mobile computer. The following table lists the carriers that Intermec currently supports. If your carrier is not listed in the table, please contact Intermec product support to see if it is now supported.

Currently Supported Carriers

Country	Carriers
United States	Sprint, Verizon

The carrier will require the Electronic Serial Number (ESN) to start the activation process. You can find the ESN:

- on a label located in the upper right corner of the battery compartment.
- on the outside of the computer shipping box.

The activation process is slightly different for each CDMA carrier. Your carrier sales contact and an Intermec representative can guide you through the process.

After you supply the ESN to your carrier, they will respond with values that you must enter using the Windows Mobile Activation Wizard (if required). Some of the supported carriers do not require you to enter any values. The following table shows the carriers, the correct activation method to use, and the values that you need to activate your phone.

Values Required for CDMA Phone

Carrier	Activation Method	Activation Values You Need
Sprint	Activation Wizard	<ul style="list-style-type: none"> • Master Subsidy Lock (MSL) or activation code • MDN • Mobile Station Identifier (MSID)
Verizon	<ul style="list-style-type: none"> • Dial *22899 • Activation Wizard 	None. All parameters are automatically transferred wirelessly.

After activation, the settings are permanently stored in the CDMA module. Changing the OS or SSPB loads will not affect any of the settings or activation parameters stored in the WAN modem.

Starting the Activation Wizard

Depending on your wireless carrier, you may need to use the Windows Mobile Activation Wizard to activate your phone.

To start the activation wizard:

- 1** Tap **Start > Phone**, or tap the **Phone** button on the Tile bar.
The phone application starts.
- 2** Tap **Menu () > Activation Wizard**.

Turning the Phone On and Off

Before you can start using your phone, you need to enable it. You can use Wireless Center to enable and disable your phone, as well as Bluetooth and Wi-Fi communications.

To turn on the phone using Wireless Center:

- 1** Tap **Start** > **Settings** > **Connections** > **Wireless Center**.
- 2** Tap **Phone** to turn on the Phone
- 3** (Optional) To configure the phone, tap **Menu** in the tile bar at the bottom of the screen.
- 4** Tap **OK** when you are done configuring the options.
- 5** Tap **OK** to close Wireless Center.

Making a Phone Call

After you activate your phone, you are ready to start making phone calls.

To make a phone call:

- 1** Press **Phone**.
- 2** Tap the keys to enter the telephone number you want to call, and tap **Talk**.

Making an Emergency Phone Call

You can use the UMTS phone to make an emergency phone call even if the SIM card is missing. When the SIM card is not installed, the phone will show that you have no service. However, if you dial certain emergency numbers (such as 112, 911, 000, 08, 118, 119, and 999) the call will go through.

4

Using the Camera

You can use the color camera to take pictures and record videos.

About the Color Camera

The camera and flash are located on the back of the computer. You run the Pictures & Videos application to access the camera features. In this application, you can:

- take, view, and edit pictures.
- record and launch video clips stored on the computer or a microSD card.
- configure camera options.

You can also send pictures and video clips to others or save an image as the background on the Home screen.



Note: While the Pictures & Videos application is running, you cannot use the imager.

Taking a Picture

You can take photos in high, normal, or low quality, with image sizes up to 2048 x 1536 pixels. When you take a picture, the image is saved as a .jpg file and stored in the /My Documents/My Pictures folder.

To take a picture:

- 1** Tap **Start > Pictures & Videos**.
- 2** Tap the **Camera** icon in the grid or the **Camera** button on the Tile bar, or press **Enter**.
- 3** Using the screen as a viewfinder, move the camera until you have the image you want to take a picture of.
- 4** Tap **Take Pic** on the Tile bar or press **Enter** to take and save the picture. If you choose to save your pictures to Main memory, they are saved to permanent storage on your mobile computer.

Recording a Video

You need to switch to video mode to record video. When you record video, the video is saved as an .mp4 file and stored in the /My Documents/My Pictures folder.

To switch to Video mode and record video:

- 1 Tap **Start > Pictures & Videos**.
- 2 Tap the **Camera** icon in the grid or the **Camera** button on the Tile bar, or press **Enter**.
- 3 Tap **Menu > Video**.
In the lower right, the camera icon turns into a video camera. On the Tile bar, the **Record** button replaces the **Take Pic** button.
- 4 Using the screen as a viewfinder, move the video camera until you see the scene you want to video record.
- 5 Tap **Record** on the Tile bar or press **Enter** to start recording.
- 6 When you are done, tap **Stop** or press **Enter** to stop recording and save the video.

If you choose to save your videos to Main memory, they are saved to permanent storage on the computer.

Saving Pictures and Videos to an SD Card

Pictures and videos are automatically saved to the main memory on your computer. You can save your pictures and video to an SD card to easily transport them to another device.

To save picture and video files to an SD card

- 1 Install a microSD card. For help, see [“Inserting a microSD Card” on page 26](#).
- 2 Tap **Start > Pictures & Videos**.
- 3 Tap the camera icon.
- 4 Tap **Menu > Options**.
- 5 From the **Save files to** list, select **SD card**, and tap **OK**.

5

Using GPS

The 70 Series computers come equipped with an integrated Global Positioning System (GPS) receiver. It can deliver standards-based National Marine Electronics Association (NMEA) data strings to GPS applications.

About the Integrated GPS on Your Computer

Intermec recommends that you use the GPS Intermediate Driver (GPSID) instead of directly accessing the GPS hardware. The GPSID is a Microsoft software component that interacts between applications and the GPS hardware. The GPSID supports Extended Ephemeris, which enhances GPS performance by:

- reducing the amount of time it takes your GPS receiver to acquire a fix.
- eliminating the need to obtain precise satellite data information from the GPS satellites.

As a Microsoft software component, the GPSID also:

- allows multiple applications to simultaneously access the GPS data stream.
- provides access to GPS data without requiring applications to recognize and parse NMEA syntax.

Using the GPSID Installed on the Computer

To use the GPSID installed on your mobile computer, you need to configure the GPSID settings.

To configure your GPSID settings:

- 1 Tap **Start** > **Settings** > **System** > **External GPS**. The GPS Settings screen appears with **Programs** selected.

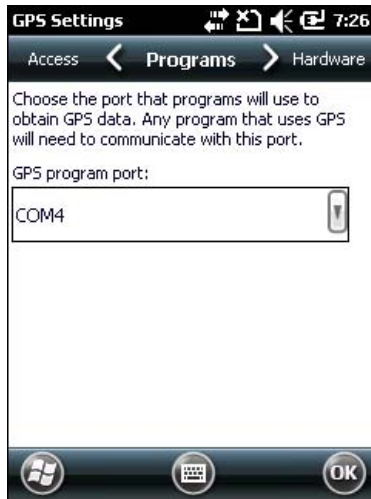

- 2 Select the COM port that you want your programs to use to get GPS data from your computer.
- 3 Tap **Access** in the horizontal scroll bar and select the **Manage GPS automatically** check box.



- 4 Tap **ok**.

Improving GPS Performance on the Computer

Use the iGPS application to improve the performance of the GPS on your CN70, CN70e, or CK70 computer. The integrated GPS module has three operating modes:

- Standalone
- MS assisted
- gpsOneXTRA™

In Standalone mode, the GPS module relies solely on GPS satellites to determine position.

In MS Assisted mode, the computer can determine position without receiving GPS signals directly from satellites; instead, the computer receives GPS signals and information provided by the cellular network. Even when the computer can receive a satellite signal, MS Assisted can improve position accuracy and reduce the time to determine initial position (Time-To-First-Fix). Check with your cell phone carrier for availability and pricing for MS Assisted service.

Qualcomm's gpsOneXTRA Assistance technology provides enhanced operation for Standalone GPS. This option enables the UMTS-enabled computer to automatically download a small assistance data file from the XTRA servers through a brief internet access session.

Another option you can configure with iGPS is the fix interval. The fix interval defines how often the GPS should provide new information. Larger intervals use less power, but many applications require small intervals to work correctly. The default for fix interval is 4.



Note: Anytime you change the GPS settings, the phone module will reset automatically. It will not affect the functionality of the computer.

To improve GPS performance:

- 1) Go to **Start > Settings > System > iGPS**.
- 2) In the **Fix Interval** tab, enter a value for the fix interval. The default setting is 4 and should be optimized for most applications.
- 3) Tap the **Fix Type** tab and select Standalone (1), MS assisted (2), or **Enable gpsOneXTRA** (check box).
- 4) Click **OK**.

6

Configuring the Computer

Use this chapter to learn about the available methods for configuring your mobile computer and how to use Intermec Settings. You can also use this chapter to learn how to configure network communications and wireless security.

How to Configure the Computer

You can configure many parameters on the 70 Series computer such as the bar code symbologies it decodes or the network settings. The values you set for these parameters determine how the computer operates.

There are several ways to configure the 70 Series computer:

- Directly on the computer. You can use Intermec Settings directly on the 70 Series computer to change only the settings on that computer. For more information, see **“Using Intermec Settings on the Computer” on page 60**.
- Remotely using Intermec SmartSystems Foundation. When you use SmartSystems, you can remotely configure all your 70 Series computers as well as other SmartSystems-enabled Intermec computers and peripherals. For more information, see **“Using Intermec Settings Remotely With SmartSystems Foundation” on page 67**.
- You can use a third-party device management product that supports the 70 Series computer and Intermec Settings, such as Soti MobiControl or Wavelink Avalanche. For more information, visit the **Device Management** page on the Intermec web site.
- You can use imager configuration bar codes to enable or disable symbologies, reset to factory defaults, and set predefined imager modes. For more information, see **“Imager Configuration Bar Codes” on page 77**.

You can also configure the computer with configuration bundles that you create using SmartSystems Foundation. For more information, see the SmartSystems Foundation online Help.

Using Intermec Settings on the Computer

Use Intermec Settings to configure parameters for Intermec applications on the 70 Series computer as well as some device-specific parameters like volume. You can configure parameters for important functions like data collection and communications.

Starting Intermec Settings

Intermec Settings is located on the Windows Mobile 6.5 System screen.

To start Intermec Settings:

- Tap **Start** > **Settings** > **System** > **Intermec Settings**.

The Intermec Settings Main Menu appears.

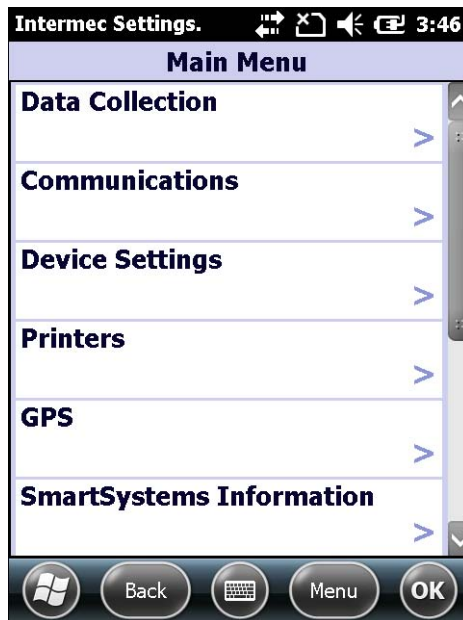

About the Structure of Intermec Settings

Finding the parameters you want to modify in Intermec Settings can be challenging. Use the tables below to help find the parameters you want to configure. Each table contains the parameters for one of the Intermec Settings Main Menu options.

If you see > next to a menu option, there are more screens available in the next level. If you see ... next to a menu option, there is only one more screen available.

Most parameters are saved as soon as you tap **OK**. Some settings such as the Serial Port Switch require you to reboot the computer for the changes to take effect.

Data Collection Menu

Data Collection Options	Parameters You Can Configure
Internal Scanner	<ul style="list-style-type: none"> • Symbologies • Scanner settings • Imager settings • Decode security
Dock Tethered Scanner	<ul style="list-style-type: none"> • Symbologies • Scanner settings • Scanner port settings • Imager settings • Decode security
Camera	<ul style="list-style-type: none"> • Symbologies • Scanner settings • Camera settings • Decode security
BT-Configure on Connect	Bluetooth-configure on connect
Magstripe Reader	<ul style="list-style-type: none"> • Enable magstripe reader • Reader model (read-only)

Communications Menu

Communications Options	Parameters You Can Configure
Device Name	Device name
802.11 Radio	<ul style="list-style-type: none"> • Security choice • Security settings • IP settings • Certificates
Ethernet Adapter	IP settings
Bluetooth	Bluetooth settings (power, discoverable, connectable, and so on)
WWAN Radio	<ul style="list-style-type: none"> • Add WWAN connection • Edit WWAN connections • Manage WWAN radio • WWAN information
Serial Port Switch	Serial port switch settings (IrDA, docking connector, and back interface)

Device Settings Menu

Device Settings Options	Parameters You Can Configure
Date and Time	Date and time settings
Good Read	<ul style="list-style-type: none"> • Internal scanner • Dock tethered scanner • Bluetooth scanner
Volume	Volume settings (beeper and voice, headset beeper, and vibrate mode intensity)
Backlight	Backlight settings (display backlight, keypad backlight, and light level)
Screen	Screen rotation
Keypad	Scan button remapping
Power Management	<ul style="list-style-type: none"> • Power button • Battery power • External power
Compass Settings	Compass settings (magnetic declination, magnetic inclination, and custom value)
Sensors	<ul style="list-style-type: none"> • Data streaming • Screen rotation • Device off
Storage Options	USB connections
System Component Versions	System component versions (read-only)
IDL Runtime Versions	ITC50 (read-only)
Profiles	<ul style="list-style-type: none"> • Camera • Power • Scanning
Features Disabled by Policy	None (read-only)

Printer Menu

Printer Options	Parameters You Can Configure
Printer	Printer settings (Auto detect printer, memory, display, and so on)

GPS Menu

GPS Options	
GPS	Bread crumbing settings

SmartSystems Information Menu

SmartSystems Information Options	Parameters You Can Configure
Identity	Identity information (hardware version, firmware version, OS version, and so on) (read-only)
Administrator	Administrator settings (name, phone, and email)
Location	Location settings (country, state, city, campus, and detail)
Information	Device Notes (read-only)

Virtual Wedge Menu

Virtual Wedge Options	Parameters You Can Configure
Enable Virtual Wedge	Enable virtual wedge
Bar Code Scanner Wedge	Bar code scanner wedge settings (bar code scanner grid and label encoding)
Magstripe Reader Wedge	Magstripe Reader Grid

Core Messaging Service Menu

Core Messaging Service Options	Parameters You Can Configure
Server IP	Server IP (read-only)
Associated Server IP	Associated server IP
Broadcast Name	Broadcast name
Port	Port (read-only)
Keep Alive Ping Interval	Keep alive ping interval

Device Monitor Menu

Device Monitor Options	Parameters You Can Configure
Device Health Controls	<ul style="list-style-type: none"> • Enable health data collection • Enable Blue light • Set rule file location • Set data refresh periods
Device Health Screen Captures	Device health screen capture settings (directory and screen capture allowed)
Disabled Executables	None (read-only)
Device Wipe	Device wipe settings (enable wipe and interval)

License Manager Menu

License Manager Options	Parameters You Can Configure
About	About settings (read-only)
License Vault	None (displays applications that are licensed)

Location Services Menu

Location Services Options	Parameters You Can Configure
Server	Server settings (port and enable server)
Virtual GPS	Virtual GPS settings

For more information on all parameters in Intermec Settings, see the [Intermec Settings Command Reference Manual](#).

Navigating in Intermec Settings

You can easily navigate through the screens in Intermec Settings to find the parameter you need to configure.

To move down a level in Intermec Settings:

- Tap the menu item in the list.

To move back a level in Intermec Settings:

- Tap **Back** or **Cancel** on the Tile bar.

To save a parameter setting:

- Tap **OK**.

To exit Intermec Settings:

- Tap **Menu > Exit** or **OK**.

Configuring ProfileSettings With Intermec Settings

A profile is a set of predefined values that you can easily apply to the computer to ensure optimal performance in a specific scenario. The end user does not need to figure out the “right” settings because we have already done that work for you. ProfileSettings is available from the Start menu so you can make it available to the end user for easy configuration.

Use Intermec Settings to determine the profiles you want the end user to see in the ProfileSettings application.

To configure the profile information an end user can access:

- 1) Go to **Device Settings > Profiles**.
- 2) Select **Camera**, **Power**, or **Scanning**.
- 3) From the Camera, Power, or Scanning submenu, check or clear the **Display** check box for the settings you want to have available to the end user.
- 4) Click **OK** to save your selection.

Restoring Default Settings

You can easily restore a menu to its default settings or all of the Intermec Settings parameters to their default settings if necessary.

To restore menu defaults:

- 1) Navigate to the menu you want to restore to defaults.
- 2) Tap **Menu > Restore Menu Defaults**.
- 3) When prompted, tap **Yes** to restore the menu default settings.
- 4) If prompted to refresh the computer, tap **Yes**.

To restore all defaults:

- 1) Tap **Menu > Restore All Defaults**. The application asks if you are sure you want to restore all defaults.
- 2) Tap **Yes**.

After several minutes, all of the default settings are restored.

Hiding Menu Items in Intermec Settings

You can hide items in the Intermec Settings menus if you do not want to have them available for other users to access. Hidden items are not saved when you back up your settings in the SmartSystems console.

On the 70 Series computer, you can:

- hide menu items by tapping and holding the item, and then choosing **Hide Menu Item** from the popup list. When asked if you want to hide the menu, tap **Yes**.
- restore hidden items in a single menu, by tapping and holding the menu bar where the item was hidden, and then choose **Restore Item Default** from the popup list.
- restore all hidden items in all menus, by tapping **Menu > Unhide All Items**.



Note: When you restore default settings in Intermec Settings, only the settings for visible items are restored to defaults. The settings for hidden menu items are not affected.

Using Intermec Settings Remotely With SmartSystems Foundation

Your 70 Series computer is SmartSystems-enabled, which lets you open Intermec Settings from the SmartSystems console to remotely configure all of your mobile computers. For more information on SmartSystems, see [“Managing the Computer Using SmartSystems” on page 92](#).

To open Intermec Settings from the SmartSystems console:

- 1) In the SmartSystems console, select a mobile computer and right-click.
- 2) From the menu, select **Intermec Settings**.
- 3) Configure the settings you need to change. As you choose parameters from the tree structure, help for each parameter appears in the upper right pane of Intermec Settings.
- 4) When you are done making changes, choose **File > Save Settings**.

For help using Intermec Settings, click **Help > Contents**. For information on all of the parameters in Intermec Settings, see the *Intermec Settings Command Reference Manual*.

About Network Communications

You can easily add the 70 Series to your wireless or wired data collection network. You can connect your computer using:

- 802.11b/g radio communications.
- Ethernet communications.
- Bluetooth communications.
- USB and serial communications.

Configuring 802.11b/g Radio Communications



Make sure all components with antennas are at least 30 cm (1 ft) apart when power is applied. Failure to comply could result in equipment damage.

The 70 Series computer contains an 802.11 radio to transfer data using wireless communications and supports the TCP/IP network protocols. This section of the manual assumes that your wireless network is set up, including your access points.

To use wireless communications in a TCP/IP network:

- 1 Configure these parameters on each mobile computer in the network:
 - Network name (SSID)
 - IP settings (if not using DHCP)
- 2 Make sure the mobile computer is talking to the network and that the network can see your mobile computer. For more information, see **“Troubleshooting 802.1x Security” on page 104**.
- 3 Configure 802.11 security. For help, see **“About Wireless Security” on page 76**.

Configuring Ethernet Communications

To configure Ethernet communications, you connect your mobile computer to your Ethernet network using the Ethernet Snap-On Adapter (Model 1000AA01).

To configure Ethernet communications:

- 1 Connect the Ethernet snap-on adapter to your mobile computer.
- 2 Connect the Ethernet cable from your network to the snap-on adapter.

Ethernet communications are automatically enabled on your mobile computer.

- 3 Make sure that your computer is communicating with the network. The network connection icon () should appear on the title bar.

Configuring Bluetooth Communications

Your 70 Series is Bluetooth™-enabled, which lets you connect to other Bluetooth devices, such as scanners, printers, or audio devices.

You need to turn on the Bluetooth radio before you can discover and connect to other Bluetooth devices. By default, the radio is turned off.

To turn on the Bluetooth radio and configure Bluetooth settings:

- 1 Tap **Start > Settings > Bluetooth > Mode**.
- 2 Select the **Turn on Bluetooth** check box.

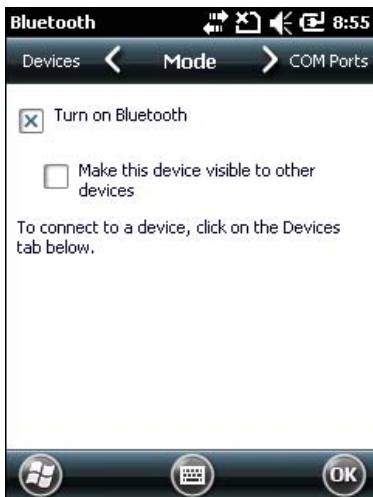

3 (Optional) If you want your 70 Series to be visible to other Bluetooth devices, choose **Make this device visible to other devices**.

4 Tap **OK**.

The Bluetooth radio maintains its state through a warm or cold boot and maintains virtual COM ports. But, if you clean boot your 70 Series you need to recreate pairings to devices.

Connecting to a Bluetooth Scanner

You can connect to an Intermec Bluetooth scanner, such as the SF51 or SR61.

To connect to an Intermec Bluetooth scanner:

1 Tap **Start > Settings > System > Wireless Scanning**.

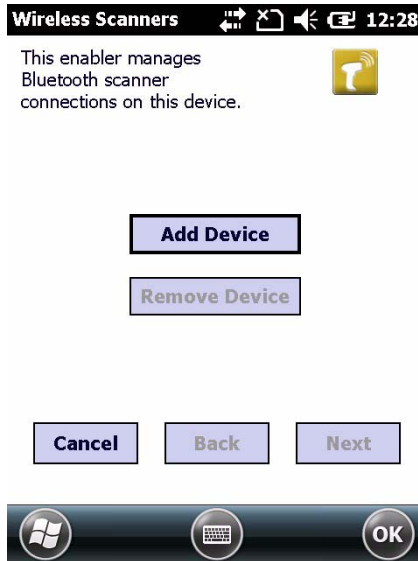

2 Tap **Add Device**.

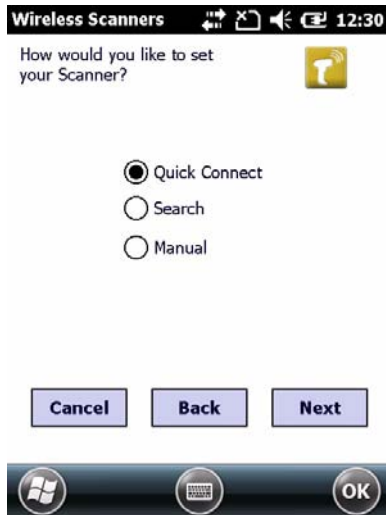

3 Select **Quick Connect**, **Search**, or **Manual**. Follow the onscreen instruction to add a wireless scanner.

Connecting to a Bluetooth Printer

To configure your 70 Series for Bluetooth wireless printing, you need to:

- create an application that opens the wireless printing COM port on your 70 Series. For help, see the Bluetooth Resource Kit, which is part of the Intermec Developer Library (IDL), available from the Intermec web site at www.intermec.com/idl.
- select the current wireless printer on your 70 Series. For help, see the next procedure.

To select the current wireless printer

1 Tap **Start > Settings > System > Wireless Printing**.

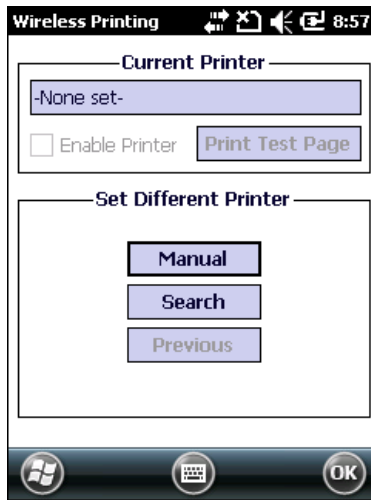

2 Tap **Search** to find a printer, or tap **Manual** to enter a device address. Follow the onscreen instructions to select the current wireless printer.

3 (Optional) Tap **Print Test Page**. The printer prints out a test page.



Note: You can also print wirelessly using Microsoft APIs with Bluetooth extensions for Winsock and Bluetooth virtual COM ports. For help, see the Bluetooth Resource Kit documentation.

Connecting to a Bluetooth Audio Device

Use the Bluetooth Audio enabler to discover, activate, and connect to Bluetooth audio devices such as a headset. This enables system sounds to be monitored through the headset.

To connect to a Bluetooth audio device:

- 1 Tap **Start > Settings > System > Bluetooth Audio**.

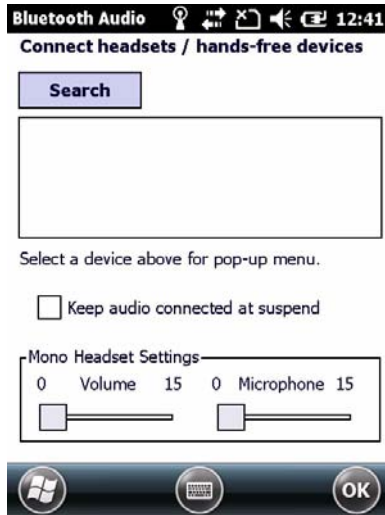

- 2 Tap **Search** to find your Bluetooth headset or hands-free device.
- 3 Select your device from the list and configure any settings.
- 4 Click **OK** when you are done.

About Serial and USB Communications

You can use these 70 Series accessories to transmit data to and receive data from another device through serial or USB communications:

- RS-232 Snap-On Adapter (Model 1000AA03)
- USB Snap-On Adapter (Model 1000AA07)

For more information about these accessories and how to order them, see [“70 Series Accessories” on page 7](#).

Creating an ISP Connection

You can create an Internet Service Provider (ISP) connection to send and receive e-mail messages using Messaging (Outlook E-mail) and view web pages using Internet Explorer Mobile. You need to get your ISP dial-up access telephone number, a user name, and a password from your ISP.

To create an ISP Connection:

- 1** Tap **Start > Settings > Connections > Connections**. (Yes, you need to tap **Connections** twice.)
- 2** Under **My ISP**, tap **Add a new modem connection**.
- 3** Enter a name for the connection, such as “ISP Connection.”
- 4** If you are using an external modem connected to your mobile computer with a cable, select **Hayes Compatible on COM1** from the **Select a modem** list.
- 5** Tap **Next**.
- 6** Enter the access phone number and then tap **Next**.
- 7** Enter the **User name**, **Password**, and **Domain** (if provided by an ISP or your network administrator).
- 8** Tap **Finish**.
- 9** On the **Connections** screen, tap **Advanced** on the horizontal scroll.

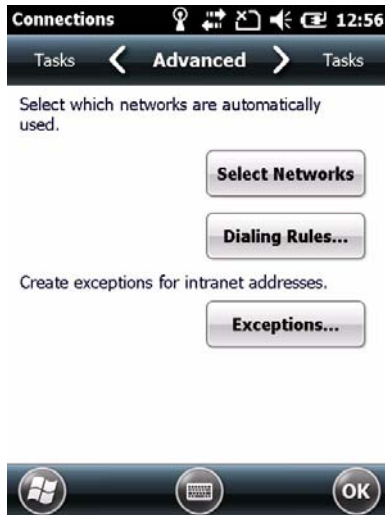

- 10** Tap **Dialing Rules**.
- 11** When the Enable Dialing Rules box appears, tap **OK**.
- 12** Tap **Edit**.
- 13** In the **Name** field, enter your phone type (**Home**, **Mobile**, or **Work**).
- 14** Tap **ok** until you exit the Connections screen.

Creating a VPN Server Connection

You can create a Virtual Private Network (VPN) connection to securely connect to servers, such as a corporate network, through the Internet. Before you can create a VPN connection, you need this information from your network administrator:

- User name
- Password
- Domain name
- TCP/IP settings
- Host name or IP address of the VPN server

To create a VPN server connection:

- 1 Tap **Start > Settings > Connections > Connections**. (Yes, you need to tap Connections twice.)
- 2 Under **My Work Network**, tap **Add a new VPN server connection**.
- 3 Step through the screens to set up your VPN connection.

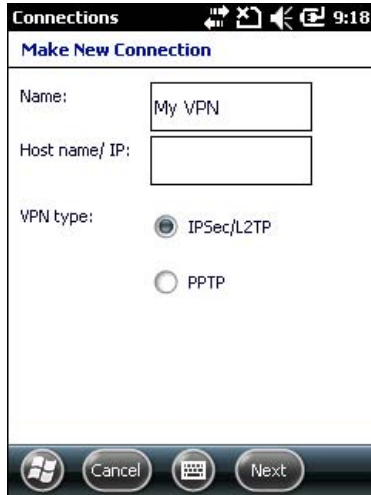

About Wireless Security

The 70 Series provides four types of security for your wireless network:

- Wi-Fi Protected Access 2 (WPA2™)
- Wi-Fi Protected Access (WPA)
- 802.1x
- WEP

This section explains how to configure wireless security on your 70 Series. If you choose not to use security, see [“Disabling Security” on page 90](#). Intermec recommends that you always implement security.

You must use either Funk or Microsoft security to implement your security solution. For details, see the next section, [“Choosing Between Microsoft and Funk Security” on page 77](#).

If you are using WPA-802.1x, WPA2-802.1x, or 802.1x security, this section also assumes that your authentication server and authenticators are properly configured.



Note: Your security choice does not depend on your authentication server. For example, you can choose Funk security if you use Microsoft Active Directory® to issue certificates.

Choosing Between Microsoft and Funk Security

The 70 Series supports both Funk and Microsoft security, which dynamically select wireless networks based on your preferences. The option you choose depends on your network security needs.

- If you are using the 70 Series in a static environment that requires a high level of security, you should use Funk security, which offers CCX v4.0 compliance, support for LEAP and TTLS, and configuration for up to four profiles.
- To use Funk security, you need to select a profile. For help, see the next section, “Choosing Between Microsoft and Funk Security.”
- If you are primarily using the 70 Series to connect to Wi-Fi hotspots, you may want to use Microsoft security.

To use Microsoft security, you need to select it as your security choice. For help, see [“Selecting Microsoft as Your Security Choice” on page 82.](#)

Selecting a Funk Security Profile

You can define up to four profiles for Funk security. Different profiles let your 70 Series communicate in different networks without having to change all of your security settings. For example, you may want to set up one profile for the manufacturing floor and one for the warehouse. By default, the active profile is Profile 1.



Note: You can also use the Profile Wizard to configure most wireless security settings. To start the Profile Wizard, tap the iConnect icon in the lower right corner of the Today screen and select **Tools > Wireless Settings**.

Selecting a Funk Security Profile

Use the following procedure to select a Funk security profile.

- 1 Start Intermec Settings.
- 2 Choose **Communications > 802.11 Radio > Funk Security**.
- 3 Choose a profile. A list of configurable settings appears.
- 4 (Optional) In the **Profile Label** text box, enter a meaningful name for your profile.
- 5 Configure your security settings. For help, see the next sections.
- 6 Repeat Steps 3 through 5 for each profile you want to define.
- 7 Set an active profile by choosing it in the **Active Profile** list.
- 8 Save your settings.

Configuring WPA Security With Funk Security

Use these procedures to set WPA-802.1x, WPA2-802.1x, WPA-PSK, or WPA2-PSK security on your 70 Series with Funk security.

- 1 Make sure the communications and radio parameters on your 70 Series are configured.
- 2 Make sure Funk is selected as your security choice.
- 3 Start Intermec Settings.
- 4 Choose **Communications > 802.11 Radio > Funk Security**.
- 5 Select the profile you want to configure.
- 6 For **Association**, choose **WPA** or **WPA2**. Encryption automatically defaults to **TKIP** or **AES**, respectively.
- 7 For **8021x**, choose **TTLS**, **PEAP**, **EAP-FAST**, or **TLS**.
- 8 If you choose **TTLS** or **PEAP**:

- a For **Prompt for Credentials**, choose **Enter credentials now**.

Note: You can use **Prompt for Credentials** to troubleshoot your network connection.



- b Enter a **User Name** and **User Password**.
- c For **Validate Server Certificate**, choose **Yes**.



Note: The correct date must be set on your 70 Series when you enable **Validate Server Certificate**.

- 9 If you choose TLS:
 - a Load a user and root certificate on your 70 Series. For help, see **“Loading a Certificate” on page 88**.
 - b Enter a **User Name** and **Subject Name**.
 - c For **Validate Server Certificate**, choose **Yes**.
 - d (Optional) To increase your level of security, enter a **Server 1 Common name** and a **Server 2 Common name**.

Configuring WPA or WPA2 with Funk Security

Use the following procedure to configure WPA or WPA2 with Funk security.

- 1 Make sure the communications and radio parameters on your 70 Series are configured.
- 2 Make sure Funk is selected as your security choice.
- 3 Start Intermec Settings.
- 4 Choose **Communications > 802.11 Radio > Funk Security**.
- 5 Select the profile you want to configure.
- 6 For **Association**, choose **WPA** or **WPA2**.
- 7 For **8021x**, choose **None**.
- 8 For **Pre-Shared Key**, enter the pre-shared key or passphrase.

The pre-shared key must be a value of 32 hex pairs preceded by 0x for a total of 66 characters. The value must match the key value on the access point. The passphrase must be from 8 to 63 characters. After you enter a passphrase, the 70 Series internally converts it to a pre-shared key. This value must match the passphrase on the authenticator.

- 9 Save your settings.

Configuring 802.1x Security With Funk Security

Use the following procedure to configure 802.1x security with Funk security.

- 1 Make sure the communications and radio parameters on your 70 Series are configured.
- 2 Make sure Funk is selected as your security choice.
- 3 Start Intermec Settings.
- 4 Choose **Communications > 802.11 Radio > Funk Security**.
- 5 Select the profile you want to configure.
- 6 For **Association**, choose **Open**.
- 7 For Encryption, choose **WEP**.
- 8 For **8021x**, choose **TTLS**, **PEAP**, or **TLS**.
- 9 If you chose **TTLS** or **PEAP**:
 - a Enter a **User Name**.
 - b For **Prompt for Credentials**, choose **Enter credentials now**.



Note: You can use **Prompt for Credentials** to troubleshoot your network connection.

- c Enter a **User Password**.
 - d For **Validate Server Certificate**, choose **Yes**.
- 10 If you choose **TLS**:
 - a Load a user and root certificate on your 70 Series. For help, see **“Loading a Certificate” on page 88**.
 - b For **Validate Server Certificate**, choose **Yes**.
 - c Enter a **User Name** and **Subject Name**.
 - d (Optional) To increase your level of security, enter a **Server 1 Common name** and a **Server 2 Common name**.
- 11 (Optional) To increase your level of security, enter a **Server 1 Common name** and a **Server 2 Common name**.
- 12 Save your settings.

Configuring LEAP Security

Use the following procedure to configure LEAP security.

- 1 Make sure the communications and radio parameters on your 70 Series are configured.
- 2 Make sure Funk is selected as your security choice.
- 3 Start Intermecc Settings.
- 4 Choose **Communications > 802.11 Radio > Funk**.
- 5 Select the profile you want to configure.
- 6 For **8021x**, choose **LEAP**.
- 7 For **Association**, choose **Open**, **WPA**, **WPA2**, or **Network EAP**. Encryption automatically defaults to **TKIP** if you choose **WPA**, **AES** if you choose **WPA2**, and **WEP** if you choose **Open** or **Network EAP**.
- 8 For **Prompt for Credentials**, choose **Enter credentials now**.
- 9 Enter a **User Name** and **User Password**.
- 10 Save your settings.

Configuring Static WEP Security With Funk Security

Use the following procedure to configure static WEP security with Funk.

- 1 Make sure the communications and radio parameters on your 70 Series are configured.
- 2 Make sure Funk is selected as your security choice.
- 3 Start Intermecc Settings.
- 4 Choose **Communications > 802.11 Radio > Funk Security**.
- 5 Select the profile you want to configure.
- 6 For **Association**, choose **Open**.
- 7 For **Encryption**, choose **WEP**.
- 8 For **8021x** choose **None**.

- 9 Define a value for the keys you want to use. You can define up to four keys (**Key 1** through **Key 4**).

Enter an ASCII key or a hex key that is either 5 bytes or 13 bytes long depending on the capability of the radio. Set a 5- byte value for 64-bit WEP or a 13-byte value for 128-bit WEP. Hex keys must be preceded by 0x and contain 5 or 13 hex pairs.

- 10 For **Transmit key**, choose the key you want to use for transmitting data.
- 11 Save your settings.

Selecting Microsoft as Your Security Choice

The default security setting is Funk. If you want to use Microsoft security, you need to select it as your security choice. After you select Microsoft as your security choice, you will be prompted to save your settings and reset your 70 Series for your change to take effect.

With Microsoft as your security choice, you can configure:

- WPA
- 802.1x
- Static WEP

Selecting Microsoft Security

Use the following procedure to select Microsoft security.

- 1 Start Intermec Settings. For help, see [“Configuring the Computer” on page 59](#).
- 2 Choose **Communications > 802.11 Radio > Security Choice**.
- 3 From the **Security Choice list**, select **Microsoft Security**. An alert box appears telling you that you must save your settings and warm boot the 70 Series for the new security choice to take effect.
- 4 Choose **Yes**. The 70 Series resets and starts with Microsoft Security as the Security Choice.

Configuring WPA Security With Microsoft Security

Use these procedures to set WPA-802.1x and WPA-PSK security on your 70 Series with Microsoft security

- 1** Make sure the communications and radio parameters on your 70 Series are configured.
- 2** Start Intermec Settings.
- 3** Choose **Communications > 802.11 Radio > Microsoft Security**.
- 4** For **Infrastructure Mode**, choose **Infrastructure**.
- 5** For **Network Authentication**, choose **WPA**. Data Encryption automatically defaults to **TKIP**.
- 6** For **802.1x Authentication**, choose either **MD5**, **TLS**, or **PEAP**.
- 7** If you choose **TLS**:
 - a** Choose **Properties > Run App**. The Auth. Settings dialog box appears.
 - b** Choose **Select**.
 - c** Select your certificate from the list and press **Enter**. The User Logon dialog box appears.
 - d** Enter a **User Name** and **Domain** and press **Enter**.
- 8** If you choose **PEAP**:
 - a** Choose **Properties > Run App**. The Auth. Settings box appears.
 - b** Choose **Validate Server** and press **Enter**. When the radio starts to authenticate, the Network Password dialog box appears.
 - c** Enter a **User Name** and **Password** and select **Save Password**.
 - d** (Optional) In the **Domain** field, enter the Active Directory domain associated with the user account.
- 9** Save your settings.

Enabling WPA-PSK With Microsoft Security

Use the following procedure to enable WPA-PSK With Microsoft Security.

- 1 Make sure the communications and radio parameters on your 70 Series are configured.
- 2 Start Intermec Settings.
- 3 Choose **Communications > 802.11 Radio > Microsoft Security**.
- 4 For **Infrastructure Mode**, choose **Infrastructure**.
- 5 For **Network Authentication**, choose **WPA-PSK. Data Encryption** automatically defaults to **TKIP**.
- 6 For **Pre-Shared Key**, enter the pre-shared key or the passphrase.

The pre-shared key must be a value of 32 hex pairs preceded by 0x for a total of 66 characters. The value must match the key value on the authenticator. The passphrase must be from 8 to 63 characters. After you enter a passphrase, the 70 Series internally converts it to a pre-shared key.

- 7 Save your settings.

Configuring 802.1x Security with Microsoft Security

Use the following procedure to configure 802.1x security with Microsoft security.

- 1 Make sure the communications and radio parameters on your 70 Series are configured.
- 2 Start Intermec Settings.
- 3 Choose **Communications > > 802.11 Radio > Microsoft Security**.
- 4 For **Infrastructure Mode**, choose **Infrastructure**.
- 5 For **Network Authentication**, choose **Open**.
- 6 For **Data Encryption**, choose **WEP**.
- 7 For **802.1X Authentication**, choose **TLS** or **PEAP**.

- 8** If you choose TLS:
 - a** Choose **Properties > Run App**. The Auth. Settings box appears.
 - b** Choose **Select**.
 - c** Select your certificate from the list and press **Enter**. The User Logon dialog box appears.
 - d** Enter a **User Name** and a **Domain**.
- 9** If you choose PEAP:
 - a** Choose **Properties > Run App**. The Auth. Settings box appears.
 - b** Select **Validate Server** and press **Enter**. When the radio starts to authenticate, the Network Password dialog box appears.
 - c** Enter a **User Name** and **Password** and select **Save Password**.
 - d** (Optional) In the **Domain field**, enter the domain.
 - e** Press **Enter**.
- 10** For **Network Key Setting**, choose **Automatic**.
- 11** Save your settings.

Configuring Static WEP Security With Microsoft Security

Use the following procedure to configure static WEP security with Microsoft security.

- 1** Make sure the communications and radio parameters on your 70 Series are configured.
- 2** Start Intermec Settings.
- 3** Choose **Communications > > 802.11 Radio > Microsoft Security**.
- 4** For **Network Authentication**, choose **Open**.
- 5** For **Network Authentication**, choose **WPA**. Data Encryption automatically defaults to **TKIP**.
- 6** For **802.1x Authentication**, choose either **MD5, TLS, or PEAP**.

- 7 If you choose TLS:
 - a Choose **Properties** > **Run App**. The Auth. Settings dialog box appears.
 - b Choose **Select**.
 - c Select your certificate from the list and press Enter. The User Logon dialog box appears.
 - d Enter a **User Name** and **Domain** and press **Enter**.
If you choose PEAP:
 - e Choose **Properties** > **Run App**. The Auth. Settings box appears.
 - f Choose **Validate Server** and press **Enter**. When the radio starts to authenticate, the Network Password dialog box appears.
 - g Enter a **User Name** and **Password** and select **Save Password**.
 - h (Optional) In the **Domain** field, enter the Active Directory domain associated with the user account.
- 8 Save your settings.

Enabling WPA-PSK with Microsoft Security

Use the following procedure to enable WPA-PSK with Microsoft security.

- 1 Make sure the communications and radio parameters on your 70 Series are configured.
- 2 Start Intermec Settings.
- 3 Choose **Communications** > **802.11 Radio** > **Microsoft Security**.
- 4 For **Infrastructure Mode**, choose **Infrastructure**.
- 5 For **Network Authentication**, choose **WPA-PSK**. Data Encryption automatically defaults to **TKIP**.
- 6 For **Pre-Shared Key**, enter the pre-shared key or the passphrase.
The pre-shared key must be a value of 32 hex pairs preceded by 0x for a total of 66 characters. The value must match the key value on the authenticator. The passphrase must be from 8 to 63 characters.

After you enter a passphrase, the 70 Series internally converts it to a pre-shared key.

This value must match the passphrase on the authenticator.

- 7 Save your settings.

Configuring 802.1x Security with Microsoft Security

Use the following procedure to configure 802.1x security with Microsoft.

- 1 Make sure the communications and radio parameters on your 70 Series are configured.
- 2 Start Intermec Settings.
- 3 Choose **Communications > 802.11 Radio > Microsoft Security**.
- 4 For **Infrastructure Mode**, choose **Infrastructure**.
- 5 For **Network Authentication**, choose **Open**.
- 6 For **Data Encryption**, choose **WEP**.
- 7 For **802.1X Authentication**, choose **TLS** or **PEAP**.
- 8 If you choose TLS:
 - a Choose **Properties > Run App**. The Auth. Settings box appears.
 - b Choose **Select**.
 - c Select your certificate from the list and press **Enter**. The User Logon dialog box appears.
 - d Enter a **User Name** and a **Domain**.If you choose PEAP:
 - e Choose **Properties > Run App**. The Auth. Settings box appears.
 - f Select **Validate Server** and press **Enter**. When the radio starts to authenticate, the Network Password dialog box appears.
 - g Enter a **User Name** and **Password** and select **Save Password**.
 - h (Optional) In the **Domain** field, enter the domain.
 - i Press **Enter**.

- 9 For **Network Key Setting**, choose **Automatic**.
- 10 Save your settings.

Configuring Static WEP Security With Microsoft Security

Use the following procedure to configure static WEP security with Microsoft security.

- 1 Make sure the communications and radio parameters on your 70 Series are configured.
- 2 Start Intermec Settings.
- 3 Choose **Communications > 802.11 Radio > Microsoft Security**.
- 4 For **Network Authentication**, choose **Open**.
- 5 For **Data Encryption**, choose **WEP**.
- 6 For **Network Key Setting**, choose **Enter Key and Index**.
- 7 For **Network Key Value**, enter an ASCII key or a hex key that is either 5 bytes or 13 bytes long depending on the capability of the radio.

Set a 5-byte value for 64-bit WEP or a 13-byte value for 128-bit WEP. Hex keys must be preceded by 0x and contain 5 or 13 hex pairs.
- 8 For **Network Key Index**, select the key you want to use for data transmission.
- 9 Save your settings.

Loading a Certificate

To use transport layer security (TLS) with WPA or 802.1x security, you need a unique client certificate on the 70 Series and a trusted root certificate authority (CA) certificate. Certificates are pieces of cryptographic data that guarantee a public key is associated with a private key. They contain a public key and the entity name that owns the key. Each certificate is issued by a certificate authority.

To import a root certificate:

- 1 Start Intermec Settings.

- 2 Go to **Start > Settings > System > Intermec Settings**.
- 3 Tap **Communications > 802.11 Radio > Certificates**.



- 4 To import a root certificate:
 - a Select **True** under **Import Root Certificates**.
 - b Tap **Import Certificates** to install the selected certificate.
 - c In the CertImportUI screen, tap the <<< button next to the Select pfx to import text field.
 - d Select the root certificate from the list.
 - e Tap **Import Certificate**.
- 5 To import a certificate from an IAS server:
 - a Tap **Import Certificates**.
 - b Tap **Web Enrollment**.
 - c Enter the **User**, **Password**, and **Server** (IP address) to log into the server.
 - d Tap **OK**. A dialog box appears asking if you want to load the root certificate.

- e** Tap **OK**. The Enrollment Tool message box appears telling you that the certificate has been added.
- f** Tap **OK** to close the message box.

Disabling Security

If you choose not to use security with your wireless network, you can disable it on the computer. Intermec recommends that you always set security in your network.

To disable security:

- 1** Start Intermec Settings. For help, see **“Configuring the Computer” on page 59**.
- 2** Choose **Communications > 802.11 Radio > Security Choice** and select **Microsoft Security**. An alert box appears telling you that you must save your settings and warm boot the 70 Series for the new security choice to take effect.
- 3** Choose **Yes**. The 70 Series resets and starts with Microsoft Security as the Security Choice.
- 4** Start Intermec Settings.
- 5** Choose **Communications > 802.11 Radio > Microsoft Security**.
- 6** For **Network Authentication**, choose **Open**.
- 7** For **Data Encryption**, choose **Disabled**.
- 8** Tap **OK**. Your settings are saved.

7

Managing the Computer

Use this chapter to learn how to remotely update, configure, and monitor your Intermec mobile computers. You will also find information on installing and developing software applications as well as how to upgrade the system software.

Managing the Computer in Your Network

When you have multiple mobile computers and peripherals in your network, it is essential to have an easy way to manage updates, configure all of the devices, and remotely troubleshoot problems. Intermec provides a free device management software platform called SmartSystems to help you manage your devices. You can also purchase third-party device management software through a vendor.

Managing the Computer Using SmartSystems

Intermec's SmartSystems™ Foundation is a software platform that lets you manage all of your SmartSystems-enabled devices simultaneously from a central server. The SmartSystems console displays all SmartSystems-enabled computers and peripherals in your network.

Intermec SmartSystems Foundation Console

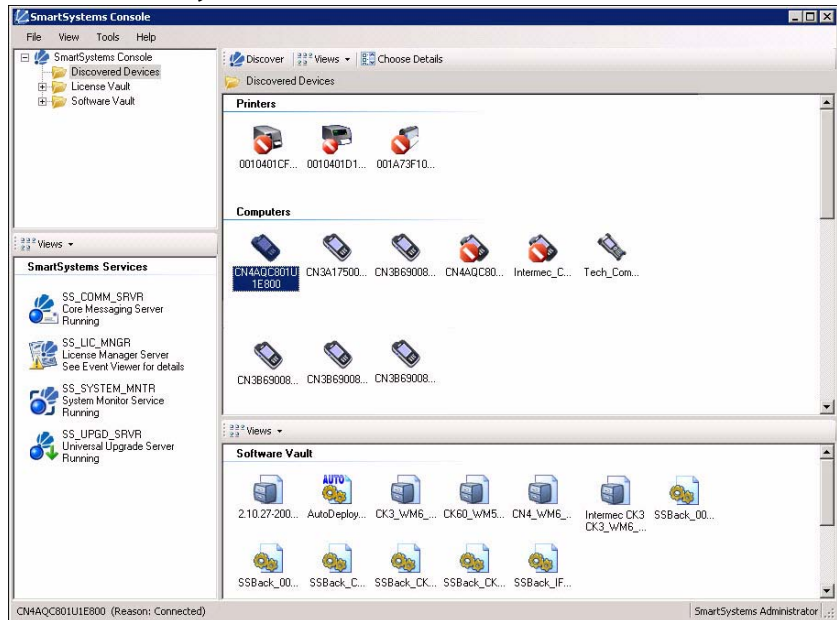

Through the Console, you can:

- drag-and-drop configuration bundles, operating system updates, and firmware upgrades to multiple computers.

- save configuration settings from a single device and deploy those settings to many devices simultaneously.
- remotely change settings on SmartSystems-enabled computers and peripherals.

The SmartSystems console can report on asset locations and battery status, making it easier to manage your mobile devices.

With an AutoDeploy license, SmartSystems can automatically push software, configuration settings, and other files to connected mobile computers. The license also enables Scan-to-Connect, which makes connecting additional mobile computers to your wireless network as easy as reading bar codes. SmartSystems Foundation can be downloaded at no charge from the Intermec web site. For more information, visit www.intermec.com/SmartSystems. To purchase an AutoDeploy license, contact your local Intermec sales representative.

Managing the Computer Using Third-Party Software

You can use third-party software such as Wavelink Avalanche to centrally manage your Intermec devices. Device management software enables you to update software, increase security, track your assets, and troubleshoot devices remotely. You can download the Wavelink Enabler for the CS40 from the Wavelink web site. For more information, visit the Intermec web site and search for Wavelink Avalanche or visit www.wavelink.com to download the enabler.

Developing and Installing Applications

Use the Intermec Resource Kits to develop applications to run on the mobile computer. The Resource Kits are a library of C++, .NET, Java, and web components grouped by functionality that you can use to create applications for the computer. The Resource Kits are part of the Intermec Developer Library (IDL), and can be downloaded from the Intermec web site at www.intermec.com/idl.

For more information, see the [Intermec Developer Library Resource Kit Developer's Guide](#).

Packaging Your Application

For very simple applications, the executable file may be the only file you need to deploy. More typically, you will have a set of files to install.

Intermec recommends using .cab files to install your applications. The computer uses standard Windows Mobile .cab files and will install third-party .cab files.

Choosing a Target Location

You can have your .cab file place your application in any of these memory locations on the mobile computer:

- The ObjectStore.
- The optional microSD card. Depending on available disk space, you may want to consider installing your application files on the microSD card. Using a card creates the Storage Card folder on the computer.
- The non-volatile Flash File Store. Applications and data in the Flash File Store will persist through a clean boot.

Note: The Flash File Store may be erased if you reflash the image.



Files copied to any of these locations are safe when you cold boot the computer as long as the AutoRun system is installed in the appropriate location. When AutoRun is installed on the computer, all .cab files in the CabFiles folder are automatically extracted after a cold boot. For more information about AutoRun, see the [Intermec Developer Library Resource Kit Developer's Guide](#).

Installing Applications Using SmartSystems Foundation Console

You can use the SmartSystems console to drag-and-drop Intermec applications onto your mobile computer. The console is part of SmartSystems Foundation.

- 1 Download your application file from the Intermec web site and unzip it on your desktop PC.

- 2** Double-click the application file to install it. The application file should appear in the Software Vault.
- 3** From the SmartSystems console in the Software Vault, drag-and-drop the application onto each mobile computer in your network, or drop the application on a group of computers contained in a folder.

Installing Applications Using Microsoft ActiveSync

When you only have a few computers to update with applications, you can copy files using Microsoft ActiveSync. This procedure assumes that Microsoft ActiveSync is installed on your PC and is up and running.

- 1** Connect to the mobile computer via ActiveSync.
- 2** Copy the .cab files from your development PC to the computer.
- 3** Warm boot or cold boot the computer.
- 4** After the boot process is finished, browse to the .cab files and tap the files to install them.

Installing Applications Using a Storage Card

Use a storage card to install applications on one computer at a time or if you have no network connection.

To install applications using a storage card:

- 1** Copy your application file to the storage card.
- 2** Install the storage card in the mobile computer.
- 3** On the mobile computer, browse to the Storage Card folder and run your application.

Installing Applications Using the FTP Server



The mobile computer has a built-in FTP server that connects to a network through Ethernet, 802.11 a/b/g/n, or WAN (Wireless Access Network). You can use the server to transfer your application file to the computer. Because you can create FTP scripts to automate the process of copying files to the computer, this option is useful when you need to send files to a large number of computers. The easiest way to manage the FTP server is to enable the FTP menu within iConnect.

To enable the FTP server:

- Create this DWORD registry key and set it to a value of 1:
HKEY_CURRENT_USER\Software\iConnect2\iConnect\Settings
\ShowFTPMenu

The iFTP menu is available the next time you start iConnect.

To manage the state of the FTP server, modify these existing registry keys where 1 = enable and 0 = disable:

- HKEY_CURRENT_USER\Software\iConnect2\iConnect\Settings\FtpAutoStart
- HKEY_CURRENT_USER\Software\iConnect2\iConnect\Settings\FtpHeartbeat

Launching Applications Automatically

There are two ways to launch an application automatically on a cold boot:

- Set up your .cab file to place a shortcut to the application in the \Windows\StartUp directory at install time.
- Use AutoRun.exe to start your application at boot time. AutoRun ships on the computer and automates other operations.

At boot time, AutoRun executes any commands found in its data file, AutoRun.dat. Follow the next procedure to create this data file for your mobile computer.

For more information on AutoRun, see the [Intermec Developer Library Resource Kit Developer's Guide](#).

To configure AutoRun:

1 In Notepad, create a file called AutoUser.dat.

2 Write this command in the file:

```
RUN "Path\AppName.exe" arg1, arg2, arg3
```

where:

Path is the path to the directory where the application resides.

AppName.exe is the application name.

arg1, *arg2*, and *arg3* are optional command line arguments.

For example, to launch MyProgram.exe located in the Flash File Store, the command is EXEC "Flash File Store\Apps\MyProgram.exe".

Because AutoRun handles quoted file names for the first parameter, you can specify path names or file names containing white spaces. AutoRun only supports one set of quotes per command.

3 Copy AutoUser.dat to the \Windows\Startup directory on the mobile computer.

Updating the System Software

The mobile computer uses Image Update to update the operating system (OS) and the system software. Image Update uses incremental packages to allow for smaller and faster updates because the contents are stored in flash ROM.

Update packages persist through a cold or clean boot and cannot be removed by the end user. The Image Update process also provides strengthened security because all packages are signed. Image Update packages (.pkg or .pks files) may contain elements such as DLLs, executable (.exe) files, and .cab files.

You can use either of these methods to update your mobile computer:

- You can update multiple computers at the same time using the SmartSystems Console. For help, see the next section,

- You can update individual computers by transferring the packages to the mobile computer and then installing them from the mobile computer.

If you are using SmartSystems Console to update the computer, you can purchase a Provisioning License to send the Image Update silently. For more information, see “[Sending the Image Updates Silently](#)” on [page 99](#).

Updating Multiple Computers Using SmartSystems Console

You can use the SmartSystems console to update the operating system or system software on your mobile computer. The console is part of SmartSystems Foundation and is available from the Intermec web site through the Intermec Developer Library (IDL). Before you can update your mobile computer, you need:

- SmartSystems Foundation. To download SmartSystems Foundation, go to www.intermec.com/idl and open the Device Management page.
- the SmartSystems bundles you want to install. The SmartSystems bundle contains the Image Update package file. These SmartSystems bundles are available from the Intermec web site at www.intermec.com. Go to **Support > Downloads**.

To update the mobile computer using SmartSystems Foundation:

- 1) Open the SmartSystems console.
- 2) Make sure the SmartSystems console and the mobile computer are on the same subnet and they are connected wirelessly or through Ethernet.
- 3) Make sure the mobile computer is in communications dock or a charging dock or that power management is disabled.
- 4) Download the SmartSystems bundle to your PC.
- 5) Double-click the SmartSystems bundle on your PC to extract the update files to the software vault.
- 6) From the SmartSystems console, locate the bundles to install and drag them to each mobile computer (or group in a folder) you want

to update. The SmartSystems console installs the update on your mobile computers.

After the download is complete, your mobile computer begins the update process and automatically performs a cold boot. The computer then boots into a special Update Loader mode where the computer has no network connections and is completely unusable. This process can take anywhere from 30 seconds to 15 minutes depending on the update.

After the update is complete, the computer boots again.

- 7) When a confirmation dialog box appears requesting user input, dismiss it.



Note: The SmartSystems console indicates that your mobile computer is offline, by displaying a red stop symbol, until the computer reboots and reconnects to the system.

Sending the Image Updates Silently

If you want to automatically download and send update packages to your mobile computers, you can purchase a Provisioning license. The silent updates do not require any user intervention and begin when you choose to have the update process start. SmartSystem Foundation users are notified when update packages are released so that they can download them and update their Intermec computers. For more information, see the SmartSystems Foundation Help.

Updating Individual Mobile Computers

You can download update packages from your PC to the mobile computer using Microsoft ActiveSync or any other file transfer method you choose. If you need to download ActiveSync or the Windows Mobility Center, go to www.windowsmobile.com/getstarted.

To update an individual mobile computer:

- 1) Download the Image Update packages you want to install from the Intermec web site at www.intermec.com. Go to **Support > Downloads**.
- 2) Transfer the Image Update packages from your PC to the mobile computer.
- 3) On your mobile computer, tap **Start > Programs > File Explorer** and navigate to the location of the Image Update package.
- 4) Double-tap the package to start the installation. Your mobile computer begins the update process and automatically performs a cold boot.

The computer then boots into a special Update Loader mode where the computer has no network connections and is completely unusable. This process can take anywhere from 30 seconds to 15 minutes depending on the update.

After the update is complete, the mobile computer boots again.

- 5) When a confirmation dialog box appears requesting user input, dismiss it.

8

Troubleshooting and Maintaining the Computer

If you encounter any problems while using the 70 Series computer, look in this chapter to find a possible solution. You will also find information on routine maintenance.

About the Intermec Dashboard

The Intermec Dashboard is designed to provide proactive monitoring of your mobile computers to prevent downtime. You can easily see the health of the device and can help pinpoint the source of a problem to determine if its hardware or software related.

Intermec Dashboard displays information such as the status of network connections, battery usage, storage space, and internal devices. It also provides system information such as the operating system, firmware, and hardware configuration.

To launch the Intermec Dashboard:

- Press the Intermec Dashboard button (Ⓜ).

Intermec Dashboard Main Screen



Intermec Dashboard is highly integrated with SmartSystems Foundation. You can use SmartSystems Foundation to remotely monitor the health of your computers. For more information, refer to the SmartSystems online help.

Troubleshooting Your Mobile Computer

Use the troubleshooting tables in this section to fix problems with the Bluetooth connection, Wi-Fi connection, the phone, the imager, the camera, or general problems with operating the mobile computer.

If you send the computer in for service, it is your responsibility to save the computer data and configuration. Intermec is responsible only for ensuring that the hardware matches the original configuration when repairing or replacing the computer.

Troubleshooting the Wi-Fi Connection

Use this troubleshooting table to help solve problems with your 802.11 radio connection.

Problems With the Wi-Fi Connection

Problem	Solution
When you turn on the computer after it was suspended for a while (10 to 15 minutes or longer), it can no longer send or receive messages over the network.	Host may have deactivated or lost current terminal emulation session. In a TCP/IP direct connect network, turn off the “Keep Alive” message from host to maintain the TCP session while the computer is suspended.
The computer is connected to the network and you move to a new site to collect data. Your computer now shows you are not connected to the network.	Move closer to an access point or to a different location to reestablish communications until you reconnect with the network. Any data collected while out of range is transmitted over the network.
The computer appears to be connected to the network, but you cannot establish a terminal emulation session with the host computer.	There may be a problem with the host computer, or with the connection between the access point and the host computer. Check with the network administrator to make sure the host is running and allowing users to log in to the system.
The computer appears to be connected to the network, but the host computer is not receiving any information from the 70 Series computer.	There may be a problem with the connection between the access point and the host computer. Check with the network administrator or use your access point user’s manual.

Problem	Solution
A network connection icon appears in the toolbar, but then disappears.	<p>The computer may not be communicating with the intended access point. Make sure the network name matches the access point network name. Default network name is “INTERMEC.”</p> <p>The access point may not be communicating with the server. Ensure the access point is turned on, properly configured, and has 802.1x security enabled.</p>

Troubleshooting 802.1x Security

Use the following table to troubleshoot problems with your 802.1x security that will prevent you from connecting to your network, such as a missing WEP key value or an incorrect password.

Problem	Solution
You are setting up multiple access points in a network, with different SSIDs, and the connection fails.	The computer does not save WEP key values when changing the SSID. Reenter the WEP key value after changing the SSID and save your changes. You should now be able to connect to the different access points.

Problem	Solution
The computer indicates it is not authenticated.	Make sure that: <ul style="list-style-type: none">• the User Name and Password parameters on the computer must match the user name and password on authentication server. You may need to reenter the password on both the computer and authentication server.• on your authentication server, the user and group are allowed and the group policy is allowed to log into the server. For help, see the documentation that shipped with your authentication server software.• the IP address and secret key for access point must match the IP address and secret key on the authentication server. You may need to reenter the IP address and secret key on both your access point and authentication server.• the authentication server software is running on the server PC.
You receive a message saying “The server certificate has expired or your system date is incorrect” after you perform a clean boot on the computer.	Date and time are not saved when you perform a clean boot. Reenter the date and time, and then save your changes.

Checking 802.11 Network Status

If you have trouble connecting to your 802.11 wireless network:

- Make sure you have correctly set network parameters on the computer.
- Check your wireless security settings.

Follow the next procedure to use Intermec Dashboard to verify available access points and networks, check signal strength, and view other diagnostics. If you need to contact Intermec Product Support, this information can be helpful in troubleshooting wireless network connection issues.

To use the Intermec Dashboard to verify the network status:

- 1** Press the **Dashboard** (📄) button. The Dashboard launches.
- 2** Tap **WiFi** to view the details of the WiFi status.
- 3** Tap **Diagnostics**. The ISpyWiFi diagnostics screen appears.

The ISpyWiFi tab shows:

- MAC address and IP address of the 802.11 radio.
 - network association status, including the SSID and MAC address of the access point.
 - security configuration.
 - radio transmit power and signal strength information.
- 4** Tap the **Scan** tab to view a list of available 802.11 networks. The list includes the signal strength, channel, and MAC address for each network.
 - Tap **Scan** to refresh the screen.
 - 5** Tap the **Supp** tab to view radio supplicant information, including a list of supplicant events and authentication status.
 - To verify the settings for the currently active security profile, tap **Configure Profile**. The Profile Wizard for the active profile appears.
 - To try reconnecting to the network, tap **Reconnect**.
 - To delete the events in the list, tap **Clear Events**.
 - 6** Tap the **Ping** tab to run a ping test to the host.

To run a ping test:

- a** In the **Host** field, enter the IP address of the host.
- b** From the **Repetitions** list, choose the number of times the computer will ping the host.
- c** Tap **Ping**. The graph shows the amount of time it takes for the host to return the ping. Tap **List** to see this information in a list format.

- 7** Tap the **RSSI** tab to view the received signal strength of the host signal.

The information box includes the current signal strength, host SSID name, MAC address, data rate, and transmit power.

- Tap **Mark** to place an arrow marker above the graph.

- 8** Tap the **Conf** tab to set up a log file that lists RSSI history.

This screen includes the 802.11 radio driver version and available radio modes.

To create a log file:

- Check the **Log to File** check box.
- (Optional) Change the sample period and number of samples displayed.
- Tap **Log File**. The Save As screen appears.
- (Optional) Change the name of the saved log file, the folder to which the file will be saved, the content type (log or text), and the location.
- Tap **Save**.

Troubleshooting Reading Bar Codes

Use this section to troubleshoot problems that may prevent you from being able to read a bar code such as the symbology not be enabled.

Problem	Solution
<p>You cannot see a red beam of light from the imager when you press the Scan button and aim the imager at a bar code label.</p>	<ul style="list-style-type: none"> • You may be too far away from the bar code label. Try moving closer to the bar code label and scan it again. • You may be reading the bar code label “straight on.” Change the reading angle and try again. • The imager hardware trigger might be disabled in Intermec Settings. To check the setting go to Start > Settings > Systems > Data Collection > Scanner Settings. Hardware trigger should be checked.

Problem	Solution
<p>When you release a Scan button or handle trigger, the Good Read light does not turn off.</p>	<p>The Good Read light will remain on if you configure the computer to use continuous/edge triggering. If you configure the computer for level triggering and the Good Read light remains on, there may be a problem. Press one of the Scan buttons or pull the trigger again without scanning a bar code label. If the light is still on, contact your local Intermec representative.</p>
<p>The scanner will not read the bar code label.</p>	<ul style="list-style-type: none"> • Aim the scanner beam to cross entire bar code label in one pass. Vary the scanning angle. • Check the quality of the bar code label, Scan a bar code label that you know will scan. Compare the two bar code labels to see if the bar code quality is too low. You may need to replace the label that you cannot scan. • Make sure the bar code symbology is enabled and configured correctly. Use Intermec Settings to check the symbologies. Expand Data Collection > Symbologies beneath devices listed (scanner, virtual wedge) to check and enable symbologies, then scan the bar code label again. • Make sure the computer application is expecting input from a bar code. You may need to type this information instead.
<p>The scanner does not read the bar code labels quickly, or the scanning beam seems to be faint or obscured.</p>	<p>The scanner window may be dirty. Clean the window with a solution of ammonia and water. Wipe dry. Do not allow abrasive material to touch the window.</p>
<p>You scan a valid bar code label to enter data for your application. The data decoded by the scan module does not match the data encoded in the bar code label.</p>	<p>The computer may have decoded the bar code label in a symbology other than the label's actual symbology. Try scanning the bar code label again. Make sure you scan the entire label.</p>

Problem	Solution
The input device attached to the computer does not work well or read bar code labels very quickly.	Set the Scanner Model command to the specific attached input device. Check enabled bar code symbologies and enable only the symbologies being used.

Troubleshooting Operating the Computer

Use this section to troubleshoot problems that may prevent you from being able to operate the computer.

Problem	Solution
You press the Power key and nothing happens.	<p>The battery status LED indicates the following states:</p> <ul style="list-style-type: none"> • If the battery status LED is a steady green, the battery is more than 95% charged and computer is on a charger. • If the battery status LED is blinking red, then the battery is low. Replace or charge the battery. • If the battery status LED is a steady red, the main battery is on charge. • If the battery status LED is amber, the computer is on charge and either the battery temperature is outside of the charging range, or the battery is defective.
The computer appears to be locked up and you cannot enter data.	<ul style="list-style-type: none"> • Press the Power key to turn off the computer, then press the Power key again to turn it on. • Press and hold the Power key ten seconds to warm boot the computer. • Try reloading the firmware. For help, see “Updating the System Software” on page 97. • If the computer does not boot or reset, contact your Intermec representative for help.
You tap the screen and nothing happens.	Align your screen. For help, see “Aligning the Screen” on page 39.

Problem	Solution
You cannot type a character on the keypad or you can only type uppercase or lowercase letters.	You may have locked a modifier key on the keypad. Press the necessary key sequence to unlock the key. For help, see “About the Keypad” on page 14 .

Calling Product Support

If you cannot find the answer to your problem in the “Troubleshooting the Computer” section, you can visit the Intermec technical knowledge base (Knowledge Central) at intermec.custhelp.com to review technical information or to request technical support. If you still need help after visiting Knowledge Central, you may need to call Product Support.

To talk to an Intermec Product Support representative, call:

1-800-755-5505

Before you can call Intermec Product Support, make sure you have the following information ready:

- Configuration number
- Serial number
- Operating system version
- SmartSystems Platform Bundle (SSPB) version
- If you are using security, know the type (Funk or Microsoft) and the full set of parameters
- Power management settings
- If you are using terminal emulation (TE), know the version and protocol. If you are not using TE, know the language your custom application was written in and the tools you used to create it.

You can find most of the information listed above in Intermec Settings. Consult your application developer for information on your custom application.

Finding Your Configuration Number

Use the following procedure to help you find the configuration number of your computer.

- Look at the label on the back of the computer.

Finding Your Operating System Version

Use the following procedure to help you find your mobile computer's OS version.

- 1 Press the **Intermec Dashboard** (📄) button to launch the Dashboard.
- 2 Tap the **Information** bar. The Information Details page appears and displays information such as the firmware version and the OS version.

Resetting the Computer

You rarely need to reset the computer. If the computer does not resume after pressing the **Power** button, or if the computer or an application locks up, you may need to reset the computer. The 70 Series computer uses the configuration currently saved in flash memory during the boot process. There are three ways to reset the computer:

- Reboot
- Cold boot
- Clean boot

Rebooting the Computer

You may need to reboot the computer to correct conditions where an application stops responding to the system.

To reboot the computer:

- Press the **Power** button and select **Reboot** from the menu.

The computer systematically shuts down, restarts, and goes through the initialization process.

Cold Booting the Computer

In some cases where the computer completely stops responding, it may be necessary to perform a cold boot or hard reset. Because cold booting may result in data loss, use this method only if all other recovery methods have failed.



Note: Cold booting the computer does not guarantee that cached disk data will be saved, so transactional data may be lost during the reset. All other data, such as configuration and network settings, is preserved.

To cold boot your 70 Series computer:

- 1 Press the **Power** button to suspend the computer.
- 2 Remove the handstrap and the battery pack.
- 3 Press the **Reset** button in the battery compartment on the back of the computer.

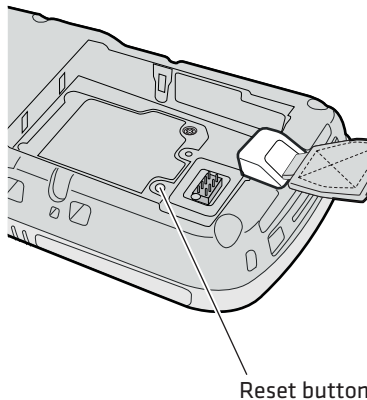

- 4 Replace the battery and the handstrap. The mobile computer boots. When the cold boot is complete, the Home screen appears.

Clean Booting the Computer



Caution

A clean boot erases the memory in the mobile computer, including all applications and data files found in the ObjectStore, and loads only the default files and programs required by the computer operating system.



Caution

During a clean boot, the computer first looks for the Image Update files on an installed microSD card. If no card is found, the computer loads the files in the Flash File Store. Files found on a microSD card during a clean boot are copied into the Flash File Store and overwrite the existing files.

If the computer seems to be locked up, try cold booting it. If this process does not work, use a clean boot to get the computer up and running for further troubleshooting. You can clean boot using the mobile computer, or you can clean boot using the SmartSystems Console:

- To clean boot the computer using the mobile computer:
 - 1 Remove the battery pack from the back of the computer.
 - 2 With a stylus, press the **Reset** button in the battery cavity.
 - 3 Insert the battery back into the computer, and immediately press and hold the **Power** button and **Volume Down** button (the lower button on the right side).
 - 4 Continue to hold the **Power** button and the **Volume Down** button down until you are prompted to release them.
 - 5 Press the **Volume Up** button on the right side to start the cold boot.
 - 6 Wait for the computer to load files from its ROM.
- To clean boot the computer using the SmartSystems Console, right click on the 70 Series computer and select **Intermec Power Tools** > **Clean Boot Device**.

Cleaning the Computer

To keep the computer in good working order, you may need to clean the imager window, color camera window, and the touch screen. Clean the windows and the touch screen as often as needed for the environment in which you are using the computer. To clean the computer, use a solution of ammonia and water.



There are no user-serviceable parts inside the 70 Series computer. Opening the computer will void the warranty and may cause damage to the internal components.

To clean the image window, camera window, and touch screen:

- 1** Press the **Power** button and choose to suspend the computer.
- 2** Dip a clean cloth towel in the ammonia solution and wring out the excess.
- 3** Wipe off the imager window, camera lens, and flash area. Do not allow any abrasive material to touch these surfaces.
- 4** Wipe dry.

A

Specifications and Default Settings

Physical and Environmental Specifications

CN70 Physical Dimensions

Dimensions	16.9 x 8.0 x 3.4 cm (6.66 x 3.14 x 1.35 in)
Weight	450 g (15.2 oz) with battery

CN70e Physical Dimensions

Dimensions	19.5 x 8.0 x 3.4 cm (7.66 x 3.14 x 1.35 in)
Weight	491 g (16.6 oz) with battery

CK70 Physical Dimensions

Dimensions	23.7 x 8.0 x 4.3 cm (9.33 x 3.16 x 1.69 in)
Weight	562 g (19 oz) with battery

CK71 Physical Dimensions

Dimensions	23.7 x 8.0 x 5.0 cm (9.33 x 3.16 x 1.98 in)
Weight	584 g (19.75 oz) with battery

Environmental Specifications

Operating temperature	-20°C to 60°C (-4°F to 140°F)
Storage temperature	-20°C to 60°C (-4°F to 140°F)
Charging temperature	0°C to 45°C (32°F to 113°F)
Relative humidity (operating)	5% to 95% non-condensing
Environmental rating	IP64 compliant
Drop Specifications	All corners and sides from 1.8 m (6 ft) per MIL-STD 810F

Power and Electrical Specifications

Battery type	Rechargeable Lithium-ion (Li-ion) battery
Battery capacity	3.7V, 4000 mAh (14.8 Wh)
Electrial rating	≡ 54.3/4.8 V; 2/1,5 A

Operating System

Microsoft Windows Mobile 6.5.3

Hardware

Main processor	ARMV41, 600 MHz
Radio processor	????? MHz
Memory	256 MB RAM
Persistent storage	1 GB Flash
Removable storage	up to 32 GB user-accessible microSD card slot
Keypad	CN70, CN70e: QWERTY, Numeric CK70: Alpha or Alphanumeric CK71: Numeric Function or Alphanumeric
Imaging options	5 megapixel color camera and EA30 area imager (all), EV12 (CK71 only), or EX25 (CK71 only)

Back Accessory Interface Pin-outs

The back accessory interface provides power for peripheral devices out the back of the CK70 and CK71 computers.

Pin	Pin Name	I/O	Description
1	OTB_PWR	Output	Power supply for peripheral
2	GND		
3	OTB_RX	Input	DTE Data Receive
4	OTB_TX	Output	DTE Data Transmit
5	OTB_I/O_Voltage	Input	I/O Voltage Level
6	OTB_ID	BiDir	One Wire Bus for ID
7	OTB_RTS	Output	DTE Ready do Send
8	OTB_CTS	Input	DTE Clear to Send

Touch Screen Specifications

Trans-reflective TFT-LCD display; QVGA color with touch panel; 240 x 320 pixels; 8.9 cm (3.5 in) diagonal active area; 5-level LED backlight control with settings.

Standard Communications

- UMTS
- CDMA
- GPS
- 802.11b/g
- Bluetooth
- USB high speed 2.0 OTG©

Wireless LAN

Standards compliant	IEEE 802.11b/g (2.4 GHz)
Data rates	up to 54 Mbps
Security	802.11i, WPA, 802.1x, WEP (EAP-TLS, TTLS, LEAP, PEAP, EAP-FAST)
Certifications	WPA2, WPA, Wi-Fi, Cisco Compatible Extensions (CCX)

Regulatory Approvals

cULus Listed, DEMKO, NOM, BSMI, Class B – FCC/ICES/EN , GOST-R

Bar Code Symbolologies

The imagers support all of the bar code symbolologies listed in the next table.

Symbology

AustraliaPost*	GS1 DataBar Omni-Directional
Aztec*	Infomail
BPO*	Interleaved 2 of 5
Canada Post	Japan Post*
China Post	KoreanPost
Codabar	Matrix 2 of 5
Codablock A	Maxicode*
Codablock F	Micro PDF417*
Code 11	MSI
Code 39	PDF417*
Code 93	Planet*
Code 128/GS1-128	Plessey
DataMatrix*	Postnet*
Dutch Post*	QR Code*
EAN/UPC	Standard 2 of 5
GS1 Composite*	SwedenPost
GS1 DataBar Expanded	Telepen
GS1 DataBar Limited	TLC 39

* These symbolologies are not supported with the EV12 imager in the CK70 or CK71.

Imager Reading Distances

Typical reading distances are done in an office environment using office lights (4 lux). Minimum distances are measured in the dark (0 lux). Both reading distances are provided in respective scan engine integration guides. Contact your local Intermec representative for more information.

Appendix A – Specifications and Default Settings

Below are the typical and minimum standard reading distances for the 70 Series computer built with an EA30 imager. Also included are typical and minimum standard reading distances for the CK71 with an EV12 or EX25C imager. When correctly mounted, and exit window reduces reading distances by about 4% for all scan engines.



Note: Minimum distances depend on the length of the bar code.

EA30 Area Imager Minimum Reading Distances

Minimum distances are measured in the dark (0 lux).

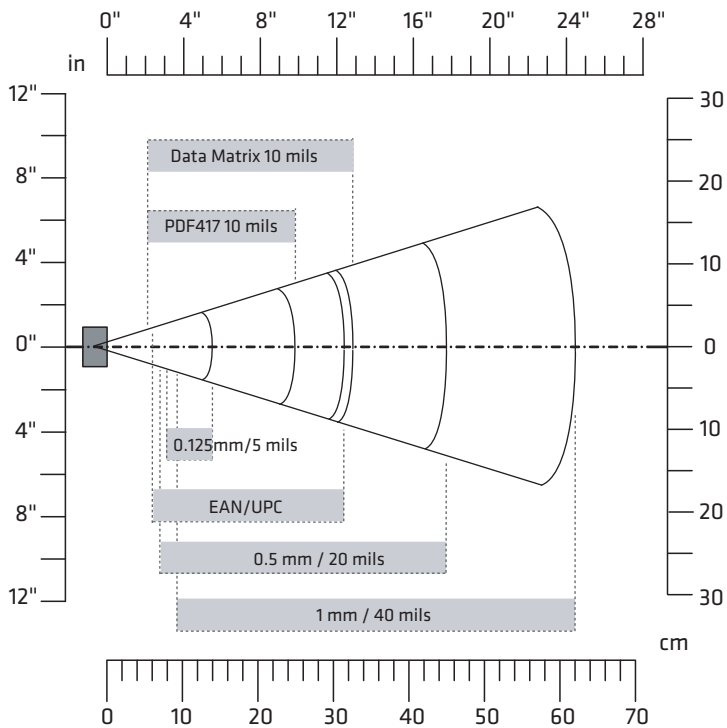

EA30 Minimum Reading Distances

Symbology	Density	Minimum Distance	Maximum Distance
Code 39	0.1 mm (4 mils)	9.5 cm (3.74 in)	10.5 cm (4.13 in)
	0.1250 mm (5 mils)	8 cm (3.15 in)	14 cm (5.51 in)
	0.5 mm (20 mils)	7 cm (2.76 in)	45 cm (17.72 in)
	1 mm (40 mils)	9.5 cm (3.74 in)	62 cm (24.41 in)
UPC/EAN 100%	0.33 mm (13.0 mils)	6 cm (2.36 in)	31.5 cm (12.4 in)
Data Matrix	0.18 mm (7 mils)	8 cm (3.15 in)	15.5 cm (6.1 in)
	0.25 mm (10 mils)	6.5 cm (2.56 in)	21.5 cm (8.46 in)
	0.38 mm (15 mils)	5.5 cm (2.17 in)	31.5 cm (12.4 in)
PDF417	0.25 mm (10 mils)	5.5 cm (2.17 in)	25 cm (9.84 in)
	038 mm (15 mils)	7 cm (2.76 in)	34 cm (13.39 in)

EA30 Area Imager Typical Reading Distances

Typical distances are measured in an office environment (250 lux).

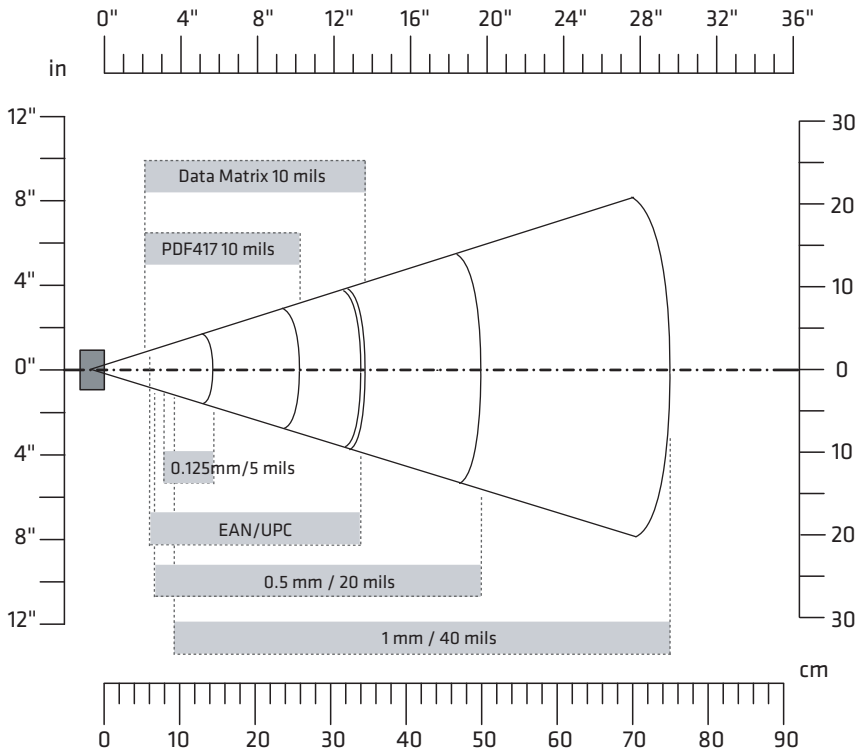

Appendix A – Specifications and Default Settings

EA30 Typical Reading Distances

Symbology	Density	Minimum Distance	Maximum Distance
Code 39	0.1 mm (4 mils)	9.5 cm (3.74 in)	11.5 cm (4.53 in)
	0.125 mm (5 mils)	8 cm (3.15 in)	14.5 cm (5.71 in)
	0.5 mm (20 mils)	6.5 cm (2.56 in)	50 cm (19.69 in)
	1 mm (40 mils)	9.5 cm (3.74 in)	75 cm (29.53 in)
UPC/EAN 100%	0.33 mm (13.0 mils)	6 cm (2.36 in)	34 cm (13.39 in)
Data Matrix	0.18 mm (7 mils)	7.5 cm (2.95 in)	16.5 cm (6.5 in)
	0.25 mm (10 mils)	6 cm (2.36 in)	23 cm (9.06 in)
	0.38 mm (15 mils)	5.5 cm (2.17 in)	34.5 cm (13.58 in)
PDF417	0.25 mm (10 mils)	5.5 cm (2.17 in)	26 cm (10.24 in)
	0.38 mm (15 mils)	6.5 cm (2.56 in)	37 cm (14.57 in)

EV12 Linear Imager Minimum Reading Distances

The illustration below does not include the 0.12 cm (0.05 in) setback for the CK71. Minimum reading distances are measured in the dark (0 lux).

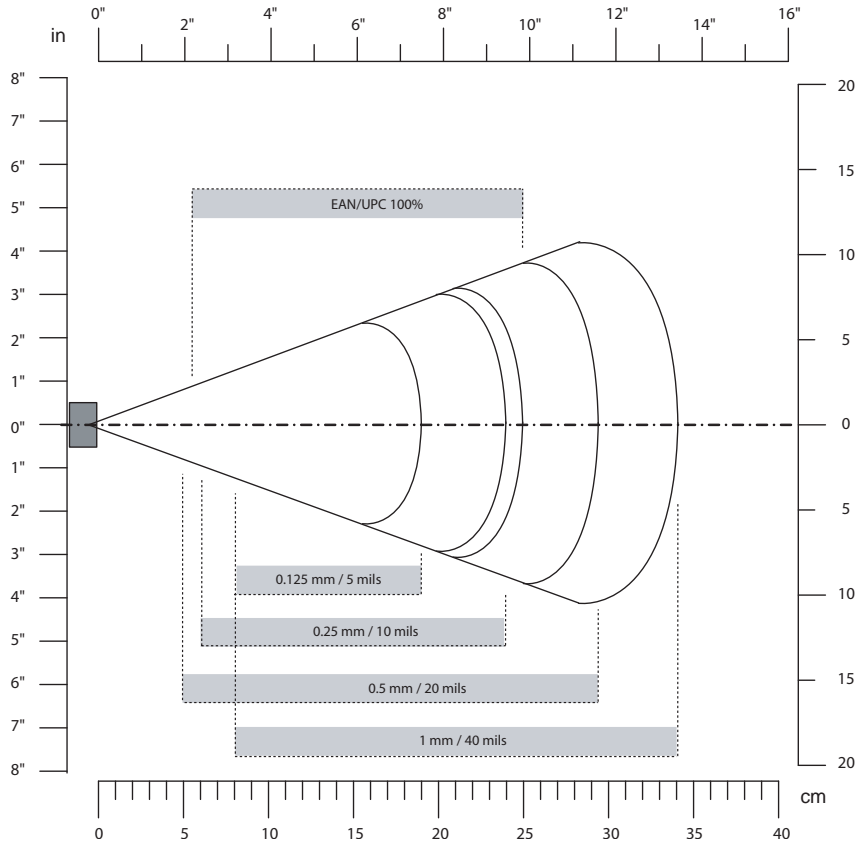

EV12 Minimum Reading Distances With 0.12 cm (0.05 in) Setback

Symbology	Density	Minimum Distance	Maximum Distance
Code 39	0.15 mm (6 mils)	9.6 cm (3.8 in)	17.9 cm (7.1 in)
	0.25 mm (10 ils)	7.1 cm (2.9 in)	20.9 cm (8.3 in)
	0.5 mm (20 mils)	6.1 cm (2.5 in)	26.9 cm (10.6 in)
	1 mm (40 mils)	8.1 cm (3.2 in)	33.9 cm (13.4 in)
EAN/UPC	0.33 mm (13 mils)	6.1 cm (2.5 in)	22.9 cm (9.1 in)

EV12 Linear Imager Typical Reading Distances

The illustration below does not include the 0.12 cm (0.05 in) setback for the CK71. Typical reading distances are measured in an office environment (200 lux).

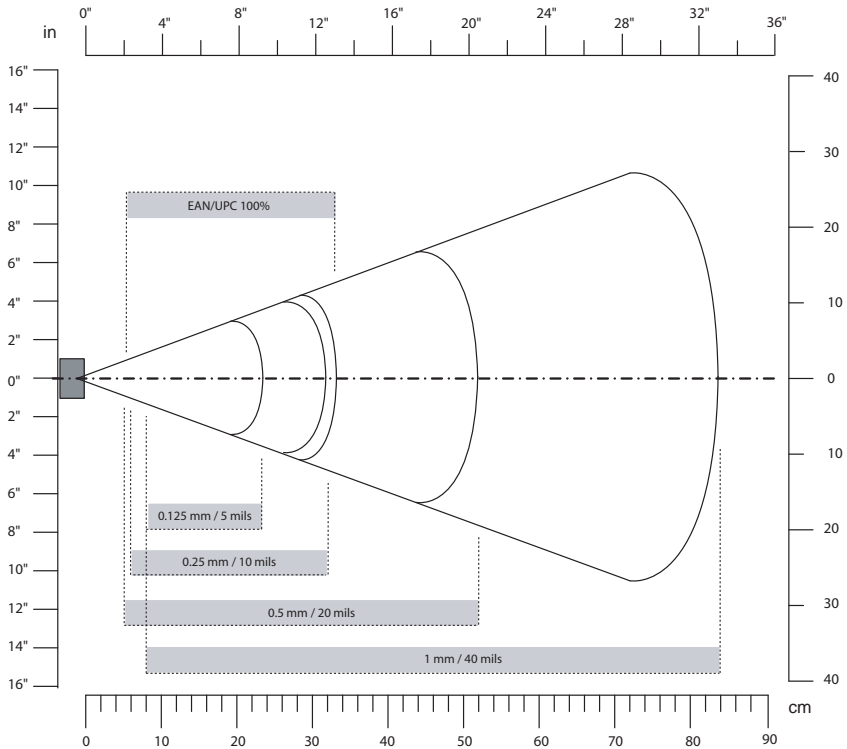

EV12 Typical Reading Distances With 0.12 cm (0.05 in) Setback

Symbology	Density	Minimum Distance	Maximum Distance
Code 39	0.15 mm (6 mils)	9.6 cm (3.8 in)	19.9 cm (7.9 in)
	0.25 mm (10 ils)	6.1 cm (2.5 in)	24.9 cm (9.8 in)
	0.5 mm (20 mils)	5.1 cm (2.1 in)	34.9 cm (13.8 in)
	1 mm (40 mils)	7.1 cm (2.9 in)**	50.9 cm (20.1 in)
EAN/UPC	0.33 mm (13 mils)	5.1 cm (2.1 in)	27.9 cm (11.0 in)

** Minimum distance depends on bar code width and scan angle.

EX25C Near-Far Range Imager Minimum Reading Distance

Minimum reading distances are measured in the dark (0 lux). The following graphic does not include the 0.24 cm (0.09 in) setback for the CK71.

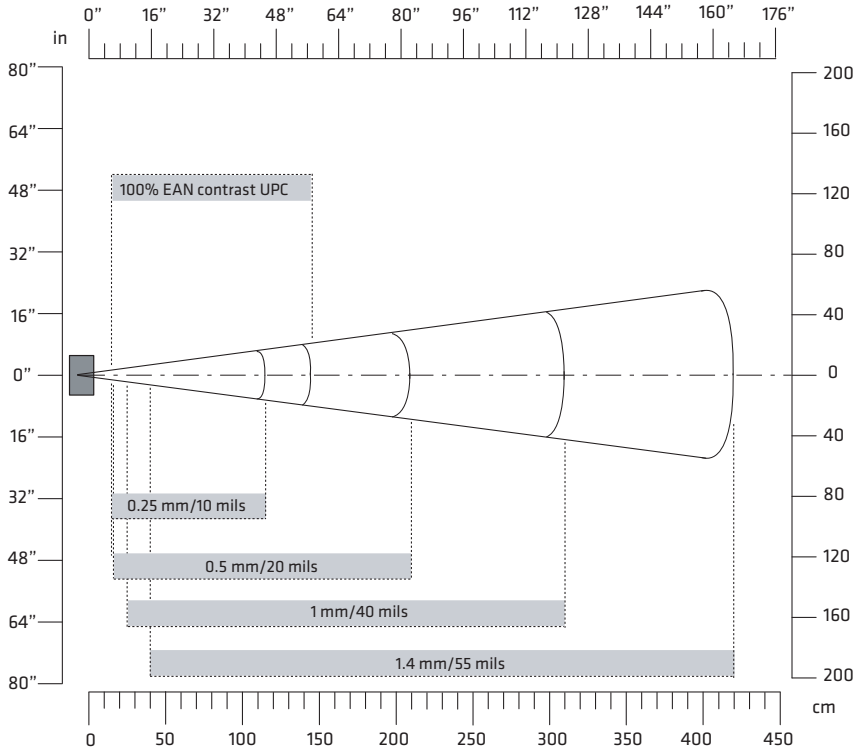

EX25C Minimum Reading Distances With 0.24 cm (0.09 in) Setback

Symbology	Density	Minimum Distance	Maximum Distance
Code 39	0.08 mm (3 mils)	15 cm (5.91 in)	35 cm (13.78 in)
	0.1 mm (2.8 mils)	15 cm (5.91 in)	45 cm (17.72 in)
	0.25 mm (10 mils)	15 cm (5.91 in)	115 cm (45.28 in)
	0.5 mm (20 mils)	16 cm (6.30 in)	210 cm (82.68 in)
	1 mm (40 mils)	25 cm (9.84 in)	310 cm (122.05 in)
	1.3 mm (51 mils)	40 cm (15.75 in)	310 cm (122.05 in)
EAN 100%	0.33 mm (13 mils)	15 cm (5.91 in)	145 cm (57.09 in)

EX25C Near-Far Range Imager Typical Reading Distance

Typical reading distances are measured in an office environment (200 lux). The following graphics do not include the 0.24 cm (0.09 in) setback for the CK71.

EX25C Near-Far Range Imager 1D Typical Reading Distances

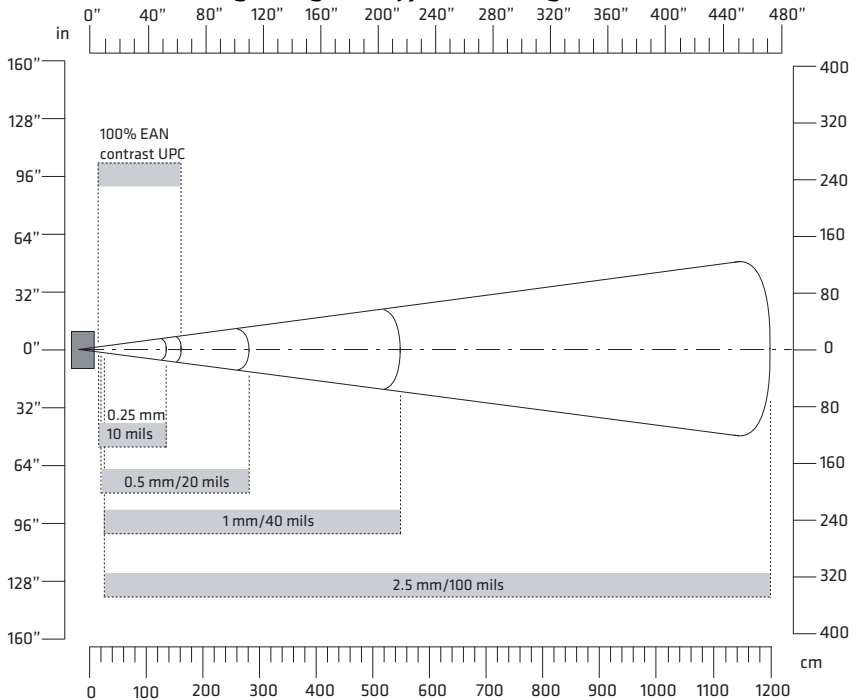

EX25C 1D Symbologies Typical Reading Distances With 0.24 cm (0.09 in) Setback

Symbology	Density	Minimum Distance	Maximum Distance
Code 39	0.25 mm (10 mils)	15 cm (5.91 in)	135 cm (53.15 in)
	0.5 mm (20 mils)	16 cm (6.30 in)	280 cm (110.24 in)
	1 mm (40 mils)	25 cm (9.84 in)	550 cm (216.54 in)
	1.4 mm (55 mils)	40 cm (15.75 in)	720 cm (283.46 in)
	2.5 mm (100 mils)	**	1200 cm (472.44 in)
Code 128 retro-reflective	2.5 mm (100 mils)	**	1300 cm (511.81 in)

Symbology	Density	Minimum Distance	Maximum Distance
EAN 100%	0.33 mm (13 mils)	15 cm (5.91 in)	160 cm (62.99 in)

** Minimum distance depends on bar code width and scan angle.

EX25C Near-Far Range Imager 2D Typical Reading Distances

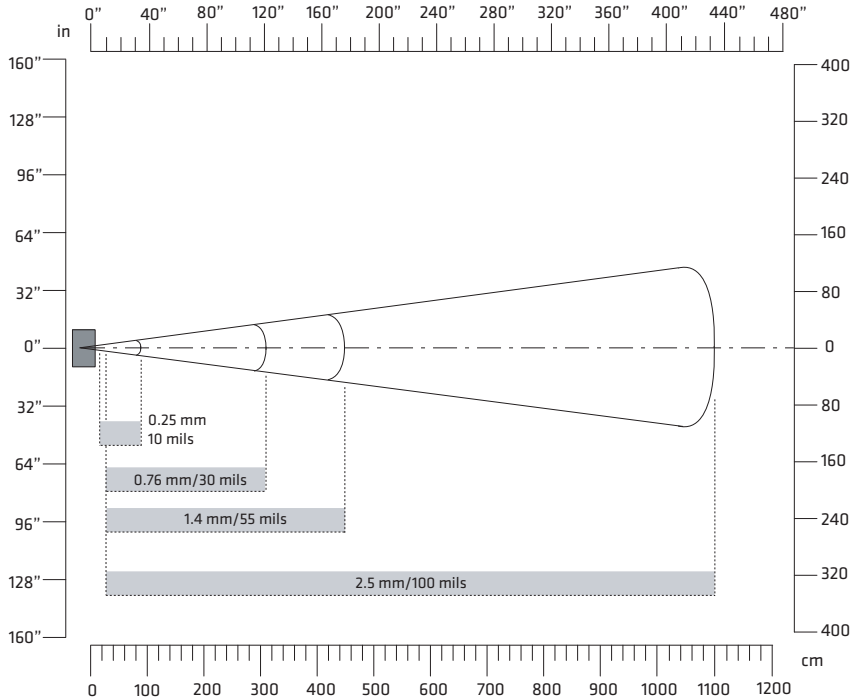

EX25C 2D Symbologies Typical Reading Distances With 0.24 cm (0.09 in) Setback

Symbology	Density	Minimum Distance	Maximum Distance
DataMatrix	0.25 mm (10 mils)	15 cm (5.91 in)	90 cm (35.43 in)
	0.76 mm (30 mils)	25 cm (9.84 in)	310 cm (122.05 in)
	1.4 mm (55 mils)	**	450 cm (177.17 in)
	2.5 mm (100 mils)	**	1100 cm (433.07 in)

** Minimum distance depends on bar code width and scan angle.

Default Configuration

The following tables list the default values of the configuration commands supported on the computer. If you restore to factory default settings, the mobile computer uses these values.

The commands are grouped by function and reflect the organization of Intermec Settings. You can configure your computer with Intermec Settings from the SmartSystems Foundation console. For detailed information on most of the commands, see the *Intermec Settings Command Reference Manual*.

Data Collection

Symbology Settings

Symbology	Default Value
AustraliaPost	Disable
Aztec	Disable
BPO	Disable
CanadaPost	Disable
ChinaPost	Disable
Codabar	Disable
Codablock A	Disable
Codablock F	Disable
Code 11	Disable
Code 39	Enable
Code 93	Disable
Code 128/GS1-128	Enable
DataMatrix	Enable
DutchPost	Disable
EAN/UPC	Enable UPC A, UPC E, EAN 8, EAN 13
GS1 Composite	Disable
GS1 DataBar Expanded	Disable
GS1 DataBar Limited	Disable
GS1 DataBar Omnidirectional	Disable
Infomail	Disable

Symbology	Default Value
Interleaved 2 of 5	Disable
JapanPost	Disable
KoreanPost	Disable
Matrix 2 of 5	Disable
Maxicode	Disable
Micro PDF417	Disable
MSI	Disable
PDF417	Enable
Planet	Disable
Plessey	Disable
Postnet	Disable
QR Code	Disable
Standard 2 of 5	Disable
SwedenPost	Disable
Telepen	Disable
TLC 39	Disable

Symbology Option Settings

Symbology Option	Default Value
Preamble	None (disabled)
Postamble	None (disabled)
Global Symbology ID	Disable
Multicode	Disable

Imager Settings

Imager Setting	Default Value
Predefined Modes	1D and 2D Standard
Signature Image Capture	Disable
Document Imaging	Disable

Decode Security Settings

Decode Security Setting	Default Value
Consecutive Data Validation	0
Identical Consecutive Timeout	300 ms
Different Consecutive Timeout	0
Center Decoding	Disable
Center Decoding Tolerance	0

Communications

Communication Settings

Communication Settings	Default Value
Device Name	CN50xxxxxxxxxxxx

Bluetooth Settings

Bluetooth Settings	Default Value
Bluetooth Power	Off
Bluetooth Discoverable	Disable
Bluetooth Connectable	Disable

802.11 Radio Settings

802.11 Radio Settings	Default Value
Allow Security Changes	Enable
Radio Measurement	0
Radio Enabled	Enable

Ethernet Adapter Settings

IP Settings	Default Value
DHCP	Enable

IP Settings	Default Value
DHCP Client Identifier	Null
Primary DNS	0.0.0.0
Secondary DNS	0.0.0.0
Primary WINS	0.0.0.0
Secondary WINS	0.0.0.0

Certificates Settings

Certificates Settings	Default Value
Import Root Certificates	False
Import User Certificates	False
Import Pac Files	False

Ethernet Adapter IP Settings

Ethernet Adapter IP Settings	Default Value
DHCP	Enable
DHCP Client Identifier	Null
Primary DNS	Null
Secondary DNS	Null
Primary WINS	Null
Secondary WINS	Null

Device Settings

Device Settings	Default Value
Date	Null
Time	Null
Adjust for Daylight Time	Disable
Good Read Beep	One Beep
Beeper Volume	Medium

Appendix A – Specifications and Default Settings



Worldwide Headquarters
6001 36th Avenue West
Everett, Washington 98203
U.S.A.

tel 425.348.2600

fax 425.355.9551

www.intermec.com

© 2010 Intermec Technologies
Corporation. All rights reserved.

70 Series Mobile Computer User's Manual



P/N 935-038-001