

Compliance Statement Insert

Device Name: Hand-held Computer

Model Number: 6400

The responsible party for the compliance of this device is:

**Intermec Technologies Corporation
Norand Mobile System Division
550 Second Street SE
Cedar Rapids, Iowa 52401 USA
(319) 369-3100**

CAUTION: See users guide instructions for handling, charging, and replacing batteries. Failure to follow those instructions can result in personal injury, fire, or battery explosion.

This product complies to the following approvals. The user(s) of this product are cautioned to use accessories and peripherals approved by Norand Corporation. The use of accessories other than those recommended or changes to this product that are not approved by Norand Corporation may void the compliance of this product and may result in the loss of the users authority to operate the equipment.

FCC Digital Emissions Compliance

This equipment has been tested and found to comply with the limits for a Class B digital device, pursuant to Part 15 of the FCC Rules. These limits are designed to provide reasonable protection against harmful interference in a residential installation. This equipment generates, uses and can radiate radio frequency energy and, if not installed and used in accordance with the instructions, may cause harmful interference to radio communications. However, there is no guarantee that interference will not occur in a particular installation. If this equipment does cause harmful interference to radio or television reception, which can be determined by turning the equipment off and on, the user is encouraged to try to correct the interference by one or more of the following measures:

- Reorient or relocate the radio of television receiving antenna.
- Increase the separation between the computer equipment and receiver.
- Connect the equipment into an outlet on a circuit different from that to which the radio or television receiver is connected.
- Consult the dealer or an experienced radio television technician for help.

Canadian Digital Apparatus Compliance

This Class B digital apparatus meets all requirements of the Canadian Interference-Causing Equipment Regulations.

Cet appareil numérique de la classe B respecte toutes les exigences du Règlement sur le matériel brouilleur du Canada.

FCC Spread Spectrum Transmitter Compliance

This device is also certified to operate under Part 15, Subpart C, Section 15.247 of the FCC rules for Intentional Radiation Products. This certification includes Docket 87-389 covering rules effective June 1994. It may not cause interference to authorized radio communication devices, and must accept any interference caused by those devices.

Canadian RSS-210 Spread Spectrum Transmitter Compliance

Operation is subject to the following two conditions: (1) this device may not cause interference, and (2) this device must accept any interference, including interference that may cause undesired operation of the device.

Canadian 2.4 GHz Spread Spectrum Radio Certification

This device requires a radio license, unless it is installed totally inside a building. (User's must obtain this license.)

Une license radio est requise pour ces dispositifs, sauf pour ceux installés tout à fait à l'intérieur d'un bâtiment. (Il faut que l'utilisateur obtienne cette license.)

Antenna Requirements

FCC rules section 15.203 and Canada RSS-210 require that this device be operated using an antenna furnished by Norand Corporation. The antenna coupling on this product has been designed to accept only antennas manufactured Norand. Use of an antenna other than that furnished with the equipment is prohibited by FCC and Industry Canada rules.

European Notice

The 902-928 MHz Spread Spectrum Transmission (SST) radio referred to within this manual is not available for sale in Europe (including, but not limited to, Great Britain, Italy, Germany, France, Spain, Norway, Denmark, Sweden, Finland, Portugal, and the Benelux countries). Any references in this manual to 902-928 MHz SST, or modules containing 902-928 MHz SST radios, should be disregarded by the users of this product in Europe.

DECLARATION OF CONFORMITY

(According to ISO/IEC Guide 22 and EN 45014)

PAGE ONE OF TWO

THE PRODUCT HEREWITH COMPLIES WITH THE REQUIREMENTS OF :

THE LOW-VOLTAGE DIRECTIVE 72/32/EEC.
THE EMC DIRECTIVE 89/336/EEC.

Manufacturer's Name:

Intermec Technologies Corporation
550 2nd Street SE
Cedar Rapids, Iowa 52401

European Representative:

Intermec International Incorporated
Sovereign House, Vastern Road
Reading, Berkshire
RG1 8BT England

Declares that the product listed below:

Product Type: ITE/Residential, Commercial, and Light Industrial

Product Name: 6400 Hand-held Computer with all docking options

Model Number: 6400

Beginning Serial Number: All

Product Options: All

Date Issued: April. 8, 1996

Conforms to the following product specifications:

Safety: IEC 950 / EN 60950

EMC: EN 55022 : 1995 / CISPR Publications 22 : 1993, Class B Limits and Methods

EN 50082-1 : 1992 Generic Immunity Standard

IEC 801-2 Tested per IEC 1000-4-2 : 1995-01

8 kV Air / 4 kV Direct, Criteria B

IEC 801-3 Tested per IEC 1000-4-3 : 1995-02

3 V/M, 27-1000 MHz, 80% @ 1kHz, Criteria A

IEC 801-4 Tested per IEC 1000-4-4 : 1995-01

Power leads 2 kV, Signal leads 1 kV, Criteria B

ETS 300 339 : Jun. 1993 Draft RES Generic EMC for radio equipments

IEC 801-2 per Draft prETS 300 339, Clause 9.2

± 8 kV Air / ± 4 kV Contact

IEC 801-3 per Draft prETS 300 339, Clause 9.1

3 V/M, 80-1000 MHz, 80% @ 400 Hz

Type Approval Certification(s): see second page of Declaration of Conformity

I, the undersigned, hereby declare that the equipment specified above conforms the above Directive(s) and Standard(s).

Company Official: Arvin Danielson

Position: Vice President

Signature: _____ Signed Copy on File

Date: August 4, 1998

European Contact: Scott Mercer, Intermec International Incorporated, Sovereign House, Vastern Road, Reading, Berkshire, RG1 8BT England; Phone INT+44 118 987 9400; Fax INT+ 44 118 987 9401

DECLARATION OF CONFORMITY

PAGE TWO OF TWO

Product Type: ITE/Residential, Commercial, and Light Industrial
Product Name: Hand-held Computer **Model Number:** 6400

Product Option: RM180

Type Approval Certifications:

ARGENTINA:	FCC ID: EHARM24002PC	AUSTRALIA:	FCC ID: EHARM24002PC
AUSTRIA:	CEPT-RLAN A	BRAZIL:	FCC ID: EHARM24002PC
CANADA:	Canada 1008 101 760A	CHILE:	FCC ID: EHARM24002PC
COLOMBIA:	FCC ID: EHARM24002PC	COSTA RICA:	FCC ID: EHARM24002PC
DENMARK:	CEPT/RLAN/DK/9608	FINLAND:	Label added in Finland
FRANCE:	960182PP0	GERMANY:	G128682H
GREECE:	ΑΝ×ΕΕΑ ΑΕΑΑ×ΠΙΔΙÇ 000ΕΑ0Ç >ΝÇ0Ç:ΙΑ0Α0ΙΝΑ0 ΑΑΑΠΙΔΙΥ 'Αδενε0ç Ε0εεΙονεά0 0ΔΙΔ/Α0ΑΑ/ΑΕ537	HONG KONG:	FCC ID: EHARM24002PC
ICELAND:	CEPT-RLAN IS-2433-02	INDIA:	FCC ID: EHARM24002PC
ITALY:	(For 41-key terminal) CEPT-RLAN I DGPGF/SEGR/2/144-03/336997/AT/0001728 del 09/09/1996	(For 51-key terminal) CEPT-RLAN I DGPGF/SEGR/2/144-03/336998/AT/0001725 del 09/09/1996	
KOREA:	Radio Type Registration	MEXICO:	SCYT: RCPNORM97-308
NETHERLANDS:	ministerie van verkeer waterstaat NL9603057 CEPT R-LAN NL	NORWAY:	CEPT-RLAN N
PERU:	FCC ID: EHARM24002PC	POLAND:	ME E.H. N° 043/98
SINGAPORE:	TAC No. PMREQ-WLAN-B-0621-98	SPAIN:	E D.G.Tel 06 97 0340
SWEDEN:	Godkaend av Post- och Telestyrelsen Ue 960059 CEPT-RLAN S Norand Corporation RM180	TAIWAN:	85G0069
TURKEY:	FCC ID: EHARM24002PC	UNITED KINGDOM:	CEPT-RLAN GB
UNITED STATES:	FCC ID: EHARM24002PC	VENEZUELA:	FCC ID: EHARM24002PC

Product Option: RM188

Type Approval Certifications:

JAPAN: MKK Approved

Product Option: RM160

Type Approval Certifications:

ARGENTINA:	FCC ID: EHARM915P	AUSTRALIA:	FCC ID: EHARM915P
BRAZIL:	FCC ID: EHARM915P	CANADA:	Canada 1008 102 269
CHILE:	FCC ID: EHARM915P	COLOMBIA:	FCC ID: EHARM915P
COSTA RICA:	FCC ID: EHARM915P	MEXICO:	SCYT: RCPNORM97-319
PERU:	FCC ID: EHARM915P	UNITED STATES:	FCC ID: EHARM915P
VENEZUELA:	FCC ID: EHARM915P		



6400 Hand-Held Computer
USER'S GUIDE

PN: 961-047-093
Revision A
September 1997

" NOTICE

This publication contains information proprietary to Intermecc Technologies Corporation. It is being supplied to you with the express understanding that the information contained herein is for the benefit of the contracting party only, and may not be copied, distributed, or displayed to third parties without the express written consent of Intermecc Technologies Corporation, and shall be returned to Intermecc Technologies Corporation upon written request. If a purchase, license, or nondisclosure agreement has been executed, the terms of that agreement shall govern this document.

This publication is furnished for information only, and the information in it is subject to change without notice. Although every effort has been made to provide complete and accurate information, Intermecc Technologies Corporation assumes no responsibility or liability for any errors or inaccuracies that may appear in this document.

Disclaimer of Warranties. The sample source code included in this document is presented for reference only. The code does not necessarily represent complete, tested programs. The code is provided **"AS IS WITH ALL FAULTS."** **ALL WARRANTIES ARE EXPRESSLY DISCLAIMED, INCLUDING THE IMPLIED WARRANTIES OF MERCHANTABILITY AND FITNESS FOR A PARTICULAR PURPOSE.**

We welcome your comments concerning this publication. Although every effort has been made to keep it free of errors, some may occur. When reporting a specific problem, please describe it briefly and include the book title and part number, as well as the paragraph or figure number and the page number.

Send your comments to:
Intermecc Technologies Corporation
Publications Department
550 Second Street SE
Cedar Rapids, IA 52401

INTERMECC, NORAND, NOR*WARE, PEN*KEY, PEN*VIEW, and TRAKKER are registered trademarks and ANTARES, JANUS, and RAPIDREP are trademarks of Intermecc Technologies Corporation.

© 1996 Intermecc Technologies Corporation. All rights reserved.



This publication printed on recycled paper.

Acknowledgments

AS/400, *IBM*, *IBM PC*, *Micro Channel*, *PS/2*, and *OS/2* are registered trademarks and *AIX* and *Presentation Manager* are trademarks of International Business Machines Corporation.

DEC, *VAX*, *VMS*, *VT*, and *VT220* are registered trademarks of Digital Equipment Corporation.

Ethernet is a trademark of Xerox Corporation.

Microclean II is a registered trademark of Foresight International.

Microsoft, MS, and MS-DOS, and Windows, are registered trademarks and Visual Basic for Windows, and Windows for Pen are trademarks of Microsoft Corporation.

Norton Disk Doctor and Norton Utilities are registered trademarks of Peter Norton Computing Inc.

Novell and UNIX are registered trademarks of Novell Inc.

PenRight! and PenRight! Pro are trademarks of PenRight Corporation.

PKZIP and PKUNZIP are registered trademarks of PKWARE, Inc.

PolyPM/2 is a registered trademark of International Software Solutions.

SUN is a trademark of Sun Microsystems.

SanDisk is a trademark of SanDisk Corporation.

Turbo Pascal is a registered trademark and *Borland C and C++ for Windows* are trademarks of Borland International, Inc.

FCC Computer Compliance

" NOTICE

This equipment meets Class B digital device limits per Part 15 of FCC Rules. These limits protect against interference in a residential area. It emits, uses, and can radiate radio frequency energy. If you do not install and use the equipment according to its instructions, it may interfere with radio signals. However, there is no guarantee that interference will not occur in a particular installation.

If this equipment does cause harmful interference to radio or television reception, which can be determined by turning our equipment off and on, the user is encouraged to try to correct the interference by one or more of the following measures:

- " Reorient or relocate the radio or television receiving antenna.
- " Increase the separation between the computer equipment and receiver.
- " Connect the equipment into an outlet on a circuit different from that to which the radio or television receiver is connected.
- " Consult the dealer or an experienced radio or television technician for help.

FCC Spread Spectrum Radio Certification

" NOTICE

This device is certified to operate under Part 15, Subpart C, Section 15.247 of the FCC rules for Intentional Radiation Products. This certification includes Docket 87-389 covering rules effective June 1994. It may not cause interference to authorized radio communication devices, and must accept any interference caused by those devices.

Antenna Requirements

" NOTICE

FCC rules section 15.203 and Canada's RSS-210 require that this device be operated using an antenna furnished by Intermec Technologies Corporation. The antenna coupling on this product has been designed to accept only antennas manufactured by us. Use of an antenna other than that furnished with the equipment is prohibited by FCC and Industry Canada rules.

Canadian Computer Compliance

This Class B digital apparatus meets all requirements of the Canadian Interference-Causing Equipment Regulations.

Cet appareil numérique de la classe B respecte toutes les exigences du Règlement sur le matériel brouilleur du Canada.

Canadian Spread Spectrum Radio Certification

" NOTICE

This device complies with RSS-210 of Industry Canada. Operation is subject to the following two conditions: (1) this device may not cause interference, and (2) this device must accept any interference, including interference that may cause undesired operation of the device.

Canadian 2.4 GHz Radio License

" NOTICE

This device requires a radio license, unless it is installed totally inside a building. (Users must obtain this license.)

Une licence radio est requise pour ces dispositifs, sauf pour ceux installés tout à fait à l'intérieur d'un bâtiment. (Il faut que l'utilisateur obtienne cette licence.)

European Notice

The 902-928 MHz SST (Spread Spectrum Transmission) radio referred to in this manual is not available for sale or use in Europe (including, but not limited to, Great Britain, Italy, Germany, France, Spain, Norway, Denmark, Sweden, Finland, Portugal, and the Benelux countries). Any references in this manual to 902-928 MHz SST, or modules containing 902-928 MHz SST radios, should be disregarded by users of this product in Europe.

Telephone Installation Warning Notices

The following notices apply to equipment that may be connected to telephone lines or systems. For your personal safety, and to protect this equipment from potential electrical or physical damage, do NOT connect equipment to telephone lines or data communication equipment unless the following warnings have been read, understood, and complied with.

- " Never install telephone wiring during a lightning storm.
- " Never install telephone jacks in wet locations unless the jack is specifically designed for wet locations.
- " Never touch uninsulated telephone wires or terminals unless the telephone line has been disconnected at the network interface.
- " Use caution when installing or modifying telephone lines.
- " Avoid using a telephone (other than cordless type) during an electrical storm. There may be a remote risk of electric shock from lightning.

- “ Do not use the telephone to report a gas leak in the vicinity of the leak.

Installation du téléphone : avertissements

Les avertissements qui suivent s'appliquent à tout équipement qui peut être branché aux lignes ou systèmes téléphoniques. Pour votre sécurité personnelle et pour protéger l'équipement de tout dommage électrique ou physique potentiel, NE PAS brancher un ordinateur tablette électronique ou ses périphériques aux lignes téléphoniques ou équipements avant que les avertissements suivants aient été lus, compris et observés :

- “ Ne jamais installer de câblage téléphonique pendant un orage électrique.
- “ Ne jamais installer de prise téléphonique dans un endroit humide à moins que la prise ait été spécifiquement conçue pour être utilisée dans les endroits humides.
- “ Ne jamais toucher les fils de téléphone ou de l'équipement terminal non isolés à moins que la ligne téléphonique n'ait été débranchée de l'interface réseau.
- “ User de prudence lors de l'installation ou de la modification de lignes téléphoniques.
- “ Éviter d'utiliser un téléphone (autre qu'un appareil téléphonique sans fil) pendant un orage électrique. Il pourrait y avoir un faible risque d'électrocution par la foudre.
- “ Ne pas utiliser le téléphone afin de signaler une fuite de gaz à proximité de la fuite.

B CAUTION: Intermec Technologies Corporation suggests you buy cables from us to connect with other devices. Our cables are safe, meet FCC rules, and suit our products. Other cables may not be tested. They may cause problems from electrostatic discharge or induced energy. Our warranties do not cover loss, injury, or damage from other cables.

B CAUTION: Intermec Technologies Corporation recommends that you only purchase Norand Mobile Systems Division certified modems. Intermec does not certify all modems available in the marketplace. Intermec does not warrant noncertified modems; furthermore, these modems may cause problems from electrostatic discharge and may not conform to FCC regulations. For a list of Norand Mobile Systems Division certified modems call Customer Support at 1-800-221-9236 in United States or (country code) 800-633-6149 in Canada.



WARNING: *The lithium ion battery may explode if replaced incorrectly. Replace only with the same or equivalent type.*



ADVERTISSEMENT: *La batterie au lithium peut exploser si elle est remplacée de manière incorrecte. Elle ne doit être remplacée que par une batterie identique ou similaire.*



WARNING: *Lithium ion batteries may explode or catch fire if overcharged due to improper dock installation.*



AVERTISSEMENT: *Les batteries au lithium peuvent exploser ou prendre feu si elles sont trop chargées à cause d'une mauvaise installation de la station d'accueil.*

CONTENTS

SECTION 1

General Information

About this User's Guide	1-1
Summary of Sections	1-1
Unpacking and Inspecting	1-2
Hand-Held Computer Main Components	1-4
Hand-Held Computer Keyboard	1-7
Key Descriptions	1-10
ENT (Enter) Key	1-10
SCAN Key	1-10
Period [.] Key	1-10
Minus [-] Key	1-10
Numeric Keys	1-11
Alphabetic Keys	1-11
Backspace [] Key	1-11
Shift Keys	1-11
Using Shifted Functions	1-13
Display Annunciator Locations on Display Window	1-15
Annunciator Descriptions	1-16
Display Annunciators (Messages)	1-16
Display Contrast	1-19
Backlight	1-19
Window Scrolling Arrows	1-19
[I/O] Suspend or Resume	1-20
Handstrap	1-20
Buzzer	1-23
Infrared (IrDA) Port	1-23
Battery Management	1-23
Battery	1-24
Main Battery Pack	1-24
Backup Battery	1-26
Memory	1-26

Main Memory	1-26
Flash	1-27
Diagnostic EEPROM	1-27
Resetting	1-27
Batch Terminal Operation	1-28
Terminal Emulation	1-28
Accessories and Options	1-28
Internal Scanner	1-28
Internal Radio	1-28
Communication Adapter	1-29
Scanner Handle	1-31
Adjustable Wrist Strap and Adjustable Handstrap ...	1-33
Hand-Held Computer Specifications	1-35
900 MHz Radio Option	1-37
NIC Specifications	1-37
2.4 GHz Radio Option	1-38
NIC Specifications	1-39
Radio and Scanner Modules	1-39

SECTION 2

Operation

Introduction	2-1
Before Using Your Computer for the First Time	2-1
Rechargeable Battery Labelling	2-4
Installing the Main Battery	2-5
Removing the Main Battery	2-6
Measuring Battery Pack Charge Level	2-8
Charging Your Battery Pack	2-9
In Your Hand-Held Computer	2-9
In An External Source	2-10
Battery Charger LED and Error Codes	2-12
Charging Indicator Error Codes	2-12
Backup Battery	2-13
Downloading Programs To Your Hand-Held Computer ...	2-14
Programming the Flash	2-14
Turning Your Hand-Held Computer On and	
Off (Suspending)	2-15
Turning On Your Hand-Held Computer	2-15
Suspending Your Hand-Held Computer	2-15
Understanding the Key Clicks	2-16

Scanning	2-17
Using an Integrated Scanner	2-17
Installing the Optional Scanning Handle	2-19
Installing the Optional Scanning Handle with Battery Pack	2-20
Charging the Scanner Handle Batteries	2-21
Using a Tethered Bar Code Scanner	2-22
Tethered Scanner Supported	2-22
Software	2-24
Setting Terminal Emulation to Accept Tethered Laser Scanners	2-24
Setting Your DOS Application to Accept Tethered Laser Scanners	2-25
Setting Up Your LS3203 or LS3603 RS-232 Serial Scanner Parameters	2-25

SECTION 3

Terminal Emulation Menu Screens

Introduction	3-1
Keyboard Functions	3-1
Yellow and Blue Shift Keys	3-1
Enter [ENT] Keys	3-2
Number Keys [0] Through [9]	3-2
Y Up and B Down Arrows	3-3
Display Annunciators	3-3
Display Position 0	3-3
Display Position 1	3-3
Display Position 2	3-4
Display Position 3	3-4
Display Position 4	3-4
Display Positions 5-8	3-5

Setting the Operating Parameters	3-6
Opening the Main Menu	3-6
Opening the Set-Up Parm's Menu	3-10
Protocol Options	3-24
Display Options	3-34
Radio Comm	3-35
Cold Start	3-36
More	3-36
Print Device	3-37
LCD Parm's	3-37
Screen Size	3-38
Screen Mode	3-39
Annunciators	3-41
Key Uppercase	3-41
Scroll Window	3-42
Beeper Setup	3-42
Key Click	3-43
Error Tone	3-44
Beeper Select	3-44
Tests	3-45
Peripherals	3-45
Memory View	3-49
Packet Driver Test	3-49
Histogram Opt's	3-51
Numbers	3-52
Timed Numbers	3-52
Version Info (Information)	3-52
Exit Menus	3-53
More	3-53
Keyboard Opt's	3-53
Save Parm's	3-54
Session Menu	3-54
To Exit Emulation Mode and Return to DOS	3-56

SECTION 4**Maintenance and Troubleshooting**

Introduction	4-1
Low Battery Indication	4-1
Cleaning Your Hand-Held Computer	4-3
Case and Display	4-3
Docking Connectors	4-3
Troubleshooting	4-4
Troubleshooting Table	4-4
Diagnostic Information	4-9
Repair Service	4-10

APPENDIX A**Connector Pin-Outs**

8-Pin Docking Connector (standard)	A-1
Optional Communication Adapter 9-Pin D-Sub Connector	A-2

APPENDIX B**NORAND[®] Utilities Program**

Entry Point	B-1
Pop-Up Menus	B-2
Drop-Down Lists	B-2
Alphanumeric Fields	B-3
Title Screen	B-4
Language Selection	B-5

Communications Menu	B-6
Option 1 BEGIN COMM SESSION	B-7
Option 2 COMM SETTING	B-15
Option 3 UNIT ID	B-18
Option 4 NETWORK PARAMETERS	B-18
Option 4 MODEM PARAMETERS	B-20
Option 5 PHONE NUMBER	B-24
Option 9 ADVANCED UTILITIES	B-25

APPENDIX C

Keyboard Overlays

41-Key DOS/PC	C-2
51-Key DOS/PC	C-3
41-Key 5250	C-4
51-Key 5250	C-5
41-Key 3270	C-6
51-Key 3270	C-7
41-Key VT220	C-8
51-Key VT220	C-9
41-Key NATIVE	C-10
51-Key NATIVE	C-11

FIGURES

Figure 1-1 Front View	1-4
Figure 1-2 Back View	1-5
Figure 1-3 Top View	1-6
Figure 1-4 Bottom View	1-6
Figure 1-5 41-Key Keyboard	1-8
Figure 1-6 51-Key Keyboard	1-9
Figure 1-7 Annunciator Locations On Display	1-15
Figure 1-8 Bottom End Handstrap Attachment	1-21
Figure 1-9 Top End Handstrap Attachment	1-22
Figure 1-10 Communication Adapter Scanner Connector	1-29
Figure 1-11 Communication Adapter Charger Connector .	1-30
Figure 1-12 Scanner Handle	1-31
Figure 1-13 Scanner Handle with Optional Battery Pack	1-32
Figure 1-14 Adjustable Handstrap	1-33
Figure 1-15 Adjustable Wrist Strap	1-34
Figure 2-1 Resetting Your Computer	2-3
Figure 2-2 Installing Main Battery Pack	2-5
Figure 2-3 Removing Main Battery Pack	2-7
Figure 2-4 Main Battery Pack Underside View Showing Contacts	2-8
Figure 2-5 Multipack Charger	2-10
Figure 2-6 Single Pack Charger	2-11
Figure 2-7 Optional Scanner Handle	2-19
Figure 2-8 Optional Scanner Handle with Battery Pack ..	2-20
Figure 2-9 Inserting Scanner Handle Into Charger	2-21
Figure 2-10 Connecting a Tethered Scanner	2-23
Figure A-1 8-Pin Docking Connector Pinouts	A-1
Figure A-2 9-Pin D-Sub Connector Pinouts	A-2

TABLES

Table 2-1 Charging Indicator Error Codes	2-12
Table 2-2 Solution Notes	2-13
Table 4-1 Basic Troubleshooting	4-4

Section 1

General Information

About this User's Guide

This user's guide is divided into four sections and three appendixes.

Summary of Sections

Section 1

Contains general information about the components of your computer. This includes how the user's guide is organized, a summary of the sections, and the specifications for your hand-held computer.

Section 2

Describes how to prepare for using your hand-held computer.

Section 3

Shows the terminal emulation menu screens for setting parameters. This section only applies if you are running NORAND[®] terminal emulation software.

Section 4

Steps you through some procedures to use when troubleshooting your hand-held computer. This section also includes information for maintaining your computer. Routine maintenance includes recharging the main battery pack; replacing the handstrap; and cleaning the keyboard, connectors, and display.

Appendix A

Pin-outs for the external connectors.

Appendix B

NORAND ROM Utilities Programs are intended for your system administrator for setting parameters to support your application.

Appendix C

Contains terminal emulation overlays offered for your computer.

Unpacking and Inspecting

The following procedures explain what to do when your hand-held computer arrives, and what to do if it has been damaged in shipping:

1. Remove the hand-held computer from its shipping container and inspect for any visible damage.
2. If your hand-held computer was damaged in shipping, record the model number, part number, and serial number. These numbers can be found on the back side of the hand-held computer.
3. Save all paperwork pertaining to shipment, and immediately notify the transport company of the damaged item(s). Follow their instructions for filing a claim on the damaged items.

Authorized repair of NORAND products is available only at NORAND Service Centers. Unauthorized repair voids any and all warranties. Contact your NORAND Sales Representative for additional instructions.

Hand-Held Computer Main Components

Figure 1-1, Figure 1-2, Figure 1-3, and Figure 1-4 on pages 1-4, 1-5, and 1-6 show you the location of the main components for your hand-held computer.

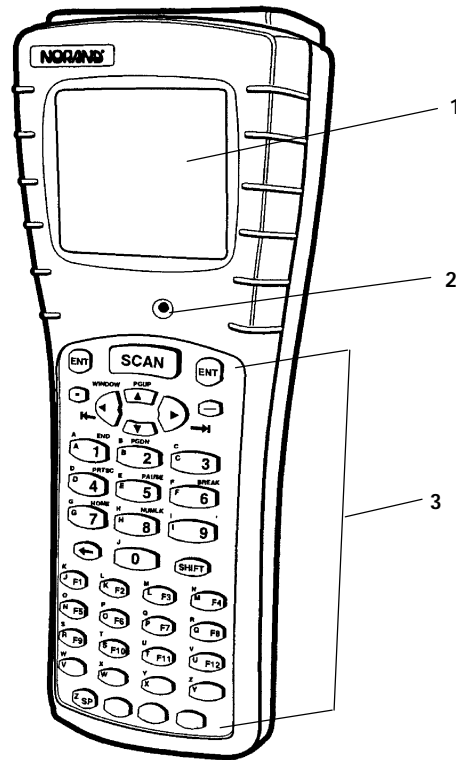

- 1. Display
- 2. Buzzer
- 3. Keyboard

Figure 1-1
Front View

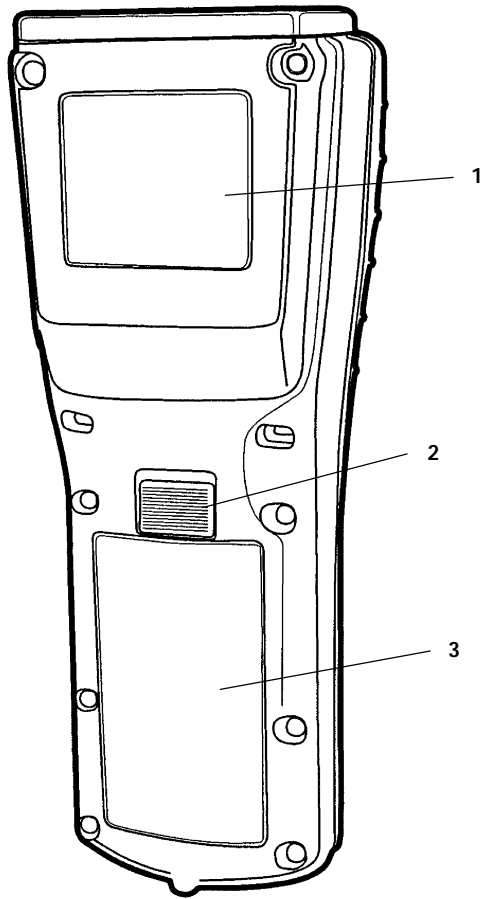

1. Label identifying model, serial number and class of scanner (optional)
2. Battery pack latch
3. Battery pack

Figure 1-2
Back View

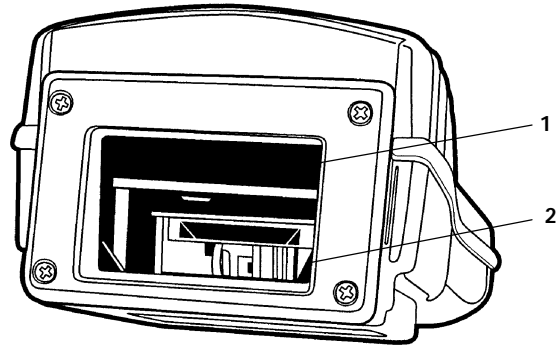

- 1. Radio card (optional)
- 2. Scanner (optional)

Figure 1-3
Top View

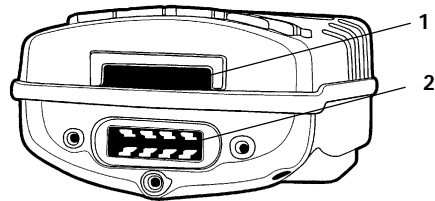

- 1. IrDA interface
- 2. Docking connector and optional communication adapter connector

Figure 1-4
Bottom View

Hand-Held Computer Keyboard

This hand-held computer provides two keyboard options. Figure 1-5 on page 1-8 and Figure 1-6 on page 1-9 detail the 41- and 51-key keyboards.

- For the 41-key keyboard, function and numeric keys are single keystrokes. Alphabetical characters can be entered by using the green, blue, or yellow shift keys.
- For the 51-key keyboard, alphabetic and numeric keys are single keystrokes. Special function keys can be entered by using the green, blue, or yellow shift keys.

Key Descriptions (41-Key)

1. Scan key
2. ENTER keys
3. Window scrolling keys
4. Numeric keys (0-9)
5. Green shift key
6. Function keys (F1-F12)
7. Special function keys (depending on keyboard overlay used)
8. I/O (Suspend/Resume) key
9. Yellow shift key
10. Blue shift key
11. Space key
12. Backspace key

Key Descriptions (51-Key)

1. Scan key
2. ENTER keys
3. Window scrolling keys
4. Numeric keys (0-9)
5. Green shift key
6. Alphabetic keys
7. I/O (Suspend/Resume) key
8. Yellow shift key
9. Blue shift key
10. Special function keys (depending on keyboard overlay used)
11. Backspace key

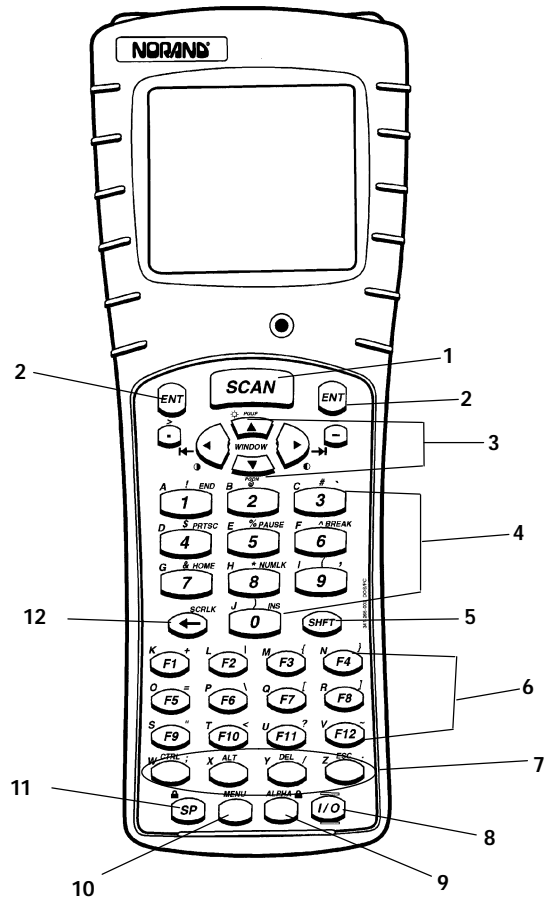

Figure 1-5
41-Key Keyboard

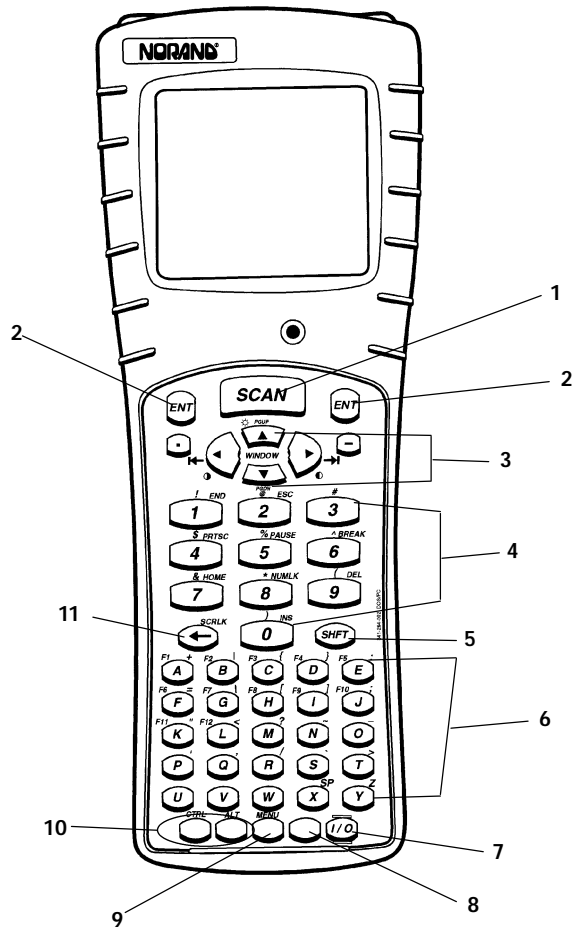

Figure 1-6
51-Key Keyboard

Key Descriptions

This section includes a description of how the shift keys work and the differences between a 41-key and 51-key keyboard. Your particular keyboard may have an overlay that has additional keys other than those described in this section. Refer to your application operation manual for descriptions of those keys. The following descriptions cover both the 41-key and 51-key computers using a DOS/PC overlay.

ENT (Enter) Key

Two Enter keys are provided for the convenience of both left and right handed users. These keys are the same as an ↵ (Enter) key on a PC. You use them to enter data, or as a "Yes" response to display prompts.

SCAN Key

This key is used with an integrated scanner to read bar code labels. If your application does not use a scanner or if you are using an optional tethered scanner, you probably will not use this key. Pressing this key also resumes operation (awaken your hand-held computer) if it is in the suspend mode.

Period [.] Key

Use the period [.] key as a period or a decimal point.

Minus [-] Key

Use the minus [-] key to enter negative values or dashes in character fields. The minus key is also used for "No" responses to display prompts.

Numeric Keys

Use the numeric keys as you would those on a calculator. Numeric values are single keystroke operations.

Alphabetic Keys

Your computer provides the full alphabet on both the 41- and 51-key keyboards. Alphabetic characters are single keystroke operations with the 51-key keyboard but are two keystrokes on a 41-key keyboard. Alphabetic characters can be entered on the 41-key keyboard by using the blue shift key.

Backspace [←] Key

Use the backspace key to back the cursor up one character at a time. Holding this key down causes the cursor to continuously move backwards until you stop or you run out of space to move.

Shift Keys

Your hand-held computer has three different "shift" function keys. These keys temporarily shift the function of the keyboard. Your keyboard has a green [SHIFT] key, a blue key and a yellow key. The green shift key is a standard shift key. Both the blue and yellow keys work just like the shift key, and allow access to different alternate functions. Your keyboard may have up to three color-coded legends (words or characters) above some of the keys. The green, blue, or yellow "shift" keys correspond to those options.

Green [SHFT] Key

Pressing the green [SHFT] key shifts the keyboard between uppercase and lowercase for a single keystroke entry. If the keyboard is set for uppercase character entry, pressing green [SHFT] followed by a character key enters a single lowercase character.

Blue Key

Use the blue shift key to enter single keystroke entries of that shifted option. The blue shifted function relates to the blue legends located above the keys.

Using a 41-Key Keyboard

On the 41-key keyboard, above the yellow shift key is Alphabetic Lock, illustrated by the symbol ALPHA . This locks the keyboard so only the alphabetical characters are entered. Press the blue key and then the yellow key.

The blue padlock  is CAPS LOCK. This causes alphabetic characters to be capitalized. Press the blue key and then the space key.

ALPHABETIC or CAPS lock continues until the blue then yellow shift keys are pressed again.

Using a 51-Key Keyboard

On the 51-key keyboard, there is no ALPHA Lock key because the alphabetical letters are not shifted functions.

Yellow Key

Use the yellow shift key to enter single keystroke entries of that shifted option. The yellow shift functions relates to the yellow legends on your keyboard.

Using Shifted Functions

This section explains the use of the shift keys.

The Rules

The green [SHFT] key is the same as the SHIFT key on a PC **except** that the green shift key also relates to those characters where green legends appear above the keys.

EXAMPLE: On a PC, SHIFT [3] produces the # character, and that is the same on the hand-held computer.

Contrast and backlighting are on the window scrolling arrow keys. The contrast control and backlight control are not the same as the PC shift. This hand-held computer uses shift left, shift right and shift up for contrast and backlight control. On a PC these key strokes produce a 4, 6, and 8. Numeric values 0-9 are available on all the 6400 Hand-Held Computer versions, those keys are used for special controls without causing compatibility issues.

Using the Shifted Functions

If the function you want is printed on the keyboard overlay (in blue, yellow, or green) then you must **first** press that colored shift key immediately before the desired color function. That two-key combination always defines that key.

EXAMPLE: A 41-key DOS/PC keyboard has the letter S in blue over the [F9] key. Therefore, to produce a lowercase 's', press blue shift then the [F9] key.

To produce an uppercase S, press the green [SHFT] key, then blue shift, then the [F9] key.

'S' is always produced by pressing blue shift, then the [F9] key; if you want to modify this, you press a modifier first.

EXAMPLE: To produce **CTRL-S**, press the [CTRL] key, then blue shift, then the [F9] key for 'S'.

To produce **ALT-F9**, press the [ALT] key, then the [F9] key.

EXAMPLE: Pressing the green [SHFT] key and then the [DEL] key produces a dot instead of deleting the character at the cursor. The nearby keys on that row [CTRL], [ALT], and [ESC] still behave normally when the green [SHFT] is pressed first.

This is why annunciators are absolutely crucial, since you must only press one key at a time. The annunciators tell you which shift key you are pressing and holding down. Refer to page 1-16 for locations and meanings of display annunciators.

Pressing more than one shift key along with another key may not always produce the result you expected. This happens as a result:

- Of the sequence of keys pressed, and
- The mode your computer is in at the time the key is pressed.

There is no problem when you press the green [SHFT] and the yellow key. But if you press the [SHFT] and either the blue or yellow shift key, you usually experience different results than you expect.

Summary of Shift Key Combinations

- Green [SHFT] and either blue or yellow shift key and another keystroke, no confusion
- Green [SHFT] and blue and yellow shift key along with another key, confusion can occur

This is similar to your PC, if the NUM LOCK or CAPS LOCK is engaged then pressing shift and a key usually produces something other than what you want. Therefore, just like with a PC, to get the result you want you have to change a mode or the sequence you press the keys.

Display Annunciator Locations on Display Window

Annunciators are located at the extreme bottom of the display, in 20 separate positions. The following figure illustrates where each annunciator is positioned. Position 1 is located in the lower left hand corner and position 20 completes the row in the lower right hand corner.

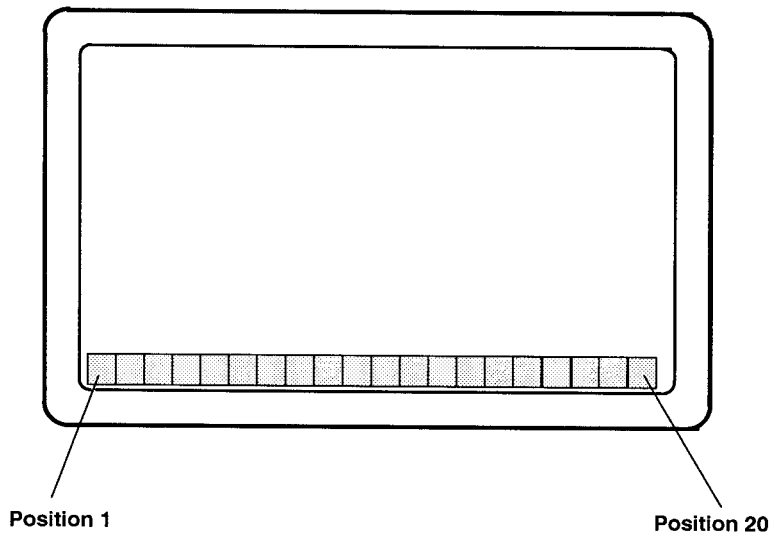











Figure 1-7
Annunciator Locations On Display

Annunciator Descriptions

Annunciators appear on the bottom line of the display.

Position	Key	Annunciator
1	Shift	
2	CTRL	
3	ALT	
4	Scroll Lock	
5	Num Lock	
6	CAPS Lock	
7	ALPHABETIC Lock (41-Key only)	
8	Blue Shift	
9	Yellow Shift	
10-13	Battery Capacity	

Display Annunciators (Messages)

The symbols contained in this section are larger than actual size. The meaning of the annunciators is described below:



Shift mode: After holding down the green Shift [**SHFT**] key, the next character will be uppercase or the alternative function.



Control mode: Generally you use the Control mode as it is designed in by your particular application.



Alt mode: Generally you use the Alt mode as required by your particular application.



Scroll lock mode: This mode locks the keyboard for scrolling only. By using the scroll arrows on the [WINDOW] keys you can continuously scroll through all data entered. Your application and keyboard definition show you which key is defined for scrolling. To unlock, press the key again.



NUM lock mode: Both the 41-key and 51-key DOS/PC keyboards have the option for locking the keyboard in numeric lock mode. Pressing the yellow shift then the number 8 key sets this function. To unlock, press the yellow shift then the number 8 key again.



CAPS lock mode: The keyboard is in CAPS lock mode when this annunciator is displayed on the bottom row of the screen. All keystrokes are entered as uppercase characters. To unlock CAPS press the [CAPS] key (51-key keyboard) again or the blue shift and space key using the 41-key keyboard.



Alphabetic lock mode: Only the 41-key keyboards have the option for locking the keyboard in alphabetic mode. Only those keys that have alphabetic characters in the blue shift mode are affected. The primary key function and the alphabetic are swapped in Alphabetic Lock. Pressing the blue shift and then the yellow shift toggles Alphabetic Lock on and off. The following example shows how by using the number 1 key you can produce characters 1 or A.

EXAMPLE:

Normal Operation: Pressing the [1] key produces the character '1'; pressing the blue shift key and then the [1] key produces an 'A'.

Using the Alphabetic Lock: Pressing the [1] key produces an 'A'; pressing the blue shift key and then the [1] key produces the character '1'.

- ← **Blue Shift Mode:** This annunciator shows you that the keyboard is in the blue shift mode. Pressing a key enters the character or performs the function shown in blue on the overlay to the upper left of the key.
- **Yellow Shift Mode:** This annunciator displays when the keyboard is in the yellow shift mode. Pressing a key enters the character or performs the function shown on the overlay in yellow to the upper right of the key.

■■■■ Battery Pack Gas Gauge Icons:

These battery icons represent the charge level in your main battery pack.

- " Four icons indicates more than 76 % charge level
- " Three icons indicates between 51-75%
- " Two icons indicates between 26-50%
- " One icon indicates between 21-25%

Once your computer gets below the 20% range, the icons are replaced by "Ls" and after the charge level is less than 10% your computer emits a series of beeps.

- " Four Ls indicates between 16-20% charge level
- " Three Ls indicates between 11-15%. At the 15% charge level, your computer beeps once. The sound duration and frequency are at levels you have set for your computer.
- " Two Ls indicates between 6-10%. At the 10% and 7% charge levels, your computer beeps once. The sound duration and frequency are at levels you have set for your computer.
- " One L indicates between 0-5%. At this charge level, your computer beeps three times at its current setting level for both duration and frequency.

" **NOTE:** *If you have the beeper turned **off**, you will not hear any of the low battery beep warnings.*

The battery pack icons on your computer display reflect the same status as the LEDs on the battery pack. However, there may be a one minute delay for updating the icons on the display when the battery pack is replaced.

Display Contrast

You can adjust the contrast of your display. Display contrast adjustment is a green [SHFT] function. To increase the contrast, press the green **[SHFT]** key and then the [◀] key (the window scroll-right arrow). To decrease the contrast, press the green **[SHFT]** key and then the [▶] key (the left window scroll arrow).

Backlight

Your hand-held computer display has a backlight feature. Backlighting the display helps when using your hand-held computer in poorly lit working areas. To toggle the backlight on and off press and hold the green **[SHFT]** key then the backlight [⊛] key (the window scroll-up arrow).

Window Scrolling Arrows

Use the window scrolling arrows while in the blue shift mode to adjust the area of the screen that is visible. Pressing the blue shift key and then one of the arrow keys moves the display one row or column at a time until the arrow key is released. This allows you to pan across the entire virtual CGA screen.

[I/O] Suspend or Resume

Pressing the [I/O] key does not turn the hand-held computer off completely, but instead puts it into a suspend mode. Suspend mode enables the hand-held computer to conserve power but also enables it to respond quickly to data entry. Your hand-held computer responds to the scan key, the trigger on the scanner handle, or the [I/O] key. To force your computer into suspend, press the [I/O] key. Opening the battery pack door latch also puts your computer into suspend.

The hand-held computer puts itself into suspend mode if no activity has occurred for a set period of time. The time that elapses before it suspends is determined by the parameters you set using your application software, AUTOEXEC.BAT or CONFIG.SYS files.

Handstrap

An elastic handstrap is included for your hand-held computer. Using the handstrap provides comfort to you and also helps prevent you from accidentally dropping your hand-held computer.

Whether you are left or right handed, the handstrap can be secured to the hand-held computer to accommodate your need. Figure 1-8 and Figure 1-9 show how to fasten the handstrap to the top and bottom of your hand-held computer.

Available as options and accessories are an adjustable handstrap and an adjustable wriststrap. These are shown in Figure 1-14 and Figure 1-15 on pages 1-33 and 1-34 and can be attached for either left or right handed use.

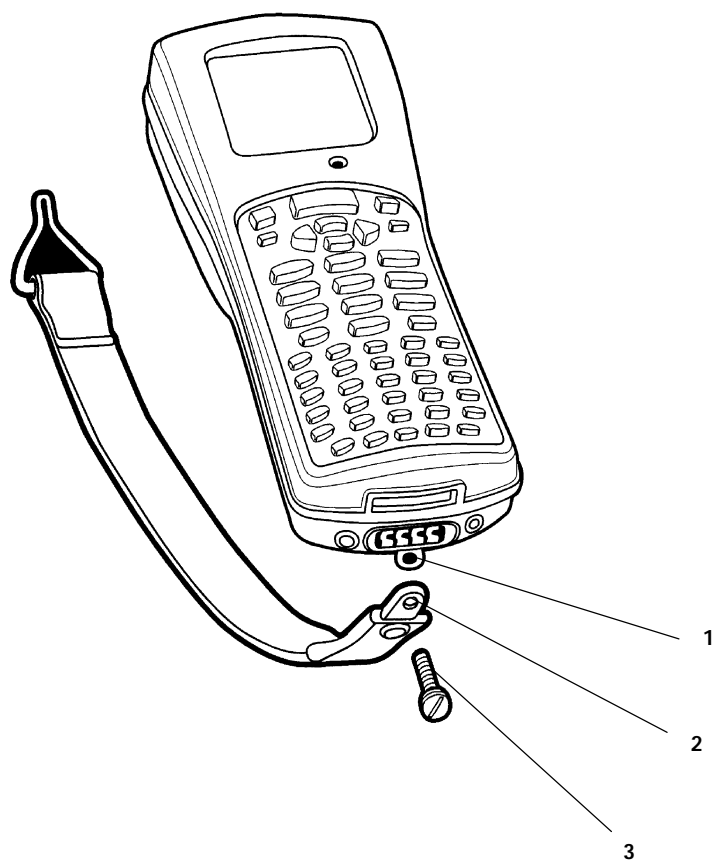

1. Handstrap attachment screw hole
2. Handstrap screw attaching hole
3. Handstrap attaching screw

Figure 1-8
Bottom End Handstrap Attachment

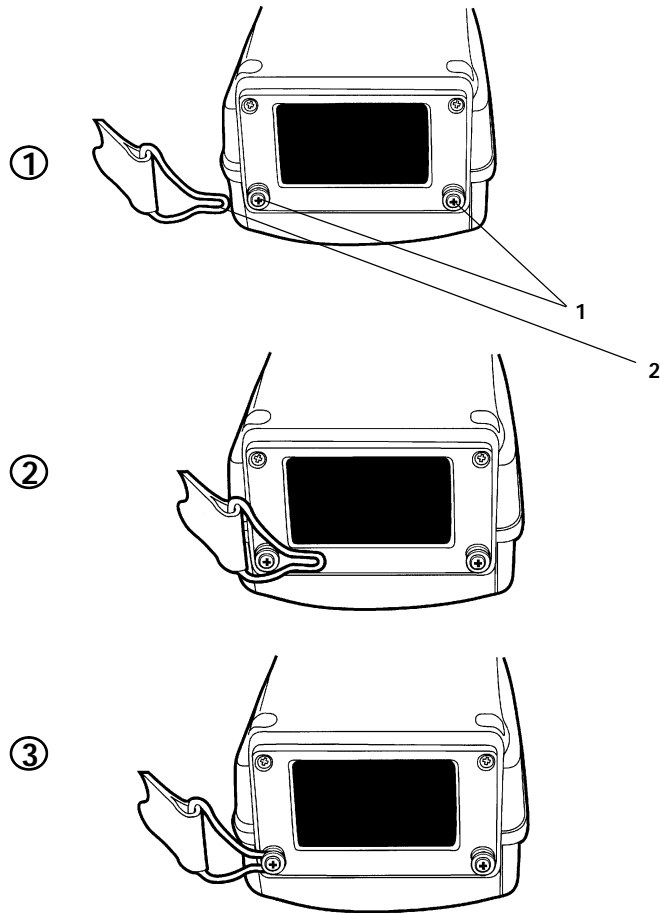

- 1. Handstrap attachment bushings
- 2. Handstrap clip fastener

Figure 1-9
Top End Handstrap Attachment

Buzzer

The buzzer sounds when you press a key (the "key click") or make a good scan, or when certain error conditions occur. Refer to Figure 1-1 on page 1-4 for the location of the buzzer.

CAUTION: Keep all foreign material out of the buzzer opening. The buzzer opening is not a pencil or pen holder. The buzzer is sealed but could be punctured by sharp objects which harm the buzzer and allow rain, dirt, or other materials to get inside your hand-held computer.

You can adjust the frequency and length of time of the buzzer tones through your parameter settings. The parameter settings are detailed in Section 3.

Infrared (IrDA) Port

The IrDA port provides for the transmitting of an infrared signal to:

- A printer equipped with an IrDA adapter
- A personal computer with IrDA serial adapter
- Any other IrDA compatible device

Battery Management

The normal charge time for the main battery pack is 1.5 hours for a 2 cell pack and 3 hours for a 4 cell pack.

You should charge the battery pack until the green LED on the charger comes on, indicating a fully charged pack.

A fully charged battery pack, left outside of a charger or your computer, self discharges in about 20 days. It is best to take batteries directly from the charging device and install them into your computer.

Your battery packs are rated for 500 full charge/discharge cycles after which they have 50% of their original capacity. The main and backup batteries will not charge below 32_F (0_C) and above 104_F(40_C). The battery life of the cells is reduced when running in cold temperatures.

EXAMPLE:

Your computer should be used only two shifts a day in a below 0_C environment to allow eight hours for the internal backup battery to recharge in room temperature.

It is always a good idea to check the capacity of your battery pack before inserting it into your computer, and charge accordingly. Refer to **Measuring Battery Pack Charge Level** on page 2-8 for instructions.

Battery

Main Battery Pack

The hand-held computer offers rechargeable lithium ion main battery packs in:

- Two cell
- Four cell
- Four cell in optional scanner handle

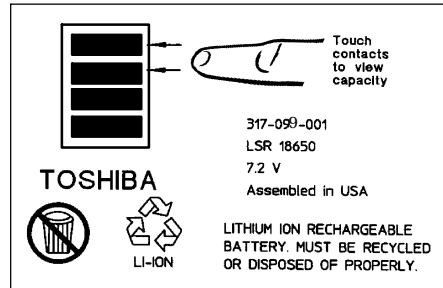

 **WARNING:** *The battery can explode if it is incorrectly replaced. Replace only with the same or equivalent kind.*

 **AVERTISSEMENT:** *La batterie au lithium peut exploser si elle est remplacée de manière incorrecte. Elle ne doit être remplacée que par une batterie identique ou similaire.*

 **WARNING:** *The lithium battery can explode if placed incorrectly in the charger.*

 **AVERTISSEMENT:** *Les batteries au lithium peuvent exploser ou prendre feu si elles sont trop chargées à cause d'une mauvaise installation de la station d'accueil.*

When your hand-held computer goes into suspend mode because of low main battery condition, the data is protected by the backup battery. Your hand-held computer will not accept data or process transactions until you deal with the low battery condition. The backup battery protects the data that you have entered for at least 100 hours.

Backup Battery

Your hand-held computer contains a rechargeable nickel-metal hydride backup battery. This backup battery recharges when needed from either an external charging source (like a printer or dock) or from the main battery pack. If the backup battery is completely run down it takes a minimum of 8 hours to completely recharge but it is better to recharge it for a full 12 hours.

The backup battery remains ready to protect your computers data whenever the main battery pack is removed or needs recharging. The backup battery should last about 500 cycles (discharge and recharge equals a cycle). This battery should last for about 5 years before it needs to be replaced. If your hand-held computer fails to hold data for at least 100 hours in the suspend mode, send your computers to the Norand Customer Support Center for replacement.

Memory

This hand-held computer design uses these types of memory:

- Main Memory DRAM
- Flash

Main Memory

Your main memory DRAM options available are 2, 4 or 8 Megabytes. The hand-held computer main memory was ordered at the time your unit was purchased. To add additional memory, send your hand-held computer into your Norand Customer Support Center.

The main memory is protected by the backup battery during low or dead main battery conditions or when the main battery pack is removed.

Flash

Flash memory is available in 2 or 4 Megabytes. Flash stores the BIOS and DOS. Software stored in flash is copied into DRAM for execution. Your application may also store information in flash memory. Flash memory retains data even if all power sources are depleted.

Diagnostic EEPROM

The hand-held computer collects and stores diagnostics. They can provide useful information to a Norand Customer Support Specialist, should your hand-held computer fail to operate. You will be instructed by the Norand personnel to complete the necessary steps while they are troubleshooting your computer with you.

Resetting

In the rare event that your hand-held computer fails to respond to your input, it may be necessary to "reset." A "hard" reset of your hand-held computer is done by holding down the Blue, Yellow and both ENT (Enter) keys all at the same time, until your computer starts beeping. This usually takes about 1-2 seconds. This method is equivalent to powering off and on with a PC. Resetting (also called re-booting) can take your hand-held computer up to 45 seconds.

Depending on the type of overlay your hand-held computer is programmed for, usually a "soft" reset is done by pressing Ctrl, Alt, and Delete.

Batch Terminal Operation

Your hand-held computer contains internal memory so it can collect and store data and then at the end of a day or shift, transmit (send) it to a centrally located host computer. Many applications do this upload and download of information daily, but sometimes this may happen several times a day, or only occur weekly.

Terminal Emulation

In Terminal Emulation you are using your hand-held computer to imitate the appearance and operation of another terminal (usually a particular IBM or DEC display monitor). The keyboard overlays for the emulated terminals supported by this hand-held computer are contained in Appendix B.

Accessories and Options

Internal Scanner

Your hand-held computer can be ordered with an internal integrated scanner. An integrated scanner provides the convenience of having a hand-held computer and scanner in one, for the freedom of one handed operation.

Internal Radio

Your hand-held computer can be factory equipped with either a 902 MHz or 2.4 GHz spread spectrum radio. This hand-held computer with a radio provides for both batch (store and forward data transfer later) and real-time (right now) interaction with your host computer or network for flexibility of operation.

Communication Adapter

CAUTION: The pins on the external connectors of the hand-held computer are fragile. Attach or disconnect cables with care to prevent damaging the connectors.

External Scanner Connector

The Communication Adapter contains a 9-pin connector for attaching a tethered scanner. Appendix A on page A-2 contains the pinouts for this connector.

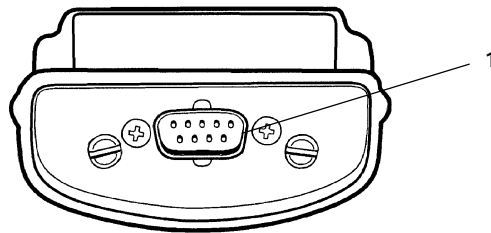

1. Scanner connector

Figure 1-10
Communication Adapter Scanner Connector

Charge Jack

The Communication Adapter contains a charge jack on the side for connecting and charging your hand-held computer using an optional AC wall charger or DC cigarette charger accessory.

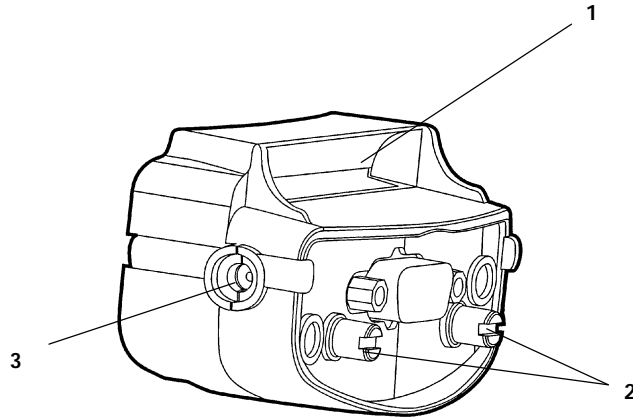

1. Infrared transceiver lens
2. Communication adapter attachment screws
3. External charge jack

Figure 1-11
Communication Adapter Charger Connector

Scanner Handle

If you do a lot of scanning, using the optional scanning handle gives you a means for point and shoot scanning. The scanning handle offers these advantages:

- " Lightweight
- " Easy to connect and use
- " Optional four cell battery pack
- " Can easily detach so the batteries can be charged separately from the hand-held computer

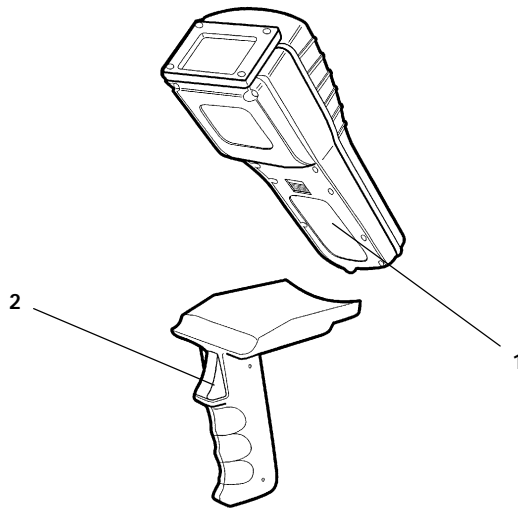

1. Two cell battery pack in hand-held computer
2. Scanning trigger

Figure 1-12
Scanner Handle

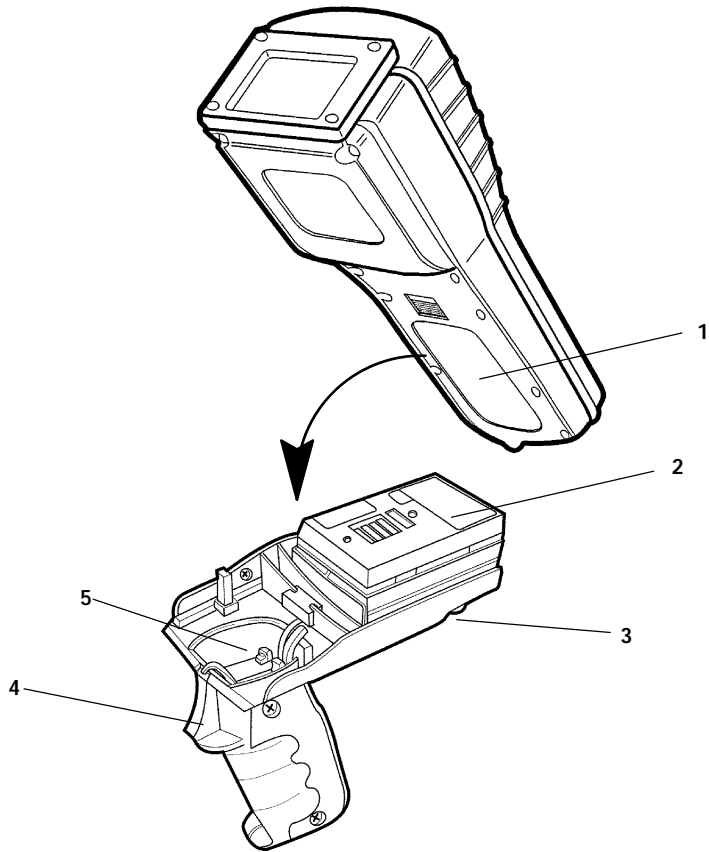

1. Battery compartment
2. Battery pack to fit in computer battery compartment
3. Button to release handle from computer
4. Scanning trigger
5. Battery pack in handle

Figure 1-13
Scanner Handle with Optional Battery Pack

Adjustable Wrist Strap and Adjustable Handstrap

You can order an optional adjustable wrist strap or handstrap. Figure 1-14 and Figure 1-15 show how to attach and adjust these optional straps.

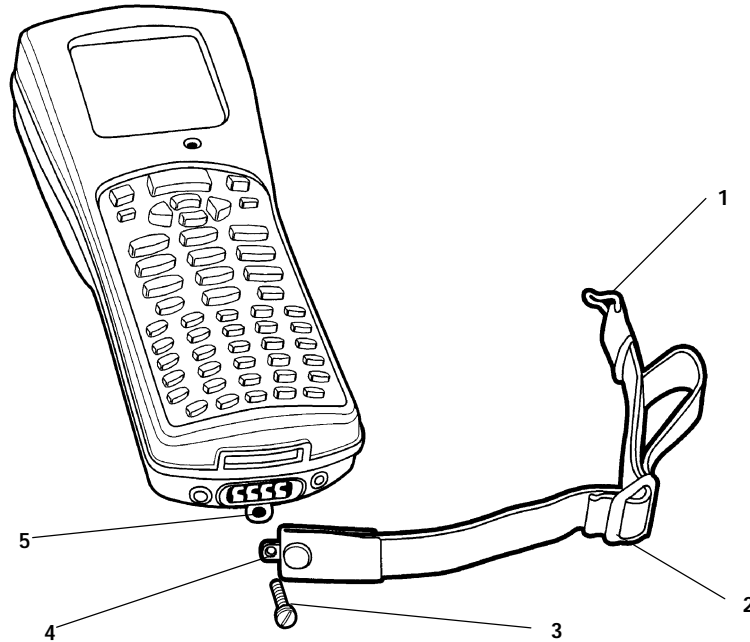

1. Top handstrap clip fastener
2. Handstrap adjustment buckle
3. Bottom handstrap attachment screw
4. Handstrap attachment screw hole
5. Computer handstrap attachment screw hole

Figure 1-14
Adjustable Handstrap

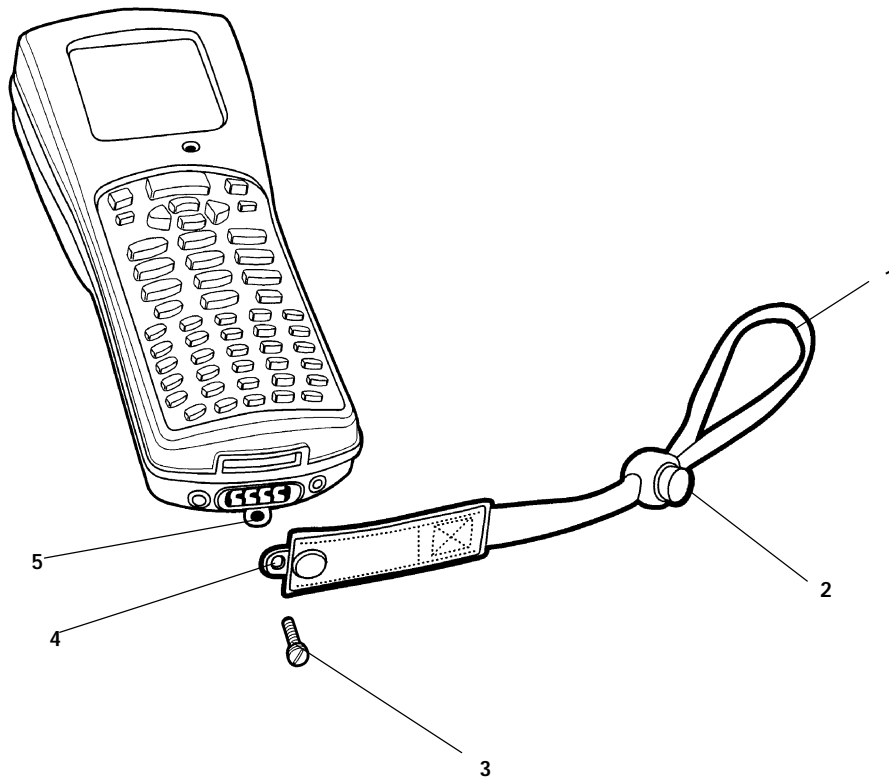

1. Wrist loop
2. Adjustment knob (push button in, slide knob down strap)
3. Wrist strap attachment screw
4. Wrist strap attachment screw hole
5. Computer wrist strap attachment screw hole

Figure 1-15
Adjustable Wrist Strap

Hand-Held Computer Specifications

Size:	8.8 inches (22.35 cm) long 3.3 inches (8.4 cm) wide at display; 2.9 inches (7.4 cm) at keyboard 2.2 inches (5.6 cm) tall
Temperature:	
Recommended Operating:	-4 to +122_F (-20 to +50_C)
Storage:	-22 to +158_F (-30 to +70_C)
Weight:	17-20 ounces (¶ 481-567 g) depending on options added
Humidity:	0 to 100% noncondensing
Static Protection:	20 kV
Power source:	
Main battery:	2 cell Lithium Ion battery pack (standard) 4 cell Lithium Ion battery pack (optional) 4 cell Lithium Ion pack in scanner handle (optional)
Backup battery:	150 mA nickel-metal hydride (NiMH) battery (standard)
Charging rate:	
0 to +40 _C: (32 to 104 °F)	Fast charge (fully charge ¶ 1.5 hours for a 2 cell pack and 3 hours for a 4 cell pack)
Communication:	
Physical devices:	Asynchronous RS-232 and RS-485, IrDA, Wireless Local Area Network
Protocol:	RS-232 protocols like xmodem, ymodem, zmodem, and Kermit; Norand Printer Communications Protocol (NPCP); IrDA through an IR adapter. For RF applications: TCP/IP, Novell, any Ethernet network protocol that can operate with the ODI specification

System Components:

FLASH: 1, 2, or 4 megabytes (MB)
DRAM: 2, 4 or 8 megabytes (MB)
Processor: AM386SC300, mixed 3.3 and 5 volt, 33 MHz.

Display:

Type: CGA compatible LCD
Size: 160 (wide) by 128 (long) pixels;

Radio Module:

2.4 GHz Spread Spectrum

Interface: Internal
Range: Up to 500 feet (152 meters)
Data Rates (throughput): 800 kbps or 1.6 Mbps, auto selecting
Modulation: Frequency Hopping Spread Spectrum (FHSS)
Frequency Band: 2400-2483 GHz
Output Power 100 mW

Radio Module:

902 mHz Spread Spectrum

Interface: Internal
Range: Up to 1200 feet (366 meters) line of sight
Data Rates (throughput): 90,225,450 kbps, programmable
Modulation: Direct Sequence Spread Spectrum (DSSS)
Frequency Band: 902-928 MHz
Output Power 250 mW

900 MHz Radio Option

NIC*	Device	Model Name
Type III	6710 Access Point	RM160
	PEN*KEY ^R 6400	RM160
	PEN*KEY 6600	RM160
	PEN*KEY 6100	RM160
Radio modules	RT1100	RM60, RM70, RM70LR (radio modules)
	RT1700	RM60, RM70, RM70LR (radio modules)

*Consult a Norand representative for availability.

NIC Specifications

Following are networking specifications for the 900 MHz NIC.

Frequency band:	902-928 MHz spread spectrum direct sequence
Range:	Up to 1300 feet line of sight
Coverage:	100,000-350,000 square feet in typical indoor installations
Data rate:	90, 225, or 450 Kbps (depends on installation)
Channelization:	7 @ 90 Kbps, 1 @ 225 or 450 Kbps
Client driver:	ODI
Software compatibility	Requires NORAND communications software resident in the access point
Output power:	250 mW
MAC protocol:	NORAND open wireless LAN MAC radio protocol
Regulatory compliance:	FCC 15.247; Industry Canada RSS 210 (Consult a Norand representative for availability.)

2.4 GHz Radio Option

Access Point NIC*	Device	Model Name
Type III	6710 Access Point	RM180

**Requires NORAND communications software resident in the access point.*

Wireless Station NIC*

Device	Model Name
Type III	PEN*KEY 6400 RM180
	PEN*KEY 6600 RM180
Type II	Laptops and notebooks . RM185
Mini-ISA	PEN*KEY 6100 RM280
	RT1100 RM80, RM90, RM90LR (radio modules)
	RT1700 RM80, RM90, RM90LR (radio modules)

ISA Desktops RM380

**Consult a Norand representative for availability.*

NIC Specifications

Following are networking specifications for the Proxim 2.4 GHz NIC.

Frequency band:	2.401–2.480 GHz SST frequency hopping
Range:	Up to 500 feet line of sight
Coverage:	25,000 ft ² (2,322 m ²) typical indoors
Data rate:	800 Kbps or 1.6 M bps, manual or autoselect
Client drivers:	ODI and NDIS (v. 2.0.1/DOS and Windows)
6710 & 6910 (access point/gateway)	Requires NORAND communications software in the access point or access point/gateway
Ethernet compatibility:	Ethernet packet types and addressing
Output power:	100 mW
MAC protocol:	RangeLAN2
Regulatory compliance:	FCC 15.247; Industry Canada RSS 210; European Union ETS 300-328 (Consult a Norand representative for availability.)

Radio and Scanner Modules

Module	Description
RM11	UHF radio
RM31	UHF radio with integrated, standard-range scanner or long-range scanner
RM60	900 MHz radio
RM70	900 MHz radio with integrated, standard-range scanner
RM70LR	900 MHz radio with integrated, long-range scanner (such as used on a forklift)
RM80	2.4 GHz radio
RM90	2.4 GHz radio with integrated, standard-range scanner
RM90LR	2.4 GHz radio with integrated, long-range scanner (such as used on a forklift)

Section 2

Operation

Introduction

This section tells you how to:

- Install and remove the main battery pack
- Charge the battery pack
- Download applications and parameters
- Program the Flash memory
- “Power-up” your hand-held computer
- Understand the key clicks
- Scan using integrated (internal) or tethered (external) scanners

Before Using Your Computer for the First Time

Your computer is shipped with uncharged batteries for safety reasons. Charge your computer for 12 hours before using it the first time. This ensures that both the main and back-up batteries are fully charged. For complete charging instructions refer to **Charging Your Battery Pack** beginning on page 2-9.

- " **NOTE:** *After the initial charging of 12 hours, the normal charge time for the main battery pack is 1.5 hours for a 2 cell pack and 3 hours for a optional scanner handle with 4 cell pack.*

If you use batteries and external battery pack chargers but do not use docks to charge the batteries, you need to fully charge your backup battery. To ensure the backup battery is fully charged:

1. Insert a fully charged main battery into your computer.
2. Perform the four finger reset (both Enter keys, blue shift, and yellow shift keys) simultaneously. See Figure 2-1 for location of keys.
3. Allow your computer to "boot" up and leave it suspended for 10 hours.

" **NOTE:**

Suspend means to press and hold the I/O key until the display goes blank.

4. Insert a new and fully charged battery pack to begin operations.

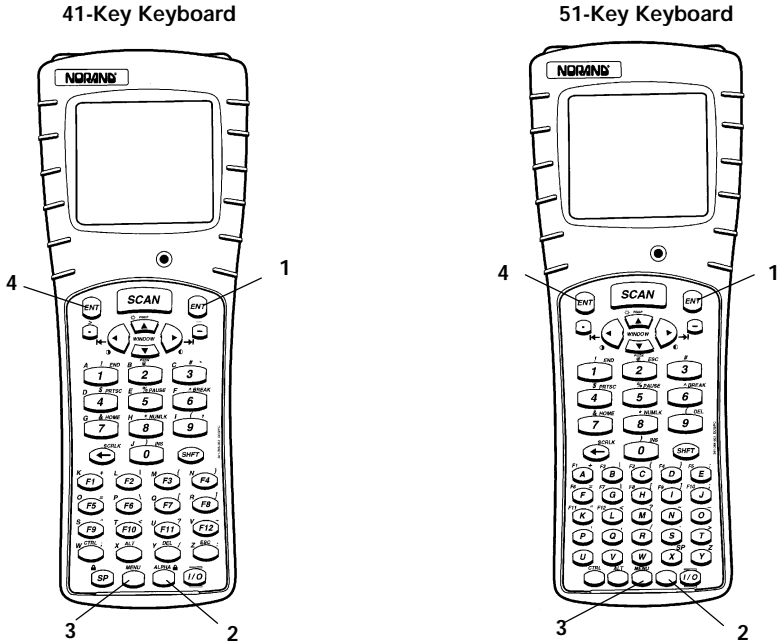



- 1. Enter key
- 2. Yellow shift key
- 3. Blue shift key
- 4. Enter key

Figure 2-1
Resetting Your Computer

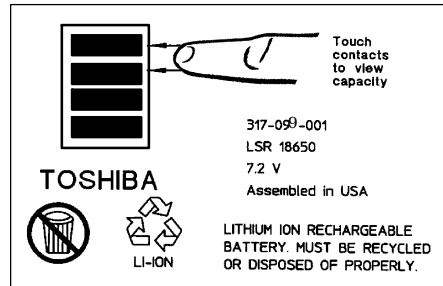
Rechargeable Battery Labelling



 **WARNING:** *The battery can explode if it is incorrectly replaced. Replace only with the same or equivalent battery type.*

 **AVERTISSEMENT:** *La batterie au lithium peut exploser si elle est remplacée de manière incorrecte. Elle ne doit être remplacée que par une batterie identique ou similaire.*

 **WARNING:** *The lithium battery can explode if placed incorrectly in the charger.*

 **AVERTISSEMENT:** *Les batteries au lithium peuvent exploser ou prendre feu si elles sont trop chargées à cause d'une mauvaise installation de la station d'accueil.*

Installing the Main Battery

1. Position the battery pack with the contacts facing into the battery compartment and the four protruding keys hooking under the bottom end lip of the compartment (see Figure 2-2).
2. Press in on the battery pack until it snaps into place.

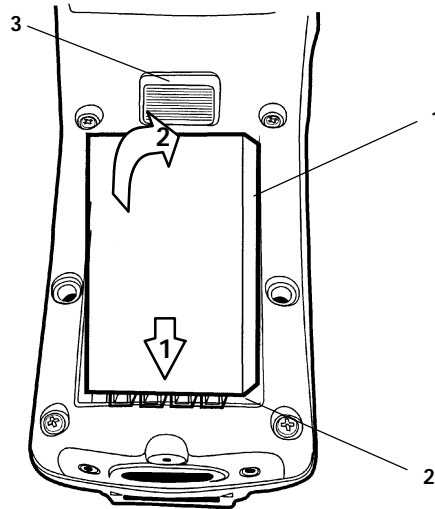

1. Rechargeable battery pack (contacts on underside)
2. Battery compartment
3. Release latch

Figure 2-2
Installing Main Battery Pack

Removing the Main Battery

Before you remove the main battery pack, ensure that your computer is in a "Suspend" mode, meaning that the display is blank. To suspend press the [I/O] key.

The steps on this page and 2-8 detail how to remove the main battery and check how much power remains. Refer to **Installing the Main Battery** on page 2-5 for replacing the battery.

1. With your thumb, firmly push the release latch forward. Battery pops up and out of the compartment.
2. Lift battery out.

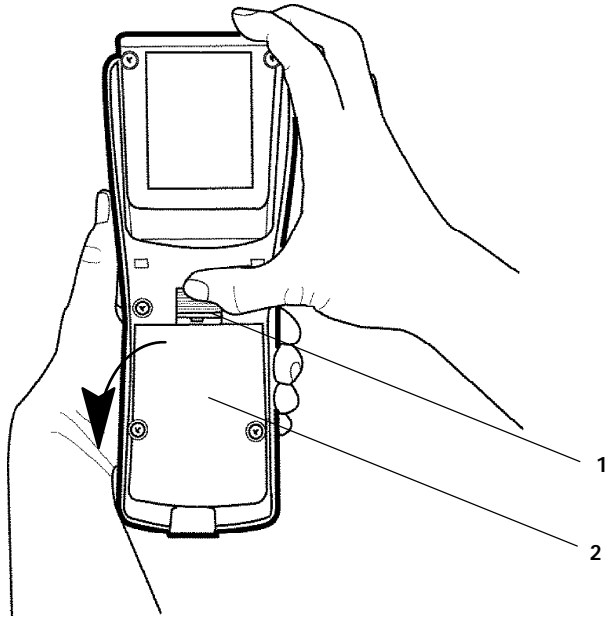

1. Release latch
2. Rechargeable battery pack (contacts on underside)

Figure 2-3
Removing Main Battery Pack

Measuring Battery Pack Charge Level

1. Touch your finger across the first two contacts.
2. Charge level is displayed from right to left. The higher the battery charge level the more LEDs light.

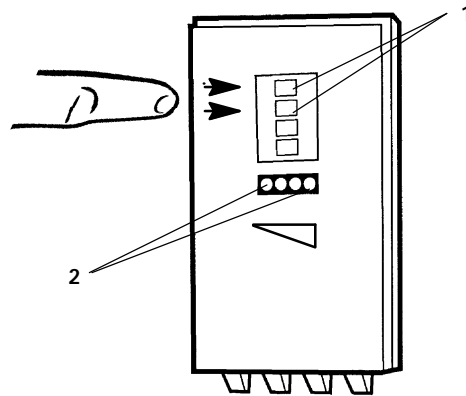

1. Contacts for measuring charge level
2. LEDs that show charge level; see below for meaning

● = LED on	
○ = LED off	
○ ○ ○ ●	one LED = 21-25% charge level;
○ ○ ● ●	two LEDs = 26-50% charge level;
○ ● ● ●	three LEDs = 51-75% charge level;
● ● ● ●	four LEDs = 76-100% charge level

Figure 2-4

Main Battery Pack Underside View Showing Contacts

3. Once your computer get below the 20% range, the icons are replaced on the display with Ls and after the level is less than 10% your computer emits a series of beeps. Refer to Section 1 page 1-18 for the explanation of these Ls and beeps.

Charging Your Battery Pack

Charging your battery pack can be done either in your hand-held computer or in a charger. The following devices provide charging while your computer is inserted into them:

In Your Hand-Held Computer

- " 6400 Series multidock
- " 6400 Series single dock
- " 6400 Series vehicle dock

The multidock, single dock, and vehicle dock installation and instructions are contained in a separate NORAND[®] publication *6400 Series Docks Installation Instructions* NPN: 962-020-004.

Using the optional Communication Adapter allows you access to charging your hand-held computer by using:

- " An ac wall charger
- " A cigarette lighter adapter

In An External Source

Figure 2-5 shows a multipack charger and Figure 2-6 shows a single pack charger.

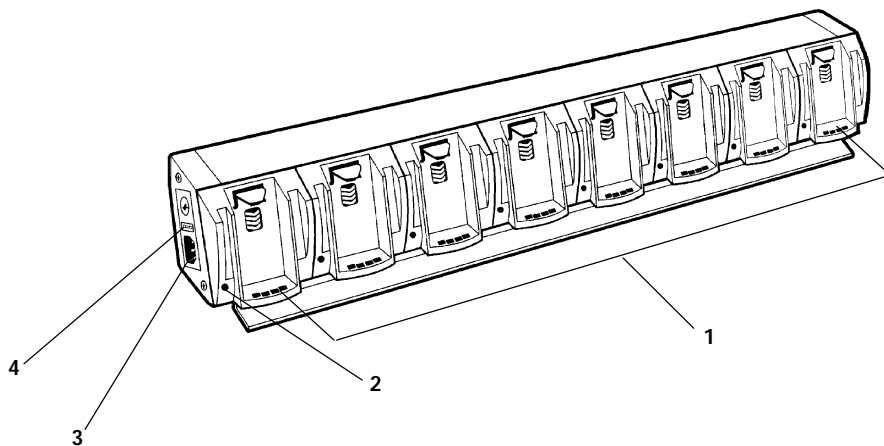

- 1. Battery pack compartments (eight)
- 2. Charge indicator LED
- 3. Power cord connector
- 4. Fuse holder

Figure 2-5
Multipack Charger

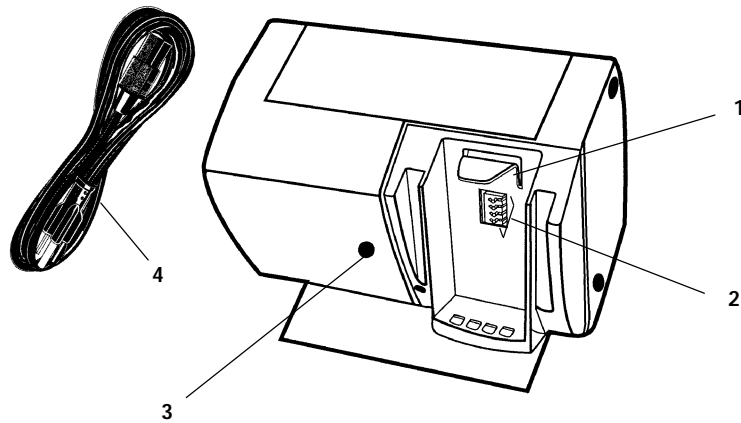

- 1. Battery pack compartment
- 2. Charger contacts
- 3. Charging indicator LED
- 4. Power cord

Figure 2-6
Single Pack Charger

Battery Charger LED and Error Codes

When your battery pack is placed in a multipack or single pack charger, the charger's LED indicates the battery pack charging status:

- Red indicates that the battery is charging.
- Green indicates the battery pack is fully charged.
- A combination of a blinking red and orange LED can indicate one of two basic conditions: Either a bad connection, in which case you need to remove and reinsert the battery pack into the charger, or there is a faulty battery that needs to be replaced. However, the indicator can also alert you of a more serious charging or product error. Table 2-1 and Table 2-2 on page 2-12 show you this more extensive list of error codes and the solution notes.

Charging Indicator Error Codes

Table 2-1
Charging Indicator Error Codes

First Blink	Second Blink	Third Blink	Pause	Description	Solution Notes
Orange	Orange	Orange	Off	High Voltage Fault	1 and 2
Red	Orange	Red	Off	No Communication	1
Orange	Red	Red	Off	Checksum Error	1
Red	Red	Red	Off	Upper Cell Mismatch	1 and 3
Red	Red	Orange	Off	Lower Cell Mismatch	1 and 3
Red	Orange	Orange	Off	5 Bad Packets Received	1
Orange	Red	Orange	Off	Wrong Battery Type	1

Table 2-2
Solution Notes

Note	Solution
1	To isolate the issue to the battery pack itself, put the "suspected" battery pack into a computer and operate for a few minutes. Then, try the battery pack in different charger cups to see if this error still occurs. If it does occur, send the battery pack to your service center for replacement.
2	This situation could be caused by a bad charger cup or a computer. Insert different batteries into this same charger cup. If the cup produces this same error with the other batteries, this indicates that the cup on the charger is bad. To get the battery back into a good state, put the battery pack back in the computer and operate for a few minutes. Then place the battery pack into a different charger cup and recharge. Send the charger to your service center.
3	Leave the battery pack in the charger for a minimum of 16 hours. If the error condition still exists, send the battery pack to your service center.

Backup Battery

A fully charged backup battery provides protection for maintaining data approximately 100 hours with the main battery removed or completely run down. The backup battery is charged from the main battery pack and every time your hand-held computer is placed in a dock or charging source.

" NOTE: *Your computer should be placed on a charging source for 12 hours before using the first time to fully charge the backup battery.*

The backup battery is not user-replaceable. To have your backup battery replaced, send it in to the Norand Customer Service Center nearest to you. Whenever you send in your hand-held computer for service, include a description of what you would like to have done to it.

Downloading Programs To Your Hand-Held Computer

Downloading parameters, program data, or inventory is done by placing your hand-held computer into a dock, through the IrDA port, or through the connector on the optional Communication Adapter endcap. The docking devices not only transmit data between your hand-held computer and the host, but also provide charging for your hand-held computer.

Programming the Flash

The flash drive (c:\) is readable and writeable; therefore, you can modify, create and delete files, etc. as your needs demand. The *PEN*KEY[®] Model 6400 Programmer's Reference Guide* NPN: 977-054-004 contains the complete details for programming flash. The upper 256 KB of flash is reserved for the BIOS and DOS files. If this area ever needs updating you will be furnished with complete instructions along with the updated files.

Turning Your Hand-Held Computer On and Off (Suspending)

Turning On Your Hand-Held Computer

Turn your hand-held computer on by pressing and releasing the [I/O] key. When your hand-held computer is cold booted (turning on the first time or after resetting), it displays several messages in rapid succession. The first message shows the firmware version and its release date (DD/MMM/YY). If you are just resuming, the display is restored to its previous state.

The screens that follow depend on your application. The documentation that addresses using this hand-held computer as a batch (store now and send later) unit instruct you about all remaining operations.

Suspending Your Hand-Held Computer

To suspend operation, press and release the [I/O] key *once*. Suspending operation works only if your computer is not plugged into a charging source. The memory contents are protected when the power is suspended.

Automatic Suspend

Your hand-held computer automatically puts itself into the suspend mode after a period of inactivity. However, waiting to suspend uses battery energy. Therefore it is best to manually suspend your hand-held computer by pressing the [I/O] key when not entering data. The memory contents are protected when the power is suspended.

Terminal Emulation programs do not automatically suspend. When lying idle but not manually suspended, the integrated radio module is still active and will drain battery much as if it is actively being used. Therefore, it is necessary to manually suspend your computer by pressing the [I/O] key.

Understanding the Key Clicks

You communicate your intended action to your hand-held computer through pressing a key on the keyboard. Your hand-held computer communicates back to you through an audible response, a "key click."

Each time you press a key, your hand-held computer lets you know with a single audible key click. Pressing certain keys causes two consecutive key clicks that occur one after another so quickly that they almost sound like a single beep. These two consecutive key clicks occur because your hand-held computer automatically "presses" the shift key for you in these cases.

EXAMPLE: An example of consecutive key clicks is the same as what happens when you use the "shift" key on a PC. These keys include a colon(:), double quote("), and percent sign(%).

If you enter an incorrect action or keystroke, you hear a "beep." An error "beep" is longer than a key click. An error "beep" is intended to get your attention and let you know an error occurred.

Scanning

You can order an integrated scanner as part of your hand-held computer, or you can attach a tethered 5-volt serial, decoded out bar code scanner to your hand-held computer. Scanners allow the terminal to read and interpret bar codes.

Using an Integrated Scanner

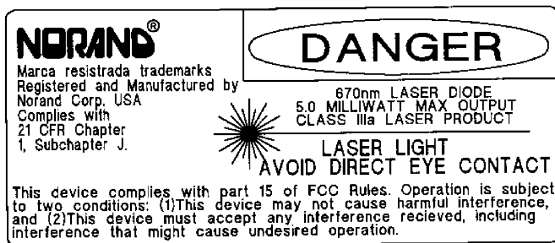

Class IIIa Laser label located on bottom side of computer

AVOID EXPOSURE Laser light is emitted from this aperture
ÉVITEZ TOUTE
EXPOSITION Émission de rayonnement laser par cette ouverture.

Label located on laser scanner lens

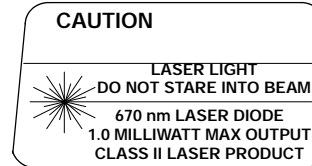

Class II Label



WARNING: *Do not point the scanner at someone's eyes or look directly into it when scanning.*



AVERTISSEMENT: *Ne regardez pas la fenêtre du scanner lorsque vous effectuez une scannérisation. Ne pointez jamais le rayon laser vers les yeux de quelqu'un.*

If your hand-held computer has been ordered with an internal integrated scanner, you can scan and key data on your hand-held computer. More complete details for setting up the parameters and operating the integrated scanner are contained in the *PEN*KEY[®] Model 6400 Programmer's Reference Guide* NPN: 977-054-004.

To use the integrated scanner, simply point the top of your unit at the bar code, press the **[SCAN]** key and listen for the beep acknowledging a good scan. A short high-tone beep indicates a good scan. If you hear no beep, scan the bar code again. If you are still not getting a "good scan" beep, follow these instructions.

1. Ensure you are positioning the scan lens properly across the bar code.
2. The scan beam must cross every bar and space on the symbol.
3. Hold the scanner farther away for larger symbols.
4. Hold the scanner closer for symbols with bars that are close together.

" **NOTE:**

Tip: After reading a bar code, aim the lens away from the bar codes and press the SCAN key within 1/2 second, to get the laser beam back on. With the laser beam on, you have five seconds to find and scan the next bar code.

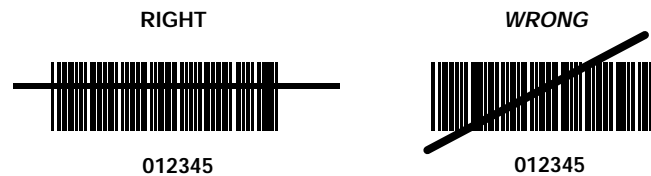

Installing the Optional Scanning Handle

To attach the handle:

1. Slip the handle onto the base of your hand-held computer.
2. Secure the two quarter-turn screws.

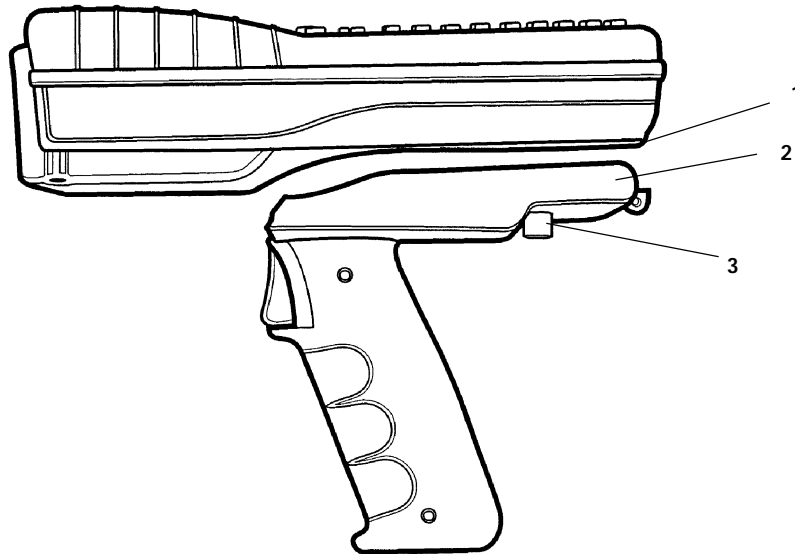

1. Bottom of hand-held computer
2. Scanner handle
3. Quarter-turn screw fasteners

Figure 2-7
Optional Scanner Handle

Installing the Optional Scanning Handle with Battery Pack

To attach the handle:

1. Slip the handle onto the base of your hand-held computer.
2. Snap into place.
3. To remove the handle, push in on the release button and lift off.

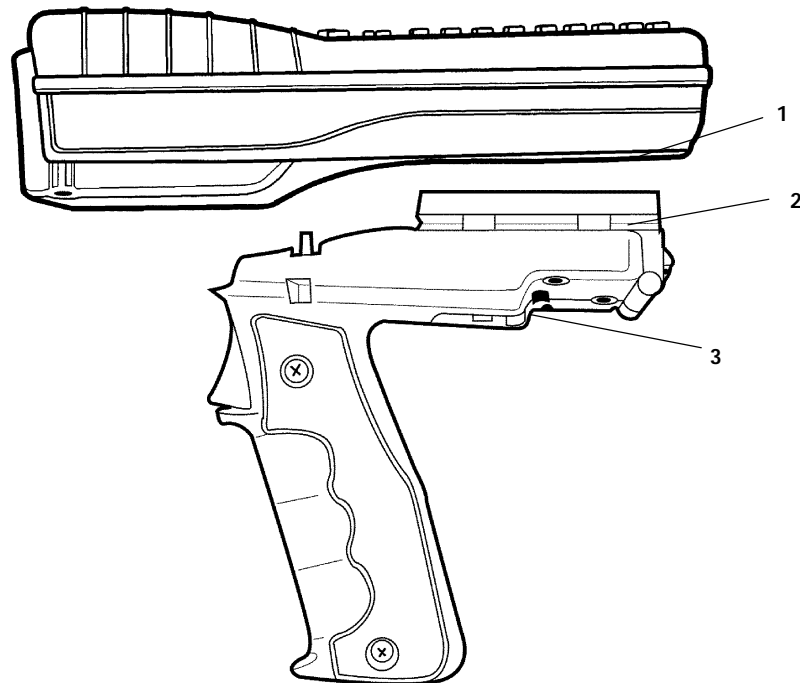

1. Bottom of hand-held computer
2. Scanner handle with battery pack
3. Button to release handle from computer

Figure 2-8
Optional Scanner Handle with Battery Pack

Charging the Scanner Handle Batteries

To charge the batteries in the scanner handle:

1. Unscrew the two quarter-turn screws securing the handle to the hand-held computer. Remove the hand-held computer.
2. Slide the handle into the charger by inserting the keys of the handle into the notches in the charger. The single unit charger's LED illuminates green when the battery pack is fully charged.

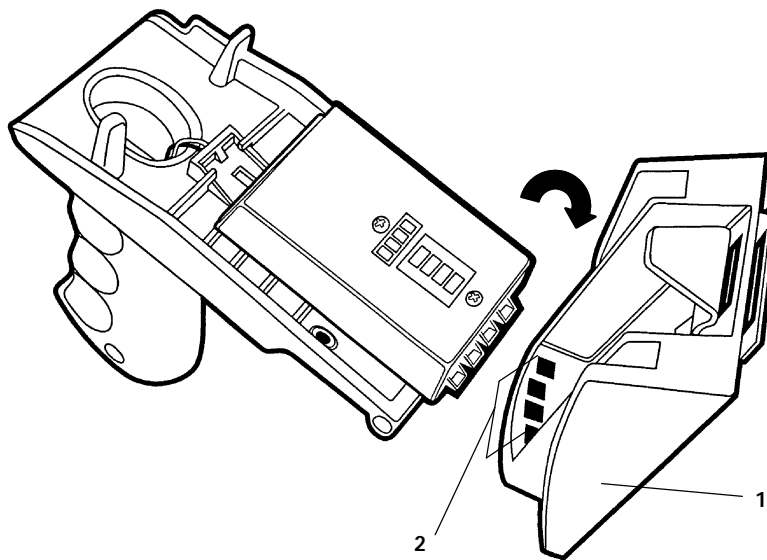

1. Charger
2. Notch outs in battery pack charger cup

Figure 2-9
Inserting Scanner Handle Into Charger

Using a Tethered Bar Code Scanner

The tethered bar code scanner attaches to your computer at the 9-pin D-sub connector located on the bottom of the optional Communication Adapter. The computer provides the power to run the scanner.

Your hand-held computer supports the serial, decoded tethered scanners in the Norand product line, these include:

Tethered Scanner Supported

Symbol Scanners

- LS-3203ER-I200A, Extended Range part number 858-042-800
- LS-3603-I200A Fuzzy Logic part number 858-079-901

Cable:

- Straight screw on connector serial cable 321-518-001

PSC Scanners

- PSC5300 IP Series Standard Range part number 858-065-012
- PSC5300 IP Series VIN part number 858-065-022
- PSC5300 IP Series Long Range part number 858-065-052
- PSC5300 IP Series Extra Long Range part number 858-065-072
- PSC5300 IP Series Ultra Long Range part number 858-065-092
- PSC5300 IP Series Long Range High Power part number 858-065-152
- PSC5300 IP Series Extra Long Range High Power part number 858-065-172

Cable:

- Straight screw on connector serial cable 321-476-082

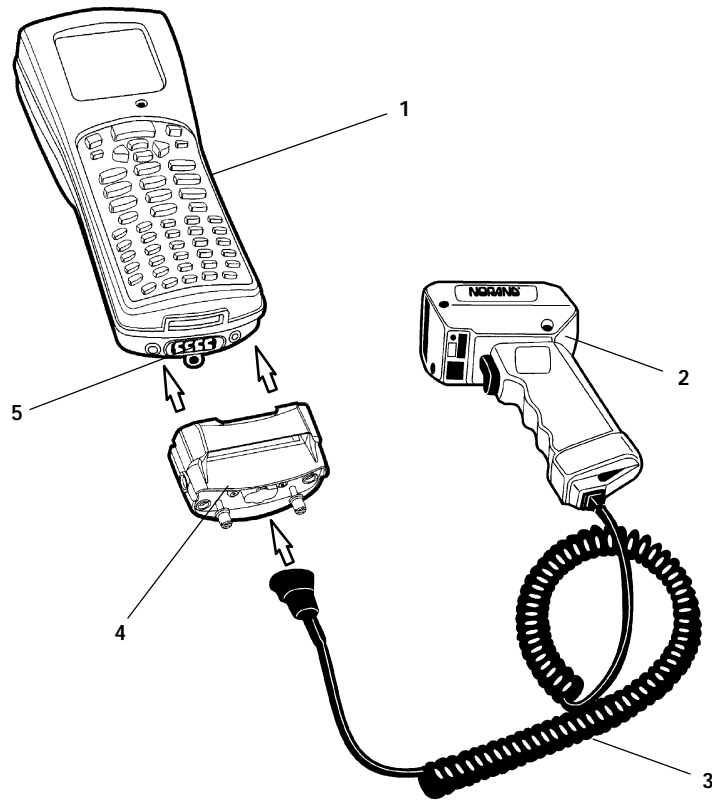

- 1. 6400 Hand-held computer
- 2. Scanner
- 3. RS-232 scanner cable
- 4. Communication adapter
- 5. Communication adapter connector

Figure 2-10
Connecting a Tethered Scanner

Software

The software that supports tethered scanning is V1.15+ BIOS and V5.10+ terminal emulations.

Tethered scanning is supported for any external device that sends its serial data at 9600 baud, 8 data bits, no parity, 1 stop bit with an ASCII STX (hex 02) before the data and an ASCII ETX (hex 03) after the data. No protocols, such as ACK/NAK, RTS/CTS, or XON/XOFF, are supported. All 8-bit characters between the STX and ETX will be stuffed in the PC BIOS key buffer.

Setting Terminal Emulation to Accept Tethered Laser Scanners

1. In AUTOEXEC.BAT, ensure the scanner driver is loaded with 64SCN7B -T1 -I0
2. From the Terminal Emulation mode, press the yellow and then the blue keys to enter the Terminal Emulation Main Menu.
3. Select option 1) Set-up Parm.s.
4. Enter password CR52401.
5. Select option 2) Barcode Parm.s.
6. At Scanner Type menu select 3) Laser and press ENT five times.
7. At Main Menu select 4) Tests
8. At Tests menu select 1) Peripherals
9. At Peripherals menu select 5) Scanner Test

If you experience problems with using your laser scanner with terminal emulation try these steps:

1. Reboot to the DOS prompt <YELLOW-BLUE-ENT-ENT> press 0 at pause.
2. Type DEL CONFIG.DAT press ENT.

3. Press CTRL ALT DEL to reboot.

Setting Your DOS Application to Accept Tethered Laser Scanners

In AUTOEXEC.BAT, ensure the scanner driver is loaded in the PS/DOS section with 64SCN7B -E -W -T1 I0 (this is for wedge scanning).

Setting Up Your LS3203 or LS3603 RS-232 Serial Scanner Parameters

Tethered laser power is always on, so a tethered laser can scan, decode, and send the data as soon as it is connected, even when it is not properly configured. Therefore, proper operation of the tethered laser is no indication that the laser is correctly configured for the scanner driver 64SCN7B.

Scan the following bar codes to set up your LS3203ER-I200A or LS3603-I200A scanner so it will work with your hand-held computer. You need to scan all the bar codes (except for the Host Transmit Code ID Character and Host Decode Options) to enable your laser scanner to work with the 64SCN7B scanner driver on your hand-held computer.

Set All Defaults

Scan the Set All Defaults bar code to set up your scanner for RS-232 serial communication.



Data Transmission Format

1. Scan the <PREFIX><DATA><SUFFIX> bar code.

<PREFIX><DATA><SUFFIX>



2. Scan the PREFIX bar code.
3. Scan the PREFIX values 1,0,0,2 bar codes from page 2-27. If you make a change or wish to change your selection, scan CANCEL.

PREFIX













4. Scan the SUFFIX bar code.
5. Scan the SUFFIX values 1,0,0,3 bar codes from page 2-27. If you make a change or wish to change your selection, scan CANCEL.

SUFFIX



RS-232 Host Prefix/Suffix Values

0		6	
1		7	
2		8	
3		9	
4		CANCEL	
5			

RS-232 Host Parity

NONE



RS-232 Host Stop Bit Select

1 STOP BIT



RS-232 Host ASCII Format

8-BIT



RS-232 Host Transmit Code ID Character (Optional)

Select to enable or disable this setting. The default is Transmit Code ID Character. The Transmit Code ID Character must be enabled if you are using FWP640H0 or FWP640H4 terminal emulation software in your hand-held computer.

TRANSMIT CODE ID CHARACTER



DO NOT TRANSMIT
CODE ID CHARACTER



RS-232 Host Decode Options (Optional)

Scan one of these bar codes to enable or disable the laser beep after a good scan. If your hand-held computer application beeps when it gets scanner data then you would probably want to disable the laser beep.

DO NOT BEEP AFTER
GOOD DECODE



BEEP AFTER
GOOD DECODE



Problems with Your Scanner

If you are having problems with your scanner:

1. Refer to the user guide for your scanner.
2. Refer to the *PEN*KEY[®] Model 6400 Programmer's Reference Guide* NPN: 977-054-004
3. Call your Norand 24-hour Customer Response Center at 1-800-221-9236.

Section 3

Terminal Emulation Menu Screens

Introduction

The Terminal Emulation Menu Screens are provided to support terminals running NORAND^R Terminal Emulation software. This section describes the menus used to set operating and scanning parameters for the hand-held computer. Additional information can be found in the programmer's guide or technical overview for your particular emulation program.

Keyboard Functions

Some keys on the hand-held computer have special functions, which can vary depending upon the application software. General function keys (keys that perform the same task, regardless of the application) are described in the following paragraphs.

Yellow and Blue Shift Keys

Use the yellow and blue shift keys to put the keyboard in the desired (yellow or blue) shift mode. These shifted key functions are shown on the keyboard overlays in Appendix C.

ENTER [ENT] Keys

Press either **[ENT]** key to select the option that is highlighted in the menu shown on the display. After selecting an option **[ENT]** either restores the display to the previous menu or advances to the next menu.

Number Keys [0] Through [9]

Many menus have numbered options. To choose a particular option, press the numeric key that corresponds to that option.

Once you make a selection and you remain at that menu screen, the option is highlighted, but you can select additional options. To deselect an enabled option, press the number corresponding to that option.

In some cases, pressing a number brings up a different menu (submenu). This allows you to further modify the choice made in the parent menu. Press the **[ENT]** key to confirm the settings and exit this menu.

After the modification(s), you may (depending on the menu and function) be permitted to return to the parent menu to make additional selections. There are also situations where pressing **[6]** causes your hand-held computer to exit from a submenu or reboot.

Various menus require entering a number, but do not necessarily have simple choices such as 1, 2, 3, 4, etc. Instead, you may have to enter a number from a range (example: 0-32). You may have to press **[ENT]** after these.

These instances are detailed in the text that applies to those menus, or in the menu displays.

Y Up and B Down Arrows

These keys are defined by the host computer. Use these keys to:

- Adjust the length and frequency of the key click and error buzzers.
- Set the display size (the number of rows displayed and characters per row) of the display.

Display Annunciators

Annunciators show the current status or operation in progress. The following lists some of the annunciators common to all emulations. These annunciators occupy positions 0 through 8 of the display. A bibliography follows that tells where more information can be found.

Display Position 0



Radio computer. The radio is transmitting data to the base station.

Display Position 1

If the radio icon is displayed in position 0 then position 1 shows the status of the radio transmission (either receiving, sending, communication loss, or message waiting). If there is no radio icon shown in position 0 then this position is blank and position 1 shows the active session number 1 or 2.

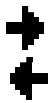

Sending. Radio is sending data to the base station.

Receiving. Radio is receiving data from the base station. This annunciator appears only when the information is for this particular computer's address.



Communications loss. No communication with the host computer has occurred for at least 60 seconds. The radio computer may be out of radio range, the base station may not have power, or communications from the host computer to the base station may not be properly set up.



Message. You have received a message and it has not been read.

Display Position 2

- x **Input Inhibited.** The keyboard has accepted enough information for the current input field. If the “key ahead” feature is on, the terminal stores the keystrokes made after “input inhibited” appears. The host may also inhibit (lock-out) the keyboard upon certain errors or when sending additional information to your computer.
- ^ **Insert Mode.** Characters are inserted, not overwritten.

Display Position 3

- Y **Alphabet Character (green) Shift Mode.** The keyboard is in the alphabet character shift mode—any alphabet character keystrokes are entered as uppercase characters.
- A **(blue) Shift Mode.** The keyboard is in a colored shift mode—keystrokes enter the symbol or perform the function shown on the **overlay** just to the upper *left* of the key.
- " **(yellow) Shift Mode.** The keyboard is in a colored shift mode—keystrokes enter the symbol or perform the function shown on the **overlay** just to the upper *right* of the key.

Display Position 4

- A **Alpha Lock.** This Alpha Lock symbol is used only for the 41-key keyboard model.

Display Positions 5-8



Battery Pack Gas Gauge Icons:

These battery icons represent the charge level in your main battery pack.

- " Four icons (positions 5-8) indicates more than 76 % charge level
- " Three icons (positions 5, 6,, and 7) indicates between 51-75%
- " Two icons (positions 5, and 6) indicates between 26-50%
- " One icon (position 5) indicates between 21-25%

Once your computer gets below the 20% range, the icons are replaced by "Ls" and after the charge level is less than 10% your computer emits a series of beeps.

- " Four Ls indicates between 16-20% charge level
- " Three Ls indicates between 11-15%.
- " Three Ls indicates between 11-15%. At the 15% charge level, your computer beeps once. The sound duration and frequency are at levels you have set for your computer.
- " Two Ls indicates between 6-10%. At the 10% and 7% charge levels, your computer beeps once. The sound duration and frequency are at levels you have set for your computer.
- " One L indicates between 0-5%. At this charge level, your computer beeps three times at its current setting level for both duration and frequency.

" NOTE:

*If you have the beeper turned **off**, you will not hear any of the low battery beep warnings.*

The battery pack icons on your computer display reflect the same status as the LEDs on the battery pack. However, there may be a one minute delay for updating the icons on the display when the battery pack is replaced.

Again, these are just a few of the display annunciators that are common to all emulations. There are others, specific to individual emulations, that are not shown here.

Annunciator bibliography (emulation/reference source/Norand Part Number):

- *VT220/ANSI Terminal Emulation Programmer's Reference Guide.* (NPN 977-047-037)
- *5250 SNA and Asynchronous Terminal Emulation Programmer's Reference Guide.* (NPN 977-047-039)
- *3270 Terminal Emulation Programmer's Reference Guide.* (NPN 977-047-040)
- *Native Async Terminal Emulation Programmer's Reference Guide.* (NPN 977-047-038)

Setting the Operating Parameters

Make sure there is a fully-charged battery pack in the hand-held computer before setting the parameters.

Opening the Main Menu

The Main Menu is the first screen displayed when you open the hand-held computer menus. All other menus are accessed from the Main Menu.

To open the Main Menu, press the yellow shift, then the blue shift (MENU) key. Briefly, these keys generally operate as:

- Blue shift is for functions labeled by blue legends above the keys.
- Green shift is for functions labeled by green legends above the keys.
- Yellow shift is for functions labeled by yellow legends above the keys.

- " Blue then Green shift is CAPS LOCK.
- " Blue then Yellow shift is Alphabetic Lock (41-key units only).
- " Yellow then Blue shift is Terminal Emulation menus; your particular emulation software probably treat the keys for contrast control, backlighting and other functions differently.

After the Main Menu appears, enter a number (1 through 7) to make a selection. The Main Menu is shown below:

<u>Main Menu</u>
1) Set-up ParmS
2) LCD ParmS
3) Beeper Setup
4) Tests
5) Version Info
6) Exit Menus
7) More

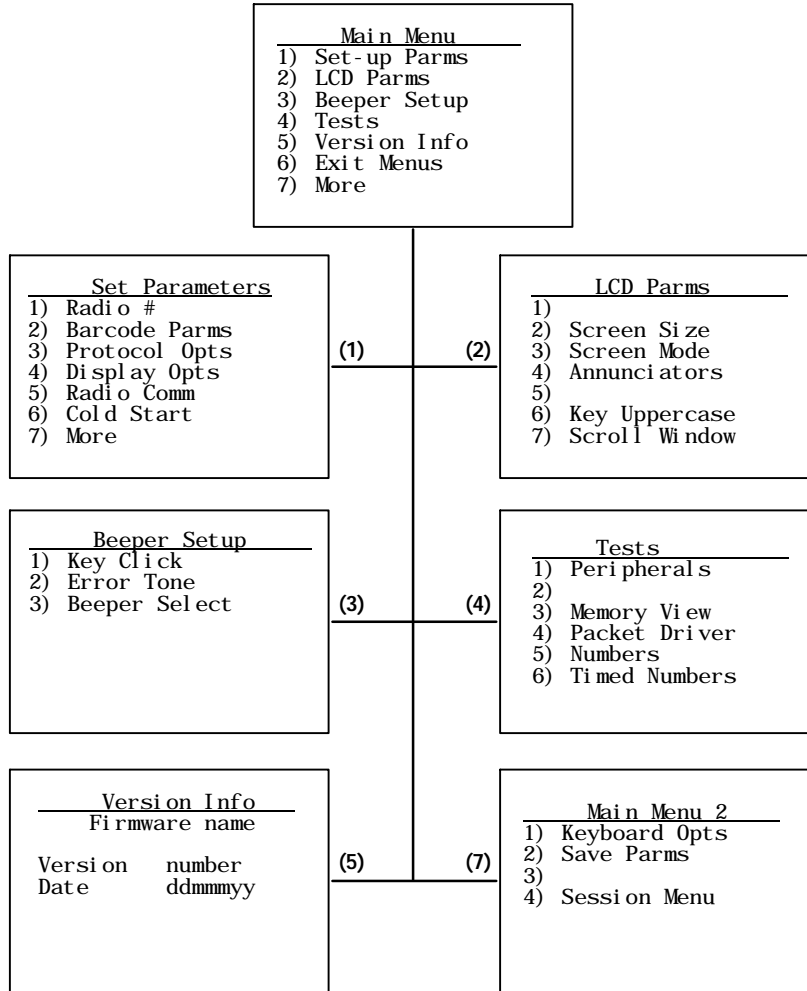

To return to the Main Menu from the hand-held computer menus program, simply press the **[ENT]** key several times. You can then select **6) Exit Menus**, to return to the operating system.

The following paragraphs describe options available from the Main Menu.

***Set-Up Parm*s**

The Set-up Parm (parameters) menu is password protected to guard against unwanted changes or loss of data.

In this menu you can change the following:

- Radio identification number
- Bar code parameters
- Host and emulation mode options
- Display options
- Radio Comm (not user accessible at this time)
- Enable system security with a global password

Or, you can reboot your hand-held computer.

***LCD Parm*s**

LCD Parm (parameters) menu adjusts the following display (**L**iquid **C**rystal **D**isplay) parameters:

- Screen size (number of lines displayed and characters per line)
- Cursor position (Screen Mode)
- Annunciators
- Uppercase display
- Scrolling window parameters

Beeper Setup

Beeper Setup lets you adjust the frequency and the length (duration) of the buzzer. Different buzzer tones can be programmed, and you can select the buzzer output for the:

- Key click (indicating that a valid key has been pressed or a good scan occurred)
- Error tone (indicating some error condition occurred; for example, an unacceptable keystroke.)

Tests

The Tests menu allows you to perform the following tests:

- Peripherals
- Memory View
- Packet Driver
- Numbers
- Timed Numbers

Version Info

You can use the UP and DOWN arrow keys in the Version Info menu to display:

- The type of program in FLASH ROM
- The release date of the program in FLASH ROM

Exit Menus

The Exit Menus option exits from the hand-held computer menus and returns to the "initial" screen.

More

The More option opens a menu called Main Menu 2, which lets you (1) set a keyboard "type-ahead" option, (2) save parameter settings as the new hand-held computer default parameters, and (3) designate session switching parameters.

Opening the Set-Up Params Menu

The Set-Up Params (parameters) menu is password protected to prevent unauthorized persons from changing hand-held computer parameters.

The parameters you set only apply to the current session. If more than one session is available to you, use the Session Menu (#4 in Main Menu 2) to verify or change the current session *before* changing parameter settings.

To open the Set-Up Params menu:

1. Press the **[1]** key.
2. Press the **[ENT]** key.
3. At the prompt, enter the password **CR52401**.

The Set-Up Params menu, and the menus you can access from it, are shown on the following page.

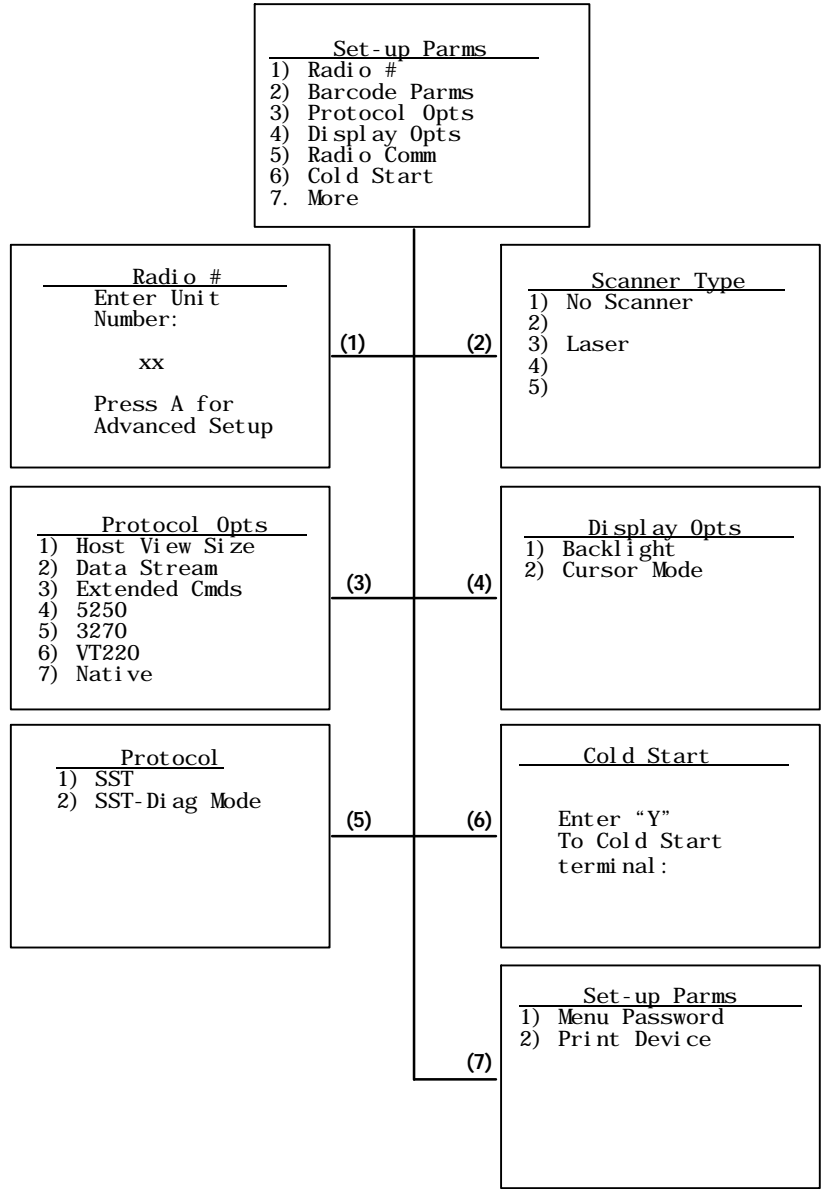

Radio

Use the Radio # menu to set, view, or change the hand-held computer identification number. This number allows the host computer to identify individual hand-held computers in the radio data network. Each hand-held computer must have a unique number in the same network.

The Set Radio # and the Advanced Setup menus, are shown on the following pages.

To set or change the hand-held computer identification number, use the numeric keys on the hand-held computer keyboard. After entering a number (between 0 and 126), press the **[ENT]** key to return to the Main Menu, or the **[A]** key to go to the Advanced Setup menus.

The LAN ID number can be 0-255 depending on the radio you are using. With the RM60/70 radio the number can be 0-255 and with the RM80/90 radio the range is 0-15. Your computer only communicates with equipment using the same ID number that you assigned to your LAN.

If you enter a LAN ID number that is different from what is configured in your NET.CFG file you get this message.



LAN ID changed
Need to reboot
to take effect.

If this happens the system modifies your net.cfg file which is used by the WTPPKT.EXE program on initialization of your computer. Therefore, that is why you need to reboot your computer.

The second option in the Advanced Setup menu allows you to change the radio configuration setting. At the present time this is not used and is left available for custom settings necessary at a particular customer site. A Norand System Engineer works with you to make this setting.

If your computer is using an RM160/170 902 MHz or RM180/190 2.4 GHz radio module use the up and down arrows to pick the Direct Sequence (DS) and Channel configuration. If your computer is using an RM111 Synthesized UHF radio you select from the list the possible frequencies for your radio module.

Use the next option in the Advanced Setup menu if there is more than one host computer on your SST network. This allows you to designate up to three host computers for each hand-held computer. Each host is assigned a separate priority level (1, 2, or 3). When powered on, the hand-held computer seeks host A. If host A is not available, the hand-held computer seeks host B; if host B is not available, the hand-held computer attempts to log onto host C.

When designating additional hosts, you must:

- Tell the hand-held computer the host type of each host computer (Native, 3270, 5250, or VT220).
- Assign a hand-held computer number for each host.
- Tell the hand-held computer the name of each host.

" **NOTE:**

Selections in these menus apply only to the current session. Use the Session Menu to verify or change the current session.

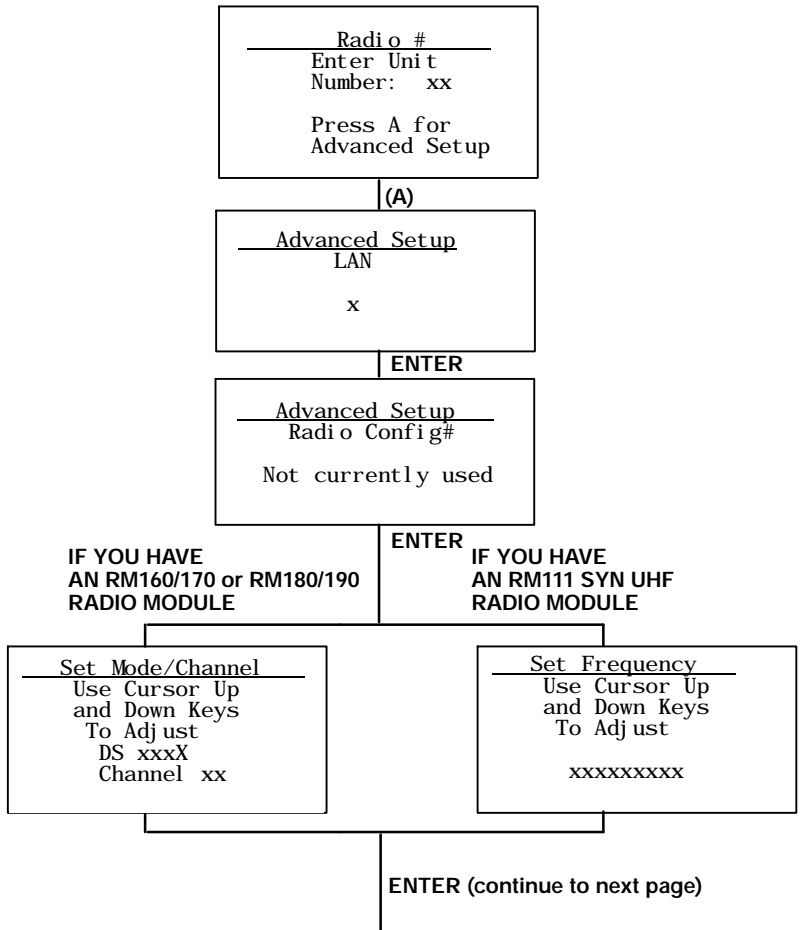

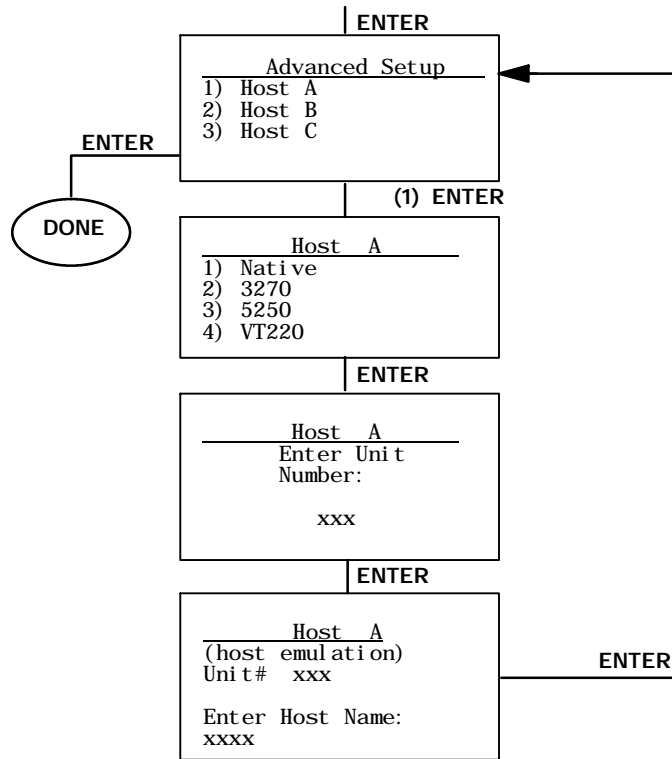

Bar Code ParmS

The Bar Code ParmS (parameters) menus designate:

- " If you are using a bar code scanner
- " Scan options
- " The bar code symbologies to use (the computer can only decode the bar code symbologies you enable)
- " Options for each enabled bar code symbology (e.g., minimum and maximum bar code lengths)

The Scanner Type menu is the first Bar Code ParmS menu. Choose the desired option from this menu and press the **[ENT]** key. The next Bar Code ParmS menu appears on the display.

Scanner Type

Use the Scanner Type menu to designate the type of bar code scanner.

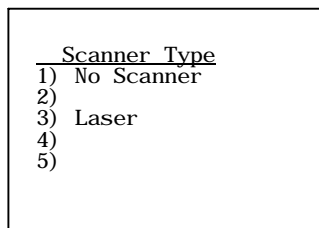

To make a selection, press the numeric key corresponding to the desired option, then press the **[ENT]** key. This takes you to the Scan Options menu.

" **NOTE:** *You can choose option 1, "No Scanner," and still set the remaining scanner and bar code options. Then, if you use a scanner at a later time, all parameters are set and it is only necessary to designate the scanner type.*

" **NOTE:** *Selected options are highlighted on the display. To deselect a selected option, press the key that corresponds to that option.*

Scan Options

Use the Scan Options menu to designate how the hand-held computer handles scanned bar codes. The Scan Options menu is shown below. Descriptions of the options follow.

<u>Scan Options</u>
1) Redundancy
2) MOD 10 Check
3) Concatenate
4) BC Type Char
5) Stream Scan
6) Scan All Fl ds
7) More

Redundancy: This option requires two identical scans of a bar code, one right after another, before the hand-held computer accepts the scan as valid.

Mod 10 Check: When you select this option, a check digit is added at the end of the bar code after a good read. This is a variation of the modulus 10 formula and is used infrequently.

For additional information on Mod10, refer to the book *PEN*KEY^R 6400 Programmers Reference Guide* NPN: 977-054-004.

Concatenate: Each bar code read is added to the end of the previous bar code read until the computer meets a condition that forces transmission to the host.

When this option is OFF, each bar code read is placed at the beginning of the current input field. After a bar code is placed in a field, any subsequent read replaces the first read.

BC Type Char: This option adds a character associated with the bar code type at the beginning of the scanned bar code.

Stream Scan: If the scanned bar code is too big for the input field, the overflow information appears in the next field. This continues until the entire bar code is entered.

When this option is OFF, and the scanned bar code is too big for the input field, the overflow information is dropped.

Scan All Fields: When you select this option the scanner is enabled whenever the cursor is in an input field. When this option is OFF, the host computer must enable the scanner for each input field that requires scanned data.

After you press the **[ENT]** key, the display advances to additional Scan Options menus.

To enable the scan options, press the numeric key(s) corresponding to the options you want, then press **[ENT]**. *You can enable more than one Scan Option at a time.*

Scan PreChar and Scan PostChar: Enter a hexadecimal value from 00-FF for the character to be sent preceding the scanned data or after the scanned data. The value of 20h means that pre or post characters are not sent.

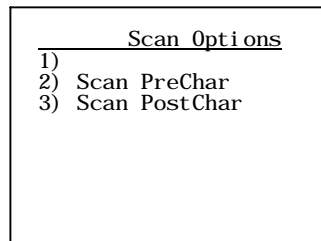

Scan Options To Enable Bar Codes

There are menus of options to enable (or disable) various bar code symbologies. To enable a bar code, press the numeric key corresponding to the number of the bar code symbology (as shown on the menu), then press the **[ENT]** key.

After enabling a particular bar code you may have to select various options for the bar code. After selecting the desired options, you are prompted to set length requirements (such as minimum and maximum length, fixed lengths, leading and trailing character options, etc.).

Once the length requirements have been set, the computer returns to the same Scan Options menu. You may then choose to enable another bar code symbology from that menu, or you can advance to the next Scan Options menu by pressing the **[ENT]** key.

The Scan Options menu, and the bar code symbologies you can enable from it, are shown here.

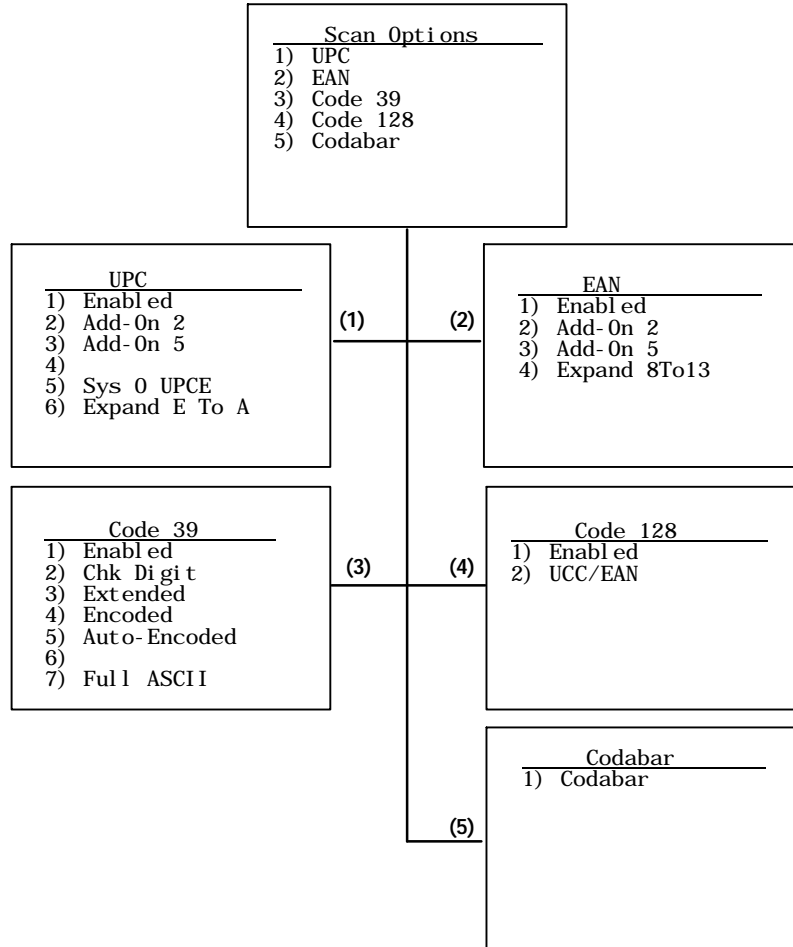

Scan Options of Additional Bar Codes

This menu offers additional bar code selections. After enabling a bar code symbology, you can set various options for the bar code, then set length options for the bar code.

When all options have been set, the display returns to the Scan Options (2) menu. The Scan Options (2) menu and the bar code symbologies you can enable from it are shown below.

When you have enabled all needed bar code symbologies, press the **[ENT]** key. You return to the first Scan Options menu. Press the **[ENT]** key again to back out and return to the Set-Up Parm's menu.

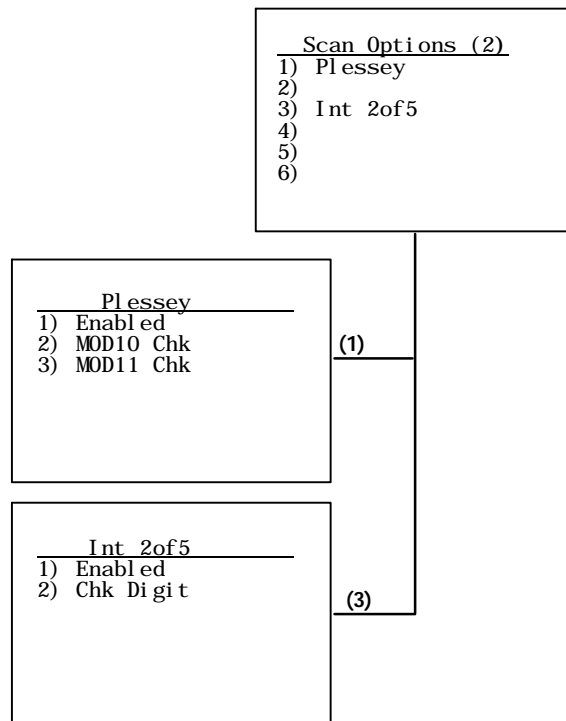

Lengths Options

The Lengths Options menus determine the maximum and minimum length for a specific bar code symbology. Setting the length of enabled bar codes helps the hand-held computer determine if a scanned bar code is valid and improves hand-held computer response time.

The length options must be set for each enabled bar code. Instructions for setting the length options follow on the next page.

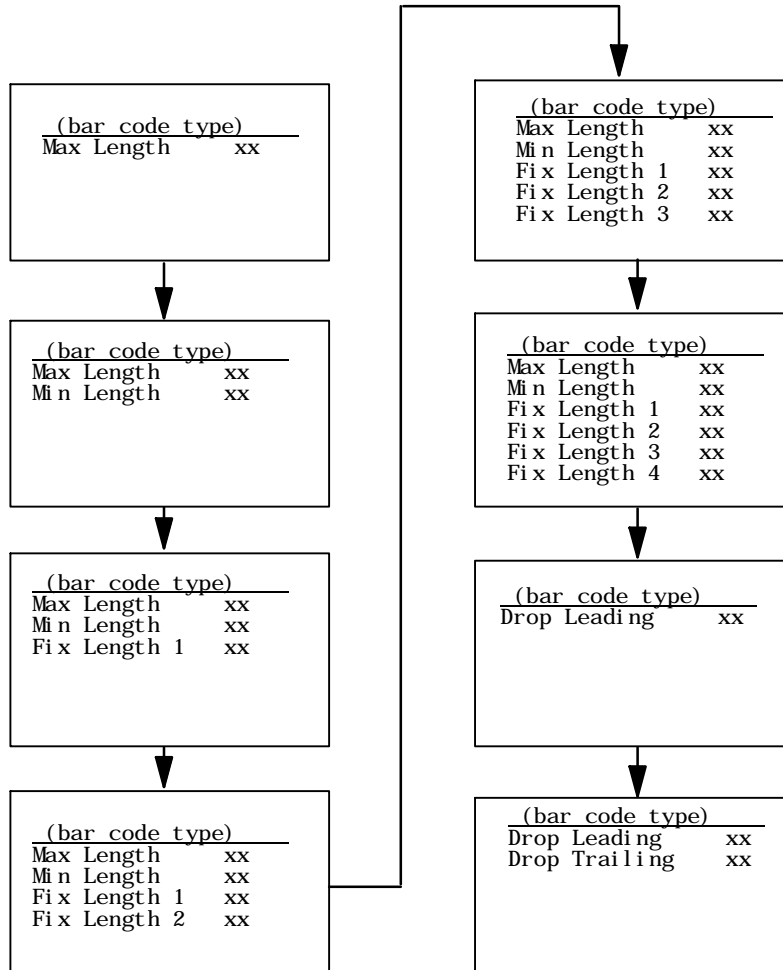

1. Key in the maximum length (0-99) for the selected bar code, then press **[ENT]**.
2. Key in the minimum length (0-99) for the bar code, then press **[ENT]**.

" **NOTE:**

1 of 5 only supports fixed lengths 1 and 2. Entries in fixed lengths 3 and 4 are ignored as well as minimum and maximum lengths.

" **NOTE:** *The next prompts set fixed bar code lengths (the enabled bar code must be of a certain length—determined by your entry). Fixed-length entries override the maximum and minimum length entries (minimum and maximum are used for chosen codes). If you do not want fixed lengths for the enabled bar code, enter zero (0).*

3. Enter the fixed length (0-99) for the defined bar code, then press **[ENT]**. Each time you set a fixed length, (then press the **[ENT]** key) you are prompted to set another fixed length—up to four. To set fewer than four fixed lengths, enter zero (0) for the unused fixed lengths. (For example, if you only require 2 fixed lengths, enter zero when the Fixed Length 3 and 4 prompts appear on the display.)

" **NOTE:** *Use the next two prompts to drop a particular number of characters from the front (leading) or rear (trailing) edge of the scanned bar code.*

4. Enter the number of characters (0-15) to drop from the beginning of the scanned bar code, then press **[ENT]**.
5. Enter the number of characters (0-15) to drop from the end of the scanned bar code, then press **[ENT]**.

After you have set all of the length options for the enabled bar code the display returns to one of the Scan Options menus (depending on which menu you enabled the bar code from).

Protocol Options

Use this selection to designate the hand-held computer type of the host computer. You can also designate which additional commands and command sets are available.

The Protocol Opts menu has seven submenus to customize your hand-held computer. The Protocol Opts menu is shown on the next page.

<u>Protocol Opts</u>	
1)	Host View Size
2)	Data Stream
3)	Extended Cnds
4)	5250
5)	3270
6)	VT220
7)	Native

Host View Size

The Host View Size option tells the hand-held computer the format of display information sent from the host. The display viewing size equals 1920 (determined by taking the number of rows times the number of columns). The exception is with 5250 Terminal Emulation which can have an additional row for error messages and therefore can have 2000 characters instead of 1920.

The default setting for Native Terminal Emulation is 120 columns by 16 rows (equals 1920). The default for VT220 Terminal Emulation is 80 columns by 24 rows (equals 1920). The default for 5250 Terminal Emulation is 80 columns by 24 rows (25 with error messages).

The default for 3270 Terminal Emulation depends on what the original setting was before you changed to 3270 Terminal Emulation. Remember that the total characters must equal 1920 (number of rows by the number of columns) unless using 5250 Terminal Emulation with error messages.

<u>Host View Size</u>	
	Width
	xx

To change the width, enter a number (between 1 - 80). Press **[ENT]**, and return to the Protocol Opts menu.

Data Stream

Use this menu to specify the data stream used by the host computer.

<u>Data Stream</u>
1) Native
2) 3270
3) 5250
4) VT220

Enter the number corresponding to the type of the host computer. Press **[ENT]** and return to the Protocol Opts menu.

Extended CMDS

With this option ENABLED, the host computer can change or use the following features of the hand-held computer:

- " RS-232 communications (e.g., printer)
- " Bar code options
- " Display screen and font size
- " Error tone

<u>Extended Cnds</u>
1) Enabl ed
2) Di sabl ed

1. Press **[1]** to enable the extended command set, or press **[2]** to disable the extended command set.
2. Press **[ENT]** to return to the Protocol Opts menu.

5250 Options

The 5250 Options menu lets you enable the following features *if you are using the 5250 communication protocol*:

- Beep On Error
- Auto Tab Scan
- Telnet

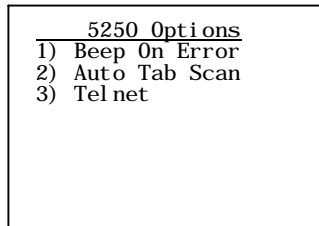

Enabling Beep On Error causes the buzzer to sound when an error condition occurs, but allows you to continue working. Normally, when an error occurs the keyboard locks-up, the hand-held computer must be reset either from the host or the RESET key on the hand-held computer itself.

The Auto Tab Scan option causes the cursor to automatically tab forward to the next input field when a good scan is obtained.

Telnet allows for the handling of telnet option negotiations to establish a session with an appropriate telnet server.

To enable these options:

1. Press **[1]** to enable the Beep On Error option.
Press **[2]** to enable the Auto Tab Scan option.
Press **[3]** to enable the Telnet option.
2. Press **[ENT]** to return to the Protocol Options menu screen.

3270 Options

The 3270 Options menu lets you enable the following features *if you are using the 3270 communication protocol*:

- " Keyboard Unlock
- " Auto Tab Scn (scan)
- " Auto Entr (enter) Scn
- " Emulate 3210
- " Telnet

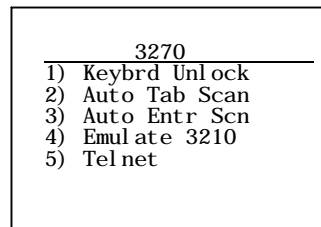

Enabling Keyboard Unlock unlocks the keyboard after the **[PA1]**, **[PA2]**, or **[CLEAR]** keys are pressed. (Normally the keyboard remains locked—until unlocked or the hand-held computer is reset by the host—after any of these keys are pressed.) When using Token Ring on your host, the tab key also unlocks the keyboard.

Enabling Auto Tab Scan causes the cursor to tab forward to the next input field whenever a good scan is obtained.

Enabling Auto Entr Scan actuates the **[ENTER]** function whenever a good scan is obtained.

Enabling Emulate 3210 allows your 3270 keyboard to emulate a 3210 terminal.

Telnet allows for the handling of telnet option negotiations to establish a session with an appropriate telnet server.

To enable these options:

1. Press **[1]** to enable the Keyboard Unlock option.
Press **[2]** to enable the Auto Tab Scan option.
Press **[3]** to enable the Auto Entr Scan option.
Press **[4]** to enable 3210 Emulation option.
Press **[5]** to enable the Telnet option.

" **NOTE:**

Auto Tab Scan and Auto Entr Scan cannot be enabled at the same time.

2. Press **[ENT]** to return to the Protocol Options menu screen.

3210 Emulation

The Norand 3210 emulation option causes your radio hand-held computer to perform the same functions as the RT3210 hand-held computer. For full 3210 compatibility: you must disable buffering the keyboard, set cursor to lazy mode, and set the LCD Parm's to Key Uppercase.

After enabling the desired 3270 options, press the **[ENT]** key to return to the Protocol Opts menu.

VT220

The VT220 menu lets you enable the following features *if you are using the VT220 communication protocol*:

- " DEL to BS (delete to backspace)
- " CR to CRLF (carriage return to carriage return line feed)
- " Auto Entr (enter) Scn
- " Auto Tab Scan
- " Local Echo
- " AnswerBack
- " More

VT220
1) DEL to BS
2) CR to CRLF
3) Auto Entr Scn
4) Auto Tab Scan
5) Local Echo
6) AnswerBack
7) More

The DEL to BS option, when enabled, causes the **[CLEAR]** key to delete the character to the left of the cursor position, and moves the cursor back one space. When this option is not enabled, the **[CLEAR]** key deletes the character at the cursors position.

The CR to CRLF option, when enabled, causes the **[ENT]** key to perform a carriage return and a line feed. When this option is not enabled, the **[ENT]** key performs a carriage return only.

Enabling Auto Entr Scn actuates the **[ENT]** function whenever a good scan is obtained.

The Auto Tab Scan option causes the hand-held computer to automatically tab to the next input field when a good scan is obtained.

" **NOTE:** *The Auto Entr Scan and Auto Tab Scan options cannot be enabled at the same time.*

Enabling the Local Echo option allows characters to be displayed from hand-held computer memory but not from host memory.

The Answerback option allows you to input up to a 30 character string, which is then sent back to the host in response to an inquiry (hex 05).

The More option calls up the following screen:

```
VT220
-----
1) Screen Lock
2) Di scret eBells
3) UserKey Locked
4) RS232 Setup
5) VT220 Mode
6) Lock Mode
7) More
```

The Screen Lock option allows the user to set up and lock the screen to a specified size. Any characters falling outside this screen size are ignored by the hand-held computer.

If the DiscreteBells option is enabled, the hand-held computer beeps for each bell character the host sends. If the option is disabled, the hand-held computer ignores bell characters if it is already beeping.

You can get a command from the host that defines the Function keys. If UserKey Locked is set the host ignores this command while this option is set.

Selecting RS232 Setup allows you to select from another menu of choices. These choices are:

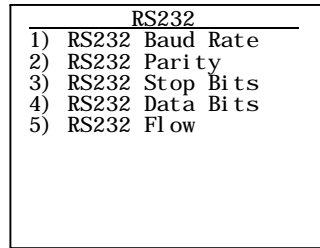

Select your choice, then press the **[ENT]** key to return to the Protocol Opts menu.

Selecting VT220 Mode allows you to select operating in character or block mode.

Select your choice, then press the **[ENT]** key to return to the Protocol Opts menu.

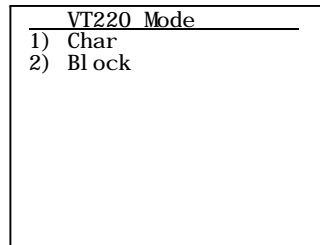

Selecting Lock Mode disables the Mode key in the VT220 data stream. The default Mode key toggles between block and character modes.

Selecting More moves you to select the telnet option for the VT220 data stream.

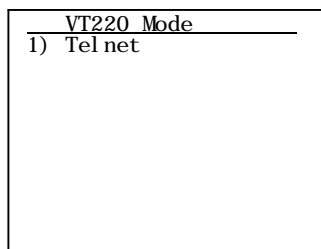

Telnet allows for the handling of telnet option negotiations to establish a session with an appropriate telnet server.

Make your selection, then press the **[ENT]** key to return to the Protocol Opts menu.

Native

This option is enabled by default to preserve backward compatibility. When enabled, pressing <F1> is equivalent to pressing Blue-0, while pressing <F2> is equivalent to pressing Blue-1, etc. When *disabled*, <F1> is equivalent to Blue-1, and <F2> is equivalent to Blue-2, etc.

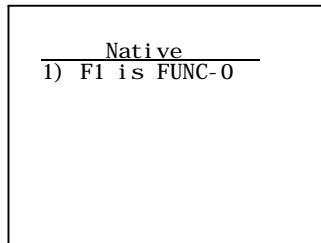

Display Options

Display Opts allows you to choose the backlight timer feature or how the cursor appears on the display.

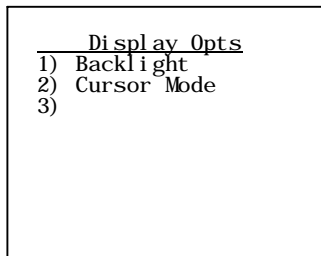

Backlight

Selecting Backlight displays this screen.

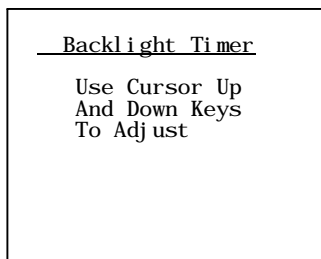

Use the up[Y] and down[B] arrows to select a number from Off to 255. This is the number of seconds that the backlight stays on after a key is pressed.

Cursor Mode

The Cursor Mode menu allows you to select the cursor style.

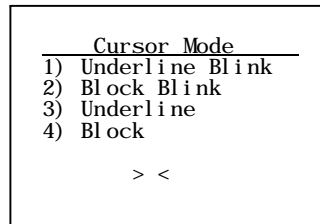

- " Cursor location in the Block mode is indicated by a reverse video (highlighted) block (J) character.
- " Blink modes causes the cursor to appear and disappear in its current location. Blinking cursor only works using the 16 line by 20 column font setting or 18 x 20 depending on the size of display you have selected on your computer.
- " The cursor shape is displayed between '>' and '<'.

After making your selection, press the **[ENT]** key. You then return to the Display Opts menu.

Radio Comm

This menu allows you to enable or disable SST diagnostic mode.

" NOTE:

Diagnostic modes disable data compression and are reserved for engineering tests.

Cold Start

The Cold Start option performs a hand-held computer cold start. A cold start resets all hand-held computer parameters to their default values.

```
      Cold Start
      -----
      Enter "Y"
      to Cold Start
      terminal:
```

Press the **[Y]** key to cold start the hand-held computer, or press any other key to return to the Set-Up Parm's menu.

More

The More option allows you to enable a menu password protection. This option provides added protection because once it is enabled, the password must be entered before any further activity can occur within the terminal emulation menu screens. The default is to have this option disabled.

```
      Set-up Parm's
      -----
      1) Menu Password
      2) Print Device
```

Enable Password

1. Press the **[1]** key.
2. At the prompt, enter the password 3193693. This becomes the permanent password. With this menu password protection enabled, enter this password whenever you access the terminal emulation menu screens.

3. Press the **[ENT]** key a couple of times to return to the main menu.
4. Press **[6] Exit Menu** to return to the main terminal screen.

Disable Password

5. To disable this permanent password, press the **[1]** key. The **1** displays in normal viewing text. You do not need to enter the password to disable this function.

Print Device

Print Device menu allows establishing extended commands either for the RS232 or IRDA printer drivers.

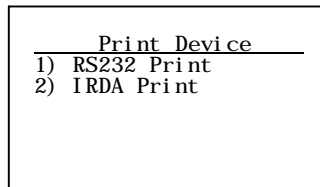

1. Press **[1]** for the RS232.
2. Press **[2]** for the IRDA.

LCD Parms

The LCD Parm (parameters) menu allows you to adjust the following features of the liquid crystal display:

- The screen size (number of rows displayed, and the number of characters displayed on each row).
- The screen mode (how the cursor positions itself on the display).
- Making all alphabetic character keystrokes uppercase characters.

- Scrolling window parameters

LCD Parms	
1)	
2)	Screen Size
3)	Screen Mode
4)	Annunciators
5)	
6)	Key Uppercase
7)	Scroll Window

Screen Size

Screen Size lets you select the number of lines, and characters in each line, that can be viewed on the display. Choices include:

- 6 rows, with 10, 13, 16, 20, 26, or 32 characters per row
- 9 rows, with 10, 13, 16, 20, 26, or 32 characters per row
- 12 rows, with 10, 13, 16, 20, 26, or 32 characters per row
- 18 rows, with 10, 13, 16, 20, 26, or 32 characters per row

It is also possible to have selected 5, 8, 10, and 16 for number of rows. This depends on what size of display you have selected. Only one option can be selected at a time.

Screen Size						
	10	13	16	20	26	32
6	Off	Off	Off	off	off	off
9	Off	Off	Off	off	off	off
12	Off	Off	Off	off	off	off
18	Off	Off	Off	ON	off	off

To change the screen size:

1. Press the arrow keys. Each key press moves the word **On** one position in the direction of the arrow key pressed. The word **On** indicates the current setting (the setting above is 18 rows with 20 characters per line—the word **On** is in the row 18, column 20).
2. When the word ON appears in the position corresponding to the desired screen size, press the **[ENT]** key.

Screen Mode

Use Screen Mode to select cursor position and movement as you scroll through data in the display buffer. This buffer stores data in a standard CRT format (as sent from the host computer). Since your hand-held computer display is smaller than a CRT, these Screen Mode options allow you to optimize your view of information (data) on the hand-held computer display.

In order to see all of the data on the screen, use the arrow keys to scroll (or “move”) the view port of the screen on the display.

<u>Screen Mode</u>
1) Center Cursor
2) Corner Mode
3) Page Mode
4) Lazy Mode
5) Locked Mode

Center Cursor is the default mode. In this mode, the cursor begins near the center of the display and attempts to remain there as you scroll through the data. Upon reaching an outside boundary of the full CRT screen, the display stops advancing while the cursor moves beyond the center

of the screen. When the cursor reaches the boundary of the CRT screen, an error tone sounds (the hand-held computer "beeps"). The cursor does not wrap to the next line in the display. This option is recommended when your application program sends the full CRT display to the hand-held computer.

The **Corner Mode** option starts the display at the upper-left corner of the full CRT screen and keeps the cursor in the lower-right corner of the display. As you scroll, the cursor remains there as data advances in the scrolled direction (up, down, right, or left)—until an outside boundary of the full CRT screen is reached. Then the screen stops moving in relation to the display and the cursor moves in the scrolled direction (the cursor no longer remains in the corner of the display). When the cursor reaches the CRT screen boundary it stops moving. The cursor does not wrap to the next line in the display. An error tone sounds if you try to move the cursor beyond the boundary. This option is recommended when your application uses only the upper-left corner of the full CRT screen.

The **Page Mode** option divides the full CRT screen into predefined "pages," and starts the hand-held computer display on page 1. The cursor first appears in the upper-right corner of the display. As you scroll, only the cursor moves (the data on the screen does not appear to move). When you scroll off the edge of the displayed page, the display snaps to the next (or previous) page. Upon reaching the boundary of the CRT screen, the cursor stops moving and an error tone sounds each time you attempt to move beyond the boundary.

" **NOTE:** *Some "pages" in Page Mode overlap each other (the same information is shown on both pages). This overlap occurs because the 24 row by 80 column CRT screen cannot be divided equally.*

Lazy Mode starts the cursor in the upper left corner of the hand-held computer display. The cursor moves across the

display in the scrolled direction. When the cursor goes beyond the edge of the display, the data begins to move in the opposite direction that the cursor is moving in and the cursor remains at the edge of the display. When you reach an outside boundary of the full CRT display, an error tone sounds each time you try to move beyond the boundary.

When **Locked Mode** is selected the screen view is locked to the upper left hand corner of the display. Any characters outside of the display window size you select are written to the screen, but you can not see them. The windowing keys do not move the visible window.

" **NOTE:**

In 5250 emulation the err_row is mapped to the last row of the screen size selected.

Annunciators

You can select and change the location of the annunciators on your display screen. The default is the lower right corner, the other choices are any of the other three corners. You can also select Stealth Mode which displays the annunciators only when you make a change and then hides it when you press a key.

Key Uppercase

The Key Uppercase option, when enabled, causes the alphabetic keys (A-Z) to display as uppercase characters regardless of the shift or caps lock mode settings.

Scroll Window

Menu items are: (1) *Tab Size*, (2) *Screen Size*, (3) *Define Width*, and (4) *Define Height*. Choices 1 and 2 allow you to define the size (tab or screen size) of cursor movement: how far it moves with each press of the arrow key. Choices 3 and 4 allow you to customize the screen size.

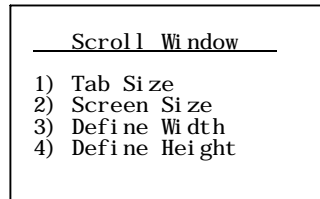

Option 1 causes the cursor to move by the amount set in options 3 and 4.

Option 2 causes the cursor to move by the virtual screen size selected in LCDParms under the Main Menu.

Options 3 and 4 manually define the x-axis and y-axis (up and down) movement of the cursor when option 1 (tab size) is selected.

Beeper Setup

The Beeper Setup menus allow you to adjust the beeper tones for key clicks (presses) and error conditions.

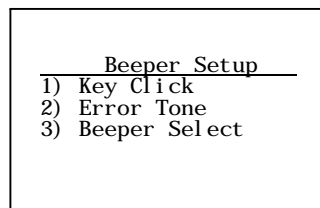

Key Click

Use the Key Click option to adjust the frequency and length (duration) of the sound made when you press a key.

The frequency of the tone is adjustable in steps from 0 to 32. The length is adjustable in steps from 0 to 10. The Key Click menu screen and subscreens are shown below.

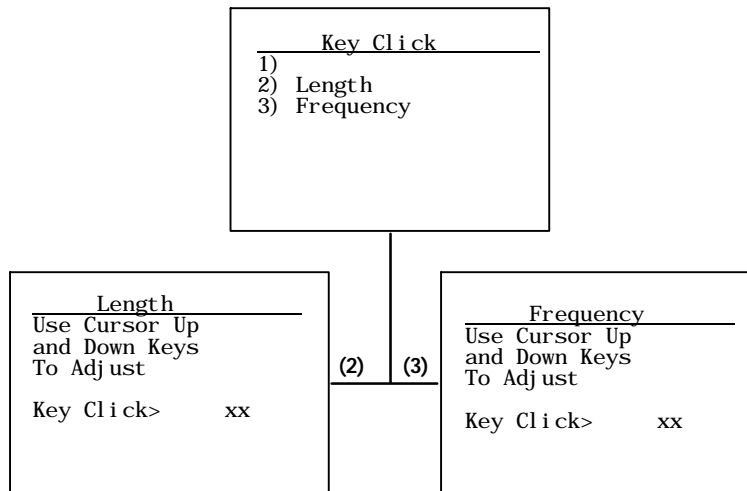

To adjust the key click tone:

1. Press key **[2]** or key **[3]**.
2. Press the **[Y]** or **[B]** keys to make the desired adjustment. Each key press is accompanied by a tone at the new frequency or length.
3. Press **[ENT]** to confirm your selection and return to the previous screen (Key Click menu).

Error Tone

The Error Tone option lets you to adjust the length and frequency of the tone made when an error occurs (for example, pressing an invalid key). The Error Tone adjustments, and the procedures for making them are identical to the Key Click adjustments.

Beeper Select

The Beeper Select option lets you turn off the internal beeper. The default setting has the beeper sound enabled.

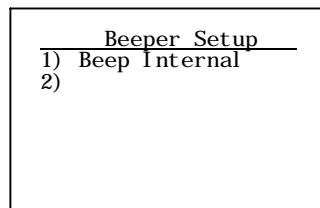

To turn the beeper select option Off:

1. Press **[1]** key to turn off the internal beeper.
2. Press **[ENT]** to confirm your selection and return to the previous screen.

Tests

The Tests menus allow you to test peripherals, the display, RF communications, and memory.

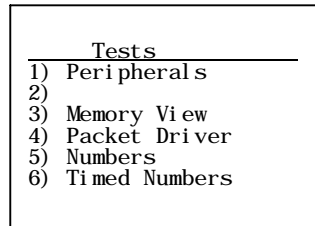

Peripherals

The Peripherals menu allows you to test various hand-held computer peripheral devices. There are currently four different tests:

- RS-232, which tests the communication port on the hand-held computer.
- Display, which tests the operation of the hand-held computer display.
- Keyboard, which tests the operation of the hand-held computer keyboard.
- Scanner, which tests the operation of a bar code scanner attached to the hand-held computer.

The peripherals menu is shown below. Detailed descriptions of each peripheral test follow.

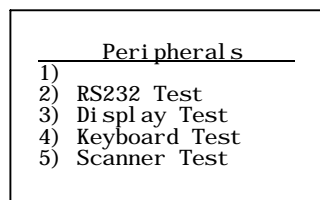

RS232 Test

The RS232 Test checks the data communication port on the bottom of the hand-held computer.

This test requires a special loop-back connector that links the following input and output pins on the data connector:

- The TX output to the RX input
- The DTR output to the DSR input
- The CTS output to the RTS input

The RS232 Test screens are shown below.

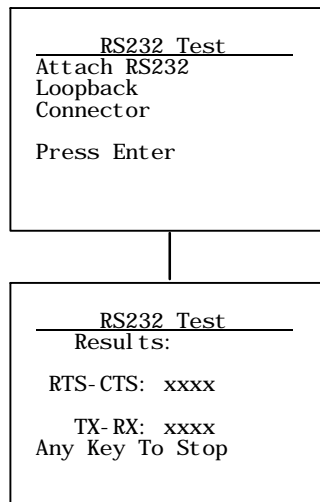

To run the test:

1. Select the RS232 Test from the Peripherals menu.
2. Attach the loop-back connector to the round connector on the bottom of the hand-held computer, then press **[ENT]**. The display changes to the second RS232 Test menu (shown above).

The condition of each line-pair displays as passing or failing the test. If any test fails, the hand-held computer should be returned for service.

Display Test

The Display Test activates each element in the LCD display. If a line appears broken, or there are gaps in the display, the LCD panel needs to be replaced.

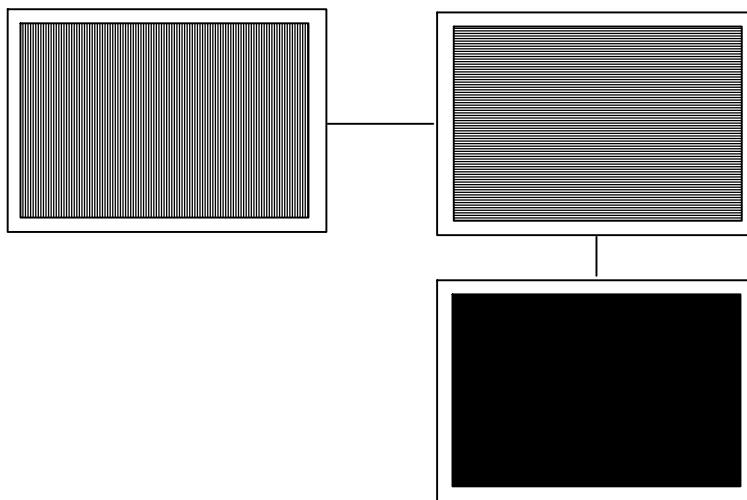

To perform the Display Test:

1. From the Display Test Menu, press **[ENT]** to start the test. The display screen is painted with a series of vertical lines.
2. Visually inspect the lines. For the test to pass, all lines should appear clear and complete (no broken segments); press **[ENT]**. The display screen is then painted with a series of horizontal lines.
3. Visually inspect the lines using the same criteria. The display screen is then painted black.
4. Visually inspect the painted black lines. For the test to pass, the screen should be uniformly black; press **[ENT]**. You return to the Peripherals menu.

Keyboard Test

The Keyboard Test lets you test each key on the hand-held computer keyboard. The Keyboard Test screen is shown below:

```
Keyboard Test
-----
Press a key
ENTER To Exit

Key =
  'A'
```

To perform this test, press each key on the keyboard (except the **[ENT]** key). A character corresponding to the key pressed should appear on the display.

Scanner Test

The Scanner Test allows you to test the operation of an attached bar code scanner. From the Scanner Test menu, scan an enabled bar code. For this test to pass the bar code and the bar code length should appear on the display. Press any key to exit.

The Scanner Test screen is shown below.

```
Scanner Test
-----
Scan Code>
Length>
```

Memory View

This menu is reserved for engineering test and evaluation.

```
Memory View
F1 - Exit
F2 - Heap
F3 - Far Heap
F4 - Memory Dump
Address: XXXXXX
```

Packet Driver Test

The Packet Driver tests allow you to test the accuracy of data transmissions to and from the hand-held computer.

```
Packet Driver
1)
2)
3) Packet Stats
4) Histogram
5)
```

Packet Stats

The Packet Stats (statistics) test shows the number of packets sent and received, number of errors, and number of packets dropped.

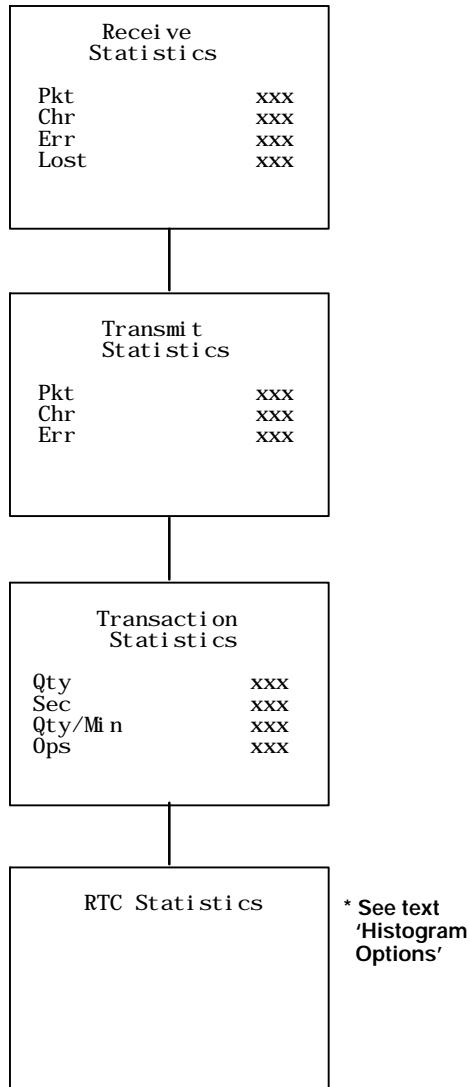

Histogram Opts

A Norand engineer may ask you to access this menu if your hand-held computer has problems. From this menu you can provide the Norand system engineer with vital information about your hand-held computer.

The actual menus are not shown in this manual, however some of the general terminology is shown below. Several of the menu options, such as "Clear. . .," are password-protected and are only accessible if the engineer provides you with the correct password.

Terminology you might see:

- " avg tx time
- " avg trans time
- " ptt (push-to-talk) count
- " addrs on list
- " poll no data
- " send retries
- " rcv retries
- " reset count
- " interval time
- " time bucket #

A Norand engineer works with you on these selections.

```
Hi stogram Opts
1) Start
2) Stop
3) Vi ew
```

Numbers

The Numbers test checks the operation of the hand-held computer microprocessor. During the test, the hand-held computer display is filled with hexadecimal numbers that move across the screen horizontally and scroll vertically. Character movement indicates that the processor is still running.

This test is helpful in detecting lockups during severe operating conditions.

Timed Numbers

The Timed Numbers tests does the same thing as the Numbers test except that it keeps track of the time in seconds that it took to run the test.

Version Info (Information)

Version Info (Information) screen shows:

- The name of the program you are using
- The version of the program you are using
- The release date of the program
- Version of radio driver
- Mac address of computer

<u>Version Info</u>	
Firmware name	
Version	x. x
Date	ddmmmyy
MLID Ver	xx. xx
	xxxxxxxxxxxx

Exit Menus

The Exit Menus option (#6) exits you from this terminal emulation section and returns you to the screen you were at before entering this section.

More

The More selection opens Main Menu 2, which is shown below.

```
      Main Menu 2
-----
1) Keyboard Opts
2) Save Parm's
3)
4) Session Menu
```

Keyboard Opts

Use the Keyboard Opts (options) menu to choose the Type-Ahead option. This lets you key in information when the hand-held computer cannot immediately send data to the host computer.

```
      Keyboard Opts
-----
1) Type-Ahead
```

Save Params

Save Params (parameters) retains the parameters you programmed into the hand-held computer. When you save parameters, they become the default settings for the hand-held computer. When you select Save Params, you are prompted to enter a seven-character password (CR52401), as shown in the following. Once the password is correctly entered, the hand-held computer automatically saves (writes to EEPROM) the parameters.

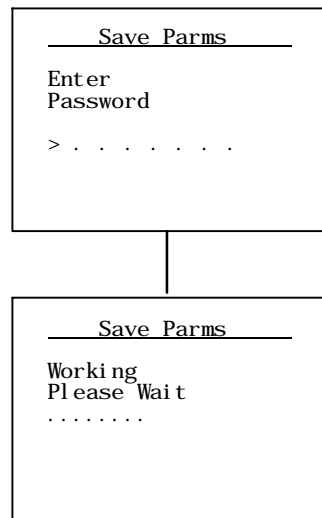

Session Menu

The Session Menu allows you to define different host communication sessions and to designate a “hot key” that allows switching quickly between the different session.

Use the Switch option to change the current session. The current (or intended) session must be identified (or designated) before setting Parameters.

When you select Set Hot Key, the current hot key is displayed. Use the up and down keys to view the available

choices. When the desired key displays, press **[ENT]** to set your selection. The Set Hot Key option is only available on hand-held computers that support session switching.

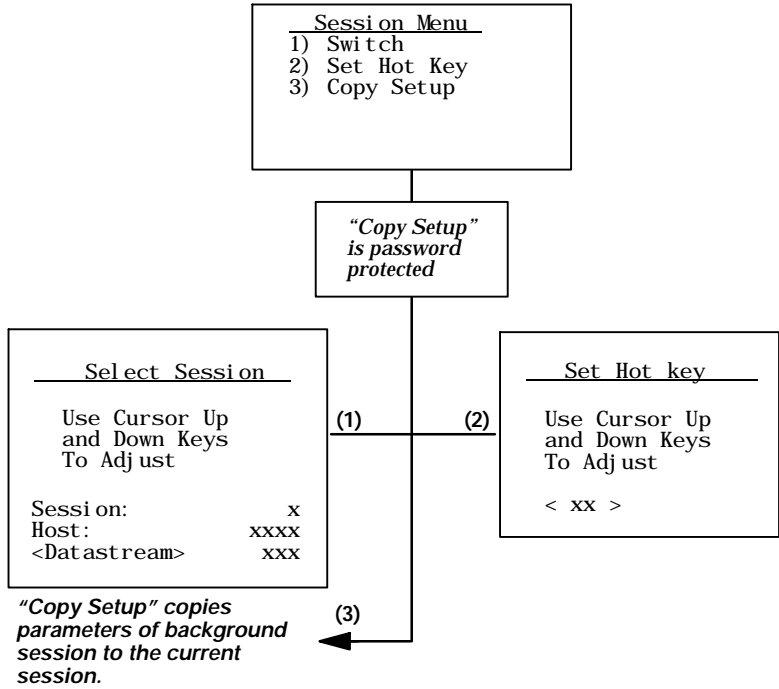

To Exit Emulation Mode and Return to DOS

If you want to exit the emulation program you are using and return back to the DOS keyboard layout complete these two steps.

1. Do a Cold Restart.
2. Press "Y".
3. Press **[ENT]** several times. This puts you at the DOS C:\ prompt.

If you do the hard reset of pressing and holding the blue and yellow shift keys, and both **[ENT]** keys this exits you to the beginning of the current emulation you are using.

Section 4

Maintenance and Troubleshooting

Introduction

Your computer is designed to withstand normal use in harsh environments. Occasional maintenance is required to ensure trouble-free operation. The procedures in this section should help keep your computer in good working condition.

Maintenance procedures included in this section provide instructions for identifying Low Battery conditions and cleaning your computer.

Low Battery Indication



Battery Pack Gas Gauge Icons:

These battery icons represent the charge level in your main battery pack.

- Four icons indicates more than 76 % charge level
- Three icons indicates between 51-75%
- Two icons indicates between 26-50%
- One icon indicates between 21-25%

Once your computer gets below the 20% range, the icons are replaced by "Ls" and after the charge level is less than 10% your computer emits a series of beeps.

- " Four Ls indicates between 16-20% charge level
- " Three Ls indicates between 11-15%. At the 15% charge level, your computer beeps once. The sound duration and frequency are at levels you have set for your computer.
- " Two Ls indicates between 6-10%. At the 10% and 7% charge levels, your computer beeps once. The sound duration and frequency are at levels you have set for your computer.
- " One L indicates between 0-5%. At this charge level, your computer beeps three times at its current setting level for both duration and frequency.

" **NOTE:**

*If you have the beeper turned **off**, you will not hear any of the low battery beep warnings.*

The battery pack icons on your computer display reflect the same status as the LEDs on the battery pack. However, there may be a one-minute delay for updating the icons on the display when the battery pack is replaced.

If you turn your computer on and it does not respond, this may mean that both the main and backup battery are run down. Just to be sure, insert your computer in a dock or other charging device, turn it on, and see if the computer responds. If it does, follow the "**Charging Your Battery Pack**" instructions beginning on page 2-9 and the "**Back-up Battery**" instructions on page 2-13. If it does not respond when inserted into the equipment that provides charge, another problem could exist. If this happens, refer to the **Troubleshooting** section for solutions.

Cleaning Your Hand-Held Computer

Periodic cleaning helps maintain the appearance and reliability of your computer. When cleaning your computer, inspect the keyboard, covers, display, connectors, and peripheral products for obvious signs of damage or wear.

B CAUTION: Do not use any abrasive cleaning compounds, ketonic solvents (acetone or ketone) or aromatic solvents (toluene or xylene) to clean any part of your computer. These solutions cause permanent damage to your computer.

Never pour cleaners directly on the display nor the case. Instead put the cleanser on a soft cloth and gently wipe the case.

Case and Display

Norand Corporation recommends cleaning the exterior of your computer using a soft cloth dampened with:

- MICRO-CLEAN II cleanser, made by Foresight International, Inc. 4887 F Street, Omaha, NE 68127-0205, telephone 1-800-637-1344
- Glass cleaner or isopropyl alcohol

Docking Connectors

If the docking connector contacts become dirty or tarnished, clean them with a cotton swab dipped in isopropyl (and not ethyl) alcohol. It may also be necessary to lightly burnish them with a pencil eraser.

Troubleshooting

Should you encounter difficulties in routine operation, printing, or communications, there are a few things you may do to correct the problem:

- Refer to your applications (software user) manual operating procedures.
- Ensure that electrical and mechanical connections are secure and undamaged.
- Check battery condition.

Troubleshooting Table

This Troubleshooting table lists conditions you might see and offers some basic remedies:

*Table 4-1
Basic Troubleshooting*

Condition	Solution
Computer Displays Shows An L And Emits A Five Second Beep	This is the lowest battery charge level that your computer will operate before shutting down. Do not continue using until you recharge the main battery pack.
As The Battery Pack Ages, It Is Losing Capacity And Fewer LEDs Are Lighting	Lithium Ion batteries lose about half of their available capacity after 500 cycles (use and recharge = 1 cycle). Therefore, a fully charged battery pack after 500 cycles shows less than four lit LEDs, this is normal. Plan your charging needs accordingly, and note that the capacity continues to decrease with each cycle.
A Fully Charged Battery Pack In The Computer Still Does Not Bring It To Life. None Of The LEDs Light On The Battery Pack.	Leave the same battery pack in your computer for at least 30 minutes, to allow some time to put some charge into your backup battery. Then replace the battery pack with a fully charged pack. Put the original battery pack into an external battery charger.

Table 4-1 continued
Basic Troubleshooting

Condition	Solution
The LEDs On The Battery Pack Do Not Match the LEDs On The Display	It takes a minute after you put in the battery pack for your computer to check the status and display the updated battery charge level.
After A Weekend A Fully Charged Battery Pack Does Not Last The Normal Length Of Time	The computer was left for the weekend without a battery pack in it. Therefore, when you start out the week with the fresh charged battery it has to build up the charge level in the backup battery and that leaves less power for its normal days use.
Computer Reboots When A Battery Pack Is Installed	The computer was not suspended (pressing the [I/O] key to blank the display) before the battery was replaced. Another reason can be that the backup battery may be drained. Recharge the computer for a minimum of 12 hours. If a problem still exists then send your computer to the service center.
Putting The Computer Into A Charging Device The Charge LED Blinks Different Colors	There is a fault state condition occurring in the battery pack or the charger. For the complete details concerning the sequence of the colors of the blinks refer to Section 2 Battery Charger LED and Error Codes on page 2-12.
When Putting The Battery Pack In The Charger The LED Never Turns Green	There is a fault state condition occurring in the battery pack or the charger. For the complete details concerning the sequence of the colors of the blinks refer to Section 2 Battery Charger LED and Error Codes on page 2-12.
Computer Does Not Turn ON When The [I/O] Key Is Pressed	<ul style="list-style-type: none"> * Ensure that there is a main battery in. * Ensure that the main battery is charged. * Ensure that the battery compartment door is closed.

Table 4-1 continued
Basic Troubleshooting

Condition	Solution
Computer Does Not Turn ON When Placed In A Dock	<ul style="list-style-type: none"> * Ensure the dock is plugged in. * Ensure that the battery compartment door is closed. * Reseat computer into dock to ensure proper connection.
Computer Shuts Down During Use	<ul style="list-style-type: none"> * You may have a very low battery. Try recharging the main battery. * You may have hit the battery door latch; this causes your computer to suspend. Check the latch then press the [I/O] key to continue operation.
Computer Resets When You Replace Or Check The Main Battery	The backup battery may not be fully charged, allow at least 8 hours to completely recharge the backup battery.
Computer Turns OFF When You Open The Battery Door Latch	This is the correct operation, the unit shuts down to conserve energy and save data.
Computer Does Not Suspend	<ul style="list-style-type: none"> * The computer stays on when it is connected to a charging device. * The computer stays on when it is processing data or in radio communications. <p>This is OK if connected to a charger or placed in a dock. If this is not the case, and either of these conditions continues for a long period of time, contact Norand support personnel, as this condition runs down the batteries.</p>
Computer Displays A Bad Tcom Message	<ul style="list-style-type: none"> * The computer may not be making full contact with the dock. Try reseating the unit in the dock. * The dock may not be properly connected to the host. Make sure there is a connection. TCOM errors may happen when telephone service is lost, or for reasons not related to the physical connection.

Table 4-1 continued
Basic Troubleshooting

Condition	Solution
Computer Takes A Long Time To Boot Up After A Reset	<p>Normal time is between 30-45 seconds. If you do not have your computer connected to a charging source the booting should be less than 30 seconds. Short beeps about one second apart occur during the booting process to indicate that your computer is working.</p> <p>If it takes longer than that, contact Norand support personnel.</p>
Tethered Laser Data And Internal Laser Engine Data Does Not Show Up In The Key Buffer	<p>Load 64SCN7B with both "-e" and "-w" command lines switches. Both are needed to enable power to the internal engine and direct the data from both scanners to the keyboard.</p>
Wedge Mode Application Dies When Scanning Data Using A Tethered Scanner, But Works Fine With The Integrated Scanner	<p>Check for non-displayable preamble, postamble, prefix, or suffix characters being sent by the laser. The internal laser engine sends a postamble of <cr-lf> by default. Either disable them or code the application to handle them. The integrated scanner and tethered lasers may be configured by scanning setup bar codes.</p>
Tethered Scan Data Does Not Show Up In The Key Buffer But The Integrated Laser Data Does	<p>Ensure that the tethered laser is configured for 9600, n, 8, 1 and the bar code data is prefixed with an STX (0x02) and suffixed with an ETX (0x03).</p>

Table 4-1 continued
Basic Troubleshooting

Condition	Solution
Computer Does Not Scan Bar Code	<p>WARNING: Do Not Look Into Scanner</p> <ul style="list-style-type: none"> * Ensure that there is a main battery in. * Ensure that the main battery is charged. * Ensure that the battery compartment door is closed. * Ensure the bar code symbology is turned On. Application has to have scanner turned On. * Ensure the scanner lens is clean. * Ensure the bar code is free of smears or dirt. <p>Refer to instructions for Scanning beginning on page 2-17.</p>
Pressing The Scan Key Does Not Turn ON Computer	<ul style="list-style-type: none"> * Normal operation is that the scan key on computer wakes it up, but if using a tethered scanner it does not. * Ensure that there is a main battery installed. * Ensure that the main battery is charged. * Ensure that the battery compartment door is closed.
Can Not Scan Interleaved 2 Of 5 Bar Codes	<p>Interleaved 2 of 5 only decodes bar codes that are exactly the same number of characters as programmed into the integrated scanner lengths 1 and 2 parameters. By default, the lengths are 14 and 0. A length of 0 means disabled, so only 14 character bar codes will decode. Ensure one of the lengths is set to the length of your bar code and the other disabled. Do not leave both lengths set, if only one is needed, because Interleaved 2 of 5 can easily mis-decode into an incorrect length.</p>
Hear A Beep When Programming Scanner To Enable Interleaved 2 Of 5, But Not When Trying To Set Length 1	<p>Beeps are heard at the end of a programming sequence. Enabling Interleaved 2 of 5 is a one-bar code sequence. Setting an Interleaved 2 of 5 length is a three-bar code sequence. You will not hear the beep until the third (last) bar code is scanned. Please note, you must scan each bar code of a multiple sequence within a 1/2 second of each other. This is most easily accomplished by making a high resolution copy of the appropriate bar codes and arranging them one above the other.</p>

Table 4-1 continued
Basic Troubleshooting

Condition	Solution
Printers Flow Control On The Serial Port Causes Missing Data	Ensure when loading 64SCN7B that the "-t0" switch is used to disable its handling of serial port data as scanner data. Otherwise, 64SCN7B is reading any XON/XOFF messages from the printer.
"DASI Scanner HW Initialization Failed."	Press any key to proceed. By default, 64SCN7B will try to initialize the integrated scanner. If your computer does not have an integrated scanner, turn off the handling of it with the 64SCN7B command line switch "-i0". The error message will not cause any problems. If you do have an integrated scanner, it is inoperative and needs to be repaired.
Running TN.EXE Does Not Display Data	Add the "-p" command line switch to 64SCN7B -e-w. Also, ensure the [PCTCP TN] section of the PCTCP.INI files contains "screen-saver=yes". TN.EXE bypasses the BIOS key buffer, but TN is not reading the buffer. The "-p" switch causes 64SCN7B to send the keys to the hardware instead of the BIOS. The "-p" switch may be tried for any software that reads keys directly from the hardware rather than the BIOS.

If these basic solutions do not solve your problem, there could be a number of possible causes. Additional things to try:

- Refer to the software documentation written for your application. This documentation may contain troubleshooting information.
- If you purchased your computer from a Norand VAR, contact them before contacting a Norand Customer Service Center.

- " Contact the Customer Support Specialist at your Norand Customer Service Center. Your regional Norand Customer Service Center is fully staffed and equipped to repair your computer. Customer Support Center addresses and telephone numbers are printed on a Product Service Information card. This document is packed with all NORAND^R products.
- " Call the Norand 24-hour Customer Response Center at 1-800-221-9236.

Diagnostic Information

Your computer is equipped with diagnostics. You might be asked to perform tasks to help the Norand Customer Support Specialist or the Customer Response Hot Line Specialist diagnose the problems that you are having.

Repair Service

If you send your computer in for service, be sure to carefully pack the unit and include a description of the problem and the measures you tried to correct it.

Include any printout (if applicable) and/or write down displayed error messages to illustrate the problem. Also give complete details of events and circumstances leading up to the failure. Include your name, address, and phone number.

If possible pack all products in their original boxes. If the original containers are not available, carefully pack each piece and provide plenty of packing material. This helps prevent additional damage to your product while in transit.

Appendix A

Connector Pin-Outs

8-Pin Docking Connector (standard)

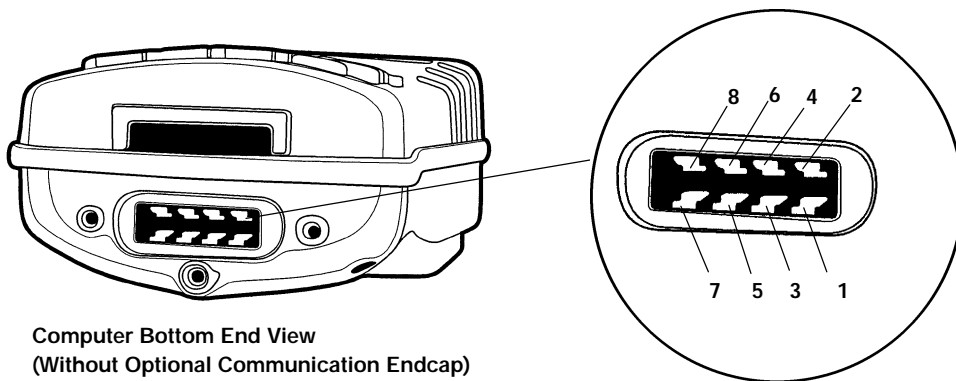

Computer Bottom End View
(Without Optional Communication Endcap)

<u>Pin</u>	<u>Signal</u>	<u>Function</u>
1	BCLK	Battery Clock
2	12.0 Volts	Charge Power
3	GND	Ground
4	BDAT	Battery Data
5	TXD	Transmit Data
6	RXD	Receive Data
7	RTS	Request To Send
8	CTS	Clear To Send

Figure A-1
8-Pin Docking Connector Pinouts

Optional Communication Adapter 9-Pin D-Sub Connector

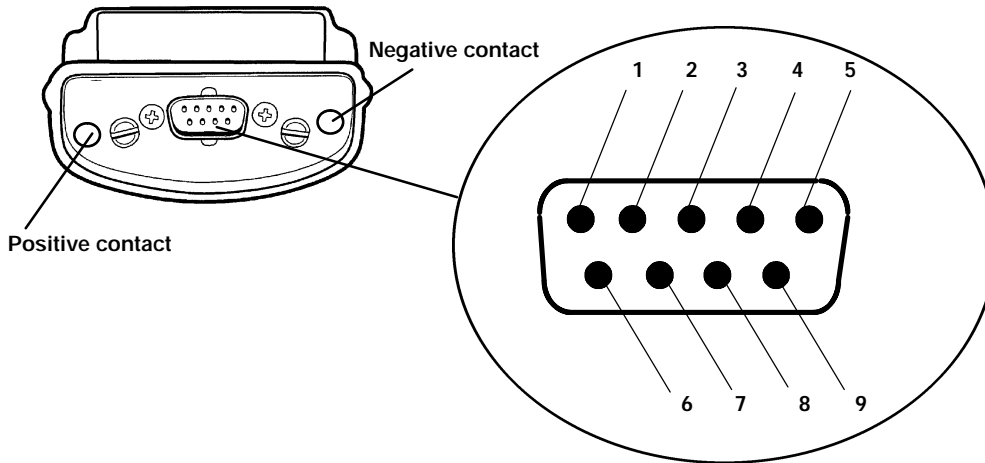

<u>Pin</u>	<u>Signal</u>	<u>Function</u>
1	No Connect	Data Carrier Detect
2	RXD	Receive Data
3	TXD	Transmit Data
4	looped to DSR	Data Terminal Ready
5	GND	Ground
6	looped to DTR	Data Send Ready
7	RTS	Request To Send
8	CTS	Clear To Send
9	Vcc	5 volts *

Figure A-2
9-Pin D-Sub Connector Pinouts

CAUTION: * 5 volts on pin 9 is for use with tethered scanners and printers only, this may damage modems.

Appendix B

NORAND[®] Utilities Program

.....

The NORAND[®] Utilities Program provides basic functions required to prepare your Hand-Held Computers for use.

Entry Point

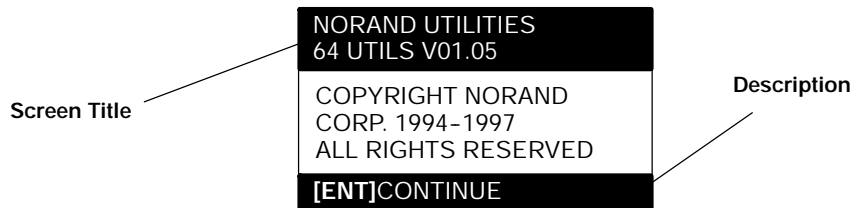

This screen appears after cold-booting the computer.

- **Screen Title:** (dark bar at the top) contains the application name, such as “NORAND UTILITIES”, and the specific screen name, such as MODEM PARAMETERS.
- **Key Description:** (dark bar at the bottom) contains “action” keys. Movement keys, such as arrows, are not shown.

Pop-Up Menus

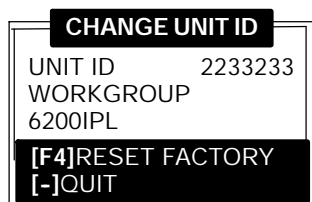

Pop-Up menus appear after a menu option. Press the number of an option you want to select; or press the **Y** or **B** keys to scroll through the list and press the **[ENT]** key to enter. Select one option each time.

Press the **[-]** key to exit a pop-up menu.

Drop-Down Lists



Drop-down lists provide suboptions under a pop-up menu. Press the number of a suboption, or press the **Y** or **B** keys to scroll through the list and press the **[ENT]** key to enter. Select one suboption each time.

Press the **[-]** key to exit a drop-down list.

Alphanumeric Fields

NETWORK PARAMETERS	
SERVER NAME	
I.U.N. INCORPORATED	
SERVER IP ADDRESS	123.123.123.123
CLIENT IP ADDRESS	123.123.123.123
RTR	0. 0. 0. 0
SUBNET MASK	0. 0. 0. 0
[-]QUIT	

If your computer has a numeric keyboard, enter alphanumeric data by pressing the **A** and " keys to scroll back and forth through the set of alphanumeric characters. After a character is selected, press the **[ENT]** key to enter that character. Press **[ENT]** again to move to the next field.

If your computer has an alphanumeric keyboard, press the characters, then press the **[ENT]** key to move to the next field.

Press **[ENT]** to save the entries and exit the menu. Press the **[-]** key to exit without saving the entries.

Title Screen

When you reboot or reset your computer, the Title Screen appears:

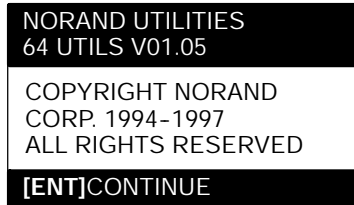

Press the **[ENT]** key to continue.

Language Selection

" **NOTE:** *The NORAND Utilities Program checks files for available language options. If no language resource files exist, you do **not** see this menu.*

If your application requires non-English languages, the Language Selection menu appears. English is the first option, followed by up to nine additional options:

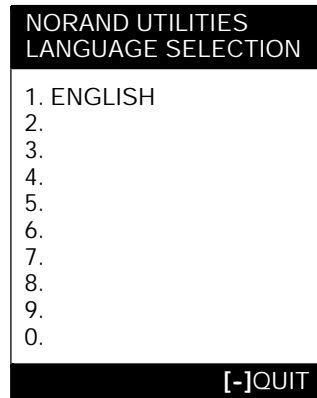

Press the number of a language, or press the **Y** or **B** keys to scroll through the list, then press the **[ENT]** key to enter. Press the **[-]** key to exit this menu.

Communications Menu

" **NOTE:** *The default is the NPCP RS-485 communication.*

" **NOTE:** *If your computer does not support any of the features listed, the following pop-up menu appears. Press the **[ENT]** key to continue:*



The Communications Menu appears after the Title Screen:

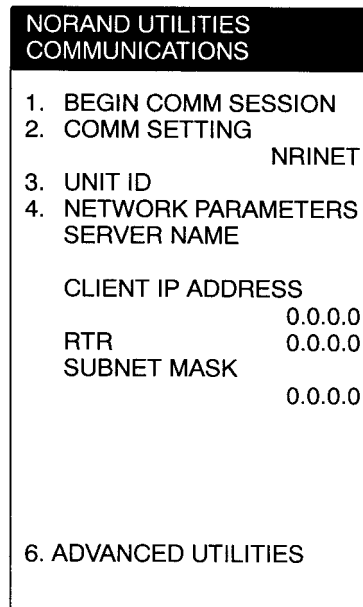

Option 1 BEGIN COMM SESSION

If you select this option, the computer repeats communications until successful or you press the [-] key.

" **NOTE:**

If you press the [-] key, this verification window appears:

```

ARE YOU SURE YOU
WANT TO STOP
COMMUNICATIONS
NOW?
[ENT]STOP
[-]RESUME
  
```

BEGIN COMM SESSION with NETWORK

If you select this option and Option **2. COMM SETTINGS** is set to NETWORK, this Communication Status menu appears:

```

NORAND UTILITIES
COMMUNICATIONS

COMM SETTINGS:
NRINET
SERVER NAME

CLIENT IP ADDRESS
                                0.0.0.0
RTR                             0.0.0.0
SIGNING ON
STATUS:                          20

[-]STOP COMM
  
```

While SIGNING ON is onscreen, STATUS: may appear with the status of the attempted connection. Refer to **Session Status** on page B-10 for meaning.

Following a successful session, NORAND Utilities executes the downloaded application. If the necessary program files are not found, this message window appears:

```

MISSING SYSTEM
FILES
[ENT]CONTINUE
    
```

If the session is unsuccessful, LAST SESSION appears with the failure status, such as "T803."

```

NORAND UTILITIES
COMMUNICATIONS

COMM SETTINGS:
  NRINET
  SERVER NAME

  CLIENT IP ADDRESS
                0.0.0.0
  RTR           0.0.0.0
SIGNING ON
STATUS:        20

LAST SESSION   T803
INVALID HOST NAME
OR IP ADDRESS

[-]STOP COMM
    
```

BEGIN COMM SESSION with MODEM/DIRECT

If you select this option and Option **2. COMM SETTINGS** is set to MODEM/DIRECT, this Communication Status menu appears:

```

NORAND UTILITIES
COMMUNICATIONS

COMM SETTINGS:
MODEM/DIRECT
MODEM TYPE
      NM2400/NM2400A
PROTOCOL BPS FMT
TTY      2400 8N1
AUTO ANSWER
                        NO

CONFIGURING

LAST SESSION:      T289
NO RESPONSE FROM
MODEM

[-]STOP COMM

```

" NOTE:

The computer may stay at the "CONFIGURING" screen for about 20 seconds if a modem is not detected.

If the session is unsuccessful, LAST SESSION appears with the failure status, such as "T289."

BEGIN COMM SESSION with ACCESSORY CARD

If you select this option and Option **2. COMM SETTINGS** is set to ACCESSORY CARD, the system attempts to execute the application from a PC card. If the "MISSING SYSTEM FILES" message appears, press the **[ENT]** key to continue.

BEGIN COMM SESSION with INTERSERVER

If you select this option and Option **2. COMM SETTINGS** is set to INTERSERVER, this Communication Status menu appears:

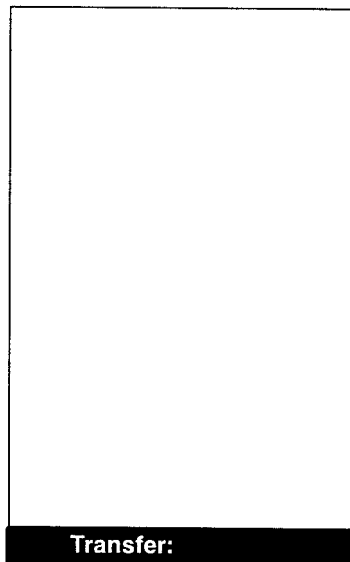

Press the [-] key to exit this screen.

Session Status

The first single character code ("T") is the session status, which applies to all COMM SETTINGS. There are five statuses possible:

- .. **"G"** Good session
- .. **"T"** Unexpected end of transmission
- .. **"H"** Incorrect file header encountered
- .. **"F"** File error encountered
- .. **"L"** Telecommunications aborted before first file header received

The three digit number ("289") indicates the specific protocol error. These error codes apply when COMM SETTINGS is set to NPCP RS-485 or NPCP RS-232:

- "0" No error
- "1" MININET.EXE not installed
- "6" User aborted communications by pressing [-]
- "11" Invalid parameter specified in control file

" NOTE:

The following values indicate an error returned by MININET.EXE. 100 is added to the error returned by MININET.EXE to avoid conflict with other defined errors.

- "101" Illegal buffer length
- "103" Invalid command
- "105" Command timed out
- "106" Message incomplete
- "108" Illegal local session number
- "109" No resource available
- "110" Session closed
- "111" Command canceled
- "113" Duplicate name in local name table
- "114" Name table is full
- "115" Name is deregistered, command complete
- "117" Local session table full
- "118" Session open rejected
- "119" Invalid name number
- "120" No answer
- "121" Name not found
- "122" Name in use on remote adapter
- "123" Name deleted
- "124" Session ended abnormally
- "125" Name conflict
- "126" Incompatible remote device
- "133" Network interface is busy
- "134" Too many commands outstanding
- "135" Invalid LAN adapter number
- "136" Command completed while cancel occurring

- "138"** Command not valid to cancel
- "164"**-**"179"** Unusual network condition
- "180"**-**"354"** Adapter malfunction

These error codes apply when COMM SETTINGS is set to MODEM/DIRECT and PROTOCOL is set to TTY:

- "0"** No error
- "6"** [-] key pressed, aborting communications
- "11"** Invalid parameter specified in control file
- "23"** End of transmission
- "101"** Line lost
- "102"** Parity error
- "103"** Character gap too long
- "104"** Data loss
- "105"** Excessive NAKs (no acknowledgements)
- "106"** Block count error
- "107"** Block check error
- "108"** Block framing error
- "109"** Control character error
- "2xx"** Modem error
 - "xx"** Hayes response code, or code defined by program:
 - "86"** Error sending command to modem
 - "87"** Expected numeric response not numeric
 - "88"** Invalid response format
 - "89"** No significant response from modem
 - "97"** COM port disabled by system due to low battery or removal of PC card modem.
 - "98"** Unrecognized English response
 - "99"** Memory allocation error

These error codes apply when COMM SETTINGS is set to NOVELL NETWARE:

- "0" No error
- "6" User aborted communications by pressing [-] key.
- "100" Connection to host failed. Verify network connection, verify that PENKEY login name exists on host.
- "101" Could not access include file. Verify existence of include file on host.
- "102" Could not allocate needed memory.

These error codes apply when COMM SETTINGS is set to NRINET:

- "0" No error
- "6" User aborted communications by pressing [-] key.
- "800" PC TCP/IP kernel is missing.
- "801" Invalid client IP address. Make sure the entry for CLIENT IP ADDRESS is correct, or make sure the DHCP server is running.
- "802" Invalid Service or Service Type, or invalid port number.
- "803" Invalid host name or IP Address. Make sure the entry for SERVER NAME is correct, and that the server is running.
- "804" Could not create socket. Check all cables and network connections.
- "806" Block sent was incomplete or block received was incomplete.
- "807" Client and server negotiation failed.
- "808" Server specified an unsupported block size.
- "809" Invalid buffer pointer.
- "810" All server connections are already in use. Try again later.

- "811"** Timeout while sending data. Connection to remote machine dropped. Make sure the host is still running, and check all cables and network connections.
- "812"** Timeout while receiving data. Connection to remote machine dropped. Make sure the host is still running, and check all cables and network connections.
- "935"** Operation would block.
- "939"** Destination address required.
- "940"** Message too long.
- "948"** Address already in use.
- "950"** Network is down.
- "951"** Network is unreachable.
- "952"** Network dropped connection or reset.
- "954"** Connection reset by peer.
- "955"** No buffer space available.
- "960"** Connection timed out.
- "961"** Connection refused.
- "962"** Too many levels of symbolic links.
- "963"** File name is too long.
- "964"** Host is down.
- "965"** Host is unreachable.
- "966"** Directory not empty.

These error codes apply when COMM SETTINGS is set to TFTP:

- "0"** No error.
- "1"** TCP/IP kernel is not loaded.
- "6"** User aborted communications by pressing [-] key.
- "201"** TFTP.EXE failed.
- "202"** TFTP.EXE not found.
- "203"** Unknown server.
- "204"** Remote file name is invalid.
- "205"** Local file name is invalid.
- "206"** File not found on server.
- "207"** Timeout.

Option 2 COMM SETTING

If you select this option, the Communications Settings drop-down list appears:

- | |
|--|
| <ol style="list-style-type: none"> 1. NETWORK. . . 2. MODEM/DIRECT 3. ACCESSORY CARD 4. HANDHELD 5. INTERSERVER |
|--|

Press the number of a communications settings, or press the **Y** or **B** keys to scroll through the list, then press the **[YES]** key to enter.

Suboption 1 NETWORK

If you select this suboption, a drop-down list appears with various networks:

- | |
|---|
| 1. NETWORK. . . |
| <ol style="list-style-type: none"> 1. NPCP RS485 2. NPCP RS232 3. NRINET 4. TCP/IP BOOTP 5. NOVELL NETWARE |

Press the number of a network or press the **Y** or **B** keys to scroll through the list, then press the **[ENT]** key to enter. The computer returns to the Communications Menu with the selected network assigned to Option **2. COMM SETTING**. See a sample menu on page B-6.

Press the **[-]** key to exit this drop-down list. The computer takes you to the Communications Menu.

Suboption 2 MODEM/DIRECT

If you select this suboption, the computer returns to the Communications Menu with the MODEM/DIRECT option assigned to Option **2. COMM SETTING:**

```
NORAND UTILITIES
COMMUNICATIONS

1. BEGIN COMM SESSION
2. COMM SETTING
   MODEM/DIRECT
3. UNIT ID
4. MODEM PARAMETERS
   MODEM TYPE
     NM2400/NM2400A
   PROTOCOL BPS FMT
   TTY      2400 8N1
   AUTO ANSWER          NO
5. PHONE NUMBER
     9...131369282

6. ADVANCED UTILITIES
```

Suboption 3 ACCESSORY CARD**Suboption 5 INTERSERVER**

If you select either of these suboptions, the computer returns to the Communications Menu with ACCESSORY CARD or INTERSERVER assigned to Option **2. COMM SETTING**.

NORAND UTILITIES COMMUNICATIONS	
1.	BEGIN COMM SESSION
2.	COMM SETTING ACCESSORY CARD
3.	UNIT ID
6.	ADVANCED UTILITIES

Suboption 4 HANDHELD

Option 3 UNIT ID

If you select this option, the Change Unit ID pop-up menu appears:

CHANGE UNIT ID	
UNIT ID	2233233
WORKGROUP	6200IPL
[F4]RESET FACTORY	
[-]QUIT	

Enter up to eight characters to change the Unit ID. Use the [**←SP**] key to backspace and use the [**CLR**] to restore the previous ID. Press the [**ENT**] key to save the new ID and return to the Communications Settings menu. Press the [**F4**] key to reset the ID to factory default. Press [-] to exit this pop-up menu.

Option 4 NETWORK PARAMETERS

Network Parameters appears as Option 4 when Option **2**. **COMM SETTINGS** is set to one of these three NETWORK options: NRINET, TFTP, or NOVELL NETWARE.

NETWORK PARAMETERS with NRINET

NETWORK PARAMETERS with TFTP

If you select this option and Option **2. COMM SETTINGS** is set to NRINET or TFTP, this Network Parameters pop-up menu appears:

NETWORK PARAMETERS				
SERVER NAME				
SERVER IP ADDRESS				
	0.	0.	0.	0
CLIENT IP ADDRESS				
	0.	0.	0.	0
RTR	0.	0.	0.	0
SUBNET MASK				
	0.	0.	0.	0
[-]QUIT				

If you have an alphanumeric keyboard, press the characters to the host name, then press the **[ENT]** key to save the entry and move to the next field.

If you have a numeric keyboard, use the **A** and **"** keys to scroll back and forth through the given set of alphanumeric characters. After a character is selected, press the **[ENT]** key to enter that character. Press **[ENT]** again to move to the next field. Press the **Y** or **B** keys to move between fields.

Press **[ENT]** to save the entries and exit the Network Parameters menu. Press the **[-]** key to exit without saving the entries.

NETWORK PARAMETERS with NOVELL NETWARE

If you select this option and Option **2. COMM SETTINGS** is set to NOVELL NETWARE, this frame type drop-down list appears:

- | |
|------------------|
| 1. 802.2 |
| 2. ETHERNET II |
| 3. 802.3 RAW |
| 4. 802.2 W/ SNAP |

Press the number of a frame type, or press the **Y** or **B** keys to scroll through the list and press the **[ENT]** key to enter. Press the **[-]** key to exit this drop-down list without changing the frame type.

Option 4 MODEM PARAMETERS

Modem Parameters appears as Option 4 when Option **2. COMM SETTINGS** is set to MODEM/DIRECT.

If you select this option, the Modem Parameters pop-up menu appears.

- | MODEM PARAMETERS | |
|------------------|----------------|
| 1. MODEM TYPE | |
| | NM2400/NM2400A |
| 2. PROTOCOL | TTY |
| 3. BPS RATE | 2400 |
| 4. DATA FORMAT | 8N1 |
| 5. AUTO ANSWER | - |
| [-]DONE | |

Press the number of a modem parameters option, or press the **Y** or **B** keys to scroll through the list, then press the **[ENT]** button to enter.

Suboption 1 MODEM TYPE

If you select this suboption, a drop-down list appears with supported modem types. Press the **Y** or **B** keys to scroll through the list, then press the **[ENT]** button to enter.

- " If you select drop-option **OTHER EXTERNAL** or **OTHER INTERNAL**, the Modem Init String pop-up menu appears:

MODEM INIT STRING	
ATE0V0Q0&M0&S1&C1& D0&R/QX0L1	
[F2]TEST STRING	
[ENT]OK	[-]QUIT

- a. Enter the initialization string of the modem you are using. Refer to your modem's reference manual for information.

" **NOTE:** Use **A** and " keys on numeric keyboards to scroll the alphanumeric character set.

" **NOTE:** If you leave this menu blank, a string is not saved.

- b. Press the **[ENT]** key to enter the string or press the **[-]** key to exit this pop-up menu.

" **NOTE:** *Testing the modem initialization string is optional.*

- " To test the modem string, do the following:
 - a. Press the **[F2]** key. The computer replies with "PLEASE WAIT" and tests the string:

```

MODEM INIT STRING
ATE0V0Q0&M0&S1&C1&
D0&R/QX0L1
PLEASE WAIT . . .
[F2]TEST STRING
[ENT]OK      [-]QUIT
    
```

Momentarily, the computer displays the modem's response:

```

MODEM INIT STRING
ATE0V0Q0&M0&S1&C1&
D0&R/QX0L1
RESULT:  97
[F2]TEST STRING
[ENT]OK      [-]QUIT
    
```

" **NOTE:** *Zero indicates the modem was successfully configured. Any other value indicates an error. See page B-12 for a list of modem errors defined by this program. If this is a NORAND modem, contact the Norand Customer Response Center at 1-800-221-9236. If this is **not** a NORAND modem, contact your modem supplier.*

- b. Press the **[ENT]** key to update the modem initialization string. The computer returns to the Modem Parameters pop-up menu with OTHER EXTERNAL or OTHER INTERNAL assigned.

Suboption 2 PROTOCOL

If you select this suboption, a drop-down list of various protocols appears:

- | |
|-----------|
| 1. TTY |
| 2. YMODEM |

Press the number of a protocol, or press the **Y** or **B** keys to scroll through the list, then press the **[ENT]** key to enter. The computer returns to the Modem Parameters pop-up menu with the selected protocol assigned.

Press the **[-]** key to exit this drop-down list.

Suboption 3 BPS RATE

If you select this suboption, the BPS Rate drop-down list appears with various bits per second (BPS) rates:

- | | |
|----|--------|
| 1. | 1200 |
| 2. | 2400 |
| 3. | 4800 |
| 4. | 9600 |
| 5. | 19200 |
| 6. | 38400 |
| 7. | 57600 |
| 8. | 115200 |

Press the number of a BPS rate, or press the **Y** or **B** keys to scroll through the list, then press the **[ENT]** key to enter. The computer returns to the Modem Parameters pop-up menu with the selected BPS rate assigned.

Press the **[-]** key to exit this drop-down list.

Suboption 4 DATA FORMAT

If you select this suboption, the Data Format drop-down list appears:

1. 8N1
2. 7E1

Press the number of a data format, or press the **Y** or **B** keys to scroll through the list, then press the **[ENT]** key to enter. The computer returns to the Modem Parameters pop-up menu with the selected data format assigned.

Press the **[-]** key to exit this drop-down list.

Suboption 5 AUTO ANSWER

This suboption is not supported at this time.

Option 5 PHONE NUMBER

If you select this option, the Phone Number pop-up menu appears:

PHONE NUMBER
9...13193693282
[.] DIALING PAUSE
[ENT] OK [-] QUIT

Enter up to 16 characters. Use the **[←SP]** key to backspace; use the **[CLR]** to reset to the previous phone number, and press **[.]** to insert a dialing pause command (“,”).

Press the **[ENT]** key to save the new phone number and return to the Communications Settings menu.

Press the **[-]** key to exit this pop-up menu.

Option 6 **ADVANCED UTILITIES**

If you select this option, the Advanced Utilities menu appears:

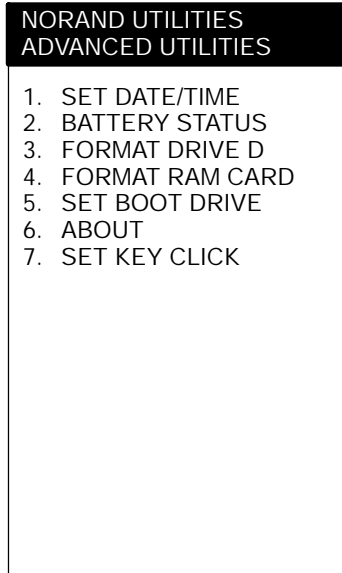

Press the number of an advanced utility option, or press the **Y** or **B** keys to scroll through the list, then press the **[ENT]** key to enter.

Suboption 1 SET DATE/TIME

If you select this suboption, the Set Date/Time pop-up menu appears:

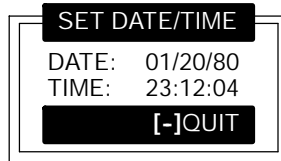

Enter numbers for the month, day, year (1980-2079), hour, minute, and second (up to 23:59:59). Press the **[ENT]** key after each entry. An incorrect entry causes the computer to default to the initial number. Press the **[-]** key to exit this pop-up menu.

Suboption 2 BATTERY STATUS

Use this suboption to check battery status. The Battery Status screen appears when you select this suboption:

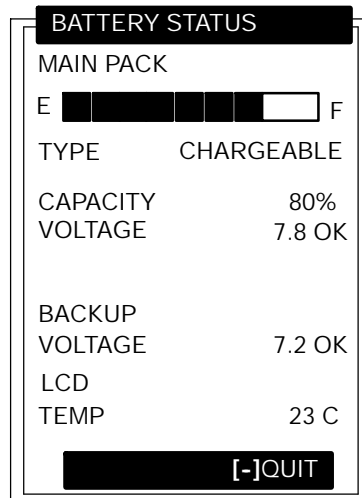

- " The battery fuel gauge displays the battery capacity level in black from left to right.
- " The capacity range that will display is 5-100%. If the capacity is less than 5% no operation of your computer will occur until you have recharged the battery to obtain at least 10% of its capacity.
- " Battery type is chargeable for rechargeable battery pack.
- " The voltage range is 6-8.4 volts.
- " The backup battery voltage will range from 6-11 volts. Below 7 volts indicates a mostly discharged backup battery. Between 7-8 volts the backup battery could be in any charged state. Between 8-11 volts is a mostly charged backup battery and good for at least 100 hours of backup support.
- " LCD temperature displays in celcius and measures the outside temperature of the display. Temperatures less than -4_F (-20_C) or greater than +122_F (+50_C) can cause faulty display operation.

Suboption 3 FORMAT DRIVE D

If you select this suboption, the Format RAM Drive pop-up menu appears:

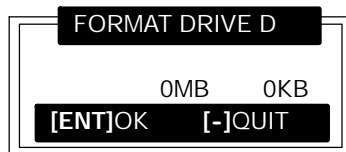

Enter the total MB and KB for the RAM drive.

" **NOTE:** *A zero in both fields deletes the RAM drive.*

Press the **[ENT]** key after each entry. A pop-up verification appears:

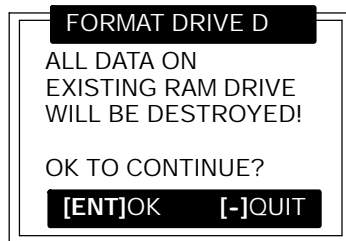

Press the **[ENT]** key to continue. Press the **[-]** key to exit the menu.

Suboption 5 SET BOOT DRIVE

If you select this suboption, the Set Boot Drive pop-up menu appears:

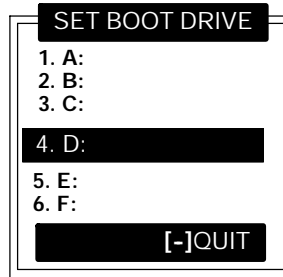

" NOTE:

The current default drive is highlighted in this menu.

Press the number of a boot drive, or press the **Y** or **B** keys to scroll through the list, then press the **[ENT]** key to enter. The computer returns to the Advanced Utilities menu.

Press the **[-]** key to exit this pop-up menu.

Suboption 6 ABOUT

If you select this suboption, the version of keyboard controller and BIOS displays.

Press the **[-]** key to exit this pop-up menu.

Suboption 7 SET KEY CLICK

If you select this suboption, the Set Key Click pop-up menu appears:

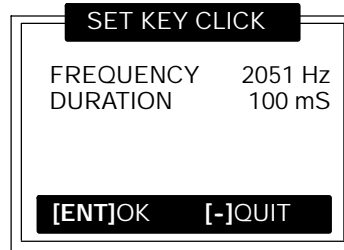

```
SET KEY CLICK
FREQUENCY 2051 Hz
DURATION 100 mS
[ENT]OK [-]QUIT
```

Press the ▲ or ▼ keys to select the frequency of the key click or the length of time to hear the key click. Enter the new frequency and or the new duration settings.

Press the **[ENT]** key after each entry. A pop-up verification appears.

Press the **[ENT]** key to continue. Press the **[-]** key to exit the menu.

Appendix C

Keyboard Overlays

41-Key DOS/PC

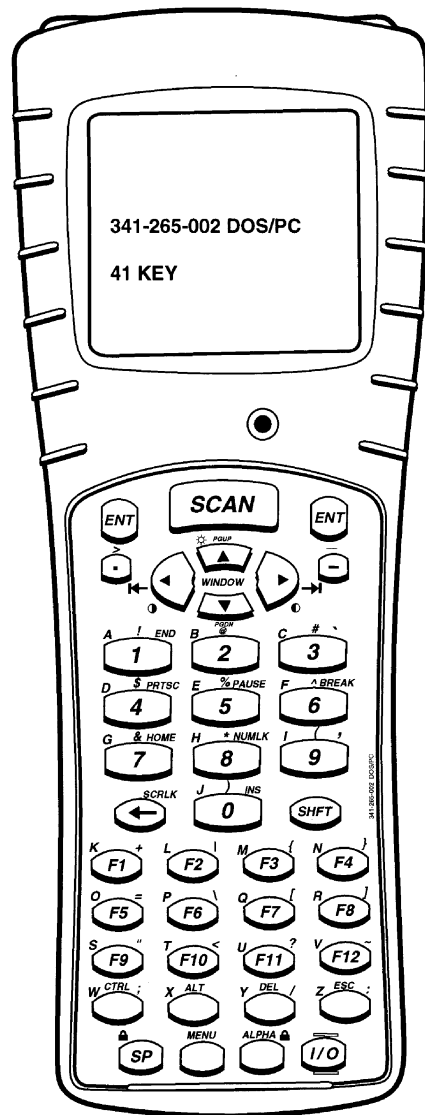

51-Key DOS/PC

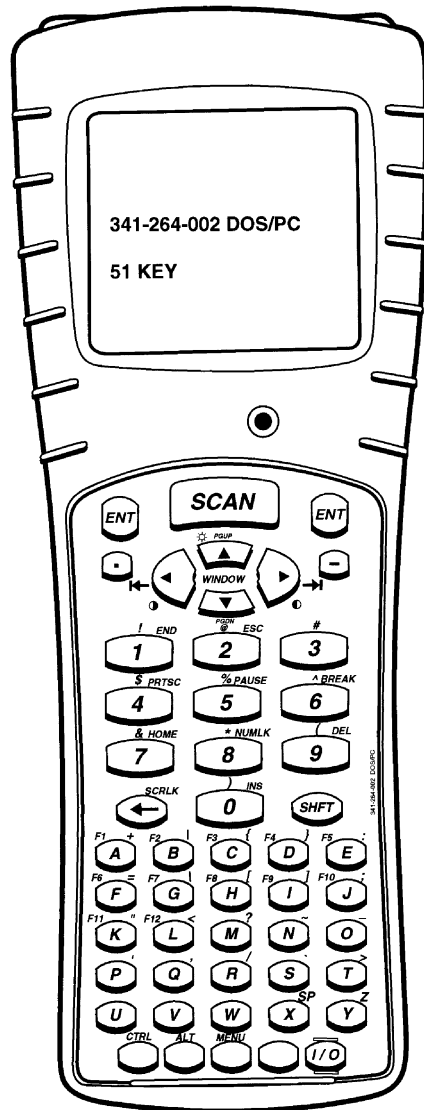

41-Key 5250

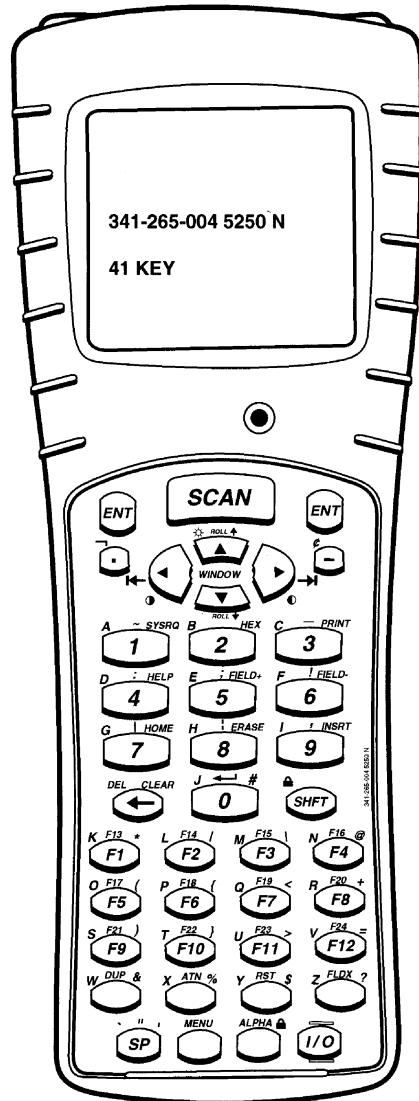

51-Key 5250

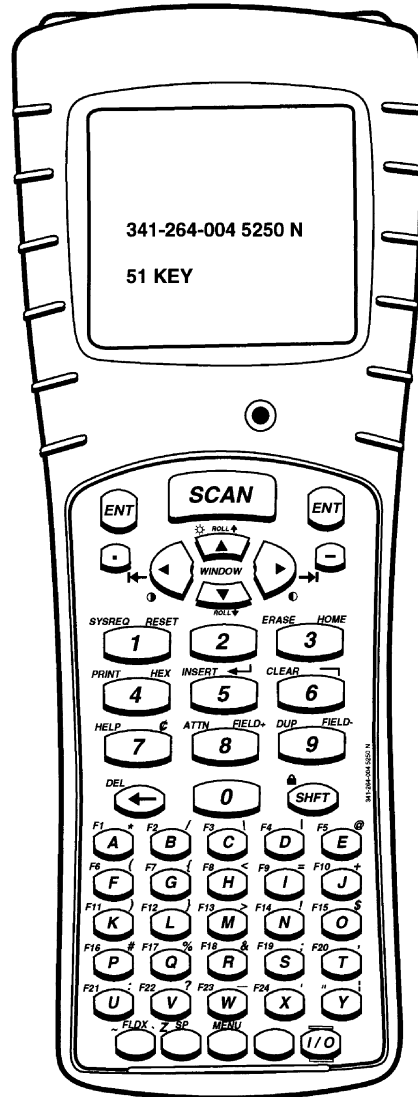

41-Key 3270

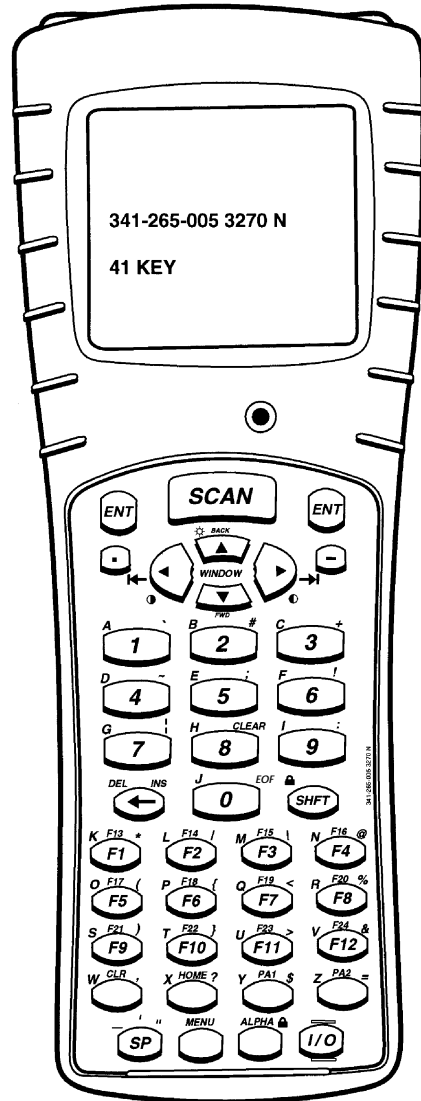

51-Key 3270

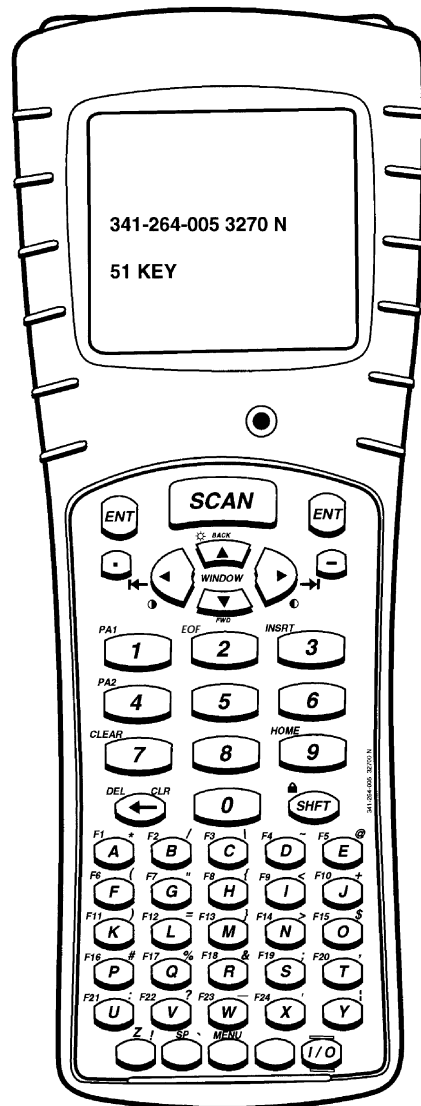

41-Key VT220

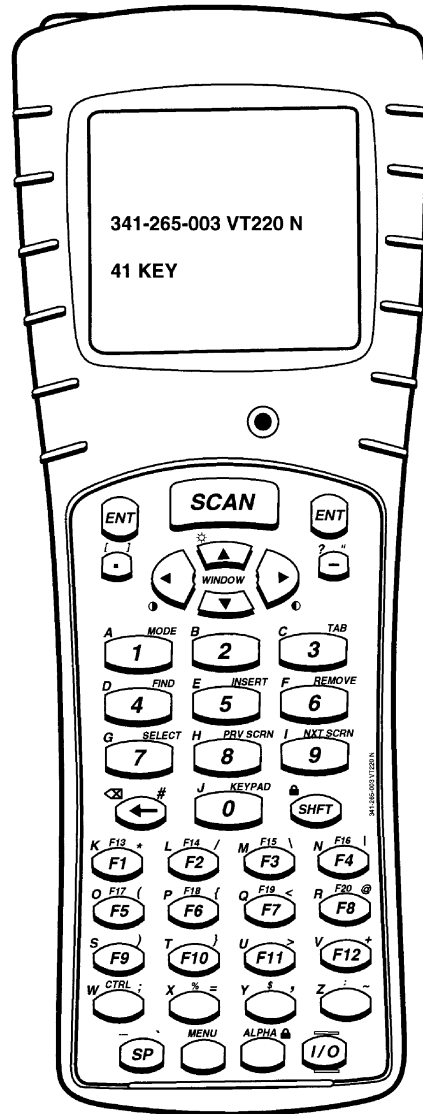

51-Key VT220

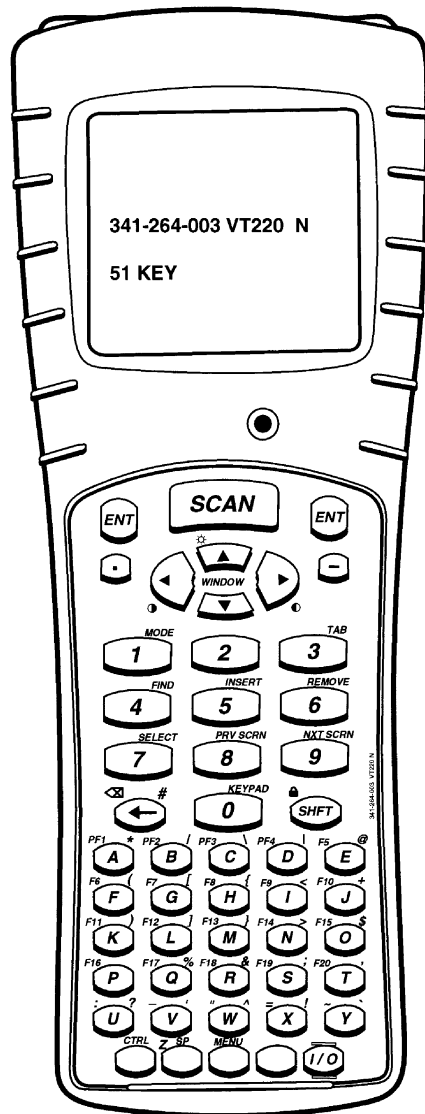

41-Key NATIVE

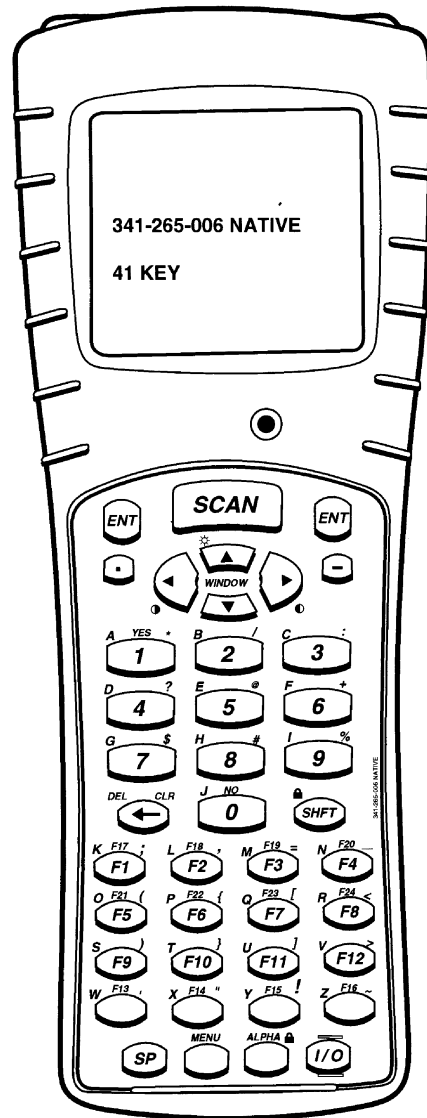

51-Key NATIVE

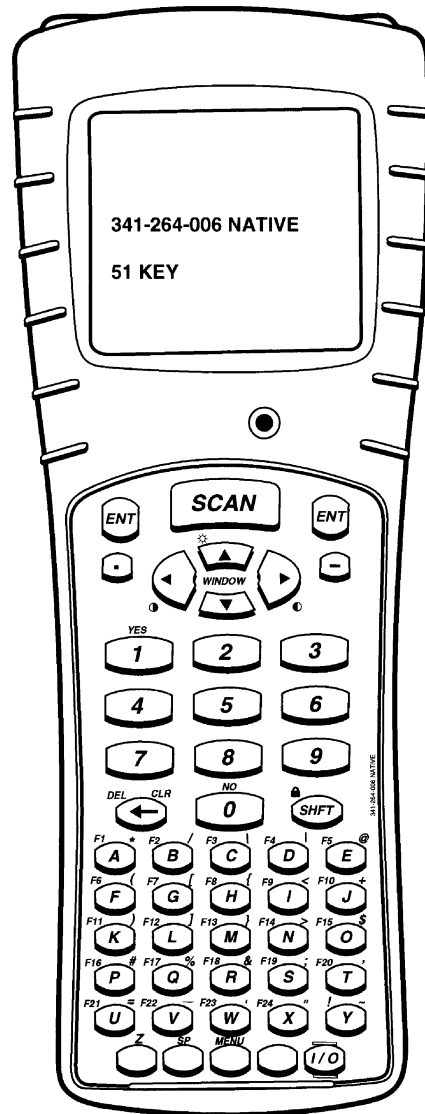

INDEX

NUMBERS

3210 emulation, 7-29
3270 options, 7-28
41-Key 3270 overlay, C-6
41-Key 5250 overlay, C-4
41-Key DOS/PC overlay, C-2
41-Key NATIVE overlay, C-10
41-Key VT220 overlay, C-8
51-Key 3270 overlay, C-7
51-Key 5250 overlay, C-5
51-Key DOS/PC overlay, C-3
51-Key NATIVE overlay, C-11
51-Key VT220 overlay, C-9
5250 options, 7-27
900 MHz radio option
 NIC model names, 5-37
 specifications, 5-37

A

Adjustable handstrap, 5-33
Adjustable wrist strap, 5-33
Alpha keys, 5-11
Alphabetic keys, 5-11
Annunciator description, 5-16
Annunciator meaning, 5-16
Annunciator screen position,
 5-15
Attaching a scanner, 6-22
Automatic suspend, 6-15

B

Backlight, 5-19
 setting, 5-19
Backspace key, 5-11

Backup battery, 5-26, 6-13
 fully charging, 6-13
Bar code parms, 7-17
Batch terminal operation, 5-28
Batteries, 5-24
 backup, 5-24, 5-26
 nickel-metal hydride, 5-26
 main, 5-24
 care, 8-1
 installing, 6-5
 lithium ion, 5-24
 low battery indication, 8-1
 removing, 6-6
 replacing, 6-6
Battery, status, utilities menu,
 B-26
Battery capacity
 icons, 5-18, 6-8, 7-5, 8-1
 low capacity levels, 5-18, 6-8,
 7-5, 8-1
 low level status, 5-18, 6-8, 7-5,
 8-1
Battery capacity icons, 5-18, 6-8,
 7-5, 8-1
Battery charging errors, 6-12
Battery doesn't bring computer
 up, 8-4
Battery gas
 icons for levels, 5-18, 6-8, 7-5,
 8-1
 low capacity levels, 5-18, 6-8,
 7-5, 8-1
 low level readings, 5-18, 6-8,
 7-5, 8-1
Battery management, 5-23
 self discharge, 5-23
Battery pack, charge level, 5-18,
 6-8, 7-5, 8-1
Battery pack loses charge level,
 8-4

Beeper setup, 7-9, 7-42
 error tone, 7-44
 key click, 7-43
Blue shift key, 5-12
Buzzer, 5-23

C

Can not scan I 2 of 5, 8-8
Center cursor, 7-39
Charge jack, 5-30
Charge level icons, 5-18, 6-8,
 7-5, 8-1
Charged battery pack doesn't
 last, 8-5
Charger indicators, 6-10
 combination of blinking red
 and orange, 6-10
Charging, first time, 6-1
Charging backup battery, 6-13
Charging main battery, 6-9
 using a multipack charger,
 6-9
 using a single pack charger,
 6-9
 using a vehicle dock, 6-9
Charging the scanner handle
 batteries, 6-21
Cleaning, 8-3
 case, 8-3
 display, 8-3
 docking connector, 8-3
 keyboard, 8-3
Cold start, 7-36
Communication adapter, 5-29
Compliances
 900 MHz NIC, 5-37
 Proxim 2.4 GHz NIC, 5-39
Computer displays, L, emits five
 second beep, 8-4
Computer doesn't suspend, 8-6

- Computer doesn't turn on
 - when [I/O] key is pressed, 8-5
 - when put in dock, 8-6
- Computer reboots, when battery pack is installed, 8-5
- Computer resets, replacing or checking main battery, 8-6
- Computer shuts down during use, 8-6
- Computer turns off, opening battery latch door, 8-6
- Connectors, A-1, A-2
 - 8-pin docking connector, A-1
 - 9-pin communication adapter, A-2
- Corner mode, 7-40
- Coverage area
 - 900 MHz NIC, 5-37
 - Proxim 2.4 GHz NIC, 5-39
- Cursor mode, 7-35

- D**
- DASI scanner HW initialization failed, 8-9
- Data rates
 - 900 MHz NIC, 5-37
 - Proxim 2.4 GHz NIC, 5-39
- Data stream, 7-26
- Desktops, 5-38
- Diagnostic EEPROM, 5-27
- Diagnostic information, 8-10
- Direct sequence, 5-37
- Display, adjusting the contrast, 5-19
- Display annunciators, 5-16
 - terminal emulation, 7-3
 - position 0, 7-3
 - position 1, 7-3
 - position 2, 7-4
 - position 3, 7-4
 - position 4, 7-4
 - position 5-8, 7-5
- Display message meanings, 5-16
- Display messages, 5-16
- Display options, 7-34
 - cursor mode, 7-35
- Display test, 7-47
- Displays bad tcom message, 8-6
- Downloading programs, 6-14

- E**
- Endcap, 5-29
- ENT key, 5-10
- Enter key, 5-10
- Error codes, 6-12
- Error tone, 7-44
- Exit emulation and return to DOS, 7-56
- Exit menus, 7-10, 7-53
- Extended commands (CMDS), 7-26
- External scanner, 6-22
- External scanner connector, 5-29

- F**
- First time use, 6-1
- FM radio, 5-28
- Four finger reset, 6-2
- Frequency bands
 - 900 MHz, 5-37
 - Proxim 2.4 GHz, 5-39
- Frequency hopping, 5-39

- G**
- Green shift [SHFT] key, 5-12

- H**
- Handstrap, 5-20
- Histogram opts test, 7-51
- Host view size, 7-25

- I**
- I/O key, 5-20
- Infra-red port, 5-23
- Installing scanner handle, 6-19
- Installing scanner handle with battery pack, 6-20
- Integrated scanner, 5-28, 6-17
- Interleaved 2 of 5, trouble setting lengths, 8-8
- Internal radio, 5-28
- Internal scanner, 5-28
- IrDA port, 5-23
- ISA NIC, 5-38

- K**
- Key click, 7-43
- Key uppercase, 7-41
- Keyboard descriptions, 5-10
 - alpha, 5-11
 - backspace, 5-11
 - blue shift, 5-12
 - enter, 5-10
 - green shift, 5-12
 - I/O suspend and or resume, 5-20
 - minus, 5-10
 - number, 5-11
 - period, 5-10
 - scan, 5-10
 - scrolling arrows, 5-19
 - shift, 5-11
 - yellow shift, 5-12
- Keyboard features
 - 41-key keypad, 5-7
 - 51-key keypad, 5-7
- Keyboard opts, 7-53
- Keyboard test, 7-48
- Keypad options
 - 41-key keypad, 5-7
 - 51-key keypad, 5-7

- L**
- Labelling, rechargeable battery, 6-4
- Laptops, 5-38
- Lazy mode, 7-40
- LCD parms, 7-9, 7-37
 - key uppercase, 7-41
 - screen mode, 7-39

screen size, 7-38
 scroll window, 7-42
 setting annunciator location,
 7-41
 LEDs on battery don't match
 display, 8-5
 Length options, 7-22
 Line of sight
 900 MHz NIC, 5-37
 Proxim 2.4 GHz NIC, 5-39
 Locked mode, 7-41
 Long time to reboot, 8-7

M

Main battery, 6-5
 care, 8-1
 installing, 6-5
 low battery indication, 8-1
 Main menu, 7-6
 beeper setup, 7-9
 exit menus, 7-10
 LCD parms, 7-9
 more, 7-10
 set-up parms, 7-9
 tests, 7-10
 version info, 7-10
 Main menu 2
 keyboard opts, 7-53
 more, 7-53
 Save parms, 7-54
 session menu, 7-54
 Main product components, 5-4
 Memory Types, main, 5-26
 Memory types, flash ROM, 5-26
 Memory view test, 7-49
 Mini-ISA NIC
 2.4 GHz, 5-38
 900 MHz, 5-37
 Minus key, 5-10
 More, 7-10, 7-36, 7-53
 keyboard opts, 7-53
 Save parms, 7-54
 session menu, 7-54

N

Native, 7-33

NDIS driver, Proxim 2.4 GHz
 NIC, 5-39
 Network Device Interface Speci-
 fication driver. *See* NDIS
 driver
 Notebooks, 5-38
 Number keys, 5-11
 Numbers test, 7-52
 Numeric keys, 5-11

O

ODI driver
 900 MHz NIC, 5-37
 Proxim 2.4 GHz NIC, 5-39
 Open Data Link Interface driv-
 er. *See* ODI driver
 Opening main menu, 7-6
 Opening set-up parms menu,
 7-10
 Operating parameters, 7-6
 Output power, 5-37, 5-39

P

Packet driver test, 7-49
 Packet stats tests, 7-50
 Page mode, 7-40
 PEN*KEY 6100 Computer
 2.4 GHz NIC, 5-38
 900 MHz NIC, 5-37
 PEN*KEY 6400 Computer
 900 MHz NIC, 5-37
 Proxim 2.4 GHz NIC, 5-38
 PEN*KEY 6600 Computer
 2.4 GHz NIC, 5-38
 900 MHz NIC, 5-37
 Period key, 5-10
 Peripherals test, 7-45
 Power, output, 5-37, 5-39
 Power output, 5-37, 5-39
 Printer misses data, 8-9
 Programming flash, 6-14
 Protocol options, 7-24
 3210 emulation, 7-29
 3270 options, 7-28

5250 options, 7-27
 data stream, 7-26
 extended commands (CMDS),
 7-26
 host view size, 7-25
 native, 7-33
 VT220, 7-30
 Proxim 2.4 GHz radio option
 NIC model names, 5-38
 specifications, 5-39
 Proxim, Inc., 2.4 GHz NIC, 5-38

R

Radio, 5-28
 Radio #, 7-13
 Radio comm, 7-35
 Radio modules, 5-39
 Range
 900 MHz NIC, 5-37
 Proxim 2.4 GHz NIC, 5-39
 Rechargeable battery labelling,
 6-4
 Regulatory compliance
 900 MHz NIC, 5-37
 Proxim 2.4 GHz NIC, 5-39
 Removing scanner handle, 6-19
 Removing scanner handle with
 battery pack, 6-20
 Repair service, 8-11
 Replaceable nickel-metal hy-
 dride backup, 5-26
 Replacing the main battery
 pack, 6-6
 Resetting, 5-27
 RS232 test, 7-46
 Running TN.EXE does not dis-
 play data, 8-9

S

Save parms, 7-54
 Scan key, 5-10
 Scan key does not turn unit on,
 8-8
 Scan options, 7-18
 length options, 7-22

- Scanner
 - attaching a tethered scanner, 6-22
 - charging batteries, 6-21
 - using an integrated scanner, 6-17
 - Scanner handle, 5-31
 - attaching, 6-19, 6-20
 - Scanner modules, 5-39
 - Scanner test, 7-48
 - Scanner type, 7-17
 - Scanning, 5-39, 6-17
 - Screen annunciator location, 7-41
 - Screen mode, 7-39
 - center cursor, 7-39
 - corner mode, 7-40
 - lazy mode, 7-40
 - locked mode, 7-41
 - page mode, 7-40
 - Screen size, 7-38
 - Scroll window, 7-42
 - Scrolling arrows, 5-19
 - Session menu, 7-54
 - Set-up parms, 7-9
 - bar code parms, 7-17
 - cold start, 7-36
 - display options, 7-34
 - more, 7-36
 - protocol options, 7-24
 - radio #, 7-13
 - radio comm, 7-35
 - scan options, 7-18
 - scanner type, 7-17
 - Setting up
 - DOS application to handle tethered laser scanners, 6-25
 - LS3203 and 3603 serial scanner parameters, 6-25
 - terminal emulation to handle tethered scanners, 6-24
 - Shift functions, 5-13
 - rules for using, 5-13
 - using, 5-13
 - Shift keys, 5-11
 - blue, 5-12
 - green, 5-12
 - yellow, 5-12
 - Specifications, 5-35
 - 900 MHz NIC, 5-37
 - Proxim 2.4 GHz NIC, 5-39
 - Store and forward data transfer, 5-28
 - Suspend and or Resume key, 5-20
- T**
- Taking care of your batteries, 5-23
 - Terminal emulation, 5-28
 - Terminal emulation stations, radio modules, 5-39
 - Tests, 7-10, 7-45
 - display, 7-47
 - histrogram opts, 7-51
 - keyboard, 7-48
 - memory view, 7-49
 - numbers, 7-52
 - packet driver, 7-49
 - packet stats, 7-50
 - peripherals, 7-45
 - RS232, 7-46
 - scanner, 7-48
 - timed numbers, 7-52
 - Tethered scanner, 6-22
 - data doesn't show up, 8-7
 - wedge mode application dies scanning data, 8-7
 - Tethered scanners supported, 6-22
 - hardware considerations, 6-22
 - software considerations, 6-22
 - Throughput
 - 900 MHz NIC, 5-37
 - Proxim 2.4 GHz NIC, 5-39
 - Timed numbers test, 7-52
 - Troubleshooting, 8-4
 - Troubleshooting table, 8-4
 - Turning off, 6-15
 - automatic suspend, 6-15
 - Turning on, 6-15
 - Type II NIC, 5-38
 - Type III NIC
 - 900 MHz, 5-37
 - Proxim 2.4 GHz, 5-38
- U**
- Understanding the keyclicks, 6-16
 - Unpacking and inspecting, 5-2
 - Using the first time, 6-1
 - Using the scanner handle, 6-19, 6-20
 - Utilities program, B-1
 - alphanumeric fields, B-3
 - communications menu, B-6
 - communications menu options
 - option 6 ADVANCED UTILITIES, B-25
 - BEGIN COMM SESSION with ACCESSORY CARD, B-9
 - BEGIN COMM SESSION with INTERSERVER, B-10
 - BEGIN COMM SESSION with MODEM/DIRECT, B-9
 - BEGIN COMM SESSION with NETWORK, B-7
 - option 1 BEGIN COMM SESSION, B-7
 - option 2 COMM SETTING, B-15
 - option 4 MODEM PARAMETERS, B-20
 - option 5 PHONE NUMBER, B-24
 - option 3 UNIT ID, B-18
 - communications menu suboptions
 - about, B-29
 - ACCESSORY CARD, B-17
 - suboption 5 AUTO ANSWER, B-24
 - BATTERY STATUS, B-26
 - suboption 3 BPS RATE, B-23
 - suboption 4 DATA FORMAT, B-24
 - FORMAT DRIVE D, B-28
 - suboption 4 HANDHELD, B-17
 - INTERSERVER, B-17
 - suboption 1 MODEM TYPES, B-21

- option 4 NETWORK PARAMETERS, B-18
 - suboption 2 MODEM/DIRECT, B-16
 - suboption 3 ACCESSORY CARD, B-17
 - suboption 5 INTERSERVER, B-17
 - suboption 1 NETWORK, B-15
 - OTHER EXTERNAL, B-21
 - OTHER INTERNAL, B-21
 - suboption 2 PROTOCOL, B-23
 - suboption 5 REMOTE OPS, B-17
 - SET BOOT DRIVE, B-29
 - suboption 1 SET DATE/TIME, B-26
 - set key click, B-30
 - drop-down lists, B-2
 - language selection, B-5
 - network parameters
 - with NOVELL NETWARE, B-20
 - with NRINET or TFTP, B-19
 - pop-up menus, B-2
 - title screen, B-4
 - Utilities programs, B-1
- V**
- Version info, 7-10, 7-52
 - VT220, 7-30
- W**
- Will not scan bar code, 8-8
- Window scrolling arrows, 5-19**
- Wireless NICs**
- 900 MHz
 - model names, 5-37
 - specifications, 5-37
 - ISA, 5-38
 - mini-ISA
 - 2.4 GHz, 5-38
 - 900 MHz, 5-37
 - Proxim 2.4 GHz
 - model names, 5-38
 - specifications, 5-39
 - Type II, 5-38
 - Type III
 - 900 MHz, 5-37
 - Proxim 2.4 GHz, 5-38
- Y**
- Yellow shift key, 5-12

