

Product Name: BT board

Brand Name: Intermecc

Model No: INBT01

User's Guide

Introduction

INBT01 is a Bluetooth Module. This can be made to connect to other Bluetooth wireless devices by integrating the INBT01 module to the user's device for which Bluetooth functionality is targeted.

The module block diagram is shown Figure 1

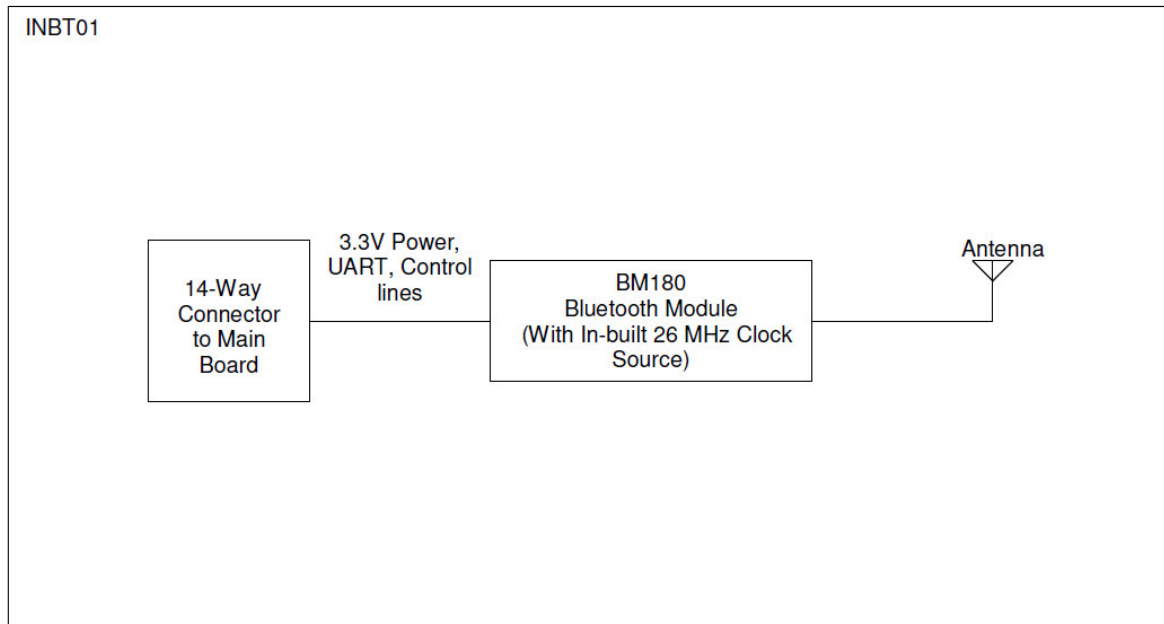

Figure 1: INBT01 - Block Diagram

It consists of 3 main portions

1. Antenna – Transmit/Receive RF Signal to/from other Bluetooth devices
2. BT Module – BM 180 – Used for Transmit/ Receive data to and from other Bluetooth devices
3. UART Interface – Interface to the external UART host

The BT Module is integrated to the printer by professional Installation, via the FFC which contains the UART interface to the host CPU, apart from some GPIO lines. It is a 14-pin connector as shown in photo in Figure 2.

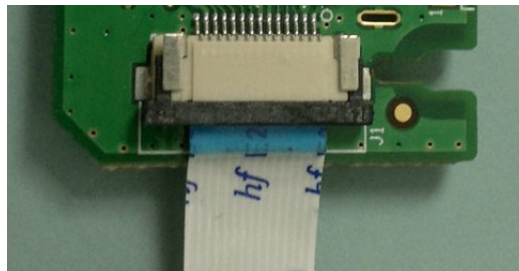

Figure 2: UART Interface - 14 Pin Connector

The Pin assignment is listed in Table 1.

1	Ground	2	Power, 3.3V
3	Data_Exit	4	Host_Wake
5	Host_Sleep	6	BT_LED
7	Ground	8	CMD_Data
9	UART_RTS	10	UART_TX
11	UART_CTS	12	UART_RX
13	Power, 3.3V	14	Ground

Table 1.Connector Pin-out

Specifications

Product Name	BT board
Model Number	INBT01
Standard	V2.1+EDR
Frequency Band	2.4GHz ~ 2.48GHz Unlicensed ISM band
Modulation Method	FHSS (GFSK, $\pi/4$ -DQPSK, 8DPSK)
Spread Spectrum	Frequency Hopping Spread Spectrum
Transfer rates (Max)	3Mbits/s
RF Output Power	3 dbm (Transmission Typical)
Antenna terminal	NA
Host Interface	UART 4 wire interface to host (Rx, Tx, RTS, CTS)
Supply Requirement	3.3 VDC, 0.1A
Dimension	41.5mm (L)X 23mm(W) X 5.5mm(H)
Operating Temperature	-10 ~ +50 °C
Storage Temperature	-20 ~ +60 °C
Humidity	10 ~ 90 % non-condensing
The Number of Channels & Channel Spacing	79 channel, 1Mhz spacing

Table 2: Specifications

Regulatory Information

The Bluetooth radio is designed to be interoperable with any Bluetooth technology product that is based on frequency hopping spread spectrum (FHSS) radio technology and complies with the Bluetooth Specification Version 2.1.

The Bluetooth radio, like other radio devices, emits radio frequency electromagnetic energy. The level of energy emitted by this device, however, is less than the electromagnetic energy emitted by other wireless devices such as mobile phones. The Bluetooth radio device operates within the guidelines found in radio frequency safety standards and recommendations. These standards and recommendations reflect the consensus of the scientific community and result from deliberations of panels and committees of scientists who continually review and interpret the extensive research literature. In some situations or environments, the use of a Bluetooth radio device may be restricted by the proprietor of the building or responsible representatives of the applicable organization. Examples of such situations include the following:

- Using the Bluetooth radio equipment onboard airplanes, or
- Using the Bluetooth radio equipment in any other environment where the risk of interference with other devices or services is perceived or identified as being harmful.

If uncertain of the policy that applies to the use of wireless devices in a specific organization or environment (an airport, for example), ask for authorization to use the Bluetooth radio device before turning it on.

Federal Communication Commission Interference Statement

This equipment has been tested and found to comply with the limits for a Class B digital device, pursuant to Part 15 of the FCC Rules. These limits are designed to provide reasonable protection against harmful interference in a residential installation. This equipment generates, uses and can radiate radio frequency energy and, if not installed and used in accordance with the instructions, may cause harmful interference to radio communications. However, there is no guarantee that interference will not occur in a particular installation. If this equipment does cause harmful interference to radio or television reception, which can be determined by turning the equipment off and on, the user is encouraged to try to correct the interference by one of the following measures:

- Reorient or relocate the receiving antenna
- Increase the separation between the equipment and receiver
- Connect the equipment into an outlet on a circuit different from that to which the receiver is connected
- Consult the dealer or an experienced radio/TV technician for help

FCC Caution: Any changes or modifications not expressly approved by the party responsible for compliance could void the user's authority to operate this equipment.

This device complies with Part 15 of the FCC Rules. Operation is subject to the following two conditions: (1) This device may not cause harmful interference, and (2) this device must accept any interference received, including interference that may cause undesired operation.

IMPORTANT NOTE: FCC Radiation Exposure Statement:

This equipment complies with FCC radiation exposure limits set forth for an uncontrolled environment. This equipment should be installed and operated with minimum distance 20cm between the radiator & your body.

This transmitter must not be co-located or operating in conjunction with any other antenna or transmitter.

This device is intended only for OEM integrators under the following conditions:

- 1) The antenna must be installed such that 20 cm is maintained between the antenna and users, and
- 2) The transmitter module may not be co-located with any other transmitter or antenna,

As long as 2 conditions above are met, further transmitter test will not be required. However, the OEM integrator is still responsible for testing their end-product for any additional compliance requirements required with this module installed

IMPORTANT NOTE: In the event that these conditions can not be met (for example certain laptop configurations or co-location with another transmitter), then the FCC authorization is no longer considered valid and the FCC ID can not be used on the final product. In these circumstances, the OEM integrator will be responsible for re-evaluating the end product (including the transmitter) and obtaining a separate FCC authorization.

End Product Labeling

This transmitter module is authorized only for use in device where the antenna may be installed such that 20 cm may be maintained between the antenna and users. The final end product must be labeled in a visible area with the following: "Contains FCC ID:EHA-INBT01"

Manual Information to the End User

The OEM integrator has to be aware not to provide information to the end user regarding how to install or remove this RF module in the user's manual of the end product which integrates this module.

The end user manual shall include all required regulatory information/warning as show in this manual.

Europe – EU Declaration of Conformity

This device complies with the essential requirements of the R&TTE Directive 1999/5/EC. The following test methods have been applied in order to prove presumption of conformity with the essential requirements of the R&TTE Directive 1999/5/EC:

- EN 60950-1: 2006:+A11:2009+A1:2010
Safety of Information Technology Equipment

- EN50371 : 2002
- Generic standard to demonstrate the compliance of low power electronic and electrical apparatus with the basic restrictions related to human exposure to electromagnetic fields (10 MHz - 300 GHz) -- General public

- EN 300 328 V1.7.1: 2006
- Electromagnetic compatibility and Radio spectrum Matters (ERM); Wideband Transmission systems; Data transmission equipment operating in the 2,4 GHz ISM band and using spread spectrum modulation techniques; Harmonized EN covering essential requirements under article 3.2 of the R&TTE Directive

EN 301 489-1 V1.8.1: 2008





Electromagnetic compatibility and Radio Spectrum Matters (ERM); ElectroMagnetic Compatibility (EMC) standard for radio equipment and services; Part 1: Common technical requirements

EN 301 489-17 V2.1.1 2009

Electromagnetic compatibility and Radio spectrum Matters (ERM); ElectroMagnetic Compatibility (EMC) standard for radio equipment and services; Part 17: Specific conditions for 2,4 GHz wideband transmission systems and 5 GHz high performance RLAN equipment

CE 0560

 Český (Czech)	<i>(Jméno výrobce)</i> tímto prohlašuje, že tento <i>(typ zařízení)</i> je ve shodě se základními požadavky a dalšími příslušnými ustanoveními směrnice 1999/5/ES.
 Dansk (Danish)	Undertegnede <i>(fabrikantens navn)</i> erklærer herved, at følgende udstyr <i>(udstyrets typebetegnelse)</i> overholder de væsentlige krav og øvrige relevante krav i direktiv 1999/5/EF.
 Deutsch (German)	Hiermit erkläre <i>(Name des Herstellers)</i> , dass sich das Gerät <i>(Gerätetyp)</i> in Übereinstimmung mit den grundlegenden Anforderungen und den übrigen einschlägigen Bestimmungen der Richtlinie 1999/5/EG befindet.
 Eesti (Estonian)	Käesolevaga kinnitab <i>(tootja nimi = name of manufacturer)</i> seadme <i>(seadme tüüp = type of equipment)</i> vastavust direktiivi 1999/5/EÜ põhinõuetele ja nimetatud direktiivist tulenevatele teistele asjakohastele sätetele.
 English	Hereby, <i>(name of manufacturer)</i> , declares that this <i>(type of equipment)</i> is in compliance with the essential requirements and other relevant provisions of Directive 1999/5/EC.
 Español (Spanish)	Por medio de la presente <i>(nombre del fabricante)</i> declara que el <i>(clase de equipo)</i> cumple con los requisitos esenciales y cualesquiera otras disposiciones aplicables o exigibles de la Directiva 1999/5/CE.
 Ελληνική (Greek)	ΜΕ ΤΗΝ ΠΑΡΟΥΣΑ <i>(name of manufacturer)</i> ΔΗΛΩΝΕΙ ΟΤΙ <i>(type of equipment)</i> ΣΥΜΜΟΡΦΩΝΕΤΑΙ ΠΡΟΣ ΤΙΣ ΟΥΣΙΩΔΕΙΣ ΑΠΑΙΤΗΣΕΙΣ ΚΑΙ ΤΙΣ ΛΟΙΠΕΣ ΣΧΕΤΙΚΕΣ ΔΙΑΤΑΞΕΙΣ ΤΗΣ ΟΔΗΓΙΑΣ 1999/5/EK.
 Français (French)	Par la présente <i>(nom du fabricant)</i> déclare que l'appareil <i>(type d'appareil)</i> est conforme aux exigences essentielles et aux autres dispositions pertinentes de la directive 1999/5/CE.
 Italiano (Italian)	Con la presente <i>(nome del costruttore)</i> dichiara che questo <i>(tipo di apparecchio)</i> è conforme ai requisiti essenziali ed alle altre disposizioni pertinenti stabilite dalla direttiva 1999/5/CE.
Latviski (Latvian)	Ar šo <i>(name of manufacturer / izgatavotāja nosaukums)</i> deklarē, ka <i>(type of equipment / iekārtas tips)</i> atbilst Direktīvas 1999/5/EK būtiskajām prasībām un citiem ar to saistītajiem noteikumiem.
Lietuvių (Lithuanian)	Šiuo <i>(manufacturer name)</i> deklaruoją, kad šis <i>(equipment type)</i> atitinka esminius reikalavimus ir kitas 1999/5/EB Direktyvos nuostatas.
 Nederlands (Dutch)	Hierbij verklaart <i>(naam van de fabrikant)</i> dat het toestel <i>(type van toestel)</i> in overeenstemming is met de essentiële eisen en de andere relevante bepalingen van richtlijn 1999/5/EG.
 Malti (Maltese)	Hawnhekk, <i>(isem tal-manifattur)</i> , jiddikjara li dan <i>(il-mudell tal-prodott)</i> jikkonforma mal-ħtiġijiet essenzjali u ma provvedimenti oħrajn rilevanti li hemm fid-Dirrettiva 1999/5/EC.
 Magyar	Alulírott, <i>(gyártó neve)</i> nyilatkozom, hogy a <i>(... típus)</i> megfelel a vonatkozó

(Hungarian)	alapvető követelményeknek és az 1999/5/EC irányelv egyéb előírásainak.
 Polski (Polish)	Niniejszym (<i>nazwa producenta</i>) oświadczam, że (<i>nazwa wyrobu</i>) jest zgodny z zasadniczymi wymogami oraz pozostałymi stosownymi postanowieniami Dyrektywy 1999/5/EC.
 Português (Portuguese)	(<i>Nome do fabricante</i>) declara que este (<i>tipo de equipamento</i>) está conforme com os requisitos essenciais e outras disposições da Directiva 1999/5/CE.
 Slovensko (Slovenian)	(<i>Ime proizvajalca</i>) izjavlja, da je ta (<i>tip opreme</i>) v skladu z bistvenimi zahtevami in ostalimi relevantnimi določili direktive 1999/5/ES.
Slovensky (Slovak)	(<i>Meno výrobcu</i>) týmto vyhlasuje, že (<i>typ zariadenia</i>) spĺňa základné požiadavky a všetky príslušné ustanovenia Smernice 1999/5/ES.
 Suomi (Finnish)	(<i>Valmistaja = manufacturer</i>) vakuuttaa täten että (<i>type of equipment = laitteen tyyppimerkintä</i>) tyypinen laite on direktiivin 1999/5/EY oleellisten vaatimusten ja sitä koskevien direktiivin muiden ehtojen mukainen.
 Svenska (Swedish)	Härmed intygar (<i>företag</i>) att denna (<i>utrustningstyp</i>) står i överensstämmelse med de väsentliga egenskapskrav och övriga relevanta bestämmelser som framgår av direktiv 1999/5/EG.

Industry Canada statement:

This device complies with RSS-210 of the Industry Canada Rules. Operation is subject to the following two conditions: (1) This device may not cause harmful interference, and (2) this device must accept any interference received, including interference that may cause undesired operation.

[French translation:](#)

Ce dispositif est conforme à la norme CNR-210 d'Industrie Canada applicable aux appareils radio exempts de licence. Son fonctionnement est sujet aux deux conditions suivantes: (1) le dispositif ne doit pas produire de brouillage préjudiciable, et (2) ce dispositif doit accepter tout brouillage reçu, y compris un brouillage susceptible de provoquer un fonctionnement indésirable.

=====

IMPORTANT NOTE: (For mobile device use)

Radiation Exposure Statement:

This equipment complies with IC radiation exposure limits set forth for an uncontrolled environment. This equipment should be installed and operated with minimum distance 20cm between the radiator & your body.

[French translation:](#)

NOTE IMPORTANTE: (Pour l'utilisation de dispositifs mobiles)

Déclaration d'exposition aux radiations:

Cet équipement est conforme aux limites d'exposition aux rayonnements IC établies pour un environnement non contrôlé. Cet équipement doit être installé et utilisé avec un minimum de 20 cm de distance entre la source de rayonnement et votre corps.

This device is intended only for OEM integrators under the following conditions: (For module device use)

- 1) The antenna must be installed such that 20 cm is maintained between the antenna and users, and
- 2) The transmitter module may not be co-located with any other transmitter or antenna,

As long as 2 conditions above are met, further transmitter test will not be required. However, the OEM integrator is still responsible for testing their end-product for any additional compliance requirements required with this module installed.

[French translation :](#)

Cet appareil est conçu uniquement pour les intégrateurs OEM dans les conditions suivantes:
(Pour utilisation de dispositif module)

- 1) L'antenne doit être installée de telle sorte qu'une distance de 20 cm est respectée entre l'antenne et les utilisateurs, et
- 2) Le module émetteur peut ne pas être coïmplanté avec un autre émetteur ou antenne,

Tant que les 2 conditions ci-dessus sont remplies, des essais supplémentaires sur l'émetteur ne seront pas nécessaires. Toutefois, l'intégrateur OEM est toujours responsable des essais sur son produit final pour toutes exigences de conformité supplémentaires requis pour ce module installé.

IMPORTANT NOTE:

In the event that these conditions can not be met (for example certain laptop configurations or co-location with another transmitter), then the Canada authorization is no longer considered valid and the IC ID can not be used on the final product. In these circumstances, the OEM integrator will be responsible for re-evaluating the end product (including the transmitter) and obtaining a separate Canada authorization.

[French translation:](#)

NOTE IMPORTANTE:

Dans le cas où ces conditions ne peuvent être satisfaites (par exemple pour certaines

configurations d'ordinateur portable ou de certaines co-localisation avec un autre émetteur), l'autorisation du Canada n'est plus considéré comme valide et l'ID IC ne peut pas être utilisé sur le produit final. Dans ces circonstances, l'intégrateur OEM sera chargé de réévaluer le produit final (y compris l'émetteur) et l'obtention d'une autorisation distincte au Canada.

=====

End Product Labeling

This transmitter module is authorized only for use in device where the antenna may be installed such that 20 cm may be maintained between the antenna and users. The final end product must be labeled in a visible area with the following: "Contains IC: 1223A-INBT01".

French translation:

Plaque signalétique du produit final

Ce module émetteur est autorisé uniquement pour une utilisation dans un dispositif où l'antenne peut être installée de telle sorte qu'une distance de 20cm peut être maintenue entre l'antenne et les utilisateurs. Le produit final doit être étiqueté dans un endroit visible avec l'inscription suivante: "Contient des IC: 1223A-INBT01"

=====

Manual Information To the End User

The OEM integrator has to be aware not to provide information to the end user regarding how to install or remove this RF module in the user's manual of the end product which integrates this module.

The end user manual shall include all required regulatory information/warning as show in this manual.

French translation:

Manuel d'information à l'utilisateur final

L'intégrateur OEM doit être conscient de ne pas fournir des informations à l'utilisateur final quant à la façon d'installer ou de supprimer ce module RF dans le manuel de l'utilisateur du produit final qui intègre ce module.

Le manuel de l'utilisateur final doit inclure toutes les informations réglementaires requises et avertissements comme indiqué dans ce manuel.

For Taiwan 警語：

經型式認證合格之低功率射頻電機，非經許可，公司、商號或使用者均不得擅自變更頻率、加大功率或變更原設計之特性及功能。

低功率射頻電機之使用不得影響飛航安全及干擾合法通信；經發現有干擾現象時，應立即停用，並改善至無干擾時方得繼續使用。前項合法通信，指依電信法規定作業之無線電通信。低功率射頻電機須忍受合法通信或工業、科學及醫療用電波輻射性電機設備之干擾。

Note: 1. 本模組於取得認證後將依規定於模組本體標示審驗合格標籤 2. 系統廠商應於平台上標示「本產品內含射頻模組:  XXXyyyLPDzzzz-x (NCC ID) 」字樣