

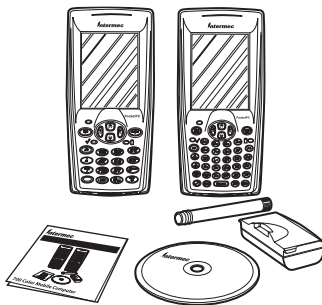

**Intermec**



Instructions  
Chinese Sim plified  
French Canadian  
Gem an  
Korean  
Portuguese  
Russian  
Spanish M exican



**700 Color**  
Mobile Computer  
Chinese Simplified  
French Canadian  
Gem an  
Korean  
Portuguese  
Russian  
Spanish Mexican

# Contents

- Features ..... 1
- Features (Simplified Chinese) ..... 4
- Features (French Canadian) ..... 7
- Features (German) ..... 10
- Features (Korean) ..... 13
- Features (Portuguese) ..... 16
- Features (Russian) ..... 19
- Features (Spanish Mexican) ..... 22

# Features

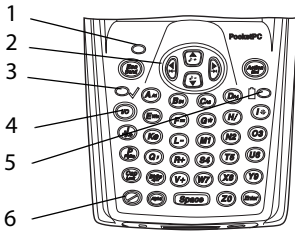

Alpha

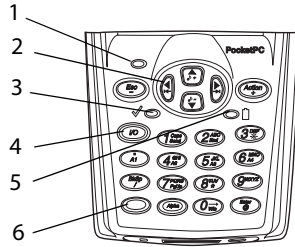

Numeric

- 1 Ambient light sensor
- 2 Navigational keys
- 3 Good Scan/Alpha mode
- 4 On/Off
- 5 Power status
- 6 White/Gold Shift plane (Alpha), Gold Shift plane (Numeric)

# Back View Features

- 1 Stylus
- 2 Scan/Record button
- 3 Speaker
- 4 IrDA
- 5 Battery release button

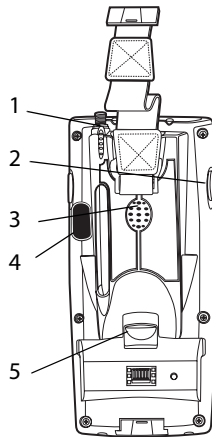

# Bottom View

- 1 Headset jack
- 2 Docking connector
- 3 Microphone

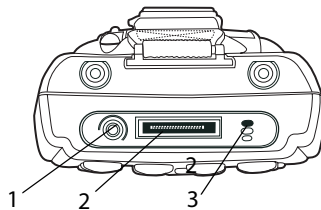

## Top View

- 1 Scanner lens
- 2 Storage media cover

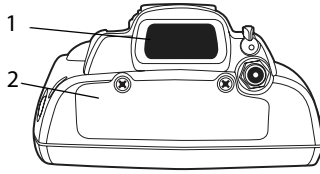

## Antenna Installation and Storage Media Slots

CDMA WWAN antenna (if applicable)

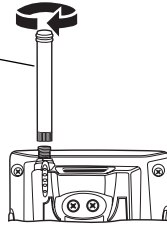

GPRS antenna (if applicable)

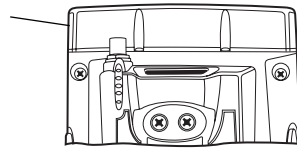

Loosen two screws to remove

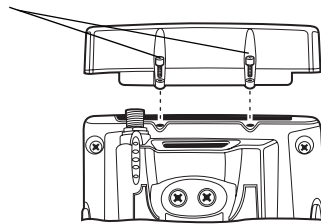

CompactFlash slot

SIM card slot

SD card slot

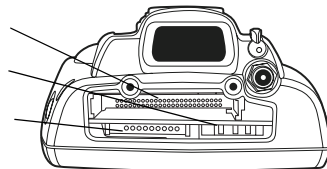

# Installing Battery and Charging Options

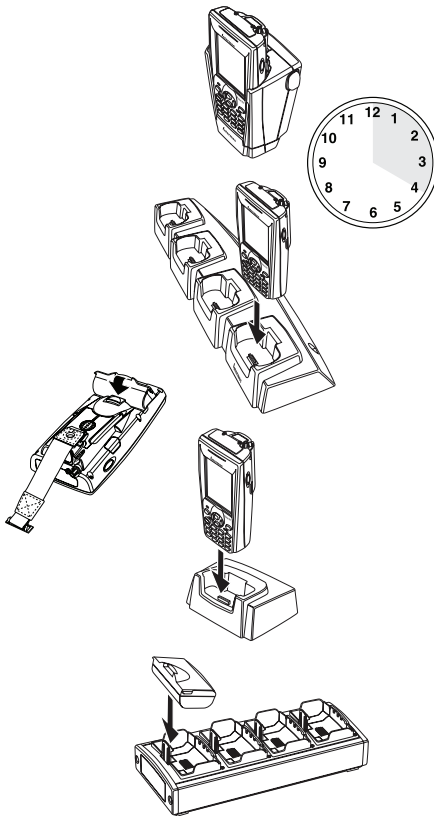

## Electrical Rating

- 12 Vdc@ 1.5 amps

## For More Information

Visit the Intermec web site at [www.intermec.com](http://www.intermec.com) to download our current manuals (in PDF). To order printed versions of the Intermec manuals, contact your local Intermec representative or distributor.

Visit the Intermec technical knowledge base (Knowledge Central) at [intermec.custhelp.com](http://intermec.custhelp.com) to review technical information or to request technical support for your Intermec product.



**Worldwide Headquarters**

6001 36th Avenue West  
Everett, Washington 98203  
U.S.A.

**tel** 425.348.2600

**fax** 425.355.9551

[www.intermec.com](http://www.intermec.com)

© 2006 Intermec Technologies  
Corporation. All rights reserved.

700 Color Multilanguage Instructions



P/N 930-163-001