

CN51

Mobile Computer

For Windows Embedded Handheld 6.5



User Manual

Intermec Technologies Corporation

Worldwide Headquarters
6001 36th Ave.W.
Everett, WA 98203
U.S.A.

www.intermec.com

The information contained herein is provided solely for the purpose of allowing customers to operate and service Intermec-manufactured equipment and is not to be released, reproduced, or used for any other purpose without written permission of Intermec Technologies Corporation.

Information and specifications contained in this document are subject to change without prior notice and do not represent a commitment on the part of Intermec Technologies Corporation.

© 2013 by Intermec Technologies Corporation. All rights reserved.

The word Intermec, the Intermec logo, Norand, ArciTech, Beverage Routebook, CrossBar, dcBrowser, Duratherm, EasyADC, EasyCoder, EasySet, Fingerprint, i-gistics, INCA (under license), Intellitag, Intellitag Gen2, JANUS, LabelShop, MobileLAN, Picolink, Ready-to-Work, RoutePower, Sabre, ScanPlus, ShopScan, Smart Mobile Computing, SmartSystems, TE 2000, Trakker Antares, and Vista Powered are either trademarks or registered trademarks of Intermec Technologies Corporation.

There are U.S. and foreign patents as well as U.S. and foreign patents pending.

Wi-Fi is a registered certification mark of the Wi-Fi Alliance.

Microsoft, Windows, and the Windows logo are registered trademarks of Microsoft Corporation in the United States and/or other countries.

Bluetooth is a trademark of Bluetooth SIG, Inc., U.S.A.

This product includes software developed by the OpenSSL Project for use in the OpenSSL Toolkit (www.openssl.org).

This product includes cryptographic software written by Eric Young (EAY@cryptsoft.com).

This product uses Regex++, Index software during its operational phases. The owner of Regex++ has granted use of the software to anyone provided such use is accompanied by the following copyright and permission notice:

Regex++, Index. (Version 3.31, 16th Dec 2001)

Copyright © 1998-2001 Dr John Maddock

Permission to use, copy, modify, distribute and sell this software and its documentation for any purpose is hereby granted without fee, provided that the above copyright notice appear in all copies and that both that copyright notice and this permission notice appear in supporting documentation. Dr John Maddock makes no representations about the suitability of this software for any purpose. It is provided “as is” without express or implied warranty.

Contents

Before You Begin.....	ix
Safety Information.....	ix
Global Services and Support.....	ix
Warranty Information.....	ix
Web Support.....	x
Send Feedback.....	x
Telephone Support.....	x
Who Should Read This Manual.....	x
Related Documents.....	x
Patent Information.....	xi

1 About the Computer Features 1

About the CN51 Mobile Computer.....	2
About Language Provisioning.....	4
About the Battery.....	4
Charge the Battery.....	4
Change the Battery.....	5
About Battery Status.....	6
About Battery Life and Conservation.....	8
About the Status LEDs.....	9
About the Keypad.....	12
Configure the Keypad Backlight.....	13
About the Color-Coded Keys.....	13
How to Capitalize Characters on the QWERTY Keypad.....	14
How to Capitalize Characters on the Numeric Keypad.....	14
About the Power Button.....	15
About the Screen Backlight.....	17
Configure the Screen Backlight Brightness.....	17
About the Audio Features.....	17
Adjust the Speaker Volume.....	17
About the Imager.....	18
Read Bar Codes with the Imager.....	18
Connect a Bluetooth Scanner.....	20

Contents

Insert a MicroSD Card	21
How to Transfer Files.....	23
Set Up the Computer as a Mass Storage Device	23
CN51 Accessories	24

2 About the User Interface and Intermec Applications..... 27

About the User Interface.....	28
About the Home Screen	28
About Screen Gestures	30
Title Bar Status Icons	30
Configure the Screen Brightness	32
Calibrate the Screen.....	32
About Intermec Applications	32
Intermec Applications on the Computer	32
Downloadable Intermec Applications for the Computer.....	34
About Features Demo	34
About Intermec Browser.....	34
About Intermec HTML5 Browser.....	34
About Intermec Launcher	35
About Intermec Terminal Emulator	35
About SmartSystems	35

3 Use the Phone..... 37

About the Phone.....	38
Activate the UMTS Phone	38
About Worldwide UMTS	42
Activate the CDMA Phone.....	42
Make a Phone Call	43
Make an Emergency Phone Call	43
Configure Phone Sounds	44
How to Add and Switch Between Network Carriers	45
Enable Automatic Configuration of Carrier Settings	45
Switch Carriers Using Intermec Settings	45

4 Use the Camera. 47

About the Color Camera.	48
How to Take Pictures and Record Videos.	48
Take a Picture	49
Record a Video.	49
Save Pictures and Videos to a microSD Card.	50
Configure or Create Camera Scenes	50
Scene Settings	50
Configure Camera Settings for Pictures and Videos	53
Camera Settings for Pictures and Videos	54
How To Read Bar Codes With the Camera.	65
Enable or Disable Reading Bar Codes With the Camera	65
Read Bar Codes With the Camera	66
Camera Settings for Reading Bar Codes.	66
How to Perform Document Capture with the Camera.	68
Enable or Disable Document Capture with the Camera	69
Perform Document Capture with the Camera	69
Camera Settings for Document Imaging	70

5 Use GPS 73

About the Integrated GPS on Your Computer	74
Use the GPSID Installed on the Computer	74
About the GPS Module Operating Modes.	75
Improve GPS Performance on the Computer	76

6 Configure the Computer 77

How to Configure the Computer.	78
About Intermec Settings on the Computer	78
Start Intermec Settings	78
About the Structure of Intermec Settings	79
How to Navigate in Intermec Settings.	84
Enable Intermec Settings Password.	85
Restore Default Settings.	85
Configure the Computer Remotely with SmartSystems	86

About Network Communications	86
Configure 802.11 Radio Communications	86
About Bluetooth Communications	87
Turn On the Bluetooth Radio	88
Connect a Bluetooth Scanner	89
Create a Configuration Bar Code with EasySet	89
Connect to a Bluetooth Printer	90
Connect a Bluetooth Audio Device	92
About Serial and USB Communications	93
About Wireless Security	93
Load a Certificate	94
How to Make Your Security Choice	95
Select a Funk Security Profile	95
Configure WPA or WPA2 Enterprise (802.1x) Security with Funk Security	96
Configure WPA or WPA2 Personal (PSK) Security with Funk Security	96
Configure 802.1x Security with Funk Security	97
Configure LEAP Security with Funk Security	98
Configure Static WEP Security with Funk Security	98
Use Open (No Security) Associations with Funk Security	99
Select Microsoft as Your Security Choice	99
Configure WPA or WPA2 Enterprise (802.1x) Security with Microsoft Security	100
Configure WPA or WPA2 Personal (PSK) Security with Microsoft Security	100
Configure 802.1x Security with Microsoft Security	101
Configure Static WEP Security with Microsoft Security	102
Use Open (No Security) Associations with Microsoft Security	102

7 Manage the Computer 105

How to Manage the Computer in Your Network	106
How to Manage the Computer Using CloneNGo	106
How to Manage the Computer Using SmartSystems	106
How to Develop and Install Applications	107
How To Package Your Application	107
Install Applications with SmartSystems	108
Install Applications with Microsoft Synchronization Software	108
Install Applications with a microSD Card	109
How to Launch Applications Automatically	109

How to Update the System Software	109
Update the Computer with SmartSystems	110
Update the Computer with a microSD Card	111

8 Troubleshoot and Maintain the Computer 113

About the Intermecc Dashboard	114
About Troubleshooting the Computer	115
Wi-Fi Connection Problems	115
Check Wi-Fi Network Status	116
802.1x Security Problems	117
Troubleshoot the Scanner with Scan Diagnostics	119
Problems Reading Bar Codes	119
Problems Using the Computer	121
Call Product Support	121
Locate Your Configuration Number	122
Locate Your Operating System Version	122
How to Restart the Computer	123
Reboot the Computer	123
Cold Boot the Computer	123
Clean Boot the Computer	124
Clean the Computer	125

A Specifications 127

Physical and Environmental Specifications	128
EA31 Extended Reading Range	130
EA31 Minimum Reading Distances	131
EA31 Typical Reading Distances	132
EA30 Extended Reading Range	134
EA30 Minimum Reading Distances	135
EA30 Typical Reading Distances	136

B Keypads and Keystrokes 137

Standard Characters	138
CN51 Keypads and Keystrokes	138

Before You Begin

This section provides you with safety information, technical support information, and sources for additional product information.

Safety Information

Your safety is extremely important. Read and follow all warnings and cautions in this document before handling and operating Intermec equipment. You can be seriously injured, and equipment and data can be damaged if you do not follow the safety warnings and cautions.

This section explains how to identify and understand dangers, warnings, cautions, and notes that are in this document. You may also see icons that tell you when to follow ESD procedures and when to take special precautions for handling optical parts.



Caution

A caution alerts you to an operating procedure, practice, condition, or statement that must be strictly observed to prevent equipment damage or destruction, or corruption or loss of data.



Note: Notes either provide extra information about a topic or contain special instructions for handling a particular condition or set of circumstances.

Global Services and Support

Warranty Information

To understand the warranty for your Intermec product, visit the Intermec web site at www.intermec.com and click **Support > Returns and Repairs > Warranty**.

Disclaimer of warranties: The sample code included in this document is presented for reference only. The code does not necessarily represent complete, tested programs. The code is provided “as is with all faults.” All warranties are expressly disclaimed, including the implied warranties of merchantability and fitness for a particular purpose.

Web Support

Visit the Intermec web site at www.intermec.com to download our current manuals (in PDF).

Visit the Intermec technical knowledge base (Knowledge Central) at www.intermec.com and click **Support > Knowledge Central** to review technical information or to request technical support for your Intermec product.

Send Feedback

Your feedback is crucial to the continual improvement of our documentation. To provide feedback about this manual, please contact the Intermec Technical Communications department directly at TechnicalCommunications@intermec.com.

Telephone Support

In the U.S.A. and Canada, call **1-800-755-5505**.

Outside the U.S.A. and Canada, contact your local Intermec representative. To search for your local representative, from the Intermec web site, click **About Us > Contact Us**.

Who Should Read This Manual

This user manual is for the person who is responsible for installing, configuring, and maintaining the CN51.

This document provides you with information about the features of the CN51, and how to install, configure, operate, maintain, and troubleshoot it.

Before you work with the CN51, you should be familiar with your network and general networking terms, such as IP address.

Related Documents

The Intermec web site at www.intermec.com contains our documents (as .pdf files) that you can download for free.

- 1** Visit the Intermec web site at www.intermec.com.
- 2** Click the **Products** tab.

3 Using the **Products** menu, navigate to your product page. For example, to find the CN51 computer product page, click **Computers > Handheld Computers > CN51**.

4 Click the **Manuals** tab.

If your product does not have its own product page, click **Support > Manuals**. Use the **Product Category**, the **Product Family**, and **Product** menus to find your documentation.

Patent Information

There are U.S. and foreign patents pending.

Before You Begin

1

About the Computer Features

This chapter introduces the CN51 Mobile Computer with Windows® Embedded Handheld 6.5 operating system. Use this chapter to learn about basic computer features and functions, as well as the available accessories for it.

About the CN51 Mobile Computer

The Intermec CN51 Mobile Computer is the class-leading mid-range rugged mobile computer that empowers mobile workers with the resources to satisfy and delight customers efficiently today and earn new business tomorrow.

The CN51 is available with the following features:

- Windows Embedded Handheld 6.5 operating system
- 1.5 GHz dual-core multi-engine processor with extended battery life
- 1 GB DRAM, 16 GB Flash memory
- Large, outdoor-viewable WVGA display with full-size keypad
- Resistive touch panel display
- Bluetooth radio
- UMTS/HSPA+/CDMA or UMTS/HSPA+ WAN radio options; both options support voice and data
- IEEE 802.11a/b/g/n on computers without a cellular radio, IEEE 802.11b/g/n on computers with a cellular radio
- Customer-accessible microSD slot for removable memory cards (up to 32 GB)
- High-performance EA30 or EA31 area imager options, for reading bar codes and capturing signatures
- HTML5 support
- Integrated GPS receiver (with WAN radio option)
- Accelerometer that can automatically sense the angle of the computer and rotate the display between portrait and landscape
- 5-megapixel color camera

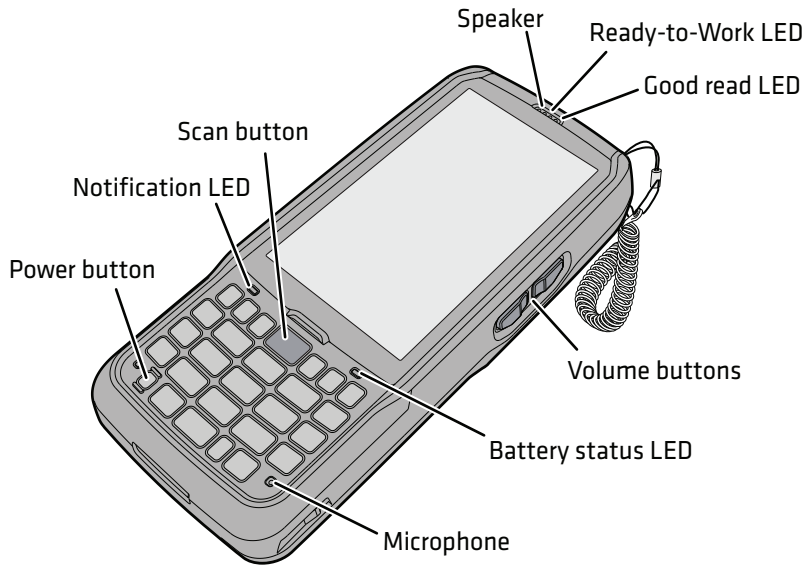

CN51 Front View

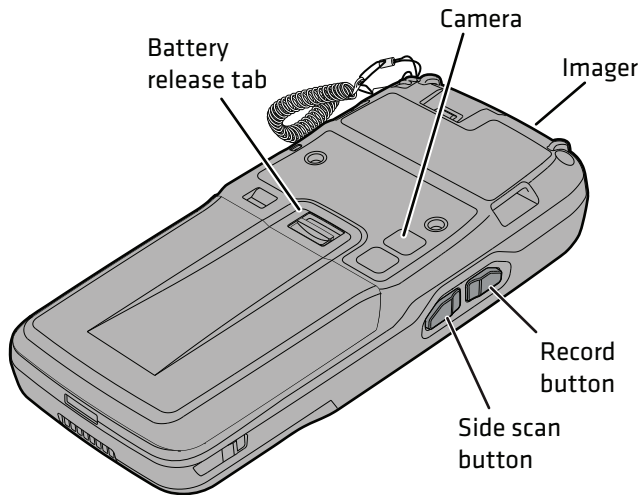

CN51 Back View

About Language Provisioning

You are prompted to select a language provision when the computer starts for the first time. It may take as little as three minutes to load your language. Once loaded, your selected language persists through all boot scenarios (warm, cold, or clean).

Make sure you select the correct language before you tap **Provision**. If you need to change the language provisioning, you must reinstall the operating system and restart the computer. When the computer restarts, select your new language.

About the Battery

The CN51 uses a Model 1015AB01 battery as its main power source. The battery has a 14.4 Watt hour capacity. Several factors determine the life of your battery, such as display brightness, display timeout, input devices, extreme temperatures, and your usage.

Fully charge the battery before you use the CN51. When you change the battery, the computer automatically goes into a power-off state and then cold boots.



Caution: The battery used in this device may present a fire or chemical burn hazard if it is mistreated. Do not disassemble it, heat it above 100 °C (212 °F) or incinerate it. Dispose of used batteries promptly. Keep away from children.

Contact your Intermec representative for replacement batteries.

Charge the Battery

Make sure you fully charge the battery (Model 1015AB01) before you use your CN51. You can charge the battery before or after you install it in the CN51. A fully discharged battery charges in approximately 6 hours.

- Insert the battery into a quad battery charger, a single dock, or a multidock, or attach external power to the CN51 with the battery installed.

The battery is fully charged when the battery status LED shows a steady green.

Use these Intermec accessories to charge the CN51 batteries:

- Quad Battery Charger (Model AC21)
- Charge-Only Multidock (Model AD23)
- Ethernet Multidock (Model AD24)
- Single Dock (Model AD27)
- Vehicle Power Adapter (Model AE36)
- AC Power Adapter (Model AE37)

Change the Battery

When the battery in the CN51 has a low charge, replace it with a charged battery.



Note: When you remove a battery from the computer, Intermec recommends that you install a charged battery within one minute to maintain your network connections.

- 1** Save your files and close all open applications.
- 2** Press the Power button, and then select **Hibernate** from the menu.
- 3** If necessary, disconnect the handstrap from the top of the computer.

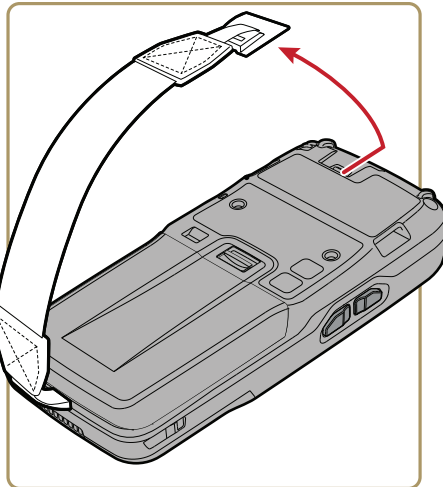

- 4 Push forward on the battery release tab until the battery releases, and then lift the battery away from the computer.

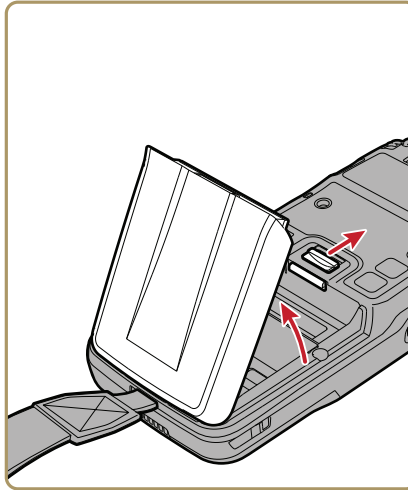





- 5 Insert the bottom of a fully charged battery into the CN51, and press down on the top until it clicks into place.
- 6 If necessary, reattach the handstrap.

About Battery Status

Use the battery icon on the Title bar to view the power status of the battery.

Battery Status Icons

Icon	Status
	Battery is fully charged.
	Battery has medium charge.
	Battery is low. You need to change the battery soon.
	Battery is critically low. You need to change the battery now or place the computer in a charging dock immediately.
	Battery is charging.

The Battery status LED below the computer screen indicates the charging status of the battery.

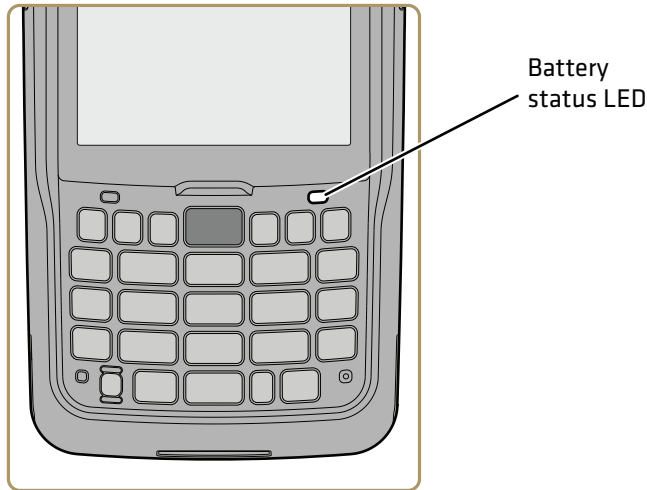

Battery LED States

LED State	Description
Steady green	The computer is connected to a charger and the battery is more than 95% charged.
Blinking green	The computer is connected to a charger and the battery is between 60% and 95% charged.
Steady red	The computer is connected to a charger and the battery is less than 60% charged.
Blinking red	The battery is very low. The computer will soon go into Suspend mode. Charge or replace the battery.
Amber	There is a battery error. The battery is not charging because it is missing, faulty, or outside the allowable charging temperature range. If it is outside the charging temperature range, charging will resume when the battery temperature returns to the acceptable range of 0 °C to 45 °C (32 °F to 113 °F).
Off	No battery is installed. The CN51 does not turn on if no battery is installed. The battery is not critically low, and the CN51 is not connected to an external power source.

About Battery Life and Conservation

Batteries that are stored outside the computer for long periods of time slowly discharge. Intermec recommends storing the battery in a charger to maintain battery performance.

Battery Conservation Tips

When You Want to:	Do this to Save Battery Power:
Use the computer and the low battery status icon appears or the battery light turns on.	<ul style="list-style-type: none">• Connect the computer to an external power source.• Or, save your data, press the Power button, and select Hibernate. After the computer turns off, remove the battery and insert a fully charged battery.
Stop using the computer for 5 minutes or longer.	<p>Make sure that the low battery status icon is not on the screen and the battery status LED is not on. Press the Power button and select Suspend to suspend the computer.</p> <p>If you have enabled the Sleep face down feature in Intermec Settings, the CN51 automatically suspends when you lay the computer face down.</p>
Store the computer for more than a day.	<ul style="list-style-type: none">• If you are storing the computer for a few days, like over the weekend, install a charged battery or connect the computer to a power source.• If you are storing the computer for longer, remove and charge the battery, and then store both the battery and computer in a cool location. Do not place the charged battery in the computer, which runs the battery down over time even when the computer is not in use.• If you store the battery for several months, recharge the battery to keep it at peak performance.
Store the battery outside the computer.	Store the battery in a charger.

About the Status LEDs

The status LEDs turn on, turn off, or blink to indicate a specific activity on your computer.

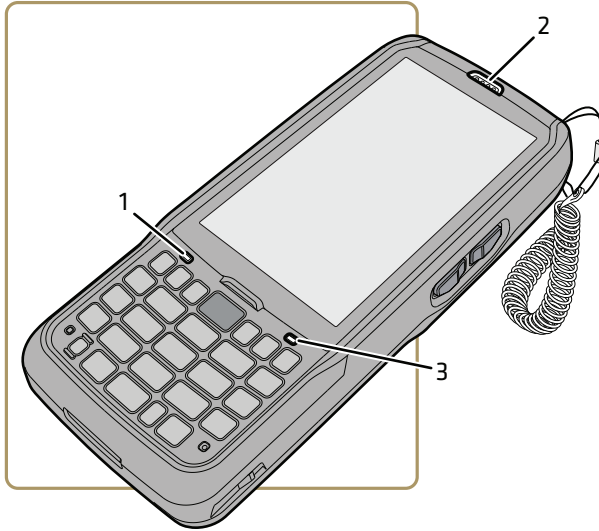

Status LED Locations

Main Status LED Descriptions

Callout	LED	Color	Description
1	Notification	Orange	Windows Mobile 6.5 notification.
2	Good Read	Green	Good read of a bar code.
		Blinking red	Bad read of a bar code.
		Blinking green	The data collection engine is processing or starting up.

Main Status LED Descriptions (Continued)

Callout	LED	Color	Description
2	Intermec Ready-to-Work™ indicator	Blue	If Intermec Terminal Emulator (ITE) is installed, the application is running and is connected to the host. If you do not have ITE, you can configure the Ready-to-Work indicator to turn on or off to indicate a healthy state.
		Blinking blue	ITE is running but not connected to the host. The computer is unhealthy.
		Off	ITE is not installed or not running. The computer is healthy.
3	Battery status	Steady green	The computer is connected to a charger and the battery is more than 95% charged.
		Blinking green	The computer is connected to a charger and the battery is between 60% and 95% charged.
		Steady red	The computer is connected to a charger and the battery is charging.
		Blinking red	The battery is very low, and the computer will go into Suspend mode soon. Charge or replace the battery.
		Amber	There is a battery error. The battery is not charging because it is missing, faulty, or outside the allowable charging temperature range. If it is outside the charging temperature range, charging will resume when the battery temperature returns to the acceptable range of 0 °C to 45 °C (32 °F to 113 °F).
		Off	The computer is not on external power and the battery is operating normally.



Location of Orange and Green Key LEDs

Orange and Green Key Status LEDs

Callout	LED	Color	Description
4	Orange/green key status	Orange or green	When the LED is orange, the Orange shift plane is enabled. You can type characters or access functions printed in orange on the keypad. When the LED is green, the Green shift plane is enabled. You can type characters or access functions printed in green on the keypad.

About the Keypad

The CN51 comes with either a numeric keypad or a QWERTY keypad:

- The numeric keypad is for applications that require mainly numeric data. This keypad also lets you enter special characters, including the alphabet, by pressing color-coded key sequences.
- The QWERTY keypad is designed for applications that require primarily alphabetic data. This keypad also lets you enter special characters by pressing color-coded key sequences.

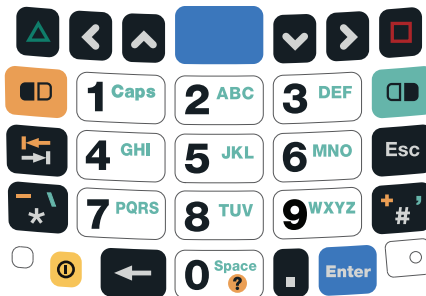

CN51 Numeric Keypad

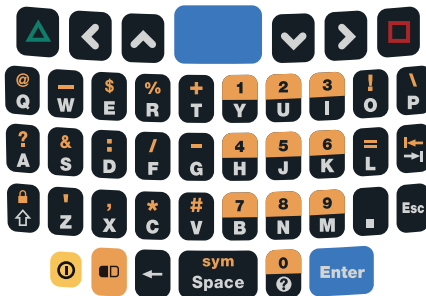

CN51 QWERTY Keypad

Configure the Keypad Backlight



You can configure the keypad backlight to always turn on, always stay off, or turn on depending on the lighting level of your work environment.

- 1 Start Intermec Settings.
- 2 Tap **Device Settings > Backlight > Keypad**.
- 3 Select the options you want for the keypad backlight:
 - Select **Always off** to prevent the keypad backlight from turning on.
 - Select **Automatic** to turn on the keypad backlight automatically based on the ambient light level.
 - Select **On With the Display** to turn on the keypad backlight only when the display is on. When the CN51 suspends, the keypad backlight turns off to save power.
 - Select **Always on** to turn the keypad backlight on all the time.
- 4 Tap **OK**.

About the Color-Coded Keys











Note: The CN51 with QWERTY keypad does not have a green key.

Use the orange  key and the green  key to access additional characters, symbols, and functions printed on the keypad overlay. After you understand how to use the color-coded keys and key sequences, you can access all of the additional features printed on the keypad overlay.



The default setting for the Green/Orange keys is **Press twice to lock**. You can also set the keys to **Press once to lock** if you do not want the Green/Orange keys to lock after pressing them twice. The information in this section assumes that you are using the default setting for the Green/Orange keys lock options. To change the setting for the Green/Orange keys, go to **Start > Settings > System > Intermec Settings > Device Settings > Keypad**.

How to Use the Color-Coded Keys

You Want To	Press	Example
Use an orange character or function printed above a key.	 (LED turns on), and then the key with the character or function printed above it (LED stays on).	On the alphanumeric keypad, press  , then press the M key to type the number 9.
Use a green character or function printed above a key.	 (LED turns on), and then the key with the character or function printed above it (LED stays on).	On the numeric keypad, press  , then press 3 twice to type the letter “e”.
Unlock the green or orange key.	 or  once.	Press  or  once to unlock the key. The LED turns off.



How to Capitalize Characters on the QWERTY Keypad

If your CN51 has the QWERTY keypad, you can capitalize characters individually, or you can type all capital letters by enabling Caps Lock:

- To capitalize a single character, press the **Shift** key, and then the character.
- To enable Caps Lock, press  and then press the **Shift** key.
- When Caps Lock is enabled, press  and then press the **Shift** key to disable Caps Lock.

How to Capitalize Characters on the Numeric Keypad

If your CN51 has the numeric keypad, you can capitalize characters individually, or you can type all capital letters by enabling Caps Lock:

- To capitalize a single character, press the  key, and then the **1** key. Select the key with the letter you want to capitalize. Press **1** again to return to lowercase letters.
- To enable Caps Lock, press  and then press **1**.
- To disable Caps Lock, press **1** again.

About the Power Button

When you press and release the **Power** button, the Intermec Power Options screen appears with a list of power options. If you do not select a power options setting, the currently selected action (the button outlined in bold) occurs after the timeout. Hibernate does not appear as an option if the computer is connected to external power.

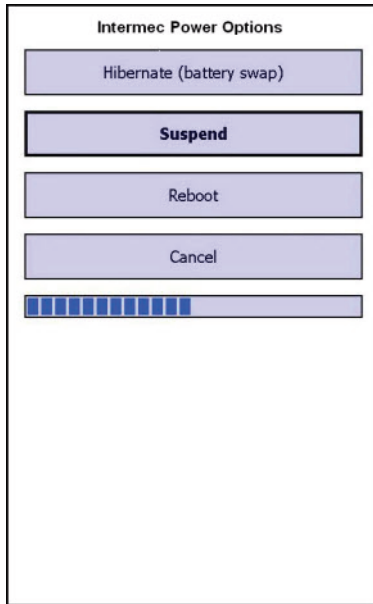

Use the next table to understand the Intermec Power Options and what settings are available for your computer.

Intermec Power Options

Option	Description
Hibernate (battery swap)	High power saving mode. The computer saves the current system state, registry, and file system and then powers off all radios and internal devices. You can wake the computer by pressing the Power button or connecting the computer to external power.

Intermec Power Options (Continued)

Option	Description
Suspend	Medium power saving mode. When on battery power, Suspend mode saves the current system state and then turns off most radios and internal devices. The WWAN radio remains in a lower power state and can still receive calls. When the computer is connected to external power, Suspend mode turns off the screen but leaves all radios on. You can wake the computer by pressing the Power button, pulling the scanner trigger, or scheduling an event such as an alarm. If the computer is on battery power during Suspend mode, you can also wake the computer by connecting it to external power.
Reboot	The computer does not save the current system state, but the registry and file systems are saved. The computer shuts down all running processes and restarts.
Cancel	Cancels the Intermec Power Options menu.
Screen Off	Lowest power saving mode. The screen turns off, but the radios and internal devices stay on. Tap the screen to turn it back on.
Shutdown	Very high power saving mode. The computer turns off everything. You must press Power or apply external power to restart the computer.

If you are using WPA or 802.1x security, the computer may need to reauthenticate before it resumes your application. The Real Time Clock (RTC) will persist through all of the power options as long as it receives power from the Real Time Clock battery.

The Intermec Power Options screen is customizable. You can use Intermec Settings to determine which options are available to end users, the timeout until the default choice is selected, the default action if no option is selected, or to disable the Power Options Screen.

About the Screen Backlight

The display has an ambient light sensor that automatically adjusts the backlight intensity to conserve power and ensure the display is readable. You can set the backlight intensity levels as needed for your environment.

Configure the Screen Backlight Brightness

Use Intermec Settings to configure the brightness of the screen backlight.

- 1 Tap **Start** > **Settings** > **System** > **Intermec Settings**.
- 2 Tap **Device Settings** > **Backlight** > **Display**.
- 3 Select a brightness level. The default value is +1.
- 4 Tap **OK** and exit Intermec Settings.

About the Audio Features

Your mobile computer has a speaker, a microphone, and several software tools for configuring the volume of sounds.

Adjust the Speaker Volume

The computer volume includes sounds you hear when you tap the screen or scan bar codes with a scanner.

- 1 Tap the Title bar at the top of the screen.
- 2 Tap the Volume icon .
- 3 Use your stylus to adjust the volume slider, or use the side volume buttons to change the volume setting.
- 4 Tap **OK**.

About the Imager

The computer has an EA30 or EA31 area imager that can read 1D and 2D bar code symbologies, composite symbologies, and postal codes. You can also use the imager to take pictures as if it were a camera.

You can also use Bluetooth communications to connect the computer to cordless scanners, such as the SF51 and SR61.

Read Bar Codes with the Imager

All of the imagers support omni-directional scanning and include an aiming beam to help you correctly frame bar codes.

Before you start reading bar codes, use Intermec Settings to:

- enable only the bar code symbologies that you need.
- choose the predefined imager mode that best suits your environment.

Predefined Mode	For Scanning
1D	Only 1D labels.
1D and 2D Standard	(Default) All types of bar code labels.
1D and 2D Bright Environment	In high ambient light, such as outdoors in sunshine.
1D and 2D Reflective Surface	Glossy Labels.

- 1** Point the imager window at the bar code and hold the computer steady a few inches from the label.
- 2** Press the **Scan** button or pull the scan handle trigger. The illumination beam, laser pointer, or frame appear.

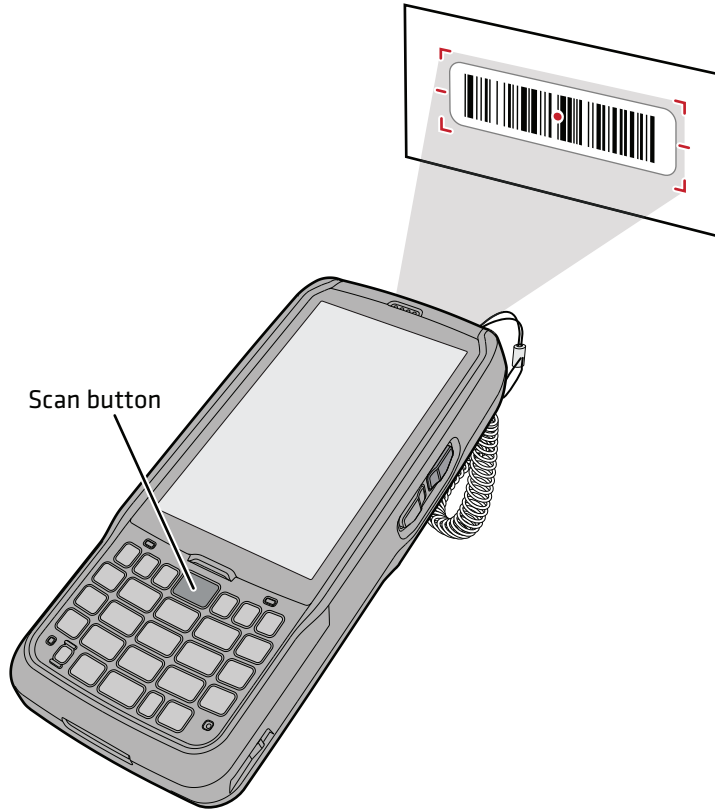

For near or close-in scanning distances of 30 cm (11.8 in) or less, use the laser pointer as a guide and aim slightly to the right of the center of the bar code. Make sure the illumination beam covers the bar code you are trying to decode.

For standard and long range scanning distances of 30 cm (11.8 in) or more, use the laser pointer as a guide and aim toward the middle

of the bar code. Make sure that the illumination beam covers the bar code you are trying to decode.

When the imager successfully reads a bar code label, you hear a high beep, and the Good Read LED turns on briefly.

- 3 Release the **Scan** button or trigger.

Connect a Bluetooth Scanner

You can connect the computer to an Intermec Bluetooth scanner, such as the SF51 or SR61. Make sure that the Bluetooth radio in the computer is turned on before you try to connect to a scanner.

- 1 Tap **Start > Settings > System > Wireless Scanning**.

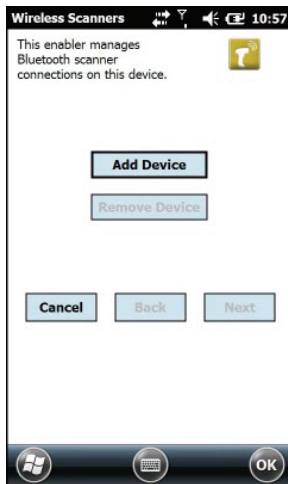

- 2 Tap **Add Device**.
- 3 Select **Quick Connect**, **Search**, or **Manual**. Follow the instructions on the screen to add a Bluetooth scanner.

After you add a Bluetooth scanner, you can configure scanner settings and parameters in Intermec Settings.

Insert a microSD Card

You can use a micro Secure Digital (SD) card to increase file storage capacity or to install software. The CN51 supports an optional 32 GB maximum capacity microSD™ card. The card slot is located in the battery compartment.

- 1** Remove the battery and open the card access door in the battery compartment.
- 2** Slide the SIM card holder to the left to unlatch it, and lift the holder to open it and access the microSD card holder.

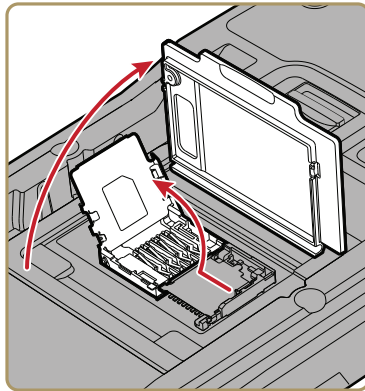

- 3** Slide the microSD card holder towards the top of the CN51 to unlatch it, and lift the holder to open it.

Chapter 1 – About the Computer Features

- 4 Place the microSD card in the holder with the contacts facing away from the holder.

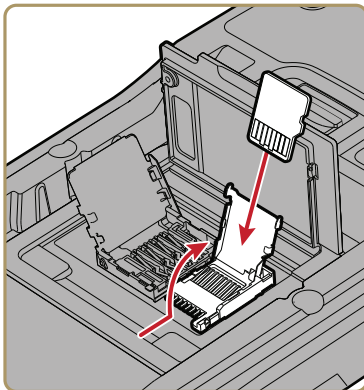

- 5 Close and latch the microSD card holder.

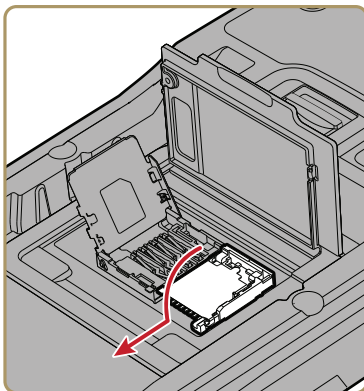

- 6 Close and latch the SIM card holder, and close the card access door until it snaps shut.
- 7 Install the battery and turn on the computer.

How to Transfer Files

To transfer files you need to physically connect your mobile computer to your PC and install either Microsoft ActiveSync (Windows XP or earlier) or Windows Mobile Device Center (Windows Vista or Windows 7) on your PC. ActiveSync and Windows Mobile Device Center are free applications available from the Microsoft website at www.microsoft.com/downloads.

Use one of these accessories to connect your mobile computer to your PC:

- USB cable (P/N 236-297-001)
- CN51 USB Snap-On Adapter
- CN51 Desktop USB Adapter
- AD27 Single Dock

Set Up the Computer as a Mass Storage Device

Use the computer as a mass storage device so you can easily copy files to and from the mobile computer and your desktop PC.

- 1 Go to www.datalight.com and download the Reliance Nitro Windows Driver (RNWD).
- 2 Connect the mobile computer to your desktop PC using a USB cable or USB-capable accessory.
- 3 On the mobile computer, tap **Start > Settings > System > Intermec Settings**.
- 4 Tap **Device Settings > USB**.
- 5 From the USB function driver menu, select **Mass storage - Flash File Store** and tap **OK**.
- 6 Copy files to and from your desktop PC to the mobile computer.

CN51 Accessories

The CN51 ships with a battery. All other accessories are sold and ordered separately. For help, contact your local Intermec sales representative.

CN51 Accessory Descriptions

Accessory	Description
CN51 AC Power Adapter (Model AE37)	The CN51 AC Power Adapter provides a connection for external AC power to the CN51. To use this adapter, you need to purchase a country-specific power cord.
CN51 Battery (Model 1015AB01)	The battery provides power to the CN51. Keep a spare battery pack on hand for longer shifts.
CN51 Charge-Only Multidock (Model AD23)	Use the charge-only multidock to hold up to four CN51s with batteries installed, charge batteries, and provide power to the computers.
FlexDock: DX4 Quad Dock	Use the DX4 Quad Dock to charge up to 4 computers and batteries simultaneously. The Quad Dock is available in Ethernet and charge-only versions.
CN51 Ethernet Multidock (Model AD24)	Use the multidock to hold up to four CN51s with the batteries installed. The multidock charges the batteries and provides power and Ethernet connections to each computer.
CN51 Replacement Handstrap	Use a replacement handstrap to replace a worn-out or lost handstrap.
CN51 Magnetic Stripe Reader (Model AR9)	This accessory snaps on to the CN51 and provides magnetic stripe reading capabilities.
CN51 Quad Charger (Model AC21)	Use the quad battery charger to charge up to four batteries.
CN51 RS-232 Adapter	This accessory snaps on to the CN51 and provides serial connectivity.

CN51 Accessory Descriptions (Continued)

Accessory	Description
CN51 Single Dock (Model AD27)	Use the single dock to hold a CN51 with its battery installed, charge a spare battery pack, charge the main battery pack, and provide power to the mobile computer. The dock has USB host and client connectors. Optional adapters are available to convert the USB host to Ethernet or to a landline modem.
Ethernet Adapter (Model 1004UA01)	Use this Ethernet adapter with the Model AD27 Single Dock to connect the CN51 to your Ethernet network.
Modem Adapter (Model 1004UA02)	Use this modem adapter with the Model AD27 Single Dock to connect the CN51 to a landline modem.
CN51 Tethered Stylus Replacement	Use a replacement stylus to replace a lost or broken stylus.
CN51 Vehicle Docks (AV6, AV9)	Use the vehicle docks to hold and charge the CN51 while using it on a vehicle.
CN51 Vehicle Power Adapter (Model AE36)	Use the vehicle power adapter to charge the battery installed in the CN51 from your vehicle.

2

About the User Interface and Intermec Applications

Use this chapter to learn about the Windows Embedded Handheld user interface and how to interact with the screen. You can also use this chapter to learn about the Intermec applications on your computer, as well as additional applications you can download.

About the User Interface

The Windows Embedded Handheld 6.5 operating system provides a touch-friendly and easy to navigate user interface.

About the Home Screen

When you turn on your mobile computer, the Home screen is the first screen that appears after language provisioning is complete.

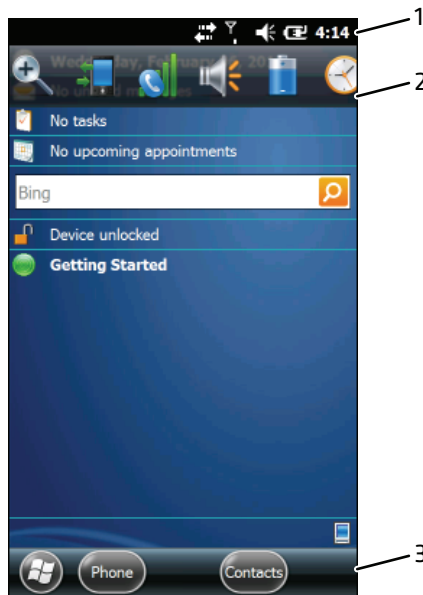

Windows Embedded Handheld 6.5 Home Screen

Home Screen Navigation Bars

Callout	Navigation Bar	Description
1	Title bar	Use the Title bar icons to view the current status of information such as signal strength and battery power remaining.
2	Horizontal scroll bar	A horizontal scroll bar appears when you tap the Title bar. The horizontal scroll bar makes it easy to access the applications associated with the Tile bar icons. The horizontal scroll bar also contains a magnifier which improves the touch experience by making parts of the screen large enough to tap with your finger. The horizontal scroll bar also replaces tabs within Windows screens and allows for easier navigation.
3	Tile bar	Use the Tile bar to access the Start menu, navigate within applications, and open the SIP.

The Clock & Alarms screen shows how the horizontal scroll bar appears when you open an application.



Clock & Alarms Screen with Horizontal Scroll Bar

About Screen Gestures

The Windows Embedded Handheld 6.5 interface supports the use of gestures with the finger or stylus to move around the screen.









Screen Gestures

Gesture	Description
Tap	Represents the left click of a mouse.
Double-tap	Represents the left double-click of a mouse.
Hold	Represents the right click of a mouse when you press and hold on the screen and a context menu appears.
Flick	Initiates scrolling in the direction (horizontal or vertical) the finger or stylus moves across the screen.
Pan	Press and hold on the screen and then drag in any direction.



















Title Bar Status Icons

Tappable icons on the Title bar immediately show you the status of your network, the volume, the battery, and the time.



Title Bar Status Icons

Icon	Description
	You have a new notification.
	You have a new text message.
	You have a new email message.
	You have a new instant message.
	An alarm is set.
	Microphone is on.
	Internet call is in progress.
	Bluetooth is on.

Title Bar Status Icons (Continued)

Icon	Description
	Bluetooth headset is detected.
	ActiveSync connection is established.
	ActiveSync synchronization is in progress.
	There is a problem with the ActiveSync synchronization.
	Connected to a Wi-Fi network.
	Connected to a Wi-Fi network, and other networks are detected.
	Wi-Fi synchronization is in progress.
	Other Wi-Fi networks are detected.
	Information about a new Wi-Fi network is available.
	Wi-Fi is on, but not connected to a network, and other networks are detected.
	Wi-Fi is on, but not connected to a network, and no networks are detected.
	A network connection is active.
	A network connection is inactive.
	The volume is on.
	The volume is off.
	The battery has full charge.
	The battery has a high charge.
	The battery has a medium charge.
	The battery has a low charge.

Title Bar Status Icons (Continued)

Icon	Description
	The battery has a very low charge.
	The computer is attached to external power and the battery is charging.
	No battery is installed in the computer.

Configure the Screen Brightness

You can configure the screen brightness from the Start menu.

- 1 Tap **Start > Settings > System > Backlight**.
- 2 Adjust the slider to the desired brightness level.
- 3 Tap **OK**.

Calibrate the Screen

If the touch screen does not respond as expected when you tap it with the stylus, you may need to calibrate the screen.

- 1 Tap **Start > Settings > Systems > Screen**.
- 2 Tap **Align Screen** and follow the instructions to align the screen.
- 3 Tap **OK**.











About Intermec Applications

Intermec provides many useful applications to help you configure, troubleshoot, and connect your computer to other devices and networks. You can also download additional applications from the Intermec website to help you use all of the features of your computer.

Intermec Applications on the Computer

Intermec applications help you configure, troubleshoot, and connect your computer to other devices and networks.

Intermec Applications Available on the Computer

Icon	Application	Description
	Bluetooth Audio	Use the Bluetooth Audio application to connect to a Bluetooth headset or hands-free device.
	CloneNGo	Use CloneNGo to configure basic device settings on multiple client computers from one master computer. For more information, see the CloneNGo User Guide .
	Intermec Settings	Use Intermec Settings to configure your computer. You can use Intermec Settings to individually configure a computer or you can use it through SmartSystems to configure all of your computers.
	ISpyWiFi	Use ISpyWiFi to check your 802.11 status and diagnose issues with the connection.
	Profile Settings	Use Profile Settings to easily configure the computer for a specific use. You can choose predefined values for the Power, Camera, and Scanning settings.
	ScanDiagnostic	Use the ScanDiagnostic application to troubleshoot problems with the internal or external scanner.
	Sensor Calibration	Use the Sensor Calibration application to demonstrate the accelerometer.
	Wireless Center	Use the Wireless Center to turn the phone and radios (Wi-Fi, Bluetooth) on and off and configure settings for each radio.
	Wireless Printing	Use the Wireless Printing application to connect to a Bluetooth printer.
	Wireless Scanning	Use the Wireless Scanning application to connect to a Bluetooth scanner.

Downloadable Intermec Applications for the Computer

You can download Intermec applications to extend the capabilities of the computer. You may need to purchase an Intermec license to run some applications. To find an application, go to www.intermec.com > **Support** > **Downloads**.

About Features Demo

Intermec Features Demo provides a simple way to explore the key features of your mobile computer. Features Demo applications demonstrate scanning, document imaging, image capture, and printing functionality. Many of the applications that are part of Features Demo also have separate full-featured versions that you can download and license for your computer. For more information on Features Demo, see the *Intermec Features Demo User Guide*.

About Intermec Browser

Intermec Browser is a web browser designed for Intermec computers and is compatible with Microsoft® Internet Explorer® 6 (IE6) and Pocket Internet Explorer (PIE). This locked-down application deliberately limits normal web browser functionality. For example, users cannot exit the program, type URLs, or use the **Back** button. You can configure Intermec Browser for your specific application requirements and you can design your own web pages.

You can download and use Intermec Browser for free for a 60-day evaluation period. After the evaluation period expires, you need to purchase a license. For more information, see the *Intermec Browser User Manual*.

About Intermec HTML5 Browser

Intermec HTML5 Browser provides a free open-platform application environment for Intermec computers. You can now run the same cross-platform web applications on an Intermec computer that you can run on iOS and Android devices. Intermec HTML5 Browser also lets you run applications while the computer is connected to the web or while it is offline. For more information, see the *Intermec HTML5 Browser User Guide*.

About Intermec Launcher

Intermec Launcher is a Microsoft Windows application, designed for Intermec mobile computers, that provides a platform from which other applications may be launched while attempting to provide a locked-down environment. You can configure Intermec Launcher for your specific application requirements. You can download and use Intermec Launcher for a 60-day evaluation period. After the evaluation period expires, you will need to purchase a license. For more information, see the *Intermec Launcher Version 2.2x User Guide*.

About Intermec Terminal Emulator

Intermec Terminal Emulator (ITE) is Intermec's popular terminal emulation client designed for enterprise-level data collection. In a single client, ITE supports multiple emulation protocols. Its features include session persistence, remote management and configuration, and multiple security options. ITE provides a consistent user interface and a common menu structure (Intermec Settings), simplifying the use and management of applications running on Intermec mobile computers.

You can download and use ITE for free for a 60-day demo period. During the demo period, a demo mode message box appears each time you launch ITE. Press **Enter** to close the message box. When the demo period expires, you need to purchase a license. For more information on ITE, see the *Intermec Terminal Emulator (ITE) User Guide*.

About SmartSystems

Intermec SmartSystems™ is an easy-to-use centralized software platform. With SmartSystems, IT Administrators and Integrators can perform hands-free provisioning and deploy and manage Intermec devices.

SmartSystems provides a consistent way to manage Intermec devices located on-site or remotely to maximize IT resources and lower the total cost of ownership for Intermec data collection equipment. SmartSystems Foundation can be downloaded at no charge from the Intermec website. For more information, visit <http://www.intermec.com/SmartSystems>.

3

Use the Phone

You can use the phone feature to make and receive telephone calls, as well as transmit data through cellular wide-area networks (WANs).

About the Phone

Phone features on the computer include a speaker and a microphone. You can also use a Bluetooth headset or hands-free kit. The phone feature is enabled by default.

The WAN radio in your computer determines the supported network types:

- If your computer includes the UMTS/HSPA+ WAN radio, you can connect to UMTS networks in all regions supporting this technology.
- If your computer includes the Flexible Network Radio, you can connect to CDMA or UMTS networks in all regions that support these technologies. The Flexible Network Radio is a software-defined radio (SDR) that can be configured for CDMA or UMTS depending on your wireless communication needs.

Intermec currently supports these CDMA network carriers:

- Sprint (United States only)
- Verizon (United States only)

For other carriers, contact Intermec Product Support.

After you turn on the phone and activate service with your wireless carrier, you can customize the phone features and network settings.



Note: Both WAN radios support Network Information and Time Zone (NITZ) messages to automatically set the system time.

Activate the UMTS Phone

You use a SIM card to activate the UMTS phone on the CN51. You can purchase the SIM card from your network provider.

- 1 Press **Ⓜ** to turn off the CN51.
- 2 Disconnect the handstrap from the top of the computer.

- 3** Push forward on the battery release tab until the battery releases, and then lift the battery away from the computer.

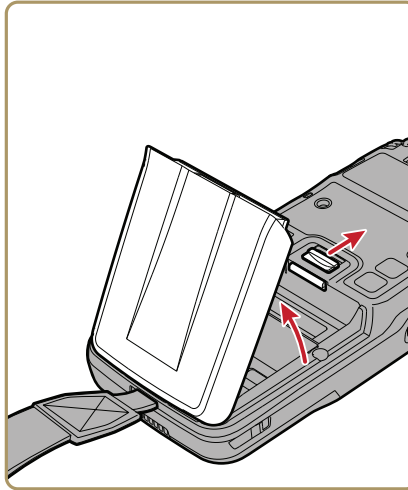

- 4** Open the card access door and slide the SIM card holder to the left to open it.

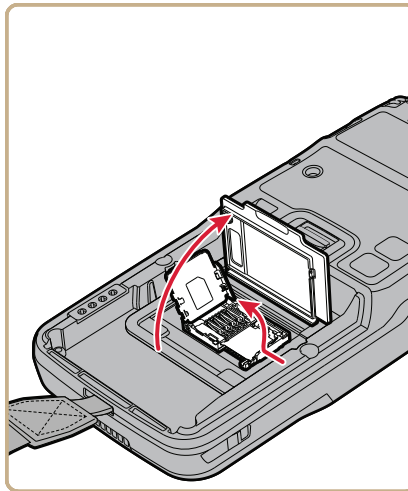

- 5 Place the SIM card in the holder.

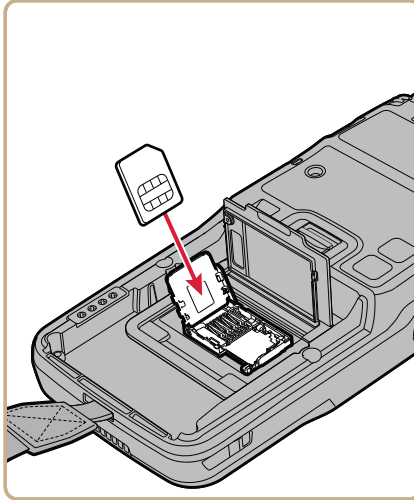

- 6 Close the SIM card holder and slide it to the right to secure it, and then close the card access door.

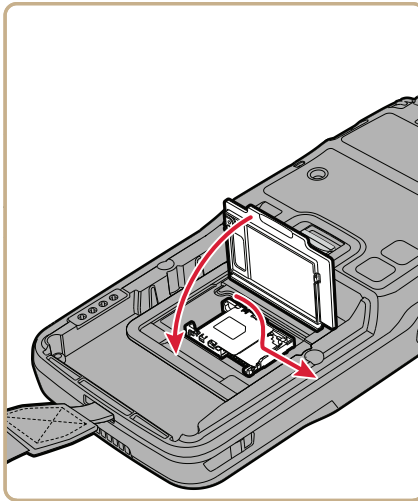

- 7 Insert the battery and press down until it clicks in place.
- 8 Reconnect the handstrap.

- 9 Press  to turn on the CN51. This screen (or similar) appears:

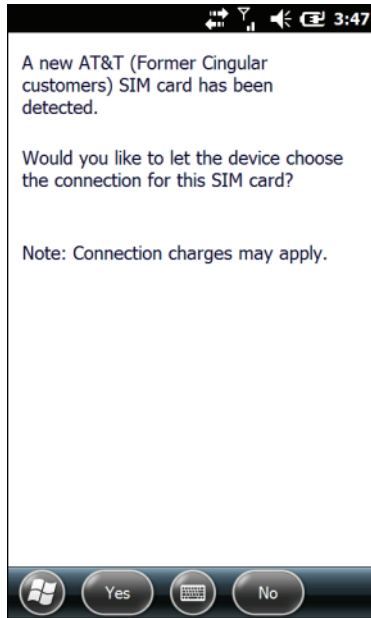

- 10 If your computer has the UMTS-only WAN radio, tap **Yes**. The computer attempts to connect to your UMTS network. When the connection is successful, a confirming message appears. Tap **OK** to close the message. The phone is ready to use.

If your computer has the software-defined radio, tap **No**. The Home screen appears and the phone is ready to use. If you plan to add additional carriers, you need to enable automatic configuration of carrier settings in Intermec Settings.



Note: Data connections are to the public domain on your network.

About Worldwide UMTS

If your computer has the UMTS-only WAN radio, when you perform a clean boot all user-created network connections are deleted, and only the generic Worldwide UMTS remains. After you perform a clean boot, you can find more information about Worldwide UMTS by tapping **Start > Settings > Connections > Connections > Tasks** tab > **Manage Existing Connections > Modem** tab.

Activate the CDMA Phone

To activate the CDMA phone in your mobile computer, you need to contact your wireless carrier and set up an account.

You also need to provide the carrier with the Mobile Equipment Identifier (MEID) for the computer. You can find the MEID:

- on a label located in the battery compartment.
- on the outside of the computer shipping box.



Note: For the CDMA phone, settings are permanently stored in the WAN radio after activation. CDMA settings persist through a cold boot.

The activation process is slightly different for each CDMA carrier. Your carrier sales contact and an Intermec representative can guide you through the process. In general, you activate the CDMA phone as follows:

- 1** Contact your wireless provider and give the provider the MEID for the computer.
- 2** If your carrier is Sprint, reboot the computer. As soon as the Sprint network detects your phone, Hands-Free Activation (HFA) begins, and a series of notification messages appear. When activation is complete, a completion message appears and the WAN radio reboots. The phone is ready to use.

If your carrier is Verizon, tap **Start > Phone**, enter *228 on the phone keypad, and press **Talk**. After a short wait, a message appears, confirming either success or failure of the activation. After successful activation, the phone is ready to use.

- 3** (Optional) If you plan to use the network for data connections (such as browsing the web), you should enable automatic configuration of carrier settings in Intermec Settings.



Note: Data connections are to the public domain on your network.

Make a Phone Call

After you activate your UMTS or CDMA phone, you are ready to start making phone calls.

- 1** Press **Phone**.
- 2** Tap the keys to enter the telephone number you want to call, and tap **Talk**.

Make an Emergency Phone Call

You can use the phone to make an emergency phone call, even if the SIM card is missing from your UMTS phone or if you do not have a valid CDMA account. In either case, the phone shows that you have no service. However, if you dial certain emergency numbers (such as 112, 911, 000, 08, 118, 119, or 999) the call will go through.

Configure Phone Sounds

You can customize the ringtone, keypad sounds, and voicemail notification sounds for the phone.

- 1 Tap **Start** > **Phone** > the Menu button  > **Options**.

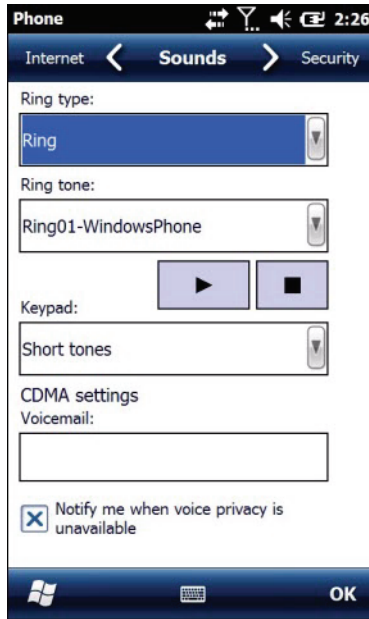

- 2 Select options for the phone sounds:
 - Select a **Ring type** from the list.
 - Select a **Ring tone** from the list. To hear the selected ring tone, tap the Play button.
 - Select a **Keypad** sound from the list.
 - Enter the name of the sound you want to use for voicemail notifications in the **Voicemail** field.
- 3 Tap **OK**.

How to Add and Switch Between Network Carriers

If your computer includes the software-defined radio, you can easily add carriers and switch between them as needed. When you enable automatic configuration of carrier settings through Intermec Settings, you only need to select a different carrier to change networks.

If you plan to add a carrier, you should enable automatic configuration of carrier settings before you activate the phone for the new carrier. This feature is disabled by default.

Enable Automatic Configuration of Carrier Settings

If you plan to add another WAN radio network carrier, you should enable automatic configuration of carrier settings before you activate the phone for the new carrier.



Note: Your computer must have the software-defined radio to use this feature.

- 1 Tap **Start** > **Settings** > **System** > **Intermec Settings**.
- 2 Tap **Communications** > **WWAN** > **Carrier Settings Auto Config**.
- 3 Select **Enabled** and tap **OK**.

Switch Carriers Using Intermec Settings

Use Intermec Settings to quickly change your WAN radio network carrier.



Note: Your computer must have the software-defined radio to switch carriers using this method.

- 1 Tap **Start** > **Settings** > **System** > **Intermec Settings** > **Communications** > **WWAN** > **Carrier Choice**.

- 2** Select a **Carrier** and tap **OK**.

If the update is successful, your new carrier appears in the WWAN settings list.

If the update is unsuccessful, the carrier does not change.

- 3** Tap **Ok** to exit Intermec Settings.

4

Use the Camera

Learn to use the color camera to take pictures and record videos, read bar codes, perform document capture, or perform signature capture.

About the Color Camera

The camera and flash are located on the back of the computer. You can use the camera for several tasks, including:

- Taking pictures and videos
- Reading bar codes
- Signature capture
- Document imaging

How to Take Pictures and Record Videos

You use the Pictures & Videos application to use the camera for taking pictures or recording videos, and to configure still photo and video recording settings.



Note: While the Pictures & Videos camera application is running, you cannot use either the imager or the camera to read bar codes. If Windows Media Player is running when you start the Pictures & Videos camera application, Windows Media Player is automatically closed.

In the Pictures & Videos application, you can:

- take, view, and edit pictures.
- switch between Still (camera) mode and Video mode.
- record and launch video clips stored on the computer or a microSD card.
- configure camera settings for taking pictures and videos.



Note: You must use Intermec Settings to configure camera settings for reading bar codes, document imaging, or signature capture.

You can send pictures and videos to others or save an image as the background on the Home screen.

Take a Picture

You run the Pictures & Videos application to use the camera for taking pictures. When you take a picture, the image is saved as a .jpg file and stored in the /My Documents/My Pictures folder.

- 1** Tap **Start > Pictures & Videos**.
- 2** Tap the **Camera** icon in the grid, or tap **Camera** on the taskbar.
- 3** Using the screen as a viewfinder, move the camera until you have the image you want to take a picture of.
- 4** Hold the computer as still as possible, and press **Enter** to take and save the picture.

If you select to save pictures to the main memory, the pictures are saved to permanent storage on the computer.

Record a Video

You run the Pictures & Videos application to use the camera for recording videos. Recorded video is stored in the /My Documents/My Pictures folder.

- 1** Tap **Start > Pictures & Videos**.
- 2** Tap the **Camera** icon in the grid or the **Camera** button on the Tile bar.
- 3** Tap **Menu > Video**.
- 4** Using the screen as a viewfinder, move the computer until you see the scene you want to record.
- 5** Press **Enter** to start recording.
- 6** When you are done, tap **Stop** or press **Enter** to stop recording and save the video.

If you choose to save your videos to main memory, the videos are saved to permanent storage on the computer.

Save Pictures and Videos to a microSD Card

By default, pictures and videos are saved to the /My Documents/My Pictures folder on the computer. You can save your pictures and video to a microSD card to easily transport them to another device.

- 1 Install a microSD card in the computer.
- 2 Tap **Start > Pictures & Videos**.
- 3 Tap the **Camera** icon.
- 4 Tap **Menu > Options**.
- 5 From the **Save file to** list, select **SD card** and tap **OK**.

Configure or Create Camera Scenes

Camera scenes are sets of preset values for camera settings. You can select or create a scene to accommodate your specific needs.

- 1 Tap **Start > SceneEditor**.
- 2 Select a **Scene** to configure and then tap .
Or, to create a new scene, tap **New**.
- 3 Configure the necessary settings. You do not need to configure all possible settings for the scene, and the values for settings you do not configure are determined by the last use.
If you are creating a new scene, type the name in the Scene box.
- 4 Tap **Save**.
- 5 When you are prompted to save the settings, tap **Yes**. The changes you made are saved.
- 6 Tap **ok** to close the message box.

Scene Settings

When you use SceneEditor to create a scene for the camera, you can configure these settings.

Scene Settings

Setting	Description
Exposure Metering	<p>The area of the image the camera uses to determine optimal exposure:</p> <ul style="list-style-type: none"> • Whole screen avg: Uses the image as a whole. • Center weighted avg: Uses the entire image but places emphasis on the center quarter of the image. • Center 1/4 averaged (default): Uses the center quarter of the image. • Lower 1/4 averaged: Uses the lower quarter of the image. • Upper 1/4 averaged: Uses the upper quarter of the image. • Lower 1/2 averaged: Uses the lower half of the image. • Upper 1/2 averaged: Uses the upper half of the image.
Exposure Compensation	<p>Exposure level of the image. Values are from -2.5 (darker, underexposed) to +2.5 (lighter, overexposed) in increments of 0.5. Default is 0.</p>
Focus	<p>Determines the focus method:</p> <ul style="list-style-type: none"> • Touch: Tap the screen to set the focal point. • Portrait: Uses a depth of field of 50 cm to the focal point. • Infinity: Uses a depth of field of greater than 4 m. • Extended: Uses a depth of field of 10 cm to infinity. • Macro: Uses a depth of field of 10 to 50 cm. • Auto: Focuses once within a depth of field range of 50 cm to infinity. • Continuous: Focuses when movement is detected in the scene. • Manual: You must enter a focus distance.
Focus Distance	<p>The distance at which the camera focuses. Values are 2.5 in, 4.5 in, 7.5 in, 1-3 ft, 3-9 ft, and Infinity (focuses the lens so that an infinitely distant object is in focus).</p>
Brightness	<p>Brightness level of the image. Manual settings are from -4 (very dark) to +4 (very light) in increments of 1. Default is 0.</p>

Scene Settings (Continued)

Setting	Description
Contrast	Amount of contrast in the image. Manual settings are from -4 (least contrast) to +4 (most contrast) in increments of 1. Default is 0.
Sharpness	Sharpness of the image. Manual settings are from -4 (very soft) to +4 (very sharp) in increments of 1. Default is 0.
Saturation	Color saturation level. Manual settings are from -4 (black and white) to +4 (maximum color) in increments of 1. Default is 0.
White Balance	Compensates for specific lighting conditions to produce true color images: <ul style="list-style-type: none">• Auto (default): Automatic White Balance (AWB) control.• Shade• Sunset• Face priority• Warm fluorescent• Twilight• Horizon• Incandescent• Office• Tungsten• Cloudy:• Daylight
Torch	Turns the LED on or off when streaming preview frames. If set to Auto, the camera system automatically determines when to turn the LED on and off when streaming preview frames.
Flash	The state of the camera flash when you take a picture: automatic, on, or off.

Scene Settings (Continued)

Setting	Description
Color Effects	Sets the color effect for pictures: <ul style="list-style-type: none"> • None • Negative • Solarize • Sepia • Gray • Natural • Vivid • Color Swap • Black Board • White Board • Aqua • Posterize • Black White
ISO	Sets the equivalent ISO film speed: Auto, 100, 200, 400, or 800.
Noise Reduction	Controls the amount of noise or graininess in the image.

Configure Camera Settings for Pictures and Videos

Use the Pictures & Videos application to configure the camera.



Note: You must use Intermec Settings to configure camera settings for reading bar codes, document imaging, or signature capture.

- 1 Tap **Start > Pictures & Videos**.
- 2 Tap the Camera icon.

3 Tap Menu.

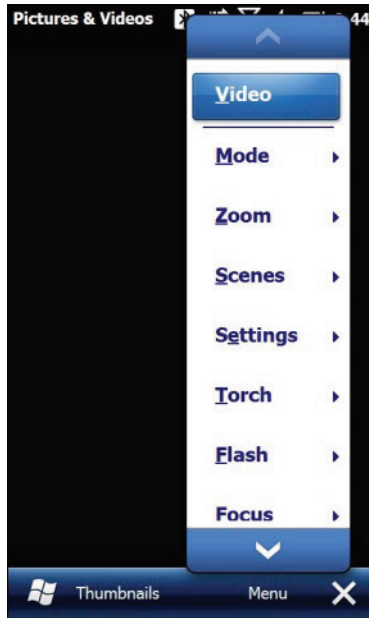

By default, all settings in the list apply to still pictures. To configure settings for taking videos, tap **Video** at the top of the list.

4 Select a setting to configure.

Camera Settings for Pictures and Videos

You can configure camera settings to meet the needs of your operating environment. In the Pictures & Videos application, camera settings are available from the menu when the camera is operating. Certain settings are only available when taking either Video or Still pictures, but not for both.



Note: You must use Intermec Settings to configure camera settings for reading bar codes, document imaging, or signature capture.

Camera Settings (Still)

Setting	Description	Choices
Mode	Determines the camera operating mode.	<ul style="list-style-type: none"> • Normal: Takes one picture. • Burst: Takes a series of five pictures. To change this value, in the Camera app tap Menu > Options and enter a new value in the Burst Mode Num. of images field. • Timer: Waits 10 seconds before taking the picture. To change this value, in the Camera app tap Menu > Options and enter a new value in the Timer mode Hold duration field.
Zoom	Sets the amount of digital zoom.	<ul style="list-style-type: none"> • 1.0x • 1.5x • 2.0x • 2.5x • 3.0x • 3.5x • 4.0x • 6.0x • 8.0x • Manual
Scenes	Selects a Scene for the camera. Scenes are sets of preset values for the camera, optimized for different environments.	<ul style="list-style-type: none"> • Auto • Manual • Van Interior • Office Store • Warehouse • Daylight • Night • Cloudy • Check • DocCap

Camera Settings (Still) (Continued)

Setting	Description	Choices
Settings	Brightness	<ul style="list-style-type: none"> • +100 • +50 • 0 • Manual
	Contrast	<ul style="list-style-type: none"> • +100 • +50 • 0 • -50 • -100 • Manual
	Sharpness	<ul style="list-style-type: none"> • +100 • +50 • 0 • -50 • -100 • Manual
	Saturation	<ul style="list-style-type: none"> • +100 • +50 • 0 • -50 • -100 • Manual
	Color Effects	<ul style="list-style-type: none"> • None • Negative • Solarize • Sepia • Gray • Natural • Vivid • Color Swap • Black Board • White Board • Aqua • Posterize • Black White

Camera Settings (Still) (Continued)

Setting	Description	Choices
	White Balance	<ul style="list-style-type: none"> • Auto • DayLight • Cloudy • Shade • Tungsten • Fluorescent • Incandescent • Horizon • Twilight • Warm Fluorescent • Sunset
	Exposure Compensation	From +2.5 to -2.5 in .5 increments.
	ISO Speed	<ul style="list-style-type: none"> • Auto • 100 • 200 • 400 • 800
	Exposure - Auto Exposure	Auto Exposure: <ul style="list-style-type: none"> • Auto • Night • Spot Light • Sport • Snow • Beach • Aperture • Small Aperture
	Exposure - Manual Exposure	Manual Exposure: <ul style="list-style-type: none"> • 1/200 • 1/100 • 1/50 • 1/33 • 1/20 • 1/8

Camera Settings (Still) (Continued)

Setting	Description	Choices
	Exposure - Metering	Metering: <ul style="list-style-type: none"> • Whole Average • Whole Center Weight • Center 1/4 Average • Lower 1/4 Average • Upper 1/4 Average • Lower 1/2 Average • Upper 1/2 Average
Torch	Sets whether or not to use the lighting LED.	<ul style="list-style-type: none"> • Off • On • Auto
Flash	Sets when to use the flash.	<ul style="list-style-type: none"> • Off • On • Auto • FillIn • RedEye
Focus	Sets the focus mode for the camera when shooting video.	<ul style="list-style-type: none"> • Auto (default) • Continuous • Touch • Macro • Portrait • Extended • Infinite
Full Screen	When enabled, this setting hides the task bar. To view the task bar, double-tap the bottom of the screen.	
Options (Camera tab)	Image filename prefix	Default is img.
	Location for saved still picture files	<ul style="list-style-type: none"> • Main Memory (default) • Flash File Store • RAM Drive

Camera Settings (Still) (Continued)

Setting	Description	Choices
	Flicker	<p>To limit possible problems with light/dark exposures when recording video, select the value matching the fluorescent light flicker in the environment:</p> <ul style="list-style-type: none"> • 50 Hz (typical in Europe) • 60 Hz (typical in North America)
	Resolution	<ul style="list-style-type: none"> • 1936 x 2592 (5.0 mp) • 1536 x 2048 (3.2 mp) • 1200 x 1600 (2.0 mp) • 1072 x 1920 (2.2 mp) • 960 x 1280 (1.2 mp) • 720 x 1280 (0.9 mp) • 768 x 1024 (0.8 mp) • 592 x 800 (0.5 mp) • 480 x 800 (0.4 mp) • 480 x 640 (0.3 mp) • 288 x 352 (0.1 mp) • 240 x 320 (0.1 mp) • 144 x 176 • 112 x 160 • 96 x 128
	JPEG quality	<ul style="list-style-type: none"> • High quality • Normal quality (default) • Low quality • Custom quality. If you select Custom, enter a value in the Custom field.
	Post processing	Enable or disable the noise filter.
	Burst mode number of pictures to take	Default is 5.
	Timer mode hold duration (in seconds)	Default is 5.

Camera Settings (Still) (Continued)

Setting	Description	Choices
	Hold snapshot (seconds)	Amount of time that a snapshot remains in the viewfinder before the screen returns to showing preview frames.
	Variable frame rate	Enable variable frame rate to allow the camera to automatically adjust the frame rate for better exposure. This may result in slower preview start.

Camera Settings (Video)

Setting	Description	Choices
Mode	Determines the camera operating mode.	<ul style="list-style-type: none"> • Normal: Records video immediately. • Timer: Waits 10 seconds before starting video recording. To change this value, with the Camera app in Video mode, tap Menu > Options and enter a new value in the Hold record field.
Zoom	Sets the amount of digital zoom.	<ul style="list-style-type: none"> • 1.0x • 1.5x • 2.0x • 2.5x • 3.0x • 3.5x • 4.0x • 6.0x • 8.0x • Manual

Camera Settings (Video) (Continued)

Setting	Description	Choices
Scenes	Selects a Scene for the camera. Scenes are sets of preset values for the camera, optimized for different environments.	<ul style="list-style-type: none"> • Auto • Manual • Van Interior • Office Store • Warehouse • Daylight • Night • Cloudy • Check • DocCap
Settings	Brightness:	<ul style="list-style-type: none"> • +100 • +50 • 0 • Manual
	Contrast	<ul style="list-style-type: none"> • +100 • +50 • 0 • -50 • -100 • Manual
	Sharpness	<ul style="list-style-type: none"> • +100 • +50 • 0 • -50 • -100 • Manual
	Saturation	<ul style="list-style-type: none"> • +100 • +50 • 0 • -50 • -100 • Manual

Camera Settings (Video) (Continued)

Setting	Description	Choices
	Color Effects	<ul style="list-style-type: none"> • None • Negative • Solarize • Sepia • Gray • Natural • Vivid • Color Swap • Black Board • White Board • Aqua • Posterize • Black White
	White Balance	<ul style="list-style-type: none"> • Auto • DayLight • Cloudy • Shade • Tungsten • Fluorescent • Incandescent • Horizon • Twilight • Warm Fluorescent • Sunset
	Exposure Compensation	From +2.5 to -2.5 in .5 increments.
	ISO Speed	<ul style="list-style-type: none"> • Auto • 100 • 200 • 400 • 800

Camera Settings (Video) (Continued)

Setting	Description	Choices
	Exposure - Auto Exposure	Auto Exposure: <ul style="list-style-type: none"> • Auto • Night • Spot Light • Sport • Snow • Beach • Aperture • Small Aperture
	Exposure - Manual Exposure	Manual Exposure: <ul style="list-style-type: none"> • 1/200 • 1/100 • 1/50 • 1/33 • 1/20 • 1/8
	Exposure - Metering	Metering: <ul style="list-style-type: none"> • Whole Average • Whole Center Weight • Center 1/4 Average • Lower 1/4 Average • Upper 1/4 Average • Lower 1/2 Average • Upper 1/2 Average
Torch	Sets whether or not to use the lighting LED.	<ul style="list-style-type: none"> • Off • On • Auto
Full Screen	When enabled, this setting hides the task bar. To view the task bar, double-tap the bottom of the screen.	
Options (Video tab)	Video filename prefix	Default is vid.

Camera Settings (Video) (Continued)

Setting	Description	Choices
	Location for saved video files	<ul style="list-style-type: none"> • Main Memory (default) • Flash File Store • RAM Drive
	Include audio when encoding video files	Enable or disable.
	Video resolution	<ul style="list-style-type: none"> • 720 x 1280 (720p) (Default) • 768 x 1024 (XGA) • 480 x 800 (WVGA) • 480 x 640 (VGA) • 288 x 352 (CIF) • 240 x 320 (QVGA)
	Video encoder	<ul style="list-style-type: none"> • H263 • H264 (default) • MPEG4 • WMV
	Video file format	<ul style="list-style-type: none"> • *.3gp • *mp4
	Hold record	When Timer mode is enabled, this value is the delay in seconds before recording begins.
	Enable video stabilization	Check the box to enable video stabilization.
	Enable video noise filtering	Check the box to enable video noise filtering.
	Enable video noise filtering	Check the box to enable video noise filtering.
	Frame rate	<ul style="list-style-type: none"> • 15 fps • 30 fps (default) • Custom. Adjust the frame rate with the slider.

How To Read Bar Codes With the Camera

You can use the camera to read bar codes. When you read bar codes with the camera, the computer treats the camera as it would any input device, such as a Bluetooth scanner, and bar code data is sent to an application as if it came from a scanner or imager.



Note: To read bar codes using the camera, you must use Intermec Settings to configure bar code symbology decode settings.

There are two ways to enable reading bar codes with the camera:

- You can use the Profile Settings application to enable bar code reading. The computer uses the current symbology decode settings to read bar code data.
- You can configure individual parameters in Intermec Settings (**Data Collection > Camera > Scanner Settings**) to enable bar code reading.



Note: Parameters set in **Data Collection > Internal Scanner > Scanner Settings** are applied to the internal imager, not the camera.

Enable or Disable Reading Bar Codes With the Camera

You use the Profile Settings application to enable or disable reading bar codes with the camera. Reading bar codes with the camera is disabled by default.



Note: You can also enable reading bar codes by setting parameters in Intermec Settings.

- 1 Tap **Start > ProfileSettings**.
- 2 Tap **Camera**.
- 3 In the Camera menu, tap **Enable bar code scan** or **Disable bar code scan** as necessary.
- 4 Tap **OK**.

Read Bar Codes With the Camera

After you enable reading bar codes with the camera, the computer sends bar code data to applications as keyboard input.



Note: Before you use the camera to read bar codes, make sure the camera window is clean.

- 1 Start the application that is to receive the bar code data.
- 2 Position the computer about 20 cm (8 in) over the bar code you want to read. Make sure nothing is blocking the camera lens.
- 3 Press and hold the **Scan** button. The screen turns into a viewfinder with an aiming bar across the middle of the screen.
- 4 Center the aiming bar over the bar code. The bar code is read and the data appears in the active application.

If the computer does not read the bar code right away, release the **Scan** button and try again. You may need to move the computer closer to or further away from the bar code for best results. You may also need to select a different focus mode depending on your environment.

Camera Settings for Reading Bar Codes

To use the camera for reading bar codes, you must use the Intermec Settings application to configure the camera. From the main screen of Intermec Settings, select **Data Collection > Camera > Camera Settings**.

Optimized Imager Mode (Advanced) Settings and Descriptions

Setting	Description	Choices
Imager decode mode		<ul style="list-style-type: none">• Linear imager emulation• 2D imager
Lighting mode		<ul style="list-style-type: none">• Illumination LED priority• Aperture priority
Lighting goal		Default is 30.

Optimized Imager Mode (Advanced) Settings and Descriptions

Setting	Description	Choices
Illumination level		Default is 3.
Initial 1D search area		<ul style="list-style-type: none"> • Center • Full • Smart raster
Damaged 1D codes		<ul style="list-style-type: none"> • Disable • Enable

Viewfinder and Focus Settings and Descriptions

Setting	Description	Choices
Enable viewfinder		Enable or disable.
Focus mode	Sets the focus mode for the camera when reading bar codes, document imaging, or capturing signatures.	<ul style="list-style-type: none"> • Manual • Continuous autofocus • Single shot autofocus • Macro • Extended (10 cm to infinity)
Manual focus value	When Focus Mode is set to Manual, this value sets the manual focus level.	Default is 65. Set to 0 for infinity, or 255 for closeups.

Lighting Settings and Descriptions

Setting	Description	Choices
Torch		<ul style="list-style-type: none"> • Off • On • Auto

How to Perform Document Capture with the Camera

You can use the camera to perform document capture. Document capture is a specialized feature for taking a picture of a document, and automatically applying perspective correction to the image so that only the document appears in the image.

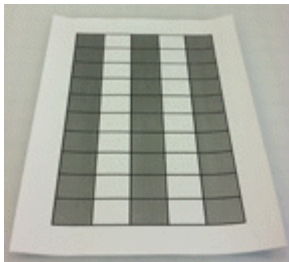

Document Capture Image with No Perspective Correction

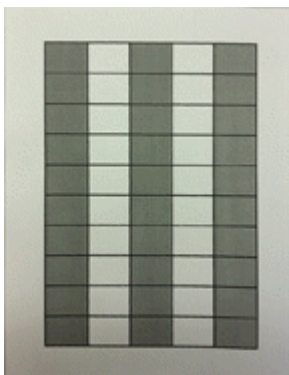

Document Capture Image with Perspective Correction

There are two ways to enable document imaging with the camera:

- You can use the Profile Settings application to enable document capture. The computer uses the current document capture settings to apply perspective correction (and other postprocessing features if specified).
- You can configure individual parameters in Intermec Settings to enable document capture.



Note: To perform document capture using the camera, you must use Intermec Settings to configure all document capture settings.

Enable or Disable Document Capture with the Camera

You use the Profile Settings application to enable or disable document capture with the camera. Performing document capture with the camera is disabled by default.



Note: You can also enable document capture by setting parameters in Intermec Settings.

- 1 Tap **Start** > **ProfileSettings**.
- 2 Tap **Camera**.
- 3 In the Camera menu, tap **Enable document image** to enable document capture.
To disable document capture, tap **Disable bar code scan**.
- 4 Tap **OK**.

Perform Document Capture with the Camera

After you enable document capture with the camera, document capture images are saved to the MyDocuments\MDI directory on the computer by default.

- 1 Place your document on a flat surface.
- 2 Position the computer a few inches above the center of the document.
- 3 Press and hold the **Scan** button. The video preview and camera viewfinder frame appear.
When the viewfinder tries to detect the document edges, the viewfinder frame is red and pulses slightly.
- 4 Move the camera to align the document edges with the viewfinder. When the viewfinder detects the document edges, the viewfinder

frame turns white and a red target appears. The camera tries to focus on the center of the document.

When the focus and distance are correct, the target turns white and the document image is captured.

- 5 To view the document capture image, you can browse to MyDocuments\MDI and tap the image file to view it.

Camera Settings for Document Imaging

To use the camera for document imaging, you must use the Intermec Settings application to configure the camera. From the main screen of Intermec Settings, select **Data Collection > Camera > Camera Settings > Document Imaging**.

Settings	Description	Choices
Enable document imaging	Enables or disables document imaging.	<ul style="list-style-type: none">• Disable• Enable without decode
Focus check	Sets the acceptable focus level for document imaging.	<ul style="list-style-type: none">• Disable (no focus check)• Medium level• High level
Image/area to capture ratio		Default is 30.
Output compression	Sets the image compression level.	<ul style="list-style-type: none">• Bitmap• JPEG• TIFFG4
Output compression quality	Sets the output compression quality level.	Default is 60.
Perspective correction	Corrects the document image for perspective.	Enable (default) or disable.
Color conversion		<ul style="list-style-type: none">• None (default)• Monochrome• Enhanced monochrome (TIFF)

Settings	Description	Choices
Conversion threshold		<ul style="list-style-type: none"> • Very dark (default) • Dark • Normal • Bright • Very bright
Contrast enhancement		<ul style="list-style-type: none"> • None (default) • Photo • Black on white • White on black
Text enhancement		<ul style="list-style-type: none"> • None • Low • Medium (default) • High
Noise reduction	Sets the noise reduction level.	Default is 3.
Image rotation	Rotates the image counterclockwise by a set amount.	<ul style="list-style-type: none"> • None (default) • 90 degrees • 180 degrees • 270 degrees
Image lighting correction		Default is disabled.
Document file name	Name for the document image file.	Default is doc_\$(num).

5

Use GPS

The computer comes equipped with an integrated Global Positioning System (GPS) receiver if your computer has phone capability (WWAN radio). The GPS receiver can deliver standards-based National Marine Electronics Association (NMEA) data strings to GPS applications.

About the Integrated GPS on Your Computer

Intermec recommends that you use the GPS Intermediate Driver (GPSID) instead of directly accessing the GPS hardware. The GPSID is a Microsoft hardware component that interacts between applications and the GPS hardware.

As a Microsoft software component, the GPSID:

- allows multiple applications to simultaneously access the GPS data stream.
- provides access to GPS data without requiring applications to recognize and parse NMEA syntax.

Use the GPSID Installed on the Computer

To use the GPSID installed on your mobile computer, you need to configure the GPSID settings.

- 1 Tap **Start > Settings > System > External GPS**. The GPS Settings screen appears with Programs selected.

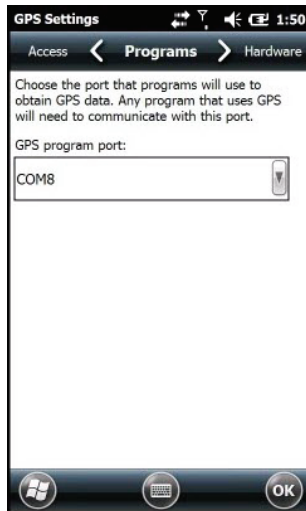

- 2 Select the COM port that you want your program to use to get GPS data from your computer.

- 3 Tap **Access** in the horizontal scroll bar and select the **Manage GPS automatically** check box.

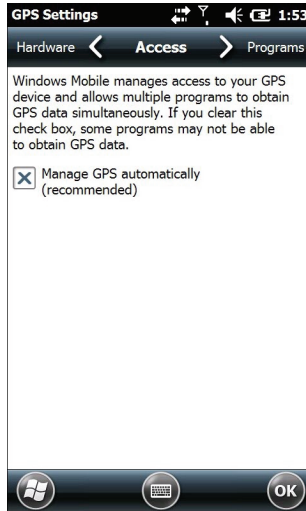

- 4 Tap **OK**.

About the GPS Module Operating Modes

The integrated GPS module has three operating modes:

- Standalone
- MS Assisted (Mobile Station Assisted)
- gpsOneXTRA™ (UMTS computers only)

In Standalone mode, the GPS module relies solely on GPS satellites to determine position.



Note: The CN51 also supports GLONASS.

In MS Assisted mode, the computer can determine position without receiving GPS signals directly from satellites. Instead, the computer receives GPS signals and information provided by the cellular network. Even when the computer can receive a satellite signal, MS Assisted can improve position accuracy and reduce the time to determine initial position (Time-to-first-Fix). Check with your cell phone carrier for availability and pricing for MS Assisted service.

Qualcomm’s gpsOneXTRA Assistance technology provides enhanced operation for Standalone GPS. This option enables the UMTS-enabled computer to automatically download a small assistance data file from the XTRA servers through a brief internet access session. To use this option, you must have a valid and activated WAN data connection.



Note: Internet connection fees may apply.

Another option you can configure with iGPS is the fix interval. The fix interval defines how often the GPS provides new information. Larger intervals use less power, but many applications require small intervals to work correctly. The default for fix interval, in seconds, is 4. The Flexible Network Radio has a maximum interval of 4.

Improve GPS Performance on the Computer

Use the iGPS application to improve the performance of the GPS on your computer. Any time you change the GPS settings, the phone automatically resets.

- 1 Go to **Start > Settings > System > iGPS**.
- 2 In the **Fix Interval** tab, enter a value for the fix interval. The default setting is 4 and should be optimized for most applications.
- 3 Tap the **Fix Type** tab and select one of these options: Standalone (1), MS assisted (2), or **Enable gpsOneXTRA** (check box).



Note: GLONASS reception is enabled by default. Intermec recommends that you keep GLONASS enabled for better accuracy. To disable GLONASS, make sure that **Enable Glonass** is not selected.

- 4 Tap **OK**.

6

Configure the Computer

Use this chapter to learn about the available methods for configuring your computer and how to use Intermec Settings. You can also use this chapter to learn how to configure network communications and wireless security.

How to Configure the Computer

You can configure many parameters on the computer such as the bar code symbologies it decodes or the network settings. The values you set for these parameters determine how the computer operates.

There are several ways to configure the computer:

- Directly on the computer. You can use Intermec Settings directly on the computer to change only the settings on that computer.
- Remotely using Intermec SmartSystems. With SmartSystems, you can remotely configure all of your mobile computers as well as other SmartSystems-enabled Intermec devices and peripherals.
- Using a third-party device management product that supports the computer and Intermec Settings, such as Soti MobiControl or Wavelink Avalanche.
- Using configuration bundles that you create with SmartSystems.

About Intermec Settings on the Computer

Use Intermec Settings to configure parameters for Intermec applications on the computer, as well as some device-specific parameters like volume. You can configure parameters for important functions like data collection and communications. You can also password protect Intermec Settings to prevent users from making changes to the configuration settings.

Start Intermec Settings

Use Intermec Settings to configure parameters for Intermec applications and some device-specific parameters. Intermec Settings is located on the System screen.

- Tap **Start > Settings > System > Intermec Settings**. The Intermec Settings Main Menu appears.

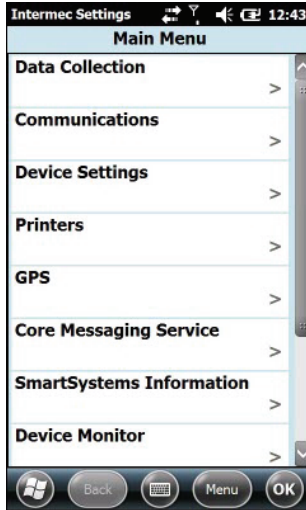

About the Structure of Intermec Settings

Use the following tables to help find the parameters in Intermec Settings that you want to configure. Each table contains the parameters for one of the Intermec Settings Main Menu options.

Most parameters are saved as soon as you tap **OK**. Some settings, such as Security Choice, require you to reboot the computer for the changes to take effect.

Data Collection Menu

Data Collection Options	Parameters You Can Configure
Internal Scanner	<ul style="list-style-type: none"> • Enable Scanner Port • Symbologies • Symbology Options • Scanner Settings • Imager Settings • Decode Security

Data Collection Menu (Continued)

Data Collection Options	Parameters You Can Configure
Bluetooth Scanners	<ul style="list-style-type: none"> • BT-Configure on Connect <p>When Bluetooth scanners are connected, you can also configure:</p> <ul style="list-style-type: none"> • Enable scanner port • Symbologies • Symbology Options • Scanner settings • Bluetooth scanner settings • Imager settings • Decode security
Camera	<ul style="list-style-type: none"> • Enable camera port • Symbologies • Symbology Options • Scanner Settings • Camera Settings • Decode Security
Magstripe Reader	<ul style="list-style-type: none"> • Enable Magstripe Reader • Magstripe Reader Settings

Communications Menu

Communications Options	Parameters You Can Configure
Device Name	Device Name
802.11 Radio	<ul style="list-style-type: none"> • Radio Enabled • Security Choice • Security Settings (Funk or Microsoft) • IP Settings • Certificates • Radio Bands • Allow Security Changes
Ethernet Adapter	IP Settings
Bluetooth	Bluetooth Settings

Communications Menu (Continued)

Communications Options	Parameters You Can Configure
WWAN	<ul style="list-style-type: none"> • Radio State • Carrier Choice • Carrier Settings • Information

Device Settings

Device Settings Options	Parameters You Can Configure
Backlight	Display and Keypad Settings
Date and Time	Date and Time Settings
Features Disabled by Policy	
Good Read	<ul style="list-style-type: none"> • Internal Scanner • Bluetooth Scanner
IDL Runtime Versions	(Read-only) IDL runtime file versions (ITC50, ITCScan)
Keypad	<ul style="list-style-type: none"> • Button Remapping • Green/Orange keys lock option
Power Management	<ul style="list-style-type: none"> • Power Button • Battery Power • External Power • Device Off Sensor
Profile Settings Application	Sets whether these parameter options appear in Profile Settings: <ul style="list-style-type: none"> • Camera • Power • Scanning
Screen	<ul style="list-style-type: none"> • Screen Rotation • Screen Rotation Sensor
Security	Enables or disables ActiveSync, the SD card, A USB external drive, and image capture.

Device Settings (Continued)

Device Settings Options	Parameters You Can Configure
Sounds	<ul style="list-style-type: none">• Beeper and Voice• Good read vibrate intensity• Headset beeper• Screen Taps• Key Clicks
System Component Versions	Read-only
USB	USB function driver

Printers Menu

Printer Options	Parameters You Can Configure
Printer (connected through Bluetooth)	Printer Settings



Note: The Printers menu displays settings for Bluetooth connected printers. The settings that appear in the menu are dependent on the printer that is paired with the device. The printer needs to be using the Wireless Printing application.

GPS Menu

GPS Options	Parameters You Can Configure
Bread Crumbing	Enable or disable bread crumbing.

Core Messaging Service Menu

Core Messaging Service Options	Parameters You Can Configure
Server IP	Read-only
Associated Server IP	Associated Server IP
Broadcast Name	Broadcast name
Port	Read-only
Keep Alive Ping Interval	Keep Alive Ping Interval

SmartSystems Information Menu

SmartSystems Information Options	Parameters You Can Configure
Identity	Identity Information (hardware version, firmware version, OS version, and so on) (Read-only)
Administrator	Administrator Settings (name, phone, and email)
Location	Location Settings (country, state, city, campus, and detail)
Information	Device Notes (Read-only)

Device Monitor Menu

Device Monitor Options	Parameters You Can Configure
Device Health Controls	<ul style="list-style-type: none"> • Enable Health Data Collection • Enable Device Health Application • Enable Blue Light (LED) • Set Rule File Location • Set Data Refresh Periods
Device Health Screen Captures	<ul style="list-style-type: none"> • Directory • Screen Captures Allowed
Disabled Executables	Read-only
Device Wipe	<ul style="list-style-type: none"> • Enable Wipe • Interval

License Manager Menu

License Manager Options	Parameters You Can Configure
About	Read-only
License Vault	Read-only

Virtual Wedge Menu

Virtual Wedge Options	Parameters You Can Configure
Enable Virtual Wedge	Enable Virtual Wedge

Virtual Wedge Menu (Continued)

Virtual Wedge Options	Parameters You Can Configure
Virtual Wedge Method	Virtual Wedge Method (Adapt to application, character mode, or block mode)
Barcode Scanner Wedge	<ul style="list-style-type: none">• Barcode Scanner Grid• Label Encoding (Code Page)
Magstripe Reader Wedge	Magstripe Reader Grid

Location Services Menu

Location Services Options	Parameters You Can Configure
Server	<ul style="list-style-type: none">• Port• Enable Server
Virtual GPS	Virtual GPS Settings

How to Navigate in Intermec Settings

You can easily navigate through the screens in Intermec Settings to find the parameters you need to configure:

- Tap inside a text field to be able to enter text into it.
- Tap a field once to select it.
- If you see a ... next to a menu item, there is only one more screen available. Tap the menu item to access this screen.
- If you see a > next to a menu item, there are more screens available in the next level. Tap the menu item to access these screens.
- Use the up and down arrow keys to move up and down the menu.
- To move back a level in the menu, tap **Back** or **Cancel** on the Tile bar.
- To exit Intermec Settings, tap **Menu** > **Exit** or **OK**.

Enable Intermec Settings Password

You can protect Intermec Settings from other users by enabling a password.

- 1 Start Intermec Settings.
- 2 Tap **Menu > Enter Password**.
- 3 Select the **Enable password** checkbox.
- 4 Type your password in the **Enter:** text box.
- 5 Retype your password in the **Confirm:** text box.
- 6 (Optional) Select the **Use password to protect CAB Installation** if you want to restrict the installation of .cab files.
- 7 Tap **OK**.

Restore Default Settings

The easiest way to restore default settings on your computer is to use Intermec Settings. You can restore all default settings on your computer or restore default settings for a specific menu item in Intermec Settings.



Note: When you restore default settings, only the settings for visible menu items are restored. The settings for hidden menu items are not affected.

- 1 Start Intermec Settings.
- 2 Restore the default settings:
 - To restore all default settings, tap **Menu > Restore all Defaults**.
 - To restore default settings for one menu item, navigate to the menu and tap **Menu > Restore Menu Defaults**.
- 3 When prompted, tap **Yes** to restore the default settings.
If you are prompted to refresh the computer, tap **Yes**.

Configure the Computer Remotely with SmartSystems

You can use Intermec Settings from a SmartSystems console to remotely configure all the Intermec computers. For help using Intermec Settings, click **Help** > **Contents**. For information on all the parameters in Intermec Settings, see the *Intermec Settings Command Reference Manual*.

- 1 In the SmartSystems console, select a computer and then right-click on it. A list appears.
- 2 Select **Start Intermec Settings**.
- 3 Configure the settings you want to change. As you select parameters, help for each parameter appears in the upper right pane.
- 4 When you are done making changes, select **File** > **Save Settings**.

About Network Communications

You can use the mobile computer in your wireless or wired data collection network. You can connect your computer using:

- 802.11 radio communications.
- Ethernet communications.
- Bluetooth communications.
- USB and serial communications.

Configure 802.11 Radio Communications



Caution: Make sure all components with antennas are at least 30 cm (1 ft) apart when power is applied. Failure to comply could result in equipment damage.

The CN51 has an 802.11b/g/n or 802.11a/b/g/n radio to transfer data using wireless communications. Before you configure radio communications, you need to have your wireless network set up including your access points.

By default, the 802.11 radio is disabled. Use the following procedure to enable the Wi-Fi radio using Intermec Settings.

- 1** Tap **Start > Settings > System > Intermec Settings**.
- 2** From the Intermec Settings main menu, tap **Communications > 802.11 Radio > Radio Enabled**.
- 3** Select the **Radio Enabled** check box and tap **OK**. By default, the computer uses Funk security and enables DHCP.

To enable both the 2.4 GHz and 5.0 GHz bands for the 802.11a/b/g/n radio, from the Intermec Settings 802.11 Radio menu, tap **Radio Bands** and select **a/b/g (2.4 and 5.0 GHz)**.
- 4** Use Intermec Settings to configure the parameters you need to use for communications with your network.
- 5** Configure 802.11 security.

About Bluetooth Communications

The CN51 is Bluetooth-enabled, which lets you connect to other Bluetooth devices such as:

- scanners.
- printers.
- audio devices.

You need to turn on the Bluetooth radio before you can discover and connect to Bluetooth devices. By default, the radio is turned off.

The Bluetooth radio maintains its current state through a warm or cold boot and maintains virtual COM ports. If you clean boot the computer, you must recreate pairings to devices.

System bar icons indicate Bluetooth status.

Turn On the Bluetooth Radio

You need to turn on the Bluetooth radio in the mobile computer before you can discover and connect to Bluetooth devices. By default the radio is turned off.

- 1 Tap **Start > Settings > Bluetooth > Mode** tab.
- 2 Tap **Turn on Bluetooth**.

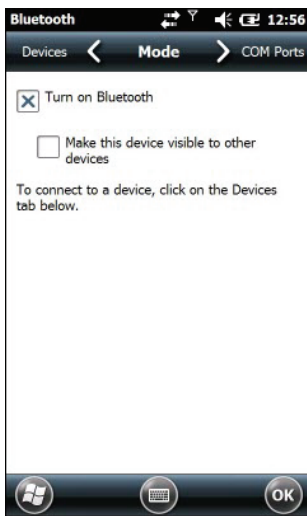

- 3 (Optional) If you want this computer to be visible to other Bluetooth devices, tap **Make this device visible to other devices**.
- 4 Tap **OK**.

Connect a Bluetooth Scanner

You can connect the computer to an Intermec Bluetooth scanner, such as the SF51 or SR61. Make sure that the Bluetooth radio in the computer is turned on before you try to connect to a scanner.

- 1 Tap **Start > Settings > System > Wireless Scanning**.

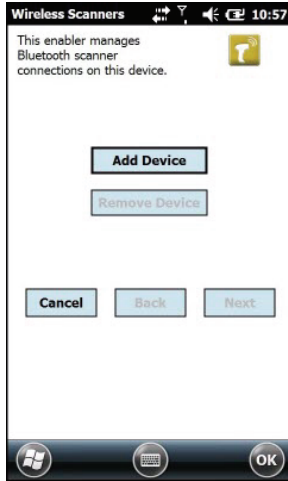

- 2 Tap **Add Device**.
- 3 Select **Quick Connect**, **Search**, or **Manual**. Follow the instructions on the screen to add a Bluetooth scanner.

After you add a Bluetooth scanner, you can configure scanner settings and parameters in Intermec Settings.

Create a Configuration Bar Code with EasySet

To connect a Bluetooth scanner to the computer, you can read a configuration bar code with the scanner. You create the bar code using Intermec EasySet.



Note: To create the configuration bar code, you need the computer Bluetooth address. The address is on the labels located on the outside of the computer shipping box, and on the packet of information that ships with the computer.

- 1 Go to the Intermec website at www.intermec.com.
- 2 Click the **Products** tab.
- 3 On the Products page, click **Computers > Handheld Computers > your computer model number > the Downloads tab > Easyset ver. 5.x.x.x**.
- 4 Follow the instructions to download and install EasySet.
- 5 Open EasySet and select **Interface > Bluetooth > Connect/disconnect > Compose BT address**. The Bluetooth - Connect/disconnect - Compose BT address screen appears.
- 6 Enter the BT address listed on the labels that shipped with your computer.
- 7 Click **OK**.

Connect to a Bluetooth Printer

You can connect the computer to a Bluetooth printer and use the computer to wirelessly print to the printer. Make sure that the Bluetooth radio in the computer is turned on before you try to connect to an Intermec Bluetooth printer, such as the PB21, PB50, or PR3. To configure your computer for printing wirelessly using Bluetooth, you need to:

- create an application that opens the wireless printing COM port on the computer. For help, see the Bluetooth Resource Kit, which is part of the Intermec Developer Library (IDL), available from the Intermec website at www.intermec.com/idl.
- select the current Bluetooth printer on the computer. For help, see the next procedure.



Note: You can also print wirelessly using Microsoft APIs with Bluetooth extensions for Winsock and Bluetooth virtual COM ports. For help, see the Bluetooth Resource Kit documentation.

1 Tap **Start** > **Settings** > **System** > **Wireless Printing**.

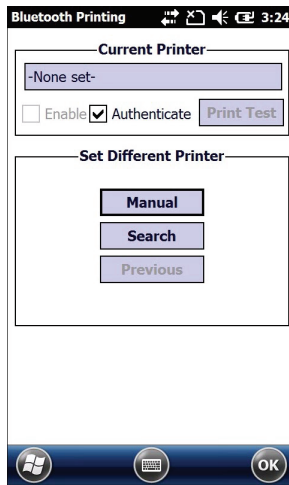

2 Tap **Search** to find a printer, or tap **Manual** to enter a device address. Follow the onscreen instructions to select the current Bluetooth printer.

3 (Optional) Tap **Print Test Page**. The printer prints out a test page.

Connect a Bluetooth Audio Device

Use the Bluetooth Audio applet to discover, activate, and connect to Bluetooth audio devices such as a headset.

- 1 Select **Start > Settings > System > Bluetooth Audio**. The Bluetooth Audio screen appears.

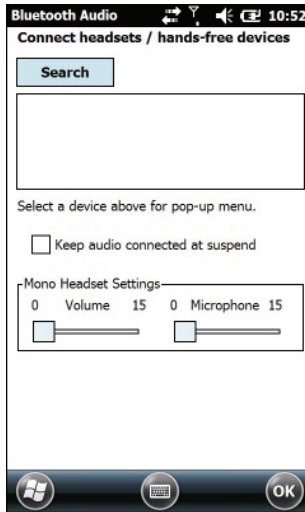

- 2 Follow the onscreen instructions to discover and connect to a Bluetooth audio device.



Note: If a wired audio device such as a headset is already connected to the computer, Bluetooth audio receives priority when a Bluetooth audio device is connected.

About Serial and USB Communications

You can use these accessories to transmit data to and receive data from another device through serial or USB communications:

- AV10 vehicle dock
- AA21 RS-232 adapter
- AD27 single dock
- Desktop USB adapter
- USB snap-on adapter
- RS-232 DEX adapter

For information on these accessories, contact your local Intermec representative.

About Wireless Security

The computer provides these security solutions for your wireless network:

- Wi-Fi Protected Access 2 (WPA2™)
- Wi-Fi Protected Access (WPA)
- 802.1x
- LEAP (Funk security only)
- WEP

You use either Funk or Microsoft security to implement your wireless security solution. Intermec recommends WPA2 security with PSK (Personal) or 802.1x (Enterprise) key management.

Before you set security, you need to enable the radio, set the date, and set the SSID on your computer. To use 802.1x security, you need to load a root certificate on your computer. To use transport layer security (TLS) with 802.1x security, you also need to load a user certificate.

Load a Certificate

To use transport layer security (TLS) with 802.1x security, you need a unique client certificate on the computer and a trusted root certificate authority (CA) certificate.

- 1 Start Intermec Settings.
- 2 Select **Communications** > **802.11 Radio** > **Certificates**.

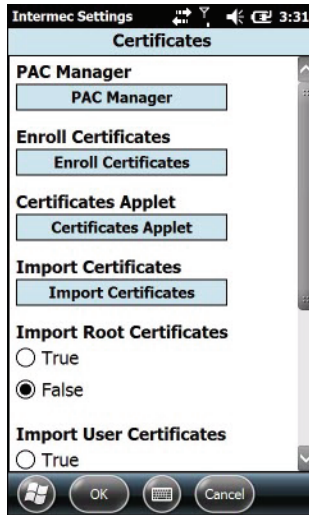

- 3 Tap **Import Certificates**.
- 4 To import a certificate chain:
 - a Tap the **Import PFX** tab.
 - b Next to the **Select pfx to import** field, tap <<<.
 - c Find and select the root certificate.
 - d If necessary, enter the **Password of pfx**.
 - e Tap **Import Certificate**.
- 5 To import user and root certificates from a Microsoft IAS server:
 - a Tap **Web Enrollment**.
 - b To log on to the server, enter the **User**, **Password**, and **Server** (IP Address).

- c** Tap **OK**.
- d** When you are prompted to load the root certificate, tap **OK**.
- e** When the message box appears to let you know the certificate has been added, tap **OK**.

How to Make Your Security Choice

The computer supports Funk and Microsoft® security. Your security choice depends on your network security needs:

- Choose Funk security if you use the computer in a static environment that requires a high level of security. Funk security provides CCX v4 compliance, support for LEAP and TTLS, and configuration for up to four profiles. Funk security is the default security setting on the computer.
- Choose Microsoft security if you primarily use the computer to connect to Wi-Fi hotspots.

Select a Funk Security Profile

You can define up to four profiles for Funk security. Different profiles let your computer communicate in different networks without having to change all your security settings. For example, you may want to set up one profile for the manufacturing floor and one for the warehouse. By default, the active profile is Profile 1.

- 1** Start Intermec Settings.
- 2** Select **Communications > 802.11 Radio > Funk Security**.
- 3** Tap a profile to expand it.
- 4** (Optional) In the **Profile Label** text box, enter a meaningful name for your profile.
- 5** Configure your security settings. For help, see the next sections.
- 6** Repeat Steps 3 through 5 for each profile you want to define.
- 7** To set the active profile, tap **Active Profile** and select a profile from the list.
- 8** Save your settings.

Configure WPA or WPA2 Enterprise (802.1x) Security with Funk Security

Before you set WPA-802.1x or WPA2-802.1x security with Funk, you need to configure your authentication server and authenticators. To use TLS protocol, you also need to load a user and root certificate. On your computer, you need to enable the radio and set the date.

- 1 Start Intermec Settings.
- 2 Select **Communications > 802.11 Radio > Funk Security**.
- 3 Select a Funk security profile to configure.
- 4 Enter the **SSID**.
- 5 For **Association**, select **WPA** or **WPA2**.
The default encryption is **TKIP** or **AES**, respectively.
- 6 For **8021x**, select **TTLS**, **PEAP**, **EAP-FAST**, or **TLS**.
- 7 If you selected **TTLS**, **PEAP**, or **EAP-FAST**:
 - a For **Prompt for Credentials**, select **Enter credentials now**.
 - b Enter a **User Name** and **User Password**.
- 8 If you selected **TLS**, enter a **User Name** and **Subject Name**.
- 9 For **Validate Server Certificate**, select **Yes**.
- 10 Tap **OK**.

Configure WPA or WPA2 Personal (PSK) Security with Funk Security

Before you set WPA or WPA2 Personal (PSK) security, you need to know the pre-shared key for your access point or passphrase for your authenticator. On your computer, you need to enable the radio and set the date.

- 1 Start Intermec Settings.
- 2 Select **Communications > 802.11 Radio > Funk Security**.
- 3 Select a Funk security profile to configure.
- 4 Enter the **SSID**.

5 For **Association**, select **WPA** or **WPA2**.

The default encryption is **TKIP** or **AES**, respectively.

6 For **802.1x**, select **None**.

7 For **Pre-Shared Key**, enter the pre-shared key or passphrase:

- Enter the pre-shared key (0x followed by 32 hexadecimal pairs) for your access point.
- Enter the passphrase (8 to 63 ASCII characters) for your authenticator. The computer internally converts the passphrase to a pre-shared key.

8 Tap **OK**.

Configure 802.1x Security with Funk Security

Before you set 802.1x-WEP security with Funk security, you need to enable the radio on your computer and set the date. To use TLS protocol, you also need to load a user and root certificate. Intermecc recommends that you use WPA2-802.1x instead of 802.1x-WEP if possible.

1 Start Intermecc Settings.

2 Select **Communications > 802.11 Radio > Funk Security**.

3 Select a Funk security profile to configure.

4 Enter the **SSID**.

5 For **Association**, select **Open**.

6 For **Encryption**, select **WEP**.

7 For **802.1x**, select **TTLS**, **PEAP**, or **TLS**.

8 If you selected **TTLS** or **PEAP**:

- a** For **Prompt for Credentials**, select **Enter credentials now**.
- b** Enter a **User Name** and a **User Password**.

9 If you selected **TLS**, enter a **User Name** and **Subject Name**.

10 For **Validate Server Certificate**, select **Yes**.

11 Tap **OK**.

Configure LEAP Security with Funk Security

Before you set LEAP security, you need to enable the radio and set the date on your computer.

- 1 Start Intermec Settings.
- 2 Select **Communications > 802.11 Radio > Funk Security**.
- 3 Select a Funk security profile to configure.
- 4 Enter the **SSID**.
- 5 For **Association**, select **Open**, **WPA**, **WPA2**, or **Network EAP**.
The default encryption is **TKIP** for **WPA**, **AES** for **WPA2**, and **WEP** for **Open** or **Network EAP**.
- 6 For **Prompt for Credentials**, select **Enter credentials now**.
- 7 Type a **User Name** and **User Password**.
- 8 Save your settings.

Configure Static WEP Security with Funk Security

Before you set static WEP security with Funk security, you need to enable the radio on your computer and set the date. Intermec recommends that you use WPA2-PSK instead of WEP if possible.

- 1 Start Intermec Settings.
- 2 Select **Communications > 802.11 Radio > Funk Security**.
- 3 Select a Funk security profile to configure.
- 4 Enter the **SSID**.
- 5 For **Association**, select **Open**.
- 6 For **Encryption**, select **WEP**.
- 7 For **8021x**, select **None**.

- 8** Enter an ASCII key or hex key value for each key you want to use (**Key 1** through **Key 4**):
 - For 64-bit WEP, enter a 5-byte value: 5 ASCII characters or 0x followed by 5 hexadecimal pairs.
 - For 128-bit WEP, enter a 13-byte value: 13 ASCII characters or 0x followed by 13 hexadecimal pairs.
- 9** Select the **Transmit key** you want to use to transmit data.
- 10** Tap **OK**.

Use Open (No Security) Associations with Funk Security

To create an open network, you can set no security with Funk security.

- 1** Start Intermec Settings.
- 2** Select **Communications > 802.11 Radio > Funk Security**.
- 3** Select the active Funk security profile.
- 4** Enter the **SSID**.
- 5** For **Association**, select **Open**.
- 6** For **Encryption**, select **WEP**.
- 7** Tap **OK**.

Select Microsoft as Your Security Choice

The default security setting is Funk. If you want to use Microsoft Wireless Zero Configuration (WZC) security, you need to select it as your security choice.

- 1** Start Intermec Settings.
- 2** Select **Communications > 802.11 Radio > Security Choice**.
- 3** Select **Microsoft Security**.
- 4** Tap **Yes** to save your settings and reboot the computer.

The computer reboots and starts with Microsoft Security as the Security Choice.

Configure WPA or WPA2 Enterprise (802.1x) Security with Microsoft Security

Before you set WPA-802.1x or WPA2-802.1x security with Microsoft, you need to configure your authentication server and authenticators. To use TLS protocol, you also need to load a user and root certificate. On your computer, you need to enable the radio and set the date.

- 1 Start Intermec Settings.
- 2 Select **Communications > 802.11 Radio > Microsoft Security**.
- 3 Enter the **Network name (SSID)**.
- 4 For **Infrastructure Mode**, select **Infrastructure**.
- 5 For **Network Authentication**, select **WPA** or **WPA2**.
The default encryption is **TKIP** or **AES**, respectively.
- 6 For **802.1X Authentication**, select **TLS** or **PEAP**.
- 7 Select **Hidden Network**.
- 8 Tap **OK**. The User Logon dialog box appears.
- 9 If you selected **PEAP**:
 - a Enter a **User Name**, **Password**, and **Domain**.
 - b If you want to save the password for future authentication sessions, select **Save Password**.
- 10 If you selected **TLS**, enter a **User Name** and **Domain**.
- 11 Tap **OK**.

Configure WPA or WPA2 Personal (PSK) Security with Microsoft Security

Before you set WPA or WPA2 Personal (PSK) security, you need to know the pre-shared key for your access point or passphrase for your authenticator. On your computer, you need to enable the radio and set the date.

- 1 Start Intermec Settings.
- 2 Select **Communications > 802.11 Radio > Microsoft Security**.
- 3 Enter the **Network name (SSID)**.

- 4** For **Infrastructure Mode**, select **Infrastructure**.
- 5** For **Association**, select **WPA-PSK** or **WPA2-PSK**.
The default encryption is **TKIP** or **AES**, respectively.
- 6** For **Pre-Shared Key**, enter the pre-shared key or passphrase:
 - Enter the pre-shared key (0x followed by 32 hexadecimal pairs) for your access point.
 - Enter the passphrase (8 to 63 ASCII characters) for your authenticator. The computer internally converts the passphrase to a pre-shared key.
- 7** Tap **OK**.

Configure 802.1x Security with Microsoft Security

Before you set 802.1x-WEP security with Microsoft security, you need to enable the radio on your computer and set the date. To use TLS protocol, you also need to load a user and root certificate. Intermec recommends that you use WPA2-802.1x instead of 802.1x-WEP if possible.

- 1** Start Intermec Settings.
- 2** Select **Communications > 802.11 Radio > Microsoft Security**.
- 3** Enter the **Network name (SSID)**.
- 4** For **Infrastructure Mode**, select **Infrastructure**.
- 5** For **Network Authentication**, select **Open**.
- 6** For **Data Encryption**, select **WEP**.
- 7** For **802.1X Authentication**, select **TLS** or **PEAP**.
- 8** Select **Hidden Network**.
- 9** Tap **OK**. The User Logon dialog box appears.
- 10** If you selected **PEAP**:
 - a** Enter a **User Name**, **Password**, and **Domain**.
 - b** If you want to save the password for future authentication sessions, select **Save Password**.

11 If you selected **TLS**, enter a **User Name** and **Domain**.

12 Tap **OK**.

Configure Static WEP Security with Microsoft Security

Before you set static WEP security with Microsoft security, you need to enable the radio on your computer and set the date. Intermec recommends that you use WPA2-PSK instead of WEP if possible.

1 Start Intermec Settings.

2 Select **Communications > 802.11 Radio > Microsoft Security**.

3 Enter the **Network name (SSID)**.

4 For **Network Authentication**, select **Open**.

5 For **Data Encryption**, select **WEP**.

6 For **802.1X Authentication**, select **Disabled**.

7 For **Network Key Value**, enter an ASCII key or hex key:

- For 64-bit WEP, enter a 5-byte value: 5 ASCII characters or 0x followed by 5 hexadecimal pairs.
- For 128-bit WEP, enter a 13-byte value: 13 ASCII characters or 0x followed by 13 hexadecimal pairs.

8 For **Network Key Index**, select the key you want to use to transmit data.

9 Tap **OK**.

Use Open (No Security) Associations with Microsoft Security

To create an open network, you can set no security with Microsoft security.

1 Start Intermec Settings.

2 Select **Communications > 802.11 Radio > Microsoft Security**.

3 Enter the **Network name (SSID)**.

4 For **Network Authentication**, select **Open**.

- 5** For **Data Encryption**, select **Disabled**.
- 6** Tap **OK**.

7

Manage the Computer

Use this chapter to learn how to remotely update, configure, and monitor your Intermecc computers. You will also find information on installing and developing software applications as well as how to upgrade the system software.

How to Manage the Computer in Your Network

When you have multiple mobile computers and peripherals in your network, it is essential to have an easy way to manage updates, configure all the devices, and remotely troubleshoot problems. Intermec provides two free software solutions for managing your computers:

- CloneNGo™ is a peer-to-peer license-free way to easily clone settings from one computer to another.
- SmartSystems™ is a device management software platform that helps you manage your devices.

How to Manage the Computer Using CloneNGo

Intermec CloneNGo is a software application that allows you to copy the settings and parameters from a master computer onto one or more client computers. Cloning reduces redundancy and error by providing an efficient and accurate way to copy and transmit settings from a master computer to one or more client computers through an ad hoc wireless network. For more information on CloneNGo, see the *CloneNGo User Guide*.

How to Manage the Computer Using SmartSystems

Intermec SmartSystems is a software platform that lets you manage all of your SmartSystems-enabled devices simultaneously from a central server. From the Intermec website, you can download this application at no charge. For help, see www.intermec.com/SmartSystems.

The SmartSystems console displays all SmartSystems-enabled devices and peripherals in your network. Through the console, you can:

- drag-and-drop configuration bundles, operating system updates, and firmware upgrades to multiple computers.
- save configuration settings from a single device and deploy those settings to many devices simultaneously.
- remotely change settings on the computer and peripherals.

The SmartSystems console can report on asset locations and battery status, making it easier to manage your computers.

With a Provisioning license, SmartSystems can automatically push software, configuration settings, and other files to the computers. The license also enables ScanNGo, which makes connecting additional computers to your wireless network as easy as scanning bar codes. To purchase a Provisioning license, contact your local Intermec representative.

How to Develop and Install Applications

Use the Intermec Resource Kits to develop applications to run on the mobile computer. The Resource Kits are a library of C++, .NET, Java, and web components grouped by functionality that you can use to create applications for the computer. The Resource Kits are part of the Intermec Developer Library (IDL), and can be downloaded from the Intermec website at www.intermec.com/idl.

How To Package Your Application

After you develop your application, you need to package it for installation on your mobile computer. For very simple applications, the executable file may be the only file you need to deploy. Typically, you will have a set of files to install. Intermec recommends using cabinet (.cab) files to install more complex applications. The computer uses standard Windows Mobile .cab files and will install third-party .cab files.

You can have your .cab file place the application in any of these memory locations on the computer:

- Object store (root directory)
- The non-volatile Flash File Store. Applications and data in the Flash File Store will persist through a clean boot or if you reflash the operating system image.
- The optional microSD card. Depending on available disk space, you may want to consider installing your application files on the microSD card. Using a card creates the Storage Card folder on the computer.

Files copied to any of these locations are safe when you cold boot the computer if the Autouser.dat file has been edited correctly. All .cab files in each CABFILES folder are automatically extracted after a cold boot. For more information about AutoRun, see the *Intermec Developer Library Resource Kit Developer's Guide*.

Install Applications with SmartSystems

You can use the SmartSystems console to drag-and-drop Intermec applications onto your mobile computer. The console is part of SmartSystems.

- 1 Download your application file from the Intermec website and unzip it on your desktop PC.
- 2 Double-click the application file to install it. The application file should appear in the Software Vault.
- 3 From the SmartSystems console in the Software Vault, drag-and-drop the application onto each mobile computer in your network, or drop the application on a group of computers contained in a folder.

Install Applications with Microsoft Synchronization Software

When you only have a few computers to update with applications, you can copy files using Microsoft synchronization software. This procedure assumes the Microsoft synchronization software is installed on your PC and is up and running.

- 1 Connect to the mobile computer through the synchronization software.
- 2 Copy the .cab files from your development PC to the mobile computer.
- 3 Reboot or cold boot the computer.
- 4 After the boot process is finished, browse to the .cab files and tap the files to install them.

Install Applications with a microSD Card

Use a microSD card to install applications on one computer at a time or if you do not have a network connection.

- 1 Copy your application file to the microSD card.
- 2 Insert the microSD card into the mobile computer.
- 3 On the mobile computer, browse to the SD Card folder and run your application.

How to Launch Applications Automatically

There are two ways to launch applications automatically on a cold boot:

- Set up your application .cab file to place a shortcut to the application in the \Windows\StartUp directory at install time.
- Use AutoRun to start your application at boot time. AutoRun ships on the computer and automates other operations. At boot time, AutoRun executes any commands found in its data file, Autouser.dat. For more information on using AutoRun, see the Readme.txt file located in the My Device\Flash File Store\2577 directory on the computer.

How to Update the System Software

The mobile computer uses SmartSystems bundles to update the operating system (OS) and the system software.

You can use these methods to update your mobile computer:

- You can update individual computers, or multiple computers at the same time, using the SmartSystems console. For help, see the next section.
- You can update individual computers using an SD card.

Update the Computer with SmartSystems

You can use the SmartSystems console to update the operating system or system software on your mobile computer. Before you can update the computer with this method, you need:

- SmartSystems. To download this software management tool, go to www.intermec.com/SmartSystems and click the Downloads tab.
- the SmartSystems bundles you want to install. Bundles that include the system software are available from www.intermec.com. Go to **Support > Downloads > OS/Firmware/Drivers** list.

After you locate these items, you can use SmartSystems to update the mobile computer.

- 1 Open SmartSystems.
- 2 Make sure the mobile computer is discovered.
- 3 Make sure the mobile computer is in a powered dock or that power management is disabled.
- 4 Download the SmartSystems bundle to your PC.
- 5 Double-click the SmartSystems bundle on your PC to extract the update files to the software vault.
- 6 From the SmartSystems console, locate the bundle to install and drag the bundle to each mobile computer (or group in a folder) you want to update. SmartSystems installs the update on your mobile computers.

After the download is complete, your mobile computer begins the update process and automatically performs a cold boot. The computer then boots into a special Update Loader mode where the computer has no network connections and is completely unusable.

This process can take anywhere from 30 seconds to 15 minutes depending on the update. After the update is complete, the computer boots again.



Note: While your mobile computer is offline, SmartSystems displays a red stop symbol in the console until the computer reboots and connects to the system.

Update the Computer with a microSD Card

You can update the computer using a microSD card. You need:

- a microSD card formatted to FAT32
- a microSD adapter card
- an SD card reader
- the AutoFlash.img file that contains the update you want to install. If you need this file, visit the Intermec website at www.intermec.com. Click the **Products** tab, navigate to the computer product page, click the **Downloads** tab, and then locate the download under OS/Firmware/Drivers.

The microSD card slot is located in the battery compartment.

- 1 Insert the microSD card into a microSD adapter card and then place it in the SD card reader connected to your PC.
- 2 On your desktop PC, navigate to the download location and select the folder with the AutoFlash.img file that contains the update you want to install. Typically, this directory is C:\Program Files\Intermec\SmartSystem\SS_Lib\Software\OS\
- 3 Copy the AutoFlash.img file to the root directory of the microSD card.
- 4 Remove the microSD card from the adapter card.
- 5 Turn off the computer and install the microSD card.
- 6 Replace the battery and turn on the computer.

The update process begins. The computer may restart several times. When the update is complete, the Autoflash Complete message appears.
- 7 Press the **Power** button and choose to Suspend the computer.
- 8 Remove the microSD card. If you do not remove the microSD card, the update process repeats each time the computer restarts.
- 9 Replace the battery, turn on the computer, and follow the setup process.

8

Troubleshoot and Maintain the Computer

Use this chapter to find answers to any problems you may encounter while using the computer. You will also find information on routine maintenance.

About the Intermec Dashboard

The Intermec Dashboard provides proactive monitoring of your computer to prevent downtime. Using Intermec Dashboard, you can easily see the health of the computer and help pinpoint the source of a problem to determine if it is hardware or software related. It is highly integrated with SmartSystems. You can also use SmartSystems to remotely monitor the health of your computers. For help, see the SmartSystems help.

Intermec Dashboard displays information, such as the status of network connection, battery usage and battery health, storage space, and internal devices. It also provides system information, such as the operating system, firmware, and hardware configuration.

- To access the Intermec Dashboard, press the Intermec Dashboard  button.



Intermec Dashboard Main Screen

About Troubleshooting the Computer

These troubleshooting tables may help you fix some common problems you may experience with your computer. These tables group solutions for the Wi-Fi connection, 802.1x security, the imager, and general operation of the computer.



Note: If you send the computer in for service, it is your responsibility to save the computer data and its configuration. Intermec is only responsible for ensuring that the hardware matches the original configuration when repairing or replacing the computer.

Wi-Fi Connection Problems

Use this section to find possible solutions to Wi-Fi connection problems.

Wi-Fi Connection Problems and Possible Solutions

Problem	Possible Solution
When you turn on the mobile computer after it was suspended for 10 to 15 minutes or longer, the mobile computer can no longer send or receive messages over the network.	The host may have deactivated or lost the current terminal emulation session. In a TCP/IP direct connect network, turn off the “Keep Alive” message from host to maintain the TCP session while the computer is suspended.
The computer is connected to the network, and you move to a new site to collect data. Now, your mobile computer is not connected to the network.	Move closer to an access point or to a different location to reestablish communications until you reconnect with the network. Any data collected while out of range is transmitted over the network.
The mobile computer appears to be connected to the network, but you cannot establish a terminal emulation session with the host computer.	Move closer to an access point or to a different location to reestablish communications until you reconnect with the network. Any data collected while out of range is transmitted over the network.
The mobile computer appears to be connected to the network, but the host computer is not receiving any information from the mobile computer.	There may be a problem with the connection between the access point and the host computer. Check with network administrator or use your access point user’s manual.

Check Wi-Fi Network Status

If you have trouble connecting to your Wi-Fi wireless network:

- Make sure you have correctly set network parameters on the computer.
- Check your wireless security settings.

Follow the next procedure to verify available access points and networks, check signal strength, and view other diagnostics. If you need to contact Intermec Product Support, this information can be helpful in troubleshooting wireless network connection issues.

1 Tap **Start** > **iSpyWiFi**. The ISpyWiFi application launches:

The ISpyWiFi tab shows:

- MAC address and IP address of the Wi-Fi radio.
- network association status, including the SSID and MAC address of the access point.
- security configuration.
- radio transmit power and signal strength information.

2 Tap the **Scan** tab to view a list of available Wi-Fi networks. The list includes the signal strength, channel, and MAC address for each network.

- Tap **Scan** to refresh the screen.

3 Tap the **Supp** tab to view radio supplicant information, including a list of supplicant events and authentication status.

- To verify the settings for the currently active security profile, tap **Configure Profile**. Intermec Settings launches for you to configure Wi-Fi radio settings.
- To try reconnecting to the network, tap **Reconnect**.
- To delete the events in the list, tap **Clear Events**.

4 Tap the **Ping** tab to run a ping test to the host.

- a** In the **Host** field, enter the IP address of the host.
- b** From the **Repetitions** list, choose the number of times the computer will ping the host.

- c Tap **Ping**. The graph shows the amount of time it takes for the host to return the ping. Tap **List** to see this information in a list format.
- 5 Tap the **RSSI** tab to view the received signal strength of the host signal.
The information box includes the current signal strength, host SSID name, MAC address, data rate, and transmit power.
 - Tap **Mark** to place an arrow marker above the graph.
- 6 Tap the **Conf** tab to set up a log file that lists the RSSI history.
This screen includes the Wi-Fi radio driver version and available radio modes.
 - a Check the **Log to File** check box.
 - b (Optional) Change to the sample period and number of samples displayed.
 - c Tap **Log file**. The **Save As** screen appears.
 - d (Optional) Change the name of the saved log file, the folder to which the file to be saved, the content type (log or text), and the location.
 - e Tap **OK**.

802.1x Security Problems

Use this section to find possible solutions to 802.1x security problems.

802.1x Security Problems and Possible Solutions

Problem	Possible Solution
The mobile computer indicates that it is authenticated, but it does not communicate with the host.	Make sure the mobile computer IP address, host IP address, subnet mask, and default router are configured for the network.
The mobile computer does not appear to be authenticating and a network connection icon does not appear on the toolbar.	<ul style="list-style-type: none"> • The mobile computer may not be communicating with the access point. Make sure the mobile computer network name matches the access point network name (SSID). • The access point may not be communicating with the server. Ensure the access point is turned on, properly configured, and has 802.1x security enabled.

802.1x Security Problems and Possible Solutions (Continued)

Problem	Possible Solution
A network connection icon appears in the toolbar, but then disappears.	<ul style="list-style-type: none">• The mobile computer may not be communicating with the intended access point. Make sure that the network name matches the access point network name. The default network name is “INTERMEC.”• The access point may not be communicating with the server. Ensure the access point is turned on, properly configured, and has 802.1x security enabled.
You are setting up multiple access points in a network with different SSIDs, and the connection fails.	When you change the SSID, the WEP key values are not saved. Configure the WEP key values and save your changes.
The mobile computer indicates it is not authenticated.	Make sure that: <ul style="list-style-type: none">• the User Name and Password parameters on the mobile computer match the user name and password on the authentication server. You may need to configure the password on both the mobile computer and the authentication server.• on your authentication server, the user and group are allowed and the group policy is allowed to log into the server. For help, see the documentation that shipped with your authentication server software.• the IP address and secret key for the access point match the IP address and secret key on the authentication server. You may need to configure the IP address and secret key on both your access point and authentication server.• the authentication server software is running on the server PC.
You clean boot the mobile computer and this message appears, “The server certificate has expired or your system date is incorrect.”	When you clean boot the computer, the date and time are not saved. Configure the date and time and save your changes.

Troubleshoot the Scanner with Scan Diagnostics

The ScanDiagnostic application helps troubleshoot problems, such as the inability to read a bar code or a scanner or imager that does not turn on.

1 Tap **Start > ScanDiagnostic**.

2 Select the scanner or imager you want to troubleshoot and tap **Diagnose**.

The application checks to make sure the scanner or imager is enabled and checks the settings to make sure they are optimized.

3 Aim the scanner or imager at a bar code and tap and hold **Press to Scan**.

After the computer reads the bar code, the computer beeps and the label data, data length, and symbology appear on the screen.

4 To view recommended settings, press the right arrow button.

5 To accept recommended settings, tap **Apply**.

6 Tap **OK**.

Problems Reading Bar Codes

You can troubleshoot problems that prevent you from reading bar codes, such as the appropriate symbology not being enabled. Before you call Intermec Product Support, look for your problem in the next table, and try the possible solutions.

Problems Reading Bar Codes

Problem	Possible Solution
You cannot see the illumination beam or frame from the imager when you press the Scan button and aim the imager at a bar code label.	<ul style="list-style-type: none"> • You may be too far away from the bar code label. Try moving closer to the bar code label and scan it again. • You may be reading the bar code label “straight on.” Change the reading angle and try again. • The imager hardware trigger may be disabled. Start Intermec Settings and go to Data Collection > Scanner Settings. Make sure Hardware trigger is selected.

Problems Reading Bar Codes (Continued)

Problem	Possible Solution
When you release the Scan button or scan handle trigger, the Good Read LED does not turn off.	If you configure the computer to use continuous/edge triggering, the Good Read LED stays on. If you configure the computer for level triggering and the Good Read LED stays on, there may be a problem. Press the Scan button or pull the trigger again without scanning a bar code label. If the LED is still on, contact Intermec.
The scanner or imager cannot read the bar code.	<ul style="list-style-type: none">• Position the scanner beam so that it crosses the entire bar code label in one pass. Try to vary the scanning angle.• Check the quality of the bar code label. Scan a bar code label that you know scans properly. Compare the quality of the two bar code labels. You may need to replace the label that you cannot scan.• Make sure the bar code symbology is enabled and configured correctly. Start Intermec Settings and go to Data Collection > Symbologies for the scanning device (scanner, virtual wedge) to check and enable symbologies.• Make sure the computer application is expecting input from a bar code. You may need to type this information instead.• The scanner may not be turned on or the scanner may be unable to scan a specific bar code. Run the ScanDiagnostic application.
The scanner or imager cannot read the bar code quickly, or the scanning beam seems to be faint or obscured.	The scanner or imager window may be dirty. Clean the window with a solution of mild soap and water. Wipe dry. Do not allow abrasive material to touch the window.
You read a valid bar code label to enter data for your application. The data decoded by the scan module does not match the data encoded in the bar code label.	The computer may have decoded the bar code label in another symbology. Scan the bar code label again. Make sure you scan the entire label.
The input device attached to the computer does not work well or read bar code labels very quickly.	Set the Scanner Model command to the specific attached input device. Enable only the bar code symbologies being used.

Problems Using the Computer

You can troubleshoot general problems while using the computer. Before you call Intermec Product Support, look for your problem in the next table, and try the possible solutions.

Problems Using the Computer

Problem	Possible Solution
You tap the screen and nothing happens.	Align the screen.
You press the Power button and nothing happens.	<ul style="list-style-type: none"> The battery may be completely drained. Replace or charge the battery. Restart the computer.
The computer appears to be locked up, and you cannot enter data.	<ul style="list-style-type: none"> Press the Power button and select Suspend. Press the Power button again to turn the screen back on. Press the Power button and select Reboot. Cold boot the computer. Reload the firmware.
You rotate the computer and the screen does not respond properly.	Run the Sensor Calibration application to calibrate the accelerometer.
You cannot type a character on the keypad, or you can only type uppercase or lowercase letters.	The orange modifier or green modifier key may be locked.

Call Product Support

If you are having trouble using your Intermec computer, you can:

- use the troubleshooting tables in this manual to find your problem and possible solutions.
- visit the Intermec technical knowledge base, Knowledge Central at intermec.custhelp.com.

If you still need help, you can call Intermec Product Support at:

1-800-755-5505

Before you call Product Support, have this information ready:

- Configuration number (CN) and serial number (SN), printed on a label inside the battery compartment or shown on the Device Health dashboard under **Information**.

- Operating system version
- Power management settings
- Wireless security settings
- Intermec Terminal Emulation (ITE) version and protocol, available from the ITE main screen.

Or, programming language of your custom application and tools used to create it.

Most information is available in Intermec Settings.

Locate Your Configuration Number

Before you call Intermec Product Support, you need to know the configuration number of your computer.

- 1 Open the Device Health Dashboard:
 - Press **[M]** and then press **[0]** on the numeric keypad.
 - Press **[?]** on the alphanumeric keypad.
- 2 In the Dashboard, scroll down and tap **Information**.
- 3 Scroll down until you see the Hardware Configuration number.
- 4 Exit the Device Health Dashboard.

Locate Your Operating System Version

Before you call Intermec Product Support, you need know the operating system version loaded on your computer.

- 1 Open the Device Health Dashboard:
 - Press **[M]** and then press **[0]** on the numeric keypad.
 - Press **[?]** on the alphanumeric keypad.
- 2 In the Dashboard, scroll down and tap **Information**.
- 3 Scroll down until you see the OS Version number.
- 4 Exit the Device Health Dashboard.

How to Restart the Computer

If the computer or an application locks up, or if the computer does not respond when you press the **Power** button, you may need to restart the computer.

The computer uses the configuration currently saved in flash memory during the boot process. Try these methods, in order, to restart the computer:

- **Reboot:** Restarts the computer and goes through the initialization process.
- **Cold boot:** Preserves configuration and network settings, but does not necessarily save cached disk data, which may result in data loss.
- **Clean boot:** Completely erases the computer memory, including all applications and data files, except those in the Flash File Store or any removable storage.

Reboot the Computer

You may need to restart the computer to correct conditions where an application stops responding to the system.

- Press the **Power** button and select **Reboot** from the menu.

Cold Boot the Computer

If the computer seems to be locked up and does not respond to keystrokes, try a cold boot to reset the operating system.



Note: The computer may also cold boot if you change the battery while the CN51 is in Suspend mode, or if you do not change the battery quickly enough when the CN51 is in Hibernate mode.

- 1** Press and hold the **Power** button for at least 8 seconds. The computer turns off.
- 2** Press the **Power** button again. The computer cold boots.

Clean Boot the Computer



Caution: A clean boot erases the memory in the mobile computer, including all applications and data files, with the exception of those found in the Flash File Store or any removable storage.

If the computer seems to be locked up, try cold booting it. If a cold boot does not work, use a clean boot to get the computer up and running for further troubleshooting.

- 1 Press the **Power** button for about 2 seconds and then release it. The Intermec Power Options screen appears.
- 2 Select **Reboot** from the menu. The computer reboots.
- 3 Watch the startup screen. As soon as a white bar appears in the center of the screen, press and hold the **Power** button.

If the message **Launching OS** appears in the white bar before you press and hold the **Power** button, the computer does not clean boot and you must start again with Step 1 after the computer finishes booting.

- 4 When the message **Release IO Button** appears, release the **Power** button. The message **Enter first key in 20 seconds** appears.
- 5 Press the **Space** key. The message **Enter second key in 6 seconds** appears.
- 6 Press the **Enter** key. The message **Confirm first key in 6 seconds** appears.
- 7 Press the **Space** key. The message **Confirm second key in 6 seconds** appears.
- 8 Press the **Enter** key. The message **Cleanboot Confirmed** appears, and the computer continues the clean boot process.

Clean the Computer

To keep the computer in good working order, you may need to clean the imager window, color camera window, and the touch screen. Clean the windows and the touch screen as often as needed for the environment in which you are using the computer. To clean the computer, use one of these recommended cleaning agents:

- Acetic acid, 10% in water
- Ethyl alcohol, 10% in water
- Mild soap solutions
- 5% to no more than 10% bleach or sodium hypochlorite with water



Caution: There are no user-serviceable parts inside the computer. Opening the computer will void the warranty and may cause damage to the internal components.



Note: Intermec recommends that you leave the battery installed when you clean the computer as described. Leaving the battery installed helps prevent fluids from entering the computer through the SIM card and microSD card connectors.

- 1 Press the **Power** button to suspend the computer.
- 2 Dip a clean cloth towel in the cleaning agent and wring out the excess.
- 3 Wipe off the imager window, camera lens, and flash area. Do not allow any abrasive material to touch these surfaces.
- 4 Wipe dry.
- 5 Let the computer completely air dry before using again.

A

Specifications

Physical and Environmental Specifications

This section lists the physical and environmental specifications for the computer.

Physical Dimensions

Length:	16.5 cm (6.5 in)
Width (at widest part):	7.6 cm (3.0 in)
Depth (at grip):	3.2 cm (1.25 in)
Weight (with battery):	350 g (12.3 oz)

Tumble and Drop Specifications

Tumble Specification:	1,000 (0.5 m) tumbles per IEC 60068-2-32 specification.
Drop Specification:	Multiple 1.5 m (5 ft) drops to concrete at ambient temperature, multiple 1.2 m (4 ft) drops to concrete across the operating temperature range per MIL-STD 810G.

Power and Electrical Specifications

Operating battery:	Rechargeable lithium-ion battery
Backup battery:	Supercap supplies 1.5 minutes of bridge time while replacing the main battery.
Electrical rating:	⎓ 4,65 V, 3 A

Temperature and Humidity Specifications

Operating temperature:	-10 °C to 50 °C (14 °F to 122 °F)
Storage temperature:	-20 °C to 70 °C (-4 °F to 158 °F)
Charging temperature:	5 °C to 35 °C (41 °F to 95 °F)
Relative humidity (operating):	20 to 95% non-condensing
Environmental rating:	IP54, Category 1

Screen Specifications

- 480 x 800 pixels
 - 10.16 cm (4.0 in) transmissive WVGA display
 - LCD capable of both portrait and landscape operation
 - LED backlight
 - Ambient light sensor
-

Keypad Options

- Alphanumeric keypad
 - Numeric keypad
-

Bar Code Symbolologies

- Australia Post*
- Aztec*
- BPO (British Post 4-state)*
- Canada Post
- Codabar
- Codablock A
- Codablock F
- Code 11
- Code 39
- Code 93
- Code 128/GS1-128
- DataMatrix*
- Dutch Post*
- EAN/UPC
- GS1 Composite*
- GS1 DataBar Expanded
- GS1 DataBar Limited
- GS1 DataBar Omni-Directional
- HanXin
- Infomail
- Intelligent Mail
- Interleaved 2 of 5
- JapanPost*
- Matrix 2 of 5
- Maxicode*
- Micro PDF417
- MSI
- PDF417*
- Planet*
- Plessey
- Postnet*
- QR Code*
- Standard 2 of 5
- SwedenPost
- Telepen
- TLC 39

* These symbolologies are only available if your CN51 has an extended range area imager or a near-far area imager.

EA31 Extended Reading Range

These typical reading distances are measured in an office environment (250 lux) for the EA31 standard model with Extended Reading Range activated. Extended Reading Range is enabled by default.

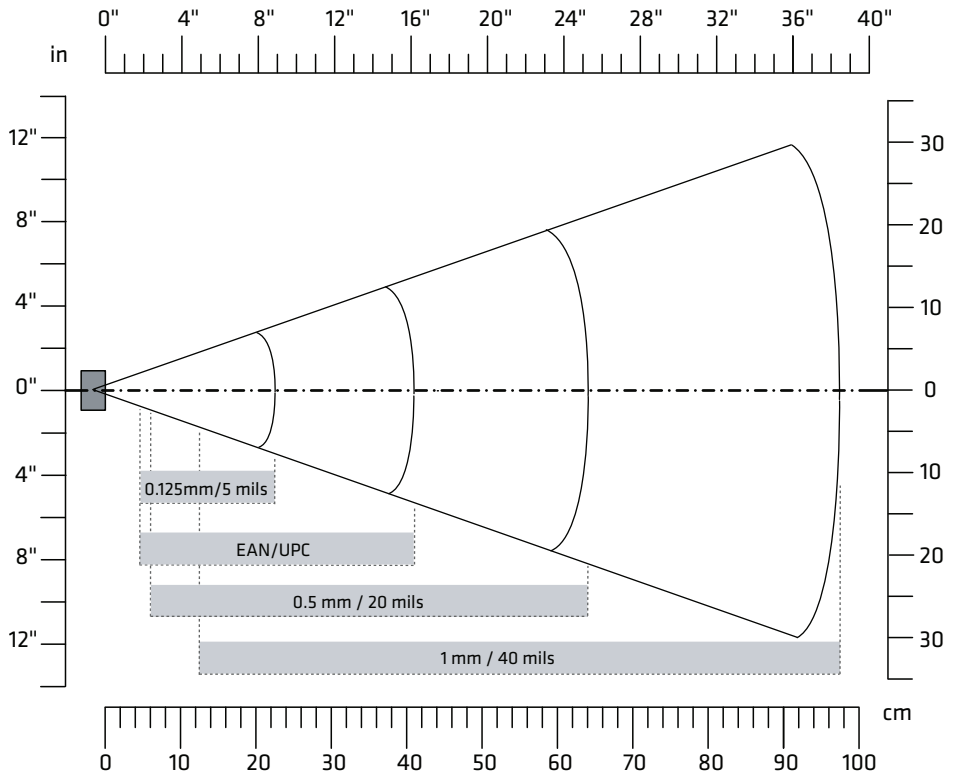

EA31 Extended Reading Range

EA31 Extended Reading Range Activated

Symbology	Density	Minimum Distance	Maximum Distance
Code 39	0.125 mm/5 mils	4.50 cm/1.77 in	22.50 cm/8.86 in
	0.50 mm/20 mils	6.00 cm/2.36 in	64.00 cm/25.20 in
	1 mm/40 mils	12.50 cm/4.92 in	97.50 cm/38.39 in
EAN/UPC 100%	0.33 mm/13 mils	4.50 cm/1.77 in	41 cm/16.14 in

EA31 Minimum Reading Distances

Minimum reading distances are measured in the dark (0 lux).

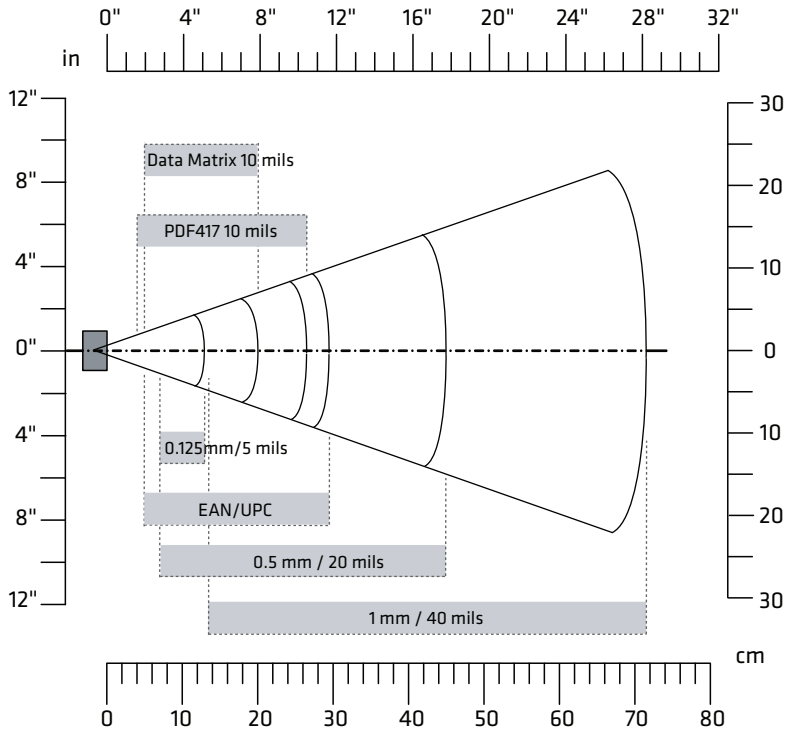

EA31 Minimum Reading Distances

EA31 Minimum Reading Distances

Symbology	Density	Minimum Distance	Maximum Distance
Code 39	0.10 mm/4 mils	8 cm/3.15 in	10 cm/3.94 in
	0.13 mm/5 mils	7 cm/2.76 in	13 cm/5.12 in
	0.20 mm/8 mils	4 cm/1.57 in	20 cm/7.87 in
	0.25 mm/10 mils	3.8 cm/1.5 in	24.5 cm/9.65 in
	0.50 mm/20 mils	7 cm/2.76 in	45 cm/17.72 in
	1 mm/40 mils	13.5 cm/5.31 in	71.5 cm/28.15 in
EAN/UPC 100%	0.33 mm/13 mils	5 cm/1.97 in	29.5 cm/11.61 in
DataMatrix	0.18 mm/7 mils	7 cm/2.76 in	14 cm/5.51 in
	0.25 mm/10 mils	5 cm/1.97 in	20 cm/7.87 in
	0.38 mm/15 mils	5.2 cm/2.05 in	29.5 cm/11.61 in

EA31 Minimum Reading Distances (Continued)

Symbology	Density	Minimum Distance	Maximum Distance
PDF417	0.17 mm/6.6 mils	5.8 cm/2.28 in	17.5 cm/6.89 in
	0.25 mm/10 mils	4 cm/1.57 in	26.5 cm/10.43 in
	0.38 mm/15 mils	4.9 cm/1.93 in	37 cm/14.57 in

EA31 Typical Reading Distances

Minimum reading distances are measured in the dark (0 lux).

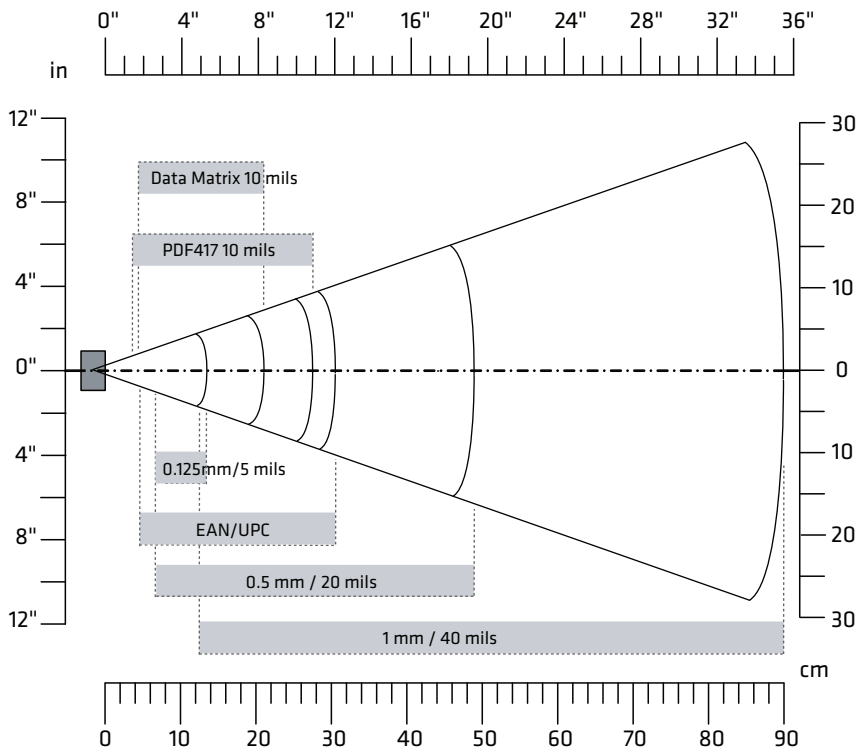

EA31 Typical Reading Distances

EA31 Typical Reading Distances

Symbology	Density	Minimum Distance	Maximum Distance
Code 39	0.10 mm/4 mils	7.5 cm/2.95 in	10.5 cm/4.13 in
	0.13 mm/5 mils	6.5 cm/2.56 in	13.5 cm/5.31 in
	0.20 mm/8 mils	4cm/1.57 in	21 cm/8.27 in
	0.25 mm/10 mils	3.5 cm/1.38 in	25.5 cm/10 in
	0.50 mm/20 mils	6.5 cm/2.56 in	49 cm/19.29 in
	1 mm/40 mils	12.5 cm/4.92 in	90 cm/35.43 in
EAN/UPC 100%	0.33 mm/13 mils	4.5 cm/1.77 in	30.5 cm/12.01 in
DataMatrix	0.18 mm/7 mils	6.5 cm/2.56 in	15 cm/5.91 in
	0.25 mm/10 mils	4.5 cm/1.77 in	21 cm/8.27 in
	0.38 mm/15 mils	4.7 cm/1.85 in	31 cm/12.20 in
PDF417	0.17 mm/6.6 mils	5 cm/1.97 in	18.2 cm/7.17 in
	0.25 mm/10 mils	3.7 cm/1.46 in	27.5 cm/10.83 in
	0.38 mm/15 mils	4.5 cm/1.77 in	40 cm/15.75 in

EA30 Extended Reading Range

These typical reading distances are measured in an office environment (250 lux) for the EA30 standard model with Extended Reading Range activated. Extended Reading Range is enabled by default.

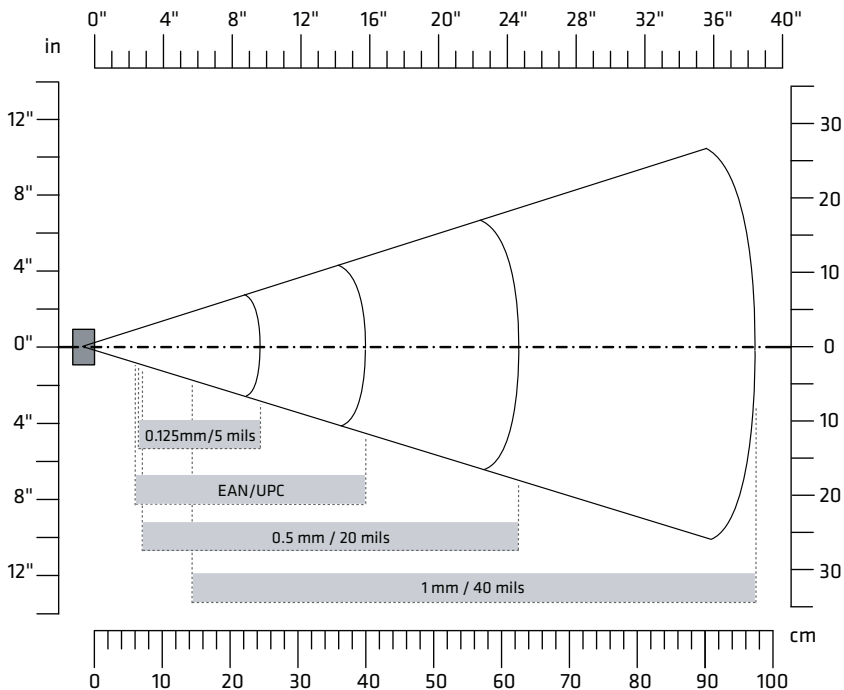

EA30 Extended Reading Range Activated

EA30 Extended Reading Range Activated

Symbology	Density	Minimum Distance	Maximum Distance
Code 39	0.125 mm/5 mils	64.50 cm/2.56 in	24.50 cm/9.65 in
	0.50 mm/20 mils	7.00 cm/2.76 in	62.50/24.61 in
	1 mm/40 mils	14.50 cm/5.71 in	97.50 cm/38.39 in
EAN/UPC 100%	0.33 mm/13 mils	6 cm/2.36 in	40 cm/15.75 in

EA30 Minimum Reading Distances

Minimum reading distances are measured in the dark (0 lux).

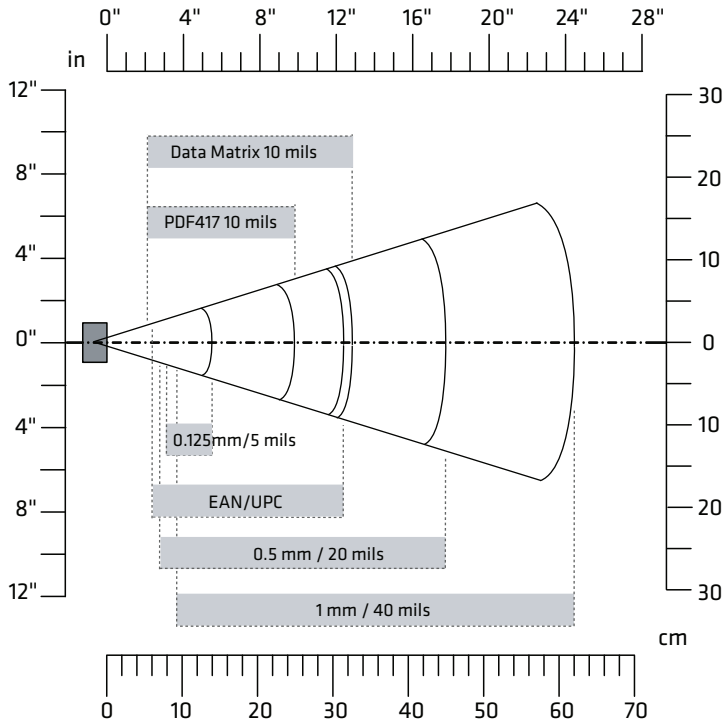

EA30 Minimum Reading Distances

EA30 Minimum Reading Distances

Symbology	Density	Minimum Distance	Maximum Distance
Code 39	0.10 mm/4 mils	9.5 cm/3.74 in	10.5 cm/4.13 in
	0.13 mm/5 mils	8 cm/3.15 in	14 cm/5.51 in
	0.50 mm/20 mils	7 cm/2.76 in	45 cm/17.72 in
	1 mm/40 mils	9.5 cm/3.74 in	62 cm/24.41 in
EAN/UPC 100%	0.33 mm/13 mils	6 cm/2.36 in	31.5 cm/12.4 in
DataMatrix	0.18 mm/7 mils	8 cm/3.15 in	15.5 cm/6.1 in
	0.25 mm/10 mils	6.5 cm/2.56 in	21.5 cm/8.46 in
	0.38 mm/15 mils	5.5 cm/2.17 in	31.5 cm/12.4 in
PDF417	0.25 mm/10 mils	5.5 cm/2.17 in	25 cm/9.84 in
	0.38 mm/15 mils	7 cm/2.76 in	34 cm/13.39 in

EA30 Typical Reading Distances

Minimum reading distances are measured in the dark (0 lux).

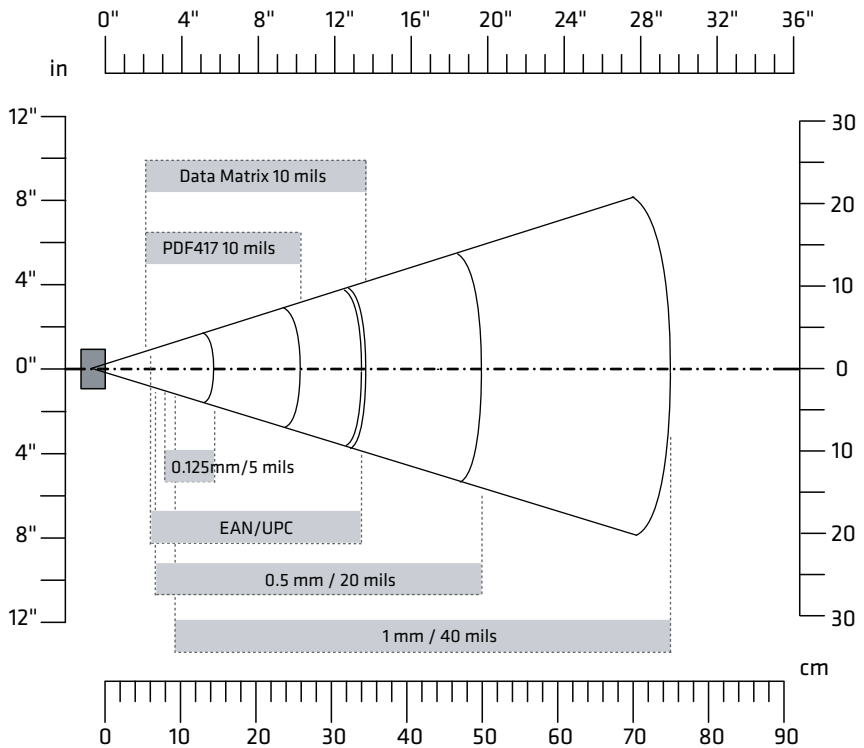

EA30 Typical Reading Distances

EA30 Typical Reading Distances

Symbology	Density	Minimum Distance	Maximum Distance
Code 39	0.10 mm/4 mils	9.5 cm/3.74 in	11.5 cm/4.53 in
	0.13 mm/5 mils	8 cm/3.15 in	14.5 cm/5.71 in
	0.50 mm/20 mils	6.5 cm/2.56 in	50 cm/19.69 in
	1 mm/40 mils	9.5 cm/3.74 in	75 cm/29.53 in
EAN/UPC 100%	0.33 mm/13 mils	6 cm/2.36 in	34 cm/13.39 in
DataMatrix	0.18 mm/7 mils	7.5 cm/2.95 in	16.5 cm/6.5 in
	0.25 mm/10 mils	6 cm/2.36 in	23 cm/9.06 in
	0.38 mm/15 mils	5.5 cm/2.17 in	34.5 cm/13.58 in
PDF417	0.25 mm/10 mils	5.5 cm/2.17 in	26 cm/10.24 in
	0.38 mm/15 mils	6.5 cm/2.56 in	37 cm/14.57 in

B

Keypads and Keystrokes

Standard Characters

Use the following tables to learn how to enter standard and other available characters and functions with the keypad. If there is no sequence of keystrokes for a particular character or function, it is only available through the soft input panel (SIP), which you can access by tapping the keyboard icon on the touch screen.



Note: You can only enter “*” and “#” characters in the phone or contacts applications.

CN51 Keypads and Keystrokes

CN51 Alphanumeric Characters

Character	Numeric Keypad	QWERTY Keypad
a	2	A
b	2 2	B
c	2 2 2	C
d	3	D
e	3 3	E
f	3 3 3	F
g	4	G
h	4 4	H
i	4 4 4	I
j	5	J
k	5 5	K
l	5 5 5	L
m	6	M

CN51 Alphanumeric Characters (Continued)

Character	Numeric Keypad	QWERTY Keypad
n	6 6	N
o	6 6 6	O
p	7	P
q	7 7	Q
r	7 7 7	R
s	7 7 7 7	S
t	8	T
u	8 8	U
v	8 8 8	V
w	9	W
x	9 9	X
y	9 9 9	Y
z	9 9 9 9	Z
A	1 2	A
B	1 2 2	B
C	1 2 2 2	C
D	1 3	D
E	1 3 3	E
F	1 3 3 3	F
G	1 4	G

CN51 Alphanumeric Characters (Continued)

Character	Numeric Keypad	QWERTY Keypad
H	1 4 4	H
I	1 4 4 4	I
J	1 5	J
K	1 5 5	K
L	1 5 5 5	L
M	1 6	M
N	1 6 6	N
O	1 6 6 6	O
P	1 7	P
Q	1 7 7	Q
R	1 7 7 7	R
S	1 7 7 7 7	S
T	1 8	T
U	1 8 8	U
V	1 8 8 8	V
W	1 9	W
X	1 9 9	X
Y	1 9 9 9	Y
Z	1 9 9 9 9	Z
0	0	

CN51 Alphanumeric Characters (Continued)















































Character	Numeric Keypad	QWERTY Keypad
1		
2		
3		
4		
5		
6		
7		
8		
9		

CN51 Characters and Functions

To Enter	Numeric Keypad	QWERTY Keypad
@ (at symbol)	N/A	
& (ampersand)	N/A	
* (asterisk)		
: (colon)	N/A	
, (comma)		
\$ (dollar)	N/A	
! (exclamation)	N/A	
- (hyphen)		
% (percent)	N/A	

Appendix B – Keypads and Keystrokes

CN51 Characters and Functions (Continued)

To Enter	Numeric Keypad	QWERTY Keypad
. (period)		
+ (plus)	 	 
# (pound)		 
? (question mark)	N/A	 
‘ (apostrophe)	N/A	 
Backslash	 	 
Forward Tab		
Backspace		
Up Arrow		
Down Arrow		
Left Arrow		
Right Arrow		
CapsLock	 	  
Enter		
Shift	 or 	 or 
Space	 	
Esc		
Intermec Dashboard		



Worldwide Headquarters
6001 36th Avenue West
Everett, Washington 98203
U.S.A.

tel 425.348.2600

fax 425.355.9551

www.intermec.com

© 2013 Intermec Technologies
Corporation. All rights reserved.

CN51 Mobile Computer User Manual



P/N 935-077-001