



Invacare® TheraPure™ Recessed Whirlpool Tubs

Model 3752G

Model 3802G



User Manual

EN



This manual MUST be given to the user of the product.

BEFORE using this product, read this manual and save for future reference.



Yes, you can.®

CONTENTS

1 GENERAL	4
Symbols and Signal Words.....	4
Limited Warranty	5
2 SAFETY	6
General Guidelines	6
Important Safety Information	6
3 OVERVIEW	8
Features.....	8
Product Labeling.....	10
Typical Product Parameters	11
Minimum Floor Space and Clearance Requirements.....	12
Dimensions.....	13
4 INSTALLATION	14
Preparing the Work Area.....	15
Electrical and Plumbing Hook-up Locations	16
Electrical Installation.....	17
Plumbing Installation.....	18
Post Installation Checklist.....	19

5 OPERATING INSTRUCTIONS	20
Overview	20
Cleaning and Disinfecting	21
Opening/Closing the Tub Door	25
Waist Strap.....	27
Water Temperature Setting.....	28
Filling the Tub	29
Using the Shower/Massage Wand.....	29
Using the Whirlpool Function	30
6 INSPECTION AND TROUBLESHOOTING	31
Safety Inspection Checklists	31
Troubleshooting.....	32
Maintenance Record.....	33

I General

I.1 Symbols and Signal Words

Signal words are used in this manual and apply to hazards or unsafe practices which could result in personal injury or property damage. See the information below for definitions of the signal words.



DANGER

Danger indicates an imminently hazardous situation which, if not avoided, will result in death or serious injury.



WARNING

Warning indicates a potentially hazardous situation which, if not avoided, could result in death or serious injury.



CAUTION

Caution indicates a potentially hazardous situation which, if not avoided, may result in property damage or minor injury or both.



IMPORTANT

Indicates a hazardous situation that could result in damage to property if it is not avoided.



Gives useful tips, recommendations and information for efficient, trouble-free use.

1.2 Limited Warranty



PLEASE NOTE: THE WARRANTY BELOW HAS BEEN DRAFTED TO COMPLY WITH FEDERAL LAW APPLICABLE TO PRODUCTS MANUFACTURED AFTER JULY 4, 1975.

This warranty is extended only to the original purchaser/user of our products.

This warranty gives you specific legal rights and you may also have other legal rights which vary from state to state.

Invacare Continuing Care, Inc. (ICCI) warrants its bathing/whirlpool products to be free from defects in materials and workmanship for a period of three years from the date of purchase. The door seal is warranted for the life of the tub. Warranty obligation is limited to parts replacement only. Warranty replacement parts are only covered for the duration of the warranty period. All purchased replacement parts will carry a 30-day warranty from the date of shipment. If within such warranty period any such product shall be proven to be defective, such product shall be repaired or replaced, at ICCI's option. This warranty does not include any labor or shipping charges incurred in replacement part installation or repair of any such product. ICCI's sole obligation and your exclusive remedy under this warranty shall be limited to such repair and/or replacement.

For warranty service, please contact the dealer from whom you purchased your ICCI product. In the event you do not receive satisfactory warranty service, please write directly to ICCI at the address below. Provide dealer's name, address, model number, date of purchase, indicate nature of the defect and, if the product is serialized, indicate the serial number.

ICCI will issue a return authorization. The defective unit or parts must be returned for warranty inspection using the serial number, when applicable, as identification within thirty days of return authorization date. DO NOT return products to our factory without our prior consent. C.O.D. shipments will be refused; please prepay shipping charges.

LIMITATIONS AND EXCLUSIONS: THE WARRANTY SHALL NOT APPLY TO PROBLEMS ARISING FROM NORMAL WEAR OR FAILURE TO ADHERE TO THE ENCLOSED INSTRUCTIONS. LABOR; EXPENDABLE ITEMS, I.E. SHOWER HOSES, VALVES, "O" RINGS, SEALS; PARTS BROKEN DUE TO ABUSE OR IMPROPER USE; ITEMS THAT BECOME INOPERABLE DUE TO LACK OF MAINTENANCE, OR NON COMPATIBLE CHEMICALS; STAINS DUE TO HARD WATER, IODINE SOLUTIONS, OR OTHER UNAPPROVED CHEMICALS; "SPIDER" CRACKS OR "CRACKING" DUE TO MISHANDLING OR ABUSE. IN ADDITION, THE FOREGOING WARRANTY SHALL NOT APPLY TO SERIAL NUMBERED PRODUCTS IF THE SERIAL NUMBER HAS BEEN REMOVED OR DEFACED; PRODUCTS SUBJECTED TO NEGLIGENCE, ACCIDENT, IMPROPER OPERATION, MAINTENANCE OR STORAGE; OR PRODUCTS MODIFIED WITHOUT ICCI'S EXPRESS WRITTEN CONSENT INCLUDING, BUT NOT LIMITED TO: MODIFICATION THROUGH THE USE OF UNAUTHORIZED PARTS OR ATTACHMENTS; PRODUCTS DAMAGED BY REASON OF REPAIRS MADE TO ANY COMPONENT WITHOUT THE SPECIFIC CONSENT OF ICCI; PRODUCTS DAMAGED BY CIRCUMSTANCES BEYOND ICCI'S CONTROL; PRODUCTS REPAIRED BY ANYONE OTHER THAN AN ICCI DEALER, SUCH EVALUATION SHALL BE SOLELY DETERMINED BY ICCI.

THE FOREGOING EXPRESS WARRANTY IS EXCLUSIVE AND IN LIEU OF ANY OTHER WARRANTIES WHATSOEVER, WHETHER EXPRESS OR IMPLIED, INCLUDING THE IMPLIED WARRANTIES OF MERCHANTABILITY AND FITNESS FOR A PARTICULAR PURPOSE, AND THE SOLE REMEDY FOR VIOLATIONS OF ANY WARRANTY WHATSOEVER, SHALL BE LIMITED TO REPAIR OR REPLACEMENT OF THE DEFECTIVE PRODUCT PURSUANT TO THE TERMS CONTAINED HEREIN. THE APPLICATION OF ANY IMPLIED WARRANTY WHATSOEVER SHALL NOT EXTEND BEYOND THE DURATION OF THE EXPRESS WARRANTY PROVIDED HEREIN. THE MANUFACTURER SHALL NOT BE LIABLE FOR ANY CONSEQUENTIAL OR INCIDENTAL DAMAGES WHATSOEVER.

THIS WARRANTY SHALL BE EXTENDED TO COMPLY WITH STATE/PROVINCIAL LAWS AND REQUIREMENTS.

2 Safety

The Safety section contains important information for the safe operation and use of this product.

2.1 General Guidelines



WARNING

DO NOT use this product or any available optional equipment without first completely reading and understanding these instructions and any additional instructional material such as owner's manuals, service manuals or instruction sheets supplied with this product or optional equipment. If you are unable to understand the warnings, cautions or instructions, contact a healthcare professional, dealer or technical personnel before attempting to use this equipment - otherwise, injury or damage may occur.



ACCESSORIES WARNING

Invacare products are specifically designed and manufactured for use in conjunction with Invacare accessories. Accessories designed by other manufacturers have not been tested by Invacare and are not recommended for use with Invacare products.



NOTICE

THE INFORMATION CONTAINED IN THIS DOCUMENT IS SUBJECT TO CHANGE WITHOUT NOTICE.

2.2 Important Safety Information



DANGERS - ELECTRICAL SHOCK HAZARD

Grounding is required.

The installation and maintenance of the tub MUST be done by a qualified technician, certified electrician or plumber. Disconnect electrical supply or turn off circuit breaker before installing or performing any maintenance on the tub. The unit MUST be connected only to a supply circuit that is protected by a ground fault circuit-interrupter (GFCI). Be certain ALL electrical work is performed by a qualified electrician and is in compliance with local electrical codes. ALL electrical connections are to be water resistant.



DANGER - RISK OF SCALDING

The hot water supply to the tub MUST not exceed 110°F (43° C) to protect the user from scalding.



WARNING - PLUMBING

Be certain all plumbing work is performed by a qualified plumber and is in compliance with local codes.



WARNING - FLOOR LOAD CAPACITY

The installation area **MUST** be able to support the 66 pounds per square inch (45 n/cm²) load capacity of the tub. Otherwise, injury or damage may occur.



WARNINGS - SAFE USE

Use this unit only for its intended use as described in this manual.

If any part of the system is not functioning properly, **DO NOT** use the tub.

NEVER drop or insert any object into any opening.

DO NOT operate the tub without the jet assemblies installed.

The tub **MUST** be cleaned and disinfected after each use. Refer to [Cleaning and Disinfecting](#) on page 21.

Keep hair and body away from the jet assemblies when pump is running.

Hyperthermia occurs when the internal temperature of the body reaches a level several degrees above the normal body temperature of 98.6° F. The symptoms of hyperthermia include an increase of the internal temperature of the body, dizziness, lethargy, drowsiness, and fainting.

To reduce the risk of injury, **DO NOT** permit children or infirm persons to use this tub **UNLESS THEY ARE SUPERVISED AT ALL TIMES**.

Recommended length of time spent in a bath is 5 to 10 minutes. However, if you or the person you are caring for becomes nauseated or dizzy or the person develops a headache, get out of the tub at once and safely bring the body temperature back to normal (98.6°F).

Seek medical attention if symptoms or sickness persist. Check with the physician **BEFORE** using the tub again.

Anyone under a doctor's supervision, pregnant, or with poor health should check with a physician **BEFORE** using this tub.

3 Overview

3.1 Features

Model 3802G

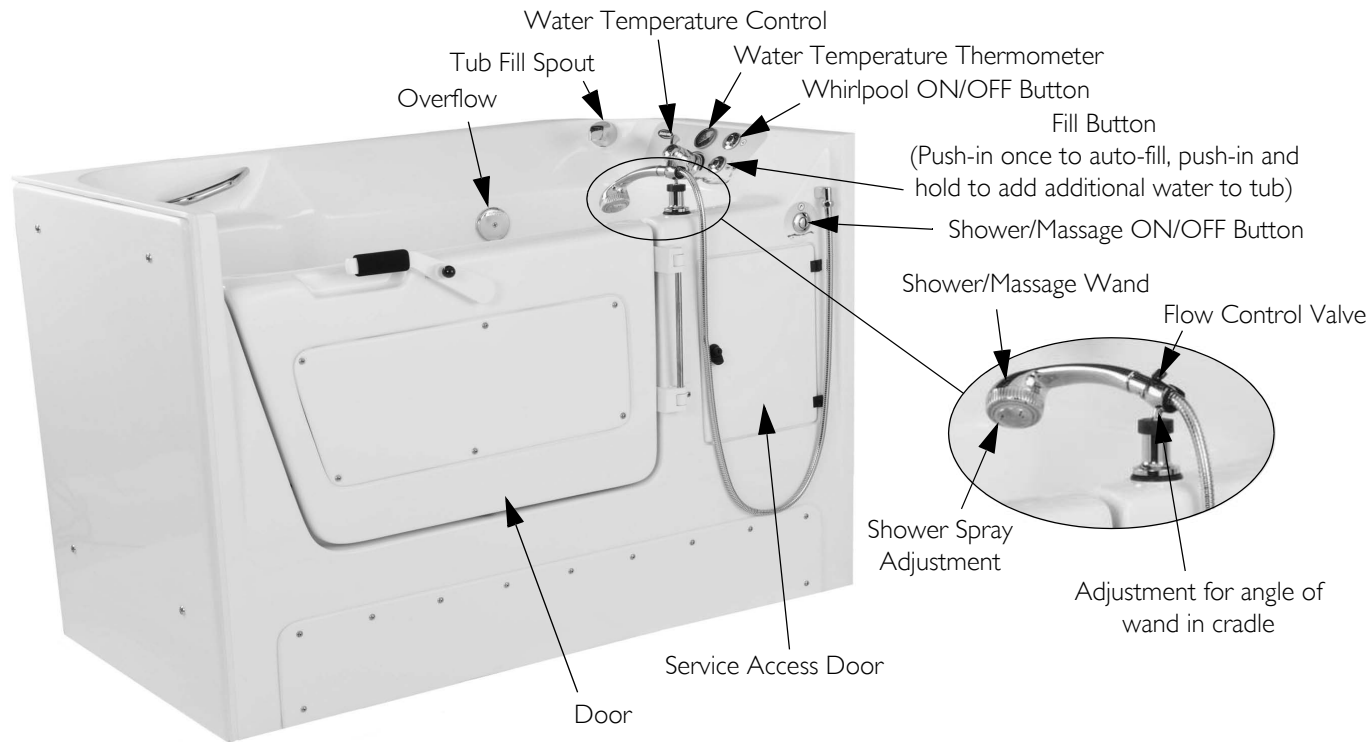

Model 3752G

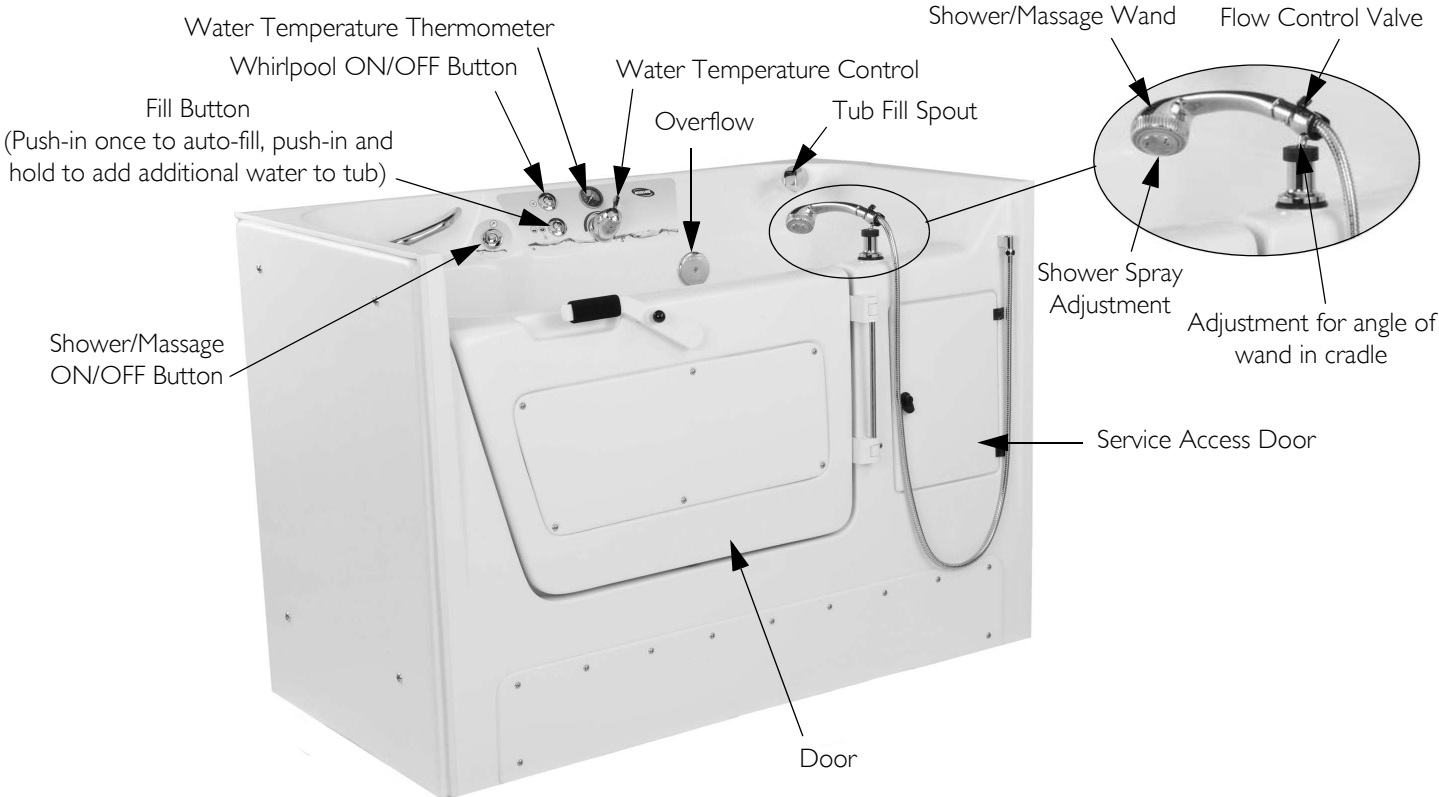

3 OVERVIEW

3.2 Product Labeling



Labels located inside the Service Access Door

CAUTION

Some state and local plumbing codes require the installation of a "reduced pressure zone" (RPZ) assembly on both the incoming hot and cold supply lines to prevent back flow contamination into the potable water system. Invacare recommends you check local plumbing code requirements to determine if RPZs are required on your tub installation. RPZs are NOT supplied by Invacare and are to be provided by the customer if required.

PN 1150759 Rev A

⚠ DANGER

ELECTRICAL SHOCK HAZARD. The National Electrical Code requires the use of a ground fault circuit interrupter (GFCI) on all therapeutic pools and tubs (hydro-therapeutic tanks). Failure to follow this requirement could result in serious or fatal injury. All disassembly and maintenance of the Tub MUST be done by a qualified technician, certified electrician or plumber. Disconnect electrical supply or turn OFF circuit breaker before performing any maintenance to the Tub. DO NOT remove this label.

1167463 Rev A

⚠ WARNING

DO NOT operate or service this equipment without first reading and understanding the user manual.

1167463 Rev A

Invacare CONTINUING CARE, INC.
Elyria, OH 44030 U.S.A.

MODEL NO.	SERIAL NO.	MFG. DATE

VOLTS: 115 VAC
AMPS: 7.0 Max Continuous Duty
CYCLE: 60 Hz

UL
Invacare
2000/102

ETL
L27018

Complies to UL 60601-1 and UL 1306.
Certified to CAN/CSA C22.2 #1000-1-0000
and CAN/CSA 945.10-01

ASME B172.1-1-99 (CSA B172.1-05)
CSA 9.10.3, CSA 945.10-01, CSA 945.0-02
CSA 945.1-05, IEC 1321-2:2004
ANSI/ISO 9112:1978/ISO 9001:2004 2134 1.2 2009



Label located on Interior Hardware

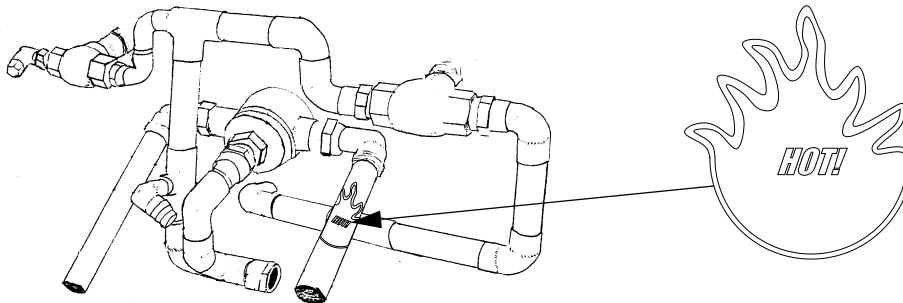

3.3 Typical Product Parameters

3752G

3802G

Weight	
Tub (shipping weight)	319 pounds (144 kg)
Tub (empty)	260 pounds (117 kg)
Tub (filled without user)	796 pounds (361 kg)
Floor Load Capacity	66 PSI (45 n/cm ²)
Minimum Space Requirements:	7 feet x 6 feet
Exterior Length/Interior Length:	59-1/2 inches/49 inches
Exterior Width/Interior (Seat) Width:	31-1/2 inches/21 inches
Deck Height:	41-1/2 inches
Side Access Door Swing:	40 inches
Volume Capacity (with user):	47 gallons
Lift Base Clearance:	6-1/4 inches
Electrical	
Classification	Class I, Type B
Power	115 VAC, 60 Hz
Current Rating	7 Amps
Number of Jet Outlets:	4
Tub Material:	Double-wall gel coated fiberglass
Thermometer:	2 inch dial, 75° to 120° F (25° - 50° C)
Anti-Scald Water Regulator:	Moen ExactTemp®

3 OVERVIEW

3.4 Minimum Floor Space and Clearance Requirements

Models 3752G or 3802G

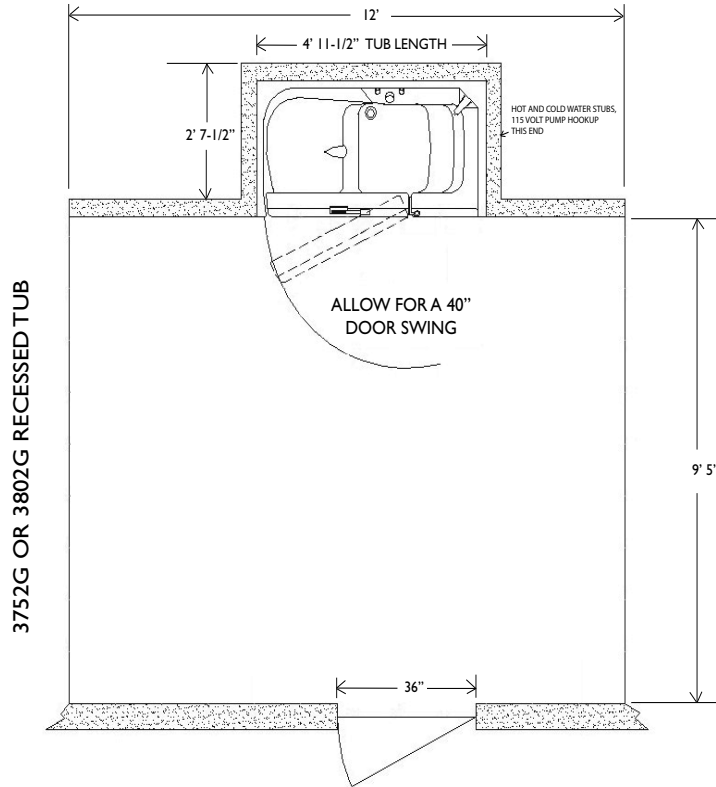

3.5 Dimensions

Models 3752G or 3802G

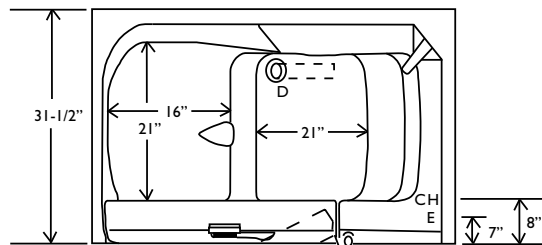
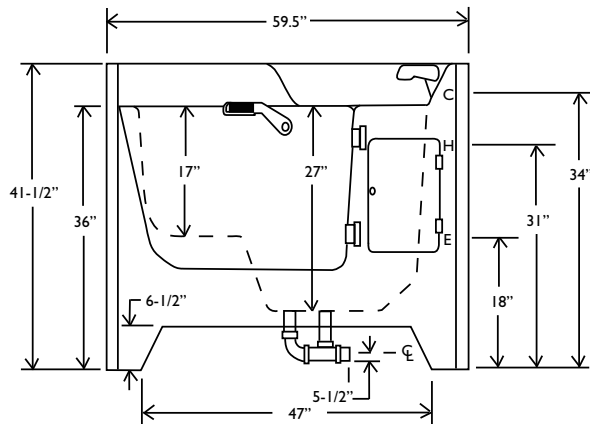

Allow for a 40" door swing

C	3/4" Cold water stub with recommended shut off valve
D	2" Drain (floor drain recommended)
E	115V AC, 60 Hz, 15 A Input
H	3/4" Hot water stub with recommended shut off valve
Allow for 40" door swing (60" for wheelchair or lift access)	

4 Installation



WARNINGS

Check all parts for shipping damage. In case of damage, DO NOT use. Contact the carrier for further instruction.

The installation area MUST be able to support the 66 pounds per square inch (45 n/cm²) load capacity of the tub. Otherwise, injury or damage might occur.

Access for servicing the tub MUST be provided. Install the tub in a location that will permit access to the service panels, plumbing and electrical hookups.



CAUTIONS

DO NOT lift the tub by the plumbing.

DO NOT modify the tub in any way. Modifications to the system or any component may cause the system to malfunction and will void the warranty.

The door MUST be closed and latched during installation to avoid deformation of the tub shell.



ICCI assumes no responsibility for code infractions or damage to components due to improper installation.

Use extreme care during installation.

After installation and before use ensure all parts are properly and securely installed.

Ensure the bathroom floor is dry and free of obstructions before transporting or assembling the unit.

4.1 Preparing the Work Area



Access for servicing the tub **MUST** be provided.

Follow the recommended floor plan. Refer to [Minimum Floor Space and Clearance Requirements](#) on page 12.

The tubs are designed to be built-in against one, two or three walls, much the same way a traditional tub/shower unit is installed in an alcove. Optional end panels are available for corner or one wall installation and are only available at the time of the tub order.

One wall installation

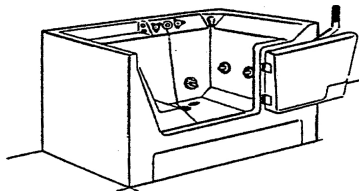

Two wall installation (corner)

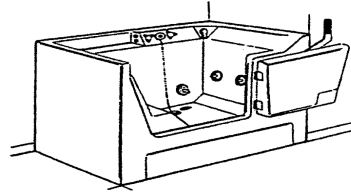

Three wall installation (recessed)

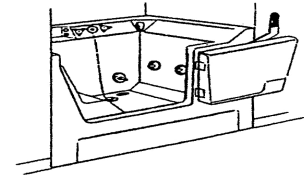

1. Carefully remove the tub from the carton and inspect for shipping damage. If damage is found, contact the carrier.
2. Measure the tub.
3. Ensure the floor in the area of installation will be able to support the 66 pounds per square inch (45 n/cm²) load capacity of the tub.
4. Determine whether the unit will be built against one, two or three walls.



Three wall installation only - ensure a stud wall “pocket” has been constructed to receive the tub unit.

The opening of the pocket should be sized to allow the tub to slide in easily, without any binding between the studs and the tub.

Minor gaps can be covered by drywall or paneling. In remodeling situations, where tub or shower units have been removed, it may be necessary to modify the pocket to receive the tub.

If desired, a wooden nailer may be attached to the stud walls as an additional mounting fixture for the tub.

5. Temporarily slide the tub into place.
6. Mark the location of the fiberglass lip against the studs.
7. Mount 2-inch by 2-inch cleats approximately 1/8-inch below the marks made in STEP 6.



Ensure the cleats do not interfere with any components of the tub or restrict the installation in any way.

8. Install a service access panel (minimum 16 by 14-inches on the wall (the back wall or right wall) to allow the tub components to be serviced.

4 INSTALLATION

4.2 Electrical and Plumbing Hook-up Locations



Refer to [Electrical Installation](#) on page 17 and [Plumbing Installation](#) on page 18. Model 3752G shown below.

**Front View
Model
3752G**

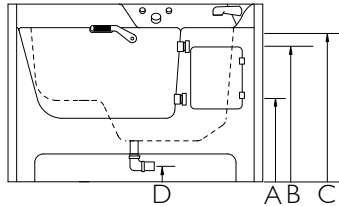

**Top View
Model 3752G**

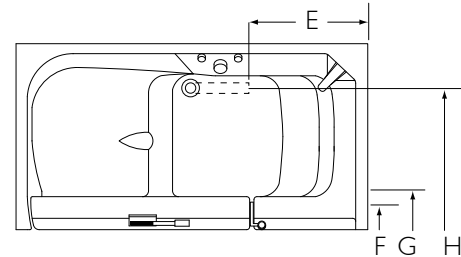

LETTER	DESCRIPTION	3752G AND 3802G (DIMENSIONS IN INCHES)
A	Height of Motor (Electrical) Input (115V AC, 60 Hz, 15A) (plug)	18
B	Height of ¾-inch Hot Water Stub with Recommended Shut Off Valve	31
C	Height of ¾-inch Cold Water Stub with Recommended Shut Off Valve	34
D	Height of 2-inch Drain Pipe (Center) from Floor	5.25
E	Distance of End of 2-inch Drain Pipe from Right End of Tub	19.5
F	Distance to Electrical Input	7
G	Distance of ¾-inch Hot and Cold Water Stubs with Recommended Shut Off Valves from Front of Tub	8
H	Distance of End of 2-inch Drain Pipe from Front of Tub	20

4.3 Electrical Installation



DANGERS - ELECTRICAL SHOCK HAZARD

Grounding is required.

The installation and maintenance of the tub **MUST** be done by a qualified technician, certified electrician or plumber.

Disconnect electrical supply or turn off circuit breaker before installing or performing any maintenance on the tub.

The National Electric Code requires the use of a ground fault circuit interrupter on all therapeutic pools and tubs (hydro therapeutic tanks). Failure to follow this requirement could result in serious or fatal injury. Use a 15 AMP GFCI breaker only.

Be certain ALL electrical work is performed by a qualified electrician and is in compliance with local electrical codes.

ALL electrical connections **MUST** be water resistant.



WARNINGS

The unit **MUST** be connected only to a supply circuit that is protected by a ground fault circuit-interrupter (GFCI). Such a GFCI should be provided by the installer and should be tested on a routine basis. To test the GFCI, push the test button. The GFCI should interrupt power. Push the reset button. Power should be restored. If the GFCI fails to operate in this manner, GFCI is defective. If the GFCI interrupts power to the bathtub without the test button being pushed, a ground current is flowing, indicating the possibility of an electric shock. **DO NOT** use this tub. Disconnect the tub and have the problem corrected by a qualified service representative **BEFORE** use.

All electrical conduit, fittings and wire to unit are to be supplied and installed by a professional electrician in accordance with the National electrical code as a minimum requirement, including the supply and installation of a Ground Fault Circuit Interrupter (GFCI).

For Canadian installation, ground fault interrupter and a 30-minute maximum timer **MUST** be installed in the electrical circuit. (Parts not supplied by ICCI). The unit must be operated through the circuit. The 30-minute timer must be located in a position where a person in the unit cannot reach the timer.



Use a 15 AMP GFCI breaker only.

Ensure a 15 AMP GFCI breaker is installed to protect the unit. Insert the plug into a pre-installed GFCI protected hospital grade receptacle.

4 INSTALLATION

4.4 Plumbing Installation



DANGER - RISK OF SCALDING

The hot water supply to the tub MUST NOT exceed 110° F (43° C) to protect the user from scalding.



WARNINGS

Be certain all plumbing work is performed by a qualified plumber and is in compliance with local codes.

Some state and local plumbing codes require the installation of a “reduced pressure zone” (RPZ) assembly on both the incoming hot and cold supply lines to prevent back flow contamination into the potable water system. Invacare recommends you check local plumbing code requirements to determine if RPZs are required on your tub installation. RPZs are NOT supplied by Invacare and are to be provided by the customer if required.



CAUTIONS

Purge water lines. Hot and cold lines MUST be purged (blown down) to clear lines of debris prior to connection. Valves and spray heads may become inoperable and/or damaged if lines are not properly cleared. Items damaged in this way are not covered under the warranty. When operating water pressure exceeds 55 PSI, pressure regulators (similar to the ¾-inch Watts U5) MUST be installed.

1. Refer to [Electrical and Plumbing Hook-up Locations](#) on page 16 for the location of the hot water stub and cold water stub.
2. Measure the location of the drain on the unit.
3. Install the drain in the floor in the appropriate location determined in STEP 2.
4. Purge water lines. Hot and cold lines MUST be purged (blown down) prior to connection, to clear lines of debris.
5. Install On/Off valves at wall and use unions between valves and stubs.
6. Connect hot and cold supply lines to ¾-inch copper pipes found on back of tub in accordance with applicable building codes.
7. Connect 2-inch drains in accordance with local plumbing codes.
8. Attach the shower/massage wand and flow valve. Be sure to use the washers supplied.
9. Check for leaks in supply or drain lines and check operation of tub. Refer to [Operating Instructions](#) on page 20.



Check local codes regarding maximum water temperature allowed at hot water outlets for facility type.

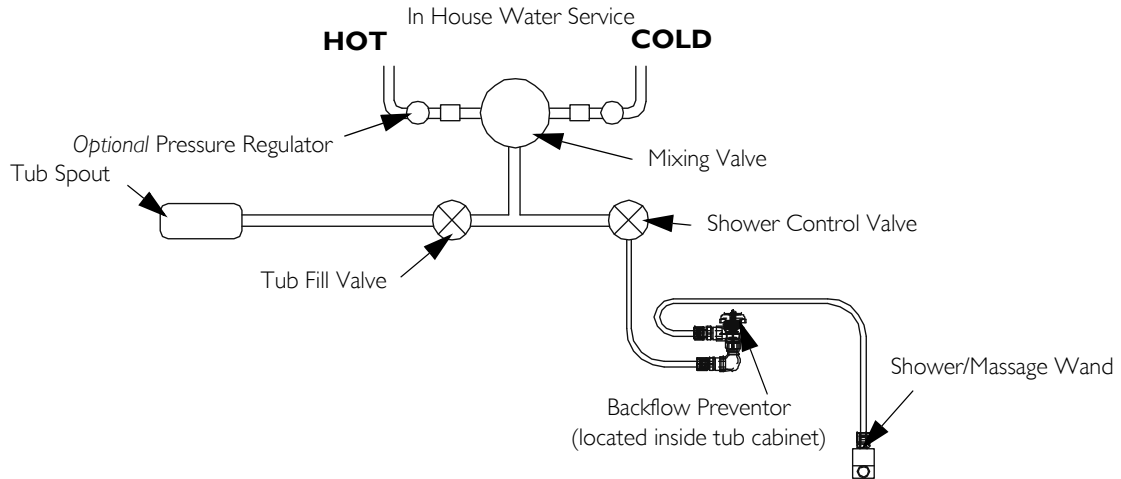

4.5 Post Installation Checklist

Before putting the tub into service, check the following:

- Water lines have been purged of any foreign matter.
- Both hot and cold water lines are properly connected to the tub.
- Dedicated 115V 15 AMP AC power line is properly wired to the unit.
- Power line is protected by a 15 AMP GFCI.
- All water lines are checked for leaks.
- ICCI skin care and cleaning products have been ordered. To place your order, call 800-668-2337.
- ICCI representative has been called to arrange for an In-Service on the tub. To schedule, call 800-668-2337.

5 Operating Instructions

5.1 Overview



WARNINGS

Read and understand ALL information in this manual BEFORE use.

Clean and disinfect the tub after EACH use to avoid resident infection and contamination of the tub.

DO NOT clean or disinfect the tub when it is occupied. Otherwise injury may occur.

To reduce the risk of injury, DO NOT permit children or infirm persons to use this tub UNLESS THEY ARE SUPERVISED AT ALL TIMES.

Recommended length of time spent in a bath is 5 to 10 minutes. However, if you or the person you are caring for becomes nauseated or dizzy or the person develops a headache, get out of the tub at once and safely bring the body temperature back to normal (98.6°F). Seek medical attention if symptoms or sickness persist. Check with the physician BEFORE using the tub again.

Anyone under a doctor's supervision, pregnant, or with poor health should check with a physician BEFORE using this tub.



Perform these procedures in the following order:

1. Make sure that the tub has been cleaned, disinfected and BEFORE use. Refer to Cleaning and Disinfecting on page 21.
2. Open the tub door.
3. Transfer the resident to the tub.
4. Use the waist strap to help stabilize the resident in the tub as necessary. Refer to Waist Strap on page 27.
5. Fill the tub.
6. Bathe the resident.
7. Drain the tub.
8. Remove the waist strap (if used).
9. Open the door.
10. Transfer the resident from the tub.
11. Clean and disinfect the tub, including the door seal and waist straps.
12. Leave the door ajar when tub is not in use to avoid compressing the seal. This will prolong the life of the door seal.

5.2 Cleaning and Disinfecting



WARNINGS

Clean and disinfect the tub after EACH use to avoid resident infection and contamination of the tub.

DO NOT clean or disinfect the tub when it is occupied. Otherwise injury may occur.

Read and understand ALL information on disinfecting BEFORE use.

ALWAYS wear rubber gloves, an apron and a face shield when using disinfectant. In case of eye or skin contact, follow procedures on the disinfectant container.



CAUTION

NEVER use abrasive cleaners like scouring powder or liquid cleaners containing pumice stone. The use of these types of cleaners will make the gel-coat finish of your tub scratched and dull. NEVER use cleaners containing Iodine, Household Bleach, Bromine, Betadine® or Methylene Blue. The use of these types of cleaners will cause the tub to stain. Use of unapproved cleaners will dry out the rubber seals and gaskets and the tub will not function properly.

5 OPERATING INSTRUCTIONS

1. Use the drain plug to close the drain.
2. Remove and disassemble all jet assemblies. Lay all pieces in the footwell of the tub.
 - Rotate each jet assembly counterclockwise and pull away from the jet casing. (Detail “A”).
 - Remove each impeller cap by rotating it clockwise (Detail “B”).
 - Remove each impeller (Detail “C”).

Detail “A”

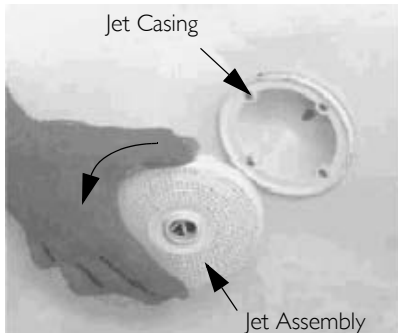

Detail “B”

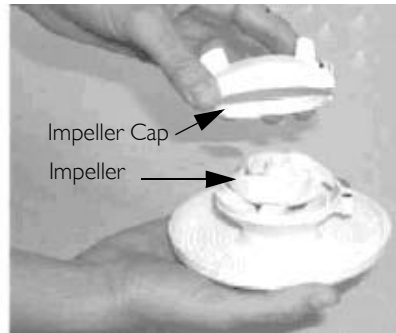

Detail “C”

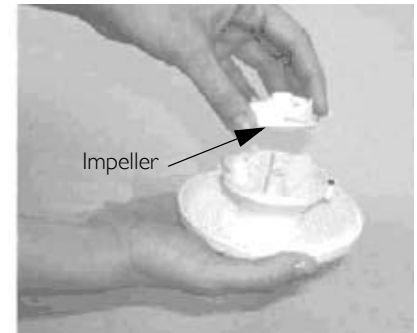

3. Remove the waist straps from the mounting attachment points. Put the straps into the footwell of the tub.
4. Clean the pieces and spray all surfaces of the tub with Dispatch® Cleaner and Disinfectant. Take a long handled brush and thoroughly clean the interior surfaces of the tub and the jet casings.
5. Allow the Dispatch Cleaner and Disinfectant to sit on the surfaces for one minute.
6. Rinse all surfaces and pieces in the footwell of the tub with water.
7. Use a clean towel to dry all tub surfaces and all pieces in the footwell of the tub. Allow the waist straps to air dry.



WARNING

DO NOT put the waist straps in the dryer, otherwise damage to the straps may occur.

8. Replace the impeller and impeller cap on each jet assembly.

**WARNING**

Cross-threading the jet assembly onto the casing may cause damage to the whirlpool motor. After installation, ensure that the jet assembly is flush against the jet casing.

9. Assemble each jet assembly to the jet casings.
 - Position the Sanijet® logo and RED indicator at the 11 o'clock position.
 - Insert the jet assembly into the receptacle in the tub and rotate the jet assembly clockwise until it locks into place.

Removing Soap Film and Hard Water Deposits

Use a commercially available cleaner such as Invacare Heavy Duty Cleaner. Remove the jet assemblies. Remove the impeller caps. Thoroughly spray the exposed surfaces, including the jet casings. Use a long handled soft brush or similar product to wipe down all surfaces and allow the heavy duty cleaner to remain in contact with the exposed surfaces for approximately ten minutes. Rinse off surfaces using the shower wand, adjusted to spray position.

5 OPERATING INSTRUCTIONS

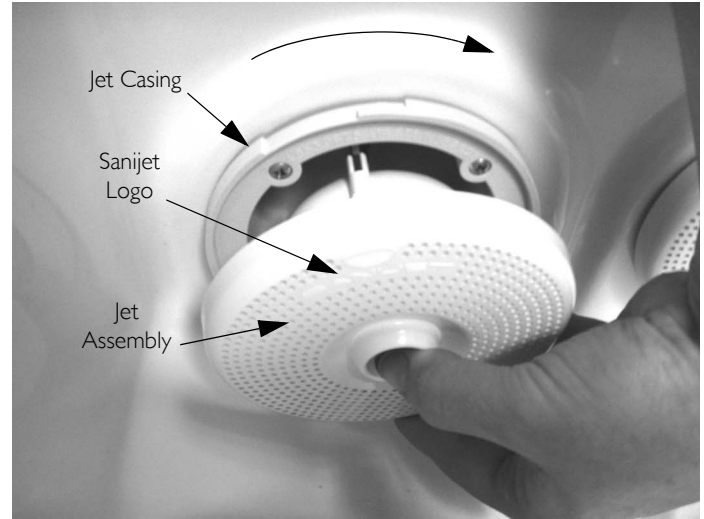

Removing Calcium Deposits, Scale and Lime Build-up

Spray a commercially available cleaner (full strength) for the intended application on all surfaces to be cleaned. Allow the cleaner to remain in contact with surfaces for at least five minutes to as long as 12 hours. Rinse off surfaces using the shower wand, adjusted to the spray position. Use the cleaner according to the manufacturer's instructions.

5.3 Opening/Closing the Tub Door



WARNINGS

DO NOT open the door when water is in the tub, otherwise serious injury could result.

DO NOT fill or use the tub if the door does not lock - otherwise serious injury or damage may occur

Opening the Tub Door

1. Place one hand on top of the door handle.
2. Use the other hand to pull the safety pin out and release the door handle.
3. Lift up on the door handle and open the door.

Closing the Tub Door

1. Close the door.
2. Push down on the door handle to lock the door into position.
3. Lift the door handle to ensure the safety pin has engaged the door properly.
4. If the door handle lifts, repeat STEPS 1-3.

5 OPERATING INSTRUCTIONS

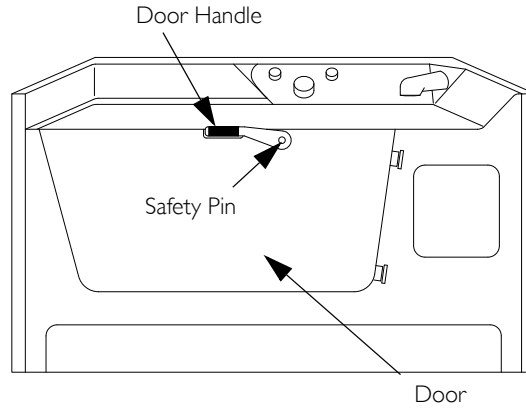

5.4 Waist Strap



The waist strap is a positioning guide only. The strap is not designed for use as a safety device or as a restraint. The strap **MUST** be washed and disinfected after each use. Refer to [Cleaning and Disinfecting](#) on page 21.

Installation

On each end of the waist strap, insert the lead into the round portion of the slot in the attachment point, slide the lead up and turn it.

Use

1. Bring both ends of the waist strap around the resident. Secure the ends together with the plastic clasp.
2. Adjust the straps for comfort as necessary.

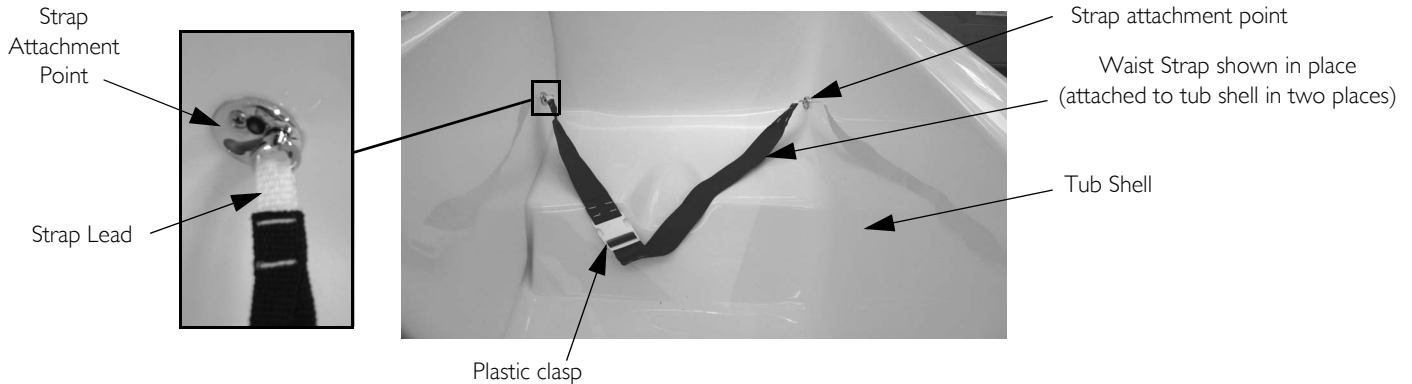

5 OPERATING INSTRUCTIONS

5.5 Water Temperature Setting



WARNING

The causes, symptoms and effects of hyperthermia may be described as follows: Hyperthermia occurs when the internal temperature of the body reaches a level several degrees above the normal body temperature of 98.6° F. The symptoms of hyperthermia include an increase in the internal temperature of the body, dizziness, lethargy, drowsiness, and fainting. The effects of hyperthermia include:

- Failure to perceive heat
- Failure to recognize the need to exit the spa or hot tub
- Unawareness of impending hazard
- Fetal damage in pregnant women
- Physical inability to exit the spa or hot tub
- Unconsciousness resulting in the danger of drowning
- The use of alcohol, drugs, or medication can greatly increase the risk of fatal hyperthermia.

Flow Water Thermometer - measures the temperature of water coming from the tub fill spout or shower/massage wand.

Water Temperature Control Valve - sets and maintains constant temperature for all incoming water.

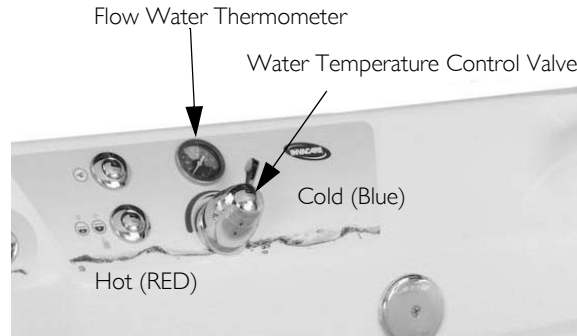

5.6 Filling the Tub



DANGER - RISK OF SCALDING

Check that the water temperature is between 95° and 105°F (35°C and 41°C) to avoid scalding the resident. Monitor the incoming water temperature on the flow water thermometer. ALWAYS hand test the incoming water temperature and the water temperature in the tub.



WARNING

DO NOT stand in the tub. The tub surfaces are slippery when wet. Serious injury may occur.

1. Close the drain with the blue stopper.
2. Push the tub fill button to start auto-fill.



The tub will fill to a predetermined level. To stop the tub from filling, press the fill button a second time (there will be a 5 second delay). After the tub has auto-filled, push in and hold the tub fill button to add additional water.

3. Use the water temperature control valve to adjust the water temperature while watching the flow water thermometer. Test the water temperature with your hand.
4. After the tub has auto-filled, push in and hold the tub fill button to add additional water.

5.7 Using the Shower/Massage Wand





Make sure that the Shower/Massage wand is in the cradle and the shower wand head is over the tub. The angle of the wand cradle can be adjusted to accommodate the user's need.

1. Turn the shower/massage on by pushing the ON/OFF button.
2. Adjust the water temperature using the water temperature valve while watching the flow water thermometer. Test the water temperature with your hand.
3. Adjust the flow of the water by turning the flow control.
4. Adjust the shower spray by rotating the shower wand head.
5. Turn the shower/massage off by pressing the ON/OFF button again.

5 OPERATING INSTRUCTIONS

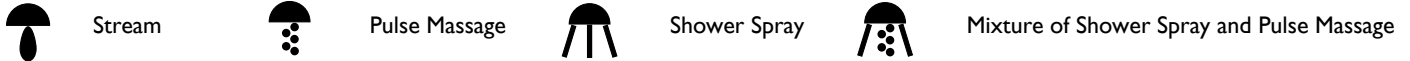
 Refer to the following chart for shower head adjustment settings.



 Flow Control serves as a volume control and water saver.

The use of the Flow Control permits the reduction of water flow without the need for readjustment of water temperature during bathing. A trickle of water through the Flow Control when in the closed position is normal.

5.8 Using the Whirlpool Function

1. If the water level does not cover the whirlpool jets, push the tub fill button to auto-fill the tub.
2. After the water level covers the whirlpool jets and after bathing the resident, add Invacare Defoamer to the bath water. Refer to the Defoamer bottle for directions.
3. Push the whirlpool button to start whirlpool jets. After use, press the whirlpool button again to stop the whirlpool jets.
4. Drain the tub completely.
5. Transfer the resident from the tub.
6. Clean and disinfect the tub, including the door seal. Refer to [Cleaning and Disinfecting](#) on page 21.

6 Inspection and Troubleshooting

If any part of the system is not functioning properly, DO NOT use the system. For parts and technical service information please contact ICCI Technical Service at (800) 668-2337, Extension 2.

6.1 Safety Inspection Checklists



Every six months or as necessary have a qualified technician perform a thorough inspection and servicing. Routine maintenance will extend the life and efficiency of your tub.

Initially

- Ensure that the maximum water supply temperature does not exceed 110°F.
- Ensure that the maximum water pressure does not exceed 55 PSI.
- Verify the water flow temperature with a separate thermometer.
- Visually inspect for cracks in the tub surface.
- Ensure that the door handle locks the door closed.
- Ensure that the safety pin properly engages the door.
- Check that all labels are present and legible. Replace if necessary.

Before Each Use

- Clean and Disinfect the tub. Refer to [Cleaning and Disinfecting](#) on page 21.
- Ensure that the maximum water fill temperature does not exceed 110°F (43° C).
- Ensure that the maximum water pressure does not exceed 55 PSI.
- Visually inspect for cracks in the tub surface.
- Ensure that the door handle locks the door closed.
- Ensure that the safety pin properly engages the door.

Every Six Months

- Verify the water flow temperature with a separate thermometer.
- Check that all labels are present and legible. Replace if necessary.
- Clean the Water Temperature Control Valve to remove lime deposit.

6 INSPECTION AND TROUBLESHOOTING

6.2 Troubleshooting



If problems are not remedied, contact technical support at 1-800-668-2337, Extension 2.

SYMPTOMS	FAULTS	SOLUTION
Hydromassage System		
System will not start	No electrical power to tub	Check and reset breaker
	Switch air hose disconnected	Reconnect hose to switch and controller
System is ineffective	Water deposits in whirlpool jets	Disassemble and clean whirlpool jets
System is noisy	Whirlpool jets are turned on without water completely covering the jet assemblies	Turn off the whirlpool jets. Add water to the tub to completely cover the jet assemblies and test the whirlpool function again.
Tub Operation		
No water flow	Water supply turned off	Turn on water supply
Restricted water flow	Water temperature control valve	Inspect and clean the water temperature control valve. Refer to the Moen service manual at www.moen.com . Search for Model 3371 ExactTemp Temperature Control Valve, Service Manual Number 153768.

NOTES

Notes

Notes



Yes, you can.®

Invacare Corporation

www.invacare-cc.com

USA and Canada

One Invacare Way
Elyria, Ohio USA
44036-2125

Customer Service
1-800-668-2337
Technical Support
1-800-668-2337,
Extension 2

Manufacturing Location

899 Cleveland Street
Elyria, Ohio 44036

© 2011 Invacare Corporation. All rights reserved. Republication, duplication or modification in whole or in part is prohibited without prior written permission from Invacare. Trademarks are identified by [™] and [®]. All trademarks are owned by or licensed to Invacare Corporation or its subsidiaries unless otherwise noted. Dispatch is a registered trademark of Clorox Industries, Inc. Sanijet and Pipeless TM are registered trademarks of Maple Industries, LLC, d.b.a. Sanijet. ExactTemp is a registered trademark of Moen Incorporated. Betadine is a registered trademark of Purdue Pharma LP.

For more information regarding Invacare products, parts, and services, please visit www.invacare-cc.com.

Invacare Continuing Care, Inc. is a subsidiary of Invacare Corporation

Part No. 1167458



Rev C - 12/11

