

- 
- Please read this manual before using your phone.
  - All illustrations in this user manual are for illustration only and may not accurately depict the actual phone.
  - We operate a policy of continuous development and reserve the right to make changes and improvements to any of the products described in this manual without prior notice.

---

---

## Table of Contents

<b>1. Safety information.....</b>	<b>4</b>
<b>2. General information .....</b>	<b>12</b>
2.1 Checking the phone and accessories .....	12
2.2 Illustrations of the phone and function .....	12
2.3 Idle mode display .....	16
2.4 Technical specifications.....	16
2.5 SIM card & battery .....	16
2.5.1 Installing SIM card & battery .....	17
2.5.2 Removing SIM card & battery .....	17
2.6 Charging the battery .....	17
2.7 Power the phone on/off .....	18
2.8 Idle mode operations .....	18
<b>3. Basic Operations.....</b>	<b>18</b>
3.1 Making a call.....	18
3.1.1 Making a call from idle .....	18
3.1.2 Inserting a pause sign when dialing .....	19
3.1.3 Speed dialing .....	19
3.1.4 Redialing.....	19
3.2 Answering/rejecting a call .....	19
3.3 Missed calls .....	20
3.4 During a call.....	20
3.4.1 Muting a call.....	20
3.4.2 Handsfree earpiece.....	20
3.4.3 Adjusting earpiece volume .....	20
3.4.4 Searching for a number from the Contacts .....	20
3.4.5 DTMF .....	20
<b>4. Entering text .....</b>	<b>20</b>
4.1 Keypad mapping .....	21
4.2 ABC/abc input .....	21
4.3 123 input .....	22
4.4 Entering symbols .....	22
<b>5. The menus .....</b>	<b>22</b>
5.1 Menu Tree.....	22
5.2 Contacts.....	23
5.2.1 Search Entry .....	24
5.2.2 Add New Entry .....	24
5.2.3 View .....	24
5.2.4 Edit.....	24
5.2.5 Delete .....	24
5.2.6 Copy .....	25
5.2.7 Move.....	25

---



5.2.8 Delete All.....	25
5.2.9 Copy All.....	25
5.2.10 Owner Number .....	25
5.2.11 Speed dialing .....	26
5.2.12 Memory Status.....	26
5.3 Messages.....	26
5.3.1 Write Message .....	26
5.3.2 Inbox.....	26
5.3.3 Outbox .....	27
5.3.4 Template .....	27
5.3.5 Message Settings .....	27
5.3.6 Voice Mail .....	28
5.4 Call History.....	28
5.4.1 Missed /Dialed /Received .....	28
5.4.2 Delete Log .....	28
5.4.3 Call Time.....	28
5.5 Settings.....	28
5.5.1 Phone Setup .....	28
5.5.2 Call Setup .....	30
5.5.3 Network Setup .....	31
5.5.4 Security Setup .....	31
5.5.5 Restore Factory Settings .....	32
5.6 Games .....	33
5.7 Organizer .....	33
5.7.1 To Do List.....	33
5.7.2 Alarm.....	33
5.7.3 Calculator.....	33
5.8 Services .....	34
<b>6. Troubleshooting.....</b>	<b>34</b>

# 1. Safety information





Read these precautions carefully before using to ensure that you use the phone safely and correctly.

The precautions listed here are intended to prevent injury to the phone user and to others, and to prevent unintended damage to property.

- The designations below Indicates the severity of the injury or damage that may be incurred if the designated precautions are not followed and the product is used incorrectly.

 <b>DANGER</b>	Indicates that, if this warning is ignored, improper handling of the product is likely to result in death or serious injury.
 <b>WARNING</b>	Indicates that, if this warning is ignored, improper handling of the product could result in death or serious injury.
 <b>CAUTION</b>	Indicates that, if this warning is ignored, improper handling of the product could result in personal injury or material damage.

The icons shown below are used to indicate instructions that should be observed.

 <b>Prohibited</b>	 <b>Do not disassemble</b>
 <b>Essential</b>	 <b>Unplug</b>

## General Precautions When Using the Phone, Battery and AC adapter



### DANGER

Only use the battery and AC adapter specified by our brand for use with this phone. The use of a battery or AC adapter other than that specified could result in the battery leaking fluids, overheating, bursting or igniting.



Essential



### WARNING

Do not subject this product to strong shocks or vibrations or throw it around, as this could result in the battery leaking fluids, overheating, bursting or igniting, and could damage the phone and cause faults or a fire.

Do not place the battery, the phone itself or the AC adapter in a microwave oven or pressure cooker, as this could result in the battery leaking fluids, overheating, bursting or igniting, or could cause the phone or AC adapter to overheat, emit smoke, or ignite, or could damage the circuitry inside the device.

Do not use this product in places where there are inflammable gases, as this could cause the gases to ignite or result in device damage, faults or a fire.

Do not put the SIM card in the place which is within children's reach.



Prohibited



### CAUTION

Do not store this product in a very damp, dusty or hot location, as this could result in faulty operation.



Prohibited

Store this product out of the reach of small children, as it could cause injury if used as a toy.



Essential





Do not leave this product on an unstable or sloping surface, as it could fall and be damaged or cause injury.



Prohibited

## Precautions When Using the Phone

### **WARNING**





<p>Do not use your phone while driving, as this is dangerous and could cause a traffic accident. Pull over and park in a safe place before using the phone.</p>	 Prohibited
<p>Switch off the phone when you are in places where the use of phones is prohibited, such as in an aircraft or hospital. Phones can adversely affect the operation of electronic instrumentation and medical equipment. For information on using your phone in a medical facility, refer to the directives provided by the facility itself.</p>	 Essential
<p>Do not use your phone around electronic devices that use very weak signals or require very precise control. Radio wave interference can cause malfunctions or other problems in electronic devices.          Examples of affected devices:          Hearing aids, pacemakers and other electronic medical aids, fire alarms, self-opening doors and other automatic control devices, etc.          For more information on the effects of mobile phones on pacemakers and other electronic medical aids, check with the device manufacturer or supplier.</p>	 Prohibited
<p>Do not attempt to disassemble or modify your phone as this could cause injury or electric shock and could damage the phone.</p>	 Do not disassemble
<p>Please make a copy of important data. Our company does not assume the lose of data due to malfunction.</p>	 Essential

### **CAUTION**



<p>When the phone is used in some types of car, it could possibly affect the operation of electronic components in the car. Do not use the phone if it adversely affects the safe operation of the vehicle in any way.</p>	 Prohibited
<p>Do not use your phone in crowded places as the antenna could strike someone and cause injury.</p>	
<p>Keep your phone away from magnetic cards. Emissions from the phone can erase the information stored on floppy disks and cash cards or credit cards.</p>	
<p>Keep sharp metal objects such as thumbtacks away from the earpiece speaker. The dynamic speaker in the earpiece is magnetic and could attract sharp objects, causing injury.</p>	
<p>Keep the phone dry. Water or other fluids entering the phone could cause overheating, electric shock or damage to the phone.</p>	

## Precautions When Using the Battery

### **DANGER**

Do not dispose of the battery by throwing it in a fire, as this could cause the battery to ignite or burst.	
If you are having difficulty connecting the battery to your phone, do not use force as this could cause the battery to leak fluids, overheat or ignite.	
Do not short-circuit the battery terminals, and do not touch the terminals with metal objects such as paper clips or needles. Also, do not carry or store the battery with objects such as metal necklaces. Any of these could cause the battery to leak fluids, overheat, burst or ignite.	 <b>Prohibited</b>
Do not solder the terminals as this could cause the battery to leak fluids, overheat, burst or ignite.	
Any fluid from inside the battery coming into contact with the eye could cause loss of vision. If this occurs, flush the affected eye with clean water (without rubbing) and seek immediate medical treatment.	 <b>Essential</b>
Do not attempt to disassemble or modify the battery as this could cause the battery to leak fluids, overheat, burst or ignite.	 <b>Do not disassemble</b>
Do not use or store the battery in hot places such as near a fire or heating appliance. This could cause the battery to leak fluids, overheat, burst or ignite.	 <b>Prohibited</b>

### **WARNING**

If there are any noticeable changes in the battery while being used, charged or stored (overheating, discoloration, deformation, etc.), remove the battery from the phone or AC adapter and discard it. Continued use of the battery in such conditions could cause the battery to leak fluids, overheat, burst or ignite.	 <b>Prohibited</b>
Any battery fluid coming into contact with your skin or clothing could cause skin damage. Wash the fluid off immediately with clean water.	
If the battery is leaking fluid or producing any odor, move it away from any naked flame as this could cause the leaking fluid to ignite, resulting in a fire or in the battery bursting.	 <b>Essential</b>

## CAUTION

Keep the battery dry. Moisture on the battery could cause the battery to overheat, emit smoke or corrode.

Do not use or leave the battery in direct sunlight or in hot places such as in a car on a hot day. This could cause the battery to leak fluids and overheat, and could impair the performance or reduce the lifetime of the battery.



Prohibited

## Precautions When Using the AC adapter

## DANGER

Always use the AC adapter with a domestic power supply (eg. 220 V AC). The use of other voltages could cause an electric shock, fire, or damage to the AC adapter.



Essential

Never short-circuit the AC adapter plug as this could cause an electric shock, fire, smoke, or damage to the AC adapter.



Prohibited

Do not use the AC adapter if the power cord is damaged (core wiring exposed or cut, etc.) as this could cause a fire or electric shock.

Clean off any dust on the power plug as this could cause a fire.



Essential

Do not place containers of water (jugs, etc.) near the AC adapter. Water on the AC adapter could cause overheating, an electric shock or damage to the devices.



Prohibited

If any water or other liquid gets into the AC adapter, immediately unplug the power cord. Failure to do so could cause the AC adapter to overheat or catch fire, or cause an electric shock or damage to the AC adapter.



Unplug

Do not attempt to disassemble or modify the AC adapter as this could cause injury, an electric shock, fire, or damage to the AC adapter.



Do not disassemble

Do not use the AC adapter in places with a lot of water vapour, such as a bathroom, as this could cause an electric shock.



Prohibited

Do not touch the AC adapter, the power cord or the power socket with wet hands as this could cause an electric shock.

## CAUTION

Always unplug the AC adapter before performing any cleaning or maintenance. Failure to do so could cause an electric shock.



Essential

Do not place heavy objects on the power cord or attempt to modify the power cord as this could cause an electric shock or fire.



Prohibited

Always grasp the AC adapter itself when you unplug the AC adapter. Pulling on the power cord can damage the cord and cause an electric shock or fire.



Essential



## General Notes on Cleaning and Maintenance

### **Do not splash water on the phone or AC adapter.**

The phone, battery and AC adapter are not manufactured to waterproof specifications. Do not use them in places where there is a lot of water vapour, such as a bathroom, and take care to protect them from rain.

### **Use a soft, dry cloth to clean the phone and AC adapter.**

Wiping the phone or AC adapter with a wet cloth could cause faults. Also, solvents such as alcohol, thinners or benzine may remove the printed lettering on the phone or cause discoloration.

### **Wipe the AC adapter plug clean occasionally with a dry cloth.**

Soiled AC adapter plug result in a poor electrical connection which can cause power loss. This can also prevent the AC adapter from recharging the battery correctly.

## Notes on the Phone

### **Do not expose the phone to extremely low high temperatures.**

Use the phone in temperatures between 5°C and 35°C and a humidity of 35% to 85%.

Use the phone as far away as possible from equipment such as conventional phones, TVs, radios and electronic office equipment, as the phone can affect the operation of such equipment.

Do not discard the phone with garbage. Please check with the relevant local authorities for the correct method for disposing of your phone.

## Notes on the Battery

Store the battery in a cool, well-ventilated location that is not exposed to direct sunlight.

### **The battery has a limited life.**

However, the life of any battery is limited, and the amount of time for which a battery can be used between recharges gradually decreases. If repeated recharging fails to restore the battery's functionality, the battery life has expired and should be replaced with a new battery of the specified type.

### **Do not dispose used batteries with ordinary household garbage.**

Apply insulating tape to the battery terminals before you dispose of the battery. Check with the relevant local authorities for the correct method for disposing of your battery.

---

## Notes on the AC adapter

**To avoid malfunctions, do not charge the battery in the following places:**

- In direct sunlight
- Where the ambient temperature is below 5°C or above 35°C
- In humid or dusty locations or places subject to vibrations (this could cause malfunctions)
- Near an appliance such as a TV or radio (this could impair picture or sound quality).

---

**Note:** Any changes or modifications not expressly approved by the party responsible for compliance could void the user's authority to operate the equipment.

Some electronic devices are susceptible to electromagnetic interference sent by phone if inadequately shielded. Please use phone at least 20cm or as far as you can from TV set, radio and other automated office equipment so as to avoid interference.

Your wireless phone is a radio transmitter and receiver. It is designed and manufactured not to exceed limits for exposure to radio frequency (RF) energy set by the Federal Communications Commission (FCC) of the U.S. Government. These limits are part of comprehensive guidelines and establish permitted levels of RF energy for the general population. The guidelines are based on standards that were developed by independent scientific organizations through periodic and thorough evaluation of scientific studies. The standards include a substantial safety margin designed to assure the safety of all persons, regardless of age or health.

This device complies with part 15 of the FCC Rules. Operation is subject to the following two conditions: (1) This device may not cause harmful interference, and (2) this device must accept any interference received, including interference that may cause undesired operation.

The antenna(s) used for this transmitter must be installed with providing a separation distance of at least 20cm from all persons.

This equipment has been tested and found to comply with the limits for a Class B digital device, pursuant to Part 15 of the FCC Rules. These limits are designed to provide reasonable protection against harmful interference in a residential installation. This equipment generates, uses and can radiate radio frequency energy and, if not installed and used in accordance with the instructions, may cause harmful interference to radio communications. However, there is no guarantee that interference will not occur in a particular installation. If this equipment does cause harmful interference to radio or television reception, which can be determined by turning the equipment off and on, the user is encouraged to try to correct the interference by one or more of the following measures:

- Reorient or relocate the receiving antenna.
- Increase the separation between the equipment and receiver.
- Connect the equipment into an outlet on a circuit different from that to which the receiver is connected.
- Consult the dealer or an experienced radio/TV technician for help.

---

## 2. General information

### 2.1 Checking the phone and accessories

After unpacking, please check the accessories. If there is anything missing or there are pages lost in the user's manual, which cause it unreadable, please contact the local seller that you purchased the phone from.

### 2.2 Illustrations of the phone and function

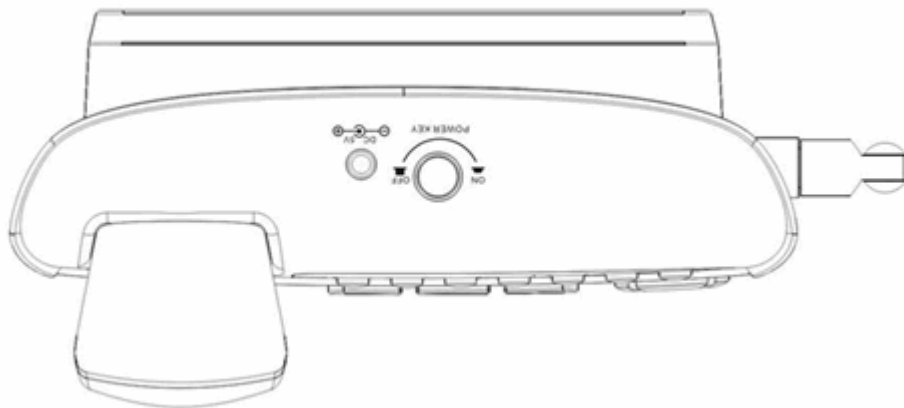

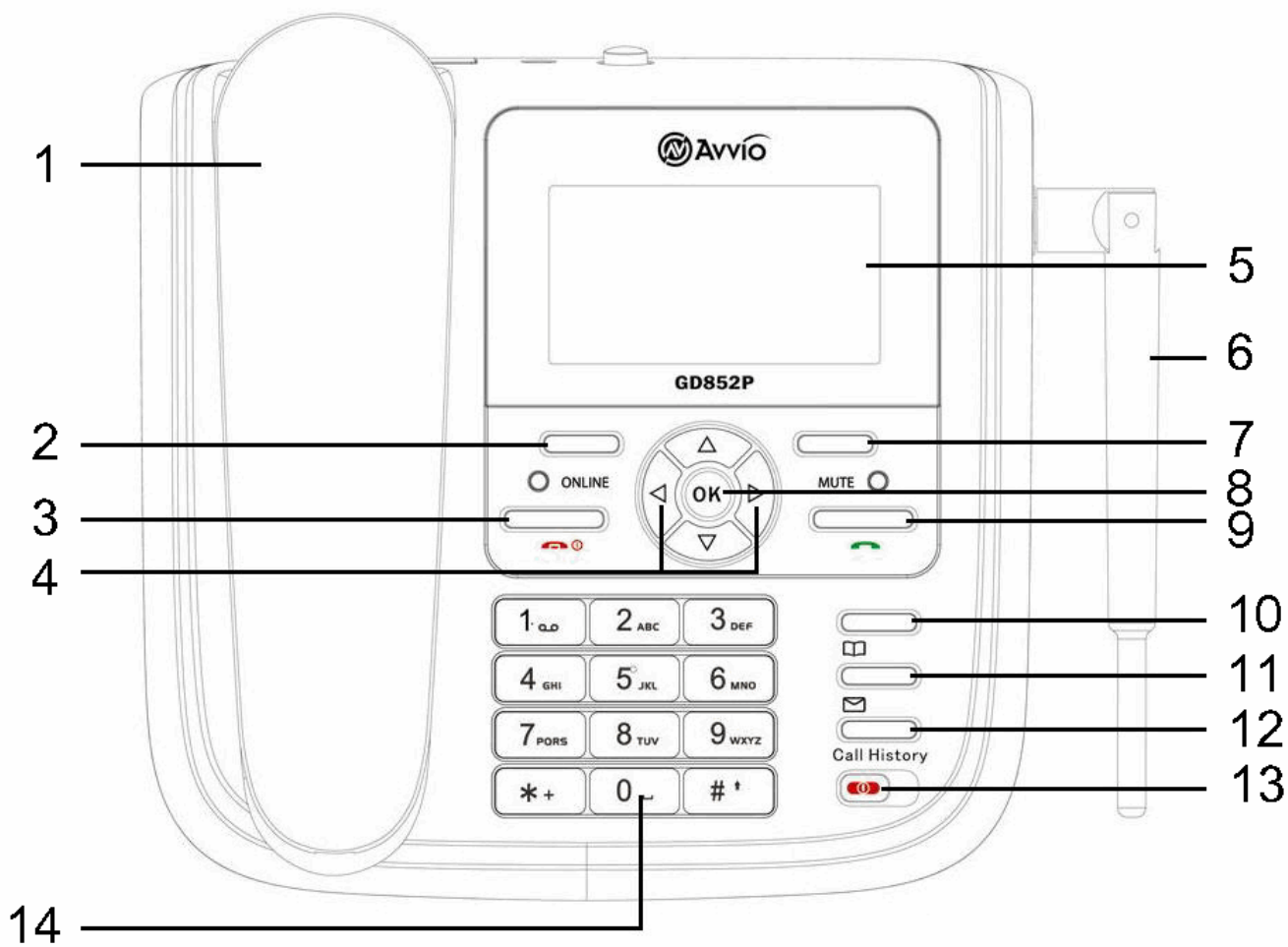

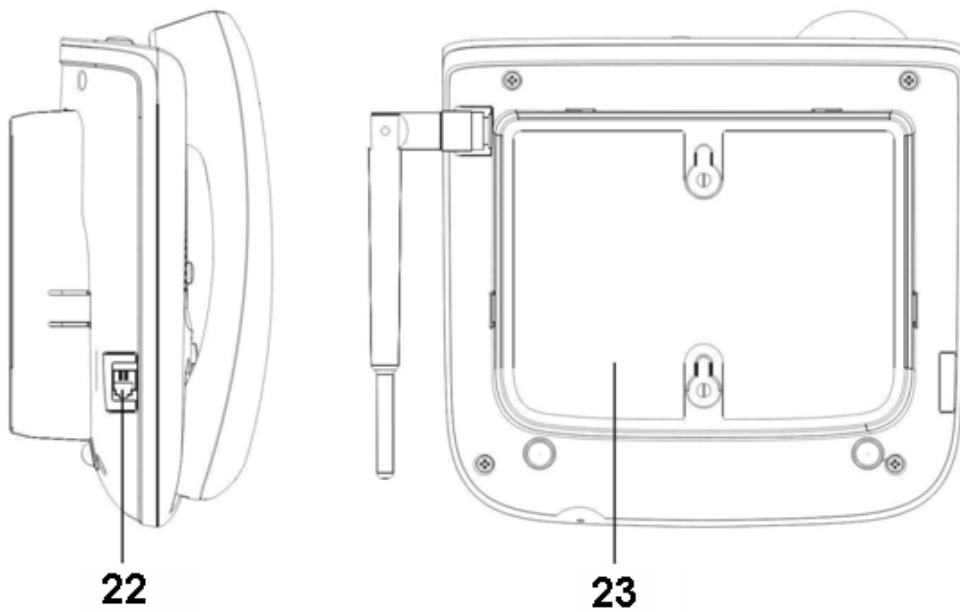
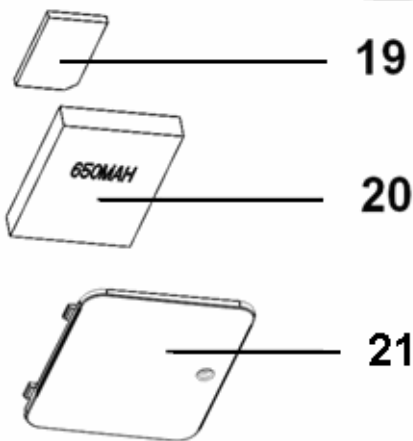
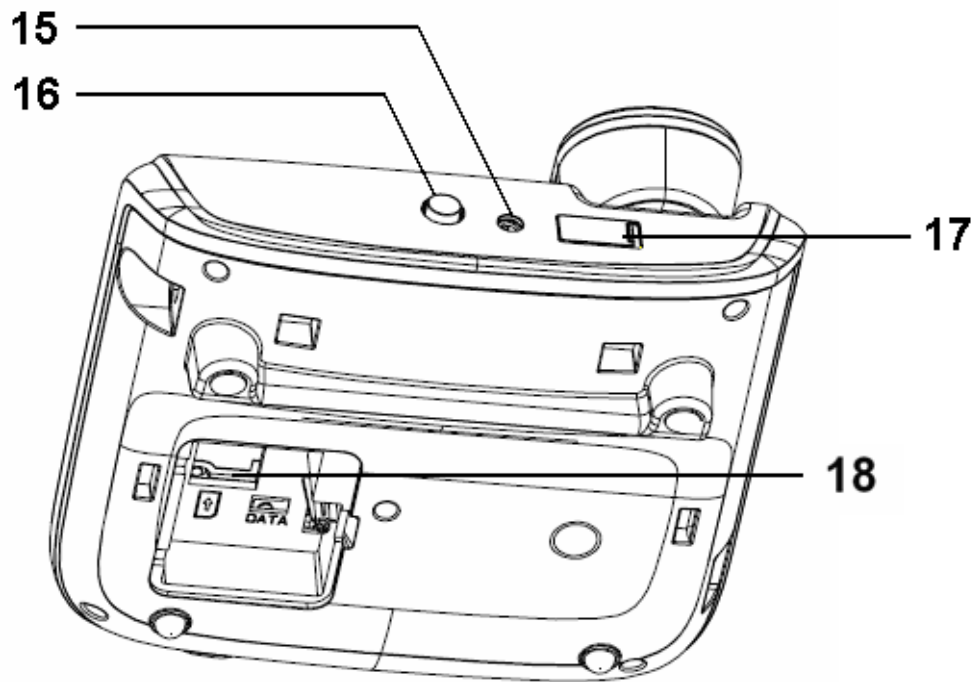

1	Handset	
2	Left Soft key	<ul style="list-style-type: none"> <li>• Enter the Menu in idle</li> <li>• Execute the function shown at the bottom left of the display</li> </ul>
3	End key	<ul style="list-style-type: none"> <li>• Press and hold to power the phone on when the phone is off</li> <li>• Press and hold to power the phone off when the phone is in idle</li> <li>• End or reject a call</li> <li>• Return to idle display</li> </ul>
4	Arrow key	<ul style="list-style-type: none"> <li>• Move the cursor</li> <li>• Press Up/Down arrow key to decrease/increase the earpiece and ring volume</li> </ul>
5	Display	
6	Dual Band ANT	
7	Right Soft key	<ul style="list-style-type: none"> <li>• Enter Name in idle</li> <li>• Execute the function shown at the bottom right of the display</li> </ul>
8	Mute key	<ul style="list-style-type: none"> <li>• To muffle the sound of microphone.</li> </ul>
9	Send key	<ul style="list-style-type: none"> <li>• Make or answer a call</li> <li>• List the dialed calls in idle</li> </ul>
10	Shortcut key for Contacts	<ul style="list-style-type: none"> <li>• Enter the Contacts in idle</li> </ul>
11	Shortcut key for SMS	<ul style="list-style-type: none"> <li>• Enter the Message in idle</li> </ul>
12	Shortcut key for Call History	<ul style="list-style-type: none"> <li>• Enter the Call History in idle</li> </ul>
13	Handfree key	
14	Dial button (Numeric key)	<ul style="list-style-type: none"> <li>• Enter phone numbers, characters or select the function</li> </ul>
15	Charger connector	
16	Power key	<ul style="list-style-type: none"> <li>• Shut off the power supply</li> </ul>
17	USB interface	
18	SIM card slot	
19	SIM card	
20	Battery	
21	Battery cover	
22	Jack for handset	
23	Base	

## 2.3 Idle mode display

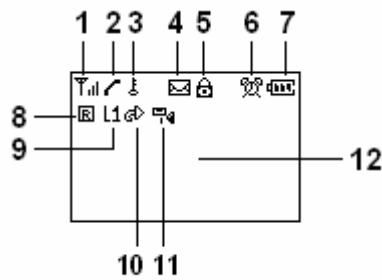

This picture shows icons in the display.

Icon	Descriptions
1.	Indicates signal strength level and more bars means better signal
2.	Indicates the phone is in the connecting or connected status
3.	Indicates the keypad is locked
4.	Indicates you have unread messages
5.	Fixed dial is set on
6.	Indicates the alarm is set on
7.	Indicates battery power
8.	Roam
9.	Indicates communication line
10.	Indicates call divert
11.	Indicates you have new voice messages in No.1 line/No.2 line/No.1 and No.2 line
12.	Display date and time, Owner number and so on

## 2.4 Technical specifications

Battery	Li-Ion battery 3.7v 650MAH
Charger	Input: 100 - 240V ~ 50/60Hz 200mA Output: DC +5V/400mA
Dimensions	185 x 218 x 88 (mm)
Weight	637 g
Standby time*	About 200 hours
Talk time*	156 - 260 minutes

\* The idle time and call time depend on the network.

## 2.5 SIM card & battery

- Keep all SIM cards out of the reach of small children.
- The SIM card and its contacts can be easily damaged by scratches or bending, so be careful while handling, inserting or removing the card.



- 
- Power off the phone before installing or removing the SIM card to prevent damage to the phone.

**Notice:** You can only use the authorized SIM card. If there is anything you doubt, please contact the local seller.

### 2.5.1 Installing SIM card & battery

1. Place the SIM card into the slot with the metal contact facing down.
2. Attach the battery.
3. Push the battery cover upwards until it clicks into place.

### 2.5.2 Removing SIM card & battery

1. Power off the phone.
2. Push the battery cover latch upwards.
3. Remove the battery.
4. Slide the SIM card.

## 2.6 Charging the battery

1. Plug the connector of the charger into the jack at the top of the phone, and plug the charger into a standard AC wall outlet. During charging, the battery icon is flashing.

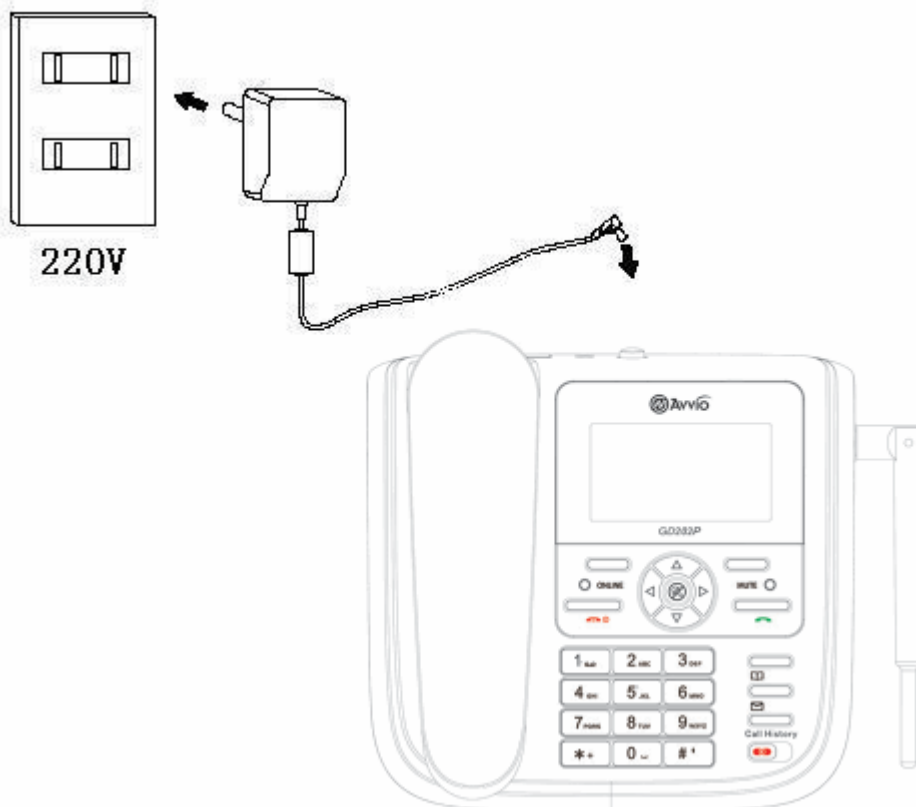

2. When charging is completed, the battery icon stops flashing.  
Charging..... Fully Charged

**Notice:**

- When  is shown in the screen, it indicates that there is not enough power, please charge the phone.
- You must fully charge the battery before using the phone for the first time. It is recommended you charge the battery for four hours for the first time.
- If the phone is turned on during charging, you can still make or answer calls, but this will consume battery power, thus extend the charging time of the phone.
- It is recommended you charge the battery when it runs out to enhance the battery life.

## 2.7 Power the phone on/off

To power the phone on, press and hold **End key** when it is off.

- If phone lock is set on, you are required to enter the password. The phone password is preset to “1122” at the factory. See “5.5.4 Security Setup”.
- If SIM lock is set on, you are required to enter the PIN. See “5.5.4 Security Setup”. If you enter wrong PIN three times in a row, you need the PUK to unlock it. PIN and PUK are both provided by the network operator.

To power the phone off, press and hold **End key** when it is in idle.

## 2.8 Idle mode operations

In idle

- Press **Left soft key (Menu)** to enter the **Main Menu**. Press **Up/Down keys** to select the desired one and press **Left soft key (Select)** to enter.
- Press **Right soft key (Name)** to enter the **Contacts list**.
- Press **Messages** to enter Messages.

## 3. Basic Operations

### 3.1 Making a call

You can make or receive calls within the service area and with sufficient signal strength.

**Notice:** The signal strength affects the quality of your call.

#### 3.1.1 Making a call from idle

##### 1. Making a call in the normal way

Pick up the handset or press the **Handfree key**, the “online” indicator turns on. Enter the phone numbers you want to call, it will be dialed automatically if no number is

---

entered after the time you set. Press the **End key** or put down the handset or press the **Handfree key** to cancel the dialing operation and return to idle.

2 Making a call beforehand

- Enter the number in idle and pick up the handset or press the **Handfree key** or press the **Send key**. The number is dialed.
  - When enter the number, press **Right soft key** (clear) to erase the number, press **Left soft key** (save) to save it to the phonebook, and press **End key** return to idle.
- 3 No matter whether the handset is picked up or the **Handfree key** is pressed, press **Send key** in idle to enter the dialed call list.

When the number is dialed, put down the handset or press the **Handfree key** or press the **End key** to cancel the dialing operation.

### 3.1.2 Inserting a pause sign when dialing

You can use the pause sign to dial an extension number automatically or manually.

#### In an automatic way

1. Enter the phone number.
2. Press **\* key** continuously three times to insert a "P".
3. Enter the extension number.
4. Dial the number before "P". After the line is connected, the phone will dial the number after "P" automatically.

**Notice:** The suspending time depends on the number of the "P" you entered.

#### In a manual way

1. Enter the phone number.
2. Press **\* key** continuously four times to insert a "W".
3. Enter the extension number.
4. Dial the number before "W". After the line is connected, the phone will ask you whether to dial the number after "W".

### 3.1.3 Speed dialing

After you have activated the Speed Dial function and assigned the phone number to the relevant numeric key, you can press and hold the key to call the number quickly in idle.

### 3.1.4 Redialing

In idle you can press the **Redial key** dial the last call.

## 3.2 Answering/rejecting a call

When there is an incoming call:

1. Pick up the handset or press the **Handfree key** or press the **Send key** to answer a call. If the handset has been picked up or the **Handfree key** has been pressed, you can just press the **Send key** to answer the call.
2. Press **End key** or **Right soft key** (Reject) to reject it.

---

### 3.3 Missed calls

The missed calls are displayed in the display. Press **Left soft key** (Read) to enter missed calls list to check.

### 3.4 During a call

#### 3.4.1 Muting a call

You can mute the call during the conversation, and then the other party would not hear your voice.

1. During the call press **Mute key** to mute the call.
2. To unmute the call, press **Mute key** again.

#### 3.4.2 Handsfree earpiece

1. Press **Handsfree key** to activate handsfree earpiece.
2. To deactivate handsfree earpiece, press the key again.

#### 3.4.3 Adjusting earpiece volume

During a call press **Up arrow key** or **Down arrow key** to adjust earpiece volume.

On the input screen during a call, press and hold the up or down key to display the volume adjustment screen, and then press these two keys to adjust the volume.

#### 3.4.4 Searching for a number from the Contacts

During a call, press **Left soft key** (Option) and select **Contacts**.

#### 3.4.5 DTMF









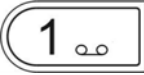

When DTMF is turned off, the entered numbers will not be responded as DTMF signals during a call.

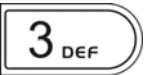
1. During the call press **Left soft key** (Option) and select **DTMF**. Press **Left soft key** (Off) to deactivate DTMF.
2. To activate DTMF, select **DTMF** and press **Left soft key** (On) in the Option display.

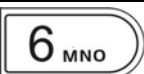
## 4. Entering text

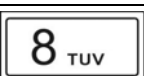
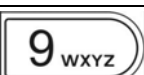
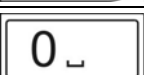
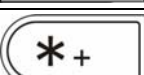
The phone provides several input methods including ABC input, abc input, 123 input. Press **# key** to switch input methods.

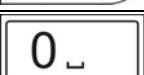
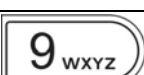
## 4.1 Keypad mapping

Input method	key	Characters or functions
abc/ABC		Display frequently used symbols
		a/b/c/2 (A/B/C/2)
		d/e/f/3 (D/E/F/3)
		g/h/i/4 (G/H/I/4)
		j/k/l/5 (J/K/L/5)
		m/n/o/6 (M/N/O/6)
		p/q/r/s/7 (P/Q/R/S/7)
		t/u/v/8 (T/U/V/8)
		w/x/y/z/9 (W/X/Y/Z/9)
		space, 0
		Display symbols
		Switch input methods
	123	 
		Display symbols
		Switch input methods

## 4.2 ABC/abc input

1. Press **# key** to switch to abc/ABC input.
2. Press the numeric key. For example, press **2 key** three times for “c/C”.
3. Press **Left soft key** (Select) to save and exit.

---

## 4.3 123 input

1. Press **# key** to switch to 123 input. Press the numeric key directly to enter the number.

## 4.4 Entering symbols

1. Press **\* key** to display symbols. Press **Arrow keys** for the desired one and press **Left soft key** (Select). Press **Right soft key** (Back) to exit the symbol display.
2. In abc/ABC input method, press **1 key** repeatedly for the frequently used symbols.

## 5. The menus

### 5.1 Menu Tree

Main menu	Sub-menu	Sub-menu	Sub-menu
1 Contacts	1 Search Entry		
	2 Add New Entry		
	3 Delete All		
	4 Copy All		
	5 Owner Number		
	6 Speed Dial		
	7 Memory Status		
2 Messages	1 Write Message		
	2 Inbox		
	3 Outbox		
	4 Template		
	5 Message Settings	1 Profile Setting	
		2 Common Setting	
		3 Memory	
	6 Voice Mail		
3 Call History	1 Missed		
	2 Dialed		
	3 Received		
	4 Delete Log		
	5 Call Time		
4 Settings	1 Phone Setup	1 Customize	1 Tone Setup
			2 Volume
			3 Ring Type
			4 Extra Tone
			5 LCD Backlight

		2 Time and Date	
		3 Input Method	
		4 Display	
		5 Contrast	
		6 Greeting	
	2 Call Setup	1 Caller ID	
		2 Call Waiting	
		3 Call Divert	
		4 Call Barring	
		5 Line Switching	
		6 Call Time Reminder	
		7 Auto Dial Time	
	3 Network Setup	1 Network Selection	1 New Search
			2 Select Network
			3 Selection Mode
	4 Security Setup	1 SIM Lock	
		2 Phone Lock	
		3 Auto Keypad Lock	
		4 Fixed Dial	
		5 Change Password	
	5 Restore Factory Settings		
5 Games	1 Puzzle	1 Start Game	
		2 Game Level	
		3 Best Grades	
		4 Game Help	
	2 Memory	1 Start Game	
		2 Game Level	
		3 Bingo Ratio	
		4 Game Help	
6 Organizer	1 To Do List		
	2 Alarm		
	3 Calculator		
7 Services			

## 5.2 Contacts

You can store names and phone numbers in the memory of the phone or SIM card.

- Phone memory stores up to 100 entries.
- The storage of SIM card memory depends on its type. To check your sim card memory please check with your telecom operator.
- In idle, press **Name** to enter Contacts list. The storage location of entries is indicated by different icons.

---

### 5.2.1 Search Entry

1. Select Menu→Contacts.
2. Select **Search Entry** and press **Left soft key** (Select).
3. Enter characters (up to 5 characters), the phone lists matched entries. Press **Right soft key** (Clear) to erase the characters entered and press **# key** to switch the input methods.

#### Notice:

- As characters entered, the entries matched are listed accordingly.
- You cannot find the entries which name is empty.

### 5.2.2 Add New Entry

If the handset has not been picked up or the **Handfree key** has not been pressed, you can enter phone numbers in idle and press **Left soft key** (Save). Select **To Phone** or **To SIM** to store it.

Or

1. Select Menu→Contacts.
2. Select **Add New Entry** and press **Left soft key** (Select).
3. Select **To Phone** or **To SIM**, then press **Left soft key** (Select).
4. Select **Name** and press **Left soft key** (Edit). Enter the name and press **Left soft key** (OK).
5. Select **Number** and press **Left soft key** (Edit). Enter the number and press **Left soft key** (OK).
6. Press **Left soft key** (Yes) to save.

### 5.2.3 View

1. In Contacts list select the entry you want to view.
2. Press **Left soft key** (Option) and select **View**.
3. Press **Left soft key** (Select) to view.

### 5.2.4 Edit

1. In Contacts list select the entry you want to edit.
2. Press **Left soft key** (Option) and select **Edit**, then press **Left soft key** (Select).
4. Press **Right soft key** (Done) to save.

### 5.2.5 Delete

There are two ways to delete entries.

1. In Contacts list
  - Select the entry you want to delete, press **Left soft key** (Option) and select **Delete**. Press **Left soft key** (Select).



- 
- The message “Delete?” appears in the display.
  - Press **Left soft key** (Yes) to confirm and press **Right soft key** (No) to cancel the message.
2. Select Menu→Contacts. Select **Delete All** and press **Left soft key** (Select).
    - **From SIM:** Delete all entries stored in the SIM card memory.
    - **From Phone:** Delete all entries stored in the phone memory.

### 5.2.6 Copy

There are two ways to copy entries between the phone and the SIM card memory

1. In Contacts list
  - Select the entry you want to copy, press **Left soft key** (Option) and select **Copy**. Press **Left soft key** (Select).
  - The message “Copy?” appears in the display.
  - Press **Left soft key** (Yes) to confirm and press **Right soft key** (No) to cancel the message.
2. Select Menu→Contacts. Select **Copy All** and press **Left soft key** (Select).
  - **From SIM:** Copy all entries stored in the SIM card to the phone memory.
  - **From Phone:** Copy all entries stored in the phone memory to the SIM card.

### 5.2.7 Move

Move entries between the phone and the SIM card memory.

1. In Contacts list, select the entry you want to move, press **Left soft key** (Option) and select **Move**. Press **Left soft key** (Select).
2. The message “Move?” appears in the display.
3. Press **Left soft key** (Yes) to confirm and press **Right soft key** (No) to cancel the message.

### 5.2.8 Delete All

1. Select Menu→Contacts→Delete All.
2. You can select delete **From SIM** or **From Phone**.

### 5.2.9 Copy All

1. Select Menu→Contacts→Copy All.
2. You can select copy **From SIM** or **From Phone**.

### 5.2.10 Owner Number

Set the own number for the different lines. After the own number is set and Show Owner Number function (see 5.5.1.5 Display: Show Owner Number) is activated, the number is

---

shown in the idle display.

1. Select one and press **Left soft key** (Option).
  - **Edit:** Edit the name and number.
  - **Erase:** Erase the selected number.

### 5.2.11 Speed dialing

After you have activated the Speed Dial function and assigned the phone number to the relevant numeric key, you can press and hold the key to call the number quickly in idle.

### 5.2.12 Memory Status

Select Menu→Contacts→Memory Status. The memory status of the SIM card and phone memory is shown in the display.

## 5.3 Messages

You can store up to 50 messages in the phone and SIM card memory. The SMS memory in Phone varies with the capacity of SIM card.

### 5.3.1 Write Message

1. Select Menu→Messages→Write Message.
2. Write down the message you want. Press **Left soft key** (Option) for the following options.
  - **Done:** Complete editing and enter the Send Option display.
  - **Template:** Enter template to select one.
3. In the Send Option display, there are for the following options:
  - **Send Only:** You can enter recipient's phone number directly or press **Left soft key** (Search) to select one entry from the Contacts. Press **Left soft key** (OK) to send the message.
  - **Save and Send:** You can enter recipient's phone number directly or press **Left soft key** (Search) to select one entry from the Contacts. Press **Left soft key** (OK) to send the message. After the message is sent, it will be saved to Outbox.
  - **Save:** Save the message to Outbox.
  - **Send To Many:** You can send up to 10 recipients at one time.

### 5.3.2 Inbox

1. Select Menu→Messages→Inbox. The messages you have read and unread are listed here.
  - Indicates the message is unread.
  - Indicates the message is read.
2. When view a detailed message, press **Left soft key** (Option) for the following options:
  - **Reply:** Reply to the message.
  - **Forward:** Forward the message to other person.

- 
- **Edit:** Edit the message.
  - **Delete:** Delete the message.
  - **Delete All:** Delete all messages in Inbox.
  - **Use Number:** List the number of the sender as well as contained in the message for you to dial or store to the Contacts.

### 5.3.3 Outbox

1. Select Menu→Messages→Outbox. Messages sent successfully are listed here. Press **Left soft key** (Select) to read the selected message.
2. When view a detailed message, press **Left soft key** (Option) for the following options:
  - **Send:** Send the message again or others.
  - **Edit:** Edit the message.
  - **Delete:** Delete the selected message.
  - **Delete All:** Delete all messages in Outbox.
  - **Use Number:** List the number of the recipient as well as contained in the message for you to dial or store to the Contacts.

### 5.3.4 Template

The phone has preset 10 templates for you to use when write the message. These templates can be modified

1. Select Menu→Messages→Template.
2. Select a template, press **Left soft key** (Option) for the following options:
  - **Edit:** Edit the selected template.
  - **Erase:** Clear the contents of the selected template.

### 5.3.5 Message Settings

Select Menu→Messages→Message Settings.

#### Profile Setting

- Edit the number of the message service center. With the SIM card inserted, the phone automatically searches for the number. You need to make sure the number is correct before sending and receiving the message.
- Select the period for the message saved. It is the time the service center's attempt to send the message. Please contact the network operator for more information.
- Select the format of the message to be sent. Please contact the network operator for more information.

#### Common Setting

- **Delivery Report:** Get the delivery report when the message is successfully delivered to the recipient.
- **Reply Path:** Whether to use the service center which send the message to reply.

#### Memory

- Check the message memory status of the SIM and the phone.

---

## 5.3.6 Voice Mail

Select Menu→Messages→Voice Mail. Set the voice mail numbers. When connecting, you can call and listen to the voice mail.

**Notice:** If you have set the voice mail number, press and hold **1 key** in idle to dial the corresponding number.

## 5.4 Call History

### 5.4.1 Missed /Dialed /Received

The phone registers the phone numbers of missed, dialed and received calls (up to 20 records each).

Below takes Missed Calls for example.

1. Select Menu→Call History.
2. Select “Missed”, press **Left soft key** (Select) to view the selected record.
3. Press **Left soft key** (Option) for the following options:
  - **Delete:** Delete the record.
  - **Save:** Save the phone number to Contacts.

### 5.4.2 Delete Log

Select Menu→Calls History→Delete Log. You can choose to delete records of missed calls, dialed calls or received calls respectively or delete them at one time.

### 5.4.3 Call Time

Select Menu→Calls History→Call Time. You can view last call time, total sent time, total received time and reset all time.

## 5.5 Settings

### 5.5.1 Phone Setup

#### 5.5.1.1 Customize

1. **Tone Setup**
  - **Incoming Call:** The phone has 25 preset rings. Press **Up/Down arrow keys** to select the ring and press **Left soft key** (Select) to save.
  - **Alarm:** Select a ring when alarm time reaches. See “Incoming Call” for detailed operations.
  - **Power On:** Select a ring when the phone is powered on. Press **Up/Down arrow Keys** to select the ring and press **Left soft key** (Select) to save.
  - **Power Off:** Select a ring when the phone is powered off. See “Power On” for detailed operations.

- 
- **Message Tone:** Select a tone when a message has been received. See “Power On” for detailed operations.

- **Keypad Tone:** Select a tone when the key is pressed. The options include Silent, Click and Tone.

## 2. Volume

Set the volume level for ring and key tones. Press **Up/Down arrow keys** to adjust the volume and press **Left soft key** (Select) to save.

## 3. Ring Type

Set the ring type to Single, Repeat, or Ascending. Press **Left soft key** (Select) to save.

## 4. Extra Tone

Press **Left soft key** (On / Off) to tick it and press **Right soft key** (Done) to save.

## 5. LCD Backlight

1. Select Shortcut key for Contacts → enter master PIN→Settings→Phone Setup→Customize→LCD Backlight.
2. Press **Up/Down arrow keys** to select LCD Backlight.
3. Press **Left soft key** to save.

### 5.5.1.2 Time and Date

1. Select Menu→Settings→Phone Setup→Time and Date.
2. Set the home city, time/date and the format.
3. Press **Left soft key** to save.

### 5.5.1.3 Display

Select Menu→Settings→Phone Setup→Display.

- **Off:** Hide date, time and owner number in idle display.
- **Show Date and Time:** Show date and time in idle display.
- **Show Owner Number:** Show the own number in idle display. To show the number, you should first store the own number in the Contacts.

### 5.5.1.4 Contrast

1. Select Menu→Settings→Phone Setup→Contrast.
2. Press **Left/Right arrow keys** to adjust the contrast
3. Press **Left soft key** to save.

### 5.5.1.5 Greeting

Select Menu→Settings→Phone Setup→Greeting.

If you edit the text and activate the function, the text is shown in the display each time you power the phone on.

Set the status on or off. Enter the greeting texts. Press **Right soft key** (Done) to save.

---

## 5.5.2 Call Setup

### 5.5.2.1 Caller ID

Select Menu→Settings→Call Setup→Caller ID. Decide whether to send the phone number to the person you are calling. This needs to be supported by the network.

- **Set by Network:** Send or hide the phone number depending on the network.
- **Hide Id:** Hide the phone number to the person you are calling. You may fail to make a call with this function in some areas. Please contact the network operator for more information.
- **Send Id:** Send the phone number to the person you are calling.

Select the desired one and press **Left soft key** (Select) to save.

### 5.5.2.2 Call Waiting

Select Menu→Settings→Call Setup→Call Waiting.

This function allows you to put the current call on hold and then make or answer a second one. You can switch between calls.

### 5.5.2.3 Call Divert

Select Menu→Settings→Call Setup→Call Divert.

With this function you can divert the incoming calls to a specified number.

- **Divert All Voice Calls:** Divert all voice incoming calls.
- **Divert If Unreachable:** Divert incoming calls when the phone is outside the network service area.
- **Divert If No Answer:** Divert incoming calls when they are not answered.
- **Divert If Busy:** Divert incoming calls when the phone is busy.
- **Divert All Data Calls:** Divert all data incoming calls.
- **Cancel All Divert:** Cancel all divert calls.

Press **Left soft key** (Select) when done.

### 5.5.2.4 Call Barring

Select Menu→Settings→Call Setup→Call Barring.

Call barring is a network-dependant service. Please contact your network operator for more information.

- **Outgoing Calls**

**All Calls:** Bar all outgoing calls except the emergency call.

**International Calls:** Bar outgoing international calls.

**International Except Home:** Bar outgoing international calls except calls to the home country.

- **Incoming Calls**

**All Calls:** Bar all incoming calls.

**When Roaming:** Bar incoming calls when roaming.

Press **Left soft key** (Select) to save.

- 
- **Cancel All**

Cancel all setup. You must input the password at first.

- **Change Barring PW**

You are required to enter the old password before changing it.

#### 5.5.2.5 Line Switching

Select Menu→Settings→Call Setup→Line Switching. Select to use Line 1 or Line 2.

Press **Left soft key** (Select) to save.

#### 5.5.2.6 Call Time Reminder

Select Menu→Settings→Call Setup→Call Time Reminder.

- **Off:** Deactivate the reminder.
- **Single:** Remind you only once during the period you set.
- **Periodic:** Remind you XX seconds per minute during the period you set.

Press **Left soft key** (Select) to save.

#### 5.5.2.7 Auto Dial Time

Select Menu→Settings→Call Setup→Auto Dial Time. The default can be modified.

When you make a call in the normal way, you can enter the number and it will be dialed automatically if none is entered within the time you set.

### 5.5.3 Network Setup

The phone should access the network before making and receiving calls.

#### 5.5.3.1 Network Selection

Select Menu→Settings→Network Setup→Network Selection.

- **New Search:** Search a new Network again.
- **Select Network:** You can select a Network you want.
- **Selection Mode:** Select a mode you want.

### 5.5.4 Security Setup

Select Menu→Settings→Security Setup.

#### 5.5.4.1 SIM Lock

Select Menu→Settings→Security Setup→SIM Lock. You are required to enter the PIN before changing its status.

With this function activated, the phone asks for a PIN each time you power the phone on.

If the PIN is entered incorrectly three times in a row, you need to unblock it using the PUK.

The PIN and PUK are provided by the network operator.

**Notice:** The phone supports Auto SIM PIN. If this function is available, the SIM PIN will be

---

changed automatically when the phone is powered on. Please contact with the local seller for details.

#### **5.5.4.2 Phone Lock**

Phone lock protects the phone from being unauthorized use. With this function activated, you need the password of the phone to unlock it.

You are required to enter the password before changing its status. The preset password is "1234".

Select Menu→Settings→Security Setup→Phone Lock. Enter the password and press **Left soft key** (Ok).

#### **5.5.4.3 Auto Keypad Lock**

Select Menu→Settings→Security Setup→Auto Keypad Lock. Select the time for the auto keylock and press **Left soft key** (Select).

When the keypad is locked on, press any key and then input the phone's password.

#### **5.5.4.4 Fixed Dial**

If the SIM card supports fixed dial function, you can set limitations on the numbers you can call. PIN2 is required to activate it.

Select Menu→Settings→Security Setup→Fixed Dial. You can activate or deactivate the fixed dial. PIN2 is required to change the mode. Press **Left soft key** (OK) to save.

#### **Notice:**

- The amount of the fixed dial you can set depends on the type of the SIM card.
- Emergency call is allowed with this function activated.

#### **5.5.4.5 Change Password**

You can change the PIN, PIN2 and the phone password. Select Menu→Settings→Security Setup→Change Password.

You need to activate the SIM Lock before changing the PIN. First enter the old PIN to verify then enter the new PIN.

When change the password, you need to enter the new password and enter it again to confirm it.

The password should be 4~8 digits from 0 to 9. Press **Left soft key** (Select) when done.

**Notice:** You cannot change the SIM PIN when Auto SIM PIN is available, because the SIM PIN will be changed automatically to one not known to the User. Please contact with the local seller for details.

### **5.5.5 Restore Factory Settings**

Reset some settings to factory default.

Select Menu→Settings→Restore Factory Settings.

**Notice:** The phone's password is also required when restore to the factory settings. The



---

preset password is “1234”. If you forget your password, please contact the local service provider’s service center.

## 5.6 Games

The phone comes with two games: memory and puzzle. Before starting the game, you can view the game rules.

## 5.7 Organizer

### 5.7.1 To Do List

This function allows you to keep a list of up to 3 tasks that you need to do.

1. Select Menu→Organizer→To Do List.
2. In the task list, press **Left soft key** (Option) for the following options:
  - **View:**View the task.
  - **Add:** Add a new task. Enter date, time, note and so on. Press **Right soft key** (Done) to save.
  - **Edit Task:** Edit the selected task.
  - **Delete Task:** Delete the selected task.
  - **Delete All:** Delete all tasks.

When the alarm is set on and the alarm time reaches, the phone rings. You can press **Left soft key** (Select) to turn off the alarm.

### 5.7.2 Alarm

Set up to 5 alarm clocks.

1. Select Menu→Organizer→Alarm.
2. Select one alarm and press **Left soft key** (Edit).
3. Set the alarm off/ on, the alarm time.
4. Press **Right soft key** (Done) to save.

**Notice:** When the alarm time reaches, the phone reminds you even when it is powered off.

When the alarm time reaches, the phone rings.

- Press **Left soft key** (Stop) to turn off the alarm.
- Press **Right soft key** (Snooze) to turn off the alarm temporarily. It reminds you again about 4 minutes later. If you do not handle the alarm, it by default reminds you again about 4 minutes later.

### 5.7.3 Calculator

The calculated numbers cannot exceed 8 digits due to accuracy limitation.

1. Select Menu→Organizer→Calculator.
2. Key definitions in the calculator function are shown below.

<b>Left/ Right arrow key</b>	Select the operator
<b># key</b>	Decimal point
<b>Left soft key</b>	Equal, confirm
<b>Right soft key</b>	Erase numbers entered Erase the result and return to the initial state Exit the calculator

## 5.8 Services

Select Menu→Services.

The content of the Services depends on the SIM card. Please contact the operator for detailed information.

## 6. Troubleshooting

<b>Problem</b>	<b>Possible cause</b>	<b>Solution</b>
<b>Unable to power on</b>	● Is the battery power low?	● Please charge the battery.
	● Do you press <b>End key</b> long enough?	● Please press and hold <b>End key</b> for 2 seconds or longer.
	● Is the battery switch on?	● Please switch on the battery.
<b>Unable to make a call</b>	● Is the phone outside of the service area?	● Move to a place where signal can be received strongly.
	● Is the number you dial correct?	● Check the number and dial again.
<b>Communication interrupted suddenly</b>	● Is the phone outside of the service area?	● Move to a place where signal can be received strongly.
	● Are you moving in high speed during conversation?	● The signal will interrupt when the phone switch between 2 cell station. Please move in low speed.
<b>Insert the SIM card</b>	● Do you insert the SIM card correctly?	● Please insert the SIM card correctly.
	● Is the SIM card connector dirty?	● Please clean the SIM card.
	● Is the SIM card damaged?	● Please check the SIM card and return it to the service provider.
	● Is the charger plugged to the phone correctly?	● Please plug the charger to the phone correctly.
	● Is the connection OK?	● Please check the connection.

	<ul style="list-style-type: none"><li>● Is the battery old?</li></ul>	<ul style="list-style-type: none"><li>● Contact the seller to replace the phone with a new battery.</li></ul>
--	---	---