

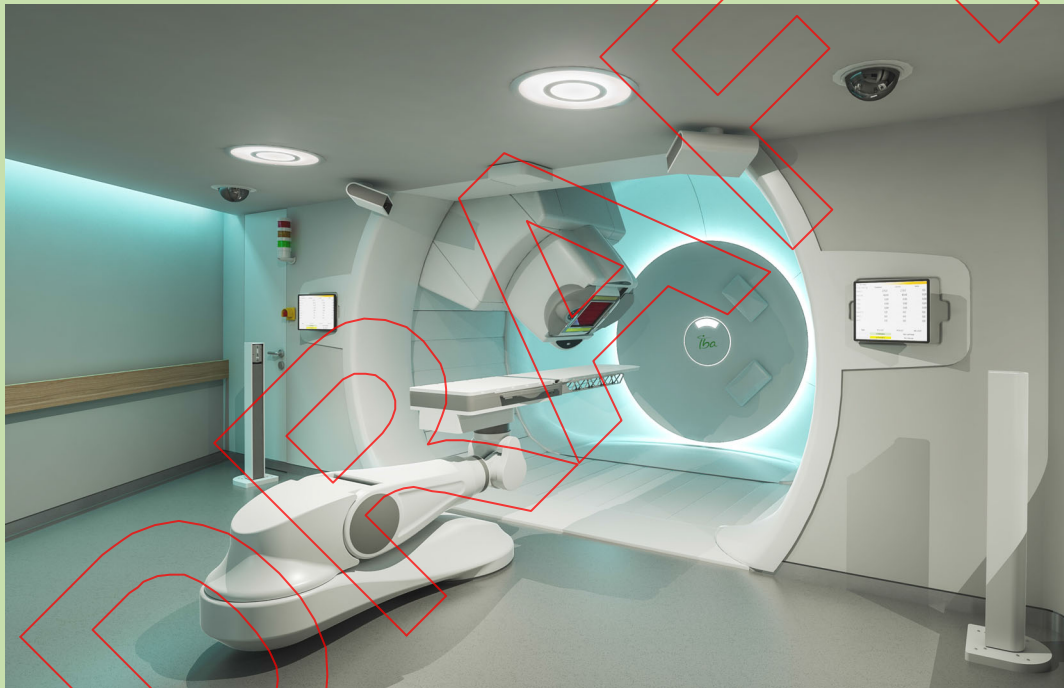

Proton Therapy System

Clinical User's Guide
Inova Schar Cancer Institute, Falls Church



Document 82358 A - September 2019

Volume
Treatment Session



DRAFT

Copyright Notice

© 2019 Ion Beam Applications S.A. All rights reserved.

All product and company names are the trademarks or registered trademarks of their respective owners.

This document contains proprietary information that is protected by copyright. All rights reserved. No part of this document may be reproduced, translated, or transmitted without prior and express written permission of Ion Beam Applications S.A.

Abstract

The *Proton Therapy System Clinical User's Guide* contains one volume and provides reference information and instructions for using the IBA Proton Therapy System (PTS) - Proteus 235 (brand name: Proteus PLUS) from a Clinical point of view.

The *Clinical User's Guide* deals specifically with routine operations in the Treatment Rooms (TRs) and Treatment Control Rooms (TCRs).

WARNING



The Safety and Emergency Recommendations Document shall be read and understood by any personnel operating, testing, maintaining or repairing the system.

Technical Support

If you cannot find the information you require in this manual, please contact your Site Manager, Site Technical Leader, or Operations Manager.

Alternatively, you can call the IBA main switch board at +32 10 47 58 11.

Notice

The information contained in this document has been checked for agreement with the hardware and/or software described.

Users of the IBA Proton Therapy System must receive adequate training on safe and effective use of the equipment and software before attempting to work with it. Training requirements may vary from country to country. Users must make sure that training is received in accordance with local laws or regulations that have the force of law.

Only appropriately qualified personnel may operate the equipment or work in its vicinity. Qualified personnel are persons familiar with the installation, assembly, startup, operation, and maintenance of this product, and who possess the relevant qualifications for their work in accordance with current standards in safety technology.

CAUTION	United States Federal law restricts this device to sale by or on the order of a physician.
	

Intended Use

The Proteus PLUS is a medical device designed to produce and deliver a proton beam for the treatment of patients with localized tumors and other conditions susceptible to treatment by radiation.

The PTS may include a Fixed Small Beam Treatment Room dedicated to treatment of patients with localized tumors and other conditions susceptible to treatment by radiation localized in the head and neck.

Indications for Use

The Proteus PLUS is indicated, according to published data, for the following indications:

- Pediatric tumors
 - Medulloblastoma
 - Ependymoma, craniopharyngioma
 - Rhabdomyosarcoma
 - Central Nervous System (CNS) germ cell tumor
 - Atypical teratoid rhabdoid
 - Glioma
 - Skull base chordoma and chondrosarcoma
 - Soft tissue sarcoma, osteosarcoma, Ewing's sarcoma
 - Lymphoma (Hodgkin and non-Hodgkin)
- Ocular tumors

- Skull base and spine chordoma and chondrosarcoma
- Primary liver cancer – HepatoCellular Carcinoma
- Lymphoma
 - Hodgkin lymphoma
 - Non-Hodgkin lymphoma
- Brain tumors
 - Meningioma
 - Pituitary adenoma
 - Acoustic Neuroma
 - Arteriovenous Malformation
 - Glioma
 - Medulloblastoma
- Head and Neck tumors
 - Paranasal sinus and nasal cavity tumors
 - NasoPharyngeal Carcinoma (NPC)
 - Oropharyngeal cancer
 - Hypopharyngeal cancer
 - Laryngeal cancer
- Lung cancer
 - Early stage Non-Small-Cell Lung Carcinoma (NSCLC)
 - Locally advanced NSCLC
 - Reirradiation
 - Post-Operative Radiotherapy
- Gastrointestinal malignancies
 - Pancreatic cancer
 - Esophageal cancer
- Breast cancer
- Prostate cancer

Contra-indications and Precautions

There have been numerous reports published indicating that radiotherapy increased risks of both acute and late toxicities in cancer patients with Collagen Vascular Diseases (CVDs).^{1,2,3,4,5}

Most clinicians would likely consider CVDs such as systemic lupus erythematosus, dermatomyositis, scleroderma, rheumatic arthritis and mixed connective tissue disease absolute or relative contraindications to radiotherapy.⁶ Although there are also studies suggesting that the increased risk in toxicity was not statistically significant^{7,8,9} the outcomes from cancer patients with CVDs can be varied and therefore great caution should be taken when treating with radiation therapy.

Another contraindication to receiving radiation therapy is the presence of genetic abnormalities in DNA repair enzymes, such as in the case of Ataxia-Telangiectasia and its related polymorphisms. These mutations place patients at higher risk for acute side effects during radiation treatment.¹⁰

Protons, like photons, are an ionizing radiation with a low Linear Energy Transfer (LET). The Relative Biological Effectiveness (RBE) of 1.1 has been adopted in current clinical practice, assuming that protons and photons have similar and predictable effect on both tumor and normal tissues. However, increased experimental and clinical evidences have indicated that RBE can vary.^{11,12,13} RBE variations may lead to the creation of suboptimal proton treatment plans with lower than expected effect in the tumor and higher than expected effect in normal tissue.¹⁴ Extra caution should be taken when applying proton therapy for patients with diseases that are reported as high-risk to photon-based radiotherapy.

Proton therapy is used to treat a wide range of conditions. To mitigate errors in treatment delivery and minimize operating risks, it is imperative to have quality assurance measures in place and follow guidelines and protocols in practice. Proton therapy is subject to the same safety guidelines and requirements in terms of risk management as those existing for photon-based radiotherapy.

When performing the benefit-risk ratio analysis of the therapy the medical professionals need to take caution with the following conditions that may increase the risks:

- Pregnancy
- Active and passive implants and devices
- Combination of Chemotherapy and Immunotherapy that may increase the sensibility to radiation

Proton therapy treatments using Proteus 235 system should only be delivered by radiation oncologists, medical physicists, dosimetrists and other related medical staff who have received adequate proton therapy training. Following the instructions for use, the radiation oncologist performs analysis on the risk/ benefit for the patient before delivering the treatment, taking into account all the side effects and risks resulting from the exposure to ionizing radiation. The radiation oncologist also defines the different volumes and dose constraints that the treatment needs to

achieve. The medical physicist assists the radiation oncologist in the decision making process to identify the best treatment technique and performs all the necessary tasks to assure that the equipment delivers the treatment plan as expected.

The Proteus 235 must be operated according to the information contained in the Clinical User's Guide and the Safety and Emergency Recommendations. Dose prescription shall be done in agreement with international and national guidelines taking into account acceptable dose to be delivered in healthy tissues (e.g. guidelines are published by medical organizations such as NCCN (https://www.nccn.org/professionals/physician_gls/f_guidelines.asp)).

(For references, see *List of Published Literature*.)

Software Updates

Any updates of PTS or Off The Shelf (OTS) software may only be performed by authorized IBA personnel.

DRAFT

Intentionally left blank

DRAFT

Essential Performances

The Essential Performances (EP) applicable to the Proteus PLUS for Pencil Beam Scanning (PBS) are given below.

Terminology

Range: The Range (d_{90}), or open beam range, is defined as the depth along the beam central axis in water to the distal 90% point of the maximum dose value, achieved without Beam Modifying Accessories (Range Compensator, Range Shifter).

Distal fall-off: The Distal Dose Fall-off is defined as the distance (in g/cm^2) in which the dose, measured in water along the beam central axis, decreases from 80 to 20% of the maximum dose value.

Field Size: The Field Size is defined as the distance (in mm) between the 50% points of the maximum dose value, measured along the line perpendicular to the beam central axis, on the isocenter in air.

Spot size (beam sigma): The Beam Sigma is defined as one standard deviation of the fluence distribution along a line orthogonal to the beam axis, on the isocenter in air.

Monitor Units: Monitor Unit is defined as an arbitrary unit in which a quantity is displayed and from which absorbed dose can be calculated.

EP Name	Limit allowed for EP value
Dimensions of the Radiation Field	
Field Size	30.0 cm * 40.0 cm or larger
Depth	Max depth: 32 g/cm^2
Min Range (open beam range, without accessories)	Dedicated Nozzle: $\approx 3.1 \text{ g}/\text{cm}^2$ ("extended minimum range" option) OR 4.1 g/cm^2 (without "extended minimum range" option). Universal Nozzle: $\approx 7.7 \text{ g}/\text{cm}^2$ (PBS)
Irradiation Time/Dose Rate	
Irradiation Time/Dose Rate	2 min for 2 Gy in 1L or faster
Dose Gradient on the Edges of the Radiation Field	
Spot size (sigma)	2.7 to 8.5 mm
Distal Dose Fall-Off	1 mm 20%-80% (on top of monoE beam) or smaller (ICRU)
Reproducibility of 2D (Lateral) Dose Distribution in PBS	
Spot Position Accuracy	1 mm or 10% of beam sigma or smaller

EP Name	Limit allowed for EP value
MU to Dose Accuracy Of Proportionality	1% or smaller
Dose Reproducibility Over Time, Fixed Conditions	0,5% 15 min, 1,0% 1 day, 3,0% 1 week or smaller
Dose Reproducibility vs Gantry Angle	2% or smaller
Delivered MU vs Prescribed MU Error	1% or 0.5 MU or smaller
Spot Shape Size Variation Over Time	10% or 0.5 mm or smaller
Spot Shape Size Variation Over Gantry Angle	10% or 0.5 mm or smaller
Spot Shape Size Variation Over Lateral Position in the Isocenter Plane	10% or 0.5 mm or smaller
Reproducibility of Depth Dose Distribution in PBS	
Range Accuracy for Deepest Layer	1 mm or smaller
Pull-Back Accuracy for Shallower Layers	1 mm or smaller
Gantry Positioning	
Gantry angle accuracy for PBS	0.5 degrees or smaller
Gantry Isocenter Displacement for PBS	1 mm or smaller
Reproducibility of Patient vs Beam Alignment	
Proton vs X-Ray Colinearity	<1mm + 0.25°
X-ray Image Registration accuracy	1mm, 1° or smaller
Gating delays	
Delay from Beam ON request to beam being turned on	250 ms
Delay from Beam OFF request to being being turned off	250 ms

Side Effects

Ionizing radiation can be harmful for living organisms. In the case of Radiation Oncology, ionizing radiation is used to treat patients with localized tumors or other conditions susceptible to treatment by radiation. The benefit/risk of the treatment is evaluated by the Radiation Oncologist who determines the amount of radiation that healthy tissues can safely receive with acceptable side effects. The Radiation Oncologist and the clinical team are to define the best treatment plan (technique and dose) that will allow achieving the best risk (i.e., limitation of the undesirable side effects due to irradiation) / benefit (i.e., eradication of the tumors) ratio.

The following table summarizes the proton radiation treatment side effects published in literature.

(For references, see *List of Published Literature*.)

Pediatric	Adult						
	Eye	CNS and Spine	Head and Neck	Lung	Gastrointestinal	Breast	Prostate
Dry eye ¹⁵	Neovascular glaucoma/rubeosis ²⁸	Nausea vomiting ³³	Dermatitis ⁴⁵	Dermatitis ⁵⁰	Fatigue ⁵⁵	Radiation dermatitis ⁵⁹	Urinary frequency or urgency ⁶³
Otitis ¹⁵	Maculopathy ²⁹	Dermatitis ³³	Mucositis ⁴⁵	Fatigue ⁵⁰	Erythema ⁵⁵	Telangiectasia ⁵⁹	Dysuria ⁶³
Cataract ¹⁵	Secondary glaucoma ³⁰	Hearing loss, Hypoacusis ³³	Nausea ⁴⁵	Hyper-pigmentation ⁵⁰	Inflammation or ulceration within the GI tract ⁵⁵	Fat necrosis ⁵⁹	Urinary incontinence ⁶³
Retinopathy ¹⁵	Dry eye syndrome ³¹	Anemia, leukopenia, cytopenia, thrombocytopenia ³³	Vomiting ⁴⁵	Anorexia ⁵⁰	GI bleeding ⁵⁵	Comesis score ⁶⁰	Obstructive symptoms ⁶³

Pediatric	Adult						
	Eye	CNS and Spine	Head and Neck	Lung	Gastrointestinal	Breast	Prostate
Dermatitis ¹⁵ , erythema ¹⁵ , alopecia ¹⁵	retinal detachment ³²	Esophagitis, Dysphagia ³⁴	Xerostomia ⁴³	Nausea ⁵⁰	Radiation- induced liver disease ⁵⁵	Fibrosis ⁶⁰	Retentive symptoms ⁶³
Mucositis ¹⁵		Anorexia weight loss ³⁴	Dysphagia ⁴³	Vomiting ⁵⁰	Fibrotic stenosis of bile duct ⁵⁶	Skin atrophy ⁶⁰	Prostatitis ⁶³
Odynophagia ¹⁵		Temporary hair loss, focal alopecia ³⁵	Dysgeusia ⁴³	Esophagitis ⁵⁰	Biloma ⁵⁶	Rib pain ⁶⁰	Proctitis ⁶³
Bowl dysfunction ¹⁵		Deficit in concentration ³⁵	Hoarseness ⁴³	Dysphagia ⁵⁰	Elevation of bilirubin level ⁵⁶	Rib fracture ⁶⁰	Rectal bleeding ⁶³
Epistaxis ¹⁶		Speech errors, impairment in language ³⁵	Fatigue ⁴³	Dyspnea ⁵⁰	Elevation of transaminase level ⁵⁶	Breast pain ⁶¹	Rectal incontinence ⁶³
Cavernoma ¹⁶		Visual deficits, hemianopsia ³⁵	Weight loss ⁴⁴	Atelectasis ⁵⁰	Anemia ⁵⁶	Breast edema ⁶¹	Abdominal cramping ⁶³
Hearing loss ¹⁶		Seizure ³⁶ epilepsy ³⁶	Feeding tube dependence ⁴⁴	Coughing ⁵⁰	Leuko- cytopenia ⁵⁶	Erythema / Hyperpigmentati on ⁶¹	Urethral stricture ⁶⁴
Facial dimorphism, bone asymmetry ¹⁷		Central nerve palsy ³⁶	Opioid pain requirement ⁴⁴	Pulmonary/ pleural fistula ⁵⁰	Thrombocyto- penia ⁵⁶	Wet desquamation, Induration ⁶¹	Hip pain ⁶⁵

Pediatric	Adult						
	Eye	CNS and Spine	Head and Neck	Lung	Gastrointestinal	Breast	Prostate
nausea anorexia weight loss ¹⁸		Peripheral neurologic deficits ³⁶	Brain stem toxicity ⁴⁵	Radiation pneumonitis ⁵⁰	Nausea ⁵⁷	Fatigue ⁶²	Hip fracture ⁶⁵
Diarrhea ¹⁹		Hemorrhage ³⁶	Temporal lobe injury ⁴⁵	Tracheo-esophageal fistula ⁵¹	Vomiting ⁵⁷	Skin pain ⁶²	Hematuria ⁶⁶
Bladder dysfunction ²⁰		Vertebral growth retardation (Peds) ³⁷	Neurological injury ⁴⁵	Hemoptysis ⁵¹	Weight loss ⁵⁷	Chest wall pain ⁶²	Cystitis ⁶⁶
Fatigue, emesis ²¹		Narrowed aorta ³⁷	Endocrine dysfunction ⁴⁵	Esophageal stricture ⁵²	Epigastralgia ⁵⁷	Esophagitis ⁶²	Urgency of defecation ⁶⁷
Hemianopsia, vasculopathy ²¹		Baseline neurocognitive impairment, incl. memory and processing speed, intellectual, language, attention, executive function ³⁸	Osteoradio-necrosis ⁴⁶	Hematologic toxicity (anemia, thrombocytopenia, neutropenia leukopenia) ⁵³	Anorexia ⁵⁷	Lymphedema ⁶²	Anal discomfort ⁶⁷

Pediatric	Adult						
	Eye	CNS and Spine	Head and Neck	Lung	Gastrointestinal	Breast	Prostate
Cognitive disturbance, Decline in neurocognitive functions ²²		Endocrine dysfunction Hypopituitarism ³	Nasal congestion ⁴⁶	Subcutaneous induration ⁵³	Dysphagia ⁵⁸		Pain at defecation ⁶⁷
Endocrinopathy ²³		Late radiation necrosis ³⁸	Epistaxis ⁴⁶	Myositis ⁵³	Esophagitis ⁵⁸		Proctalgia ⁶⁷
Endocrine abnormalities ²³		Leukoencephalopathy, Anemia Thrombocytopenia, Leucopenia ³⁹	Middle ear inflammation ⁴⁶	Rib fracture ⁵⁴	Esophageal stenosis ⁵⁸		EPIC sexual score decline ⁶⁸
Skeletal or muscle defect, scoliosis/ kyphosis ²⁴		Cerebrospinal fluid leakage ⁴⁰	Vocal cord paralysis ⁴⁷		Hypoalbuminemia ⁵⁸		Erectile dysfunction ⁶⁸
Neutropenia, pancytopenia, thrombocytopenia, anemia (concurrent chemo) ²⁵		Ischemic brain stroke, brain edema, brain necrosis ⁴¹	Epiglottitis ⁴⁷		Hypocalcemia ⁵⁸		
Hypertension (concurrent chemo) ²⁵		Chronic pain, motor paraplegia, hypoesthesia, paraplegia ⁴²	Secondary tooth decay ⁴⁷		Hyponatremia ⁵⁸		

Pediatric	Adult						
	Eye	CNS and Spine	Head and Neck	Lung	Gastrointestinal	Breast	Prostate
Sepsis (concurrent chemo) ²⁵		Scoliosis, ataxia ⁴²	Nasolacrimal duct stenosis ⁴⁸		Hypophosphatemia ⁵⁸		
Ataxia, quadriplegia, bulbar palsies, hemiparesis, seizure ²⁶		Urinary and bowel sphincter dysfunction ⁴²	Dry-eye syndrome ⁴⁸		Hypoxia Infection ⁵⁸		
Imaging changes in brainstem as radiation reaction or necrosis ²⁶			Ectropion ⁴⁸		Cough ⁵⁸		
Anxiety/depression Pulmonary toxicity Esophagitis ²⁷			Conjunctivitis ⁴⁸				
Chest pain Xerostomia ²⁷			Blepharitis ⁴⁸				
			Cataract ⁴⁸				
			Sinonasal cutaneous fistulas ⁴⁸				
			Facial cellulitis ⁴⁸				

Pediatric	Adult						
	Eye	CNS and Spine	Head and Neck	Lung	Gastrointestinal	Breast	Prostate
			Ocular/visual toxicity (vascular retinopathy, optic neuropathy) ⁴⁸				
			Neurologic toxicities ⁴⁸				
			Auditory toxicities ⁴⁸				
			Thyroid cartilage necrosis ⁴⁹				
			Trismus ⁴⁹				
			Fibrosis ⁴⁹				
			Esophagitis ⁴⁹				
			Carotid rupture ⁴⁹				
			Nasopharyngeal ⁴⁹				
			Parapharyngeal bleeding ⁴⁹				

Limitation and Exclusion of Scope

The scope of this Clinical User's Guide is to describe the operations, features, and functions of the Proteus PLUS.

The Proteus PLUS is capable of interfacing with certain third party products. Where applicable or necessary, these interfaces are described in this Clinical User's Guide.

IBA does **not** assume any responsibility for third party products nor third party product documentation. This Clinical User's Guide in no way aims to replace the relevant documentation of the third party vendor. The third party vendors at all times remain fully responsible for their product and product documentation.

Modification of the IBA System or IBA Accessories

Users are requested not to make any unauthorized modification to the IBA System or IBA accessories. Unless approved in writing and in advance by IBA, any modification to the IBA System or to IBA accessories by the user may cause the loss of the regulatory approval and will void the warranty, and/or be classified as an abnormal failure under the uptime commitment.

Integration or Use of Third Party Equipment or non-IBA Accessories

Users are advised to integrate or use in conjunction with IBA medical devices only authorized third-party equipment or non-IBA accessories that are qualified by IBA as compatible with the IBA System (like proprietary software installation such as the Oncology Information System (OIS)).

Users are further advised to analyse the collisions or other hazards induced by the use of immobilization devices.

Restriction of Use of OIS

The IBA PTS interfaced with an Oncology Information System (OIS) shall only be used in combination with an OIS that is appropriately certified for the country where the Proton Therapy System is deployed.

Restriction of Use of TPS and Gating System

The IBA PTS interfaced with a Treatment Planning System (TPS) and a gating system shall only be used in combination with a TPS and a gating system that are appropriately certified for the country where the Proton Therapy System is deployed.

Wireless Hand-Pendant

■ Generic:

Safe and effective use of the wireless device:

- The wireless hand-pendant subsystem contains:
 - A Bluetooth radio with the following characteristics:

Bluetooth Low Energy (BLE) version 4.1 operating in the 2.400 GHz-2.4835 GHz ISM band using F.H.S.S. modulation.

Effective Isotropic Radiated Power (EIRP): 0 dBm 1 mW Class 1.
 - A Smartphone using an IEEE 802.11 Wi-Fi link. Other wireless links in the smartphone are factory disabled to avoid interferences.

Wi-Fi operating in the 2.400 GHz-2.4835 GHz ISM band using F.H.S.S. modulation; maximum power 100 mW (20 dBm).
 - Wireless Quality of Service (QoS): the subsystem has been designed to be fail safe (to stop movements) in case of loss of communication or significant degradation. Only IBA authorized devices can connect to the hand-pendant wireless access points in treatment room.
 - The battery of the wireless hand-pendant must be replaced by authorized IBA personnel only.
 - Wireless security measure: The subsystem will only accept a connection from a single IBA Hand-Pendant at a time in a given room with IBA Universally Unique Identification protocol. The UUID is factory set and can not be changed by the user. The IEEE 802.11 Wi-Fi link uses WPA2 for authentication. Cross talk between devices in the same vicinity: Due to the unique ID mechanism, it is not possible to operate two devices in the same treatment room. Due to treatment room neutron shielding and low power Bluetooth usage, crosstalk between equipments from outside treatment rooms is very unlikely.
- However we recommend to keep the wireless hand-pendant in the docking station when not in use.

■ USA:

FCC PART 15 Information to user.

FCC ID: 2AHZSHP-MOB

FCC ID: 2AHZSHPV3C-MOB

FCC ID: 2AHZSHP-FIX

Pursuant to part 15.21 of the Federal Communications Commission (FCC) Rules, you are cautioned that changes or modifications not expressly approved by IBA could void your authority to operate the device.

This device complies with part 15 of the FCC Rules. Operation is subject to the following two conditions: (1) This device may not cause harmful interference, and (2) this device must accept any interference received, including interference that may cause undesired operation.

- Europe:

The wireless hand-pendant is in conformity with the relevant Union harmonization legislation: Directive 2014/53/EU (RED).

DRAFT

Intentionally left blank

DRAFT

List of Published Literature

1. *Exaggerated radiation-induced fibrosis in patients with systemic sclerosis.* Varga, J, et al. 24, Philadelphia : s.n., 1991, JAMA, Vol. 265, pp. 3292-3295.
2. *Consequences of breast irradiation in patients with pre-existing collagen vascular diseases.* Fleck, R, et al. 4, Houston : s.n., 1989, Int J Radiat Oncol Biol Phys, Vol. 17, pp. 829-833.
3. *Acute and late reactions to radiation therapy in patients with collagen vascular diseases.* Ross, JG, et al. 11, Iowa City : s.n., 1993, Cancer, Vol. 71, pp. 3744-3752.
4. *Irradiation of the setting of collagen vascular disease: Acute and late complications.* Morris, MM et Powell, SN. 7, Boston : s.n., 1997, Journal of Clinical Oncology, Vol. 15, pp. 2728-2735.
5. *Severe acute toxicity from whole breast radiotherapy in the setting of collagen vascular disease.* Hernandez, S, Evans, SB et Wazer, DE. 6, Boston : s.n., 2006, American Journal of Clinical Oncology, Vol. 29, pp. 647-648.
6. *Radiotherapy in setting of collagen vascular disease.* Wo, J et Taghian, A. 5, Boston : s.n., 2007, Int J Radiat Oncol Biol Phys, Vol. 69, pp. 1347-1353.
7. *Matched-control retrospective study of the acute and late complications in patients with collagen vascular diseases treated with radiation therapy.* Phan, C, et al. Louisville : s.n., 2003, Cancer.
8. *Role of radiation therapy in patients with a diagnosis of both systemic lupus erythematosus and cancer.* Benk, V, et al. 1, Toronto : s.n., 2005, Arthritis & Rheumatism, Vol. 53, pp. 67-72.
9. *Systemic lupus erythematosus, radiotherapy, and the risk of acute and chronic toxicity: The Mayo Clinic Experience.* Pinn, ME, et al. 2, Rochester : s.n., 2008, Int J Radiat Oncol Biol Phys, Vol. 71, pp. 498-506.
10. *Ataxia Telangiectasiae - Mutated gene polymorphisms and acute normal tissue injuries in cancer patients after RT.* Dong, L, et al. 5, Changchun : s.n., 2014, Int J Radiat Oncol Biol Phys, Vol. 91, pp. 1090-1098.
11. *Relative biological effectiveness values for proton beam therapy. Variations as a function of biological endpoint, dose, and linear energy transfer.* Paganetti, H, et al. 22, Boston : s.n., 2014, Physics in Medicine & Biology, Vol. 59, pp. 420-473.
12. *Towards achieving the full clinical potential of proton therapy by inclusion of LET and RBE models.* Jones, B. Oxford : s.n., 2015, Cancers, Vol. 7, pp. 460-480.
13. *Clinical evidence of variable proton biological effectiveness in pediatric patients treated for ependymoma.* Peeler, CR, et al. Houston : s.n., 2016, Radiotherapy and Oncology, pp. 395-401.
14. *Disregarding RBE variation in treatment plan comparison may lead to bias in favor of proton plans.* Wedenberg, M et Toma-Dasu, I. 9, Stockholm : s.n., 2014, Medical Physics, Vol. 41.

15. *Preliminary results of a phase II trial of proton radiotherapy for pediatric rhabdomyosarcoma.* Ladra, MM, et al. 33, Boston : s.n., 2014, Journal of Clinical Oncology, Vol. 32.
16. *Proton radiotherapy for pediatric central nervous system ependymoma: clinical outcomes for 70 patients.* MacDonald, SM, et al. Boston : s.n., 2013, Neuro-Oncology, Vol. 15, pp. 1552-1559.
17. *Proton radiotherapy for pediatric tumors: review of first clinical results.* Rombi, B, et al. Trento : s.n., 2014, Italian Journal of Pediatrics, Vol. 40.
18. *Proton radiotherapy for pediatric Ewing's sarcoma: Initial clinical outcomes.* Rombi, B, et al. 3, Trento : s.n., 2012, Int J Radiat Oncol Biol Phys, Vol. 82, pp. 1142-1148.
19. *Proton therapy for spinal ependymomas: Planning, acute toxicities, and preliminary outcomes.* Amsbaugh, MJ, et al. 5, Houston : s.n., 2012, Int J Radiat Oncol Biol Phys, Vol. 83, pp. 1419-1424.
20. *Proton radiotherapy for pediatric bladder/prostate rhabdomyosarcoma: clinical outcomes and dosimetry compared to intensity modulated radiation therapy.* Cotter, SE, et al. 5, Boston : s.n., 2011, Int J Radiat Oncol Biol Phys, Vol. 81, pp. 1367-1373.
21. *Craniopharyngioma and Proton Therapy.* Bradley, JA et Indelicato, DJ. Jacksonville : s.n., 2014, International Journal of Particle Therapy, pp. 386-398.
22. *Early cognitive outcomes following proton radiation in pediatric patients with brain and central nervous system tumors.* Pulsifer, MB, et al. 2, Boston : s.n., 2015, Int J Radiat Oncol Biol Phys, Vol. 93, pp. 400-407.
23. *Proton beam therapy versus conformal photon radiation therapy for childhood craniopharyngioma: multi-institutional analysis of outcomes, cyst dynamics, and toxicity.* Bishop, AJ, et al. 2, Houston : s.n., 2014, Int J Radiat Oncol Biol Phys, Vol. 90, pp. 354-361.
24. *Proton radiotherapy for pediatric sarcoma.* Ladra, MM et Yock, TI. Boston : s.n., 2014, Cancer, Vol. 6, pp. 112-127.
25. *Outcomes and acute toxicities of proton therapy for pediatric atypical teratoid/rhabdoid tumor of the CNS.* McGovern, SL, et al. 5, Houston : s.n., 2014, Int. J. Radiat. Oncol. Biol. Phys., Vol. 90, pp. 1143-1152.
26. *Incidence of CNS injury for a cohort of 111 patients treated with proton therapy for medulloblastoma: LET and RBE associations for areas of injury.* Giantsoudi, D, et al. 1, Boston : s.n., 2016, Int J Radiat Oncol Biol Phys, Vol. 95, pp. 287-296.
27. *Involved-node proton therapy in combined modality therapy for Hodgkin lymphoma: results of a phase 2 study.* Hoppe, BS, et al. 5, Jacksonville : s.n., 2014, Int J Radiat Oncol Biol Phys, Vol. 89, pp. 1053-1059.
28. *Intravitreal bevacizumab for neovascular glaucoma in uveal melanoma treated by proton beam therapy.* Mahdjoubi, A, et al. Paris : s.n., 2018, Graefes Arch Clio Exp Ophthalmol, pp. 411-420.

29. *Radiation maculopathy after proton beam therapy for uveal melanoma: Optical coherence tomography angiography alterations influencing visual acuity.* Matet, A, Daruich, A et Zografos, L. Lausanne : s.n., 2017, *Investigative Ophthalmology and Visual Science*, Vol. 58, pp. 3851-3861.
30. *Proton therapy of iris melanoma with 50 CGE.* Riechardt, AI, et al. Berlin : s.n., 2017, *Strahlenther Onkol*, pp. 943-950.
31. *Dry eye syndrome after proton therapy of ocular melanomas.* Thariat, J, et al. 1, Nice : s.n., 2017, *Int J Radiat Oncol Biol Phys*, Vol. 98, pp. 142-151.
32. *Intravitreal dexamethasone implant (Ozurdex) for exudative retinal detachment after proton beam therapy for choroidal melanoma.* Malclès, A, et al. Lyon : s.n., 2017, *European Journal of Ophthalmology*, Vol. 27, pp. 596-600.
33. *Technique, outcomes, and acute toxicities in adults treated with proton beam craniospinal irradiation.* Barney, CL, et al. Houston : s.n., 2014, *Neuro-Oncology*, Vol. 16, pp. 303-309.
34. *Proton beam craniospinal irradiation reduces acute toxicity for adults with medulloblastoma.* Brown, AP, et al. 2, Houston : s.n., 2013, *Int J Radiat Oncol Biol Phys*, Vol. 86, pp. 277-284.
35. *First experiences in treatment of low-grade glioma grade I and II with proton therapy.* Hauswald, H, et al. Heidelberg : s.n., 2012, *Radiation Oncology*.
36. *Stereotactic proton beam therapy for intracranial arteriovenous malformations.* Vernimmen, FJ, et al. 1, Tygerberg : s.n., 2005, *Int J Radiat Oncol Biol Phys*, Vol. 62, pp. 44-52.
37. *Clinical results of proton beam therapy for advanced neuroblastoma.* Oshiro, Y, et al. Tsukuba : s.n., 2013, *Radiation Oncology*.
38. *Proton therapy for low-grade gliomas: Results from a prospective trial.* Shih, HA, et al. 2015, *Cancer*, pp. 1712-1719.
39. *Phase I/II trial of hyperfractionated concomitant boost proton radiotherapy for supratentorial glioblastoma multiforme.* Mizumoto, M, et al. 1, Tsukuba : s.n., 2010, *Int J Radiat Oncol Biol Phys*, Vol. 77, pp. 98-105.
40. *Proton beam radiation therapy for skull base adenoid cystic carcinoma.* Pommier, P, et al. Boston : s.n., 2006, *Arch Otolaryngol Head Neck Surg*, Vol. 132, pp. 1242-1249.
41. *Spot scanning-based proton therapy for intracranial meningioma: Long-term results from the Paul Scherrer Institute.* Weber, DC, et al. 3, Geneva : s.n., 2011, *Int J Radiat Oncol Biol Phys*, Vol. 83, pp. 865-871.
42. *Long-term outcome of patients with spinal myxopapillary ependymoma: treatment results from the MD Anderson Cancer Center and institutions from the Rare Cancer Network.* Weber, DC, et al. Villigen : s.n., 2015, *Neuro-Oncology*, Vol. 17, pp. 588-595.
43. *Proton beam radiation therapy results in significantly reduced toxicity compared with intensity-modulated radiation therapy for head and neck tumors that require ipsilateral radiation.* Romesser, PB, et al. New York : s.n., 2016, *Radiotherapy and Oncology*, Vol. 118, pp. 286-292.

44. *Acute toxicity in comprehensive head and neck radiation for nasopharynx and paranasal sinus cancers: cohort comparison of 3D conformal proton therapy and intensity modulated radiation therapy.* McDonald, MW, et al. Atlanta : s.n., 2016, Radiation Oncology.
45. *Proton therapy for head and neck cancer: expanding the therapeutic window.* Leeman, JE, et al. New-York : s.n., 2017, The Lancet Oncology, Vol. 18, pp. 254-265.
46. *High-dose proton beam therapy for sinonasal mucosal malignant melanoma.* Fuji, H, et al. Nagaizumi : s.n., 2014, Radiation Oncology.
47. *Proton radiation for treatment of cancer of the oropharynx: Early experience at Loma Linda University medical centre using a concomitant boost technique.* Slater, JD, et al. 2, Loma Linda : s.n., 2005, Int J Radiat Oncol Biol Phys, Vol. 62, pp. 494-500.
48. *Long-term outcomes after proton beam therapy for sinonasal squamous cell carcinoma.* Russo, AL, et al. 1, Boston : s.n., 2016, Int J Radiat Oncol Biol Phys, Vol. 95, pp. 368-376.
49. *Proton beam reirradiation for recurrent head and neck cancer: Multi-institutional report on feasibility and early outcomes.* Romesser, PB, et al. 1, New York : s.n., 2016, Int J Radiat Oncol Biol Phys, Vol. 95, pp. 386-395.
50. *Phase II study of high-dose proton therapy with concurrent chemotherapy for unresectable stage III non-small cell lung cancer.* Chang, JY, et al. Houston : s.n., 2011, Cancer, pp. 4707-4713.
51. *Phase 1 study of dose escalation in hypofractionated proton beam therapy for non-small cell lung cancer.* Gomez, DR, et al. 4, Houston : s.n., 2013, Int J Radiat Oncol Biol Phys, Vol. 86, pp. 665-670.
52. *Long-term outcomes after proton therapy, with concurrent chemotherapy, for stage II–III inoperable non-small cell lung cancer.* Nguyen, QN, et al. Houston : s.n., 2015, Radiotherapy and Oncology, Vol. 115, pp. 367-372.
53. *Hypofractionated high-dose proton beam therapy for stage I non-small cell lung cancer: Preliminary results of a phase I/II clinical study.* Hata, M, et al. 3, Tsukuba : s.n., 2007, Int J Radiat Oncol Biol Phys, Vol. 68, pp. 786-793.
54. *Proton beam therapy for patients with medically inoperable stage I non-small cell lung cancer at the University of Tsukuba.* Nakayama, H, et al. 2, Tsukuba : s.n., 2010, Int J Radiat Oncol Biol Phys, Vol. 78, pp. 467-471.
55. *The safety and efficacy of high-dose proton beam radiotherapy for hepatocellular carcinoma: A phase 2 prospective trial.* Bush, DA, et al. Loma Linda : s.n., 2011, Cancer, pp. 3053-3059.
56. *Proton beam therapy for hepatocellular carcinoma: A retrospective review of 162 Patients.* Chiba, T, et al. Tsukuba : s.n., 2005, Clinical Cancer Research, pp. 3799-3805.
57. *A phase I/II study of gemcitabine-concurrent proton radiotherapy for locally advanced pancreatic cancer without distant metastasis.* Terashima, K, et al. Hyogo : s.n., 2012, Radiotherapy and Oncology, Vol. 103, pp. 25-31.

58. *A prospective study of proton beam reirradiation for esophageal cancer.* Fernandes, A, et al. 1, Philadelphia : s.n., 2016, Int J Radiat Oncol Biol Phys, Vol. 95, pp. 483-487.
59. *Partial breast radiation therapy with proton beam: 5-year results with cosmetic outcomes.* Bush, DA, et al. 3, Loma Linda : s.n., 2014, Int J Radiat Oncol Biol Phys, Vol. 90, pp. 501-505.
60. *Long-term cosmetic outcomes and toxicities of proton beam therapy compared with photon based 3-Dimensional conformal accelerated partial-breast irradiation: A phase 1 trial.* Galland-Girodet, S, et al. 3, Boston : s.n., 2014, Int J Radiat Oncol Biol Phys, Vol. 90, pp. 493-500.
61. *Phase II trial of proton beam accelerated partial breast irradiation in breast cancer.* Chang, JH, et al. Goyang : s.n., 2013, Radiotherapy and Oncology, Vol. 108, pp. 209-214.
62. *Early toxicity in patients treated with postoperative proton therapy for locally advanced breast cancer.* Cuaron, JJ, et al. 2, New York : s.n., 2015, Int J Radiat Oncol Biol Phys, Vol. 92, pp. 284-291.
63. *Early outcomes from three prospective trials of image-guided proton therapy for prostate cancer.* Mendenhall, NP, et al. 1, Jacksonville : s.n., 2012, Int J Radiat Oncol Biol Phys, Vol. 82, pp. 213-221.
64. *Outcomes in men with large prostates (>60 cm³) treated with definitive proton therapy for prostate cancer.* McGee, L, et al. Gainesville : s.n., 2013, Acta Oncologica, Vol. 52, pp. 470-476.
65. *Hip fractures and pain following proton therapy for management of prostate cancer.* Valery, R, et al. Jacksonville : s.n., 2013, Acta Oncologica, Vol. 52, pp. 486-491.
66. *Conformal proton therapy for prostate carcinoma.* Slater, JD, et al. 2, Loma Linda : s.n., 1998, Int J Radiat Oncol Biol Phys, Vol. 42, pp. 299-304.
67. *Phase II feasibility study of high-dose radiotherapy for prostate cancer using proton boost therapy: First clinical trial of proton beam therapy for prostate cancer in Japan.* Nihei, K, et al. Chiba : s.n., 2005, Japanese Journal of Clinical Oncology, pp. 745-752.
68. *Erectile function, incontinence, and other quality of life outcomes following proton therapy for prostate cancer in men 60 years old and younger.* Hoppe, BS, et al. Jacksonville : s.n., 2012, Cancer, pp. 4619-4626.

Intentionally left blank

DRAFT



Amendment records

Version	Date of Issue	Details of Amendments	Major Changes in...
A	September 2019	This is the first version of the System Description for the Inova Schar Cancer Institute, Falls Church.	Not applicable
Written by		Checked by	Approved by
Shaunak Khandekar <i>Technical Writer</i>		Philippe Hauglustaine <i>PT Project Manager</i> Max Murphy <i>PT Site Manager</i> Savanna Green <i>QA Product Release Associate</i> Navid Radnia <i>PT Site Technical Leader</i>	

DRAFT

Intentionally left blank

DRAFT

Contents

Copyright Notice	iii
Abstract	iii
Technical Support	iii
Notice	iii
Intended Use	iv
Indications for Use	iv
Contra-indications and Precautions	vi
Software Updates	vii
Essential Performances	ix
Terminology	ix
Side Effects	xi
Limitation and Exclusion of Scope	xvii
Modification of the IBA System or IBA Accessories	xvii
Integration or Use of Third Party Equipment or non-IBA Accessories	xvii
Restriction of Use of OIS	xvii
Restriction of Use of TPS and Gating System	xvii
Wireless Hand-Pendant	xviii
List of Published Literature	xxi
Amendment records	xxvii

Contents

Figures

Tables

About this Manual

Scope and Contents	lxv
Referenced Documentation	lxvi
Coordinates and Movements	lxvi
IBA Dosimetry Water Phantoms	lxvi
AdaPT ^{insight} Patient Position Verification System	lxvi
CIVCO Couchtop	lxvii
What to Expect?	lxviii
Conventions	lxxii
Warnings	lxxii

Cautions	lxxii
Important Notes	lxxii
Typographic Conventions	lxxiii
Illustrations	lxxiii
Troubleshooting Information	lxxiii
Visual Cues	lxxiii

Chapter 1 Introduction

Overview	1-1
Treatment Modes Available at the PT Center	1-2
Therapy Center and Proton Therapy System Building Blocks	1-2
Treatment Planning System (TPS)	1-2
Oncology Information System (OIS)	1-3
Proton Therapy System (PTS) Software	1-5
Usage With an OIS	1-5
Usage Without an OIS	1-5
Patient Positioning Verification System (PPVS)	1-5
PPVS Process	1-5
Treatment Workflow Options	1-7
Workflow Option Criteria	1-7
Workflow Options	1-8
Treatment Mode Aspects	1-9
Frequency Aspect	1-10
Reading Sequence of This Manual	1-11
Option A: Using the Batch Importer and Standalone Delivery	1-11
Option B: Full Standalone Mode	1-12
Option C: Using the OIS	1-12
Patient Related Parameters	1-12
Prescribed Parameters	1-12
Received versus Delivered Parameters	1-13
Operating adaPTdeliver in Clinical Mode or in Physics Mode	1-13
Using Information From the OIS	1-14
Using QA Features of adaPTprescribe	1-15

Chapter 2 Starting Up Applications in the adaPT Treatment Suite

Startup Operations	2-1
Clinical and Non-clinical Environment	2-1

Beginning Clinical Operations	2-2
Verifying the Global Checksum	2-2
The Clinical Environment	2-3
Characteristics of the Clinical Environment	2-4

PART I

EXPLAINING ESSENTIAL SAFETY ASPECTS

Chapter 3

Emergency Procedures in Case of Irradiation Hazard

A Patient is in the Treatment Room and the Beam Fails to Stop when Requested	3-2
The Preset Dose Has Been Reached and the Beam Fails to Shut off Automatically	3-2
A Radiation Therapy Technologist (RTT) Requests the Beam to Pause (or Stop) and the Beam Fails to Pause (or Stop)	3-2
Irradiation Emergency Procedure	3-2
Staff are Present in a Secured Area	3-3
Irradiation Emergency Procedure	3-4
To be Present in a Location Susceptible to Irradiation While Beam is On or Room is Secured	3-5
Irradiation Emergency Procedure	3-5

Chapter 4

Miscellaneous Safety Hazards

Cleaning, a Basic Safety Requirement	4-1
Precautionary Measures	4-2
Keyboard and Mouse Requirements	4-2
Usage of Tools or Parts in a Treatment Room	4-2
Dealing With an Emergency Situation	4-3
Gantry Rolling Floor Precautions	4-3
Pinching Hazard	4-4
General Pinching Hazards	4-5
Magnetic Field Hazard	4-7
Functions of the Beam Intensity Redundant Electronic Unit	4-9
BIREU Startup or Connection Failure	4-9

PART II

USING TREATMENT ROOM EQUIPMENT

Chapter 5

Introducing Treatment Room Equipment

Effects of Temperature and/or Pressure Changes in the Treatment Room	5-2
Safety Aspects	5-2

Chapter 6

Elementary Notions on Patient Positioning

Supported Coordinate Systems	6-3
IEC Fixed Reference System (f)	6-3
IEC Gantry Coordinate System (g)	6-5
IEC Table Top Coordinate System (t)	6-5
Types of Patient Positioning Device (PPD) Motion	6-8
Using Auto Motions	6-9
Target Positions in a GTR	6-10
Using Manual Motions	6-11
Manual Motions in a GTR	6-12
Using Trajectory Motions	6-13
Patient Positioning Devices	6-13

Chapter 7

Moving the Patient Positioning Devices

Patient Positioning Devices	7-3
Patient Positioning System (PPS)	7-3
Allowed Maximum Weight on the Couch	7-4
Patient Positioning System Overload	7-5
Constant Weight on the Couch	7-6
Couch Modifications	7-6
Extended Treatment Volume (ETV)	7-6
Using the Couch	7-8
Moving the couch beams (for X-ray imaging) for the kVue couch	7-9
Enhanced Safety Through Various Software Limits	7-10
GoTo Motions in a GTR	7-10
Snout Holder	7-13
Accessory Drawer	7-13
Gantry	7-14

Solving Collisions	7-14
If a collision occurs	7-15
Managing Proximity	7-16

Chapter 8

Controlling Movement: Wireless Hand-Pendant and Remote Positioning Controls

Wireless Hand-Pendant Screens	8-2
Remote Positioning Controls Panel	8-3
App Bar (Wireless Hand-Pendant) and Remote Positioning Controls Bar Icons	8-5
Understanding Colors in the Wireless Hand-Pendant GUI and Remote Positioning Controls Panel	8-6
Understanding Auditive Signals	8-10
Understanding Vibration Signals of the Wireless Hand-Pendant	8-11
Switching Command From the Wireless Hand-Pendant to the Remote Positioning Controls	8-11
Switching Command From the Remote Positioning Controls to the Wireless Hand-Pendant	8-13

Chapter 9

Using the Wireless Hand-Pendant

Safety Measures Specific to the Use of the Wireless Hand-Pendant	9-3
Registering the Wireless Hand-Pendant	9-4
Registration Procedure	9-5
Registration Consequences	9-8
Unlocking the Wireless Hand-Pendant	9-8
Controlling Speed	9-8
Stopping Movements	9-10
Release the Move Device Button	9-10
Release the Motion Enable Buttons	9-11
Press an Emergency Stop Button	9-11
Operating Modes: Auto and Manual	9-12
Prerequisite: Selecting a Device	9-12
Using the GUI in Auto Mode	9-13
Auto Mode Target Positions	9-13
Selecting a Target Position	9-13
Selecting and Moving a Patient Positioning Device	9-15
PPS Screen	9-16
Gantry, Snout, and Drawer Screen	9-17

Selecting and Moving a Device	9-17
Creating User-Defined Positions	9-18
Managing Prescribed and User-Defined Positions	9-21
Using the GUI in Manual Mode	9-23
Using Manual Mode to Move the Gantry, the Accessory Drawer and the Snout	9-24
Moving the Gantry	9-25
Moving the Accessory Drawer	9-26
Moving the Snout holder	9-26
Using Manual Mode to Move the PPS (Patient Positioning System)	9-27
Moving the PPS along the X Axis	9-28
Moving the PPS along the Y Axis	9-29
Moving the PPS along the Z Axis	9-29
Rotating the PPS Around the Isocenter	9-29
Pitching the PPS	9-29
Rolling the PPS	9-31
Moving the Digital Imaging Devices	9-31
Preparing Equipment for a CBCT Acquisition	9-32
Using Advanced Options From the Menu	9-39
Recovering Devices after an Error	9-40
Colorblind Users: Negative Colors	9-40

Chapter 10

Wireless Hand-Pendant Daily Checks and Troubleshooting

Checking the Good State of the Hand-Pendant's Casing	10-1
Checking the Motion Enable Buttons	10-2
Checking Sound and Vibration Feedbacks	10-2
Monitoring Wireless Hand-Pendant Connections	10-3
Solving Battery and Autonomy Issues	10-3

Chapter 11

Using the Remote Positioning Controls

Safety Measures Specific to the Use of the Remote Positioning Controls	11-2
Performing a Motion Dry Run	11-3
Remote Positioning Hardware Console	11-3
Controlling Speed	11-4
Stopping Movements	11-6
Release the MOVE Button	11-6
Release the Motion Enable Button	11-6

Press an Emergency Stop Button	11-6
Using Tool Tips	11-7
Operating Modes: Auto and Manual	11-8
Using the Remote Positioning Controls in Auto Mode	11-8
Auto Mode Target Positions	11-9
Selecting a Target Position	11-10
Target Position Device Feedback	11-12
Moving Devices to a Target Position	11-13
Moving the Snout holder	11-14
Moving the Accessory Drawer	11-14
Moving the Gantry	11-17
Moving the PPS	11-17
Using Auto Mode to Move the Imaging Devices	11-18
Preparing Equipment for a CBCT Acquisition	11-18
Using Auto Mode to Move to a User Preset	11-22
Using Auto Mode to Create and Edit User Presets	11-23
Creating a User Preset	11-23
Editing a User Preset	11-25
Managing User Presets	11-26
Using the Remote Positioning Controls in Manual Mode	11-30
Using Manual Mode to Move the Accessory Drawer and the Snout	11-31
Moving the Accessory Drawer	11-32
Moving the Snout	11-33
Using Manual Mode to Move the Gantry	11-34
Using Manual Mode to Move the PPS (Patient Positioning System)	11-35
Moving the PPS Along the X Axis	11-36
Moving the PPS Along the Y Axis	11-36
Moving the PPS Along the Z Axis	11-37
Rotating the PPS Around the Isocenter	11-37
Pitching the PPS	11-38
Rolling the PPS	11-38
Using Advanced Settings	11-39

Chapter 12 Alignment Tools and Devices

Alignment Correction Calculation Tool: adaPTinsight	12-3
Relationship between Imaging equipment and treatment geometries	12-5
Alignment	12-5
Patient Alignment Devices	12-7
Working With Laser Devices	12-9

Location of Lasers in a GTR	12-9
Laser Locations for PBS Dedicated Nozzle	12-9
Turning Lasers On and Off	12-12
Working with X-ray Images in a GTR, for Use With adaPTinsight	12-13
Setting up for Orthogonal X-ray Images in a GTR	12-14
Setting up for Portal View X-ray Images in a GTR	12-16
Setting up for Single-source (Rad-A) Stereoscopic X-ray Image Acquisition in the GTR	12-17
Setting up for Acquiring Stereo X-ray Images Using Rad-A	12-19
Setting up for Acquiring CBCT Images	12-21

Chapter 13

Attaching/Removing a Patient Support Device to/from the PPS

Preliminary: Gantry Rolling Floor Precautions	13-1
Couch Identification	13-1
The Docking Principle	13-2
Docking Modes	13-5
Manual Docking and Undocking	13-7
Manually Docking a PPS Support Device	13-7
Manually Undocking a PPS Support Device	13-9
Automatic Docking and Undocking	13-11
Overview: Automatic Docking	13-11
Overview: Automatic Undocking	13-11
Positions and Areas	13-12
Docking Instructions	13-13
Automatically Docking a Docking Device	13-15
Automatically Undocking a Docking Device	13-19
Interrupting, Resuming, or Cancelling an Automatic Docking or Undocking Operation	13-21
Interrupting an Automatic Docking or Undocking Operation	13-21
Resuming an Automatic Docking or Undocking Operation	13-21
Canceling an Automatic Docking or Undocking Operation	13-21

Chapter 14

Installing and Removing Accessories into/from the Accessory Drawer or PBS Dedicated Snout

Accessories	14-1
Preliminary Precautions	14-3
Preliminary: Gantry Rolling Floor Precautions	14-3
Accessory Precautions	14-3
Accessory Holder Operations	14-5
Installing an Accessory or Snout onto the Accessory Drawer	14-5
Removing an Accessory or Snout from the Accessory Drawer	14-6
Snout Types	14-7
Type DN_S (Dedicated Nozzle - Small) Snout Operations ...	14-9
Installing Accessories onto a DN_S Type Snout	14-11
Removing Accessories from a DN_S Type Snout	14-13
Type DN_M (Dedicated Nozzle - Medium) Snout Operations	14-15
Installing Accessories onto a DN_M Type Snout	14-17
Removing Accessories from a DN_M Type Snout	14-18
Type DN_XL (Dedicated Nozzle - Extra Large) Snout Operations	14-19
Installing Accessories onto a DN_XL Type Snout	14-22
Removing Accessories from a DN_XL Type Snout	14-22

Chapter 15

Resetting a Dose Counter Electronic Unit

DCEU Types	15-4
DCEU With Actual Preset MU Value	15-4
DCEU With Preset MU Value to be Multiplied by 10	15-4
Effects of Temperature and/or Pressure Changes in the Treatment Room	15-5

Chapter 16

Operating the Patient Positioning System Manually (Emergency Release Mode)

Using the Emergency Hand-Pendant	16-4
Performing a Coplanar Movement, Joints 1-2	16-4
Performing a Vertical Motion, Joint 3	16-5

Chapter 17

Performing QA Checks and Verifying Beams With a Water Phantom

Locating the Water Phantom on the PPS	17-3
Verifying Beams	17-5

Chapter 18

Troubleshooting Treatment Room Equipment

PART III

THE PENCIL BEAM SCANNING (PBS) SUITE

Chapter 19

Guiding You Through the Pencil Beam Scanning Documentation

Chapter 20

Pencil Beam Scanning Principles

Introduction	20-1
Clinical Advantages	20-2
Longitudinal and Transversal Dose Distribution in PBS	20-3
Longitudinal Distribution	20-3
Layers	20-3
Transversal Distribution	20-4
Beam Delivery Characteristics in PBS	20-4
Spot Scanning	20-4
Repainting Modes	20-5
In-Layers Repainting	20-6
Decrease in Energy	20-6
Back and Forward	20-6
None (no layer repainting)	20-6
Mixed Repainting	20-6

Chapter 21

Introducing PBS Beam Delivery System Equipment

The PBS Treatment Mode	21-1
PBS Capable Nozzle Types	21-2

Role of the Scanning Magnets	21-2
Low Ranges	21-2
The Scanning Controller	21-2

Chapter 22 PBS Multiple Repainting

Multiple Repainting Types	22-1
None	22-2
Identification	22-2
Representation	22-2
Graph	22-2
In-Layers Repainting	22-3
Identification	22-3
Representation	22-3
Graph	22-4
Decrease in Energy	22-4
Identification	22-4
Representation	22-5
Graph	22-5
Back and Forward	22-5
Identification	22-6
Representation	22-6
Graph	22-6
Mixed Repainting	22-7
Identification	22-7
Representation	22-7
Graph	22-7

PART IV USING *adaPTprescribe*

Chapter 23 TPS-PTS Communication in Standalone Mode

Using the Batch Importer	23-2
Using the <i>adaPTprescribe</i> 'Import' Feature	23-4

Chapter 24 Getting Started With *adaPTprescribe*

Starting an <i>adaPTprescribe</i> Session	24-2
Exiting an <i>adaPTprescribe</i> Session	24-2
Logging into <i>adaPTprescribe</i>	24-3
Logging out From <i>adaPTprescribe</i>	24-4
<i>adaPTprescribe</i> Screen Layout	24-5

Chapter 25 How *adaPTprescribe* is Organized

Chapter 26 Managing Patients

Viewing a Patient	26-2
Searching for a Patient	26-3
Performing a Simple Search	26-3
Performing an Advanced Search	26-4
Arranging Patients	26-7
Selecting a Patient	26-7
Importing a Patient Using DICOM	26-9
Editing a Patient	26-9
Impact of Editing Activities on an External Plan	26-10
Activating or Deactivating a Patient	26-12
Deactivating a Patient	26-12
Activating a Patient	26-12
Unlocking a Patient	26-12
Creating a Study	26-15
Obtaining Irradiation History Reports	26-16
Saving the Irradiation History Report	26-17
Exporting the Irradiation History of a Plan in DICOM Format	26-18
Displaying the Irradiation History of a Beam	26-19

Chapter 27 Managing Studies

Searching for a Study	27-2
Viewing a Study	27-3
Activating or Deactivating a Study	27-3
Deactivating a Study	27-4
Activating a Study	27-4

Chapter 28 Managing Plans

Searching for a Plan	28-2
Viewing a Plan	28-4
Baselining a Plan	28-5
Confirming Baselining in PBS	28-7
Receiving the Baseline Notification	28-7
Copying and Pasting a Plan	28-7
Copying a Plan	28-8
Pasting a Plan	28-8
Activating or Deactivating a Plan	28-9
Deactivating a Plan	28-9
Activating a Plan	28-9

Chapter 29 Managing Beams

Viewing a Setup Beam	29-3
Viewing the Tolerance Table	29-4
Viewing a Treatment Beam	29-5
Copying and Pasting a Treatment Beam	29-6
Copying a Beam	29-7
Pasting a Beam	29-7
Saving a PBS Beam	29-7
Accessing Layer Details	29-8
Viewing Layer Details	29-8
Baselining a Beam	29-11
Confirming Baselining in PBS	29-12
Confirming Excessive MUs	29-12
Receiving the Baseline Notification	29-13

Chapter 30 Using QA Features of *adaPTprescribe*

Managing QA patients	30-2
Managing MACHINE_QA plans	30-2
Modifying the Treatment Machine	30-3
Creating a New PBS Beam from Scratch	30-4
Managing Beams Belonging to MACHINE_QA Plans	30-5
Editing Layer and Spot Details On the Layer Editing Screen	30-6
Editing Layer Details Using the Layer Editing Menu	30-9
Using Keyboard Shortcuts to Edit Layers	30-10

Adding Layers	30-10
Deleting a Layer	30-11
Editing a Layer	30-11
Copying a Layer	30-12
Pasting a Layer	30-12
Editing Spot Details Using the Spot Editing Menu	30-12
Using Keyboard Shortcuts to Edit Spots	30-13
Adding Spots	30-13
Deleting a Spot	30-14
Editing a Spot	30-14
Copying a Spot	30-15
Pasting a Spot	30-15
Importing a PLD (PBS Layer Definition) File	30-16
Understanding PLD files	30-16

PART V

USING *adaPTdeliver*

Chapter 31

Introducing *adaPTdeliver*

Introduction	31-1
Using <i>adaPTdeliver</i> in Standalone Mode	31-1
Using <i>adaPTdeliver</i> in Worklist Mode	31-3
Starting <i>adaPTdeliver</i>	31-5
Stopping <i>adaPTdeliver</i>	31-6
Logging into <i>adaPTdeliver</i>	31-7
Logging Out From <i>adaPTdeliver</i>	31-8
Operation Mode: Clinical	31-8
Screen Layout	31-9
Dealing With Error Messages	31-11
Standalone Mode Specific: Selecting a Patient, Study, Plan, or Beam	31-11
Finding a Patient	31-13
Working With Patients, Studies, Plans, or Beams in the List	31-14
Expanding or Collapsing an Instance	31-15

PART VI

USING ADAPT*deliver*

IN STANDALONE MODE

Chapter 32

Introducing adaPT*deliver* Operating in Standalone Mode

Introduction	32-2
In Case an Error Message Appears	32-4

Chapter 33

Including One or More Beams into a Session

Introduction	33-1
Performing General Activities on Screen	33-1
Selecting an Individual Beam	33-1
Selecting Some or All Beams	33-3
Displaying Information in the Information Area	33-3
Reviewing Patient, Study, and Plan Information	33-5
Reviewing Clinical Prescriptions for PBS	33-7
Displaying Layer Information	33-10
Visualizing Layers	33-13

Chapter 34

Proceeding to Beam Selection

Introduction	34-1
Proceeding With an Incomplete Plan	34-2
Reporting Functions	34-2
Selecting a Beam	34-2

Chapter 35

Preparing the Equipment for Irradiation

Getting Started With Equipment Preparation	35-1
Process	35-1
Equipment Preparation for a Setup Beam	35-2
Interpreting Positioning Values	35-4
Entering Corrections	35-6
Validating the Positioning Parameters	35-6

Equipment Preparation for a Treatment Beam	35-8
Preparing the Treatment Room	35-8
Preparing the Equipment for Treatment - PBS	
Dedicated Nozzle	35-9
Verifying the PBS Dedicated Nozzle	35-11
Overview	35-11
Nozzle Devices Details	35-14
Verifying the Position of Devices	35-17
Influence of Setup Position Corrections on a	
Subsequent Treatment Beam	35-19
An Adjusted Setup Beam followed by multiple	
Treatment Beams	35-19
An Adjusted Setup Beam followed by multiple	
sets of Treatment Beams	35-20
Entering Corrections	35-20
Validating the Positioning Parameters	35-21
Requesting Beam	35-22
Obtaining Authorizations	35-23
Making a Beam Request	35-23
Verifying the Room Interlocks	35-25
Proceeding to Treatment	35-27

Chapter 36 Monitoring and Controlling the Treatment

Proceeding to the Treatment Step	36-1
Performing Functions From the Actions Panel	36-3
Working With the Dosimetry Panel	36-4
Performing Functions From the Monitor Panel	36-6
Monitor Panel GUI Conventions	36-7
Viewing Operator Logs	36-8
Monitoring System Start/Resume Conditions	36-8
Monitoring Beam Line Checks	36-8
Monitoring Nozzle Cyclic Checks	36-10
Monitoring TSS Interlocks	36-11
Monitoring the Positioning System Status	36-12
Resuming Irradiation After a Positioning Check	
Manager Halt	36-13

Chapter 37 Starting Irradiation

Process	37-1
Partially Delivered Prescribed Dose	37-3
Error Message "Delivered MU of layer should be less than prescribed MU"	37-3

Chapter 38 Pausing and Stopping an Irradiation

Introduction	38-2
Gating the Beam	38-2
Pausing Irradiation	38-3
Resuming Irradiation After a Pause	38-4
Stopping Irradiation	38-5

Chapter 39 Resuming after a Partial Irradiation

Summary of the steps for Resuming from a Partial treatment	39-3
Termination by the Therapist: No Recovery needed	39-6
Specific warnings	39-6
Termination by the Proton Therapy System	39-8
Online recovery - adaPTdeliver session maintained	39-8
Automatic recovery	39-8
Retry and Troubleshoot	39-9
Manual recovery from File	39-11
Manual Recovery from DCEU values	39-13
Resuming Irradiation	39-14
Offline recovery - adaPTdeliver session crashes	39-15
Automatic recovery	39-16
Manual recovery from File	39-18
Manual Recovery from DCEU values	39-20
Resuming Irradiation	39-20
Resuming Irradiation in the Same Session	39-22
Resuming irradiation	39-23
Resuming Irradiation in a New Session	39-23
Using the Standalone mode	39-23
Partial treatment record found	39-24
Multiple partial treatment records found	39-26

No partial records found	39-27
Using an OIS	39-27
DEV-Centric mode	39-27

PART VII

USING *adaPTdeliver*

IN WORKLIST MODE

Chapter 40

Operating in Worklist Mode

Selecting an Appointment	40-1
Appointment Selection: Dose Limits Check	40-3
Grayed Out Appointments	40-3
When no Appointments Appear	40-4
Procedure	40-4
Selecting a Beam	40-4
How to Proceed From Here?	40-6

Chapter 41

Resuming after a Partial Irradiation

Summary of the steps for Resuming from a Partial treatment	41-2
Termination by the Therapist: No Recovery needed	41-5
Termination by the Proton Therapy System	41-6
Online recovery - <i>adaPTdeliver</i> session maintained	41-6
Automatic recovery	41-6
Retry and Troubleshoot	41-7
Manual recovery from File	41-9
Manual Recovery from DCEU values	41-11
Resuming Irradiation	41-12
Offline recovery - <i>adaPTdeliver</i> session crashes	41-13
Automatic recovery	41-14
Manual recovery from File	41-16
Manual Recovery from DCEU values	41-18
Resuming Irradiation	41-18
Resuming Irradiation in the Same Session	41-20
Resuming irradiation	41-21
Resuming Irradiation in a New Session	41-21
Using an OIS	41-21

DEV-Centric mode	41-21
End of an Irradiation	41-25
Disconnection of the OIS-adaPT <i>deliver</i> Link	41-25

PART VIII

BROWSING adaPT*deliver* REPORTS

Chapter 42

Browsing Reports

Using Reports	42-1
Session Report Entry Characteristics	42-2
Beam Report Entry Characteristics	42-3
Display an Irradiation Report	42-3
Exporting a Session Report to DICOM	42-4

PART IX

ADAPT*deliver* IN PHYSICS MODE

Chapter 43

Using adaPT*deliver* in Physics Mode

Session Definition	43-4
Baselining Aspects in Clinical and Physics Mode	43-6
Using the Pristine Beam Tool	43-7
Beam Selection	43-11
Preparation	43-11
Verifying the Position of Devices	43-12
Verifying the Room Interlocks	43-14
Treatment	43-15

PART X PREPARING FOR TREATMENT

Chapter 44 Beam Scheduling Principles

ABS Automatic Mode	44-1
ABS Manual Mode	44-1
Switching ABS Modes	44-2

Chapter 45 Preparing a Treatment Room

Verifying Removable Patient Supports	45-1
Preparing a Gantry Treatment Room	45-1
Preliminary: GRF Precautions	45-1
GTR Preparation	45-2
Procedure	45-2

PART XI PATIENT POSITIONING AND ALIGNMENT

Chapter 46 Introducing Patient Positioning and Alignment

Various Positions Involved	46-2
Setup Position	46-3
Prescribed and Corrected Setup Position	46-5
Treatment Position	46-5
Taring the PPS	46-9
What is the tare, and why should it be done?	46-9
When the tare must be done?	46-9
Prerequisites for performing a tare	46-9
If tare is performed with an incorrect prerequisite... ..	46-10
Procedure to perform the tare	46-10
Using the wireless hand-pendant.	46-10
Automatic Weight Check	46-13
The Typical Alignment Correction Process	46-19
Recovering From an Equipment Error	46-25

Chapter 47

Calculating Corrections Using *adaPTinsight*

Preliminary <i>adaPTinsight</i> Activities	47-2
Starting up <i>adaPTinsight</i>	47-2
Logging Into <i>adaPTinsight</i>	47-2
Logging Out From <i>adaPTinsight</i>	47-3
Starting the X-ray Generators	47-3
Calculating Corrections	47-5
Selecting the Patient, Plan and Beam	47-5
Pre-aligning the Patient	47-5
Acquiring Images	47-6
3D Acquisition: kV CBCT	47-8
Registering Images	47-9
2D-3D Image Registration	47-10
3D-3D Image Registration	47-10
Generating the Correction	47-10
Correction Feedback	47-11
How to Interpret <i>adaPTinsight</i> Corrections	47-11
How to Apply and Implement the Calculated Corrections	47-12

Chapter 48

Using the Universal Beam Triggering Interface

Introducing Triggering	48-1
Why Use Triggering With the Proton Beam?	48-1
Why Use Triggering With the Patient Positioning Verification System (PPVS)?	48-1
The Triggering Solution	48-2
Triggering Requirements	48-2
UBTI Details	48-4
Explaining the Universal Beam Triggering Interface	48-4
Location	48-4
Operating the UTEU	48-6
Two Modes of Operation: Manual or Automatic	48-6
Automatic Triggering	48-6
Manual Triggering	48-6
UTEU Controls	48-7
Gating Prescription	48-8
Specify the prescription at TPS/OIS level	48-8
Relationship between prescription and source selected on the triggering rack	48-8
Prescription display	48-9

Prescription mismatch	48-9
Triggering Procedure	48-16
How the UBTI Affects the Irradiation Process	48-18
Using UBTI in the Pencil Beam Scanning	
Treatment Mode	48-18
Beam Enabling/Disabling	48-19

Chapter 49

Aligning a Patient in the GTR

Moving Equipment to the Setup Position	49-2
Verifying Patient Alignment in Setup Position	49-3
Correcting the Setup Position	49-5
Inputting the Setup Corrections	49-6
Implementing the Corrections	49-6
Confirming the Setup Position	49-8
Working With the Treatment Session Manager	49-8
Moving Equipment to Treatment Position	49-8
Verifying Patient Alignment in Treatment Position	49-9
Correcting the Treatment Position	49-9
Inputting the Treatment Position Corrections	49-10
Implementing the Position Corrections	49-11
Confirming the Treatment Position	49-12

PART XII

MONITORING AN IRRADIATION

Chapter 50

Monitoring an Irradiation

Appendix A

Nozzle Types and Components

Nozzle Position	A-1
Nozzle Types	A-1
Pencil Beam Scanning (PBS) Dedicated Nozzle	A-1
Nozzle Types and Components PBS Dedicated	
Nozzle Structure	A-3
The Scanning Controller	A-3
PBS Dedicated Nozzle Layout	A-5
PBS Dedicated Nozzle Components	A-6

Nozzle Frame	A-6
(Low Pressure) Ionization Chamber No. 1 - (LP)IC1	A-6
PBS Dedicated Quadrupole Magnets	A-7
Scanning Magnets	A-7
PBS Dedicated Nozzle Pre-assembly	A-7
Retractable X-ray Tube	A-7
Range Verifier	A-7
Beam Stop Assembly	A-7
Ionization Chambers No. 2 & No. 3 (IC2 & IC3)	A-8
Snout Holder	A-9

Appendix A

Using the Dosimetry Manager

Starting the Dosimetry Manager	A-2
Entering Temperature and Pressure Values	A-3
Handling Errors	A-4
Entering Dose Correction Factor	A-5
Determining the Minimum Allowed MU	A-6
Viewing the History Log	A-7

Appendix B

Managing PTS Users

Creating a New User	B-3
Editing a User and Changing the Password	B-4
Managing Overrides	B-4
Non-Clinical Mode	B-5

Appendix C

Managing *adaPT* prescribe Settings

Managing Tolerance Tables	C-2
Performing Functions With Tolerance Tables	C-3
Internal Tolerance Tables	C-3
External Tolerance Tables	C-4
Managing MU Clinical Ranges	C-5
Managing Accessories	C-6

Appendix D

Emergency Stop Button Locations

Motion Stop Buttons	D-4
---------------------------	-----

**Appendix E
System Messages**

**Appendix F
PTS Acronyms & Abbreviations**

**Appendix G
Glossary of Terms**

Index

Safety Decisions

Issue Tracking System

Problem Reports and Engineering Change Requests ITS-1

DRAFT



Figures

Figure 1-1.	Treatment Workflow Options	1-8
Figure 1-2.	Treatment Workflow Options - Frequency Aspect	1-10
Figure 2-1.	'About TCS' Icon Content	2-3
Figure 2-2.	adaPT <i>prescribe</i> in Clinical Mode	2-5
Figure 2-3.	adaPT <i>prescribe</i> in a non-clinical Mode	2-6
Figure 4-1.	Pinching Hazards on Gantry Rolling Floor Panels	4-4
Figure 4-2.	'BireuServiceStartedCheck' Message	4-9
Figure 6-1.	IEC Fixed Coordinate System	6-4
Figure 6-2.	IEC Gantry Coordinate System	6-5
Figure 6-3.	Table Top Coordinate System (TTCS)	6-6
Figure 6-4.	Zero position of the TTCS	6-7
Figure 6-5.	Remote Positioning Controls Panel - Auto and Manual Modes	6-8
Figure 6-6.	Wireless Hand-Pendant GUI Screen - Auto and Manual Modes	6-9
Figure 7-1.	PPS Structural Parts	7-4
Figure 7-2.	Treatment Volume	7-7
Figure 7-3.	Treatment Volume When Using the (kVueOne) Couch	7-9
Figure 7-4.	Tool for moving the kVue couch beams	7-10
Figure 7-5.	Gantry Angles in Treatment Session (viewed from the Treatment Room)	7-14
Figure 8-1.	Remote Positioning Hardware Console	8-2
Figure 8-2.	Wireless Hand-Pendant GUI Screen	8-3
Figure 8-3.	Remote Positioning Controls Panel in adaPT <i>deliver</i> Screen	8-4
Figure 8-4.	Remote Positioning Controls Panel - Main Features	8-5
Figure 8-5.	Remote Positioning Controls Panel - Disabled	8-12
Figure 9-1.	Wireless Hand-Pendant	9-1
Figure 9-2.	Wireless Hand-Pendant Docking Station	9-2
Figure 9-3.	Wireless Hand-Pendant Connected - Not Registered	9-6
Figure 9-4.	Registration Procedure Screen	9-7
Figure 9-5.	Movement Speed Icons	9-9
Figure 9-6.	Device Selection Bar	9-12
Figure 9-7.	Menu Icon	9-14
Figure 9-8.	Menu	9-15
Figure 9-9.	Treatment Position - Auto Mode (PPS screen)	9-16
Figure 9-10.	Treatment Position - Auto Mode (Gantry, Snout, Drawer screen)	9-17
Figure 9-11.	Creating a User-Defined Position	9-19
Figure 9-12.	New Position Screen	9-20

Figure 9-13.	Arranging User-Defined Positions.....	9-22
Figure 9-14.	Gantry, Snout and Accessory Holder - Manual Mode.....	9-25
Figure 9-15.	Move Accessory Drawer Into the Beam Path Icon	9-26
Figure 9-16.	Move Accessory Drawer Out of the Beam Path Icon	9-26
Figure 9-17.	Insert Snout Icon	9-27
Figure 9-18.	Retract Snout Icon	9-27
Figure 9-19.	PPS - Manual Mode.....	9-28
Figure 9-20.	PPS Pitch/Roll Widget.....	9-30
Figure 9-21.	PPS - Pitch Icon (above) and PPS + Pitch Icon (below).....	9-30
Figure 9-22.	PPS + Roll Icon (above) and PPS - Roll Icon (below).....	9-31
Figure 9-23.	Digital Imaging Devices Screen.....	9-32
Figure 9-24.	CBCT Preparation Button.....	9-33
Figure 9-25.	Snout and Accessory Drawer - CBCT Preparation Screen.....	9-34
Figure 9-26.	Retract Snout Icon	9-34
Figure 9-27.	Move Accessory Drawer Into the Beam Path Icon	9-35
Figure 9-28.	PPS - CBCT Preparation Screen.....	9-36
Figure 9-29.	Digital Imaging Devices - CBCT Preparation Screen.....	9-37
Figure 9-30.	CBCT Dry Run Screen	9-38
Figure 9-31.	Menu - Advanced Options.....	9-39
Figure 9-32.	Wireless Hand-Pendant GUI - Inverted Colors.....	9-40
Figure 11-1.	Remote Positioning Hardware Console.....	11-4
Figure 11-2.	Movement Speed Icons.....	11-4
Figure 11-3.	Tool Tip	11-7
Figure 11-4.	Error Tool Tip	11-8
Figure 11-5.	Remote Positioning Controls Panel - Auto Mode	11-9
Figure 11-6.	Target Positions Commands.....	11-10
Figure 11-7.	User Presets Menu.....	11-11
Figure 11-8.	Preset Selected as Target Position.....	11-12
Figure 11-9.	Target Position Device Feedback	11-13
Figure 11-10.	Snout Options.....	11-14
Figure 11-11.	Accessory Drawer Options.....	11-15
Figure 11-12.	Status Panel - Accessory Drawer Position Feedback	11-16
Figure 11-13.	Gantry Options.....	11-17
Figure 11-14.	Gantry Options.....	11-17
Figure 11-15.	CBCT Preparation Panel (equipment not ready)	11-19
Figure 11-16.	Remote Positioning Controls Panel - CBCT Preparation Icon	11-20
Figure 11-17.	CBCT Preparation Panel - Equipment Ready	11-22
Figure 11-18.	Remote Positioning Controls Panel - User Presets	11-23
Figure 11-19.	New User Preset Icon	11-23
Figure 11-20.	User Preset Edition Menu	11-24
Figure 11-21.	List of User Presets	11-25
Figure 11-22.	Edit User Preset Icon.....	11-25
Figure 11-23.	Manage Presets Icon.....	11-26
Figure 11-24.	Manage Presets Menu	11-27
Figure 11-25.	Edit Preset Icon	11-28

Figure 11-26.	Clone Preset Icon	11-29
Figure 11-27.	Delete Preset Icon	11-30
Figure 11-28.	Remote Positioning Controls - Manual Mode.....	11-31
Figure 11-29.	Accessory Drawer and Snout Commands.....	11-32
Figure 11-30.	Move Accessory Drawer Into the Beam Path Icon	11-32
Figure 11-31.	Move Accessory Drawer Out of the Beam Path Icon	11-32
Figure 11-32.	Insert Snout Icon	11-33
Figure 11-33.	Retract Snout Icon	11-33
Figure 11-34.	Insert or Retract Snout Icon.....	11-34
Figure 11-35.	Gantry Commands.....	11-34
Figure 11-36.	Gantry Commands - Target Angle Selected	11-35
Figure 11-37.	PPS Commands.....	11-36
Figure 11-38.	X and Y PPS Axes Icon	11-36
Figure 11-39.	X and Y PPS Axes Icon	11-37
Figure 11-40.	Z PPS Axis Icon.....	11-37
Figure 11-41.	PPS + Rot Arrow (above) and PPS - Rot Arrow (below)	11-38
Figure 11-42.	PPS +Pitch Icon (above) and PPS - Pitch Icon (below)	11-38
Figure 11-43.	PPS + Roll Icon (above) and PPS - Roll Icon (below)	11-39
Figure 11-44.	Options Menu Icon	11-39
Figure 11-45.	Advanced Settings Menu	11-40
Figure 11-46.	Reset SRCU Warning	11-41
Figure 12-1.	GTR Imaging Geometry.....	12-4
Figure 12-2.	adaPTinsight Integration With the TCS.....	12-5
Figure 12-3.	Laser Locations for PBS Dedicated Nozzle in GTR.....	12-11
Figure 12-4.	CBCT Commands on the X-ray Console	12-22
Figure 13-1.	Tool ID system for couch identification	13-2
Figure 13-2.	PPS - Major Moving Parts.....	13-3
Figure 13-3.	Coupling System.....	13-3
Figure 13-4.	Lock/Unlock Button	13-4
Figure 13-5.	Air Locking Coupler on the Wrist.....	13-5
Figure 13-6.	Positioner Menu	13-8
Figure 13-7.	Positioner Menu	13-9
Figure 13-8.	Automatic Docking Areas and Positions.....	13-12
Figure 13-9.	Automatic Docking Areas and Positions.....	13-13
Figure 13-10.	Automatic Docking - Sequence of Operations.....	13-14
Figure 13-11.	Advanced Menu.....	13-16
Figure 13-12.	Automatic Docking Screen	13-17
Figure 13-13.	Lock/Unlock Button	13-18
Figure 13-14.	Automatic Docking Screen	13-19
Figure 13-15.	Back Button	13-22
Figure 14-1.	PBS Dedicated Snout Holder.....	14-5
Figure 14-2.	Type DN_S Snout Components.....	14-9
Figure 14-3.	LEDs on the Snout's Tray.....	14-10
Figure 14-4.	Type DN_S Snout (lateral cut).....	14-12
Figure 14-5.	Type DN_M Snout Components.....	14-15

Figure 14-6.	LEDs on the Snout's Tray.....	14-16
Figure 14-7.	Type DN_M Snout (lateral cut).....	14-18
Figure 14-8.	Type DN_XL Snout Components.....	14-19
Figure 14-9.	Type DN_XL Snout Components - continued.....	14-20
Figure 14-10.	LEDs on the Snout.....	14-21
Figure 15-1.	Dose Counter Electronic Unit (DCEU)	15-4
Figure 15-2.	Dose Counter Electronic Unit (DCEU) - detail.....	15-5
Figure 16-1.	Emergency Hand-Pendant.....	16-1
Figure 16-2.	Joints 1 and 2 Motions	16-4
Figure 16-3.	Joint 3 Motion.....	16-5
Figure 16-4.	Emergency Hand-Pendant Details	16-6
Figure 17-1.	Position of Water Phantom on PPS (typical).....	17-3
Figure 20-1.	Pencil Beam Scanning (PBS) Delivery Technique.....	20-2
Figure 20-2.	Organization of the Prescription Data.....	20-4
Figure 20-3.	Scaling Sample: 3 Paintings.....	20-5
Figure 21-1.	BDS Equipment Usage in PBS Treatment Mode - Schematic.....	21-1
Figure 22-1.	None (No Multiple Repainting) Icon.....	22-2
Figure 22-2.	None (No Multiple Repainting) Energy/Layer Graph.....	22-2
Figure 22-3.	In-Layers Icon	22-3
Figure 22-4.	In-Layers Energy/Layer Graph.....	22-4
Figure 22-5.	Decrease in Energy Icon.....	22-5
Figure 22-6.	Decrease in Energy Energy/Layer Graph.....	22-5
Figure 22-7.	Back and Forward Icon	22-6
Figure 22-8.	Back and Forward Energy/Layer Graph (typical)	22-6
Figure 22-9.	PBS Mixed Icon.....	22-7
Figure 22-10.	PBS Mixed Energy/Layer Graph.....	22-7
Figure 23-1.	Communication Mode: Using the Batch Importer.....	23-3
Figure 24-1.	Start <i>adaPTprescribe</i> Icon.....	24-2
Figure 24-2.	<i>adaPTprescribe</i> Login Screen.....	24-3
Figure 24-3.	<i>adaPTprescribe</i> Screen.....	24-5
Figure 25-1.	Treatment Data Organization.....	25-2
Figure 26-1.	Prescription Screen.....	26-2
Figure 26-2.	Search Area	26-3
Figure 26-3.	Advanced Search Panel	26-4
Figure 26-4.	<i>adaPTprescribe</i> Arrange Options.....	26-7
Figure 26-5.	Patient Panel (typical).....	26-8
Figure 26-6.	Patient Data File Selection.....	26-9
Figure 26-7.	Patient Edit Screen	26-10
Figure 26-8.	Locked Patient.....	26-13
Figure 26-9.	Unlock Confirmation Prompt	26-14
Figure 26-10.	Create Study Screen.....	26-15
Figure 26-11.	Irradiation History.....	26-16
Figure 26-12.	Save Screen.....	26-17
Figure 26-13.	Irradiation History - Plan Selected.....	26-18
Figure 26-14.	Save Screen (DICOM format).....	26-19

Figure 26-15.	Irradiation History - Beam Selected	26-19
Figure 26-16.	Irradiation Report	26-20
Figure 26-17.	Irradiation Report	26-21
Figure 26-18.	Irradiation Report	26-22
Figure 27-1.	Study List.....	27-1
Figure 27-2.	Study Search Results.....	27-2
Figure 27-3.	Study Panel.....	27-3
Figure 28-1.	Plan List	28-1
Figure 28-2.	Plan Search Results	28-3
Figure 28-3.	Plan Panel	28-4
Figure 28-4.	Unbaselined Plan	28-5
Figure 28-5.	Consistency Check Pitch/Roll PPS Positions	28-6
Figure 28-6.	Couch Positions Check - Pop-Up Message	28-7
Figure 29-1.	Beam List Screen	29-1
Figure 29-2.	Setup Beam Display Screen	29-3
Figure 29-3.	Tolerance Table Pop-up	29-4
Figure 29-4.	Treatment Beam Display Screen	29-5
Figure 29-5.	Layer List Screen.....	29-8
Figure 29-6.	Layer Details Screen.....	29-9
Figure 29-7.	Unbaselined Beams.....	29-11
Figure 29-8.	Beam Baseline Confirmation	29-12
Figure 29-9.	MU Override Confirmation	29-12
Figure 29-10.	Beam Baseline Notification.....	29-13
Figure 30-1.	Treatment Machine Field.....	30-4
Figure 30-2.	Plan Display Screen	30-5
Figure 30-3.	Notification Message.....	30-6
Figure 30-4.	Layer Editing Screen	30-7
Figure 30-5.	Layer Edit Menu	30-9
Figure 30-6.	Input Layer Information Dialogue	30-10
Figure 30-7.	Input Layer Information Dialogue	30-11
Figure 30-8.	Spot Edit Menu.....	30-12
Figure 30-9.	Input Spot Information Dialogue.....	30-14
Figure 30-10.	Input Spot Information Dialogue.....	30-15
Figure 30-11.	Import PLD File.....	30-16
Figure 30-12.	PLD File	30-17
Figure 31-1.	Treatment Flow - Standalone Mode	31-2
Figure 31-2.	adaPTdeliver Activities	31-4
Figure 31-3.	Start adaPTdeliver Icon	31-5
Figure 31-4.	adaPTdeliver Logo Screen	31-5
Figure 31-5.	adaPTdeliver Login Screen	31-7
Figure 31-6.	adaPTdeliver - Login Error.....	31-8
Figure 31-7.	Typical adaPTdeliver Screen	31-9
Figure 31-8.	adaPTdeliver - Typical Error Message.....	31-11
Figure 31-9.	Session Definition Screen.....	31-12
Figure 31-10.	Find Criteria and Patient List.....	31-13

Figure 31-11.	List Area.....	31-14
Figure 32-1.	Mode Indication (OIS/Standalone) on adaPTdeliver Screens.....	32-1
Figure 32-2.	Treatment Flow - Standalone Mode	32-3
Figure 33-1.	Quick Selection Options	33-3
Figure 33-2.	Patient, Study, and Plan Information	33-5
Figure 33-3.	Beam Information - Pencil Beam Scanning	33-7
Figure 33-4.	Maximum Field Size	33-8
Figure 33-5.	Layer Information.....	33-11
Figure 33-6.	Layer Information - details	33-13
Figure 34-1.	Beam Selection Confirmation Prompt.....	34-2
Figure 34-2.	Beam Selection Screen	34-3
Figure 35-1.	Equipment Preparation Screen.....	35-2
Figure 35-2.	PMS Interface Panel.....	35-5
Figure 35-3.	Beam Correction Screen.....	35-6
Figure 35-4.	Equipment Preparation Screen.....	35-7
Figure 35-5.	Setup Beam - Completed indication.....	35-7
Figure 35-6.	Equipment Preparation Screen.....	35-9
Figure 35-7.	PBS Dedicated Nozzle Panel	35-11
Figure 35-8.	Nozzle Panel	35-13
Figure 35-9.	PBS Dedicated Nozzle Panel.....	35-14
Figure 35-10.	PBS Dedicated Nozzle Panel	35-15
Figure 35-11.	PMS Interface Panel.....	35-17
Figure 35-12.	Beam Correction Screen.....	35-21
Figure 35-13.	PMS Interface Panel.....	35-22
Figure 35-14.	Beam Panel.....	35-22
Figure 35-15.	Beam Preparation Failure Message.....	35-24
Figure 35-16.	Beam Panel.....	35-25
Figure 35-17.	Room Interlocks Panel - Not Ready.....	35-26
Figure 35-18.	Room Interlocks Panel - Ready.....	35-27
Figure 35-19.	Equipment Preparation Screen.....	35-27
Figure 36-1.	Treatment Screen.....	36-2
Figure 36-2.	Treatment Screen - Actions Panel	36-3
Figure 36-3.	Treatment Screen - Dosimetry Panel (typical)	36-4
Figure 36-4.	Treatment Screen - Dosimetry Panel - Irradiating screen (typical)....	36-5
Figure 36-5.	Treatment Screen - Monitor Panel.....	36-7
Figure 36-6.	Monitor Panel - Operator Logs	36-8
Figure 36-7.	System Start/Resume Tab.....	36-8
Figure 36-8.	Beam Line Checks Tab.....	36-9
Figure 36-9.	Nozzle Cyclic Checks Tab	36-11
Figure 36-10.	TSS Interlocks Tab.....	36-12
Figure 36-11.	Positioning System Status Tab.....	36-13
Figure 37-1.	Irradiation Screen: Irradiating	37-2
Figure 37-2.	Partial Delivery - System Message.....	37-3
Figure 38-1.	Mode Indication (OIS/Standalone) on adaPTdeliver Screens.....	38-1
Figure 39-1.	Resuming from Partial Treatments.....	39-5

Figure 39-2.	Recovery after Termination by Therapist - Warning message.....	39-6
Figure 39-3.	Resuming irradiation - Standalone mode: Warning messages	39-7
Figure 39-4.	Recovery after termination by PTS - Warning message	39-8
Figure 39-5.	Recovery after termination by PTS - Automatic recovery process (online)	39-9
Figure 39-6.	Recovery after termination by PTS - Automatic data recovery information (online).....	39-10
Figure 39-7.	Recovery after termination by PTS - Retrying automatic recovery process (online)	39-11
Figure 39-8.	Recovery after termination by PTS - Manual data recovery information (online).....	39-12
Figure 39-9.	Recovery after termination by PTS - Manual recovery process (online)	39-13
Figure 39-10.	Recovery after termination by PTS - Recovery from DCEU values	39-14
Figure 39-11.	Confirmation to the use of simulated data for resuming irradiation.....	39-14
Figure 39-12.	Recovery after termination by PTS - Offline recovery	39-16
Figure 39-13.	Recovery after termination by PTS - Automatic data recovery information (offline)	39-17
Figure 39-14.	Recovery after termination by adaPTdeliver - Manual data recovery message (offline)	39-18
Figure 39-15.	Recovery after termination by PTS - Manual data recovery information (offline)	39-18
Figure 39-16.	Recovery after termination by PTS - Manual recovery process (offline).....	39-19
Figure 39-17.	Recovery after termination by PTS - Recovery from DCEU values	39-20
Figure 39-18.	Confirmation to the use of simulated data for resuming irradiation.....	39-21
Figure 39-19.	Resuming irradiation after partial treatment	39-22
Figure 39-20.	Confirmation to the use of simulated data for resuming irradiation	39-23
Figure 39-21.	Resuming irradiation after partial treatment in Standalone mode ..	39-24
Figure 39-22.	Resuming irradiation	39-25
Figure 39-23.	Resuming irradiation after partial treatment	39-25
Figure 39-24.	Confirmation to the use of simulated data for resuming irradiation.....	39-26
Figure 39-25.	Resuming irradiation - Partial treatment records found	39-27
Figure 39-26.	Resuming irradiation after partial treatment	39-28
Figure 39-27.	Confirmation to the use of simulated data for resuming irradiation.....	39-29
Figure 40-1.	Appointment Selection Screen.....	40-1
Figure 40-2.	Consistency Check Pitch/Roll PPS Positions	40-2
Figure 40-3.	Couch Positions Check - Pop-Up Message	40-3

Figure 40-4.	Beam Selection Screen	40-4
Figure 41-1.	Resuming from Partial Treatments.....	41-4
Figure 41-2.	Recovery after Termination by Therapist - Warning message.....	41-5
Figure 41-3.	Recovery after termination by PTS - Warning message	41-6
Figure 41-4.	Recovery after termination by PTS - Automatic recovery process (online)	41-7
Figure 41-5.	Recovery after termination by PTS - Automatic data recovery information (online).....	41-8
Figure 41-6.	Recovery after termination by PTS - Retrying automatic recovery process (online)	41-9
Figure 41-7.	Recovery after termination by PTS - Manual data recovery information (online).....	41-10
Figure 41-8.	Recovery after termination by PTS - Manual recovery process (online).....	41-11
Figure 41-9.	Recovery after termination by PTS - Recovery from DCEU values	41-12
Figure 41-10.	Confirmation to the use of simulated data for resuming irradiation.....	41-12
Figure 41-11.	Recovery after termination by PTS - Offline recovery	41-14
Figure 41-12.	Recovery after termination by PTS - Automatic data recovery information (offline)	41-15
Figure 41-13.	Recovery after termination by adaPTdeliver - Manual data recovery message (offline).....	41-16
Figure 41-14.	Recovery after termination by PTS - Manual data recovery information (offline).....	41-16
Figure 41-15.	Recovery after termination by PTS - Manual recovery process (offline).....	41-17
Figure 41-16.	Recovery after termination by PTS - Recovery from DCEU values	41-18
Figure 41-17.	Confirmation to the use of simulated data for resuming irradiation.....	41-19
Figure 41-18.	Resuming irradiation after partial treatment.....	41-20
Figure 41-19.	Confirmation to the use of simulated data for resuming irradiation.....	41-21
Figure 41-20.	Resuming irradiation after partial treatment.....	41-22
Figure 41-21.	Confirmation to the use of simulated data for resuming irradiation.....	41-23
Figure 41-22.	Irradiation Screen: Irradiation Complete (typical)	41-25
Figure 42-1.	Report List Screen.....	42-2
Figure 42-2.	Irradiation Report Screen.....	42-4
Figure 42-3.	DICOM Export Screen.....	42-5
Figure 42-4.	DICOM File List.....	42-5
Figure 43-1.	adaPTdeliver Login Screen	43-2
Figure 43-2.	adaPT <i>deliver</i> in Physics Mode	43-3
Figure 43-3.	Physics Mode Acknowledgment Message	43-4

Figure 43-4.	Session Definition Screen - Physics Mode	43-5
Figure 43-5.	Pristine Beam Tool - Beam Settings	43-7
Figure 43-6.	Pristine Beam Tool - BEAM SETTINGS SCREEN	43-8
Figure 43-7.	Pristine Beam Tool - Preparation Screen	43-9
Figure 43-8.	Pristine Beam Tool - Irradiation Screen.....	43-10
Figure 43-9.	Beam Selection Screen	43-11
Figure 43-10.	Equipment Preparation Screen	43-12
Figure 43-11.	PMS Interface Panel	43-13
Figure 43-12.	PMS Interface Panel, with Blocking Selection.....	43-14
Figure 43-13.	Room Interlocks Panel.....	43-14
Figure 43-14.	Treatment Screen	43-16
Figure 43-15.	Treatment Screen	43-17
Figure 46-1.	Setup Position (GTR, lateral view)	46-3
Figure 46-2.	Setup Position (GTR, top view).....	46-4
Figure 46-3.	Treatment Position (GTR, lateral view).....	46-6
Figure 46-4.	Treatment Position (GTR, top view).....	46-7
Figure 46-5.	PPS icon of the wireless hand-pendant GUI screen	46-10
Figure 46-6.	Tare section of the wireless hand-pendant GUI screen.....	46-11
Figure 46-7.	Automatic weight check - Positioner screen.....	46-14
Figure 46-8.	Automatic weight check - Retract imager	46-15
Figure 46-9.	Automatic weight check - Move Gantry	46-16
Figure 46-10.	Automatic weight check - Move PPS	46-17
Figure 46-11.	Automatic weight check - Perform weight check.....	46-18
Figure 47-1.	AdaPTinsight Login	47-2
Figure 47-2.	AdaPTinsight WORKFLOW SELECTION SCREEN	47-3
Figure 47-3.	Power Switch for X-ray Generators	47-4
Figure 47-4.	X-ray Console.....	47-4
Figure 47-5.	kV/kV Single Source Workflow.....	47-7
Figure 47-6.	X-ray Console Hand-switch	47-7
Figure 47-7.	Correction	47-11
Figure 48-1.	UTEU Rack.....	48-4
Figure 48-2.	Universal Triggering Electronic Unit (UTEU) Module	48-8
Figure 48-3.	Gating Prescription - No gating input selected	48-10
Figure 48-4.	Gating Prescription - Gating input selected for setup beam	48-11
Figure 48-5.	Gating Prescription - Gating input selected for treatment beam ...	48-12
Figure 48-6.	Gating Prescription - User override for Gating YES and no input selected for treatment beam.....	48-13
Figure 48-7.	Gating Prescription - Gating YES and no input selected for treatment beam.....	48-14
Figure 48-8.	Gating Prescription in Physics mode - Gating YES and no input selected for treatment beam.....	48-15
Figure 48-9.	Gating Interface Visual Checks	48-18
Figure 48-10.	UBTI, in Pencil Beam Scanning Treatment Mode	48-20
Figure A-1.	PBS Dedicated Nozzle	A-5
Figure A-2.	PBS Dedicated Snout Holder.....	A-9

Figure A-1.	adaPTdeliver: Dosimetry Manager Button.....	A-2
Figure A-2.	Dosimetry Manager Main Display	A-3
Figure A-3.	Dosimetry Manager: Entering credentials for confirmation.....	A-4
Figure A-4.	Dosimetry Manager: Entering Temperature and Pressure Values	A-4
Figure A-5.	Dosimetry Manager: Entering Dose Correction Factor.....	A-5
Figure A-6.	Dosimetry Manager: Determining the Minimum Allowed MU.....	A-6
Figure A-7.	Dosimetry Manager: Viewing the History Log.....	A-7
Figure B-1.	User Manager Login Screen	B-1
Figure B-2.	User Manager Main Screen.....	B-2
Figure B-3.	New User Screen	B-3
Figure B-4.	User Update Screen	B-4
Figure B-5.	User Manager in a non-clinical Mode	B-5
Figure C-1.	adaPT <i>prescribe</i> Login Screen - Administration.....	C-2
Figure C-2.	Tolerance Table Management Screen.....	C-4
Figure C-3.	Tolerance Table Management Screen - with External Tables.....	C-5
Figure C-4.	Monitor Unit (MU) Clinical Range Definition Screen.....	C-6
Figure C-5.	Accessories Management Screen.....	C-7
Figure C-6.	Snout Type Legend	C-8
Figure D-1.	Location of Safety and Emergency Devices.....	D-3

DRAFT



Tables

Table 1-1.	Treatment Mode by Treatment Room.....	1-2
Table 1-2.	Treatment Mode Aspects.....	1-9
Table 1-3.	Reading Sequence by Workflow Option.....	1-11
Table 6-1.	Target Positions for a GTR.....	6-10
Table 6-2.	Manual Motions in a GTR.....	6-12
Table 7-1.	Labeled Positions for a GTR.....	7-11
Table 8-1.	Wireless Hand-Pendant App Bar and Remote Positioning Controls Bar: Common Icons.....	8-6
Table 8-2.	Wireless Hand-Pendant GUI and Remote Positioning Controls Panel- Color Legend.....	8-7
Table 8-3.	Wireless Hand-Pendant - GUI Color Legend.....	8-9
Table 8-4.	Remote Positioning Controls - Color Legend.....	8-10
Table 8-5.	Wireless Hand-Pendant and Remote Positioning Controls - Auditive Signals.....	8-10
Table 8-6.	Wireless Hand-Pendant - Vibration Signals.....	8-11
Table 9-1.	Movement Speeds.....	9-10
Table 11-1.	Movement Speeds.....	11-5
Table 11-2.	Imaging Devices Movement Options.....	11-18
Table 11-3.	CBCT Preparation - Devices Movement Options.....	11-21
Table 12-1.	Wireless Hand-Pendant App Bar and Remote Positioning Controls Bar: Lasers ON/OFF Icon.....	12-12
Table 14-1.	PBS Accessories.....	14-2
Table 26-1.	Internal/External Plans (for PBS).....	26-11
Table 30-1.	Types of Patients, Plans, and Plan Intents.....	30-1
Table 30-2.	Keyboard Shortcuts - Edit Layer Details.....	30-10
Table 30-3.	Keyboard Shortcuts - Edit Spot Details.....	30-13
Table 36-1.	Monitor Panel Icons and Colors Legend.....	36-7
Table 43-1.	Patient and Plan Availability.....	43-3
Table 43-2.	Baselining Aspects in Clinical and Physics Mode.....	43-6
Table 48-1.	Triggering in Pencil Beam Scanning.....	48-19
Table D-1.	Emergency Stop Button Data.....	D-1
Table E-1.	System messages.....	E-2

Intentionally left blank

DRAFT

About this Manual

Scope and Contents

This *Clinical User's Guide* describes and gives instructions to clinical staff for operating the Proton Therapy System (PTS). The *Clinical User's Guide* includes one volume. Clinical staff have to deal with the Treatment session only of the PTS software version 12. Treatment sessions are fully accessible at the Treatment Control Room (TCR) workstation and Treatment Room (TR) terminal. Limited functions are also available through the Treatment Planning Room (TPR) terminal.

Important	This guide is intended for properly qualified personnel who are authorized to operate the Proton Therapy System.
	

Referenced Documentation

Coordinates and Movements

Coordinates and movements described throughout this manual are based on:

- *International Standard IEC 61217:2011, Radiotherapy Equipment – Coordinates, Movement, and Scales.*

Note: Throughout the manual, International Standard IEC 61217:2011 is referred to as IEC 61217.

IBA Dosimetry Water Phantoms

For a description of and operation instructions for the **IBA Dosimetry water phantoms**, refer to any of the following documents relevant at your site:

- IBA Dosimetry WP1D User's Guide (PW-01-001-510-001 01)
- IBA Dosimetry RFA-300 with MCU User's Guide (DAA000 90015 03)
- IBA Dosimetry Blue Phantom with CU500E User's Guide (DWA000 90001 04)
- IBA Dosimetry OmniPro-Accept 6.6 User's Guide (P-07-001-510-001 04)
- IBA Dosimetry RFA-300 with CCU User's Guide (PW-04-002-510-001 03)
- IBA Dosimetry Blue Phantom with CCU User's Guide (PW-04-002-510-002 02)
- IBA Dosimetry Blue Phantom2 User's Guide (PW-04-002-510-003 01)
- IBA Dosimetry OmniPro-Accept 7.1 User's Guide (P-08-010-510-001 02)

Leoni Orion Patient Positioning System

For technical information on the Leoni Orion Patient Positioning System, refer to the following documentation set:

- Leoni Orion System - User Manual (UMN_Orion_EN)

AdaPT^{insight} Patient Position Verification System

For instructions on how to operate the IBA adaPT^{insight} hardware and software for patient position verification, refer to:

- *adaPT^{insight} System Description* manual
- *adaPT^{insight} Clinical User's Guide*

- *adaPTinsight Safety and Emergency Recommendations*
- *adaPTinsight Labels*

CIVCO Couchtop

For information on how to use the **CIVCO Couch Top**, refer to any of the following document(s) relevant for your site:

- CIVCO Couchtop Extensions - Reference Guide
- Universal Couchtop Long Extension - CIVCO Technical Data Sheet
- ProForm Head & Neck Extension - Technical Details - Extensions

DRAFT

What to Expect?

This chapter ...	Describes ...
Chapter 1	A general overview of the Proton Therapy System from a clinical point of view, and an introduction of some essential notions on coordinate systems and types of parameters.
Chapter 2	Some strict rules to obey when starting up applications in the adaPT Treatment Suite, and outlines guidelines on how to verify that the PTS is operated in a Clinical environment.
Part I - Explaining Essential Safety Aspects	
Chapter 3	List of some basic emergency procedures that must be performed in case of an irradiation hazard.
Chapter 4	List of miscellaneous safety hazards.
Part II - Using Treatment Room Equipment	
Chapter 5	An introduction to the Treatment Room equipment.
Chapter 6	Some elementary notions on patient positioning.
Chapter 7	General information on the movement of the patient positioning devices.
Chapter 8	Information on how to control equipment movement using the wireless hand-pendant and the remote positioning controls.
Chapter 9	Detailed information on how to use the wireless hand-pendant to perform movements with the patient positioning devices.
Chapter 10	Information on wireless hand-pendant troubleshooting.
Chapter 11	Detailed information on how to use the remote positioning controls to perform movements with the patient positioning devices.
Chapter 12	An overview of the alignment tools and devices, with instructions on how to manipulate the Patient Alignment Devices.
Chapter 13	An explanation on how to attach/remove a docking device to/from the PPS.
Chapter 14	Information about how to install and remove accessories onto/from the accessory drawer or PBS dedicated snout.
Chapter 15	Information on how to reset a Dose Counter Electronic Unit.
Chapter 16	A brief explanation about the manual operation of the PPS.
Chapter 17	Reference to information about how to perform energy checks using a water phantom.
Chapter 18	A list with troubleshooting information for the treatment room equipment.

This chapter ...	Describes ...
Part III - The Pencil Beam Scanning (PBS) Suite	
Chapter 19	A list of all parts and chapters of the current manual that together comprise the Pencil Beam Scanning (PBS) documentation.
Chapter 20	An overview of principles that have been applied in developing the current Pencil Beam Scanning implementation.
Chapter 21	An introduction to the Pencil Beam Scanning (PBS) Beam Delivery System (BDS) equipment.
Chapter 22	Detailed information on how the different PBS repainting types are identified and represented on screens.
Part IV - Using <i>adaPTprescribe</i>	
Chapter 23	A description of the communication between the Treatment Planning System (TPS) and the Proton Therapy System (PTS) in Batch mode.
Chapter 24	An explanation on how to launch an <i>adaPTprescribe</i> session and how to logon.
Chapter 25	A brief explanation of how <i>adaPTprescribe</i> is organized.
Chapter 26	An explanation on how to manage patients.
Chapter 27	An explanation on how to manage studies.
Chapter 28	An explanation on how to manage plans.
Chapter 29	An explanation on how to manage setup and treatment beams and how to access layer details.
Chapter 30	Specific information on how to use the QA features of <i>adaPTprescribe</i> .
Part V - Using <i>adaPTdeliver</i>	
Chapter 31	An introduction on how to get started with <i>adaPTdeliver</i> , including an explanation of the screen layout and how to retrieve a patient, study, plan, or beam.
Part VI - Using <i>adaPTdeliver</i> in Standalone Mode	
Chapter 32	An introduction on what it means to use <i>adaPTdeliver</i> in Standalone mode.
Chapter 33	An explanation on how to include one or more beams into a session.
Chapter 34	A brief explanation of how to proceed to beam selection, how to proceed with an incomplete plan, and how to select a beam.
Chapter 35	An explanation of how to prepare the PTS equipment for irradiation.
Chapter 36	An explanation on how to monitor and control a treatment.
Chapter 37	An explanation of how to start an irradiation and how to deal with an partially delivered prescribed dose.
Chapter 38	An explanation on what to do to pause, or stop an irradiation.

This chapter ...	Describes ...
Chapter 39	An explanation on resuming after a partial irradiation.
Part VII - Using adaPTdeliver in Worklist Mode	
Chapter 40	An introduction on what it means to use adaPTdeliver in OIS (DEVC mode).
Chapter 41	An explanation on resuming after a partial irradiation.
Part VIII - Browsing adaPTdeliver Reports	
Chapter 42	An explanation on how to use the reporting function in adaPTdeliver.
Part IX - adaPTdeliver in Physics Mode	
Chapter 43	A description of the difference in usage of adaPTdeliver in Physics mode, as compared with its usage in Clinical mode.
Part X - Preparing for Treatment	
Chapter 44	A summary of beam scheduling principles.
Chapter 45	A description of some procedures on how to prepare the treatment room.
Part XI - Patient Positioning and Alignment	
Chapter 46	An introduction of what patient positioning entails and a description of the different positions involved.
Chapter 47	An outline of the procedure to calculate alignment corrections using the adaPTinsight Patient Position Verification System (PPVS) application.
Chapter 48	A description of how to use the Universal Beam Triggering Interface (UBTI) when taking X-ray images or during treatment.
Chapter 49	A detailed description of the alignment procedure in the GTR.
Part XII - Monitoring an Irradiation	
Chapter 50	Here you find out how you can monitor an irradiation.

This appendix ...	Describes ...
Appendix A	The nozzle components.
Appendix B	How to use the Dosimetry Manager.
Appendix C	Information on how to configure and manage PTS roles.
Appendix D	How to manage adaPTprescribe settings (tolerance tables, MU clinical ranges, and accessories).
Appendix E	An overview of the emergency stop button locations.
Appendix F	A list of the different system, error and fault messages intended for the clinical operator

This appendix ...	Describes ...
Appendix G	A list of acronyms and abbreviations.
Appendix H	Glossary of Terms
Index	A list of keywords used throughout this manual, in alphabetical order.
Safety Decisions	A list of all safety decisions used throughout this manual, along with the relevant page numbers.
Issue Tracking System	A list of all bug solutions documented throughout this manual, along with the relevant page numbers.

DRAFT

Conventions

The following typographic conventions and visual cues are used in this guide.

Warnings

WARNING	A Warning is provided when:
	A procedure, practice, etc., may result in personal injury or loss of life if not followed properly. The personnel may be exposed to hazards when carrying out a task on the system.

Cautions

CAUTION	A Caution is provided when a procedure, practice, etc., may result in damage to the equipment if not followed properly.
	

Important Notes

Important	An Important Note is provided where a task or procedure requires emphasis or additional information essential to completion.
	

Typographic Conventions

Typeset	Refers to
Button	The name of a command button to be clicked with the mouse
SCREEN	The name of a user interface screen
< entry >	Information to be entered from the keyboard appears inside angle brackets
Label	The label of a field appearing on a screen
Message	A message (warning, error, acknowledgment, or request) from the system appearing on a screen

Illustrations

Photos, drawings, and User Interface (UI) screen representations are provided for **reference purposes only** and do not necessarily reflect the actual appearance of system hardware or software.

Troubleshooting Information





Error messages and system warnings are presented in tables throughout this guide as in the example below:

Pop-up Message	Description
Patient ID previously defined	A patient with the same Patient Identifier already exists in the database. Use a different ID.
String of maximum length (nn) expected	Too many characters have been entered into this field.

Visual Cues

The table below lists the symbols that identify the location where a task may be performed.

Symbol	Identification
	Identifies paragraphs or steps performed in the Treatment Planning Room (TPR) or on the Treatment Planning Room terminal.

Symbol	Identification
	<p>Identifies paragraphs or steps performed in the Treatment Control Room (TCR) or on the Treatment Control Room workstation.</p>
	<p>Identifies paragraphs or steps performed in the Treatment Room (TR) or on the Treatment Room terminal.</p>
	<p>Identifies paragraphs or steps performed with the hand-pendant (HP) in the Treatment Room (TR).</p>
	<p>Identifies paragraphs or steps performed by the Accelerator Operator.</p>

DRAFT



Chapter 1

Introduction



Overview

IBA Proton Therapy System (PTS) – Proteus 235 is a medical proton beam irradiation system designed to:

- Create and deliver a proton beam with an adequate energy, shape and intensity to the patient treatment location
- Deliver the designated dose to the patient's treatment site with the dose distribution defined in the patient's treatment plan.

Treatment Modes Available at the PT Center

The following treatment modes are available in the TRs:

Table 1-1. Treatment Mode by Treatment Room

TR	Treatment Modes
GTR1	PBS
GTR2	PBS

Note: Gantry Treatment Room (GTR).

Therapy Center and Proton Therapy System Building Blocks

The PTS consists of a large number of hardware elements such as the cyclotron, the beam line, the nozzle, to name but a few. The physical structure of the PTS is described in detail in *PTS System Description*.

In addition to the physical structure, it is important for you as a user of the PTS to have an understanding of the logical structure of the PTS. Major logical components of the PTS, or interfaced with the PTS, are:

- *Treatment Planning System (TPS)* (interfaced)
- *Oncology Information System (OIS - DEVC)* (interfaced)
- *Proton Therapy System (PTS) Software*
- *Patient Positioning Verification System (PPVS)*

Figure 1-1 illustrates the therapy center and PTS building blocks from a clinical point of view.

Treatment Planning System (TPS)

The **Treatment Planning System (TPS)** enables users to prepare and store all prescription data. Before starting a treatment, staff of the treatment center takes images using various imaging techniques such as X-ray imaging, CT scans, MRI, PET, etc. of that region of the patient's body where irradiation is needed.

Based on these images and scans, staff of the treatment center uses the TPS to select the beam delivery technique, determine dose distribution, and design potential patient specific devices such as blocks or range compensators.

For many tumor types, CT scans are instrumental in enabling the PPVS (e.g., *adaPTinsight*) to perform the correction vector calculation at the time of treatment. With such input material the PPVS will be able to perform an automatic image registration.

Certain tumor types, e.g., prostate tumors, require patient specific landmarks to be established as fiducial points. In these cases, a number of implants will identify specific locations on the tumor on the CT scan. At the time of treatment these locations need to be selected in the PPVS (e.g., *adaPTinsight*).

The CT scans will be instrumental in computing proper patient alignment corrections at the time of treatment.

The Treatment Planning System (TPS) is connected to the OIS via a DICOM ¹ connection, which renders the data interchangeable. The **DICOM protocol** is the de facto standard communications protocol for medical applications.

Oncology Information System (OIS)

One very efficient way of entering prescription data into the PTS software is by using an OIS. The OIS is capable of managing and communicating all patient and treatment related data, potentially coming from various systems offering diverse treatment types, such as conventional radiation therapy, proton therapy, and others. The OIS is the central repository for prescription data of all treatment types.

Various systems offering diverse treatment types, such as conventional radiation therapy, proton therapy, and others, can communicate patient and treatment related data with the OIS.

Important	It is recommended to use an Oncology Information System (OIS) to manage all patient and treatment related data.
	

Once completed in TPS, the treatment plan data is transmitted through the Dicom protocol from the TPS to the **OIS**. At treatment time, the plan is transmitted from the OIS into PTS software, each time via the DICOM interface. At the end of the treatment, a treatment record is sent back from the PTS software to the OIS; this information is recorded in the OIS.

The OIS cooperates with the PTS working in **DevC mode (Device Centric mode)**, whereby the PTS is in command of the communication with the OIS.

1. DICOM is the registered trademark of the National Electrical Manufacturers Association for its standards publications relating to digital communications of medical information.

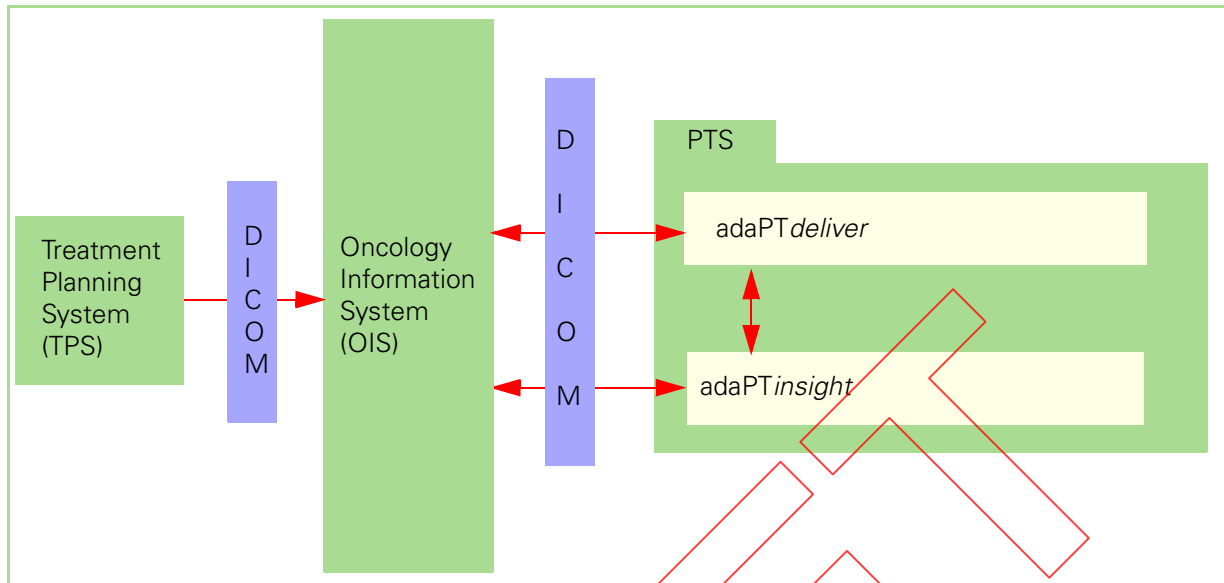

For each patient that will be treated by the PTS, patient data is received from the OIS and stored in the PTS software database. To enable proton therapy treatment, specific study and treatment plan data is also stored.

Data resident in the OIS is not only communicated to the PTS software but also to the (optional) **milling machine** that is used to make patient specific *blocks and range compensators* to be used in snouts, and to the PPVS, e.g., adaPT~~insight~~.

Proton Therapy System (PTS) Software

The PTS is controlled by a package called the PTS Software.

It is mainly composed of software components. Depending on their function in the treatment center various users have access to different options of the PTS software; some are clinical, others are administrative or more hardware oriented. It is obvious that, as a clinical user of the system, you have access to the full clinical functionality of the PTS software.

Usage With an OIS

With respect to the proton therapy treatment provided by the PTS, the **PTS software** stores and retrieves all clinical data into the dedicated software database. The PTS software is the central repository of all key information of the PTS. Communication between the OIS and the PTS happens via a DICOM^{®1} interface.

Figure 1-1 illustrates the communication between the OIS and the PTS.

Usage Without an OIS

The **PTS software** can store all clinical data into and retrieve that data from the dedicated database, which is the central repository of all key information of the PTS.

For each patient that will be treated by the PTS, patient data is stored in the PTS software database. To enable proton therapy treatment, specific treatment plan data is also stored. This patient and treatment plan data typically is created in a planning system.

For PBS, the treatment plan, which requires large amount of data, is transmitted from TPS into PTS software via the DICOM interface.

Patient Positioning Verification System (PPVS)

Data resident in TPS is communicated, with or without the use of the OIS, to the **PPVS**.

PPVS Process

At the time of treatment, the Patient Position Verification System (PPVS) (e.g., Verisuite[®], adaPT^{insight}) requests the Oncology Information System (OIS) for the required information (e.g., CT scans, DRRs, etc).

1. DICOM is the registered trademark of the National Electrical Manufacturers Association for its standards publications relating to digital communications of medical information.

The PPVS transforms the CTs into DRRs and those DRRs are automatically compared to the DRs; *adaPTinsight*, for instance, calculates the corrections using a grey level comparison algorithm.

The computed corrections must be manually entered (or electronically exchanged and confirmed) and applied from a PTS software monitor in the TR. These applied corrections subsequently must be implemented using the hand-pendant.

DRAFT

Treatment Workflow Options

Note: This section “Treatment Workflow Options” lists all workflow options that are possible using the PTS. Depending on criteria listed below, not all options may be available at your treatment center.

You can choose among different workflow options to process treatments.

Workflow Option Criteria

The options available in any given Treatment Control Room (TCR) and TR depend on:

- the chosen beam delivery technique (refer to section “Overview” on page 1-1).
- the availability (or absence) of an OIS
- the operational mode of the PTS: EMRC or DEVC

Note: Depending on the selections made at your treatment center, only a subset of all listed workflow options may be available.

DRAFT

Workflow Options

As a result, the following options can be distinguished (see Figure 1-1):

- *Option A: Using the Batch Importer and Standalone Delivery* (refer to page 1-11)
- *Option B: Full Standalone Mode* (not supported from PTS release 12.0.)
- *Option C: Using the OIS, also called 'Worklist mode'* (refer to page 1-12)

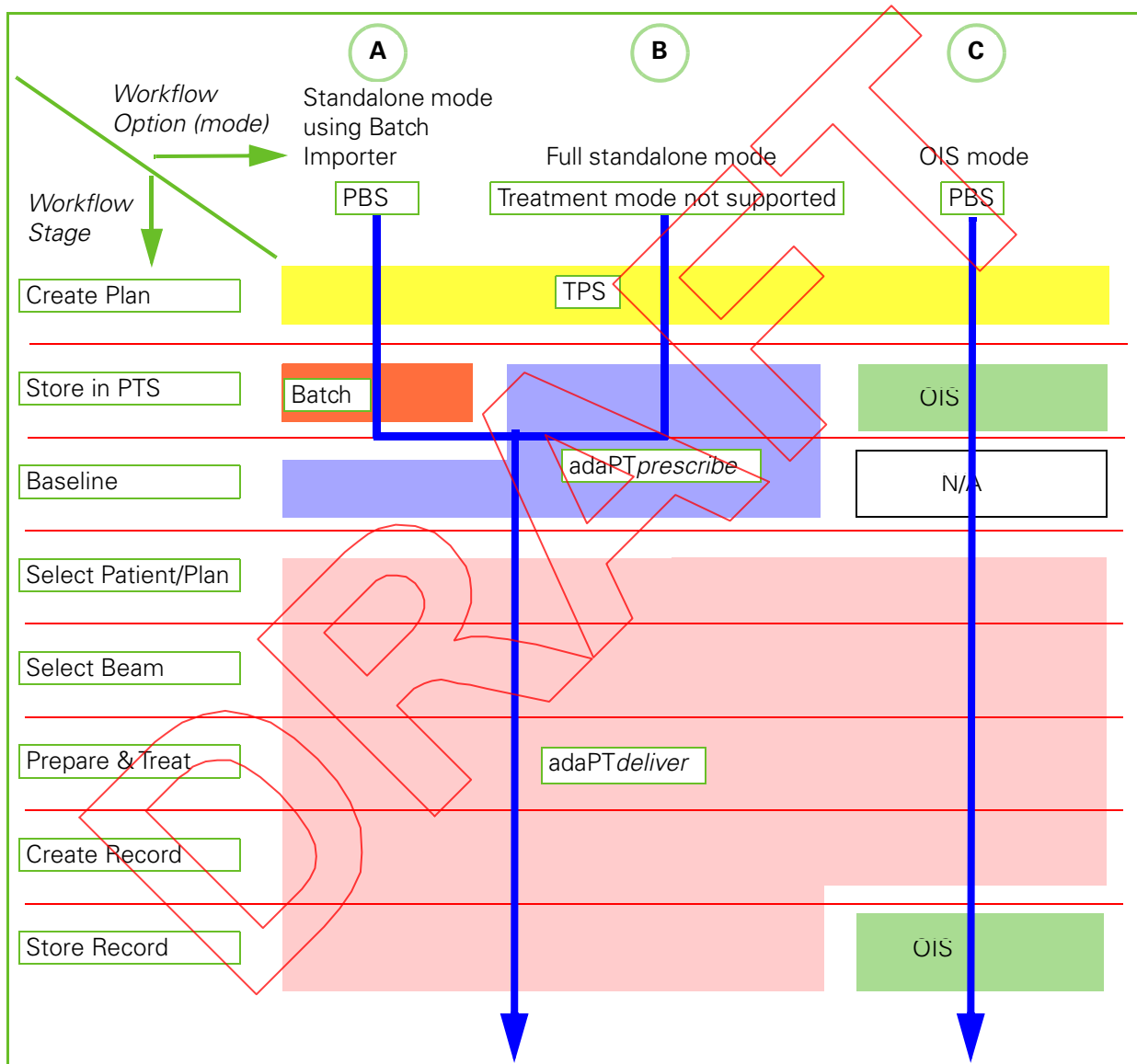

Figure 1-1. Treatment Workflow Options

Figure 1-1 illustrates the different stages of a treatment workflow, from the creation of a plan (top) up to storage of the record after irradiation (bottom), as seen by the user. All processes such as the OIS, the batch importer, etc., continually keep on running during the entire workflow.

Treatment Mode Aspects

Table 1-2 lists the preferred workflow option that can be used for each of the treatment modes, and its possible alternatives.

Note: The workflows that are validated for your treatment center are listed in the Site Delivery Note.

Table 1-2. Treatment Mode Aspects

	Option A Standalone mode using Batch Importer	Option B Full Standalone mode	Option C OIS mode
Pencil Beam Scanning (PBS)	Alternative	✘	Preferred

DRAFT

Frequency Aspect

From a different perspective, all activities can be categorized in two groups:

- to be performed **once** for the entire treatment: boxed in **green** in Figure 1-2 .
- to be performed **every day** of the treatment: boxed in **red** in Figure 1-2 .

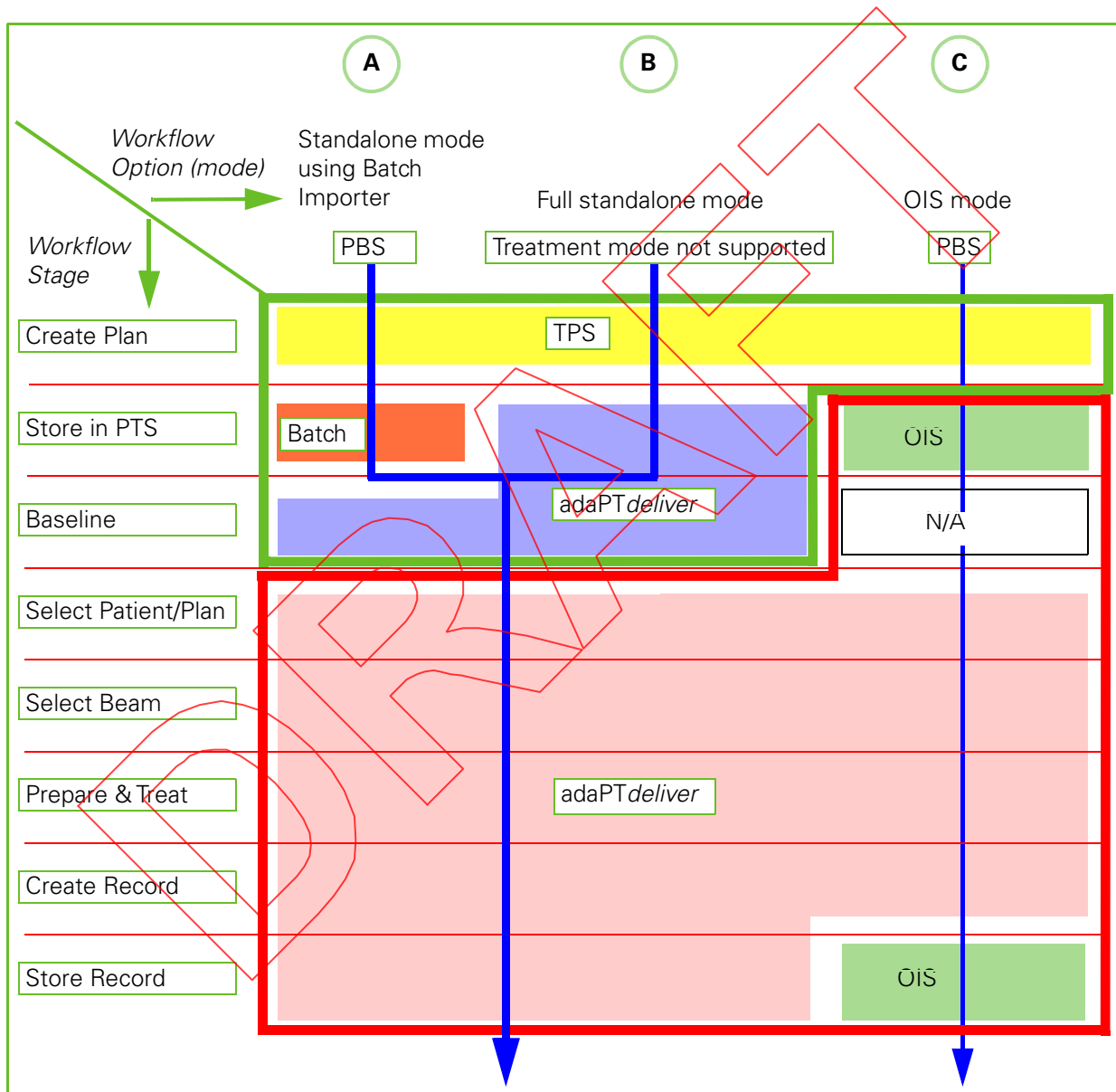

Figure 1-2. Treatment Workflow Options - Frequency Aspect

Note: Option B is not supported from PTS release 12.0.

Reading Sequence of This Manual

Your choice of treatment workflow option also decides on the chapters to read in this manual. This manual contains generic information that is not related to any specific workflow option on the one hand, and some chapters that are workflow option specific on the other. This implies that, depending on the workflow option that you wish to use, those chapters on workflow options that you do wish not to use, are not relevant to you.

Table 1-3 lists the reading sequence of the chapters, by workflow option.

Table 1-3. Reading Sequence by Workflow Option

Workflow option A	Workflow option B	Workflow option C
1 through 22		
23	N/A	
24-32		
33-39	N/A	
N/A	40-41	
42 through 50		
App A through H		
Index		
Safety Decisions		
Issue Tracking System		

Note: Generic information has been highlighted in yellow.

Option A: Using the Batch Importer and Standalone Delivery

This workflow option can be used for the SS, DS, US, and PBS treatment modes.

The treatment plan is created using the Treatment Planning System (TPS) and then imported into the PTS using the Batch Importer.

Baselining is performed using *adaPTprescribe*.

All subsequent activities, i.e., patient and plan selection, selection of the beam, preparation and treatment of the patient, creation of the irradiation record, and local storage of that record in the PTS software database are performed using *adaPTdeliver*.

Option B: Full Standalone Mode

Note: This option is not supported from PTS release 12.0.

The treatment plan data is created using a Treatment Planning System (TPS). For **eye treatment**, this must be an eye Treatment Planning System (TPS) such as the **Eclipse Ocular Proton Planning** application (from Varian®).

Subsequently, and this is the meaning of **'Full'** standalone, the user manually encodes the patient, plan, and beam data into the PTS; definition of the plan; baselining in PTS is performed using *adaPTprescribe*.

All subsequent activities, i.e., patient and plan selection, selection of the beam, preparation and treatment of the patient, creation of the irradiation record, and local storage of that record in the PTS software database are performed using *adaPTdeliver*.

Option C: Using the OIS

This workflow option can be used for the SS, DS, US, and PBS treatment modes.

The treatment plan is created using the Treatment Planning System (TPS) and then communicated to the OIS.

The plan is stored in the OIS.

Patient and plan selection, selection of the beam, and preparation and treatment of the patient is performed using *adaPTdeliver*.

The session record is created by *adaPTdeliver* and then communicated to the OIS for storage.

Patient Related Parameters

Patient related parameters within the PTS allow for the configuration of an entire course of treatment for a particular patient. This section gives a brief description of the different types of parameters associated with a patient:

- Prescribed parameters
- Received parameters
- Delivered parameters

Prescribed Parameters

Prescribed parameters are a selected set of values needed by the PTS equipment to deliver an irradiation and are prescribed by the Radiation Oncologist.

Prescribed parameters are expressed both as Prescribed *Clinical parameters* and Prescribed *Equipment Settings*. The clinical staff enters the clinical parameters. The prescribed equipment settings are the result of translation algorithms on the prescribed clinical parameters.

Received versus Delivered Parameters

When beam starts, the system begins logging parameters. Logged parameters fall into two categories, *received* and *delivered*. The difference is the way that they are stored:

- Received parameters are recorded along the irradiation and include relevant equipment feedbacks.
- Delivered parameters are stored in the database at the end of irradiation and include:
 - Dose counts
 - Patient Positioning Device (PPD) settings
 - Date, time at beginning and end of beam, and user logged on to the TCR.

Operating *adaPTdeliver* in Clinical Mode or in Physics Mode

You can use *adaPTdeliver* in two modes:

- **Clinical mode:** purpose of Clinical mode is to perform clinical operations aimed at irradiating patients. Almost all the information in this manual is focused on Clinical mode.
- **Physics mode:** Purpose of Physics mode is to perform Quality Assurance (QA) and calibration activities. No actual patient irradiations are involved at all.

WARNING



In Physics mode, patient treatment is absolutely forbidden at all times.

Note: Make sure that you have obtained the right to use Physics mode. For detailed information on the User Manager, refer to **Appendix B**, "Managing PTS Users."

Because no actual patients are involved in this mode, Physics mode is available in Standalone mode only, not in OIS mode. You can, however, make use of information that resides in the OIS.

For detailed information on the use of *adaPTdeliver* that is generic to both Clinical mode and Physics mode, refer to **Part V**, “*Using adaPTdeliver*”.

For detailed information on the use of *adaPTdeliver* specifically in Physics mode, refer to **Part IX**, “*adaPTdeliver in Physics Mode*”.

Using Information From the OIS

You can select a patient, study, plan, or beam using an OIS connection but the OIS is not informed about any such retrieval, nor does the PTS send any Physics mode related information to the OIS.

When the OIS sends a plan in Physics mode, the PTS issues an error message to the OIS that the plan is erroneous. In this way, the OIS is prevented from storing any subsequent data. The plan, however, is used in PTS.

The steps to transfer a plan from the OIS to the PTS are identical in Physics mode and Clinical mode. No special or extra actions are required.

DRAFT

Using QA Features of adaPTprescribe

Login in adaPT*prescribe* is either using **Prescription** or **Administration**.

For detailed information on the use of adaPT*prescribe*, refer to **Part IV**, "Using adaPT*prescribe*".

For detailed information on the use of the QA features of adaPT*prescribe*, refer to Chapter 30, "Using QA Features of adaPT*prescribe*".

DRAFT

Intentionally left blank

DRAFT

Chapter 2

Starting Up Applications in the adaPT Treatment Suite

.....

Startup Operations

At startup in the Main Control Room (MCR) and TCR, the PTS performs automated checks on the versions of critical software running in Control Units (CU) and Electronic Units (EU) inside the system against the expected versions of these software packages.

In case of a mismatch a pop-up message appears and the PTS blocks startup.

WARNING



In case you opt to bypass the software version checks, i.e., you click OK to acknowledge that you want to continue, knowing that such version discrepancies exist, be aware that any formal activity (e.g., treatment, patient Quality Assurance (QA), clinical acceptance, etc.) is forbidden.

Clinical and Non-clinical Environment

WARNING



Any formal activity (e.g., treatment, patient Quality Assurance (QA), clinical acceptance, etc.) performed out of the Clinical environment is forbidden. The Proton Therapy System cannot be guaranteed to satisfy safety and performance criteria needed for such activities out of the Clinical environment.

It is imperative that all **clinically related activities** are performed within the Clinical environment. Therefore, this chapter provides some strict rules to obey, and outlines guidelines on how to verify that the PTS is operated in a Clinical environment, or to detect otherwise.

Important	If, for any reason, you encounter a system message that reads '<i>Not using clinical database</i>', do not proceed with any clinical workflow. Stop using the system and contact IBA.
	

Beginning Clinical Operations

Make sure to comply with the warning messages in this section whenever clinical operations get started.

WARNING	Before starting daily clinically related activities, the Proton Therapy System must be restarted completely through the startup procedure.
	

WARNING	When starting up the Proton Therapy System, and before starting clinically related operations, do check and log the software versions running on the computer at startup. In case of unexpected change, checksum issue, or warning of the system's runtime, you must suspend all clinically related activities and contact IBA personnel as the Proton Therapy System cannot be guaranteed to satisfy safety and performance characteristics.
	

Verifying the Global Checksum

A checksum mechanism is in place to detect possible changes or corruptions of software configuration files and/or runtime executables. The Global Checksum enables users to easily monitor unexpected changes in the software. The Global Checksum should only change in case of a new installation of a PTS version or configuration.

Each morning, and before beginning clinically related operations, it is recommended to verify that the content of the 'About TCS' icon stored in the MCR log book by IBA operators is not unexpectedly modified compared to the previous day of clinical use.

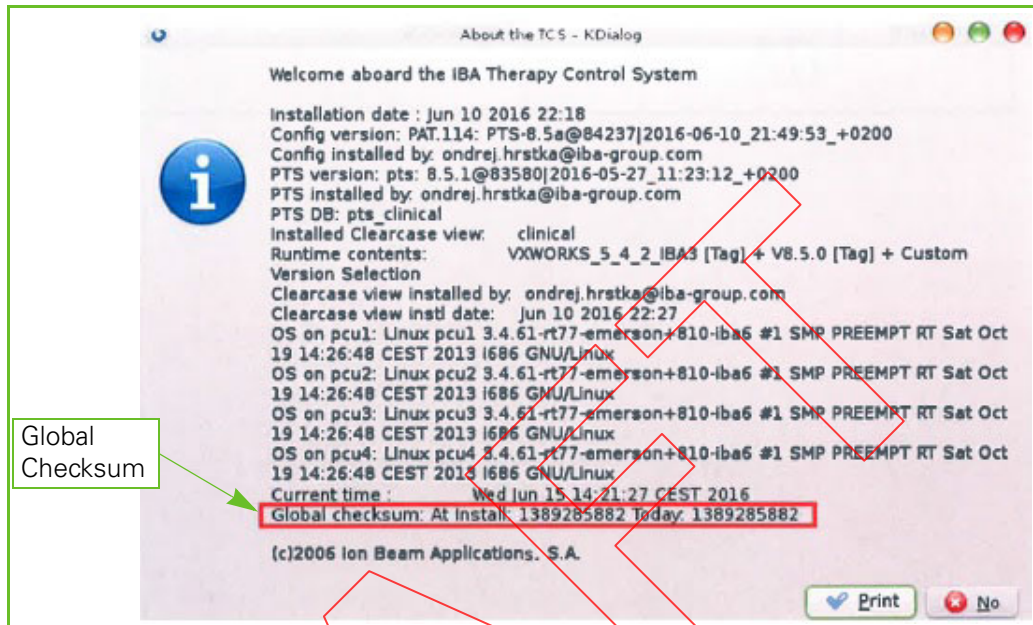



Figure 2-1. 'About TCS' Icon Content

WARNING		In case of any unexpected change of the Global Checksum line compared to the line present in the 'About TCS' content of the previous day of clinical use, you must suspend all clinically related activities. The safety and essential performances of the Proton Therapy System cannot be guaranteed. In this case, you must contact IBA immediately for support.

The Clinical Environment

WARNING		The Clinical environment is the only suitable environment for clinically related activities.
----------------	---	--

WARNING

Any formal activity (e.g., treatment, patient Quality Assurance (QA), clinical acceptance, etc.) performed out of the Clinical environment is forbidden. The Proton Therapy System cannot be guaranteed to satisfy safety and performance criteria needed for such activities out of the Clinical environment.

Characteristics of the Clinical Environment

Each of the applications in the *adaPTsuite*, i.e., *adaPTprescribe*, *adaPTinsight*, and *adaPTdeliver*, requires you to perform a dedicated login.

When the applications in the *adaPTsuite* have been validated for clinical use, the background color of the header is **black**. This is indicative of a Clinical environment.

Whenever the applications in the *adaPTsuite* have **not** been validated for clinical use, the background color of the header is **red**. This is indicative of a non-Clinical environment. In these circumstances, the applications are NOT for clinical use. The applications must not be used for treating patients.

Note: *Within the Clinical environment, the different adaPTsuite applications offer different log-in modes. AdaPTdeliver in particular offers a Clinical and a Physics mode. AdaPTdeliver's Physics mode is to be used for QA purposes, calibration and research activities only.*

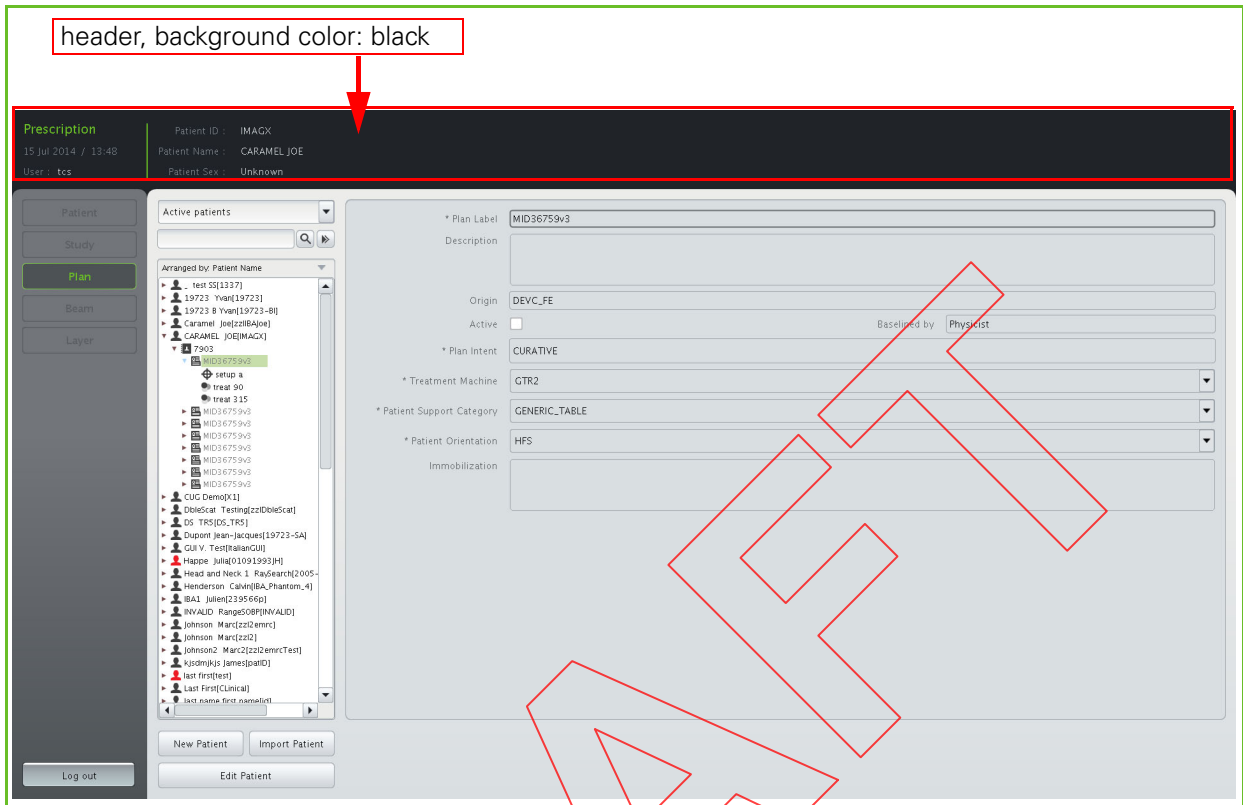

Figure 2-2. adaPTprescribe in Clinical Mode

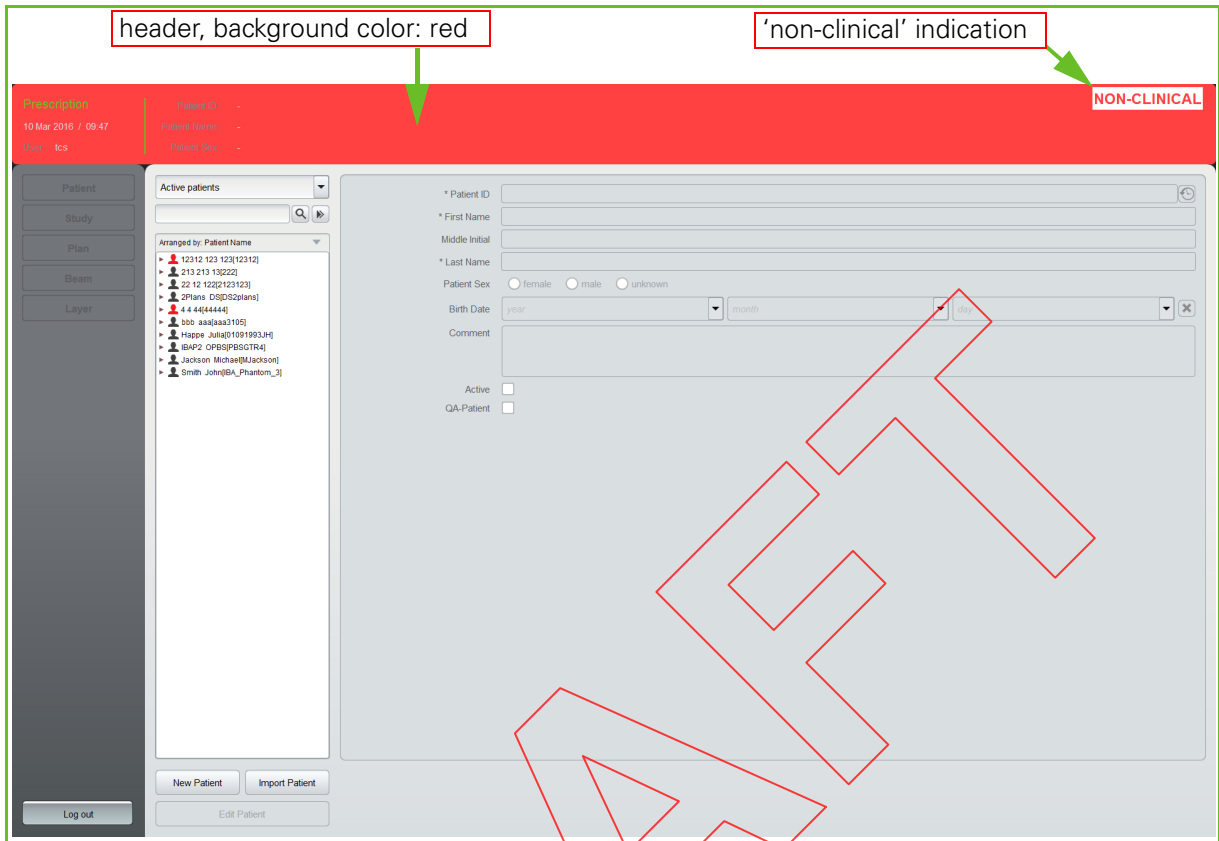

Figure 2-3. adaPT prescribe in a non-clinical Mode

For information regarding adaPT deliver, refer to Chapter 31.



Part I
Explaining Essential Safety Aspects

DRAFT

DRAFT

Chapter 3

Emergency Procedures in Case of Irradiation Hazard

.....

WARNING



In case the system does not behave as expected when trying to stop an operation (if releasing the motion enable button does not stop a movement or if the beam pause function does not stop the beam as requested), push an emergency stop button.

IBA has taken precautions to make the PTS as failsafe as possible. However, conditions may exist that cannot be foreseen, either due to human error or because of equipment failure. Any such condition may lead to irradiation incidents or near irradiation incidents.

IBA wants all staff on site to be informed about such incidents as well as be prepared and trained to face such incidents. Therefore, the following irradiation emergency procedures have been developed.

We strongly advise you to communicate these procedures to all members of your staff, and provide training on these procedures regularly.

Emergency procedures have been developed for the following situations:

- *A Patient is in the Treatment Room and the Beam Fails to Stop when Requested*
- *Staff are Present in a Secured Area*
- *To be Present in a Location Susceptible to Irradiation While Beam is On or Room is Secured*

A Patient is in the Treatment Room and the Beam Fails to Stop when Requested

The following situations can be distinguished whereby a patient can be subjected to a dose higher than requested:

- The preset dose has been reached and the beam fails to shut off automatically
- A Radiation Therapy Technologist (RTT) requests the beam to pause and the beam fails to pause
- A RTT requests the beam to stop and the beam fails to stop

The Preset Dose Has Been Reached and the Beam Fails to Shut off Automatically

The normal end to a treatment is triggered by the dose count from ionization chamber 2 (IC2) to the Therapy Control System (TCS). The irradiation normally stops when the dose read by IC2 equals the required dose.

In the **PBS** beam delivery technique the setpoint of each magnet is progressively modified for each map (i.e., each layer) to reach the setpoint of the first spot to irradiate; that setpoint is kept constant until the spot is fully irradiated and then it is adapted to reach the setpoint for the next spot, until the last spot is irradiated. All the setpoints are calculated by Scanalgo and are then applied by the scanning controller.

If treatment is not intended to be resumed, a RTT also has the option to stop an irradiation by clicking **Pause** followed by **Stop** from the IRRADIATION SCREEN.

A Radiation Therapy Technologist (RTT) Requests the Beam to Pause (or Stop) and the Beam Fails to Pause (or Stop)

A pause interrupts the beam and prevents it from entering the TR.

If, as a RTT, you interrupt the irradiation from the TCR by clicking **Pause** from the IRRADIATION SCREEN and the irradiation does not pause, immediately perform the procedure that follows.

Irradiation Emergency Procedure

If the beam does not pause (or stop):

- when the preset dose count has been reached
- when the user requires it

- when paused

Immediately perform the following procedure:

1. Press the emergency stop button in the TCR.

Note: The emergency stop button can be a global or local emergency stop, depending on the configuration of your PT center.

2. Turn the TCR master key switch off.
3. Open the doors of the TR.

If this procedure fails to stop the irradiation, contact the MCR immediately and request the accelerator operator to shut off the RF.

Important	In any case, immediately contact the local radiation safety department and inform them with full details of the radiation incident.
	

The TR must not be used for treatments until the cause of the incident has been fully established and remedied.

The irradiation should only be resumed after the cause of the incident has been fully investigated and remedied.

Staff are Present in a Secured Area

Beam should only be **On** when the securable areas (i.e., all locations where irradiation hazards are present: cyclotron vault, beam transportation vault, GTR pit, TRs and technical rooms adjacent to TRs) have been properly searched and secured. The securable areas are listed in **Appendix D** "Emergency Stop Button Locations". This is applicable to all securable areas required for sending beam to a given TR.

Note: The MCR and TCRs are not securable areas.

WARNING	Closure of a door of a securable area is part of a search procedure.
	Whenever you close a door of a securable area, make sure that no other person is performing the search procedure for the same securable area.

In the event that anyone is detected (using video monitors or any other detection system) to be present in a secured area when beam is **On**, or when you are about to produce beam, perform the procedure that follows.

Irradiation Emergency Procedure

Immediately perform the following procedure:

1. Turn the MCR master key switch off.
2. Verify that beam is **Off** and cannot be restarted: confirm BF is **Off**, and remove and take possession of the master key.
3. Go to that secured area.
4. Break the search.
5. Contact that person.
6. Evacuate that person from the area.
7. Inform your supervisor of the incident.

Important



If there is any possibility that a person was exposed to ionizing radiation, contact the local radiation safety department and inform them with full details of the radiation incident.

8. If required, update your local safety procedure.

To be Present in a Location Susceptible to Irradiation While Beam is On or Room is Secured

In the unlikely event that you find yourself in a secured area before beam is **On**, or while beam is **On**, perform the procedure that follows.

Irradiation Emergency Procedure

Immediately perform the following procedure:

1. Press the emergency stop button nearest to you (see **Appendix D** "Emergency Stop Button Locations").
2. Proceed to the nearest exit in the secured area.
3. Inform the MCR operator immediately.

Important



Contact the local radiation safety department and inform them with full details of the radiation incident.

4. Investigate the cause of the incident.
5. If required, update your local safety procedure.

Intentionally left blank

DRAFT

Chapter 4 Miscellaneous Safety Hazards

.....

Cleaning, a Basic Safety Requirement

CAUTION	<p>The Proton Therapy System (PTS) parts which are not in direct contact with the patient can be cleaned with the following products:</p> <ul style="list-style-type: none"> * Isopropyl Alcohol - Concentration up to 70 % * Ethyl Alcohol - Concentration up to 90 % * Bleach solution - up to 100 ppm active Chlorine * Formaldehyde - up to 35 % * Didecyldimethylammonium chloride - up to 3 mg/g <p>The following exclusions apply:</p> <ul style="list-style-type: none"> * Couch: you must refer strictly to the user instructions of the couch. * Robot Patient Positioning System (PPS): you should avoid bleach and other chlorine solutions for Robot PPS cleaning. <p>During the cleaning process please ensure to:</p> <ul style="list-style-type: none"> * Avoid water to penetrate inside equipment parts. * Avoid using sprays such as the cleaning product penetrates parts.
----------------	---

Precautionary Measures

- Avoid all infiltration of liquids that are likely to cause operating problems, especially on the hand-pendant, PPS, snout.
- During cleaning and disinfection, use protective gloves.

Keyboard and Mouse Requirements

WARNING	Do not modify the keyboard or mouse of the Proton Therapy System (PTS). The application of wireless or battery powered devices is not allowed.
	

Usage of Tools or Parts in a Treatment Room

WARNING	It is strictly forbidden to ever place any objects (tools, parts, etc) on top or inside moving devices such as the nozzle, or the gantry. Falling tools or parts can injure patients or staff.
	Take inventory of the tools or parts after using them in a treatment room.

WARNING	Make sure that all tools and maintenance equipment have been properly removed from moving parts and safely stored prior to the operation of the system.
	

Dealing With an Emergency Situation

WARNING	In case the system does not behave as expected when trying to stop an operation (if releasing the motion enable button does not stop a movement or if the beam pause function does not stop the beam as requested), push an emergency stop button.
	

WARNING	In case of an emergency situation (e.g., fire, earthquake, flooding, etc.) or before an emergency response, push emergency stop button from a safe position.
	

Gantry Rolling Floor Precautions

Gantry treatment rooms that are equipped with the Gantry Rolling Floor enable you to enter the patient enclosure. Whenever you consider entering the patient enclosure, be aware of the warning texts below.

WARNING	Do not stand or move into the patient enclosure or the gantry rolling floor when the gantry is rotating.
	

WARNING	Do not remove any objects from the patient enclosure before rotating the gantry. Check that no objects are present on the Gantry Rolling Floor before gantry rotation.
	

WARNING	Watch your step when entering the patient enclosure. When the nozzle is positioned between approximately 135° and 225°, there is a slight height difference between the treatment room floor and the gantry rolling floor.
	

Pinching Hazard

WARNING	Do not touch any of the panels of the Gantry Rolling Floor when the gantry is rotating. Fingers may get pinched when you touch the space between the panels while the gantry is rotating.
	

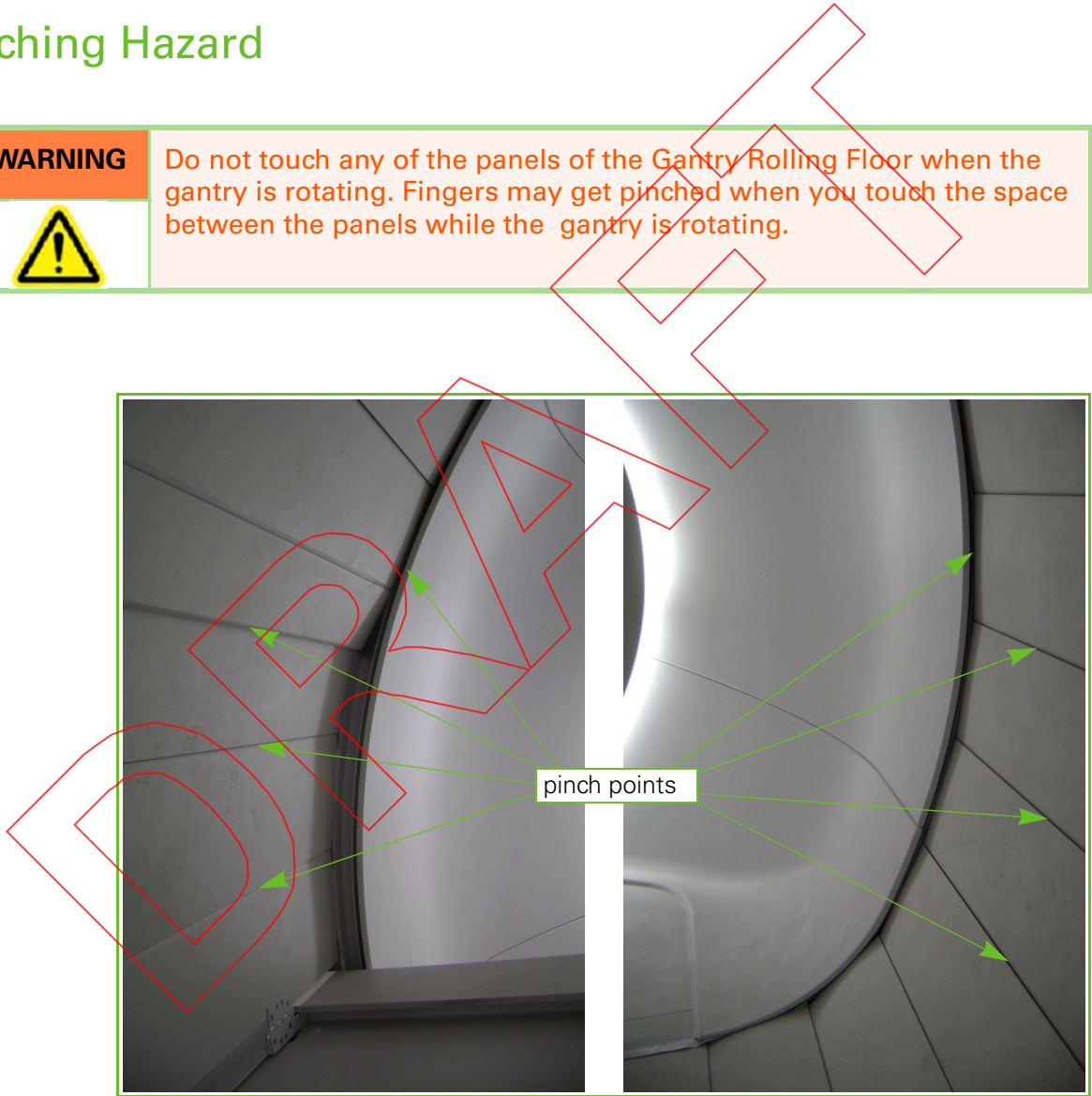



Figure 4-1. Pinching Hazards on Gantry Rolling Floor Panels

General Pinching Hazards

WARNING	Do not touch any of the components of devices such as the Gantry Rolling Floor, the Patient Positioning System (PPS), the Accessory Drawer, the snout. Fingers may get pinched.
	

DRAFT

Intentionally left blank

DRAFT

Magnetic Field Hazard

The indicative values of electromagnetic fields around the nozzle are defined according to tests established against ICNIRP #74:1998, IEEE C95.1:2005 and IEEE C93.3:2002 series). These values are of importance to evaluate the impact on implantable medical devices for patients and anyone else carrying such device.

The tests state values for fixed or low frequency (≤ 100 kHz) / high frequency (> 100 kHz) fields by type of TR, treatment mode, and nozzle type, as follows:

- FBTR, PBS, Dedicated Nozzle
 - at isocenter: $< 2.5 \mu\text{T}^*$ / $< 1 \text{ V/m}^*$
 - at nozzle contact: $< 2.5 \mu\text{T}^*$ / $< 1 \text{ V/m}^*$
- IBTR, PBS, Full Universal Nozzle
 - at isocenter: $< 2.5 \mu\text{T}^*$ / $< 1 \text{ V/m}^*$
 - at nozzle contact: $< 2.5 \mu\text{T}^*$ / $< 1 \text{ V/m}^*$
- IBTR, US, Universal Nozzle
 - at isocenter: $< 2.5 \mu\text{T}^*$ / $< 1 \text{ V/m}^*$
 - at nozzle contact: $< 2.5 \mu\text{T}^*$ / $< 1 \text{ V/m}^*$
- GTR, PBS, Dedicated Nozzle
 - at isocenter: $< 2.5 \mu\text{T}^*$ / $< 1 \text{ V/m}^*$
 - at nozzle contact: $< 2.5 \mu\text{T}^*$ / $< 1 \text{ V/m}^*$
- GTR, PBS, Full Universal Nozzle
 - at isocenter: $< 30.52 \mu\text{T}$ / $< 1 \text{ V/m}^*$
 - at nozzle contact: $< 20.25 \mu\text{T}$ / $< 1 \text{ V/m}^*$
- GTR, DS, Universal Nozzle
 - at isocenter: $< 2.5 \mu\text{T}^*$ / $< 1 \text{ V/m}^*$
 - at nozzle contact: $< 2.5 \mu\text{T}^*$ / $< 1 \text{ V/m}^*$

*: the values measured have been identified below the levels of $2.5 \mu\text{T}$ or 1 V/m .

Note: It is possible that one or more type of TR, treatment mode and/or nozzle type from the above list are not available at your PT center.

Intentionally left blank

DRAFT

Functions of the Beam Intensity Redundant Electronic Unit

Throughout the PTS a number of electrometers are installed. Electrometers are connected to Beam Profile Monitors (BPMs) and Beam Current Monitors (BCMs). An electrometer reads out very small currents and performs some basic calculation on the acquired data that it transmits to the Beam Operation Manager (BOM).

One of the electrometers is called the Beam Intensity Redundant Electronic Unit (BIREU), which is connected to the ionization chamber of the cyclotron (IC cyclo).

Note: If the BIREU is not (yet) installed at your center, the cyclo IC chamber is connected to the Beam Current Comparator Electronic Unit (BCCEU).

The BIREU performs the following functions:

- Perform a Max Current Check
- Provide a Dosimetry Counter Electronic Unit (DCEU) output to enable measurement of the overall dose delivered by the cyclotron

BIREU Startup or Connection Failure

In case the BIREU cannot start or fails to connect, the following error message appears:

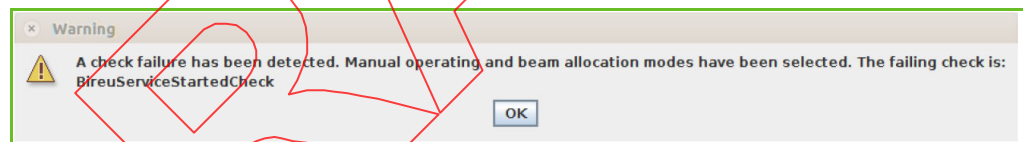

Figure 4-2. 'BireuServiceStartedCheck' Message

Intentionally left blank

DRAFT



Part II

Using Treatment Room Equipment

DRAFT

DRAFT



Chapter 5

Introducing Treatment Room Equipment



The purpose of this part is to describe each piece of equipment in the TR that may be used during a *Treatment* session. The PTS at your treatment center features the following types of TR:

- Gantry Treatment Room (GTR)

For those pieces of equipment that can be controlled from the hand pendant (i.e., the device used to move patient positioning devices and imaging equipment from within the TR) or the remote positioning controls (i.e., the controls displayed on *adaPT deliver* screens that allow you to move patient positioning devices and imaging equipment from the TCR), the most common actions are described. Otherwise, generic descriptions of the hand pendant controls are provided.

The chapters in this part describe the following activities:

- Elementary Notions on Patient Positioning
- Moving the Patient Positioning Devices
- Controlling Movement: Wireless Hand-Pendant and Remote Positioning Controls
- Using the Wireless Hand-Pendant
- Wireless Hand-Pendant Daily Checks and Troubleshooting
- Using the Remote Positioning Controls
- Alignment Tools and Devices (Using the devices of the (PPVS)
- Attaching/Removing a Patient Support Device to/from the PPS
- Installing and Removing Accessories into/from the Accessory Drawer or PBS Dedicated Snout.
- Resetting a Dose Counter Electronic Unit

- Operating the Patient Positioning System Manually (Emergency Release Mode)
- Performing QA Checks and Verifying Beams With a Water Phantom
- Troubleshooting Treatment Room Equipment.

Effects of Temperature and/or Pressure Changes in the Treatment Room

Fluctuations in temperature and/or pressure have an impact on beam measurement performed by Ionization Chamber 2/3 (IC2/3), which is located in the nozzle.

To ensure correct IC2/3 measurement, the ambient TR temperature and pressure is measured and recorded every morning.

If, in the course of the day, temperature and/or pressure is observed to be deviating from the values measured in the morning, these new values must be recorded using the Dosimetry Manager. For detailed information on the Dosimetry Manager, refer to **Appendix C "Using the Dosimetry Manager"**.

WARNING	Whenever the temperature and pressure deviate beyond the treatment center quality management plan threshold, the temperature and pressure have to be updated manually using the Dosimetry Manager.
	

Note: An acceptable deviation will depend on the your PT center's requirement for dose reproducibility

Safety Aspects

WARNING	It is strictly forbidden to ever place any objects (tools, parts, etc) on top or inside moving devices such as the nozzle, or the gantry. Falling tools or parts can injure patients or staff.
	Take inventory of the tools or parts after using them in a treatment room.

Chapter 6

Elementary Notions on Patient Positioning



Positioning and alignment of a patient happen before every fraction. As treatment progresses, it may become necessary to gradually modify an initially defined position. Or because of a patient's condition it may become necessary to deviate from the originally planned position. It is therefore important that a coherent and clear **coordinate system** is used, leaving no room for misinterpretation and ensure the exact recording of positioning data.

This chapter contains the following information:

- *Supported Coordinate Systems*
- *Types of Patient Positioning Device (PPD) Motion*
- *Patient Positioning Devices*



Supported Coordinate Systems

A coordinate system is a system that defines the position of a point in space. A coordinate system is defined by its origin and axes X, Y, and Z. All coordinate systems used by the Treatment Control System (TRCS) are Cartesian right-handed (axis X is the thumb, Y is the index, and Z is the middle finger).

Positioning and alignment data are stored in the PTS database according to the IEC61217 standard. All PPDs' positions are represented according to IEC61217 standard both on screen and in the database. The IEC61217 defines a unique way to display the table, snout and gantry positions.

Note: Imager and Focus coordinate systems defined in IEC61217 are not used.

Within the TRCS the following IEC 61217 compliant Coordinate Systems are used:

- **Fixed Reference System (FRS):** for detailed information, refer to section "IEC Fixed Reference System (f)" on page 6-3.
- **Gantry Coordinate System (GCS):** for detailed information, refer to section "IEC Fixed Coordinate System" on page 6-4.
- **Table Top Coordinate System (TTCS):** for detailed information, refer to section "IEC Table Top Coordinate System (t)" on page 6-5.

IEC Fixed Reference System (f)

The IEC61217 Fixed Reference System (FRS) is defined on the basis of the radiation beam axis, the gantry axis and the isocenter. In the GTR there is a rotating radiation beam axis that orthogonally crosses a fixed gantry axis through a common isocenter.

The FRS is defined as follows:

- the origin is at isocenter
- X_f is aligned with the beam axis and directed towards the beam source when the gantry is at 90° ¹
- Y_f is aligned with the gantry axis and directed to the left of a viewer facing the beam source when the gantry is at 90° ²
- Z_f is vertical and directed upwards

1. By convention, the gantry angle is 90° when the radiation beam axis is horizontal, at 90° from Z_f and directed in the opposite direction of X_f .
2. When the radiation beam axis is horizontal, Y_f is the horizontal axis passing through the FRS origin, and orthogonal to the beam axis.

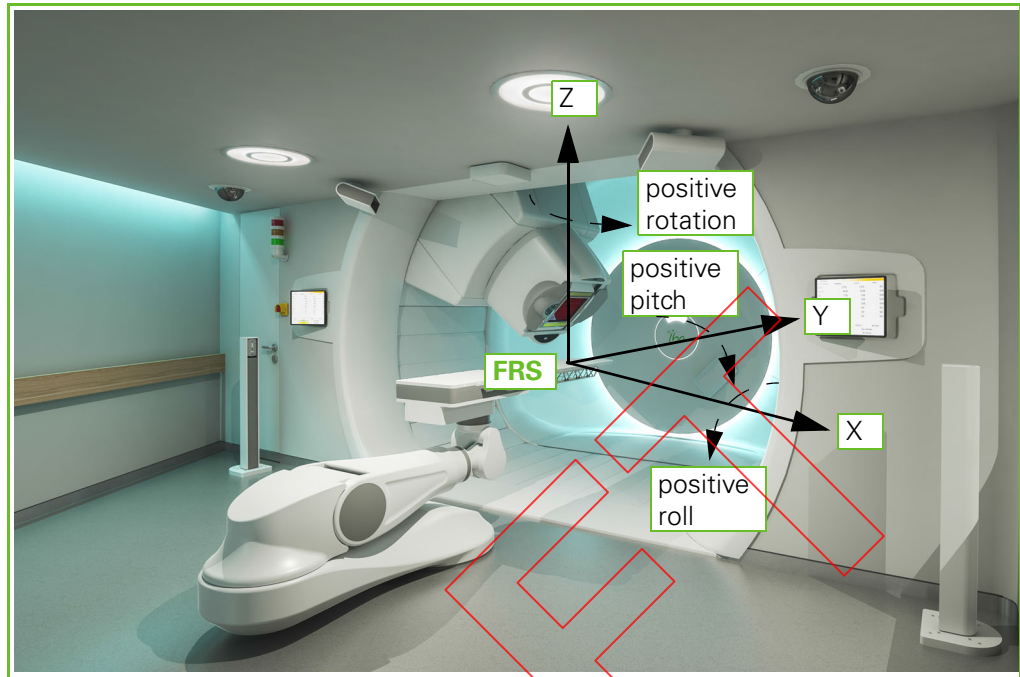

Figure 6-1. IEC Fixed Coordinate System

DRY

IEC Gantry Coordinate System (g)

The IEC 61217 gantry coordinate system is stationary with respect to the gantry. It is defined as a daughter of the FRS, as follows:

- the origin is the origin of the FRS
- X_g is orthogonal to the beam axis, directed downwards when the gantry angle is 90°
- Y_g is coincident with Y_f
- Z_g is aligned with the beam axis, directed towards the beam source

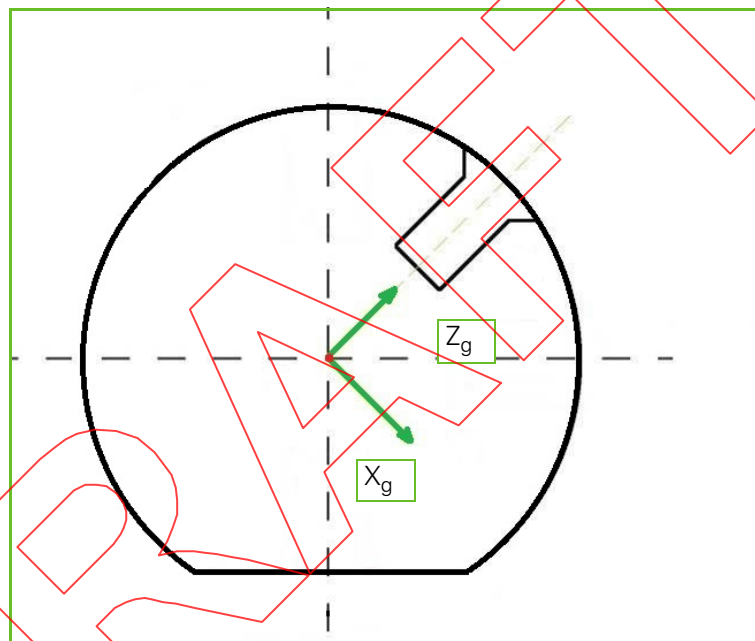

Figure 6-2. IEC Gantry Coordinate System

IEC TableTop Coordinate System (t)

The IEC 61217 table top coordinate system (TTCS) is stationary with respect to the table.

In case of a couch (which presents a rectangular planar surface):

- X_t is parallel to the table small side and directed on the left of a patient in head-first supine position on the table
- Y_t is parallel to the table longitudinal axis (long side) and directed towards the head of a patient lying head-first on the table
- Z_t is normal to the table surface and directed upwards

- the origin is the center of the treatment volume (see page 7-6), 10 cm above the table top in the Z direction (this distance may vary depending on the table used), on the median of the table that is parallel to its long axis in the X direction, and 85 cm to the front of the physical rotation axis of joint 6 in the Y direction. As a result, the origin of the TTCS is defined in such a way that, when the center of the treatment volume of the table top is placed at the origin of the FRS, then the origin of the TTCS is overlaid with the origin of the FRS.

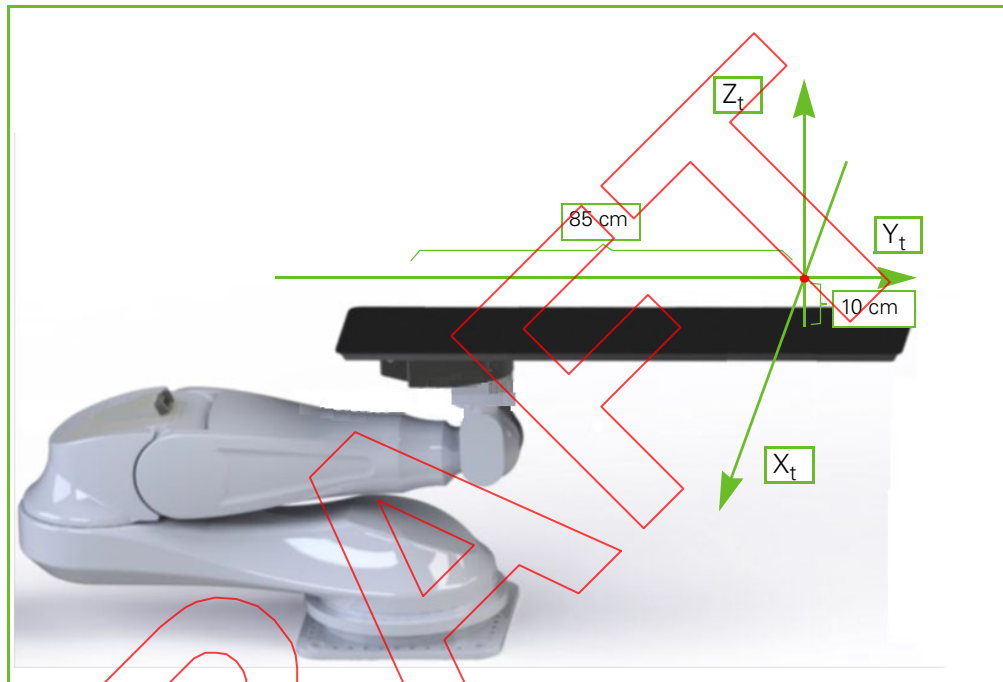

Figure 6-3. Table Top Coordinate System (TTCS)

Note: TTCS does not comply with IEC 61217 for following points:

- Zero position is not the one defined in IC61217 for Y and Z axis. Zero position of TTCS is defined so that the TCP (as shown in Figure 6-4) is at isocenter.
- Pitch and roll are between $[-180^\circ; 180^\circ]$ instead of $[0^\circ; 360^\circ]$

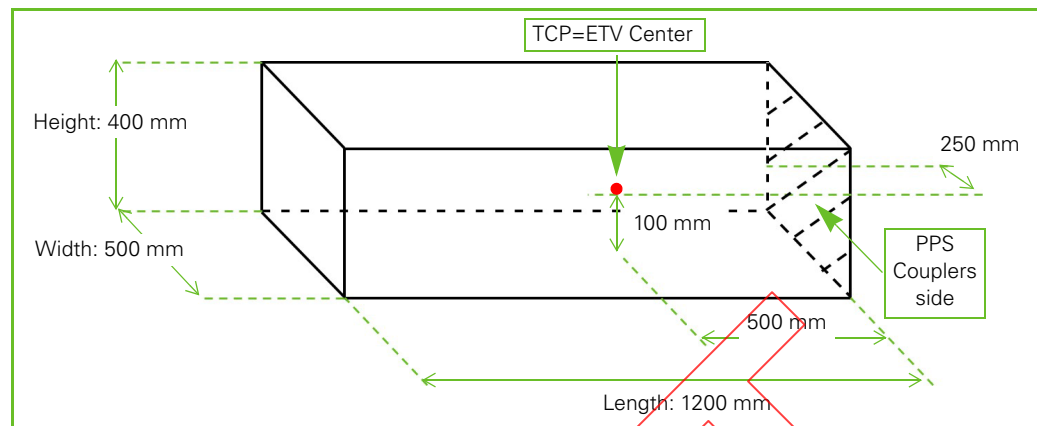

Figure 6-4. Zero position of the TTCS

Note: PPS positions are always displayed according to the TTCS.

Note: Auto PPS motions are managed in such a way that movement along all involved axes is synchronized. As such, the PPS trajectory is not defined in TTCS terms.

Note: PPS Manual movements follow the HTTCS¹ for translations along the X, Y and Z axes as well as for top rotation.

1. The Horizontal Table Top Coordinate System (HTTCS) is equivalent to the IEC 61217 patient support coordinate system and as its name indicates, it always remains horizontal. In the Proton Therapy System, it is used instead of the TTCS for the execution of Manual PPS motions. This enables lateral (X) and longitudinal (Y) motions to be horizontal displacements of the table top even if there is a pitch or roll of the table. If the TTCS was used instead, as it is stationary with respect to the table, lateral (X) motions would be executed on the plane of the current roll angle and longitudinal (Y) motions on the plane of the current pitch angle.

Types of Patient Positioning Device (PPD) Motion

Using the hand-pendant or the remote positioning controls, the user can perform any of the following types of motion:

- Auto motions
- Manual motions

Note: For the purpose of this manual, the Manual operating mode of the remote positioning controls is fully explained and illustrated. This operating mode may or may not be available at your treatment center.

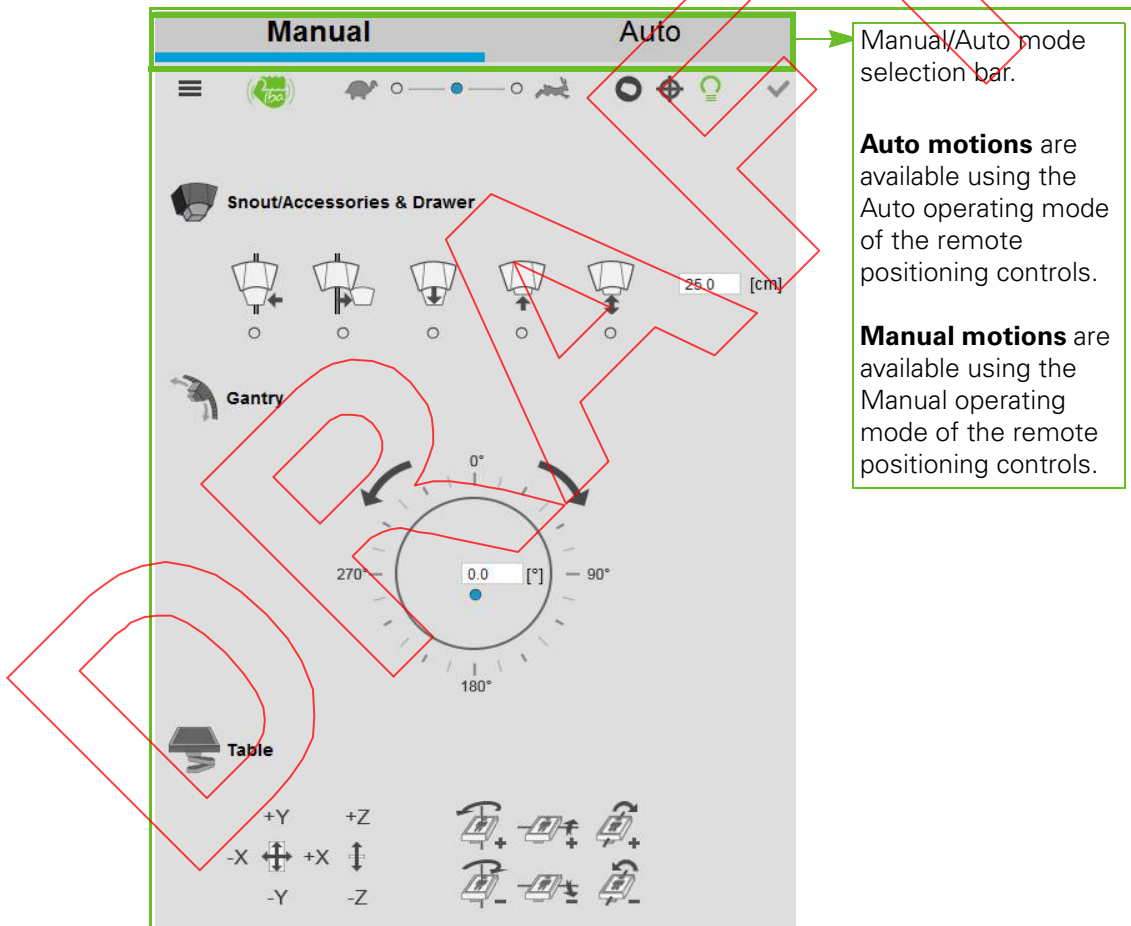

Figure 6-5. Remote Positioning Controls Panel - Auto and Manual Modes (typical)

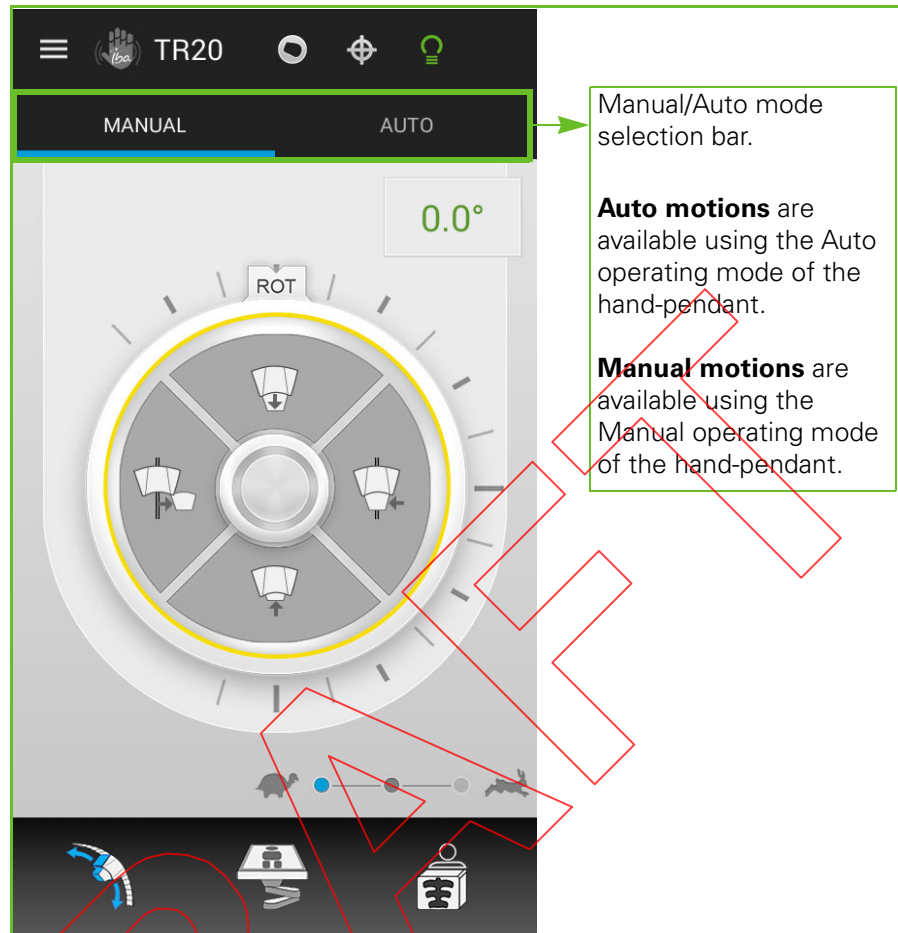

Figure 6-6. Wireless Hand-Pendant GUI Screen - Auto and Manual Modes (typical)

Besides Auto and Manual motions, Trajectory motions are predefined gantry trajectories that enable the acquisition of CBCT.

Using Auto Motions

Auto motions are available using the Auto operating mode of the hand-pendant or of the remote positioning controls. This type of motion is used to move several PPDs to a predefined programmed position (also called target position), which may either be a prescribed position or a user-defined position.

- **Prescribed positions** are patient-specific (i.e., they depend on the patient-specific data from the treatment plan that may be loaded in the system at a given time).

- User-defined positions** are non patient-specific (i.e., they do not depend on the loaded patient-specific data). These positions may be stored and used across treatment sessions in the same treatment room. For example, a user-defined *Load* position may be used to load patients onto the couch.

Prescribed or user-defined positions may require more than one PPD to be positioned in a certain way. These positions are computed in advance, so you may use the hand-pendant or the remote positioning controls to execute Auto motions that take the different devices to target. Motions of the different devices take place sequentially. Each device involved in a predefined programmed position needs to be individually selected and moved to its target position.

The settings of all target positions are displayed according to IEC61217 (refer to "Supported Coordinate Systems" on page 7-3).

Target Positions in a GTR

This section features a list of the target positions that may be available in the different types of treatment rooms when using Auto mode.

Note: For further information on how to perform Auto motions using the wireless hand-pendant, refer to Chapter 9. For further information on how to perform Auto motions using the remote positioning controls, refer to Chapter 11.

Table 6-1. Target Positions for a GTR

	Position name	Coordinate system in which it is expressed	PPD	Settings for target position
Prescribed / Patient-specific	SETUP	IEC	Gantry PPS PBS ded. snout	Obtained from the patient's selected treatment plan.
	TREATMENT	IEC	Gantry PPS PBS ded. snout	Obtained from the patient's plan, with application of the correction from the setup beam.

Table 6-1. Target Positions for a GTR (Cont'd)

	Position name	Coordinate system in which it is expressed	PPD	Settings for target position
User-defined / Non patient-specific	CORRECTED	IEC	PPS Gantry Snout	Obtained from the setup or treatment correction data manually entered by a user or received from a patient position verification system such as <i>adaPTinsight</i> . It means that you want to execute the corrections that have been manually entered or received from <i>adaPTinsight</i> .
	User presets	IEC	PPS Gantry Snout (Optional)	You may define and save the equipment position(s) that you deem useful.

Using Manual Motions

Note: For the purpose of this manual, the Manual operating mode of the remote positioning controls is fully explained and illustrated. This operating mode may or may not be available at your treatment center.

WARNING	Manual motions do not ensure an accurate positioning of the patient. If a treatment with the beam has to be done after a manual motion, it is necessary to check the tumor position with the imaging systems.
	

Manual motions are available using the Manual operating mode of the hand- pendant or of the remote positioning controls. This type of motion is used to move a single piece of equipment along an axis/direction either without a specific target or with a target defined on the go.

Manual motions allow the user to execute the refinements that ensure proper patient positioning according to the circumstances. Manual motions may follow an Auto motion.

The settings of all Manual motions are displayed according to IEC61217 (refer to "Supported Coordinate Systems" on page 7-3).

Manual Motions in a GTR

This section features a list of the Manual motions available in the different types of treatment rooms when using Manual mode.

Note: For further information on how to perform Manual motions using the wireless hand-pendant, refer to Chapter 9. For further information on how to perform Manual motions using the remote positioning controls, refer to Chapter 11.

Table 6-2. Manual Motions in a GTR

Device	Axis/ Direction of Movement	Coordinate System	Movement
PPS	+X -X	IEC HTTCS ^a	Couch movement along the X-axis of the HTTCS.
	+Y -Y	IEC TTCS	Couch movement along the Y-axis of the TTCS.
	+Z -Z	IEC TTCS	Couch movement along the Z-axis of the TTCS.
	Rotation CW/CCW	IEC TTCS	Clockwise and counterclockwise couch rotation
	Pitch CW/CCW	IEC TTCS	
	Roll CW/CCW	IEC TTCS	
Gantry	CW CCW	IEC	Gantry rotation (0° – 360°)
Snout (PBS ded.)	Drawer Insertion/ Retraction	IEC	Snout extension

- a. The Horizontal Table Top Coordinate System (HTTCS) is equivalent to the IEC 61217 patient support coordinate system and as its name indicates, it always remains horizontal. In the Proton Therapy System, it is used instead of the TTCS for the execution of Manual PPS motions. This enables lateral (X) and longitudinal (Y) motions to be horizontal displacements of the table top even if there is a pitch or roll of the table. If the TTCS was used instead, as it is stationary with respect to the table, lateral (X) motions would be executed on the plane of the current roll angle and longitudinal (Y) motions on the plane of the current pitch angle.

Using Trajectory Motions

Trajectory motions are applicable to the gantry when the full trajectory of its movement is predefined. This type of motion enables volumetric image acquisition using *adaPTinsight*. The parameters of the gantry's trajectory are set by the user (e.g., start and stop gantry angles and gantry rotation speed) and a dry-run is performed before treatment. Motion is initiated by pressing both the software and the hardware start buttons (respectively on *adaPTinsight* and on the Cone-Beam Computed Tomography - CBCT console), and does not require continuous activation from the user. Motion stops when the trajectory is complete or when the user presses a motion stop button.

WARNING	<p>As a Radiation Therapy Technologist (RTT), you should visually check the absence of collision before initiating a Cone-Beam Computed Tomography (CBCT) acquisition. In case of doubt, you shall perform a dry-run of the CBCT trajectory to confirm that there is no collision.</p> <p>As a RTT, you shall be vigilant regarding positioning changes; if the patient position or the position of immobilization devices changes during different fractions, this verification shall be re-done.</p> <p>As a RTT, you shall also be vigilant regarding collision with other equipment such as anesthesia or respiratory equipment which have a direct impact on the patient's safety.</p>
	

Note: The trajectory motion mode is closely related to CBCT image acquisition. For further information on CBCT acquisition refer to *adaPTinsight* user documentation.

Patient Positioning Devices

Proper positioning and alignment of a patient entails the proper positioning of the patient positioning devices involved: **gantry**, **PBS Dedicated snout**, and **Patient Positioning System (PPS)**. Depending on the case, one or more of these devices may need to be properly positioned.

Note: For further information on Patient Positioning Devices, refer to Chapter 7.

Different PPDs exist in each type of treatment room, as follows:

- **Gantry Treatment Room (GTR):**
 - Patient Positioning System (PPS)
 - Gantry
 - PBS Dedicated snout and accessory drawer



Chapter 7

Moving the Patient Positioning Devices

.....

This chapter contains some general information on the movement of the different Patient Positioning Devices in the treatment room:

- *Patient Positioning Devices*
- *Solving Collisions*
- *Managing Proximity*

Use the hand-pendant described in Chapter 9 or the remote positioning controls described in Chapter 11 to move the gantry, snout, PBS Dedicated snout, the PPS or the imaging devices.

CAUTION	Improper patient restraint on the Patient Positioning System (PPS) can cause the patient to fall from the PPS when in motion. Furthermore, releasing the pressure sensitive button on the back of the hand pendant stops the PPS abruptly and can cause the patient to fall off if not suitably restrained.
	Only press the Motion Enable Button when the patient is safely restrained on the couch or outside the moving equipment operating range.

WARNING	The Leoni Orion maintenance hand pendant is a service hand pendant only. As a service hand pendant, the Leoni Orion maintenance hand pendant is capable of overriding safety checks.
	It is strictly forbidden to use the Leoni Orion maintenance hand pendant after an initial beam request has been completed, and for any clinical operation in general. Do NOT use the Leoni Orion maintenance hand pendant while the patient is loaded.

WARNING	It is strictly forbidden to ever place any objects (tools, parts, etc) on top or inside moving devices such as the nozzle, or the gantry. Falling tools or parts can injure patients or staff.
	Take inventory of the tools or parts after using them in a treatment room.

CAUTION	In order to avoid Patient Positioning System (PPS) damage, do not use the PPS robot as a lifting tool.
	

CAUTION	Take caution for flat panel arm and gantry movement in GTR as they do not respect the rotation and linear movement stopping distances.
	

Patient Positioning Devices

The Patient Positioning Devices in the treatment room allow you to position the patient for treatment. You may control them using the wireless hand-pendant or the remote positioning controls.

Note: For details on how to move the PPDs with Manual and Auto motions using the wireless hand-pendant, refer to Chapter 9. For details on how to move the PPDs with Manual and Auto motions using the remote positioning controls, refer to Chapter 11.

The Patient Positioning Devices in the GTR are:

- **Patient Positioning System (PPS):** the PPS is the mechanical arm that serves to position the patient laying on the couch.
- **Dedicated Nozzle Snout Holder (DNSH):** the DNSH is the device that holds the accessory drawer and is capable of bringing it closer or further from the patient skin for treatment.
- **Accessory Drawer:** the device capable of putting the accessory fully in or out of the beam path depending on whether or not the accessory is used in the prescription.
- **Gantry:** the device capable of rotating the nozzle to deliver the proton beam from different angles.

Patient Positioning System (PPS)

Note: For information on how to manually operate the PPS (in case of emergency), refer to Chapter 16, "Operating the Patient Positioning System Manually (Emergency Release Mode)."

The Patient Positioning System (PPS) has six axes of movement that can be controlled using the hand-pendant or the remote positioning controls.

Note: PPS positions are always displayed according to the TTCS in the FRS.

Note: Auto PPS motions are managed in such a way that movement along all involved axes is synchronized. As such, the PPS trajectory is not defined in TTCS terms.

Note: PPS Manual movements follow the TTCS for translations along the X, Y and Z axes as well as for top rotation.

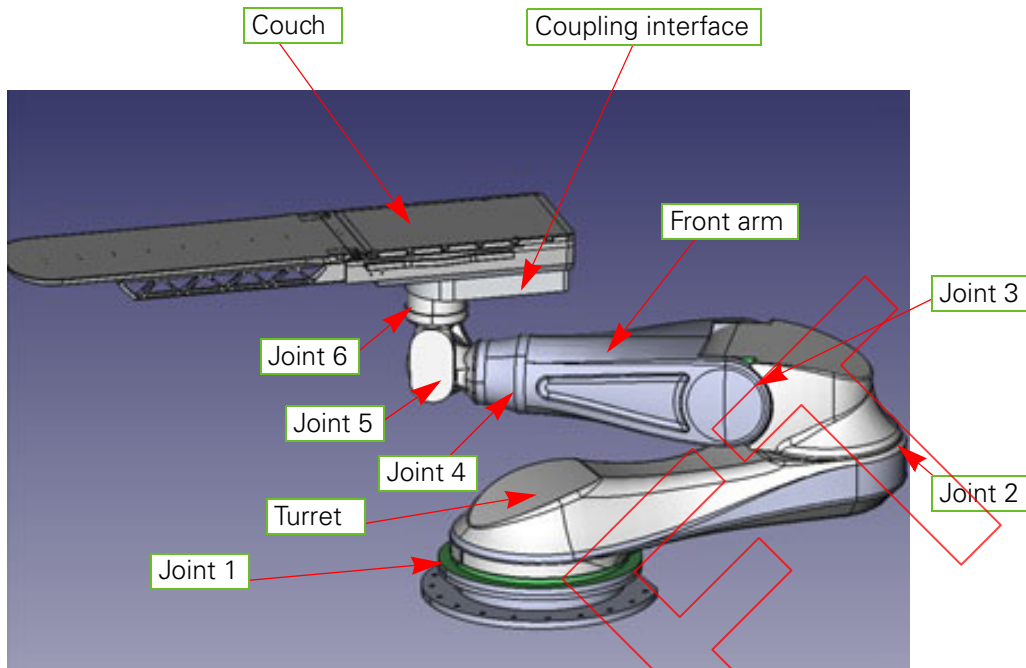



Figure 7-1. PPS Structural Parts

CAUTION	Before moving the Patient Positioning System (PPS) robot, the user shall ensure area around the joint 1 and the turret has to be clear.

Allowed Maximum Weight on the Couch

The PPS is a high-precision tool. The precision is guaranteed for total weights on the couch within certain weight limits; this total weight may be comprised of the patient and/or equipment. Beyond those guaranteed limits, absolute weight limits exist.

WARNING	<p>The maximum load allowed on the Patient Positioning System (PPS) robot is 215 kg. This maximum load includes the patient and any accessory placed on the couch with the patient or any other equipment.</p>
	<p>Between the maximum load of the PPS robot and the maximum load of the couch being used, one must consider the lowest load as your maximum load allowed, no matter if the couch labeling suggests a higher load.</p> <ul style="list-style-type: none"> * Couch supporting 250 kg: Maximum load is 215 kg * Couch supporting 150 kg: Maximum load is 150 kg <p>Failure to comply could induce a loss of accuracy or precision which impairs safety and performances of the PPS robot.</p>

Patient Positioning System Overload

CAUTION	<p>When loading, unloading or positioning the patient, the patient mass must be spread homogeneously and adequately centered on the couch at all times to avoid excessive stress on a part of the couch or on the robot.</p>
	<p>As the patient mass on the couch creates deflection, one must ensure the patient mass is placed such as you do not exceed a mass of 100 kg beyond the center of the Extended Treatment volume (85 cm from the Patient Positioning System Joint 6).</p> <p>Pay particular attention to other loads related to clinical application which can have inadapted load characteristics (ex.: a fully filled water phantom, heavy metallic parts,...).</p> <p>Failure to comply could lead to damages and / or loss of accuracy or performance of the PPS Robot.</p>

CAUTION	<p>If the robot has undergone an overload or a collision, the essential performances of the Patient Positioning System are not guaranteed anymore.</p>
	<p>Contact IBA immediately before resuming clinical use of the robot.</p>

Constant Weight on the Couch

CAUTION	The same clinical devices must be put on the Patient Positioning System (PPS) for every treatment day in order to maintain a constant weight on the couch.
	

Couch Modifications

To ensure good accuracy and collision detection, it is required to identify the mass installed above the PPS coupling System, and the position of the center of gravity of this mass.

Each couch is identified by a unique couch ID and the mass properties of each couch are configured in the IBA system according to the couch ID. The patient mass properties are measured and updated automatically by the PPS before each motion, except for the patient Z-coordinate which is based on an assumption.

WARNING	Define a new couch ID and related couch properties when mass properties of the couch are changed significantly. Failure to do so may result in an incorrect couch properties assumption.
	Examples of significant changes are an unknown couch, a modified couch, or a couch loaded with clinical equipment above 15 kg.

Extended Treatment Volume (ETV)

The extended treatment volume, in the case of a PPS with a couch, is a box-shaped virtual volume attached to the table top. Its inferior surface is merged with the horizontal top surface of the couch. The longitudinal axis of the ETV is parallel to the longitudinal axis of the couch and intercepts orthogonally rotation axis of joint 6 of the PPS.

This volume includes all the points that can be physically brought to the isocenter with:

- a PPS top rotation within the interval $[-95^\circ; +95^\circ]$
- a PPS pitch value between -5° and 5°
- and a PPS roll value between 5° and -5°

- the defined absolute accuracy

The dimensions of the extended treatment volume are:

- 50 cm parallel to the table top's short axis
- 100 cm parallel to the table top's long axis
- 40 cm perpendicular to the table top

The extended treatment volume contains the origin of the TTCS (Table Top Coordinate System), also named Tool Center Point (TCP), as the origin. This point is centered with respect to the length and width of the extended treatment volume and 10 cm above its inferior internal surface. This point is located 850 mm away from PPS axis joint 6 along the longitudinal direction of the couch.

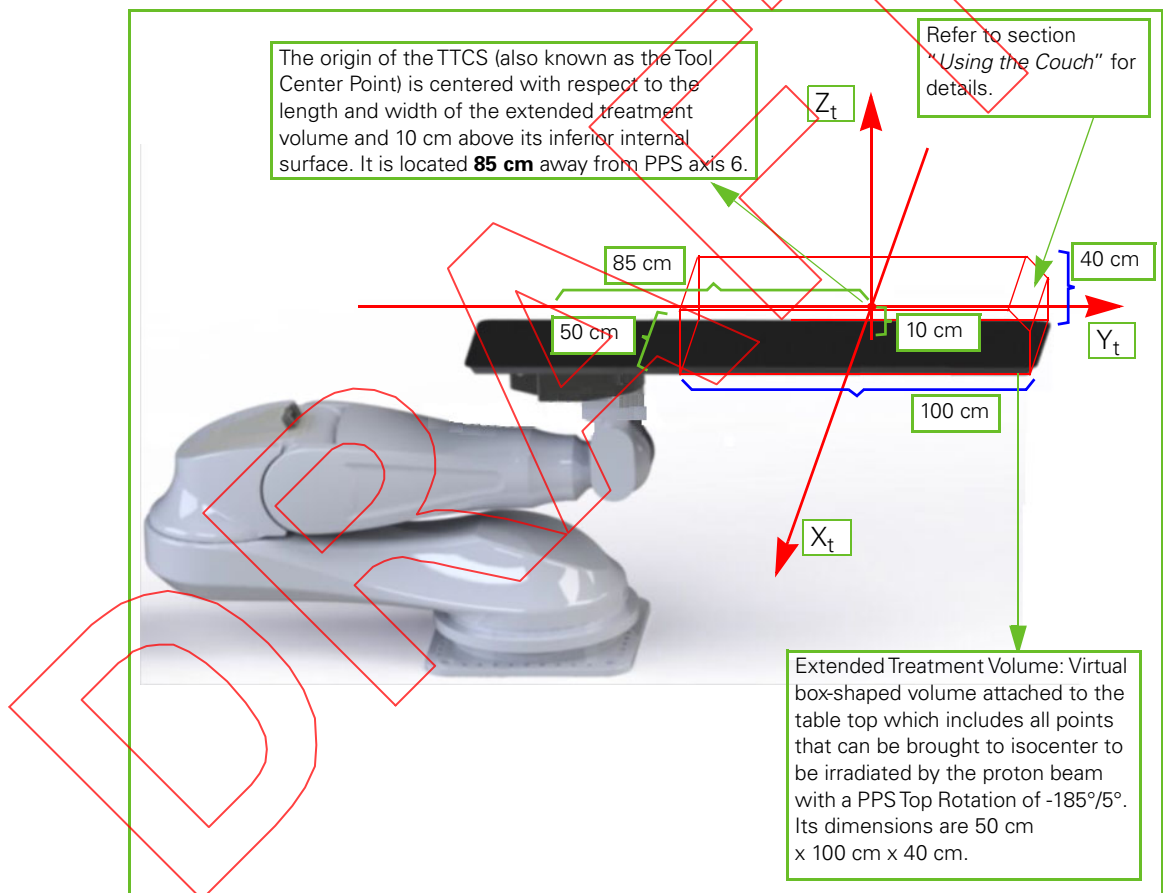

Figure 7-2. Treatment Volume (drawing not to scale)

Note: Positioning accuracy is only validated for points within the treatment volume.

Note: For a long table-top offering uniformity¹, WET (Water Equivalent Thickness) uniformity is only guaranteed for a position within the ranges of the treatment volume. This is relevant only for those positions where the beam passes through the table in the RT Ion plan beams geometry definition.

The PPS is capable to move and place a zone of interest outside the treatment volume. However, positioning the PPS outside the treatment volume requires you to exercise specific care for patient positioning verification.

The accuracy in the treatment volume is valid for left and right elbow configurations.

Note: The Patient Positioning System (PPS) is capable of positioning a point of the treatment volume at isocenter within the required accuracy and repeatability values. These values are valid for both small correction movements and large absolute PPS movements.

WARNING	Due to existing interferences, it may not be possible to acquire images of certain points of the treatment volume in all hardware configurations. You must select the proper arm configuration (right or left) such that the oblique imager X-ray beams will not be obstructed by the robotic arms.
	



Whenever you confirm a position outside the treatment volume, the following message appears on the hand-pendant:

Position outside treatment volume. Position verifications are mandatory.

Press **OK** to validate your selection.

Using the Couch

Note: The following information is valid for the kVue, kVueOne and CIVCO couch.

Figure 7-3 shows a detailed view of the treatment volume displayed by Figure 7-2. When using the couch, the section represented in red (see Figure 7-3) is not part of the treatment volume.

The dimensions of the rectangular sides of the triangle are as follows:

- +/- 0° pitch: 5 cm by 5 cm
- +/- 5° pitch: 10 cm by 10 cm

1. To establish whether or not the table-top offers uniformity, refer to the OEM documentation.

Figure 7-3 represents the most restricted situation.



Figure 7-3. Treatment Volume When Using the (kVueOne) Couch Longitudinal Cross Section

CAUTION	Specific attenuation tests should be conducted by physics department. The support beams (arms) can be moved laterally with or without the patient on the kVue. The clinical user shall, whenever possible, make sure that the support beams are not in the treatment beam path.

Moving the couch beams (for X-ray imaging) for the kVue couch

The automatic load cell check needs to block the beams of the kVue couch. Hence, a tool is fixed on the beams (see Figure 7-4)

In some cases, the user might need to move beam of the kVue couch for X-ray imaging or when they are in interference with gantry. In this case, the user must squeeze or press the handle of this tool to move the beams (see Figure 7-4).

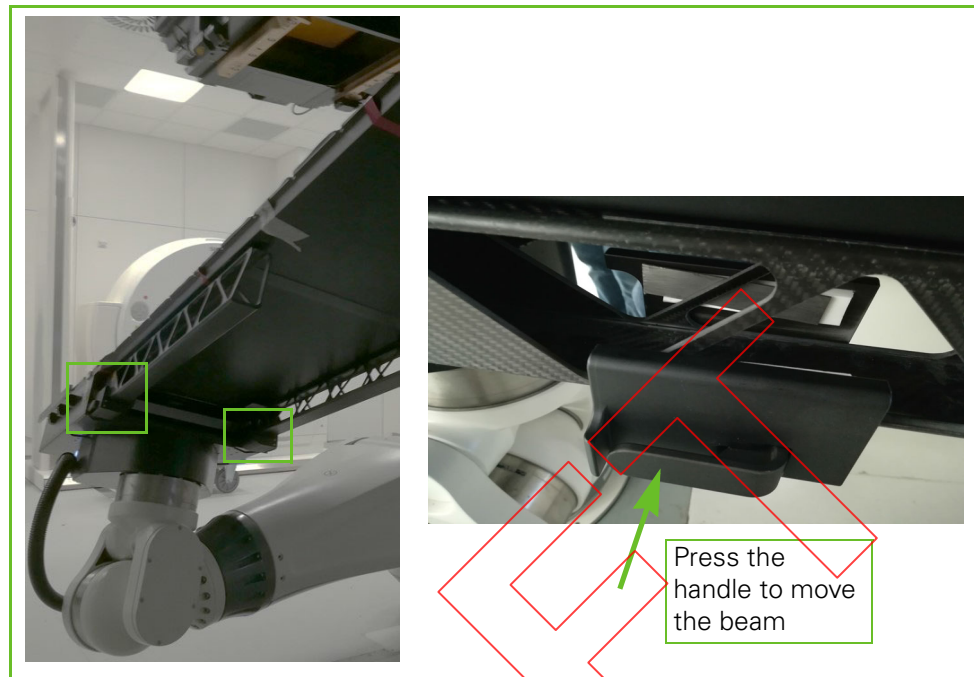

Figure 7-4. Tool for moving the kVue couch beams

Enhanced Safety Through Various Software Limits

Safe operation of the PPS is guaranteed by a set of configurable software limits and low level non-configurable software limits for each axis, protecting the patient from being injured and the equipment from being damaged. To be sufficiently accurate, these software limits depend on the load that is exerted on the PPS; these limits reside in the TCS configuration database.

The operation of the software limits is fully transparent to you as a user.

GoTo Motions in a GTR

Commands sent from the hand-pendant to move the **Patient Positioning System (PPS)** and **gantry** and **PBS Dedicated snout** to a target position are received and managed by the Therapy Control System (TCS).

Note: Only those Labeled positions for which the conditions are currently met appear in the GOTO menu.

Table 7-1. Labeled Positions for a GTR

	Position name	Coordinate system in which it is expressed	PPD	Settings for target position
Patient specific	SETUP	Isocentric	Gantry PPS PBS ded. snout	Obtained from the patient's plan.
	TREATMENT	Isocentric	Gantry PPS PBS ded. snout	Obtained from the patient's plan, with application of the correction from the setup beam.
	MEMORY	FRS, Isocentric	Gantry PPS PBS ded. snout	This position is only available if previously defined and saved when the PPD settings were saved during a "Save Position" request. The saved MEMORY position is deleted following a fraction.
	CORRECTED	FRS, Isocentric	PPS	Obtained from the setup or treatment correction data entered by a user. It means that you want to execute the corrections that have been entered.
	CBCT menu - Pre-start	Isocentric	Gantry	This position is only available when the PPVS is in the CBCT acquisition step. After selecting the start angle in the CBCT Acquisition menu of <i>adaPTinsight</i> , Prestart moves the gantry to a start position, ready for a CBCT scan.
	CBCT menu - Dry-run	Isocentric	Gantry	This position is only available when the PPVS is in the CBCT acquisition step. Performs a CBCT dry-run to verify that the trajectory will be collision free.

Table 7-1. Labeled Positions for a GTR (Cont'd)

	Position name	Coordinate system in which it is expressed	PPD	Settings for target position
	CBCT menu - Safe	Isocentric	PPS	Defines a target position for the PPS. This position is only available when the PPS is not in a safe position for CBCT; this position is used when the current PPS position will lead to a collision trajectory during a CBCT scan. Moving the PPS after choosing the CBCT Safe position will move the PPS to a position where no collision occurs with the table.
Non-patient specific	LOAD	FRS, Isocentric	Gantry PPS PBS ded. snout	Position used to load/unload a patient onto/from the couch.
	USER	FRS	Gantry PPS PBS ded. snout	This position is only available if in Service session and previously defined and saved in the TR when the PPD settings were saved during a "Save Position" request.
	GANTRY 90	FRS, Isocentric	Gantry	Position used to move the gantry to a frequently required position.
	GANTRY 180	FRS, Isocentric	Gantry	Position used to move the gantry to a frequently required position.
	GANTRY 270	FRS, Isocentric	Gantry	Position used to move the gantry to a frequently required position.

Snout Holder

Note: For details on how to move the PBS dedicated snout with Manual and Auto motions using the wireless hand-pendant, refer to Chapter 9. For details on how to move the PBS dedicated snout with Manual and Auto motions using the remote positioning controls, refer to Chapter 11.

The Snout Holder is the structure on which the accessory drawer is mounted.

The snout holder has one direction (axis) of movement:

- Movement **along the beam axis** (Z_g axis of the Gantry Coordinate System) to position the accessory drawer closer to the patient's skin in preparation of irradiation or to retract it away from the patient's skin following irradiation.

Accessory Drawer

Note: For details on how to move the accessory drawer with Manual and Auto motions using the wireless hand-pendant, refer to Chapter 9. For details on how to move the accessory drawer with Manual and Auto motions using the remote positioning controls, refer to Chapter 11.

Note: Due to safety reasons, moving the accessory drawer using the hand-pendant is only possible when the snout holder is at a position far from isocenter (i.e., retracted position).

At the end of the nozzle, an accessory drawer can support an optional range shifter, ridge filter or snout (and a block and/or range compensator onto the snout). This accessory drawer can be put fully in (inserted) or out (retracted) of the beam path depending on whether or not the accessory is used in the prescription.

Gantry

Note: For details on how to move the gantry with Manual and Auto motions using the wireless hand-pendant, refer to Chapter 9. For details on how to move the gantry with Manual and Auto motions using the remote positioning controls, refer to Chapter 11.

Note: The rotating gantry is only available in a Gantry Treatment Room (GTR).

The gantry is capable of rotating 360° around its center (horizontal) axis with respect to the nozzle (vertical beam) positioned vertically and pointed in a downward direction, as illustrated by Figure 7-5. The gantry may be rotated clockwise from 0° (12:00 o'clock) to 180° (6:00 o'clock) and counterclockwise from 0° (12:00 o'clock) to 180° (6:00 o'clock).

In Treatment session, the gantry angle scale is in the range of 0° (12:00 o'clock) to 360° (12:00 o'clock).

Throughout this guide, reference to the various positions of the gantry are made in terms of both degrees and clock positions.

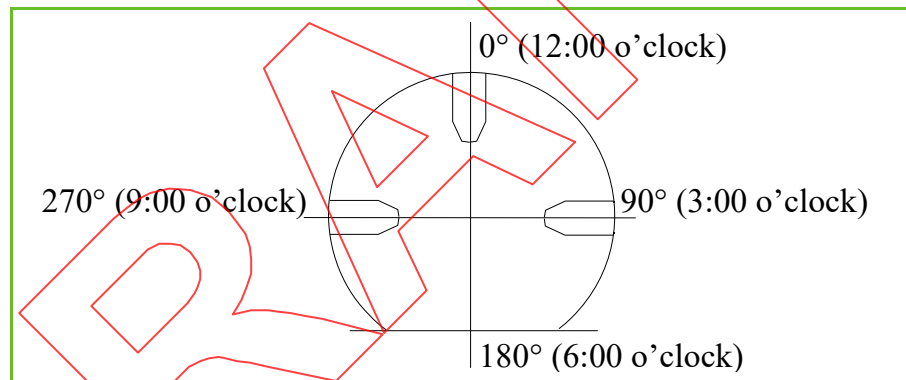



Figure 7-5. Gantry Angles in Treatment Session (viewed from the Treatment Room)

Solving Collisions

CAUTION	<p>If the robot has undergone an overload or a collision, the essential performances of the Patient Positioning System are not guaranteed anymore.</p> <p>Contact IBA immediately before resuming clinical use of the robot.</p>

CAUTION	<p>In case of collision of the Patient Positioning System (PPS) with a device or person, suspend all clinically related activities and contact IBA personnel as the Proton Therapy System (PTS) cannot be guaranteed to satisfy safety and performance characteristics. Collision of the PPS with a device or person can affect the calibration of the PPS, leading to reduction of positioning accuracy.</p>
	

Any collision between a device and the PPS is automatically detected.

CAUTION	<p>Be careful when handling the system in this mode because the collision detection will be automatically disabled (upon acknowledgement of the collision detection) at the start of a collision recovery phase in order to allow to move equipment(s) out of collision.</p>
	

In case of collision, the PPS shifts into Recovery mode and the Collision detected message appears.

- Pressing **OK** will start a recovery phase. During this phase, you can move the equipments at a very slow speed.

When the PPS has been moved out of the collision situation, the Out of collision. Next move will re-enable detection message appears. When you move an equipment, collision detection will be enabled again.

If a collision occurs

If a collision occurs between the PPS and a person or another equipment, proceed as follows:

1. The Collision detected message appears. Press **OK**.
2. If a collision is no longer present,
 - a. The Out of collision. Next move will re-enable collision message immediately appears.
 - b. When you move an equipment, collision detection will be enabled.
3. If a collision is still present,
 - c. The Please move out of collision. Be careful: collision detection will be disabled during next movement message appears.

- d. Press **OK**
- e. Move the equipment causing the collision. During this movement, collision detection is disabled and equipment movements can be performed at low speed only.
- f. If this movement brings the system into a state in which the collision is no longer present, see Step 2.
- g. If you interrupt the movement while the collision is still present, see Step 3.

Managing Proximity

When a proximity situation is detected:

- Patient Positioning Devices (PPDs) move at medium speed.
- The wireless hand-pendant or the remote positioning controls make(s) a beeping sound during equipment motion to alert you that the devices are getting close to each other.

Note: *If the PPDs are close but the motion is such that one is getting away of the other, there is no proximity situation.*

Chapter 8

Controlling Movement: Wireless Hand-Pendant and Remote Positioning Controls

.....

The **wireless hand-pendant** is the device used to move patient positioning devices and imaging equipment from within the Treatment Room (TR).

Note: For detailed information on using the wireless hand-pendant, refer to Chapter 9.

Most motion control functions can also be used from the Treatment Control Room (TCR) using the **remote positioning controls**, which are displayed on adaPT~~deliver~~ screens. The remote positioning controls are used in combination with the remote positioning hardware console. To execute the motions selected using the remote positioning controls, you must use the **Motion Enable Button (MEB)** and **Move** buttons on the remote positioning hardware console.

Note: For detailed information on using the remote positioning controls, refer to Chapter 11.

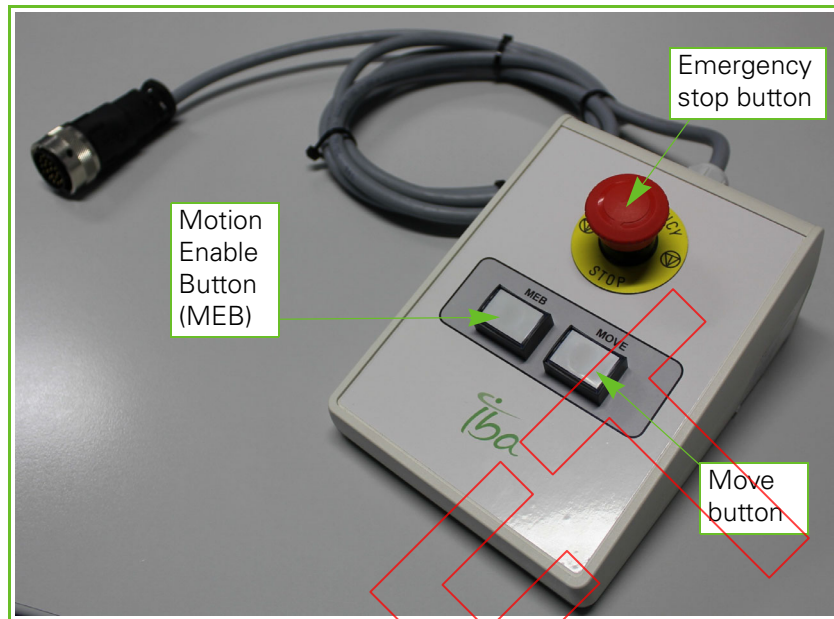

Figure 8-1. Remote Positioning Hardware Console

Note: When the Cone-Beam Computed Tomography (CBCT) option is active, it is also possible to move equipment from the CBCT controls on the X-ray generator hardware console. For further details, refer to the adaPTinsight user documentation.

The wireless hand-pendant and remote positioning controls share a number of similar features. This chapter provides you with an overview of those features.

Wireless Hand-Pendant Screens

All wireless hand-pendant screens (both in Manual and Auto modes) share a series of main features (see Figure 8-2).

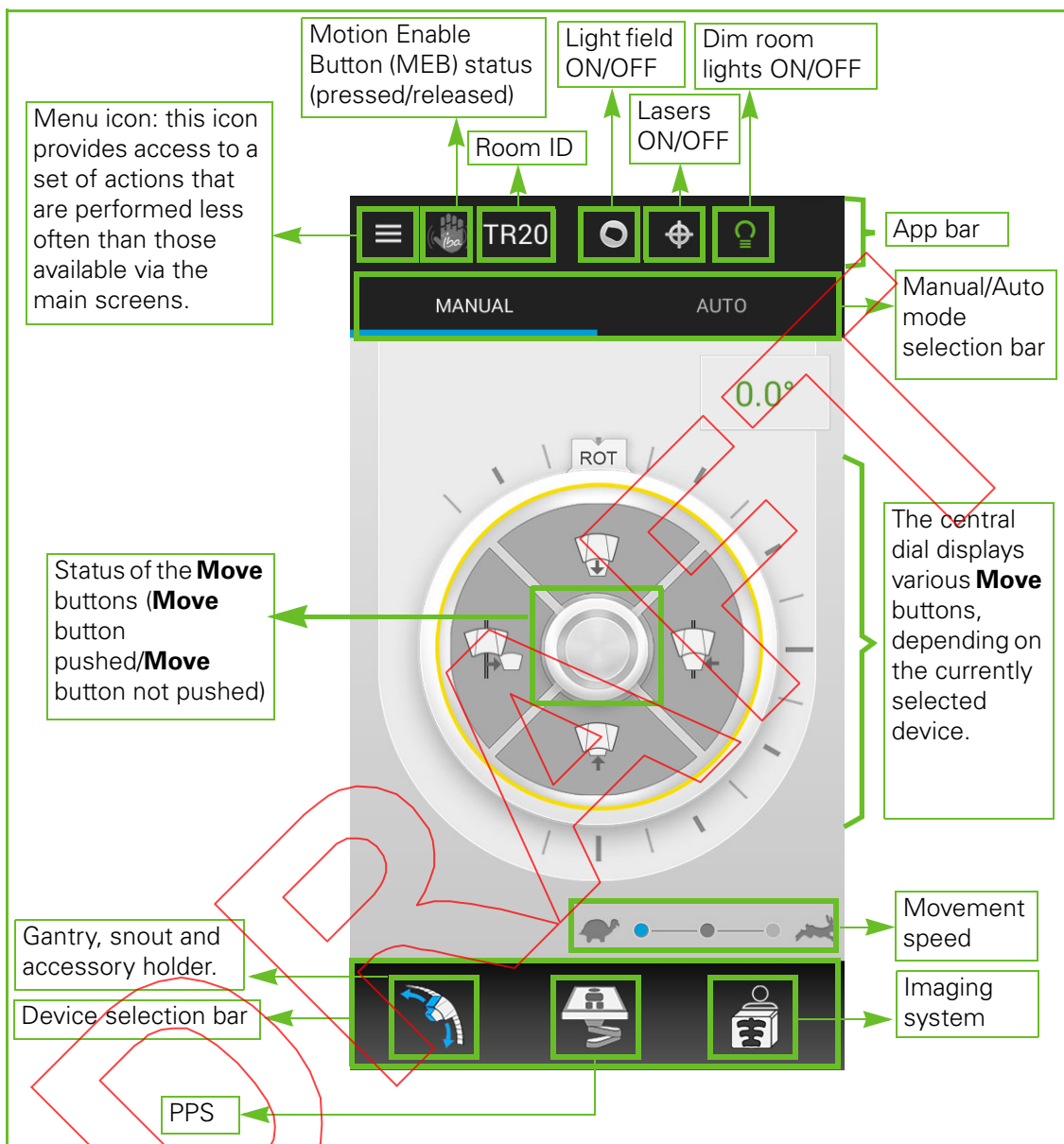

Figure 8-2. Wireless Hand-Pendant GUI Screen (typical)

Remote Positioning Controls Panel

The remote positioning controls panel appears on the right of all the adaPT*deliver* screens.

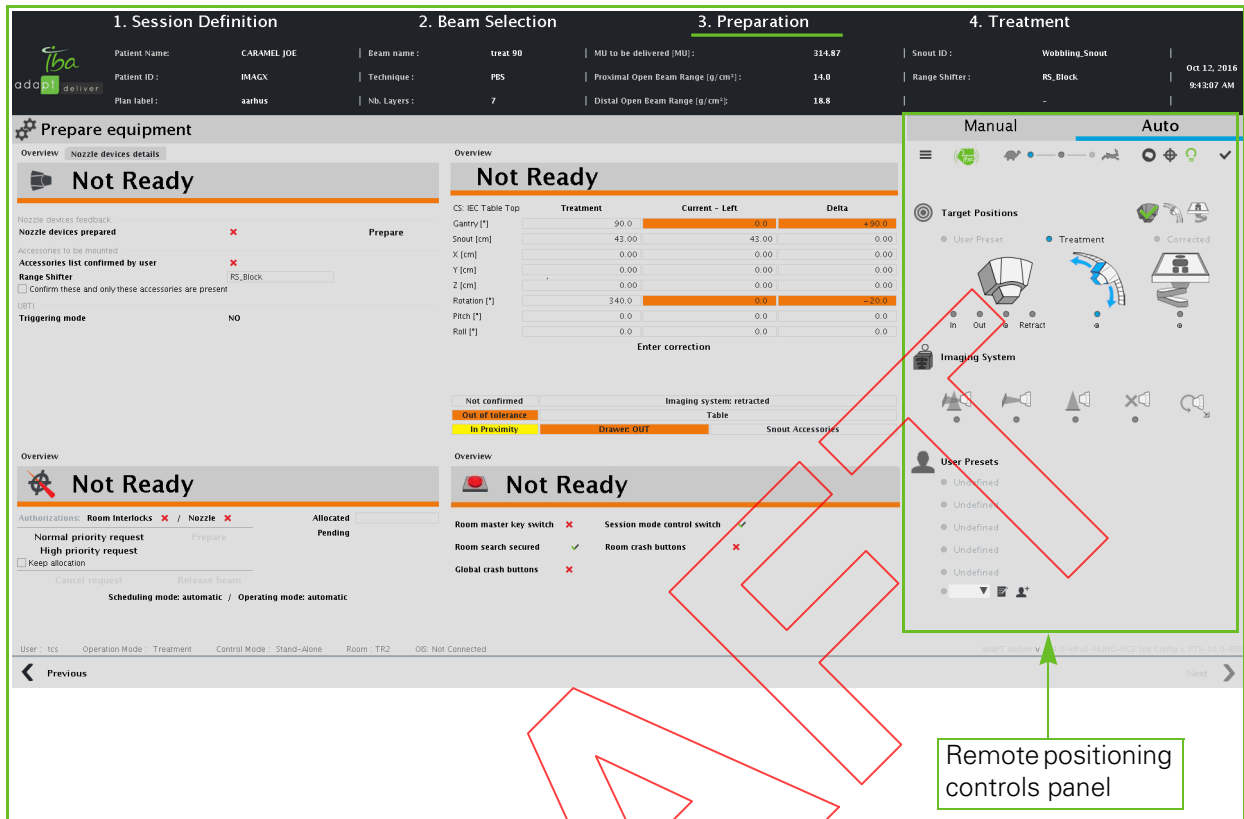

Figure 8-3. Remote Positioning Controls Panel in adaPTdeliver Screen (typical)

The remote positioning controls panel, both in Manual and Auto modes, has a series of main features (see Figure 8-4).

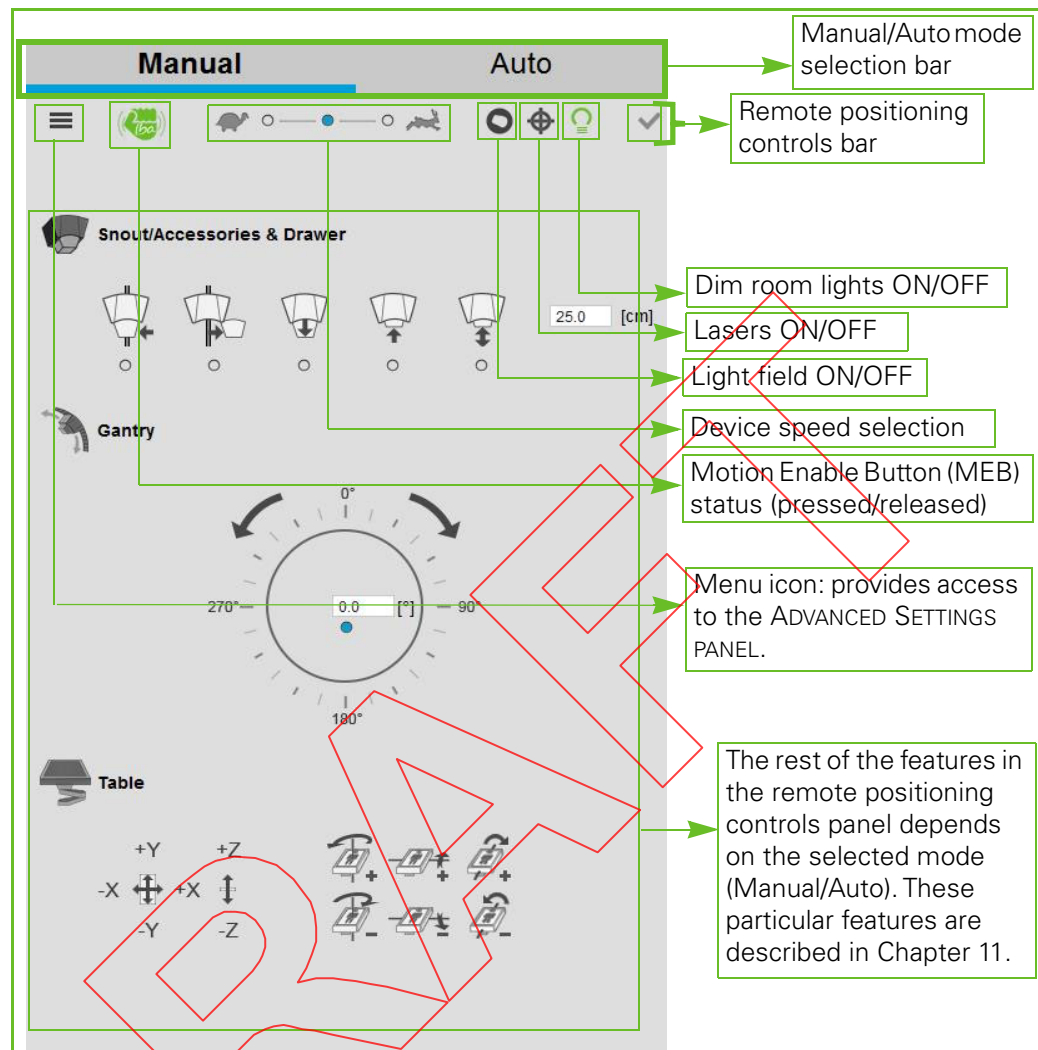







Figure 8-4. Remote Positioning Controls Panel - Main Features (typical)

App Bar (Wireless Hand-Pendant) and Remote Positioning Controls Bar Icons

The wireless hand-pendant **App bar** and the **remote positioning controls bar** feature a series of common icons. These icons are described in Table 8-1.

Table 8-1. Wireless Hand-Pendant App Bar and Remote Positioning Controls Bar: Common Icons

Icon	Meaning
	Menu
	Indicates the status of the Motion Enable Button (Pressed/Not Pressed)
	Switches the light field ON/OFF
	Switches the lasers ON/OFF
	Dims/undims room lights
	Confirms position

Understanding Colors in the Wireless Hand-Pendant GUI and Remote Positioning Controls Panel

The color legend detailed in Table 8-2 applies to all of the wireless hand- pendant GUI screens as well as to the remote positioning controls panel.

Table 8-2. Wireless Hand-Pendant GUI and Remote Positioning Controls Panel-Color Legend

Feature	Color	Meaning	Explanation
General	Light gray	Function disabled/not selectable	When due to the current circumstances a particular option or set of options is disabled (e.g., high speed is not selectable when a proximity situation is detected, remote positioning controls are disabled when the wireless hand- pendant is being used, etc.), the corresponding icon(s) or button(s) appear(s) in light gray and are not selectable (see Figure 8-5).
Mode selection bar	Blue	Mode selected	When a mode is selected, it becomes underlined by a blue trait.
	Gray	Mode not selected	When a mode is not selected, the word 'Manual' or 'Auto' appears on a gray background.
App bar (wireless hand- pendant)/Remote positioning controls bar	Green	Feature is active	Depending on the icon in the remote positioning controls bar: MEB pressed/ light field on/ laser crosswire on/ lights dimming on.
	Gray	Feature is not active	Depending on the icon in the remote positioning controls bar: MEB not pressed/ light field off/ laser crosswire off/ lights dimming off.

Table 8-2. Wireless Hand-Pendant GUI and Remote Positioning Controls Panel-Color Legend (Cont'd)

Feature	Color	Meaning	Explanation
Movement speed selection	Blue	Speed selected	When a speed is selected, the dot next to the corresponding icon (turtle for low speed, hare for high speed) or the 'medium speed' dot turns blue.
	Gray	Speed not selected	When a speed is not selected, the dot next to the corresponding icon (turtle for low speed, hare for high speed) or the 'medium speed' dot is gray.
	Light gray	Speed not selectable	When a speed is not selectable in the current circumstances (e.g., high speed is not selectable when a proximity situation is detected), the dot next to the corresponding icon (turtle for low speed, hare for high speed) or the 'medium speed' dot is light gray.
Device selection	Blue	Device selected and ready for movement	When a device is selected and ready for movement, the corresponding icon becomes highlighted with some blue traits.
	Orange	Device selected and not ready for movement	When a device is selected but not ready for movement (e.g., the gantry needs to be homed), the corresponding icon becomes highlighted with some orange traits.
	Red	Device selected and in error	When a device is selected but in error, the corresponding icon becomes highlighted with some red traits.

The color legend detailed in Table 8-3 applies to all of the wireless hand-pendant GUI screens.

Table 8-3. Wireless Hand-Pendant - GUI Color Legend

Feature	Color	Meaning	Explanation
Central dial	Gray	No proximity or collision situation detected	When neither a proximity nor a collision situation is detected, the circle surrounding the central dial is gray.
	Yellow	Proximity situation detected	When a proximity situation is detected, the circle surrounding the central dial turns yellow, as is the case in Figure 8-2.
	Red	Collision situation detected	When a collision situation is detected, the circle surrounding the central dial turns red.
Move buttons	Dark Blue	Button is not pressed.	When a Move button in the central dial is not being pressed, its border at the center of the central wheel is highlighted by a dark blue line.
	Light Blue	Button is pressed and movement is authorized.	When a Move button in the central dial is being pressed and movement is authorized, its border at the center of the central wheel is highlighted by a light blue line.

The color legend detailed in Table 8-4 applies to the remote positioning controls.

Table 8-4. Remote Positioning Controls - Color Legend

Feature	Color	Meaning	Explanation
Target position selection (Auto mode)/ Movement selection (Manual mode)	Blue	Target selected/Movement selected	When a target position (Auto mode) or a movement (Manual mode) is selected, the dot corresponding to the selected target or the arrow or label corresponding to the selected movement becomes highlighted in blue.
	White	Target not selected/Movement not selected	When a target position (Auto mode) or a movement (Manual mode) is not selected, the dot corresponding to the target or the arrow or label corresponding to the movement is displayed in gray.

Understanding Auditive Signals

The remote positioning controls and wireless hand-pendant produce the following auditive signals.

Table 8-5. Wireless Hand-Pendant and Remote Positioning Controls - Auditive Signals

Signal	Meaning	Explanation
Single short beep	Target position reached by a PPD.	A given PPD has reached its target position.
Double short beep	Target position reached by all PPDs.	All PPDs have reached the target positions required.
Single long beep	Error.	There is a device or system error or a warning message.

Understanding Vibration Signals of the Wireless Hand-Pendant

The remote wireless hand-pendant produces the following vibration signals.

Table 8-6. Wireless Hand-Pendant - Vibration Signals

Signal	Meaning	Explanation
Short vibration	Movement starts.	The Move and Motion Enable Buttons are pressed and PPD movement starts.
	Target position reached by a PPD.	A given PPD has reached its target position.
Long vibration	Error.	There is a device or system error or a warning message.

Switching Command From the Wireless Hand-Pendant to the Remote Positioning Controls

When you are using the wireless hand-pendant, all of the options in the remote positioning controls panel are grayed out. You are hence unable to use the remote positioning controls.

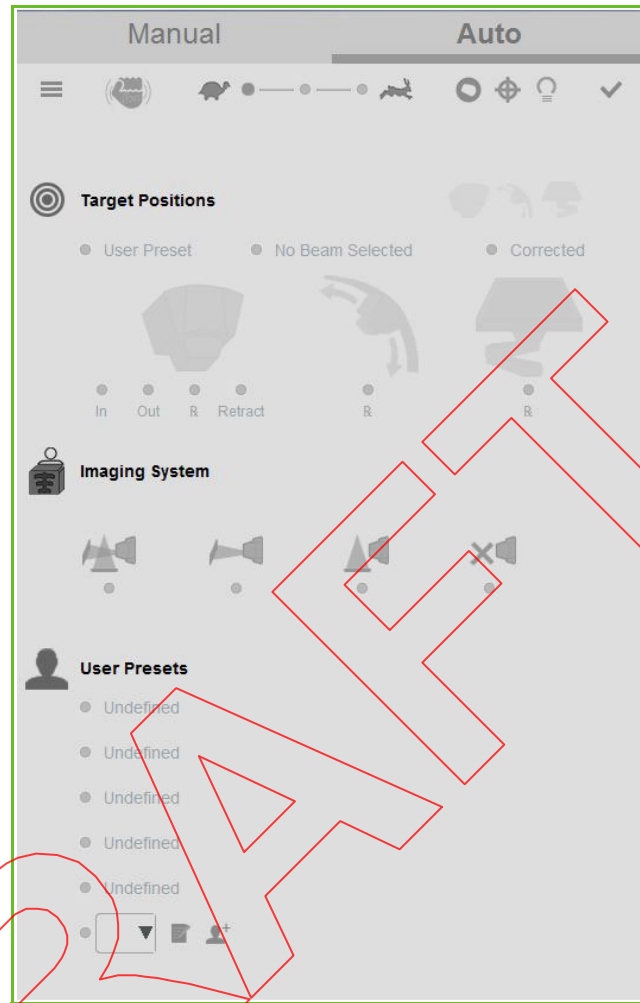

Figure 8-5. Remote Positioning Controls Panel - Disabled (typical)

To switch command to the remote positioning controls, press and release the **Motion Enable Button** (MEB) on the remote positioning hardware console.

As a result:

- the remote positioning controls are enabled
- the wireless hand-pendant is disabled

- the Locked - TCR hand-*pendant in use.* message appears on the wireless hand-*pendant display*

Note: *It is impossible to take over command when the **Motion Enable Button (MEB)** is pressed on the active hand-*pendant.**

Note: *It is impossible to take over command when the **Move** button on the X-ray generator hardware console is being pressed. In cases where the Cone-Beam Computed Tomography (CBCT) controls on the X-ray generator hardware console are locking the control, press the **Reset** button on the console.*

Switching Command From the Remote Positioning Controls to the Wireless Hand-Pendant

When you are using the remote positioning controls, the Locked - TCR hand-*pendant in use* message appears on the wireless hand-*pendant display.*

To switch command to the wireless hand-*pendant,* squeeze and release the **Motion Enable Button (MEB)** on the sides of the wireless hand-*pendant:*

- the wireless hand-*pendant is enabled*
- the remote positioning controls are disabled
- the Locked - TR hand-*pendant in use.* message appears on the remote positioning controls.

Note: *It is impossible to take over command when the **Motion Enable Button (MEB)** is being pressed on the remote positioning hardware console.*

Intentionally left blank

DRAFT

Chapter 9

Using the Wireless Hand-Pendant

.....

Note: Figures of the wireless hand-*pendant* GUI across this manual show a typical configuration (Gantry Treatment Room with snout and accessory drawer as well as with stereoscopic, portal and orthogonal imagery system). Some details may differ from the GUI displayed by the wireless hand-*pendant* in other room configurations. However, the principles explained apply to all GUI configurations.

The wireless hand-*pendant* is the device used to move the patient positioning devices and imaging equipment inside the Treatment Room (TR). It features a Graphical User Interface application and two buttons, one on each side. These are the **Motion Enable Buttons (MEB)**. The **MEB** enable you to confirm and enable, as a user, the execution of the movements commanded via the Graphical User Interface.



Figure 9-1. Wireless Hand-Pendant (typical)

The wireless hand-*pendant* can be docked for charging onto a docking station.



Figure 9-2. Wireless Hand-Pendant Docking Station (typical)

This chapter provides instructions on how to use the wireless hand-pendant, covering the following topics:

- *Safety Measures Specific to the Use of the Wireless Hand-Pendant*
- *Registering the Wireless Hand-Pendant*
- *Unlocking the Wireless Hand-Pendant*
- *Controlling Speed*
- *Stopping Movements*
- *Operating Modes: Auto and Manual*
- *Using the GUI in Auto Mode*
- *Using the GUI in Manual Mode*
- *Using Advanced Options From the Menu*
- *Colorblind Users: Negative Colors*

Note: Most motion control functions can also be used from the Treatment Control Room (TCR) using the remote positioning controls, which are displayed on adaPTdeliver screens. For more details on how to use the remote positioning controls, refer to Chapter 11. For detailed information on adaPTdeliver refer to **Part V**, "Using adaPTdeliver."

Note: Throughout this chapter, the color legend, auditive signals, and vibration signals described in Chapter 8 apply.

Safety Measures Specific to the Use of the Wireless Hand-Pendant

Make sure you read and understand the following warning and important messages before using the wireless hand-pendant.

WARNING	It is not allowed to activate movements with the wireless hand pendant when there is no visibility on the moving devices (e.g., it is not allowed to move the patient positioning devices from the maze).
	

WARNING	Stop using the wireless hand pendant and inform IBA personnel in case any unusual defect is observed on the wireless hand pendant.
	Defects can be (but are not limited to) unusual overheating of the device, leakage of substances, emission of fumes or gas, cracks in the hand pendant case.

Important	Other wireless devices could interfere with the wireless hand-pendant and are therefore proscribed in the treatment room. Interferences could lead to untimely and unexpected motion interruptions.
	While remaining safe, such situation could impede the normal use of the Proteus 235 system.
	If you experience loss of effectiveness or an unexpected stop of movements with the wireless hand-pendant, please move away emitters like mobile phones, laptops, etc.

Important	Do not use the wireless hand-pendant for another purpose than controlling Proteus 235 system. Do not connect the wireless hand-pendant manually to any Wi-Fi network. Do not connect the wireless hand-pendant to another Wi-Fi network than a Proteus PLUS treatment room.
	

Important	<p>When leaving the treatment room, you must always put the wireless hand-pendant back on its docking station. This ensures that the wireless hand-pendant remains protected from irradiation during treatment.</p>
	

Important	<p>The wireless hand-pendant is a failsafe device. In case of interruption of the communication between the wireless hand-pendant and the rest of the Proton Therapy System, any ongoing movement will be stopped.</p> <p>The loss of communication of the wireless hand-pendant is considered as a release of any currently pressed or tapped button. More specifically, if the system loses the communication with the wireless Motion Enable Button during a movement, it will stop and disable all motion in the treatment room.</p>
	

WARNING	<p>Use the wireless hand pendant always with the delivered IBA necklace or with an alternative reliable means to prevent the device falling down accidentally</p> <p>Falling of the wireless hand pendant can cause severe damages, including</p> <ul style="list-style-type: none"> - Damage to the battery - Degradation inducing hazardous faulty behaviour.
	

Registering the Wireless Hand-Pendant

In order to use the wireless hand-pendant in a given treatment room, it is necessary to register it to that treatment room.

When as part of the registration process the application connects via Wi-Fi to the Proton Therapy System, it retrieves the room configuration of the room to which it is currently registered. The room configuration includes the list of the installed devices and their type. Based on this information, the application adapts itself to provide

controls that match the current room configuration. For this reason, there are as many possible GUI configurations as there are room configurations. The same wireless hand-pendant can be used in any treatment room as long as it has been successfully registered to that treatment room.

The registration process guarantees that only one wireless hand-pendant is allowed to send commands in a given treatment room.

The registration of a wireless hand-pendant to a given room is not possible if another user is pressing the motion enable buttons on an already registered wireless hand-pendant, irradiation is ongoing or the registration of another wireless hand-pendant is ongoing. This rule guarantees that it is not possible to interfere with a user sending commands to the Proton Therapy System.

When you enter a Treatment Room with a wireless hand-pendant that is not registered, the wireless hand-pendant automatically prompts you to register it by displaying the **Register** button, which enables you to start the registration procedure.

Although several wireless hand-pendants may be present in a given treatment room and they may all be connected to the wireless network, only one wireless hand-pendant can be registered to a single treatment room at any given time. The registered wireless hand-pendant is the only one authorized and able to move treatment room equipment.

Registration Procedure

In order to register a wireless hand-pendant to a given treatment room, proceed as follows:

1. Once the wireless hand-pendant is in the treatment room, it automatically connects to the treatment room Wi-Fi network. The following screen appears:

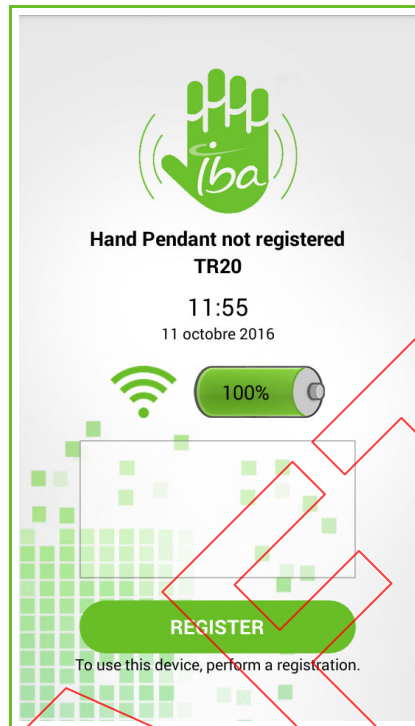

Figure 9-3. Wireless Hand-Pendant Connected - Not Registered

2. Touch the **REGISTER** button. The REGISTRATION PROCEDURE SCREEN appears. This screen features some animated instructions that illustrate the sequence of operations that needs to be performed in order to complete the registration.

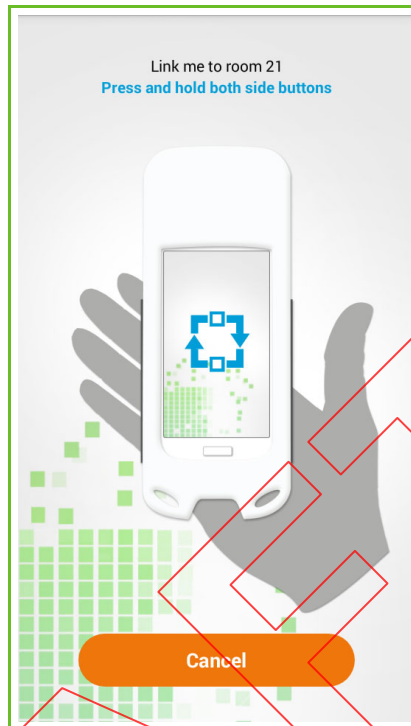

Figure 9-4. Registration Procedure Screen (typical)

3. Follow the animated instructions on the REGISTRATION PROCEDURE SCREEN:

- a. Press and hold both side buttons.
- b. Release one of the side buttons.
- c. Press and hold both side buttons.
- d. Release the side button that was not released in Step b.

4. After 5 seconds, the REGISTRATION PROCEDURE SCREEN is closed and the locked screen appears:

- If the registration was performed successfully, you are able to unlock and use the device. To unlock the device, proceed as detailed in section *Unlocking the Wireless Hand-Pendant*.
- If the registration was not performed successfully, you can execute the registration procedure again by touching the **REGISTER** button (see Figure 9-3).

Registration Consequences

Only one wireless hand-pendant can be registered to a single treatment room at any given time. The successful registration of a wireless hand-pendant to a given treatment room has the following consequences:

- The wireless hand-pendant that was previously registered in this treatment room is automatically unregistered.
- The newly registered wireless hand-pendant is automatically unregistered from any other treatment room it was previously registered to.

Note: *It is not possible to register a wireless hand-pendant to a treatment room if a user is currently pressing the motion enable buttons of the wireless hand-pendant currently registered to that same treatment room.*

Unlocking the Wireless Hand-Pendant

In order to unlock the wireless hand-pendant, swipe as indicated on the locked screen.

Note: *Once a wireless hand-pendant is registered to a given treatment room and unlocked, it is automatically locked after 5 minutes of inactivity.*

Controlling Speed

Each patient positioning device (PPD) may be moved at the following speeds:

- **low** speed: always possible.
- **medium**: not possible during homing.
- **high**: not possible when a device is in a situation of proximity.

In case high speed cannot be selected, it could be due to the following:

- Device must be homed
- A retractable device is positioned between the inserted and retracted position (DID panel, drawer, etc.)
- A device may be moving too close to another device

Note: *Certain activities like homing the gantry or taring the PPS cannot be performed at all speeds.*

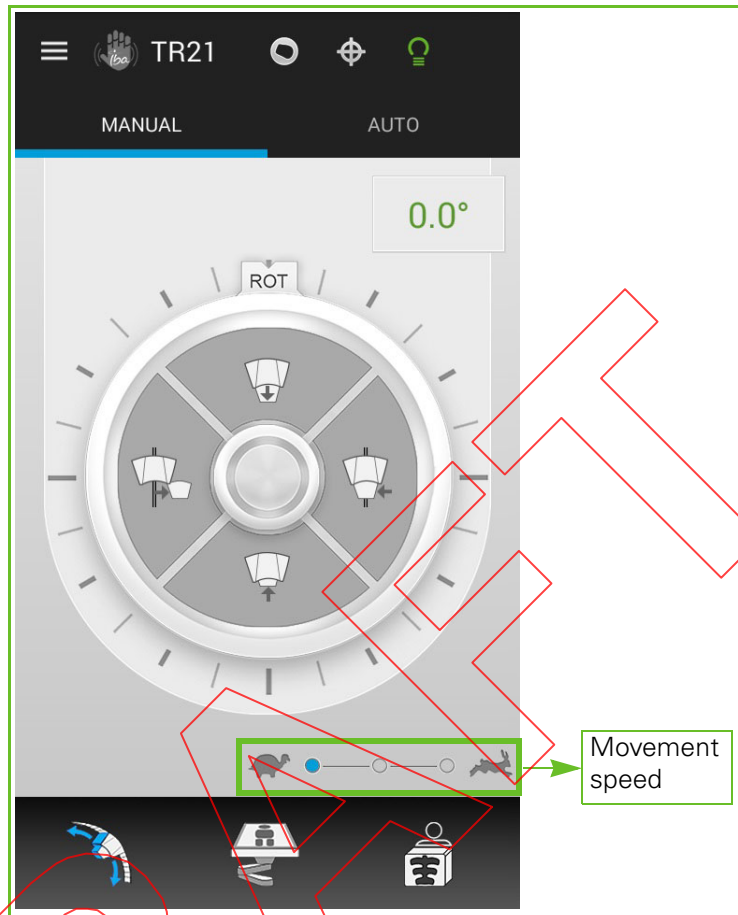

Figure 9-5. Movement Speed Icons



To choose the high speed option, touch the dot next to the 'hare' icon.

Alternatively, to choose the low speed option, touch the dot next to the 'tortoise' icon.

Alternatively, to choose the medium speed option, touch the dot between the high and low speed options.

The dot corresponding to the currently selected speed is highlighted in blue.

Table 9-1. Movement Speeds

Icon	Speed
	High speed ('hare' icon)
	Medium speed
	Low speed ('tortoise' icon)

Note: The speed of the device remains set to the last speed used until a different speed is selected.

Note: The proximity control software may automatically switch the speed of a device from high speed to medium speed in certain circumstances.

Stopping Movements



The following methods are available to stop movements of the Proton Therapy System (PTS) equipment when using the wireless hand- pendant:

- Release the **Move** button that is currently being pressed on the wireless hand- pendant.
- Release the **Motion Enable Buttons** on the wireless hand- pendant.
- Press an **emergency stop button**.

WARNING	If a patient is not safely secured to the PPS, the patient may fall off. Each patient shall be safely secured before moving the PPS.
	

Release the Move Device Button

If the currently pressed **Move** button is released during Patient Positioning Device (PPD) movement, the PPD performs a normal stop.

Release the Motion Enable Buttons

If the **Motion Enable Buttons** are released during Patient Positioning Device (PPD) movement, the PPD performs an emergency stop. If you release these buttons before releasing the currently pressed **Move** button, the motion stops abruptly.

Only press the **Motion Enable Button** when the patient is safely restrained on the couch or outside the moving equipment operating range.

The movement can be resumed by pressing the **Motion Enable Buttons**, followed by the chosen **Move** button.

Press an Emergency Stop Button

Note: Emergency stop buttons and TSS interlocks exist on a level local to your treatment room and system-wide. The description in this section pertains to the local level only.

WARNING



Emergency stop buttons shut off energy to most components in the Proton Therapy System (PTS). However, the electrical power to some components will not be interrupted, so be aware that electrical hazards and faults (faulty parts made live or induced fire) may still be present.

If an emergency stop button local to your treatment room is pressed during Patient Positioning Device (PPD) movement, motion stops immediately.

After using an emergency stop button local to your treatment room to stop the PPDs, the emergency stop button and the Therapy Safety System (TSS) must be reset.

After the emergency stop button and TSS are reset, the following may also be required:

- Recovery enabling beam production
- Recovery of gantry movement (for GTR only)
- Recovery of PBS Dedicated snout and PPS movements
- Recovery enabling beam in TR
- Recovery enabling X-ray high-voltage
- Verification of proper operation
- Successful daily calibrations (e.g., variable collimators)

Operating Modes: Auto and Manual

The wireless hand-pendant can be used in two different operation modes:

- **Auto mode:** using Auto mode, you may perform Auto motions to prescribed or user-defined target positions.

For detailed information on Auto motions, refer to Chapter 6.

Note: Only those target positions for which conditions are currently met are available using Auto mode.

- **Manual mode:** using Manual mode, you may perform Manual motions to positions that are not predefined.

For detailed information on Manual motions, refer to Chapter 6.

Both Auto and Manual modes give you access to the motion of the imaging devices.

Note: The digital imaging devices screen is identical in Auto and Manual mode.

The Auto and Manual operating modes may also be available in the remote positioning controls (Manual mode available upon request). For more details on how to use the remote positioning controls, refer to Chapter 11.

Prerequisite: Selecting a Device

Before selecting an operating mode, select your device from the device selection bar at the bottom of the WIRELESS HAND-PENDANT GUI SCREEN (see Figure 8-2).

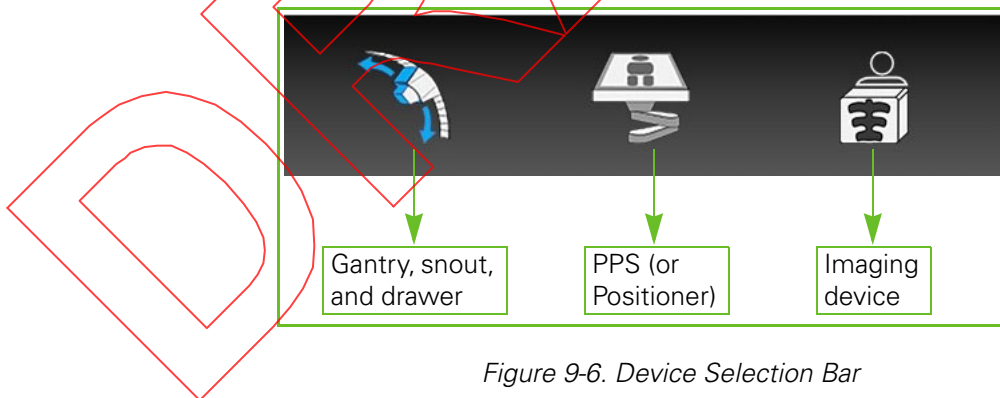

Figure 9-6. Device Selection Bar

A selected device appears in blue on the screen. For example, in Figure 9-6 the gantry, snout, and drawer are selected.

Using the GUI in Auto Mode

Auto mode enables you to perform Auto motions to patient-specific and non patient-specific target positions.

To select Auto mode, proceed as follows:

1. Touch the **Auto** option on the hand-pendant mode selection bar.

Auto option becomes highlighted by a blue line and the default Auto mode screen appears.

Auto Mode Target Positions

A target position may be one of the following:

- **User preset:** a user preset is a target position defined by the user. The label of a user preset is the name of the preset as defined by the user.
- **Setup position:** setup positions are defined in the Treatment Plan and associated to setup beams. As such, a setup position is only available as a target position when a setup beam is selected and the preparation for the setup beam has started.
- **Treatment position:** treatment positions are associated to treatment beams. As such, a treatment position is only available as a target position when a treatment beam is selected and the preparation for the treatment beam has started.
- **Corrected position:** a corrected position becomes available once a given treatment or setup position has been corrected using the Patient Position Verification System (PPVS), adaPTinsight. As such, a corrected position is only available as a labeled target position when a treatment or setup beam is selected and after the alignment process is complete.

Depending on the stage of the workflow, you may choose among the available target positions.

Selecting a Target Position

All prescribed and user-defined target positions are available in the menu accessible via the **Menu** icon located at the top left of the screen.

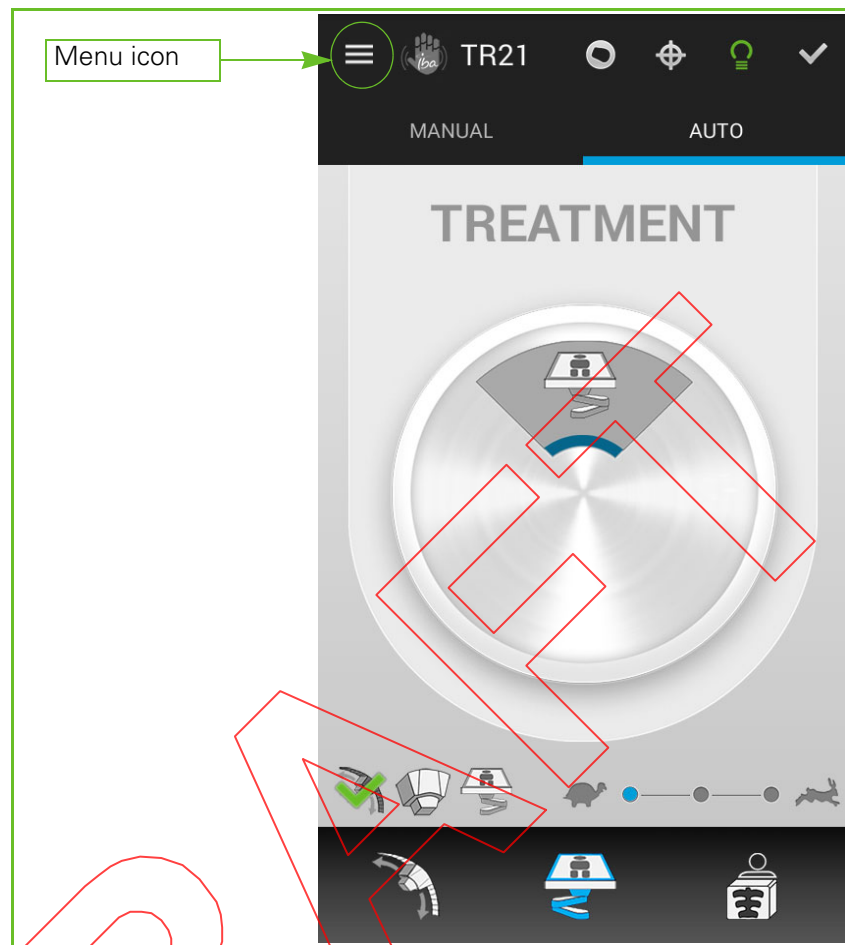

Figure 9-7. Menu Icon (typical)

To select a target position from the menu, proceed as follows:

1. Touch the **Menu** icon on the top left of the screen.
2. Touch the prescribed or user-defined target position that you want to select.

The selected prescribed or user-defined target position is highlighted in blue.

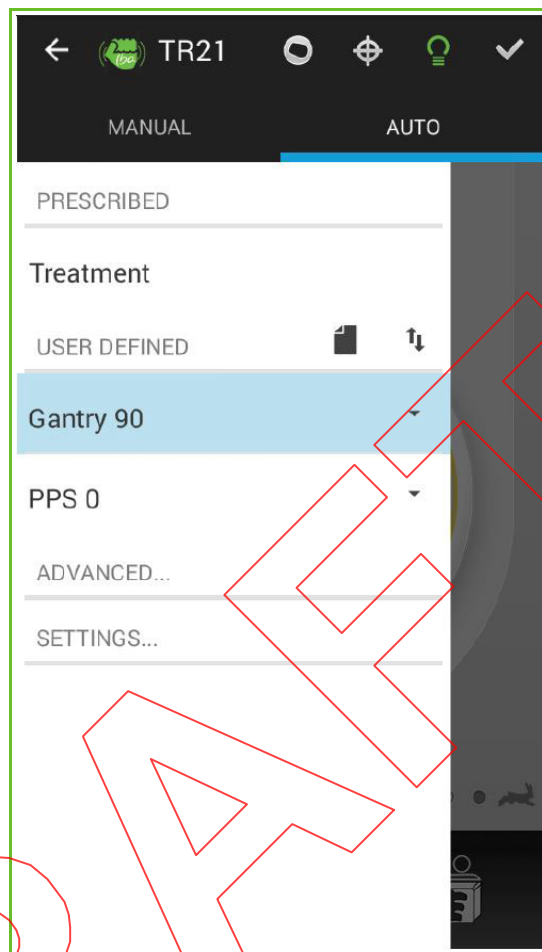

Figure 9-8. Menu (typical)

Once you choose a prescribed or user-defined target position, you are able to move the patient positioning devices that need to be moved in order to reach the selected position, one by one, using the different device screens in Auto mode.

Selecting and Moving a Patient Positioning Device

In Auto mode, the only movement possible for every device is the one required for it to reach the selected target position.

At the bottom left of every device screen, the GUI displays the icons of all the devices that need to be moved in order to reach the selected target position. The icons of those devices that have not been moved to the target position yet are displayed in gray. Those that have already been moved to the target position are displayed with a green check mark overlaid.

PPS Screen

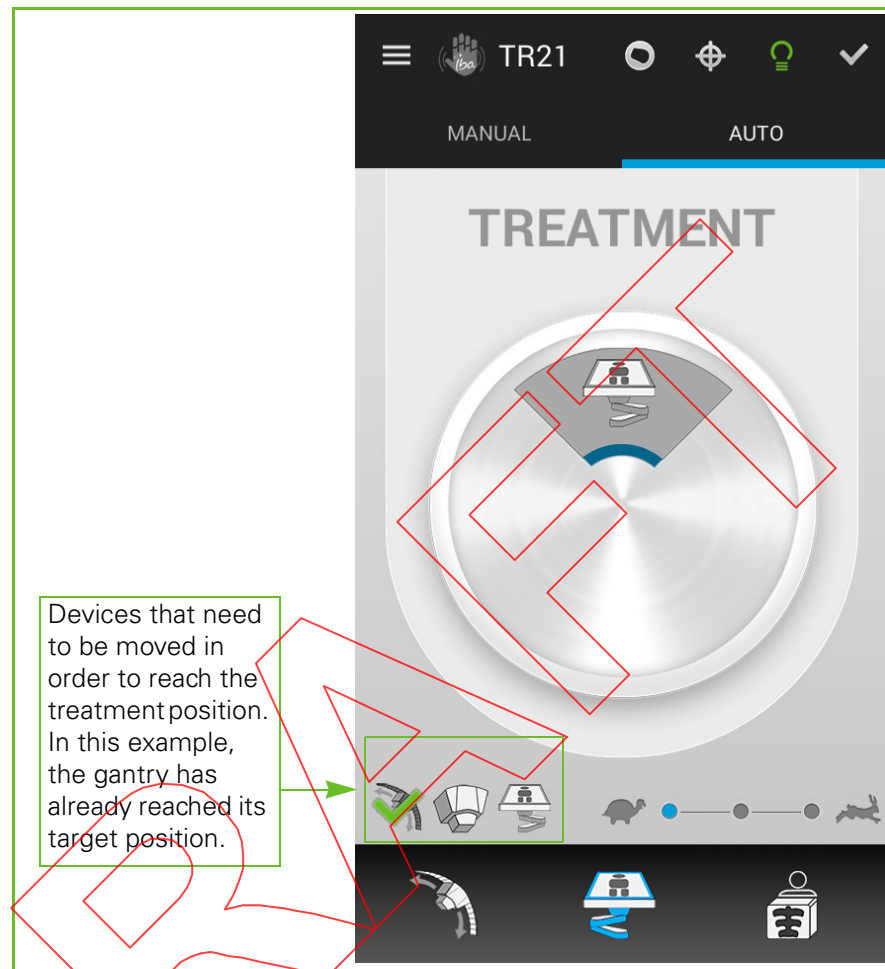

Figure 9-9. Treatment Position - Auto Mode (PPS screen)

Figure 9-9 shows the PPS screen in Auto mode, with a treatment position selected. The GUI application always enables the user to switch back and forth between Manual and Auto modes.

Gantry, Snout, and Drawer Screen

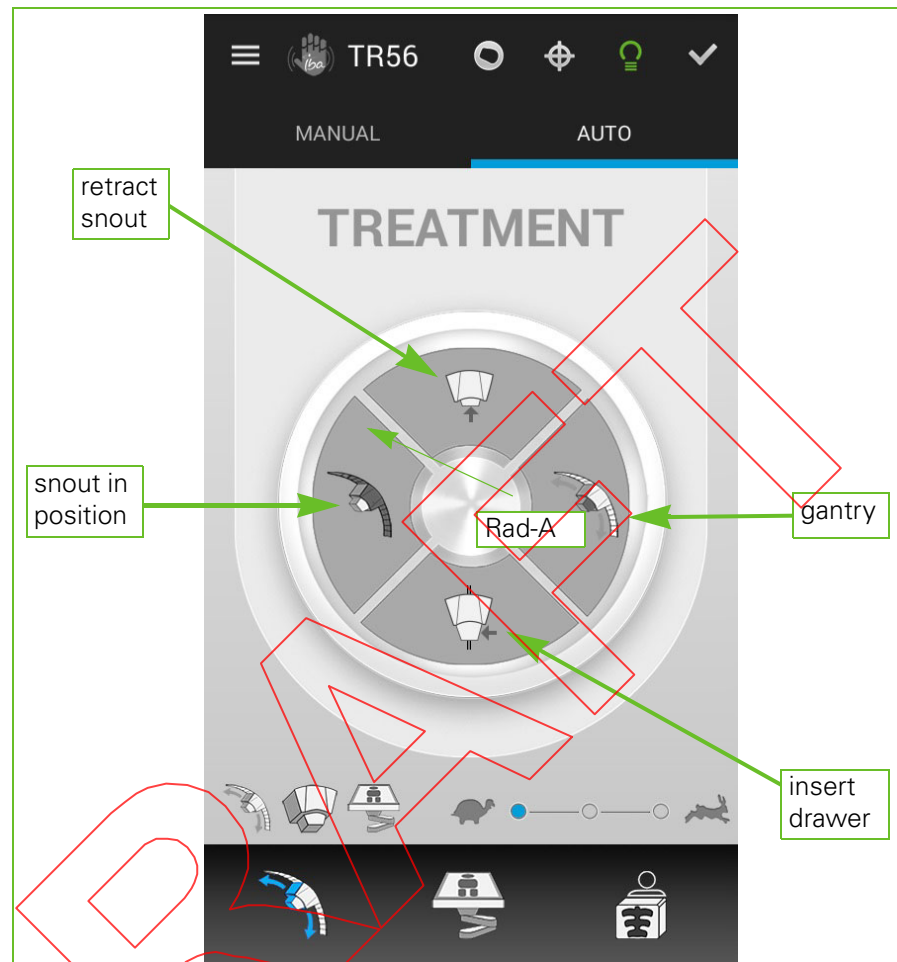

Figure 9-10. Treatment Position - Auto Mode (Gantry, Snout, Drawer screen)

Figure 9-10 shows the Gantry, Snout, and Drawer screen in Auto mode, with a treatment position selected.

Selecting and Moving a Device

In order to select the patient positioning device that you want to move, proceed as follows:

1. Touch the icon corresponding to the device that you want to move on the device selection bar at the bottom of the screen.

The screen corresponding to that particular patient positioning device appears.

In order to move the selected patient positioning device to the selected target position, proceed as follows:

1. Touch and hold the **Move** button.
2. While holding the **Move** button, press and hold the **MEB** buttons on the wireless hand-pendant until the device reaches the target position.

Creating User-Defined Positions

User-defined positions enable you to define new positions to fit your user needs.

Using the menu, it is possible to create new user-defined positions, arrange the list of existing user-defined positions and delete, copy or modify existing user-defined positions.

In order to create a new user-defined position, proceed as follows:

1. Touch the **Menu** icon at the top left of the screen in order to display the menu.
2. Touch the **New** icon in order to access the NEW POSITION SCREEN.

DRAFT

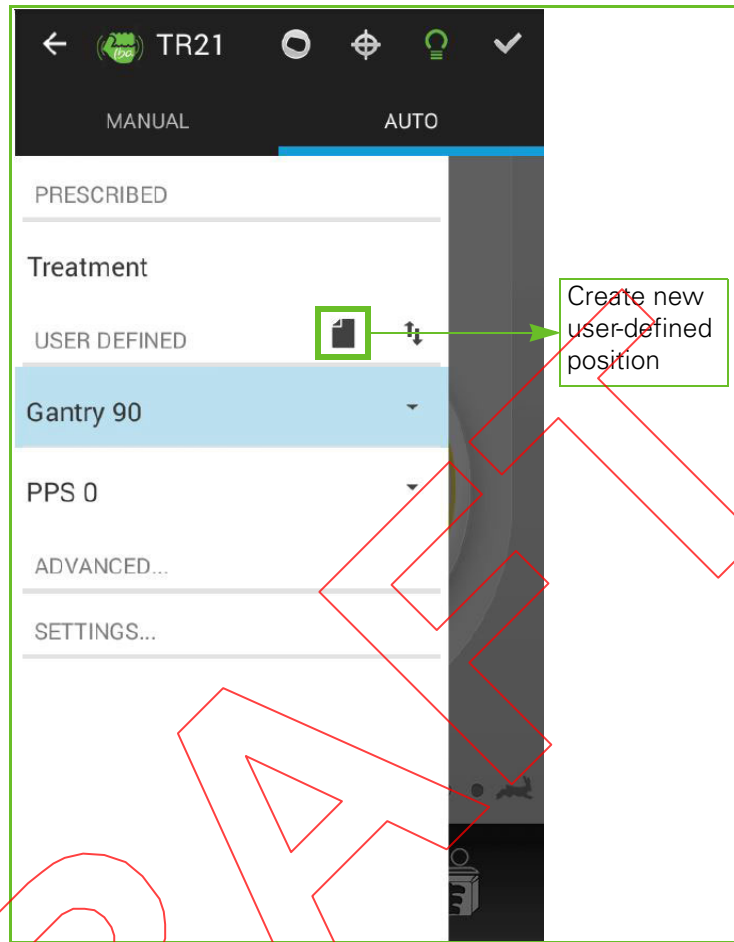

Figure 9-11. Creating a User-Defined Position (typical)

Figure 9-12 shows the NEW POSITION SCREEN, the interface that enables you to create a new user-defined position or to modify an existing one.

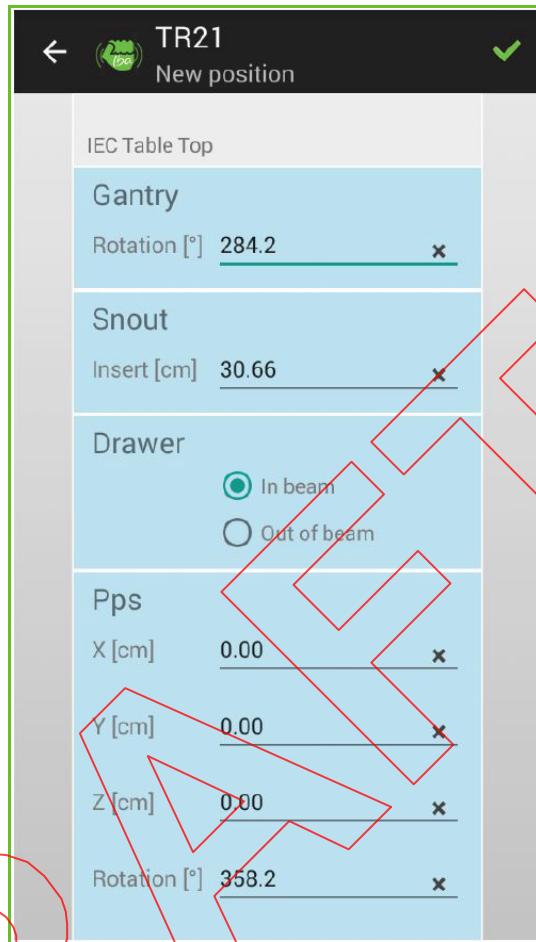

Figure 9-12. New Position Screen (typical)

3. Fill in the required fields.

Note: The fields in the NEW POSITION SCREEN are automatically filled with the current position of the equipment. You may modify this information, as necessary.

4. To select the devices that you require to be included in a new user-defined position (i.e., the devices that shall have an assigned target when the user-defined position is selected), proceed as follows:

- a. Touch the section corresponding to the device(s) that you wish to include in the new position.

The background color toggles between blue and white. Device section(s) with a blue background are included in the new user-defined position. Device section(s) with a white background are not included in the new user-defined position.

- b. Enter the required position for each selected device.

Note: When a user-defined target position is selected, you are only able to select for movement those devices that are included in the target position (i.e., the devices that have an assigned target for the selected user-defined position).

5. Touch the (**Tick**) icon at the right of the app bar to save the newly created position.

You may also save the new position by touching the arrow at the left of the app bar or the return arrow at the bottom right of the screen.

6. You are prompted to enter a name for the newly created position. Enter an appropriate name and the new position is saved.

Managing Prescribed and User-Defined Positions

Using the menu, it is possible to create a new user-defined position, arrange the list of existing user-defined positions and delete, copy or modify an existing user-defined position.

In order to arrange the list of user-defined positions, proceed as follows:

1. To display the menu, touch the **Menu** icon at the top left of the screen.

Note: Once the menu is open, the **Menu** icon is replaced by an arrow pointing to the left (see Figure 9-13). You may touch this arrow to close the menu.

2. To be able to arrange the existing positions, touch the **Arrange** icon.

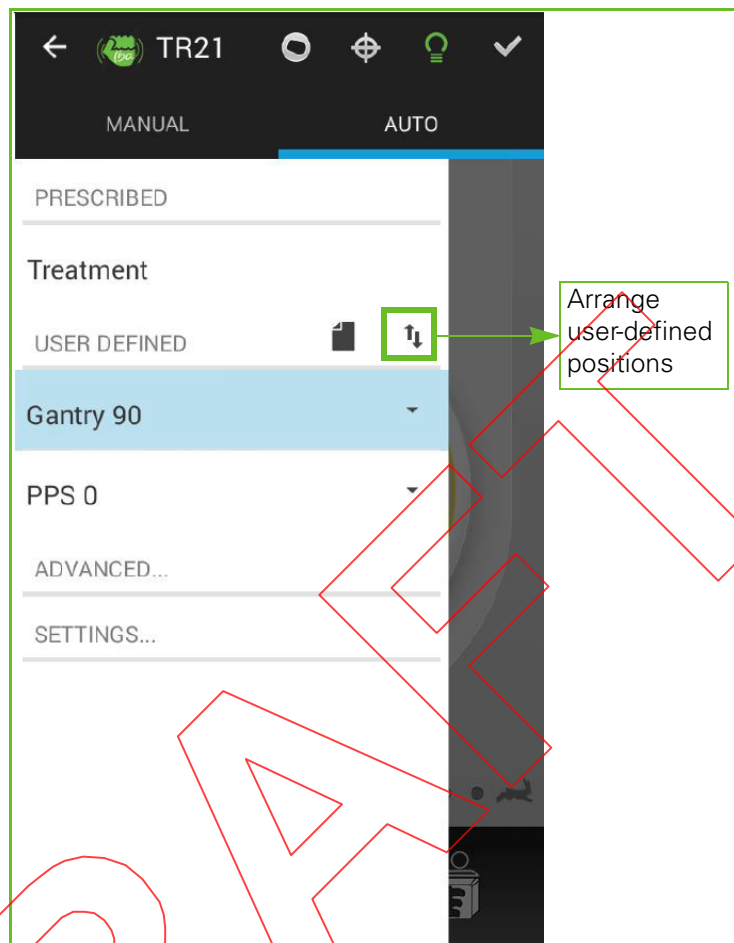

Figure 9-13. Arranging User-Defined Positions (typical)

3. To arrange the existing positions, drag each position to the order that suits your preferences.

In order to delete an existing user-defined position, proceed as follows:

1. To display the menu, touch the **Menu** icon at the top left of the screen.
2. To be able to delete a particular position, touch the arrow located to the right of the user-defined position that you want to delete.
3. To delete the user-defined position, touch the **Delete** icon.

A pop-up message prompts you to confirm your action.

In order to copy an existing user-defined position, proceed as follows:

1. To display the menu, touch the **Menu** icon at the top left of the screen.
2. To be able to copy a particular position, touch the arrow located to the right of the user-defined position that you want to copy.

3. To copy the user-defined position, touch the **Copy** icon.

You are now able to create a new user-defined position using the NEW POSITION SCREEN. All the fields in this screen are automatically filled out with the values corresponding to the copied user-defined position. You may modify these values as you consider appropriate.

4. Touch the (**Tick**) icon at the right of the app bar to save the new user-position.

You may also save the changes by touching the arrow at the left of the app bar or the return arrow at the bottom right of the screen. In these cases, you are prompted to confirm whether or not you want to save the changes before leaving the NEW POSITION SCREEN.

In order to edit an existing user-defined position, proceed as follows:

1. To display the menu, touch the **Menu** icon at the top left of the screen.
2. To be able to edit a particular position, touch the arrow located to the right of the user-defined position that you want to edit.
3. To edit the user-defined position, touch the **Edit** icon.

You are now able to modify the user-defined position using the USER-DEFINED POSITION EDITING SCREEN.

4. Touch the (**Tick**) icon at the right of the app bar to save the changes to the user-position.

You may also save the changes by touching the arrow at the left of the app bar or the return arrow at the bottom right of the screen. In these cases, you are prompted to confirm whether or not you want to save the changes before leaving the USER-DEFINED POSITION EDITING SCREEN.

Using the GUI in Manual Mode

Manual mode enables you to perform equipment movements that do not require any particular patient information or user presets. This covers Manual motions as well as certain Auto motions (the insertion/retraction of various pieces of equipment, gantry Auto angle motions, etc.).

Note: All positions appear displayed according to IEC61217 (refer to "Supported Coordinate Systems" on page 7-3).

To select Manual mode, proceed as follows:

1. Touch the **Manual** option on the hand-pendant mode selection bar.

Manual option becomes highlighted by a blue line and the default Manual mode screen appears.

Using Manual Mode to Move the Gantry, the Accessory Drawer and the Snout

1. Touch the **Gantry, Accessory Drawer and Snout** icon on the device selection bar at the bottom of the screen.

Once the gantry, snout and accessory holder subsystem is selected, the interface displays four **Move** buttons in the central dial:

- The top and bottom buttons enable you to insert and retract the snout (**Insert Snout** button and **Retract Snout** button).
- The left and right buttons enable you to put the accessory drawer in or out of the beam path (**Move Accessory Drawer Into the Beam Path** button and **Move Accessory Drawer Out of the Beam Path** button).
- The **ROT** slider controls gantry rotation, which may be performed either clockwise or counter clockwise.

A target gantry position may be specified using the field above the central dial, on the right of the screen.

Note: *The GUI is designed to provide quick access to often used actions. Other actions are accessible using the Nav icon (top left of the screen).*

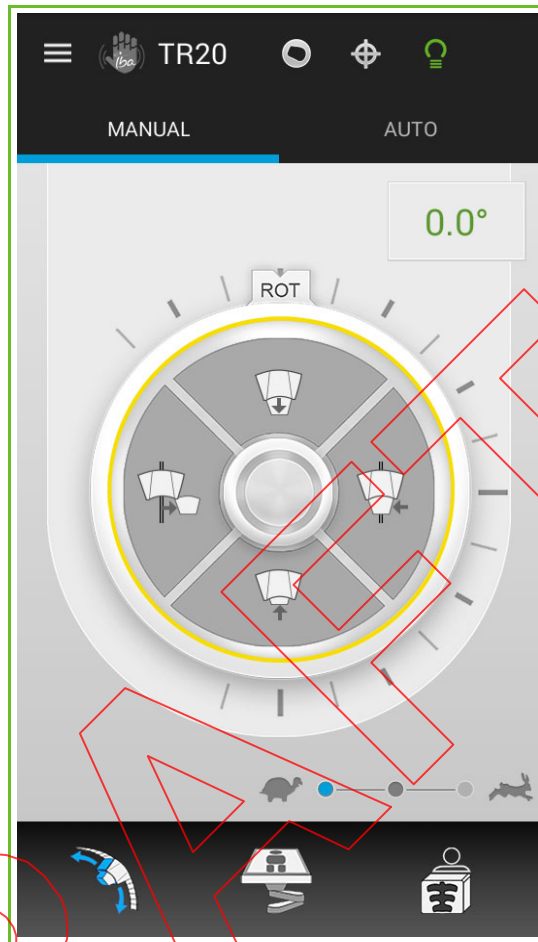

Figure 9-14. Gantry, Snout and Accessory Holder - Manual Mode (typical)

Moving the Gantry

The Gantry, Accessory Drawer and Snout commands enable you to move the gantry in several ways.

To move the gantry to a particular angle, proceed as follows:

1. Touch the field on the top right of the screen and enter a target gantry angle.
2. Touch and hold the central **Move** button.
3. While holding the central **Move** button, press and hold the **MEB** buttons on the wireless hand-pendant until the device reaches the target position.

To move the gantry clockwise or counterclockwise, proceed as follows:

1. Touch and hold the **ROT** tab on the **ROT** slider and slide it clockwise or counterclockwise, as necessary.

2. Hold the **ROT** tab until the device reaches the required position.
3. While holding the **ROT** tab, press and hold the **MEB** buttons on the wireless hand-pendant until the device reaches required position.

Moving the Accessory Drawer

Note: The system only enables you to move the accessory drawer when the snout is in a completely retracted position (the furthest possible from the isocenter).

To move the accessory drawer into the beam path, proceed as follows:

1. Touch and hold the **Move Accessory Drawer Into the Beam Path** button.

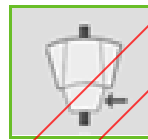

Figure 9-15. Move Accessory Drawer Into the Beam Path Icon

2. While holding the **Move Accessory Drawer Into the Beam Path** button, press and hold the **MEB** buttons on the wireless hand-pendant until the device reaches the required position.

To move the accessory drawer out of the beam path, proceed as follows:

1. Touch and hold the **Move Accessory Drawer Out of the Beam Path** button.

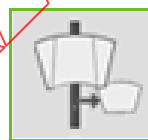

Figure 9-16. Move Accessory Drawer Out of the Beam Path Icon

2. While holding the **Move Accessory Drawer Out of the Beam Path** button, press and hold the **MEB** buttons on the wireless hand-pendant until the device reaches the required position.

Moving the Snout holder

To insert the snout, proceed as follows:

1. Touch and hold the **Insert Snout** button.



Figure 9-17. Insert Snout Icon

2. While holding the **Insert Snout** button, press and hold the **MEB** buttons on the wireless hand-pendant until the device reaches the position that you consider appropriate or motion is stopped by the software motion limits.

To retract the snout, proceed as follows:

1. Touch and hold the **Retract Snout** button.



Figure 9-18. Retract Snout Icon

2. While holding the **Retract Snout** button, press and hold the **MEB** buttons on the wireless hand-pendant until the device reaches the position that you consider appropriate or motion is stopped by the software motion limits.

Using Manual Mode to Move the PPS (Patient Positioning System)

Note: Manual PPS motions are executed along the Horizontal Table Top Coordinate System (HTTCS) axes.

1. Touch the **PPS** icon on the device selection bar at the bottom of the screen.

Once the PPS subsystem is selected, the interface displays four **Move** buttons in the central dial:

- The top and bottom buttons enable you to move the PPS along the Y axis (**Y+** button and **Y-** button).
- The left and right buttons enable you to move the PPS along the X axis (**X+** button and **X-** button).
- The **Z** slider controls PPS movement along the Z axis (positive movement if the slider is slid clockwise, negative movement if the slider is slid counterclockwise).

- The **ROT** slider controls PPS top rotation.

Note: By default, the GUI application displays the X, Y, Z and top rotation controls. You may access the pitch and roll view using the widget located above the central dial, on the left of the screen.

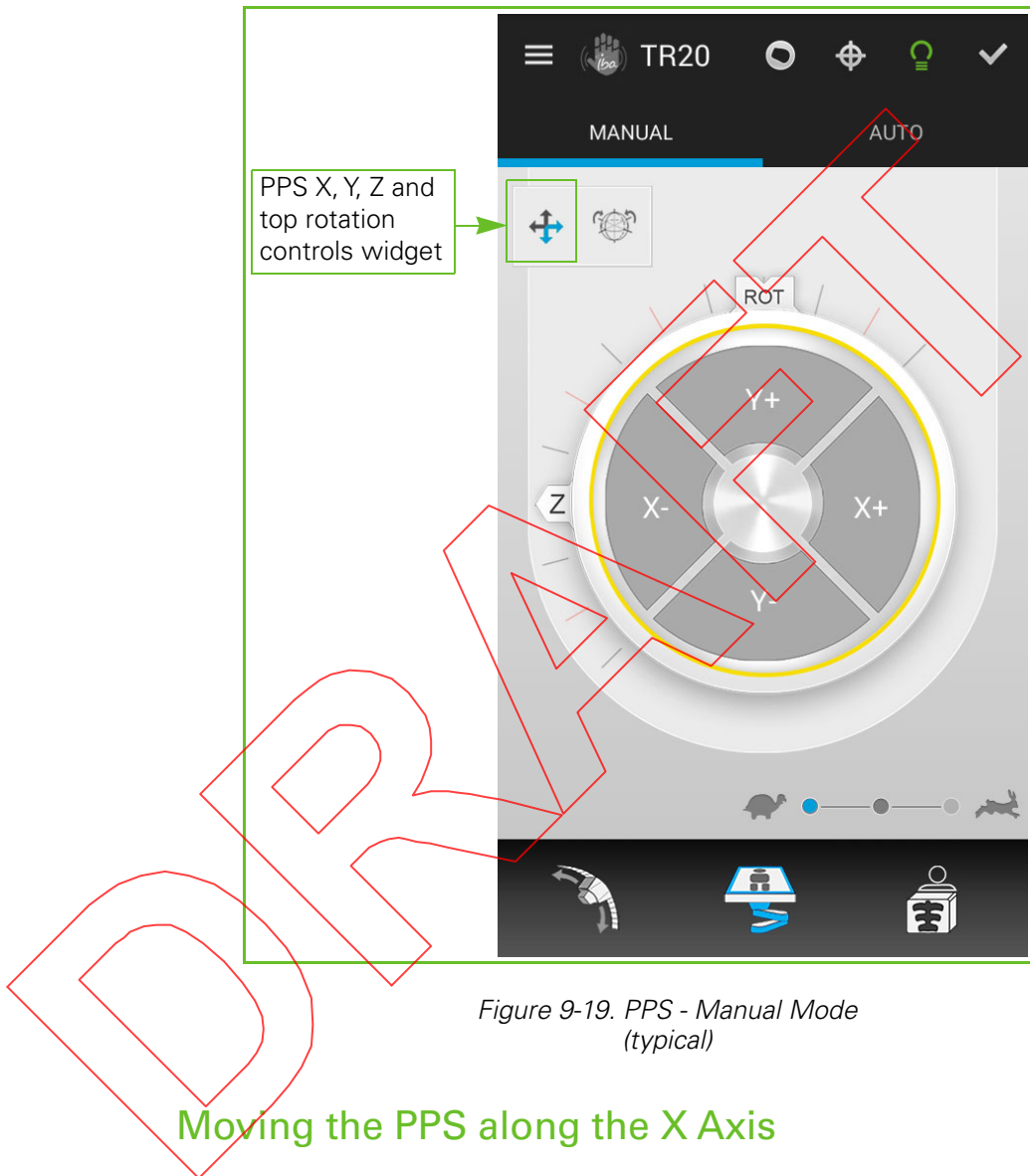

Figure 9-19. PPS - Manual Mode (typical)

Moving the PPS along the X Axis

To move the PPS along the X axis, proceed as follows:

1. To move the PPS in the + direction along the X axis, touch and hold the **X+** button.

Alternatively, to move the PPS in the - direction along the X axis, touch and hold the **X-** button.
2. While holding the **X+** or **X-** button, press and hold the **MEB** buttons on the wireless hand-pendant until the device reaches the required position.

Moving the PPS along the Y Axis

To move the PPS along the Y axis, proceed as follows:

1. To move the PPS in the + direction along the Y axis, touch and hold the **Y+** button.

Alternatively, to move the PPS in the - direction along the Y axis, touch and hold the **Y-** button.

2. While holding the **Y+** or **Y-** button, press and hold the **MEB** buttons on the wireless hand-pendant until the device reaches the required position.

Moving the PPS along the Z Axis

To move the PPS along the Z axis, proceed as follows:

1. Touch and hold the **Z** tab on the PPS Z slider and slide it in the desired direction (positive movement along the Z axis if the slider is moved clockwise, negative movement along the Z axis if the slider is moved counterclockwise).
2. While holding the **Z** tab, press and hold the **MEB** buttons on the wireless hand-pendant until the device reaches the required position.

Rotating the PPS Around the Isocenter

To rotate the PPS around the isocenter, proceed as follows:

1. Touch and hold the **ROT** tab on the PPS ROT slider and slide it in the desired direction (clockwise PPS rotation when looking at the couch from above if the slider is moved to the left, counterclockwise PPS rotation when looking at the couch from above if the slider is moved to the right).
2. While holding the **ROT** tab, press and hold the **MEB** buttons on the wireless hand-pendant until the device reaches the required position.

Pitching the PPS

To pitch the PPS, proceed as follows:

1. To access the PPS pitch and roll commands, touch the widget located above the central dial, on the left of the screen.

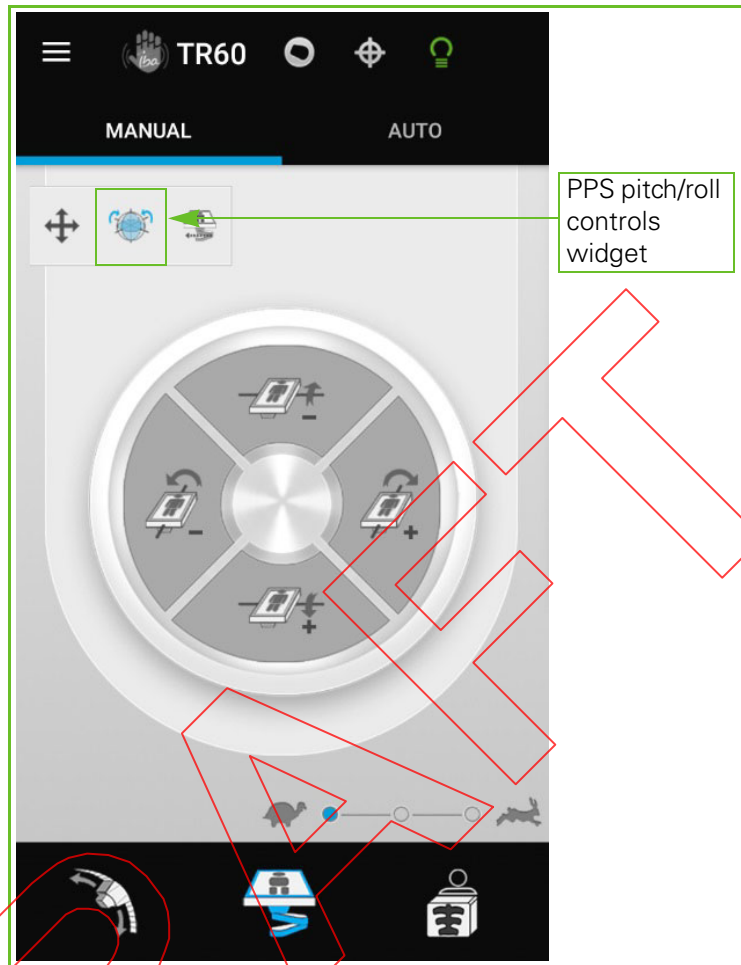

Figure 9-20. PPS Pitch/Roll Widget (typical)

2. Touch and hold the **PPS + Pitch** button to pitch the PPS in the positive direction. Alternatively, touch and hold the **PPS - Pitch** button to pitch the PPS in the negative direction.

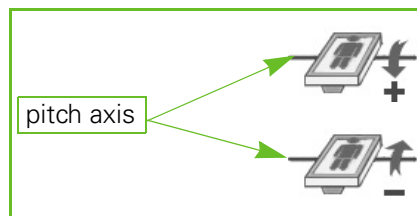

Figure 9-21. PPS - Pitch Icon (above) and PPS + Pitch Icon (below)

Note: The arrows indicate the rotation around the pitch axis.

3. While holding the **PPS + Pitch** or **PPS - Pitch** button, press and hold the **MEB** buttons on the wireless hand-pendant until the device reaches the required position.

Rolling the PPS

To roll the PPS, proceed as follows:

1. To access the PPS pitch and roll commands, touch the widget located above the central dial, on the left of the screen.
2. Touch and hold the **PPS + Roll** button to roll the PPS in the positive direction.
Alternatively, touch and hold the **PPS - Roll** button to roll the PPS in the negative direction.

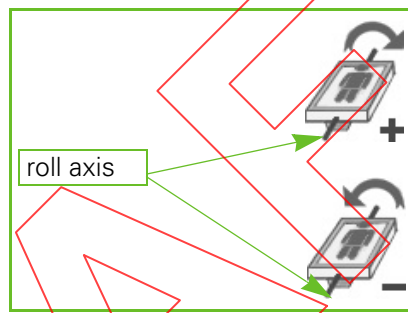

Figure 9-22. PPS + Roll Icon (above) and PPS - Roll Icon (below)

Note: The arrows indicate the rotation around the roll axis.

3. While holding the **PPS + Roll** or **PPS - Roll** button, press and hold the **MEB** buttons on the wireless hand-pendant until the device reaches the required position.

Moving the Digital Imaging Devices

Digital imaging devices options may be accessed either from the Auto or Manual mode screen. The options available in both modes are identical.

1. Touch the **Digital Imaging Devices** icon on the device selection bar at the bottom of the screen.

Once the digital imaging devices subsystem is selected, the interface displays four **Move** buttons in the central dial:

- The top button enables you to insert the devices needed for performing stereoscopic image acquisition.
- The left button enables you to insert the devices needed for performing orthogonal image acquisition.

- The right button enables you to insert the devices needed for performing portal image acquisition.
- The bottom button enables you to retract all digital imaging devices.

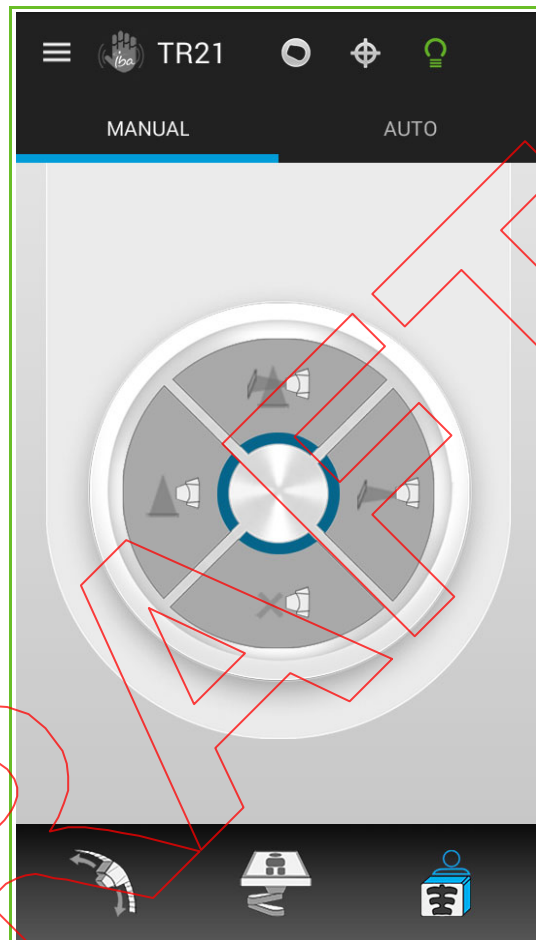

Figure 9-23. Digital Imaging Devices Screen (typical)

2. Touch and hold the button corresponding to the image acquisition mode that you want to perform.
3. While holding the button, press and hold the **MEB** buttons on the wireless hand-
pendant until the device reaches the target position.

Preparing Equipment for a CBCT Acquisition

When a Cone-Beam Computed Tomography (CBCT) preparation is requested using *adaPTinsight*, the **CBCT Preparation** button appears above the central dial of the DIGITAL IMAGING DEVICES SCREEN.

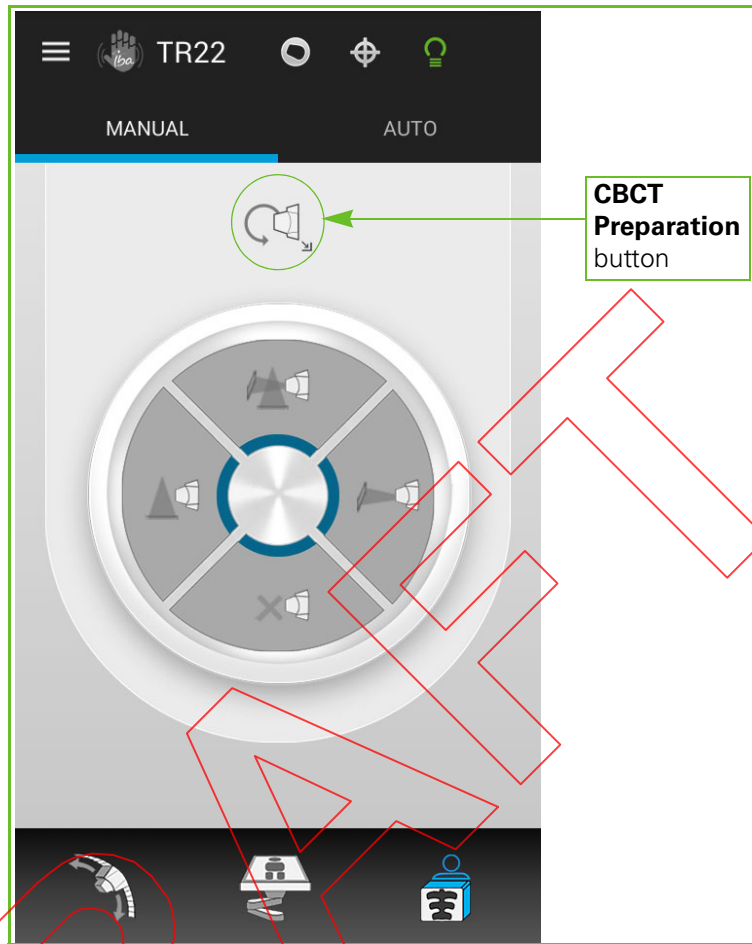

Figure 9-24. CBCT Preparation Button (typical)

1. To access the CBCT Preparation workflow, touch the **CBCT Preparation** button.

The CBCT Preparation workflow consists of several screens which enable you to move the patient positioning and imaging devices to the position required for adaPT^{insight} to be able to perform a CBCT scan.

Note: Only the devices available in the treatment room are shown on the screens of the CBCT Preparation workflow.

Note: The CBCT Preparation workflow has a predetermined order and the screens progress automatically after each step is complete. However, you may choose to modify the order of the steps of the CBCT preparation workflow by selecting the device that you want to prepare next, using the Device Selection bar at the bottom of the screen. In this case, the screens in the workflow do not progress automatically.

After touching the **CBCT Preparation** button, the SNOUT AND ACCESSORY DRAWER - CBCT PREPARATION SCREEN appears.

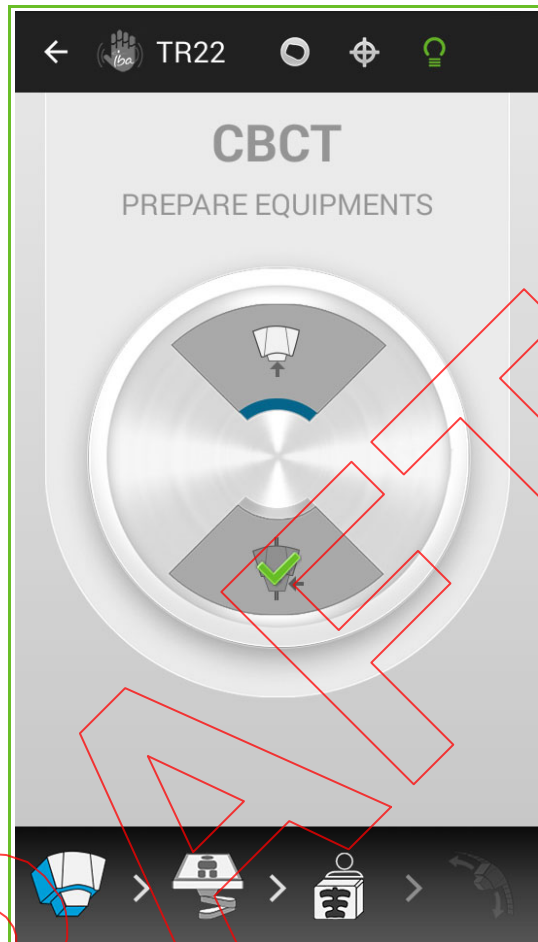

Figure 9-25. Snout and Accessory Drawer - CBCT Preparation Screen (typical)

2. Use the **Move** buttons on the SNOUT AND ACCESSORY DRAWER - CBCT PREPARATION SCREEN to retract the snout and put the accessory drawer in the beam path.

To retract the snout, proceed as follows:

- a. Touch and hold the **Retract Snout** button.



Figure 9-26. Retract Snout Icon

- b. While holding the **Retract Snout** button, press and hold the **MEB** buttons on the wireless hand-pendant until the device reaches the target position.

A green check mark overlays the **Move** button once the device has reached the target position.

To move the accessory drawer into the beam path, proceed as follows:

- a. Touch and hold the **Move Accessory Drawer Into the Beam Path** button.

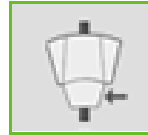

Figure 9-27. Move Accessory Drawer Into the Beam Path Icon

- b. While holding the **Move Accessory Drawer Into the Beam Path** button, press and hold the **MEB** buttons on the wireless hand-pendant until the device reaches the target position.

A green check mark overlays the **Move** button once the device has reached the target position.

Once both **Move** buttons are overlaid by a green check mark, the workflow progresses automatically onto the next screen. The PPS - CBCT PREPARATION SCREEN appears.

The device icon in the Device Selection bar at the bottom of the screen is also overlaid by a green check mark once all required movements are complete.

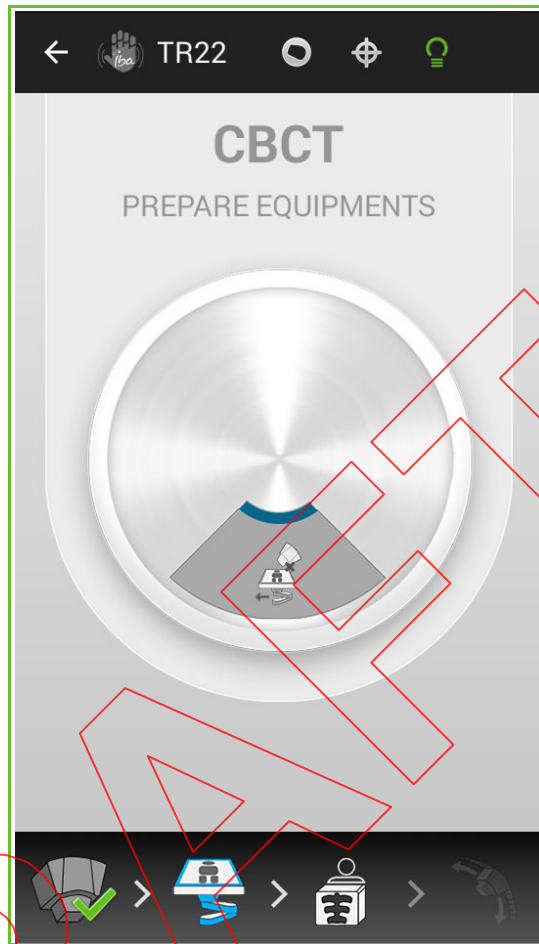

Figure 9-28. PPS - CBCT Preparation Screen (typical)

3. Use the **Move** button on the PPS - CBCT PREPARATION SCREEN to put the PPS in a safe position for CBCT acquisition.
 - a. Touch and hold the **Move** button.
 - b. While holding the **Move** button, press and hold the **MEB** buttons on the wireless hand-pendant until the device reaches the target position.

A green check mark overlays the **Move** button once the device has reached the target position and the workflow progresses automatically onto the next screen. The DIGITAL IMAGING DEVICES - CBCT PREPARATION SCREEN appears.

The device icon in the Device Selection bar at the bottom of the screen is also overlaid by a green check mark once all required movements are complete.

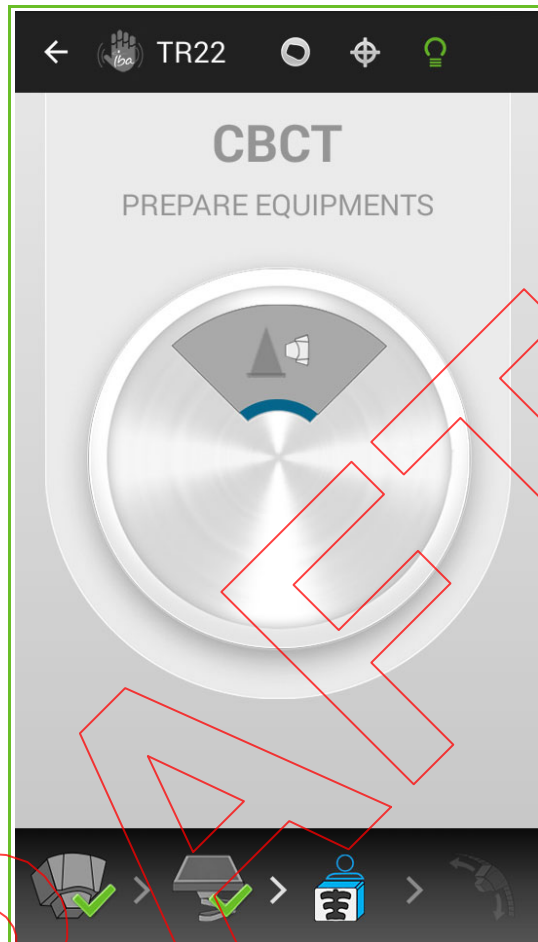

Figure 9-29. Digital Imaging Devices - CBCT Preparation Screen (typical)

4. Use the **Move** button on the DIGITAL IMAGING DEVICES - CBCT PREPARATION SCREEN to put the digital imaging devices in place for CBCT acquisition (orthogonal imager).
 - a. Touch and hold the **Move** button.
 - b. While holding the **Move** button, press and hold the **MEB** buttons on the wireless hand-pendant until the device reaches the target position.

A green check mark overlays the **Move** button once the device has reached the target position and the workflow progresses automatically onto the next screen. The CBCT DRY RUN SCREEN appears.

The device icon in the Device Selection bar at the bottom of the screen is also overlaid by a green check mark once all required movements are complete.

Note: You may at this point continue the CBCT acquisition procedure using *adaPTinsight*, without completing the dry run.

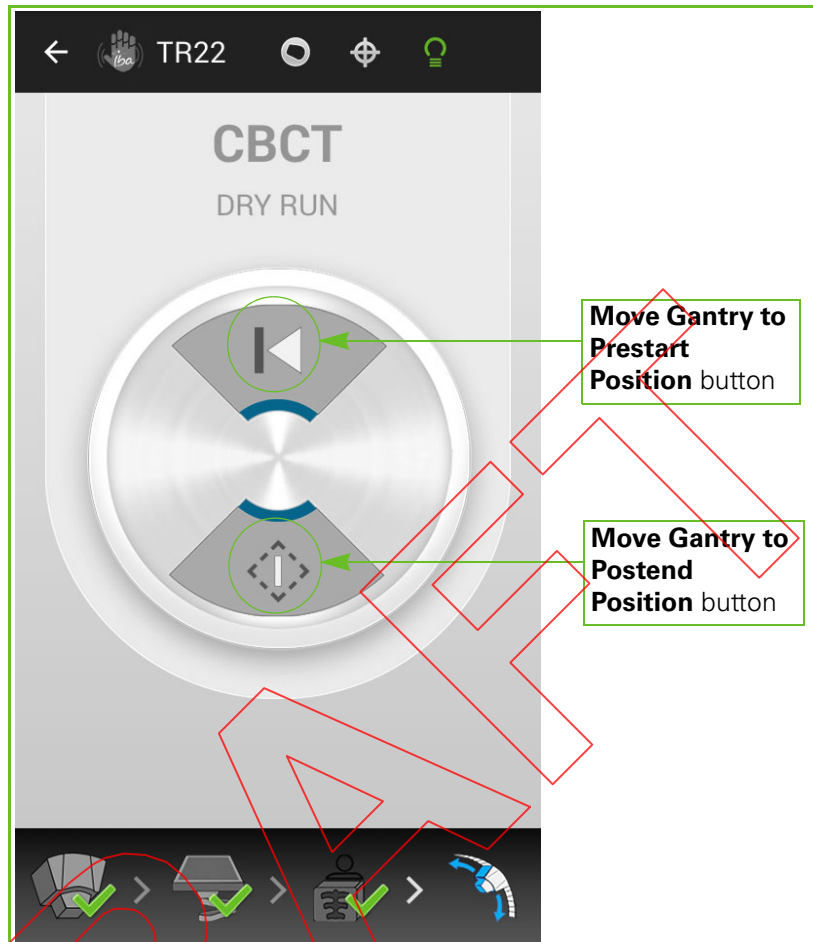

Figure 9-30. CBCT Dry Run Screen (typical)

5. Use the **Move** buttons on the CBCT DRY RUN SCREEN to perform a CBCT dry run before proceeding to CBCT acquisition using *adaPTinsight*.

Note: You may perform the following actions in the order you consider appropriate considering the current circumstances. The order explained here is a suggestion.

- a. Use the **Move Gantry to Postend Position** button to move the gantry to the position reached at the end of a CBCT acquisition.
- b. Use the **Move Gantry to Prestart Position** button to move the gantry to the position required to start a CBCT acquisition.

The gantry is now in position to proceed to CBCT acquisition using *adaPTinsight*.

Note: For further details on CBCT acquisition, refer to the *adaPTinsight* user documentation listed in the Delivery Note.

Using Advanced Options From the Menu

Figure 9-31 shows the functions present in the 'Advanced' section of the menu. These functions include:

- **Select all devices:** this function enables you to select all positioning devices so that they are all reset in a single push of the SRCU **Restart** button. This action is necessary after an emergency stop has occurred.

Note: For further details on how to recover the system after an emergency stop refer to the Safety and Emergency Recommendations document.

- **Reset checks:** this function resets internal Positioning Management System communications. You may need to 'reset checks' after a particular error occurs. This is recommended in the relevant error messages.

These functions are used less often than those directly available via the manual and auto modes screens.

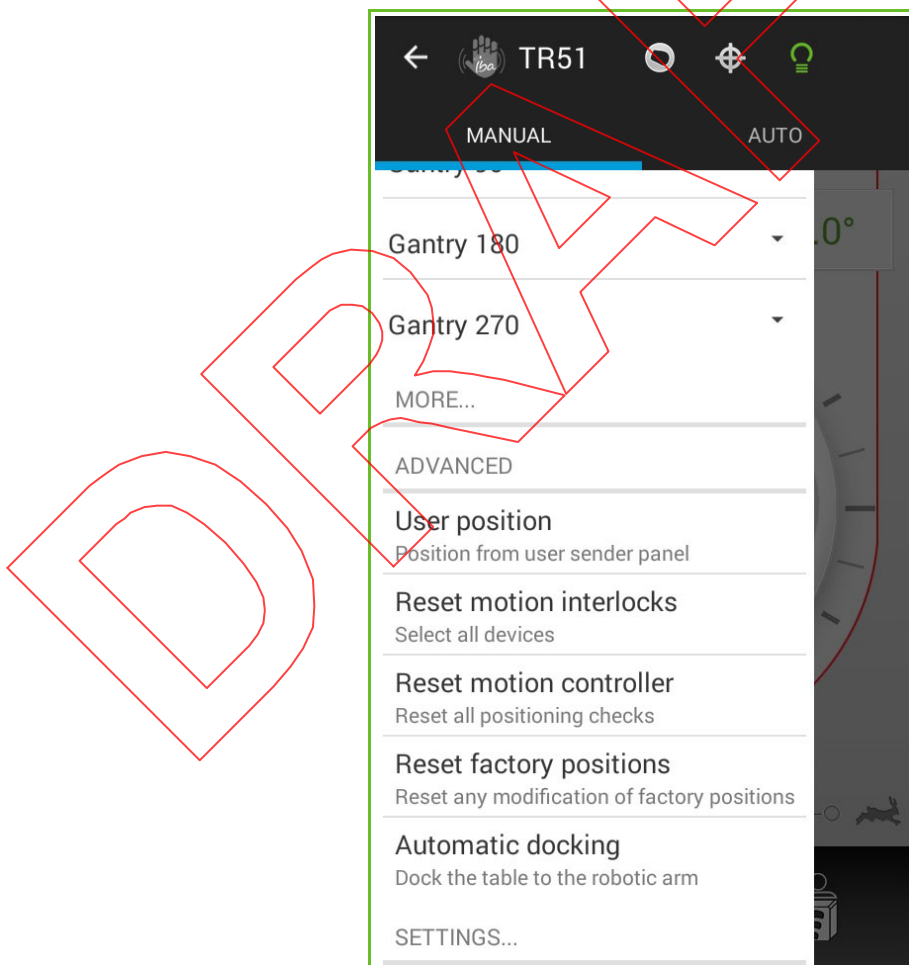

Figure 9-31. Menu - Advanced Options (typical)

Recovering Devices after an Error

When an error occurs, the icon in the Device Selection bar which corresponds to the device in error becomes red.

Long press the red icon to select 'recover mode' and be able to move the device back to a normal working position using the available commands.

Colorblind Users: Negative Colors

In order to ease the user experience of the GUI for colorblind users, the interface can be displayed in negative colors.

Figure 9-32 shows a sample screen of the GUI accessible for colorblind users.

To use the GUI in negative colors, contact IBA personnel.

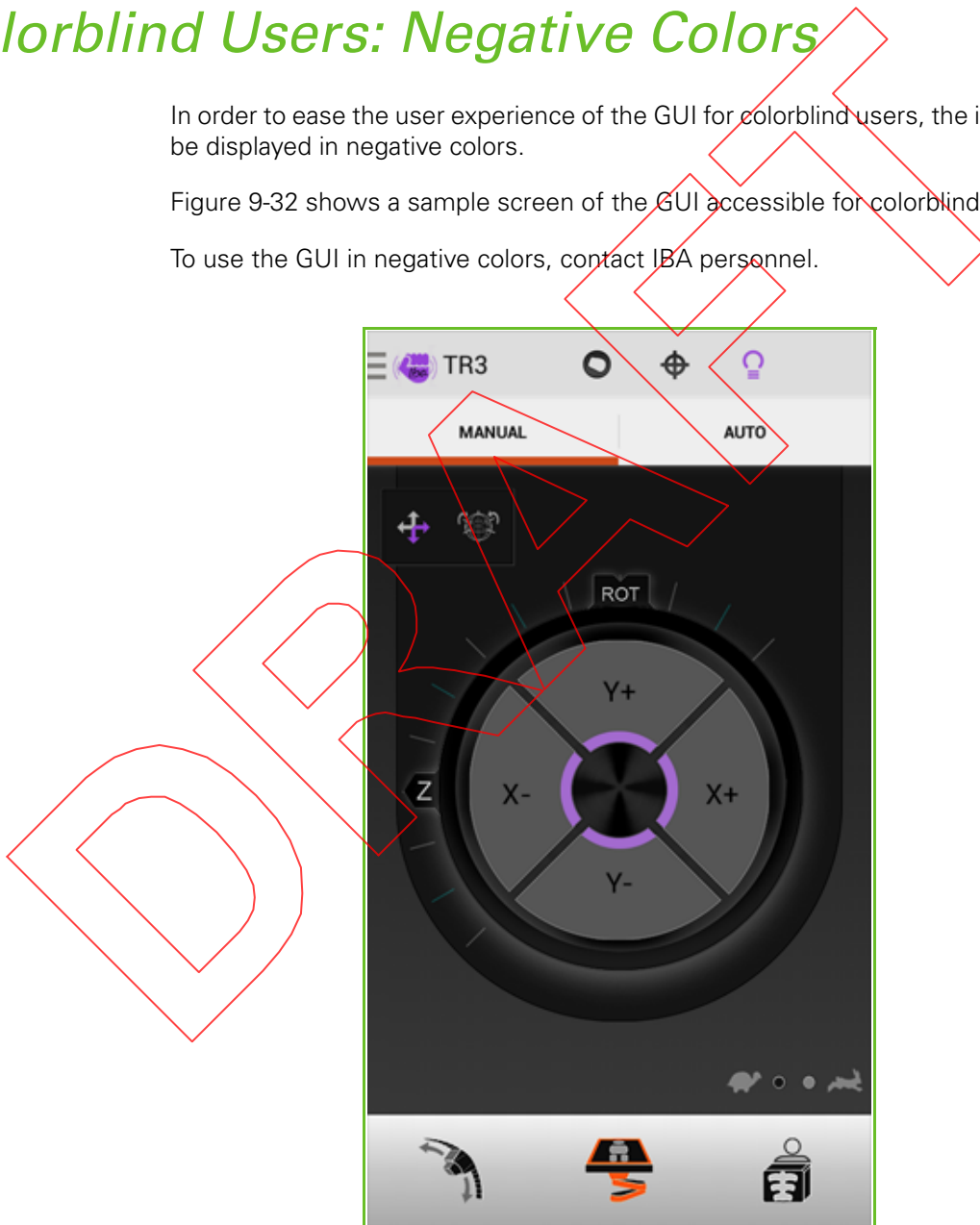

Figure 9-32. Wireless Hand-Pendant GUI - Inverted Colors (typical)

Chapter 10

Wireless Hand-Pendant Daily Checks and Troubleshooting



This chapter describes the following tasks:

- *Checking the Good State of the Hand-Pendant's Casing*
- *Checking the Motion Enable Buttons*
- *Checking Sound and Vibration Feedbacks*

The checks listed above need to be performed daily in order to ensure correct hand-
pendant operation.

Besides, this chapter describes the following:

- *Monitoring Wireless Hand-Pendant Connections*
- *Solving Battery and Autonomy Issues*

Checking the Good State of the Hand-Pendant's Casing

It is important that the hand-
pendant's casing remains in a good state for the device to operate safely. Please inspect the casing every day to check that:

- There are no visible cracks.
- Both Motion Enable Buttons work properly (e.g., they do not jam).

If the check is successful, you may proceed to use the wireless hand-
pendant.

If the check is not successful, the hand-
pendant must be serviced.

Checking the Motion Enable Buttons

The Motion Enable Button is a safety component of the wireless hand-pendant that regularly performs self-tests automatically.

If the wireless hand-pendant is not used for a period of time longer than 24 hours, in order to unlock it, you need to perform a Motion Enable Buttons check. In order to perform a Motion Enable Buttons check, proceed as follows:

1. Follow the instructions detailed in the wireless hand-pendant screen:
 - a. Push and hold both side buttons.
 - b. Release one of the side buttons.
 - c. Press and hold both side buttons.
 - d. Release the side button that was not released in Step b.
2. You may be prompted to repeat this procedure until the check is completed.

If the check is successful, you may proceed to use the wireless hand-pendant.

If the check is not successful, the hand-pendant must be serviced.

Checking Sound and Vibration Feedbacks

The wireless hand-pendant provides sound and vibration feedback to the user. This feedback is important to perform movement commands in a safe way. It is therefore important to regularly check that these functions remain operational. For this purpose, the wireless hand-pendant requests you to check these functions, as follows:

1. Every 24 hours, before you are able to unlock the graphical interface, the wireless hand-pendant displays a message stating that a sound and a vibration are about to be produced for the sound and vibration check procedure.
2. The wireless hand-pendant then prompts you to confirm whether both have been observed.
3. You are then prompted to acknowledge that:
 - the sound check is correct by touching the **OK** button on the screen.
 - the vibration check is correct by touching the **OK** button on the screen.

If the check is successful, you may proceed to use the wireless hand-pendant.

If the check is not successful, the hand-pendant must be serviced.

Monitoring Wireless Hand-Pendant Connections

The wireless hand-pendant is connected via Wi-Fi to the rest of the PTS. The status of this connection can be monitored via the Wi-Fi icon in the welcome screen:

1. Long press the Wi-Fi icon.
2. The Wi-Fi, Notification Server and PMS Controller statuses appear.

Solving Battery and Autonomy Issues

If the wireless hand-pendant faces autonomy issues, contact IBA to service the wireless hand-pendant.

Important	The battery of the wireless hand pendant must be replaced by IBA authorized personnel only.
	

Intentionally left blank

DRAFT

Chapter 11

Using the Remote Positioning Controls

.....

Note: Figures of the remote positioning controls panel across this manual show a typical configuration (Gantry Treatment Room with snout and accessory drawer as well as with stereoscopic, portal and orthogonal imagery system). Some details may differ from the remote positioning controls displayed in other room configurations. However, the principles explained apply to all remote positioning controls panel configurations.

Most motion control functions can also be used from the Treatment Control Room (TCR) using the **remote positioning controls**, which are displayed on adaPT *deliver* screens. The remote positioning controls are used in combination with the remote positioning hardware console. To execute the motions selected using the remote positioning controls, you must use the Motion Enable Button (**MEB**) and **Move** buttons on the remote positioning hardware console.

This chapter provides instructions on how to use the remote positioning controls, covering the following topics:

- *Safety Measures Specific to the Use of the Remote Positioning Controls*
- *Remote Positioning Hardware Console*
- *Controlling Speed*
- *Stopping Movements*
- *Operating Modes: Auto and Manual*
- *Using the Remote Positioning Controls in Auto Mode*
- *Using the Remote Positioning Controls in Manual Mode*
- *Using Advanced Settings*

Safety Measures Specific to the Use of the Remote Positioning Controls

Make sure you read and understand the following warning messages before using the remote positioning controls.

Use of the remote positioning controls from the Treatment Control Room (TCR) means that the Radiation Therapy Technologist (RTT) is not in the near vicinity of the patient and therefore may have less visibility on the exact position of the patient and potential collisions. Therefore, two cameras in the Treatment Room capture images that are displayed on two video screens in the Treatment Control Room.

WARNING	<p>When motion is performed from the Treatment Control Room (TCR) during the treatment session, visually check to see on the video screens in the TCR that no collision with the patient is imminent before initiating motion. Also, continuously check the absence of collision during motion.</p> <p>Interrupt motion immediately in case of patient movement or insufficient visibility on the video screens during motion.</p>
	

WARNING	<p>Be careful to avoid collisions of the Patient Positioning System. Collisions may damage the PPS. It may also deteriorate the robot accuracy and performance.</p> <p>In case of a collision, the robot must be calibrated.</p>
	

CAUTION	<p>When performing actions from the Treatment Control Room, as a Radiation Therapy Technologist, make sure that the means for audio and video communication with the patient are available during treatment positioning and delivery.</p>
	

Performing a Motion Dry Run

WARNING

When it is planned to perform motion from the Treatment Control Room (TCR), perform a motion dry run from the Treatment Room to evaluate the risk of collision before performing motion from the TCR.

In case the motion dry run reveals that the risks of collision remain high, motion must be performed from the Treatment Room.

The motion dry run is to reproduce the motions to be performed in the treatment session as faithfully as possible. The purpose of performing a motion dry run is as follows:

- Test all motions.
- Test these motions in the order as foreseen in the Treatment Room.
- Consider the fact that:
 - a different setup correction may be applied to the patient support in each treatment session
 - the patient might move during motion

The motion dry run can be performed either on the first day of treatment or during a simulation session. It is recommended to record all points of attention in the patient chart.

Remote Positioning Hardware Console

Each Treatment Control Room (TCR) is equipped with a remote positioning hardware console featuring the following buttons:

- Motion Enable Button (MEB)
- Move button
- Emergency stop button

To execute the motions selected using the remote positioning controls, you must use the **MEB** and **Move** buttons on the remote positioning hardware console.

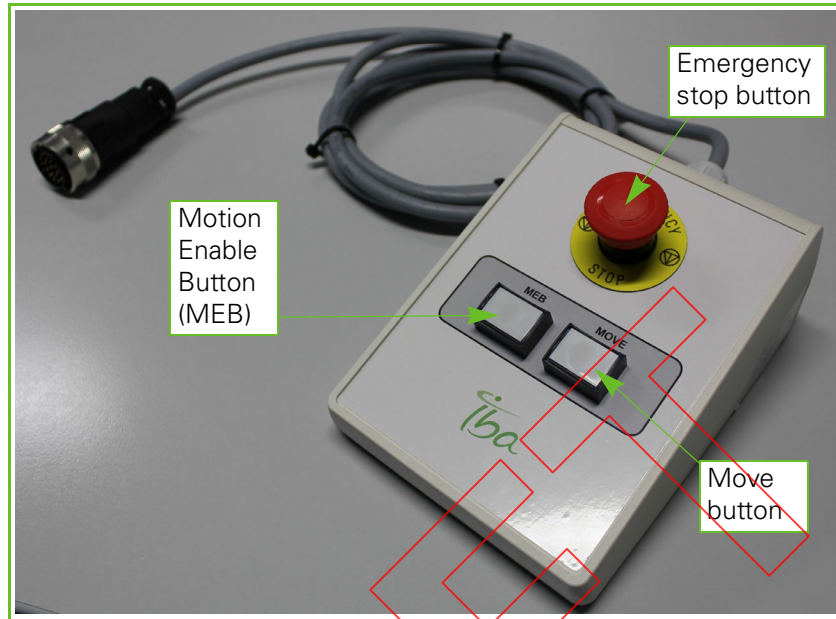



Figure 11-1. Remote Positioning Hardware Console

Important 	Throughout this manual, whenever you are instructed to press the Motion Enable Button (MEB) or the Move button on the hand-pendant, this means either on the wireless hand-pendant or on the remote positioning hardware console.
---	---

Controlling Speed

Each patient positioning device (PPD) may be operated at high, medium or low speed.

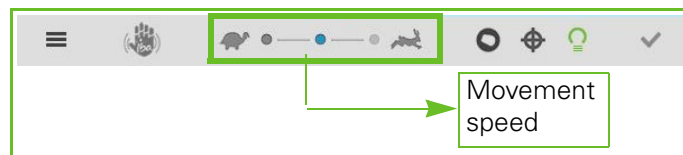

Figure 11-2. Movement Speed Icons Remote Positioning Controls Bar (typical)



1. To chose the high speed option, click the dot next to the 'hare' icon.

Alternatively, to choose the low speed option, click the dot next to the 'tortoise' icon.

Alternatively, to choose the medium speed option, click the dot between the high and low speed options.

The dot corresponding to the currently selected speed is highlighted in blue.

Table 11-1. Movement Speeds

Icon	Speed
	High speed ('hare' icon)
	Medium speed
	Low speed ('tortoise' icon)

Note: The speed of the device remains set to the last speed used until a different speed is selected.

Note: The proximity control software may automatically switch the speed of a device from high speed to medium speed in certain circumstances.

Note: The 'high speed' option is not selectable when a device is in a situation of proximity.

Stopping Movements

The following methods are available to stop movements of the Proton Therapy System (PTS) equipment when using the remote positioning controls:

- Release the **MOVE** button on the remote positioning hardware console.
- Release the **Motion Enable Button** on the remote positioning hardware console.
- Press an **emergency stop button**.

WARNING	If a patient is not safely secured to the PPS, the patient may fall off. Each patient shall be safely secured before moving the PPS.
	

Release the MOVE Button

If the **MOVE** button is released during Patient Positioning Device (PPD) movement, the PPD stops smoothly.

Release the Motion Enable Button

If the **Motion Enable Button** is released during Patient Positioning Device (PPD) movement, the PPD stops immediately. If you release this button before releasing the **MOVE** button, the motion stops abruptly.

The movement can be resumed by pressing the **Motion Enable Button**, followed by the **MOVE** button.

Press an Emergency Stop Button

Note: Emergency stop buttons and TSS interlocks exist on a level local to your treatment room and system-wide. The description in this section pertains to the local level only.

WARNING	Emergency stop buttons shut off energy to most components in the Proton Therapy System (PTS). However, the electrical power to some components will not be interrupted, so be aware that electrical hazards and faults (faulty parts made live or induced fire) may still be present.
	

If an emergency stop button local to your treatment room is pressed during Patient Positioning Device (PPD) movement, the motion stops immediately.

After using an emergency stop button local to your treatment room to stop the PPDs, the emergency stop button and the Therapy Safety System (TSS) must be reset.

After the emergency stop button and TSS are reset, the following may also be required:

- Recovery enabling beam production
- Recovery of gantry movement (for GTR only)
- Recovery of PBS Dedicated snout and PPS movements
- Recovery enabling beam in TR
- Recovery enabling X-ray high-voltage
- Verification of proper operation
- Successful daily calibrations (e.g., variable collimators)

Using Tool Tips

The remote positioning controls panel consists of tool tips.

Place the mouse pointer over any given icon to see a tool tip with some details regarding what that particular icon or button can enable you to do, the meaning of its current state, etc.



Figure 11-3. Tool Tip (example)

Tool tips also exist for error messages.

Place the mouse pointer over an error sign to see a tool tip with some details regarding the occurring error.

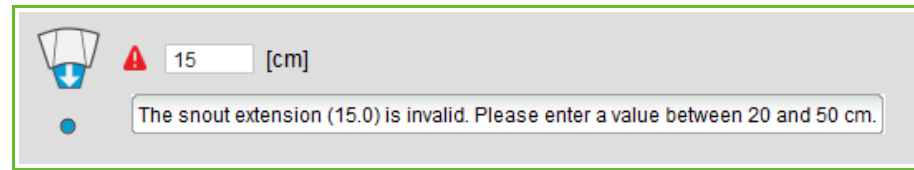

Figure 11-4. Error Tool Tip
(example)

Operating Modes: Auto and Manual

The remote positioning controls can be used, by default, in a single operating mode in adaPT~~deliver~~ clinical sessions:

- **Auto mode:** using Auto mode, you may perform Auto motions to prescribed or user-defined target positions.

For detailed information on Auto motions, refer to Chapter 6.

Note: Only those target positions for which conditions are currently met are available using Auto mode.

Auto mode also gives you access to the motion of the imaging devices.

The Manual operating mode may be available in the remote positioning controls of adaPT~~deliver~~ clinical sessions at your site upon explicit request to IBA:

- **Manual mode:** using Manual mode, you may perform Manual motions to positions that are not predefined.

For detailed information on Manual motions, refer to Chapter 6.

Note: For the purpose of this manual, the Manual operating mode of the remote positioning controls is fully explained and illustrated. This operating mode may or may not be available at your site.

Both Manual and Auto operating modes are available in adaPT~~deliver~~ physics mode sessions.

Manual and Auto operating modes are available by default in the wireless hand-
pendant GUI. For more details on how to use the wireless hand-
pendant, refer to Chapter 9.

Using the Remote Positioning Controls in Auto Mode

Auto mode enables you to perform Auto motions to patient-specific and non patient-specific target positions.

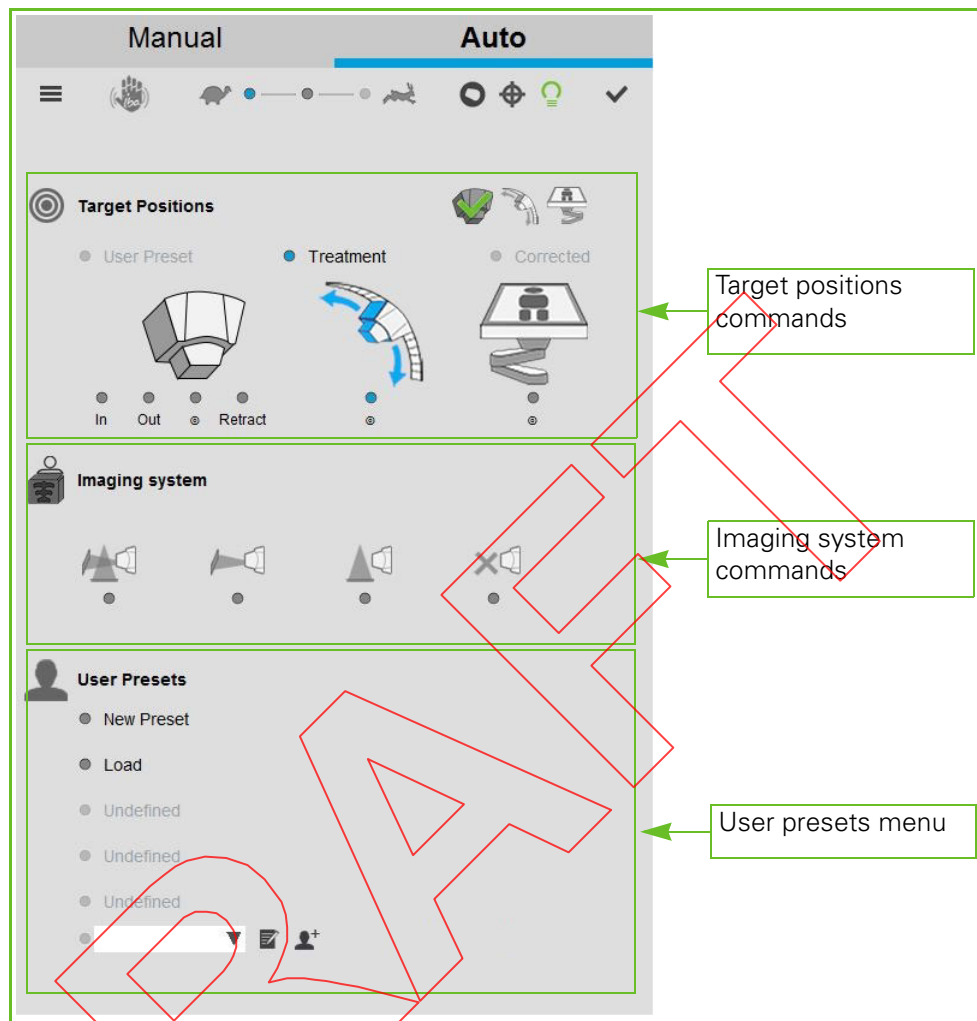

Figure 11-5. Remote Positioning Controls Panel - Auto Mode (typical)

Auto Mode Target Positions

A target position may be one of the following:

- **User preset:** a user preset is a target position defined by the user. The label of a user preset is the name of the preset as defined by the user.
- **Setup position:** setup positions are defined in the Treatment Plan and associated to setup beams. As such, a setup position is only available as a target position when a setup beam is selected and the preparation for the setup beam has started.
- **Treatment position:** treatment positions are associated to treatment beams. As such, a treatment position is only available as a target position when a treatment beam is selected and the preparation for the treatment beam has started.

- Corrected position:** a corrected position becomes available once a given treatment or setup position has been corrected using the Patient Position Verification System (PPVS), adaPTinsight. As such, a corrected position is only available as a labeled target position when a treatment or setup beam is selected and after the alignment process is complete.

Depending on the stage of the workflow, you may choose among the available target positions.

Selecting a Target Position

To make a selection among the available target positions, click the dot next to the required target position in the 'Target Positions' part of the remote positioning controls panel. The dot becomes blue.

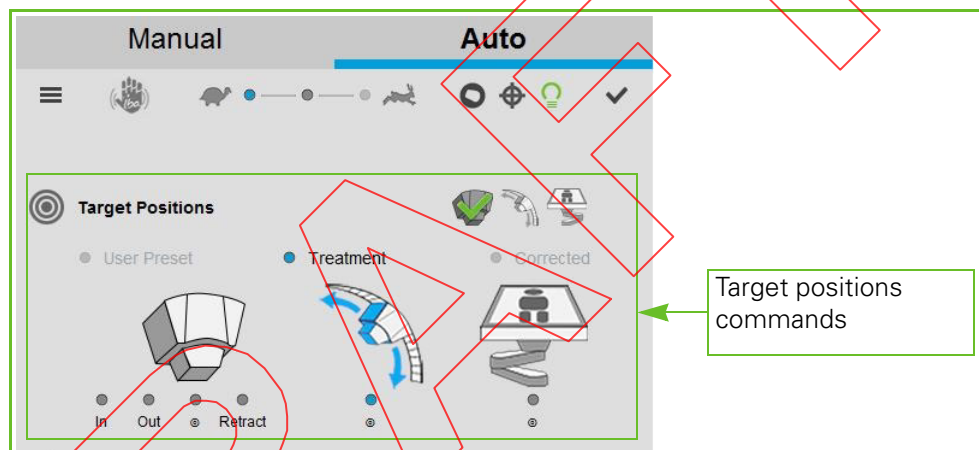

Figure 11-6. Target Positions Commands (typical)

The 'User Preset' target position, which appears on the left side of the 'Target Positions' commands, is not selectable.

To select a user preset as a target position, use the USER PRESETS MENU at the bottom of the remote positioning controls panel.



Figure 11-7. User Presets Menu (typical)

Click the dot next to the user preset that you want to set as the target position. The dot next to the preset becomes blue.

The 'User Preset' position that appeared on the left side of the 'Target Positions' commands now echoes the USER PRESETS MENU selection.

DRAFT