



Iridium Extreme™ User's Manual



web: www.iridium.com

email: info@iridium.com

toll free: +1.866.947.4348

phone: +1.480.752.5155



Legal Notices

This User Manual provides user information and is provided “as is.” Iridium and its affiliated companies, directors, officers, employees, agents, trustees or consultants (“Iridium”) assume no responsibility for any typographical, technical, content or other inaccuracies in this User Manual. Iridium reserves the right to revise this User Manual or withdraw it at any time without prior notice. You can find the current version of this Iridium Extreme™ User Guide at www.iridiumextreme.com.

IRIDIUM MAKES NO REPRESENTATIONS, GUARANTEES, CONDITIONS OR WARRANTIES, EITHER EXPRESS OR IMPLIED, INCLUDING WITHOUT LIMITATION, ANY IMPLIED REPRESENTATIONS, GUARANTEES, CONDITIONS OR WARRANTIES OF MERCHANTABILITY AND FITNESS FOR A PARTICULAR PURPOSE, NON-INFRINGEMENT, SATISFACTORY QUALITY, NON-INTERFERENCE, ACCURACY OF INFORMATIONAL CONTENT, OR ARISING FROM A COURSE OF DEALING, LAW, USAGE, OR TRADE PRACTICE, USE, OR RELATED TO THE PERFORMANCE OR NONPERFORMANCE OF ANY PRODUCTS, ACCESSORIES, FACILITIES, SERVICES OR USER INFORMATION, EXCEPT AS EXPRESSLY STATED IN THIS USER MANUAL. ANY OTHER STANDARDS OF PERFORMANCE, GUARANTEES, CONDITIONS AND WARRANTIES ARE HEREBY EXPRESSLY EXCLUDED AND DISCLAIMED TO THE FULLEST EXTENT PERMITTED BY LAW. THIS DISCLAIMER AND EXCLUSION SHALL APPLY EVEN IF THE EXPRESS LIMITED WARRANTY CONTAINED IN THIS USER MANUAL FAILS OF ITS ESSENTIAL PURPOSE. FURTHER, THIS LIMITED WARRANTY COVERS THE Iridium Extreme™ (INCLUDING HARDWARE, SOFTWARE AND/OR FIRMWARE, BUT EXCLUDING LEATHER CASE) AND ACCESSORIES ONLY, AND NO WARRANTY IS MADE AS TO USER INFORMATION AND/OR COVERAGE, AVAILABILITY OR GRADE OF SERVICE PROVIDED BY IRIDIUM SEPARATELY FOR IRIDIUM SATELLITE SERVICES.

IN NO EVENT SHALL IRIDIUM BE LIABLE, WHETHER IN CONTRACT OR TORT OR ANY OTHER LEGAL THEORY, INCLUDING WITHOUT LIMITATION STRICT LIABILITY, GROSS NEGLIGENCE OR NEGLIGENCE, FOR ANY DAMAGES IN EXCESS OF THE PURCHASE PRICE OF THE Iridium Extreme™ (INCLUDING HARDWARE, SOFTWARE AND/OR FIRMWARE) AND/OR ACCESSORIES AND/OR THE COST OF IRIDIUM SATELLITE SERVICES PROVIDED, INCLUDING ANY DIRECT, INDIRECT, INCIDENTAL, SPECIAL OR CONSEQUENTIAL DAMAGES OF ANY KIND, OR LOSS OF REVENUE OR PROFITS, LOSS OF BUSINESS, LOSS OF PRIVACY, LOSS OF USE, LOSS OF TIME OR INCONVENIENCE, LOSS OF INFORMATION OR DATA, SOFTWARE OR APPLICATIONS OR OTHER FINANCIAL LOSS CAUSED BY THE Iridium Extreme™ (INCLUDING HARDWARE, SOFTWARE AND/OR FIRMWARE) AND/OR ACCESSORIES AND/OR THE IRIDIUM SATELLITE SERVICES, OR ARISING OUT OF OR IN CONNECTION WITH THE ABILITY OR INABILITY TO USE THE Iridium Extreme™ (INCLUDING HARDWARE, SOFTWARE AND/OR FIRMWARE) AND/OR ACCESSORIES AND/OR THE IRIDIUM SATELLITE SERVICES TO THE FULLEST EXTENT THESE DAMAGES MAY BE DISCLAIMED BY LAW AND WHETHER ADVISED OF THE POSSIBILITIES OF SUCH DAMAGES.

Please refer to Chapter 18 of this User Manual for Limited Warranty, Product and Satellite Service Terms and Warranty Support, Conditions of Use and Software License.

Third Party Information

This User Manual might refer to third party sources of information, hardware or software, products or services and/or third party web sites (“third party information”). Iridium does not control, and is not responsible for, any third party information, including without limitation the content, accuracy, copyright compliance, compatibility, performance, trustworthiness, legality, decency, links, or any other aspect of third party information. The inclusion of such third party information does not imply endorsement by Iridium of the third party information. ANY THIRD PARTY INFORMATION THAT IS PROVIDED WITH IRIDIUM'S FACILITIES, SERVICES, PRODUCTS OR USER INFORMATION IS PROVIDED “AS IS.” IRIDIUM MAKES NO REPRESENTATIONS, GUARANTEES OR WARRANTIES IN RELATION TO THIRD PARTY INFORMATION AND IRIDIUM SHALL NOT BE LIABLE FOR ANY LOSSES, DAMAGES, LIABILITIES, JUDGMENTS, FINES, AMOUNTS PAID IN SETTLEMENT, EXPENSES OR COSTS OF DEFENSE SUSTAINED IN RELATION TO ANY SUCH THIRD PARTY INFORMATION.

Intellectual Property, Trade Secret, Proprietary or Copyrighted Information

To protect Iridium proprietary and confidential information and/or trade secrets, this User Manual may describe some aspects of Iridium technology in generalized terms. Iridium products may include copyrighted Iridium and third party software. Any such copyrighted software contained in Iridium products may not be modified, reverse engineered, distributed or reproduced in any manner to the extent provided by law. The purchase of any Iridium products shall not be deemed to grant either directly or by implication or otherwise, any license under copyrights, patents, or patent applications of Iridium or any third party software provider, except for the normal, nonexclusive, royalty free license to use that arises by operation of law in the sale of a product. Please refer to Chapter 19 of this User Manual for Limited Warranty, Product and Satellite Service Terms and Warranty Support, Conditions of Use and Software License.

Content Copyright

You are exclusively responsible for the use of the Iridium Extreme™, including proper use of third party copyrighted materials. If you violate these terms you agree to defend, indemnify and hold Iridium harmless with respect to any claims or actions by third parties related to your improper use of copyrighted materials and to pay all costs, damages, fines and other amounts incurred by Iridium, or on its behalf, in the defense of any such claims or actions.

Contents

1: Introduction	1
2: Important Safety Information	3
Safety and Warning Icons	3
Exposure to Radio Frequency Signals	4
Specific Absorption Rate Data	4
Batteries	5
Battery Charging	6
Battery Disposal	7
Emergency Calling	7
Antenna Care	8
Driving and Operation of Other Motor Vehicles	8
Posted Facilities	8
Blasting Areas	8
Potential Explosive Atmospheres	9
Electronic Devices	9
Product Operation	9
Radio Interference	9
Implantable Medical Devices	10
Persons with pacemakers:	10
Hearing Aids	11
Other Medical Devices	11
Aircraft	11
Vehicles	11
Vehicles Equipped with an Air Bag	11
Adult Use Only	11
Glass Parts	12
Extended Exposure to Loud Noise	12
Seizures and Blackouts	12
Repetitive Motion	12
3: Iridium Extreme™ Overview	13
Guide Overview	13
Phone Overview	14
Front View	14
Side View	15
Back View	16
Charging / USB / External Antenna Adapters	17
Adapter #1: Charging / USB	17
Adapter #2: Charging / USB / External Antenna	17
Installation of the adapter	18

Use of the adapter	18
Removal of the adapter	19
Accessories.....	19
AC Travel Charger and International Plug Kit	19
Headset	20
Auto Accessory Charger	21
Display Status Indicators and Icons	25
Main Screen Components	25
Menu Components	26
4: Getting Started	27
Using the SIM Card.....	27
SIM Card Care	27
Insert the SIM Card.....	28
Remove the SIM Card.....	28
Battery Pack Information	29
Battery Charging.....	30
Battery Disposal	30
Remove and Install the Battery Pack.....	31
To Remove the Battery Pack	31
To Install the Battery Pack.....	32
Charging the Battery	33
Charge the Battery Pack.....	33
Checking Battery Charge Level	33
Low Battery Warning	33
Start-up Procedure.....	34
Power on Message	34
Phone Operation	36
Normal Operation.....	36
Tips on Efficient Operation.....	36
Placing a Call	37
Before you place a call:	37
Dial the Number.....	37
End a Call	39
Re-dial Last Number Called	40
Receiving a Call	40
Before you receive a call:.....	40
Receiving a call with the Antenna Extended	41
Answering the call with the Antenna Extended.....	42
Receiving a Call with the Antenna Stowed	43
Muting a Call	45
Speaker Phone.....	45

Speaker Volume	45
Ringer Volume	46
Unanswered Calls	47
Messages from Missed Calls	47
Locking and Unlocking the Keypad.....	48
Unlocking the Keypad	49
5: Using Menus and Keys.....	51
Using the Keys	51
The Soft Keys	51
The 2-way Navi-key	51
The Keypad	52
Using the Menus.....	52
To Access the Main Menu	52
To Access Main Menu Options	53
To Return to a Menu	54
Entering Characters	54
6: Traditional Text Entry	57
Entering Characters	57
Keypad Guide.....	58
Entering Punctuation	59
Entering Numbers and Symbols into Text	60
7: Predictive Text Entry	63
LetterWise Text mode	66
WordWise Text mode	68
Digit mode (123).....	70
Punctuation mode (#?@)	70
8: Using the Phonebooks	73
Organizing My Phonebook.....	73
Phone Memory.....	73
SIM Card Memory	73
Personal Numbers.....	73
Phone Number Digits	73
Name Characters	73
Locating My Phonebook.....	73
About the My Phonebook Menu	74
Add a New Entry to My Phonebook	75
Locating Entries.....	77
Calling an Entry	78
Using the Short Message Service (SMS) Menu	80
Edit an Entry in My Phonebook.....	83

Delete an Entry.....	85
Viewing Memory Status.....	87
Adding Notes to a Phonebook Entry.....	88
Restricted Phonebook.....	89
9: Using the Messages Menu	91
Locating the Messages Menu	91
Create and Send a new SMS Message to an Email Address not in your Phonebook.....	92
Create and Send a new SMS Message to an Email Address in My Phonebook.....	94
About SMS Messaging.....	96
Message Notification.....	96
How Messages are Stored	96
What Messages Contain	96
Using the Inbox Menu	97
Read a Message.....	97
Reply to Sender	98
Forward a Received Message	99
Call a Number from a Received Message.....	102
Delete a Message.....	102
Using the Drafts Menu.....	104
Using the Settings Menu	107
Enter Service Center Number.....	107
Set Expiry Period	108
Select Delivery Reports	110
10: Using the Voicemail Menu	111
Locating the Voicemail Menu	111
About the Voicemail Menu	111
Voicemail Notification.....	112
Check Your Voicemail	112
Store Your Voicemail Number	113
One-Touch Access to Voicemail.....	114
11: Using the Data Modem Menu	115
Locating the Data Modem Menu.....	115
12: Using the Call History Menu	117
Locating the Call History Menu	117
About the Call History Menu.....	117
Using the Call Log Menu.....	118
View Most Recent Received Calls.....	118
View Missed Calls.....	119

View Most Recent Dialed Calls	120
Using the Call Meters Menu.....	122
Show the Time of Last Call.....	122
Show Total Time for All Calls	123
Reset all Timers	124
Showing the Lifetime Call Timer	126
Showing the In-call Display	127
Setting Audible Call Timers.....	129
Set the Single Alert Timer	129
Set the Repetitive Alert.....	131
13: Using the Setup Menu	133
Locating the Setup Menu	133
About the Setup Menu.....	133
Setting Call Options.....	134
Setting Volumes and Tones.....	135
Adjust the Ringer Volume.....	135
Adjust the Speaker Volume.....	137
Adjust the Ring Tone	138
Setting the Call Alert Mode.....	140
Setting the Keypad Tone.....	141
Set the Phone to Ring and /or Vibrate	143
Time and Date Settings	144
Select the Time Zone.....	144
Select the Time Format.....	146
Select the Date Format.....	147
Selecting the Display Language	148
Setting Backlights.....	150
Setting Contrast	151
Using the Key Setup Menu.....	152
Setup the Convenience Key Function.....	152
Setup the Right Soft Key Function	153
Set Number Entry Prefix.....	154
View Phone Information	155
Reset Phone Options to Factory Defaults	156
14: GPS and Location-Based Services	159
Location Options Setup Menu	159
Locating Location Options.....	160
Using the GPS Options Menu.....	161
GPS Settings Lock.....	161
GPS Update Options.....	162
Turning GPS On/Off.....	163

Setting Emergency Options	163
Emergency Mode	164
Emergency Actions.....	166
Emergency Beep.....	167
Message Recipient	167
Call Recipient	169
Message Options	170
GPS Quick List	172
Position Format	173
Altitude Format	173
Current Location	174
Online Portal Integration with 3 rd Parties	175
15: Using the Security Menu	177
Locating the Security Menu.....	177
About the Security Menu	178
Locking and Unlocking Your Phone	178
Enable or Disable the SIM lock	179
Using the Change PIN Menu	181
Change the Phone PIN Code	181
Change the SIM PIN Code.....	183
Change the SIM Card PIN2 Code.....	185
Call Barring PIN.....	187
16: Troubleshooting	185
17: Certification and Compliance Information.....	189
Export Compliance	189
Standards Compliance Information.....	189
FCC Compliance	189
EU Regulatory Conformity.....	189
Canada Regulatory Conformity	189
18: Limited Warranty, Product and Satellite Service Terms, Warranty Support, and Software License.....	191
Exclusions	192
Limitations of Warranty/Local Laws.....	193
Conditions of Use and Limitations of Liability.	194
Warranty Claim Process	196
SOFTWARE LICENSE.....	197
19: Renseignements importants sur la sécurité.....	185

1: Introduction

Thank you for purchasing the state of the art Iridium Extreme™.

This User Manual contains the procedures for the safe operation of the satellite phone and the available facilities.

Important: Read this entire manual, including the safety information in Chapter 2 before using the Iridium Extreme™.

Related Documents

The following Iridium product documentation is available to help you:

- Iridium Extreme™ Specification Sheet
- Iridium Extreme™ Quick Start Guide

Refer to www.iridiumextreme.com for your copies.

2: Important Safety Information

Important: Read this entire chapter, before using the Iridium Extreme™.

Safety and Warning Icons

The following conventions are used in this User Manual.



Caution!

Care must be taken. Failure to follow directions carefully could result in damage to equipment.



Warning!

Failure to comply with this warning could result in serious damage to life, limb or property.

Before doing this task, be sure to familiarize yourself with appropriate safety practices, personal protective equipment and have a plan in case of accident.



Do not let your battery, charger, or satellite phone come in contact with water.



Risk of explosion.



High heat source. Burn risk.



Do not dispose in trash.



Do not dispose of your battery in a fire.



Harmful noise.

Exposure to Radio Frequency Signals

Your Iridium Extreme™ is a low power radio transmitter and receiver. When it is ON, it receives and also sends out radio frequency (RF) signals. Your Iridium Extreme™ is designed to comply with local regulatory requirements in your country concerning the exposure of human beings to RF frequency.

International agencies have set standards and recommendations for the protection of public exposure to RF electromagnetic energy.

- International Commission on Non- Ionizing Radiation Protection (ICNIRP)
- Verband Deutscher Elektrotechniker (VDE)
- United States Federal Communications Commission (FCC), Radio Frequency Exposure Guidelines
- National Radiological Protection Board of the United Kingdom
- American National Standards Institute (ANSI) IEEE. C95. 1-1992
- National Council on Radiation Protection and Measurements (NCRP). Report 86
- Department of Health and Welfare Canada. Safety Code 6

The design of your phone complies with these standards when used as described under “Phone Operation” on page 31.

This product is compliant with Industry Canada RSS-102 for RF Exposure.

Refer to “Specific Absorption Rate Data” on pages 4-5.

Specific Absorption Rate Data

This Iridium Extreme™ meets international standards for exposure to radio waves.

Your satellite phone is designed and manufactured not to exceed limits for exposure to radio frequency (RF) energy. These limits are part of comprehensive guidelines and established permitted levels of RF energy for the general population. The guidelines are based on standards that were developed by independent scientific organizations through periodic and thorough evaluation of scientific studies. The guidelines include a substantial safety margin designed to assure the safety of all persons, regardless of age and health.

The exposure standard for mobile phones employs a unit of measurement known as the Specific Absorption Rate, or SAR. Under the guidelines for this model, the SAR limit is 1.6 W/Kg. Tests for SAR were conducted in accordance with the European Committee for Electrotechnical Standardization (CENELEC) and FCC testing procedures using standard operating positions with the phone transmitting at its highest certified power level in all tested frequency bands. Although the SAR is determined at the highest certified power level, the actual SAR of the phone while operating can be below the maximum value. Before a phone model is available for sale to the public, it is tested to confirm compliance with the guidelines. The tests are performed in positions and locations (e.g., at the ear and worn on the body) that conform to a uniform testing methodology determined by an expert standards body.

The highest SAR level recorded from this product was 1.27 W/Kg which was below the uncontrolled (i.e., general population) limit. While there may be differences between the SAR levels of various phones and at various positions, they all meet the governmental requirements.

PLEASE NOTE THAT MODIFICATIONS TO THIS PRODUCT MODEL COULD CAUSE DIFFERENCES IN THE SAR VALUE FOR LATER PRODUCTS; IN ALL CASES, PRODUCTS ARE DESIGNED TO BE WITHIN THE GUIDELINES.

Batteries

All batteries may cause serious injury or property damage, particularly if handled improperly or used after damage.



Warning!

Improper treatment or use of batteries may present a danger of fire, explosion, leakage, or other hazard.



Make sure to follow all of the following safety guidelines:

- Do not disassemble, crush, puncture, shred or otherwise attempt to change the form of the battery.

- Do not let the phone or battery come in contact with water. Water can lead to corrosion of the phone's circuits. 
- Do not allow the battery to touch metal objects. Contact with metal objects can cause the battery to heat and possibly explode. 
- Do not place your battery near a heat source. Excessive heat can damage the phone or battery by causing it to swell, leak or malfunction. Do not dry a wet or damp battery with an appliance or heat source, such as a hair dryer or microwave oven. Do not leave your phone in an automobile or other vehicle with high temperatures.
- Do not drop the battery or the phone because the impact can damage them.
- Do not dispose of batteries in a fire, because they may explode. 
- Contact your service provider or Iridium if your phone or battery has been damaged from dropping or high temperatures.

WARNING!



Use of non-Iridium batteries or chargers may present a risk of fire, explosion, leakage or other hazard.



Important

Use only Iridium original products for safety and quality assurance. Iridium's warranty does not cover damage caused by use of non-Iridium batteries.

Battery Charging

Batteries may be charged and discharged many times, but eventually they wear out.

Important: Follow these guidelines when charging your battery:

- Keep the battery at room temperature. Never expose batteries to temperatures below 0°C (32°F) or above 45°C (113°F) when charging.
- New batteries are not fully charged and may take more time to charge.

Battery Disposal

Proper battery disposal is not only important for safety but also benefits the environment. Consumers should recycle used batteries and telephones in accordance with applicable national, state or local laws and regulations.



Under EU requirements, all electrical and electronic products must be taken to separate collection at the end of their working life and must not be disposed of as unsorted municipal waste.

Do not dispose of your battery in a fire.



Emergency Calling

CHECK WITH YOUR SERVICE PROVIDER FOR LOCAL EMERGENCY NUMBERS (full international access code, country code, and phone number) for all locations outside the United States and mainland Australia. Iridium currently only supports in-country emergency call routing to 911 within the United States and to Triple Zero (000) or 112 within mainland Australia. Outside of the United States and mainland Australia, calls to emergency access numbers such as 999, are not able to be made on the Iridium system. When placing a call to an emergency operator or local public safety answering point, always verbally report your location to assist first responders with identifying your location to provide assistance. Caller location identification is not automatically transmitted on the Iridium system.

Iridium does not guarantee network availability at all times due to situations where the network is unavailable due to satellite availability, terrain, weather, or other conditions that may prevent an emergency call from being placed.

EMERGENCY CALLS WITHIN THE UNITED STATES: Power on the Iridium Extreme™, extend the antenna towards the open sky, confirm proper registration & signal strength on the display, dial 911 and press the green send key. Verbally report the situation and your location to the operator for assistance. The Iridium service does not provide enhanced 911 service which automatically identifies the caller location.

EMERGENCY CALLS WITH MAINLAND AUSTRALIA: Power on the Iridium Extreme™, extend the antenna towards the open sky, confirm proper registration & signal strength on display, dial Triple Zero (000) or 112 depending upon your service provider's instructions, and press the green send key. Verbally report the situation and your location to the operator

for assistance. The Iridium service does not provide enhanced emergency calling service which automatically identifies the caller location.

EMERGENCY CALLS IN ALL OTHER LOCATIONS: You will need to obtain and dial the full international access code, country code, and phone number for the local fire, police, or ambulance depending upon the nature of the emergency. Power on the Iridium Extreme™, extend the antenna toward the open sky, confirm proper registration & signal strength on the display, dial the local emergency number obtained from your service provider or local advisor and press the green send key. Verbally report the situation and your location to the operator for assistance. The Iridium service does not provide enhanced emergency calling service which automatically identifies the caller location.

Antenna Care

Use only the supplied or an approved replacement antenna. Unauthorized antennas, modifications, or attachments could damage the phone and may violate government regulations. When using remote mount antenna, mount antenna at least 20 cm away from the user. Also when using a remote mount antenna in order to reduce potential radio interference to other users, the antenna type and its gain should be so chosen such that the equivalent isotropically radiated power (EIRP) is not more than that permitted for successful communication.

Driving and Operation of Other Motor Vehicles

The use of any wireless device, including a satellite telephone, may cause distraction. Discontinue a call if you cannot concentrate on driving. Check the laws and regulations on the use of wireless telephones in the areas where you drive. Always obey them. Many local governments prohibit the use of mobile telephones while driving. Observe the following guidelines when using your phone while driving:

- Give full attention to driving—driving safely is your first responsibility.
- Use hands-free phone operation, if available.
- Pull off the road and park safely before making or answering a call.

Posted Facilities

Turn your phone OFF in any facility where posted notices so require.

Blasting Areas

To avoid interfering with blasting operations, turn your phone OFF when in a “blasting area” or in areas posted: “Turn off two-way radio.” Obey all signs and instructions.

Potential Explosive Atmospheres

Areas with a potentially explosive atmosphere are often but not always clearly marked. They include, but are not limited to: fueling areas such as gasoline stations; below deck on boats; fuel or chemical transfer or storage facilities; areas where fuel odors are present (for example, if a gas/propane leak occurs in an automobile or home); areas where the air contains chemicals or particles, such as grain, dust, or metal powders; and any other area where you normally would be advised to turn off your vehicle engine.



Turn your phone OFF and do not remove, install or charge your battery when you are in any area with a potentially explosive atmosphere. Obey all signs and instructions. Sparks from your battery in such areas could cause an explosion or fire resulting in bodily injury or even death.



Electronic Devices

Most electronic equipment is subject to interference from RF energy from external sources if inadequately shielded. In some circumstances your mobile device may cause interference with other devices. Turn off your phone in any location where posted notices instruct you to do so.

For optimal performance and to be sure that exposure to RF energy does not exceed guidelines set forth in the relevant standards (discussed in “Exposure to Radio Frequency Signals” on page 4 and “Specific Absorption Rate Data” on page 4), always follow the instructions and precautions.

Product Operation

If you wear the satellite phone on your body, always place it in an Iridium leather case. Refer to www.iridium.com.

Using accessories not supplied by Iridium may cause your satellite phone to exceed RF energy exposure guidelines.

Radio Interference

Your satellite phone contains digital circuits for the display of data and connection to a personal computer. Emissions from these circuits can cause radio interference. With respect to such circuits, this device complies with part 15 of the FCC Rules. Operation is subject to the following two conditions: (1) This device may not cause harmful interference, and (2) this device must accept any interference received, including interference that may cause undesired operation. This statement does not apply to digital

circuits used only to enable the operation of the transmitter in this satellite phone. The receiver in this phone is subject to the condition that radio emissions from it not cause harmful interference.

This equipment has been tested and found to comply with the limits for a Class B digital device, pursuant to Part 15 of the FCC Rules. These limits are designed to provide reasonable protection against harmful interference in a residential installation. This equipment generates, uses and can radiate radio frequency energy and, if not installed and used in accordance with the instructions, may cause harmful interference to radio communications. However, there is no guarantee that interference will not occur in a particular installation. If this equipment does cause harmful interference to radio or television reception, which can be determined by turning the equipment off and on, the user is encouraged to try to correct the interference by one or more of the following measures:

- Reorient or relocate the receiving antenna.
- Increase the separation between the equipment and receiver.
- Connect the equipment into an outlet on a circuit different from that to which the receiver is connected.
- Consult the dealer or an experienced radio/TV technician for help.

Implantable Medical Devices

If you have an implantable medical device such as a pacemaker or defibrillator, the Health Industry Manufacturers Association recommends that a minimum separation of six inches (6") be maintained between a handheld wireless phone and a pacemaker to avoid potential interference with the pacemaker. These recommendations are consistent with the independent research by and recommendations of Wireless Technology Research.

Persons with pacemakers:

- should ALWAYS keep the phone more than six inches from their pacemaker when the phone is turned ON.
- should not carry the phone in a breast pocket.
- should use the ear opposite the pacemaker to minimize the potential for interference.
- should turn the phone OFF immediately if there is any reason to suspect that interference is taking place.

Hearing Aids

Some digital wireless phones may interfere with some hearing aids. In the event of such interference, you may want to consult your hearing aid manufacturer to discuss alternatives.

Other Medical Devices

If you use any other personal medical device, consult the manufacturer of your device to determine if it is adequately shielded from external RF energy. Consult your physician to determine compatibility with your medical device.

Turn your phone OFF in health care facilities when any regulations posted in these areas instruct you to do so. Hospitals or health care facilities may be using equipment that could be sensitive to external RF energy.

Aircraft

Airline regulations prohibit using your phone while in the air. Check and comply with the policy of your airline regarding the use of your phone while the aircraft is on the ground.

Switch OFF your phone before boarding an aircraft.

Vehicles

RF signals may affect improperly installed or inadequately shielded electronic systems in motor vehicles. Check with the manufacturer or its representative regarding your vehicle. You should also consult the manufacturer of any equipment that has been added to your vehicle.

Vehicles Equipped with an Air Bag

An air bag inflates with great force. Do NOT place objects, including installed or portable wireless equipment, in the area over the air bag or in the air bag deployment area. If in-vehicle wireless equipment is improperly installed, serious injury could result.

Adult Use Only

Keep your phone and accessories away from children. These products are not toys and may be hazardous to small children. For example:

- A choking hazard may exist for small, detachable parts.
- Improper use could result in loud sounds, causing hearing injury.
- Improperly handled batteries could over heat and cause a burn.

Glass Parts

Some parts of your satellite phone may be made of glass. This glass could break if the product is dropped on a hard surface or receives a substantial impact. If glass breaks do not touch or attempt to remove. Stop using the phone until the glass is replaced by a qualified service center.

Extended Exposure to Loud Noise

Exposure to loud noise from any source for extended periods of time may affect your hearing. The louder the volume sound level, the less exposure is required to affect your hearing. To protect your hearing:



- Limit the amount of time you use headsets or headphones at high volume.
- Avoiding turning up the volume to block out noisy surroundings.
- Turn the volume down if you cannot hear people speaking near you.

Seizures and Blackouts

Some people may be susceptible to epileptic seizures or blackouts when exposed to flashing lights, such as when playing video games. If you or your family members have a history of such seizures or blackouts, please consult your physician before enabling a flashing lights feature on your phone. Discontinue use or consult a physician if any of the following symptoms occur: convulsion, eye or muscle twitching, loss of awareness, involuntary movements or disorientation.

Repetitive Motion

When you repeatedly perform actions such as pressing keys or entering finger-written characters, you may experience occasional discomfort in your hands, arms, shoulders, neck or other parts of your body. If you continue to have discomfort during or after such use, stop use and see a physician.

3: Iridium Extreme™ Overview

Guide Overview

This chapter provides a complete tour of the Iridium Extreme™. You will discover all the features and components that you need to operate your phone to its full potential.

For ease of use, the chapters in this manual are divided by menu options. Each section of the chapter is then divided by the same sub-menu options as your phone. Just follow the sequence of menus on your phone, the manual will follow along, making the startup process a simple one.



Phone Overview

Front View



Side View

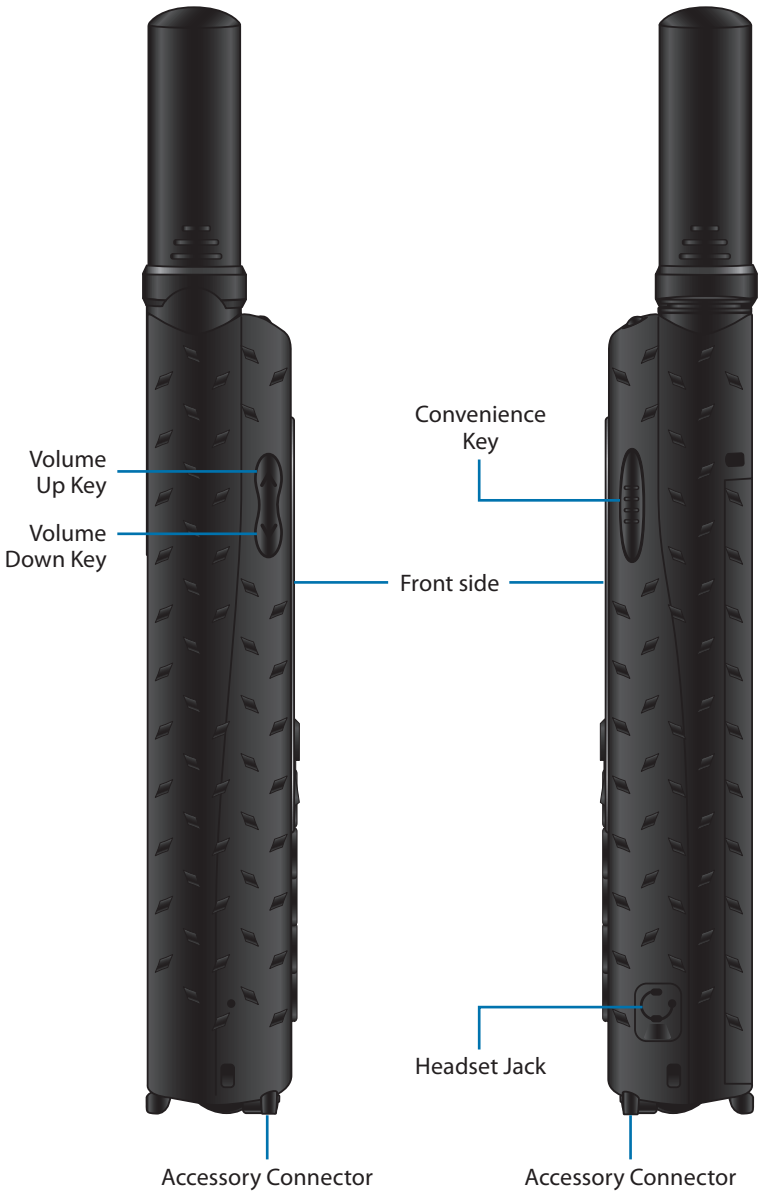

Back View

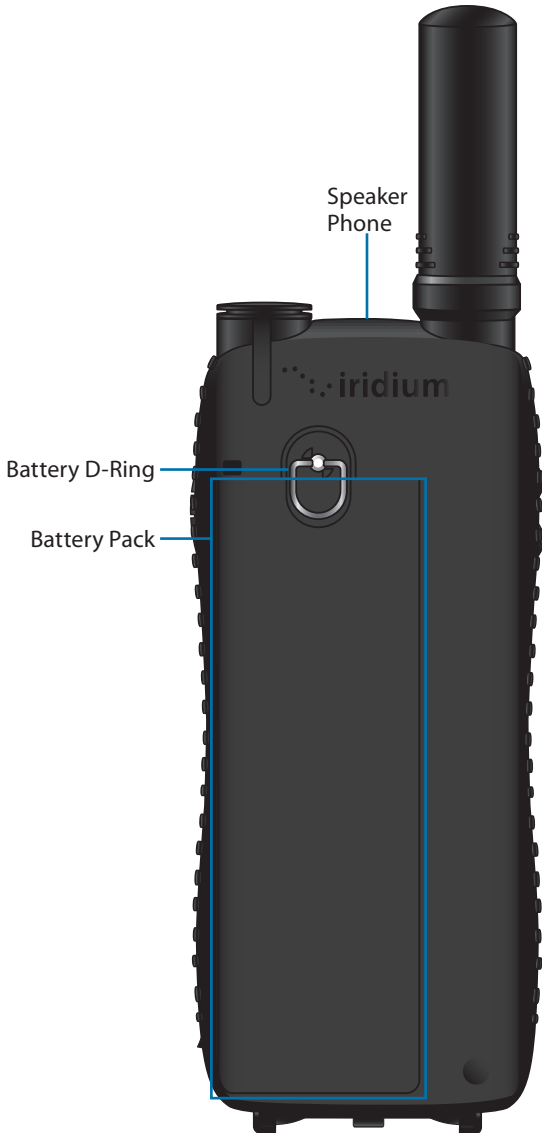

Charging / USB / External Antenna Adapters

Included with the Iridium Extreme™ are two adapters. These adapters attach to the bottom of your phone and are required for charging, connecting the USB data cable, or using the external antenna. These adapters are designed to provide a robust and flexible approach to using external accessories with the Iridium Extreme™.

Adapter #1: Charging / USB

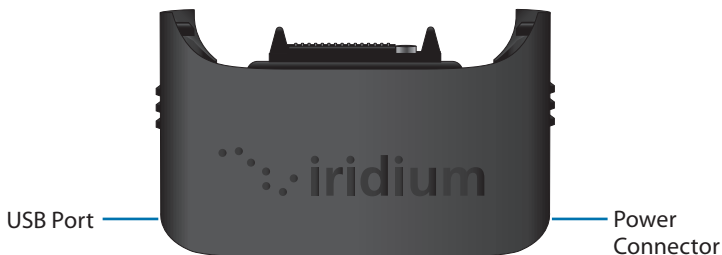

- This adapter is to be used for charging the phone or connecting to a laptop via USB data cable when the phone's antenna is used.

Adapter #2: Charging / USB / External Antenna

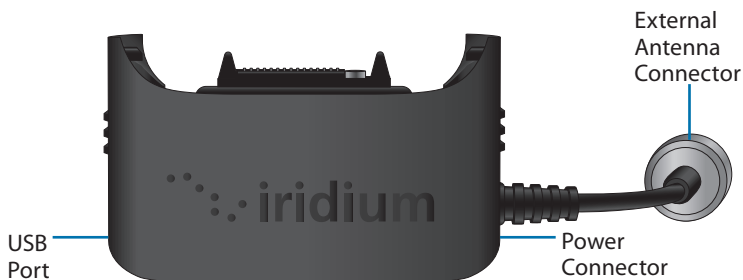

- This adapter is to be used for charging the phone or connecting to a laptop via USB data cable when a wired, external antenna is used. This adapter provides a TNC connector that is compatible with the included 5' external antenna.

Installation of the adapter

- In order to charge, use the USB port, or connect an external antenna, the appropriate adapter must first be selected and attached to the bottom of the phone.
- Prior to installation, open your phone's accessory connector cover on the bottom of your phone and move it to the back of your phone, securing it to the rear retaining features.
- Select the appropriate adapter and orient it with the bottom of the phone so the Iridium brand is facing forward. Then press the adapter up until the side clasps are locked into place and the adapter is securely fastened to your phone.



Use of the adapter

- Once the appropriate adapter is installed on the phone, you may now connect the charging, USB data, or external antenna to your phone.

- Note that the Charging / USB / External Antenna adapter should only be used if you are planning to connect an external antenna. When this adapter is connected, use of your phone's antenna will temporarily be suspended while the Charging / USB External Antenna adapter is connected.

Removal of the adapter

- To remove the adapter, hold your phone with your left hand and grasp the adapter on both sides. Press the bottom portions of the side clasps with your thumb and index fingers and pull the adapter away from the phone.
- Last, move the accessory connector cover back to the accessory connector and press it so it is securely in place.

Accessories

AC Travel Charger and International Plug Kit

The AC Travel Charger and International Plug Kit provides rapid charge for optimal performance. The AC Travel Charger plugs directly into the power connector on the right side of your adapter.

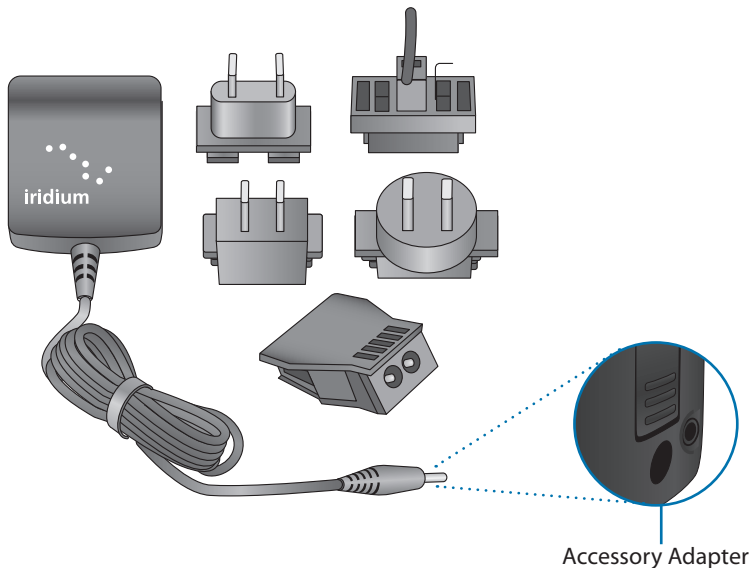

- Can be used to power the phone when the battery is depleted.

- The battery must be installed when using the charger to power the phone.
- Includes five international plug adapters for use in many countries around the world.
- Allows you to use the Iridium Extreme™ while recharging the battery. The battery should not be allowed to discharge fully.

Headset

The convenient headset provides both an earphone and microphone in one small piece for simple hands-free and private telephone conversations. The headset plugs directly into the jack on the right side of your phone.

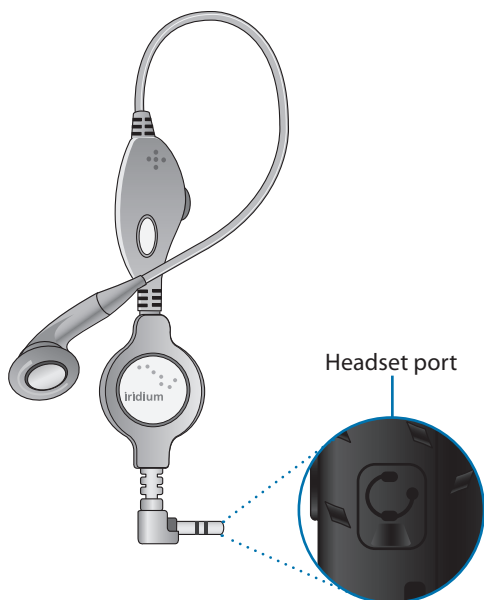

Auto Accessory Charger

The Auto Accessory Charger provides a rapid charge for your phone from DC charging sources such as cars, boats, or solar charging panels. The Auto Accessory Charger plugs directly into the power connector on the right side of your adapter.

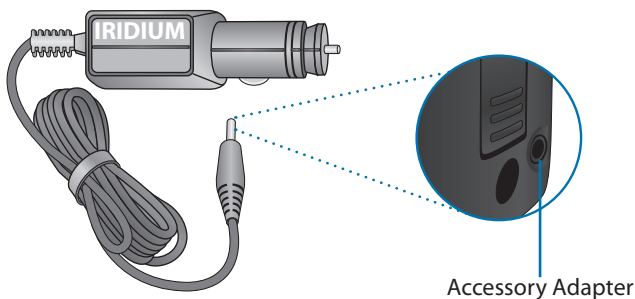

External Antenna

The External Antenna is designed to allow you to use your phone while inside an enclosed area in close proximity to an open view of the sky. The External Antenna screws on to the TNC connector on your Accessory Adapter. To install, hold the Accessory Adapter's TNC connector in place while attaching the External Antenna and take care not to twist the wires. Then attach the Accessory Adapter with connected External Antenna to your phone and place the External Antenna in an area with a view of the open sky for use.



Leather Case

The leather case is designed to hold your phone, help protect it from scratches, and allow you to attach it to other items with the built-in clip. To attach the leather case to your phone, ensure the bottom of the case is open and insert the phone through the bottom and push it towards the top. The leather case is designed to be used either with our without the accessory adapters so an extended leather flap and Velcro is provided for this purpose.

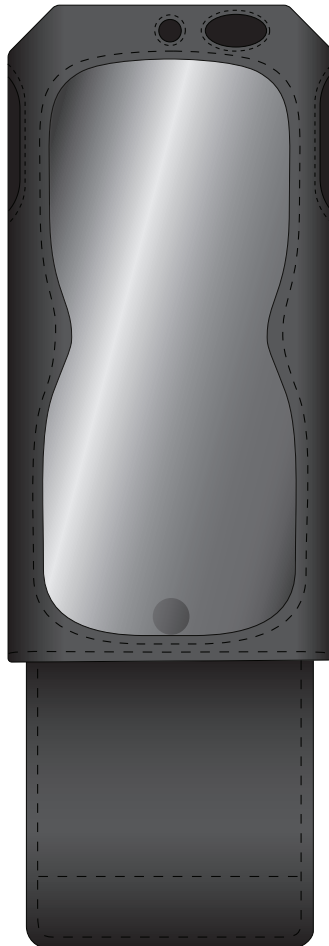

USB Data Cable

The USB data cable allows you to connect your Iridium Extreme™ phone to a laptop in order to provide a data connection for email or web access. Software and installation instructions are provided on your included CD-ROM or can be obtained from your service provider. The USB Data Cable plugs directly into the mini-USB connector on the left side of your Accessory Adapter. Make sure your Accessory Adapter is connected to your phone, the USB cable is attached to your laptop, and software is installed for use. Airtime charges apply for data service usage.



Indicators



Status Indicator LED

The status indicator at the top of the phone has the following meanings:

LED is ...	Indicates
Alternating red and green	Call in progress; ringing, dialing or in call.
Flashing green	Network is available and SIM status okay. Phone is idle.
Flashing red	No connection to network or valid SIM card is required.

SOS Indicator LED

The status indicator at the top of the phone has the following meanings:

SOS LED is ...	Indicates
Flashing red	Obtaining location
Flashing orange	Sending location
Flashing yellow	Location sent
Flashing green	Location sent and will wait for five (5) minutes to obtain and send new location.

Display Status Indicators and Icons

The following icons appear in your display to provide you with information about the phone's activity.

Main Screen Components

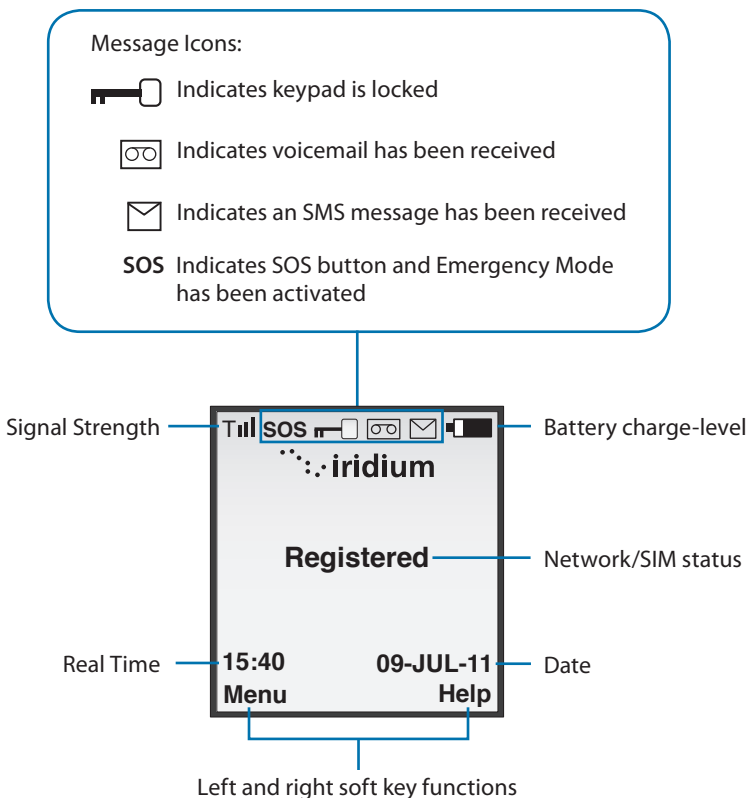

Menu Components

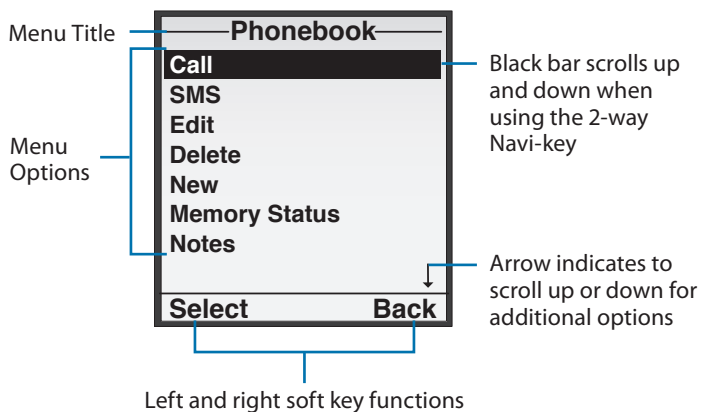

4: Getting Started

Using the SIM Card

You will receive a Subscriber Identity Module (SIM) card from your service provider that is required for use with your phone. The SIM card is a smart card that contains your service details and memory for storing phone book entries and messages.

Your phone has limited functionality without the SIM card, so you want to install the card before using your phone.

SIM Card Care

You may want to keep your card with you when you are not using your phone. This helps keep your personal information secure and gives you access to your service even if your phone is not available.

Important: Do not bend or scratch your SIM card, and avoid exposing your card to static electricity, water or dirt.

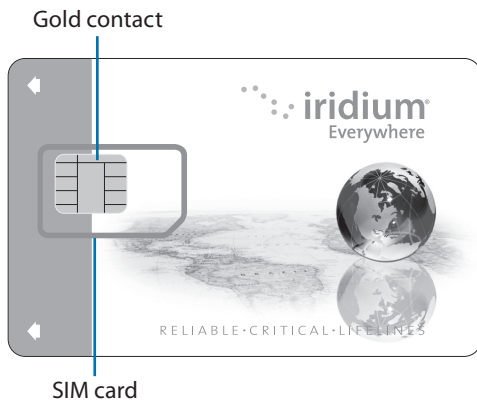

Insert the SIM Card



1. Remove the SIM card from the larger card.
2. Remove the battery as shown on page 27.
3. Slide the SIM card into the SIM card slot. Follow the card orientation shown on the decal. Be sure the gold contact is facing down.
4. Slide the retaining clip down until you hear a 'click' to secure the SIM card.



- SIM Decal
- SIM Door
- SIM Card

Remove the SIM Card

First unlock the retaining clip, then swing out the retaining clip and slide the SIM card out of the slot.

Battery Pack Information

All batteries may cause serious injury or property damage, particularly if handled improperly or used after damage.

Warning!

Improper treatment or use of batteries may present a danger of fire, explosion, leakage, or other hazard.



Make sure to follow all of the following safety guidelines:

- Do not disassemble, crush, puncture, shred or otherwise attempt to change the form of the battery.

- Do not let the phone or battery come in contact with water. Water can lead to corrosion of the phone's circuits.



- Do not allow the battery to touch metal objects. Contact with metal objects can cause the battery to heat and possibly explode.



- Do not place your battery near a heat source. Excessive heat can damage the phone or battery by causing it to swell, leak or malfunction. Do not dry a wet or damp battery with an appliance or heat source, such as a hair dryer or microwave oven. Do not leave your phone in an automobile or other vehicle with high temperatures.

- Do not drop the battery or the phone because the impact can damage them.

- Do not dispose of batteries in a fire, because they may explode.



- Contact your service provider or Iridium if your phone or battery has been damaged from dropping or high temperatures.

WARNING!



Use of non-Iridium batteries or chargers may present a risk of fire, explosion, leakage or other hazard.



Important

Use only Iridium original products for safety and quality assurance. Iridium's warranty does not cover damage caused by use of non-Iridium batteries.

Battery Charging

Batteries may be charged and discharged many times, but eventually they wear out.

Important: Follow these guidelines when charging your battery:

- Keep your battery near room temperature. Never expose batteries to temperatures below 0°C (32°F) or above 45°C (113°F) when charging.
- New batteries are not fully charged and may take more time to charge.

Battery Disposal

Proper battery disposal is not only important for safety but also benefits the environment. Consumers should recycle used batteries and telephones in accordance with applicable national, state or local laws and regulations.



Under EU requirements, all electrical and electronic products must be taken to separate collection at the end of their working life and must not be disposed of as unsorted municipal waste.

Do not dispose of your battery in a fire.



Remove and Install the Battery Pack

The back panel of the phone is the battery pack. You need to remove the battery pack to insert the SIM card or replace the battery.

To Remove the Battery Pack



1. Lift D-ring up and rotate counterclockwise 90 degrees
2. Pull D-ring forward and remove battery pack

To Install the Battery Pack



1. Before installing battery pack, ensure D-ring is raised and in vertical position (as pictured)
2. Hold the D-ring in the vertical position and place bottom of battery in first, aligning the battery pack pegs to ensure that the battery is fully seated at the bottom
3. Push the top portion of the battery in ensuring that the D-ring pin is aligned properly when pressed into the phone
4. Once the battery is fully inserted, rotate the D-ring clockwise 90 degrees and put the D-ring into the stowed position

Charging the Battery

Use the AC travel charger or auto accessory adapter to charge the Iridium Extreme™.

Important: The battery should only be charged in environments between 0°C (32°F) to 45°C (113°F).

Charge the Battery Pack

1. Connect the travel charger or auto accessory charger to the accessory adapter and ensuring that the accessory adapter is attached to your phone.



Power connector on adapter

2. Plug the AC travel charger or auto accessory adapter into the appropriate power source. The phone beeps.
3. The battery symbol on the LCD display flashes.

Note: Calls can still be made or received while the battery is charging; however the battery charges faster if the phone is turned off. When the Iridium Extreme™ is not in use the battery takes approximately 4 hours to fully charge.

You must wait a minimum of 5 seconds before powering on the Iridium Extreme™ after you have disconnected from the charger.

Checking Battery Charge Level

Low Battery Warning

Your phone has two ways to indicate that the battery is low and only a few minutes of talk time remains:

1. The battery charge indicator appears continuously in the upper right hand corner of the display. When the battery charge is low the icon appears empty, and Low Battery appears on the display.

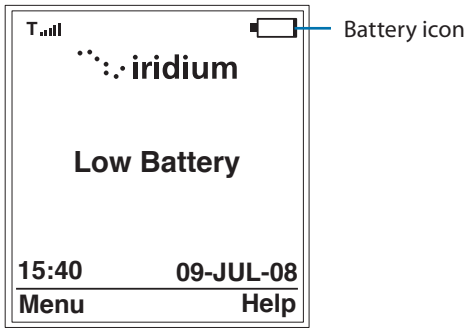

2. A warning tone (two double beeps) sounds.

Note: To help maintain the best battery and phone performance, recharge your battery as soon as possible after you receive the low battery warning.

Start-up Procedure

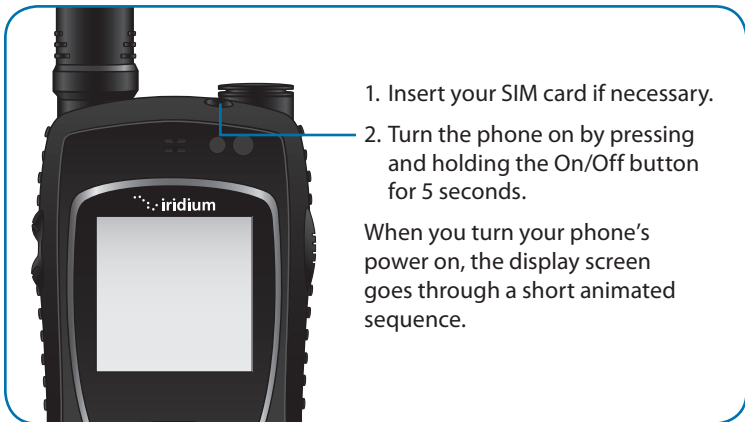

Power on Message

Once your phone is on, one of the following messages may appear.

Message	Directive
Bad Card	See Supplier. Your SIM card has been damaged or incorrectly issued. Contact your service provider for information.

Message	Directive
Check Card	The SIM card is damaged or inserted the wrong way.
Denied	Your phone has seen a network, but has been denied access.
SIM PIN	Enter the four- to eight-digit SIM card PIN code provided by your service provider and press OK to proceed. See "Using the Security Menu" on page 153, for more information about your SIM.
Invalid Account	Contact your service provider.
Phone PIN	The phone has been locked. To unlock the phone, you must enter the correct Phone PIN number.
PIN Blocked	When the PIN number has been entered incorrectly three times in a row, the phone automatically blocks the PIN. To unblock the pin, enter the PUK1 code for the phone by entering **05* from the main screen.
PIN 2 Blocked	When the PIN2 number has been entered incorrectly three times in a row, the phone automatically blocks the PIN. To unblock the PIN2 enter the PUK2 code for the phone by entering **052* from the main screen.
Registered	Your phone is now registered with the network.
Searching for network...	The phone is attempting to establish communications with the satellite network. This message appears while your phone searches for a network connection.
CAUTION! Emergency call recipient has not been configured. Refer to user guide and edit.	Emergency Actions is set to Message and Call or Call Only and a Call Recipient has not been configured. See Chapter 14: GPS and Location Based Services for information on configuring the Emergency Call Recipient. Press Edit to configure the Emergency Call Recipient or Cancel to proceed to the main window.

Message	Directive
<p>CAUTION! Emergency SMS recipient has not been configured. Refer to user guide and edit.</p>	<p>Emergency Actions is set to Message and Call or Message Only and SMS contact has not been configured. See Chapter 14: GPS and Location Based Services for information on configuring the Message recipient.</p> <p>Press Edit to configure the Message Recipient or Cancel to proceed to the main window.</p>

Phone Operation

Normal Operation

Hold the phone as you would any other telephone. Fully extend the antenna then rotate the antenna to either the left or right detent. The antenna should be vertical to the ground and have a clear unobstructed view of the sky.

Tips on Efficient Operation

For your phone to operate most efficiently:

1. Keep your phone battery charged to ensure that the phone is ready for use when needed.
2. Fully extend your antenna and rotate top portion of antenna as needed to ensure antenna is pointed directly up while in use.
3. Make sure the antenna has a clear unobstructed view of the sky.
4. Do not touch the antenna unnecessarily when the phone is in use.
5. Contact with the antenna affects call quality and may cause the phone to operate at a higher power level than otherwise needed.
6. Do not wear the phone on your body while making calls with the headset accessory. Wearing the phone on the body can interfere with proper phone operation, since the antenna requires a clear unobstructed view of the sky to access the Iridium® satellite network.
7. Once you complete your call and are finished with the phone, return the antenna to the center upright position and gently retract the antenna before carrying or storing the phone between uses.
8. For backup, keep a written record of all important information stored on your phone.

Placing a Call

Before you place a call:

1. The phone must be powered on.
2. SIM card inserted.
3. Phone is unlocked.
4. Have a clear direct view of the sky to be in contact with the network.
5. Antenna should be extended and pointed up towards the sky.

Dial the Number

As you enter a phone number, the digits are displayed on a single line that scrolls across the display.

1. Enter the number using the key pad. As you begin entering digits, you see **Options** displayed above the left soft key and **Clear** displayed above the right soft key.

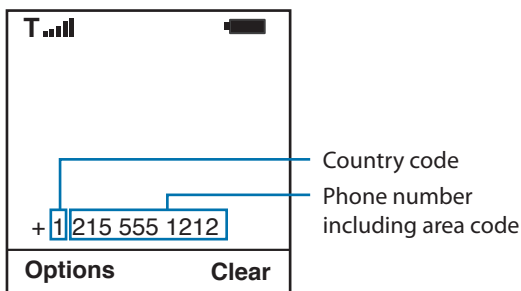

The phone number must be entered in international format: + or 00 [country code][phone number]. Your Iridium Extreme™ will automatically enter a + for the international access code so the only numbers that are required to add are the country code and phone number.

Note: All Iridium subscriber numbers begin with county code of **8816** unless an alternative access number has been issued by your service provider.

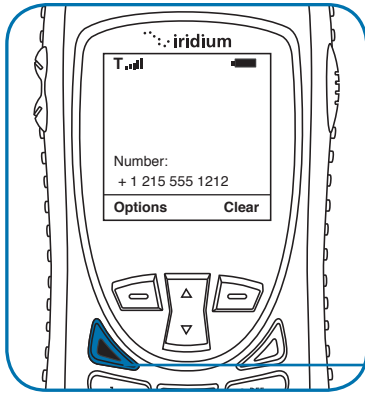

2. Press the **green** key.

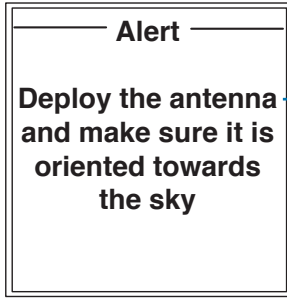

Note: You receive this message when the antenna is not fully extended from the Iridium Extreme™.

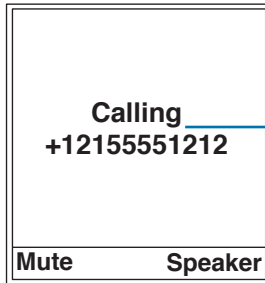

3. Calling followed by the number you dialed appears in the display.

If the call does not connect, one of the following messages appears.

Message	Directive
Busy Try Later Or Please Try Later	The phone is unable to access the network. Try again in a few minutes
Could not place call. No connection to the network	The phone is unable to access the network.
Restricted Area	The phone is unable to access the network. Move to an area where calls are allowed.

Note: If you have disabled the timer, **Connected** display.

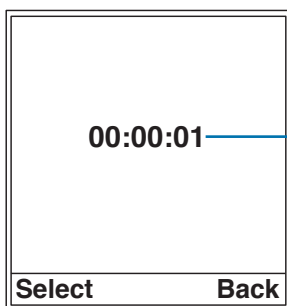

4. A timer keeps track of the duration of each call.

End a Call

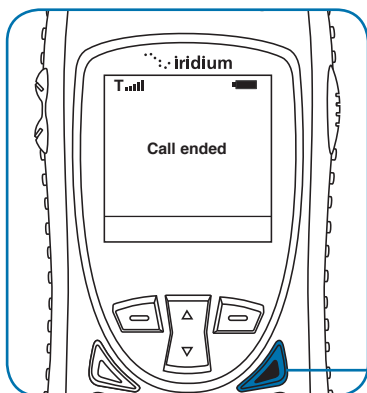

Press the **red** key.

Re-dial Last Number Called

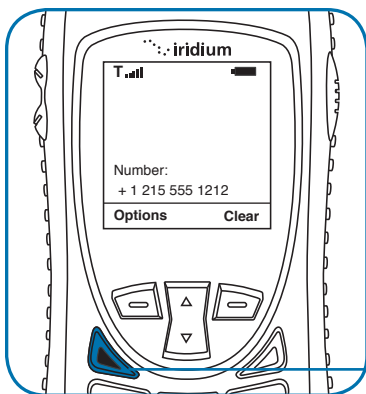

Press the **green** key twice.

Receiving a Call

Before you receive a call:

1. The phone must be powered on.
2. A valid SIM card must be inserted.
3. Phone is unlocked.
4. The phone must be connected with the network.

There are two scenarios for receiving calls depending on the antenna position:

1. Antenna extended
2. Antenna stowed; that is, in the down position.

Receiving a call with the Antenna Extended

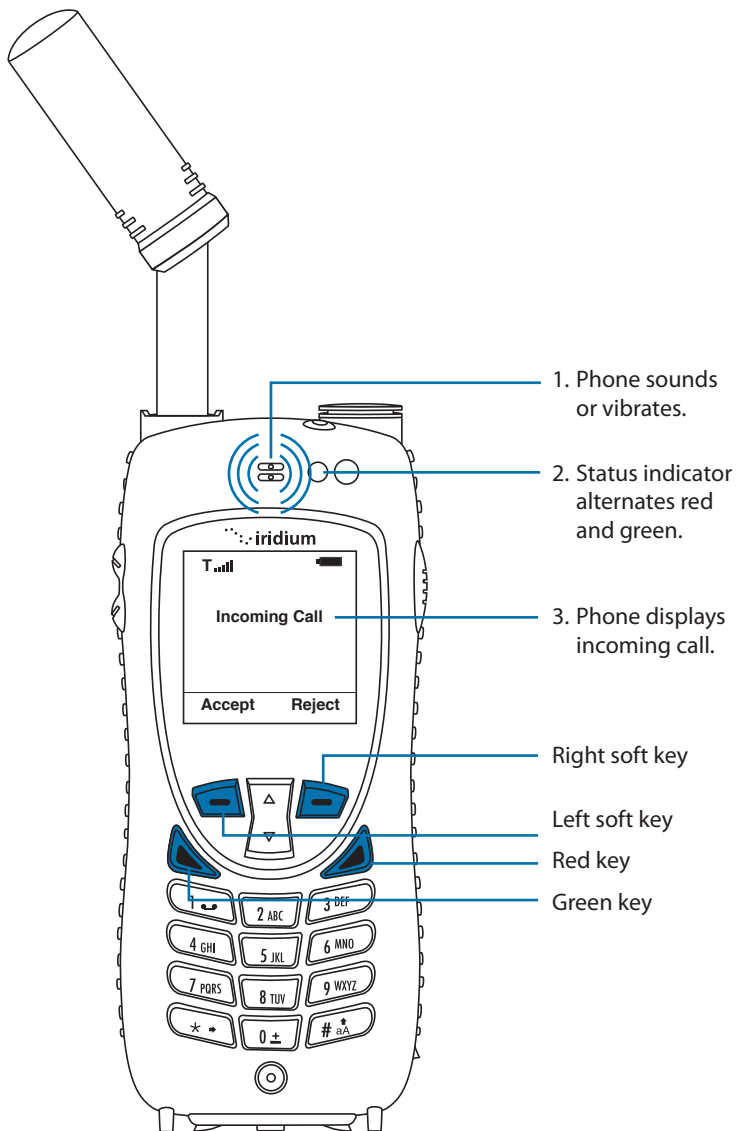

Answering the call with the Antenna Extended

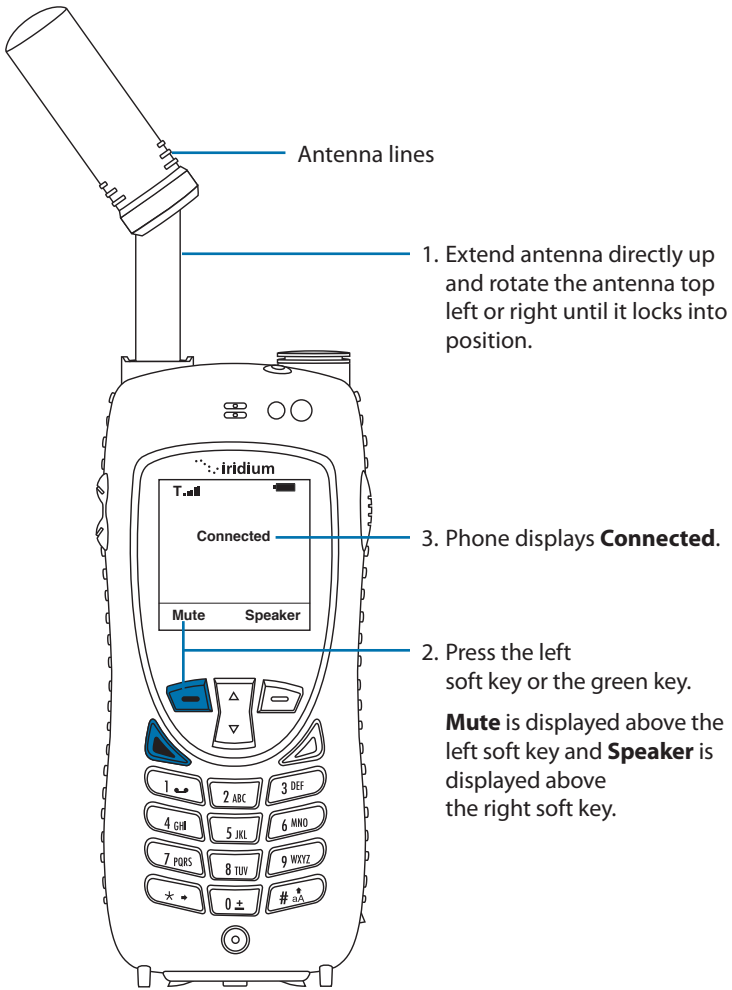

If the call does not connect properly, the following message appears:

Message	Directive
Call Failed	The antenna is not properly positioned or the network signal is not strong enough.

Receiving a Call with the Antenna Stowed

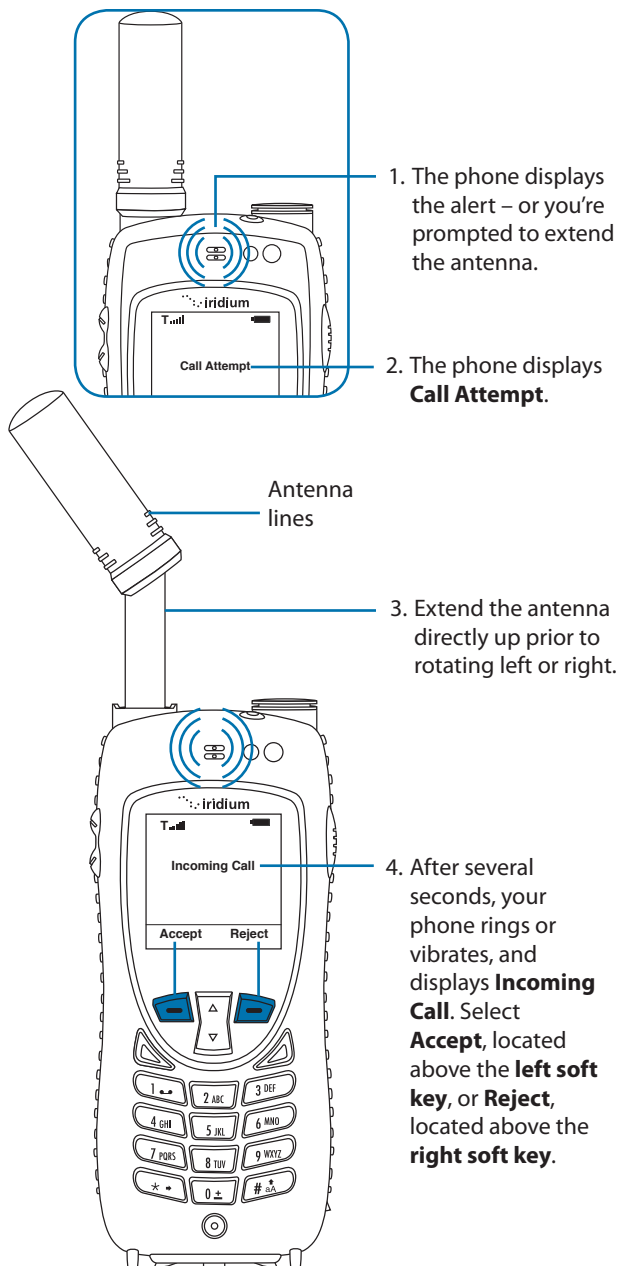

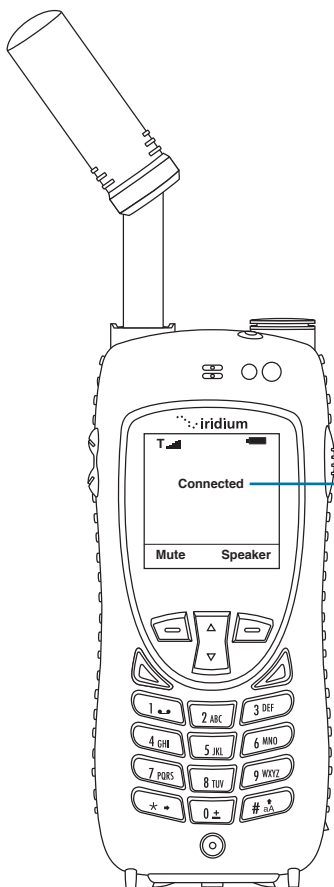

5. The phone displays **Connected**.

If the call does not connect properly, the following message appears:

Message	Directive
Call Failed	The antenna is not properly positioned or the network signal is not strong enough.

Muting a Call

For privacy during a call, use the mute feature. You hear the party on the other end, but they do not hear you.

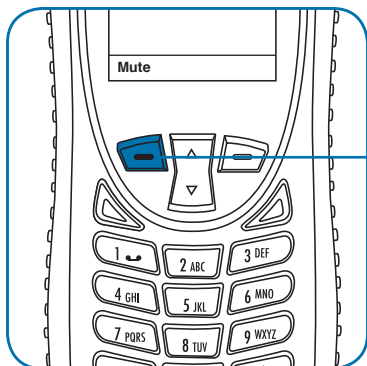

To mute the call:
Press the **left soft key**.

To un-mute the call:
Press the **left soft key** again.

Speaker Phone

To allow the call to be shared with other people within close proximity to your phone, use the speaker phone feature. In this mode the speaker in the rear of the phone is used instead of the normal earpiece/receiver.

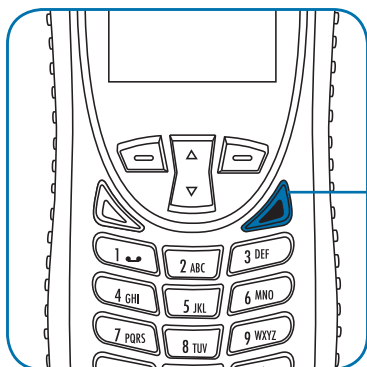

To use speaker phone: Press the **right soft key**.

To switch back to the earpiece: Press the **right soft key** again.

Speaker Volume

The speaker volume can be adjusted either while on a call or with the Volume and Tones menu located under the Setup menu.

1. Increase the speaker volume by pressing the **upper volume control**

key, during a call. Once you are satisfied with the volume press **OK**. If you would like to cancel the change to the volume press **Back**.

2. Decrease the speaker volume by pressing the **lower volume control** key, during a call.

As you press the keys, you hear the new volume level. The bar graph on the display indicates the volume level; the higher the graph, the louder the volume.

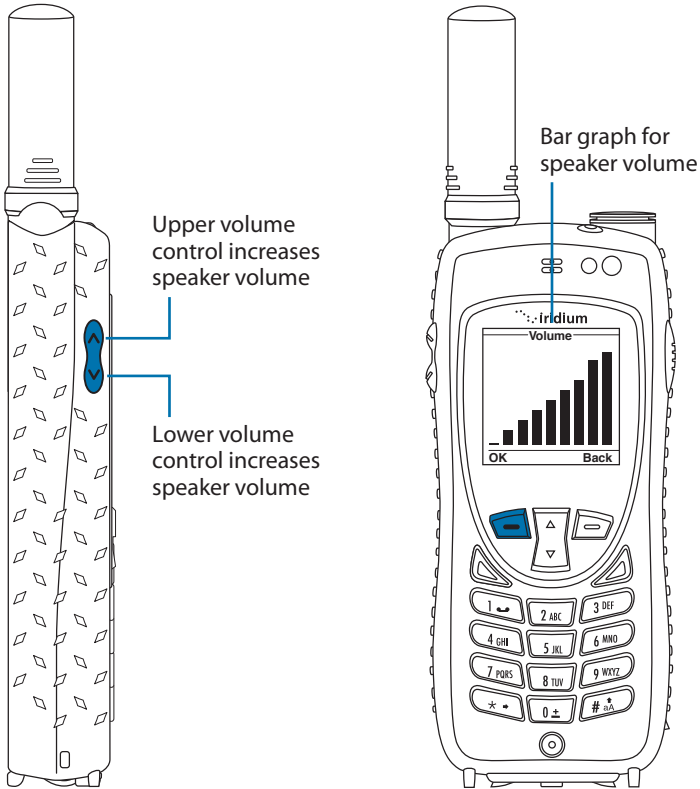

Ringer Volume

The ringer volume may be adjusted with the Volume and Tones menu located under the **Setup** menu.

- Increase the ringer volume by pressing the **upper volume control** key.
- Decrease the ringer volume by pressing the **lower volume control** key.

- As you press the keys, you hear the new volume level. The bar graph on the display indicates the volume level; the higher the graph, the louder the volume.

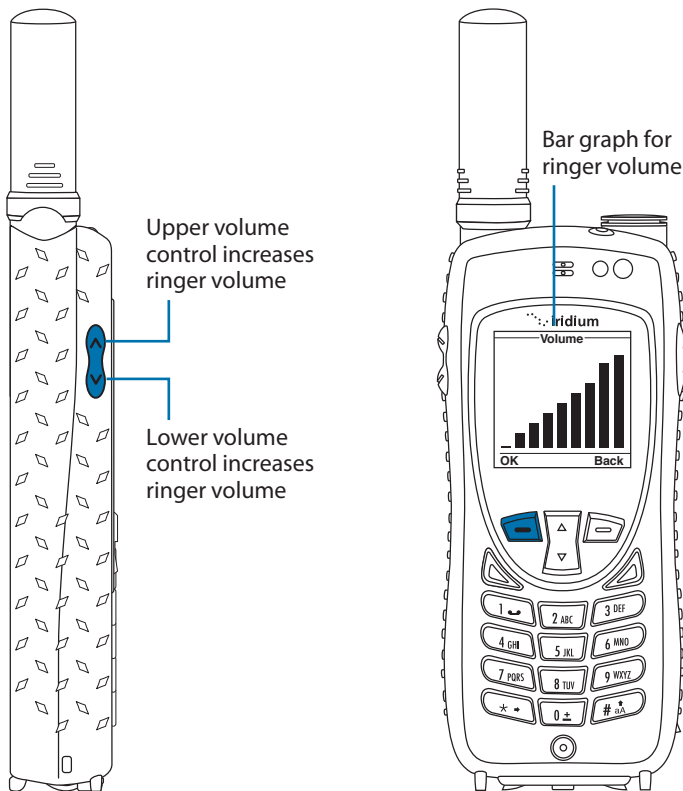

Unanswered Calls

If you are away from your phone or choose not to answer a call the screen displays the number of missed calls.

Messages from Missed Calls

If you are not able to answer your phone, or are not connected to the network, callers can leave you a voice message which can be accessed from the voicemail system. When connected to the network, a message icon appears on your screen indicating a new voicemail message.

For more information on retrieving messages, see "Using the Voicemail Menu" on page 105.

Locking and Unlocking the Keypad

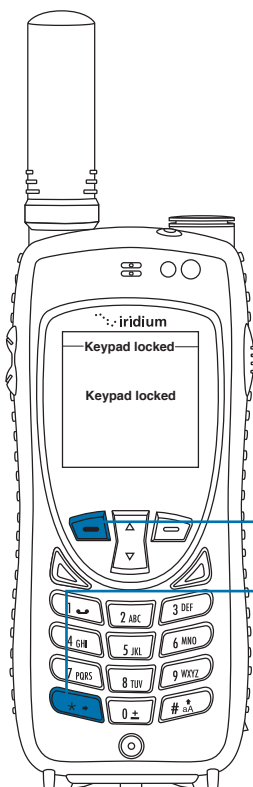

To prevent accidental phone usage you can **lock the keypad** by:

1. Press the **left soft key**, labeled **Menu**.
2. Press the *** key** to lock the keypad. A message will flash indicating the keypad is locked.

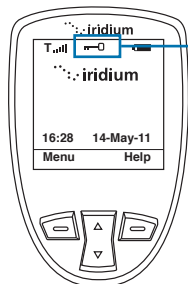

3. The **Main Screen** will now have a lock symbol.

Note: All keys with the exception of the power key are locked. You can still answer an incoming call by pressing the green key or the left soft key when the keypad is locked.

Unlocking the Keypad

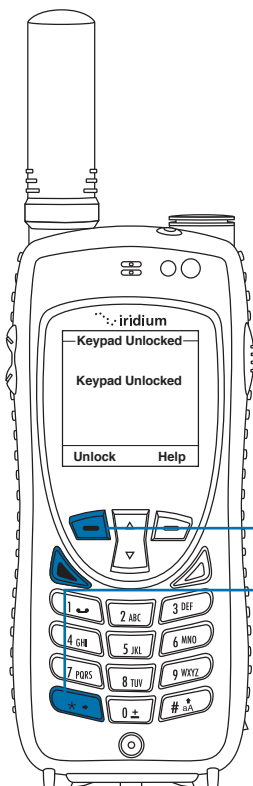

1. Press the **left soft key** labeled **Unlock**.
2. Press the *** key**. A message flashes indicating the keypad is unlocked, and the lock symbol no longer appears on the main screen.

5: Using Menus and Keys

Many of the phone's features are organized into lists of options called menus. Use the phone keys to navigate these menus.

Using the Keys

The Soft Keys

When you press the soft keys the function appears above the key on the display screen. The function varies depending on the menu.

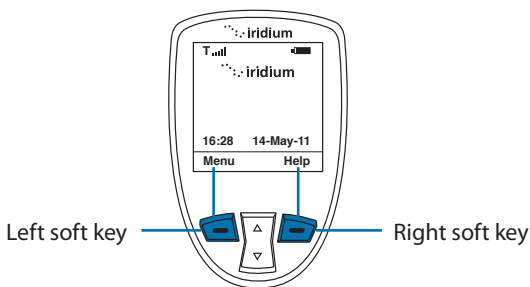

The 2-way Navi-key

Press the 2-way Navi-key up to step through the options on a menu screen.

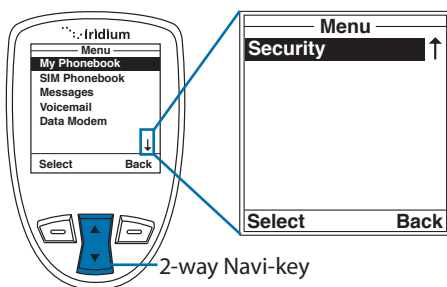

Important: When an arrow appears on the bottom of any menu screen it indicates more options to follow. To see all options, you must continue to press the 2-way Navi-key.

The Keypad

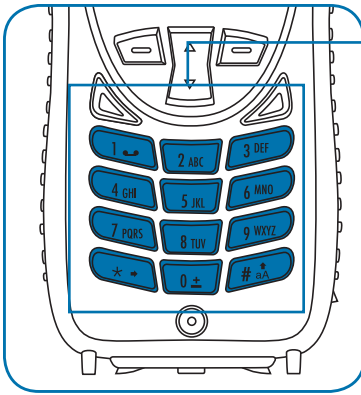

The numbered and alphabetized keys make up the Keypad. Use the keys to enter text, numbers and punctuation marks into various fields in display screens. See entering characters on page 48 for more information.

Using the Menu

To Access the Main Menu

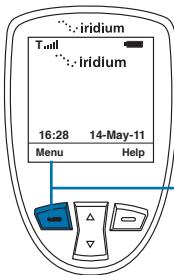

Starting from the **Main Screen**:

Press the **Left soft key**, labeled **Menu**.

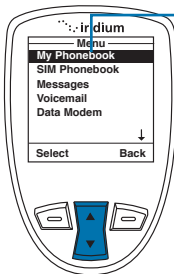

The **Main Menu** appears. The Main Menu consists of:

- My Phonebook
- SIM Phonebook
- Messages
- Voicemail
- Data Modem
- Call History
- Setup
- Security

Note: You cannot access the Menus during a call.

To Access Main Menu Options

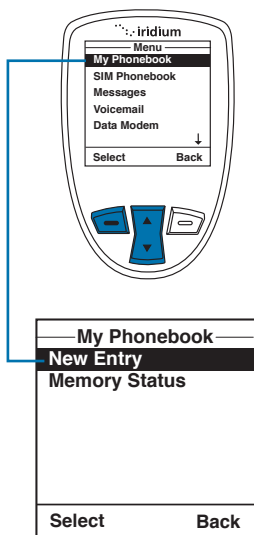

Starting from the Main Menu, use the **2-way Navi-key** to scroll to the desired menu option until it is highlighted.

Press the **left soft key**, labeled **Select**. The option you selected appears. Continue this procedure for each sub-menu.

To Return to a Menu

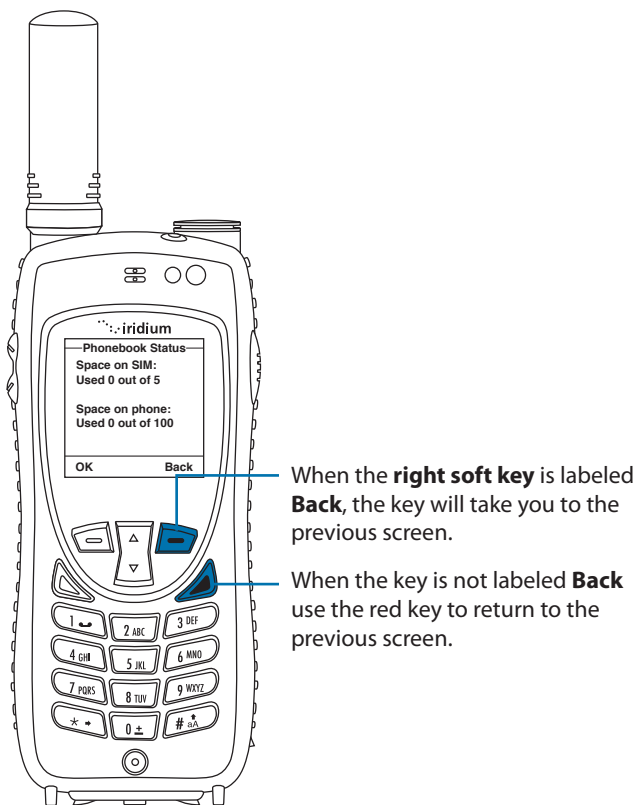

Note: In all other instances the red key will return you to the Main Screen.

Entering Characters

Many of the menu screens have fields where you need to enter information such as names and addresses. To enter this information you need to use the keys on the keypad. Entry of text with the keys on the keypad is discussed in detail in “Traditional Text Entry” on page 51 and “Predictive Text Entry” on page 57.

When creating phonebook entries and/or composing text messages; you can use both the side volume keys and the navigation key to help navigate between characters or lines of text without deleting.

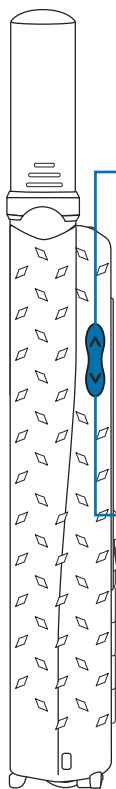

The **up volume key** takes you backwards through text when you are editing a phone book entry. If you are editing a message, it moves you up a line of text. Choosing **Up** on the **2-way Navi-key** moves backwards through message text.

The **down volume key** takes you forward through text when you are editing a phone book entry. If you are editing a message, it moves you down a line of text. Choosing **Down** on the **2-way Navi-key** moves forward through message text.

6: Traditional Text Entry

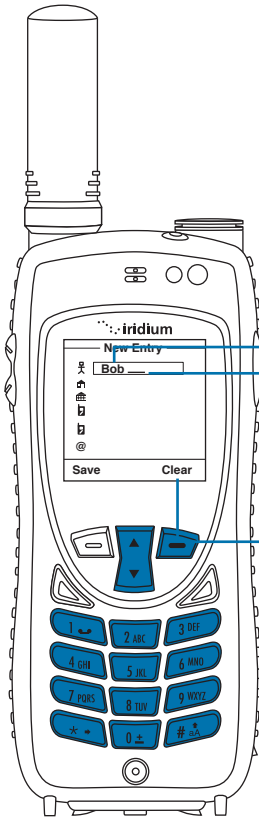

To enter characters via traditional method:

1. Enter a character by pressing the appropriate keys on the keypad. See keypad guide below.
2. The cursor moves to the next character position.
3. To delete a character press the **Right Soft Key**, labeled **Clear**.
4. Repeat steps 1 and 2 as many times as necessary.

Entering Characters

Many of the menu screens have fields where you need to enter information such as names and addresses. To enter this information you need to use the keys on the keypad. Each key represents a set of letters.

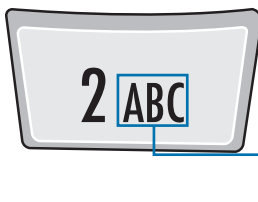

For Example: Use the number 2 key for letters A, B, and C.

- Press 1 time for A
- Press 2 times for B
- Press 3 times for C

Note: Press the **# key** to toggle between caps, lowercase, first letter capitalization, and digits. The mode currently selected is displayed in the top left corner of the screen; the modes are indicated as **ABC**, **abc**, **Abc**, **123**.

Keypad Guide

Key	Available Characters
1	. (period) /1
2	A/B/C/2
3	D/E/F/3
4	G/H/I/4
5	J/K/L/5
6	M/N/O/6
7	P/Q/R/S/7
8	T/U/V/8
9	W/X/Y/Z/9
0	_ (space)
*	next character
#	shift up
Right Soft Key	backspace / exit

Entering Punctuation

Pressing * (**star**) key takes you to a symbols menu with a list of the most commonly used punctuation marks and symbols.

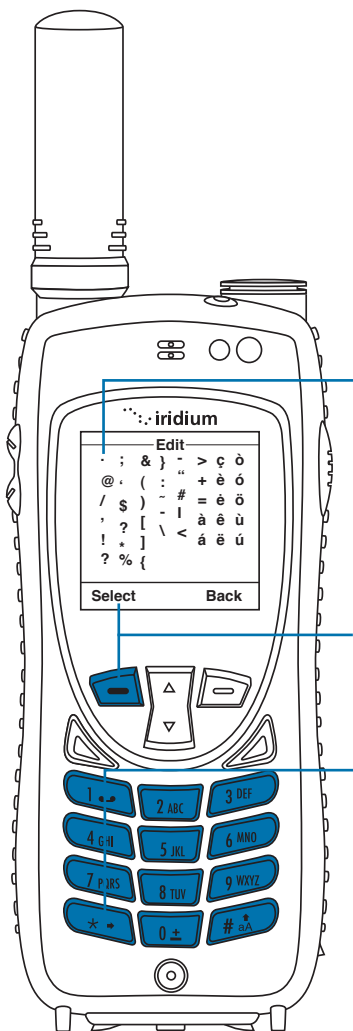

Using the **2-way Navi key**, cycle through the screen until you reach the desired symbol.

Press the **Left Soft Key** labeled **Select**.

Press the **Star** key to open the symbols menu.

Entering Numbers and Symbols into Text

There may be times when you need to add numbers into a message that you are writing. For example, to send someone a phone number as part of a text message.

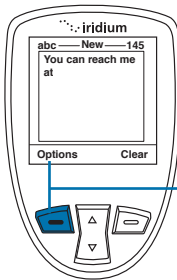

Starting from a text entry field:

1. Press the **left soft key** labeled **Options**.

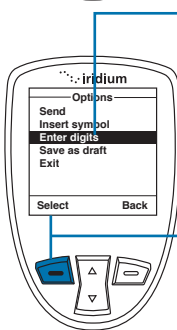

2. The **Options** screen appears. Using the **2-way Navi-key** scroll until **Enter digits** is highlighted.

3. Press the **left soft key** labeled **Select**.

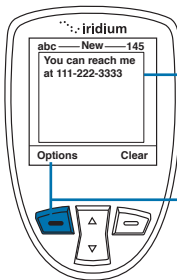

4. The original text now appears, but you are in the number entry mode.

5. Press the **left soft key** labeled **Options**.

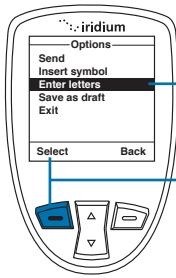

6. The **Options** screen appears. Using the **2-way Navi-key** scroll until **Enter letters** is highlighted.
7. Press the **left soft key** labeled **Options**.

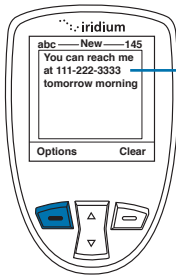

8. The original text screen now appears and you can continue to enter text in the letter entry mode.

Note: Use this same procedure for entering symbols into text by choosing **Insert** symbol in the **Options** menu. You can also press the *** key** as a shortcut for accessing the symbol menu (see “Entering Punctuation” on page 53).

7: Predictive Text Entry

Predictive text is implemented on the Iridium Extreme™ and affects the following areas:

- Creating an SMS/Email
- Adding Notes to an existing Phonebook entry
- Entering the Name field for a Phonebook entry (LetterWise only)

Predictive text is not set on a new phone by default, it must be enabled. To do so, start at the main screen and:

1. Press the Menu softkey
2. Select "Setup" (6 clicks down)
3. In the Setup menu, select "Language" (4 clicks down)
4. In the Language menu, select "Text entry"

In the Text entry menu, Multi-tap is the default selection. Multi-tap has no language sensitivity, other than the fact that it provides standard Western characters. To choose predictive text, select one of:

- English
- Français
- Español

Once you have made this change, all SMS entry and entry of contacts incorporate Predictive Text capabilities specific to the selected language. Once selected, select the "Back" option twice, then scroll up to "Messages" to use Predictive Text entry for messaging. To change back to "Multi-Tap" in the future, you need to adjust this setting.

Predictive text entry has the following modes:

- WordWise (Ww) which provides word prediction for users who like dictionary-based methods
- LetterWise (Lw) for letter-by-letter prediction for situations where word-based prediction doesn't afford the flexibility that may be required in some situations.

Special character entry has the following modes:

- Punctuation (#?@) for entry of punctuation and special symbols
- Digit (123) for entry of numbers

For all alphabetic languages:

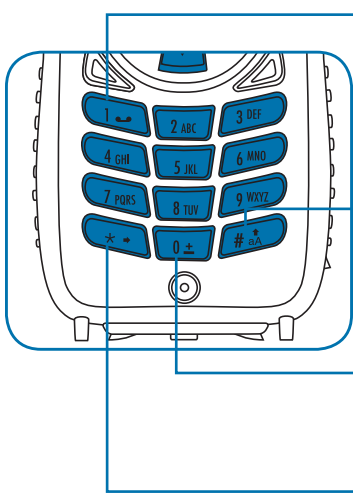

The **1 key** can be used for entering punctuation, however for full and efficient punctuation entry you can switch to **Punctuation mode (123)**.

Pressing the **Pound key (#)** switches between lower and upper case, indicated by the (↑) symbol. This is the **Shift key**.

Pressing the **Zero key (0)** enters a space, indicated by the (↵) symbol. This is the **Space key**.

Pressing the **Asterisk key (*)** enters the next word or letter, indicated by the (→) symbol. This is the **Next key**.

To complete a message, you may need to switch between these four main modes of text entry during message creation:

- WordWise (Ww) - word predictive text entry
- LetterWise (Lw) - letter-by-letter predictive text entry
- Numbers (123) - number entry (non-predictive)
- Punctuation (#?@) - punctuation entry (non-predictive)

The appropriate text entry mode can be selected by pressing the Convenience key on the side of the Iridium Extreme™. The active text entry mode will be displayed on the screen as indicated in the illustrations on the following page.

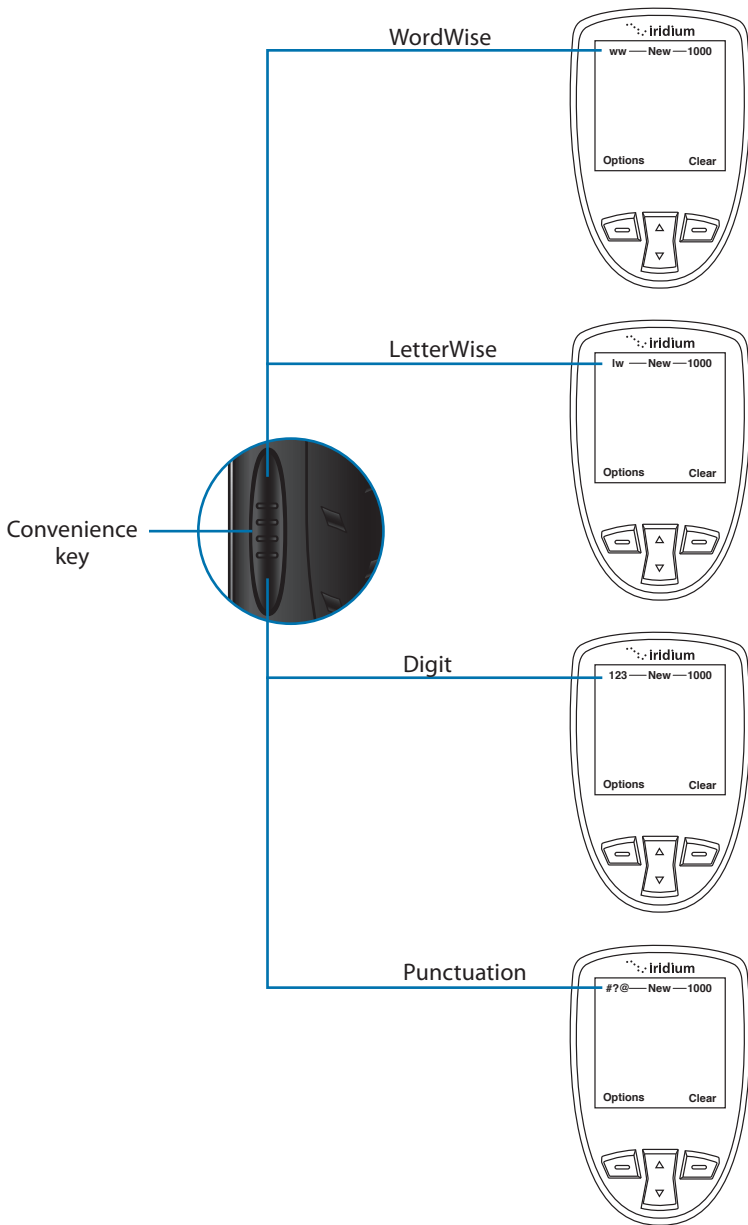

LetterWise Text mode

Press the **Convenience key** until you are in LetterWise (Lw) text mode. Press the key with the desired letter. If it doesn't appear, press the **Next key** (→) until it does. Use the **Right Soft key** (Clear) for backspace and **Space key** (↵) for space. Press the **Shift key** (↑) to switch between lower and upper case.

Note: Apostrophe (') for English entry and hyphen (-) for Russian entry are treated as letters (that is, can be predicted by LetterWise) and are found on **key 5**.

Example: Entering "don't"

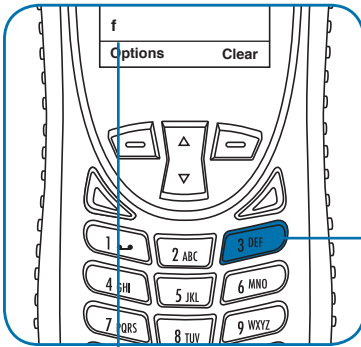

1. Press **key 3**.

Desired letter did not come up.

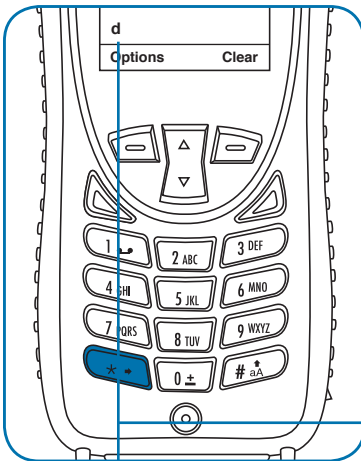

2. Press **Next key** (→) for desired letter. Proceed to next letter of the word.

Desired letter appears.

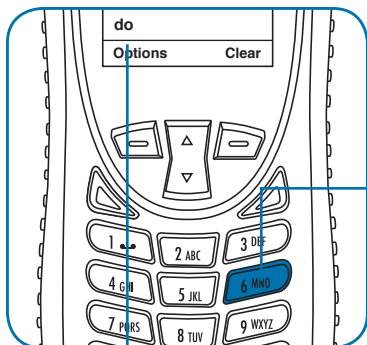

3. Press **key 6**.

Desired letter appears.

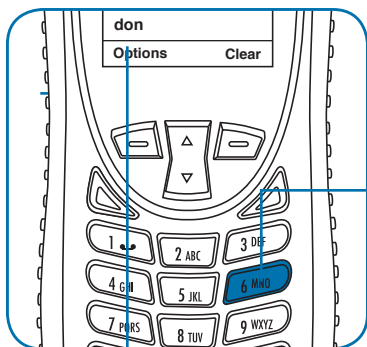

4. Press **key 6** again.

Desired letter appears.

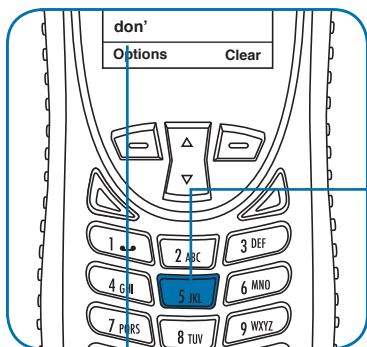

5. Press **key 5** for apostrophe.

Apostrophe is predicted along with letters in English.

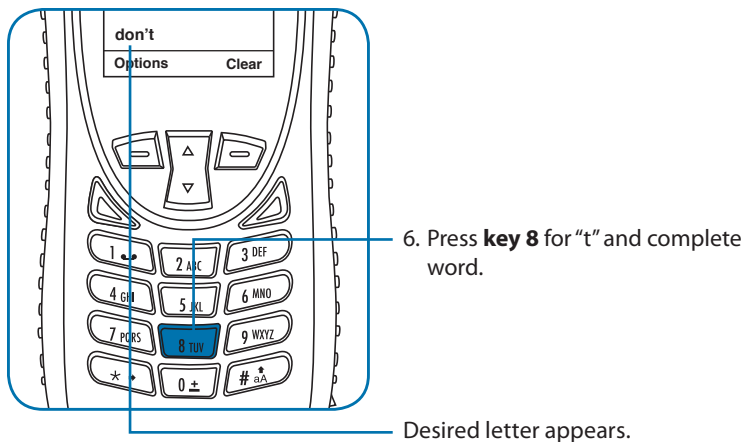

WordWise Text mode

Press the **Convenience key** until the “ww” symbol appears in the top left corner of the screen indicating that you have entered WordWise text entry mode. To enter text in WordWise, press the key containing the first letter you want to type **ONLY ONCE**.

If the correct letter does not appear at first, continue by pressing the key that corresponds to the next letter in your text, and so on.

After pressing the last key in the sequence, the word should appear. However, if the word is underlined (or highlighted), it is possible that an alternate word (which happens to require the same key presses) appeared instead. Just press Next key (→) until the desired word appears.

If the word you are entering is not found in any dictionary you can switch to LetterWise mode by pressing the convenience key and viewing the top left corner of the screen.

During use of WordWise, the 1 key can be used to insert punctuation without changing text entry modes. To insert punctuation, press the **1 key** and then add the appropriate punctuation by using the Next key (→). As an alternative, you may also use the **left option key** either “Insert symbol” or “Enter digits” during WordWise use. This also applies to LetterWise use.

Example: Entering "red"

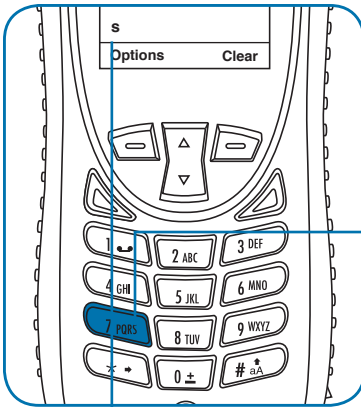

1. Press **key 7**.

Even if the correct letter "r" has not appeared, proceed with the next letter in the word.

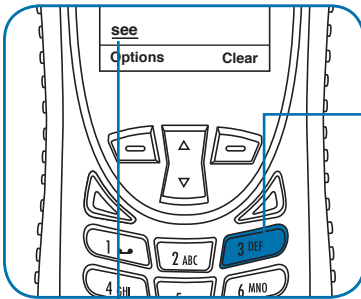

2. Press **key 3** twice for the next two letters "c & d".

The word "see" comes up which is more common than "red". The underline indicates there are other words to choose from.

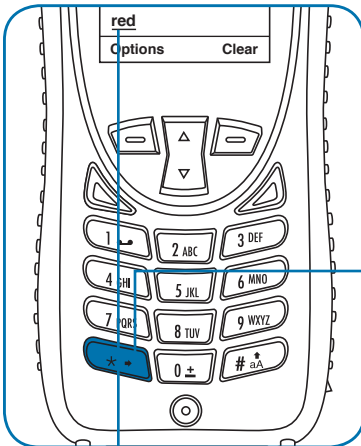

3. Press **Next Key** (→).

The word "red" appears.

Digit mode (123)

There may be times when you need to add numbers into a message that you are composing. Digit mode allows you to use the number keys to enter digits, similar to dialing a phone call. To enter digit mode, press the **Convenience key** until the **123 indicator** appears on the upper left corner of the screen. Enter the numbers required for your message and then use the **Convenience key** to return to the desired text entry mode to complete the rest of the message.

Digit mode may be entered either by pressing the **Convenience key** on the side of the phone, or with the **Options** menu in the **Create Message editor** to "Enter digits". During use of WordWise, the **1 key** can be used to insert punctuation without changing text entry modes.

Punctuation mode (#?@)

Punctuation mode may be entered either by pressing the **Convenience key** on the side of the phone, or with the **Options** menu in the **Create Message editor** to "Insert symbol". During use of WordWise, the **1 key** can be used to insert punctuation without changing text entry modes.

In Punctuation mode, symbols are spread across all keys based on their shape to help you remember which symbol is on each key (see table on following page). For example: ! is on 1 key, ? is on key 2

If there is more than one symbol on a key, press the **Next key** (→) to get the others.

Key	English/French/Russian/Spanish*
0	. , @ °
1	!
2	?
3	% \$ € £
4	_ ~
5	- + = " ^
6	([{ <
7	/ \
8	:: &
9)] } >

* Spanish includes inverted versions of ! and ?.

Once you have selected the appropriate symbol for your message, you may return to your preferred text entry mode by pressing the side convenience key and viewing the top left corner of the screen.

8: Using the Phonebooks

Organizing My Phonebook

Your satellite phone has two primary phonebooks: My Phonebook and SIM Phonebook.

My Phonebook can store up to 100 names and numbers and is completely editable by you. This information is stored directly on your phone. The SIM Phonebook is provided to you by your service provider and/or organization. The entries for the SIM Phonebook are stored directly on the SIM card used with your phone and you cannot create them or edit them from your phone.

	Phone Memory	SIM Card Memory
Personal Numbers	100 entries	155 entries
Fixed Dial Numbers	No entries	40 entries
Phone Number Digits	24	20
Name Characters	24	16

Note: SIM card capacity varies depending upon the card issued by your service provider.

Locating My Phonebook

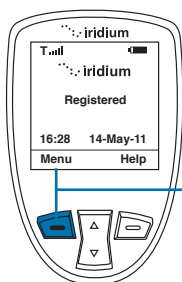

Starting from the Main Screen:

1. Press the **left soft key**, labeled **Menu**.

Note: All instructions for My Phonebook start from the **Main Menu** as shown.

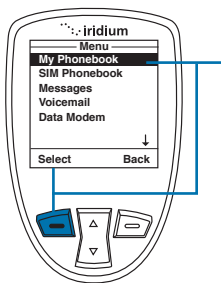

2. The **Main Menu** is now displayed, with **My Phonebook** highlighted press the **left soft key**, labeled **Select** to enter the **Phonebook menu**.

Note: To open the **SIM Phonebook**, use the **2-way Navi-key** to scroll until the **SIM Phonebook** is highlighted.

About the My Phonebook Menu

You can do the following functions using the **Phonebook** menu:

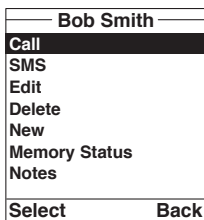

- Call an entry
- Create and send a text message (SMS).
- Edit an entry
- Delete an entry
- Add an entry
- Check the memory status of your Phonebook
- Add notes regarding entries

Add a New Entry to My Phonebook

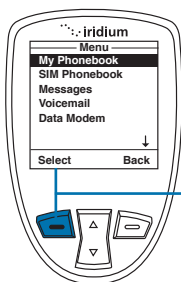

To add information to the Phonebook, use the **New** option. Start at the **Main Menu**, with **My Phonebook** highlighted:

1. Press the **left soft key**, labeled **Select**.

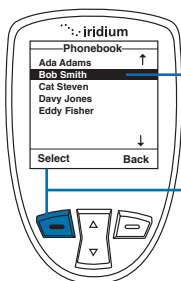

2. The **Phonebook** is displayed.

3. Press the **left soft key**, labeled **Options**.

Note: If there are no entries Empty will be displayed on this screen. If entries are present press the **left soft key** while highlighting any contact.

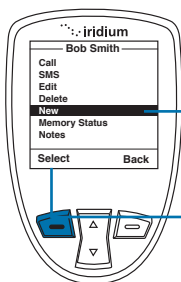

4. Use the **2-way Navi-key** until the **New** option is highlighted.

5. Press the **left soft key**, labeled **Select** to proceed.

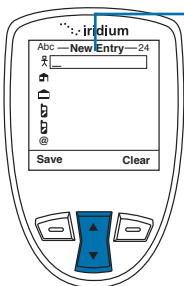

6. The **New Entry** screen is displayed with a list of icons that represent:



Name



Home phone



Work phone



1st cell phone



2nd cell phone



email address

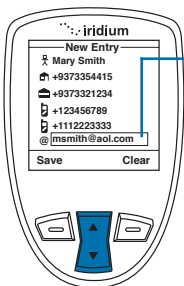

7. Use the **2-way Navi-key** to scroll to each field and the keypad to enter information into the fields.

Note: While entering or editing contact information the side volume keys allow you to move backwards and forwards without deleting.

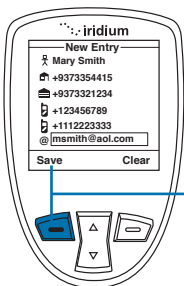

8. Press the **left soft key**, labeled **Save**.

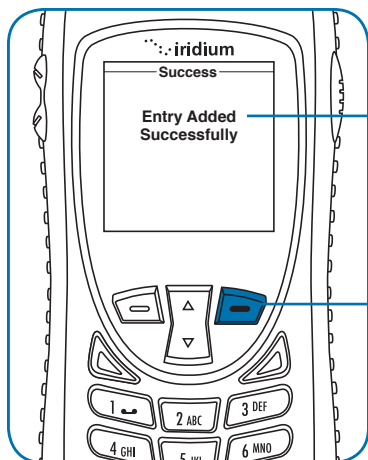

9. A message briefly appears to indicate the contact was entered successfully. The screen reverts to the main **Phonebook** menu.

Press the **red key** to return to the **Main Screen**.

Locating Entries

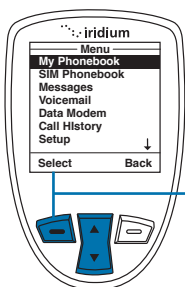

Starting at the Main Menu, using the **2-way Navi-key**, highlight the Phonebook you want to use.

1. Press the **left soft key**, labeled **Select**.

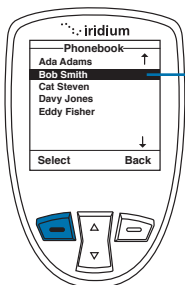

2. The **Phonebook** entries are now displayed in alphabetical order.

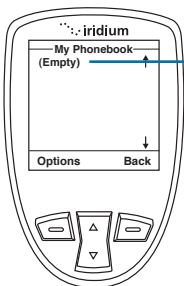

3. If there are no entries **Empty** is displayed. See “Add a New Entry to My Phonebook” on page 69.

Calling an Entry

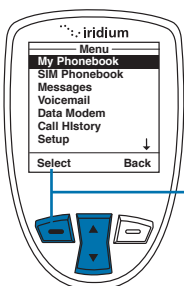

Starting at the Main Menu, using the **2-way Navi-key**, highlight the Phonebook you want to use.

1. Press the **left soft key**, labeled **Select**.

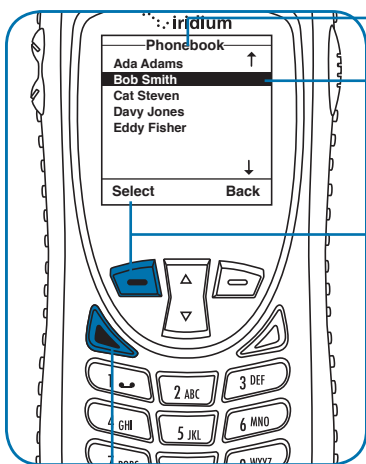

2. The **Phonebook** is displayed.

Use the **2-way Navi-key** to scroll until the desired entry is located.

3. With the entry highlighted, press the **left soft key** labeled **Options**.

Note: You can also press the green key as a short-cut to calling an entry.

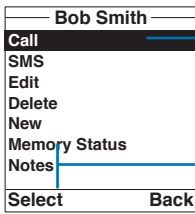

4. The **Phonebook** options are displayed.

5. With the **Call** option highlighted, press the **left soft key** labeled **Select**.

Note: If an entry has more than one number, for example, Home, Work and Mobile, then all numbers are displayed. Using the **2-way Navi-key**, highlight the number to be called and press **Select**.

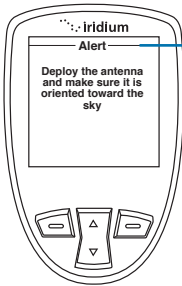

Note: If your antenna is not extended you receive an alert message telling you to extend the antenna.



6. **Calling** followed by the number you dialed is displayed. The call is then connected.

Using the Short Message Service (SMS) Menu

The Short Message Service (SMS) is a text messaging system.

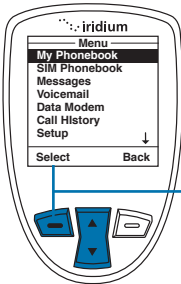

To send a text message Start at the **Main Menu**, using the **2-way Navi-key**, highlight the **Phonebook** you want to use.

1. Press the **left soft key**, labeled **Select**.

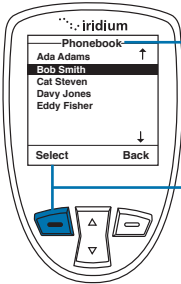

2. The **Phonebook** is displayed. Use the **2-way Navi-key** to scroll until the desired entry is located.

3. Press the **left soft key**, labeled **Options**.

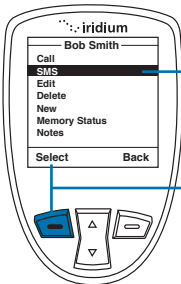

4. Use the **2-way Navi-key** until **SMS** is highlighted.

5. Press the **left soft key**, labeled **Select**.

Note: If an entry has more than one number, for example, Home, Work and Mobile, then all numbers are displayed. Using the **2-way Navi-key**, highlight the number to be called and press **Select**.

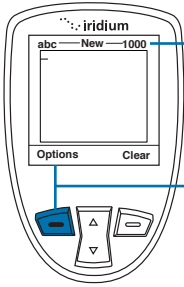

6. The **SMS** Screen now appears. You can enter up to 1,000 characters.

7. Press the **left soft key**, labeled **Options**.

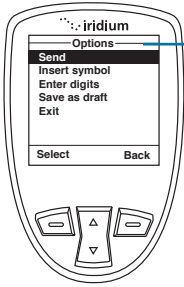

8. The **SMS Options menu** appears. From here you can:

- Send a SMS message
- Insert symbols into your message
- Enter digits
- Save as a draft to send later
- Exit the menu

Sending an SMS Message

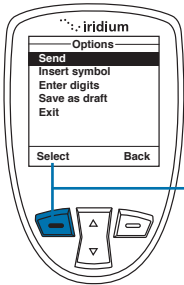

Starting at the **SMS Options Menu**:

1. While **Send** is highlighted press the **left soft key**, labeled **Select**.

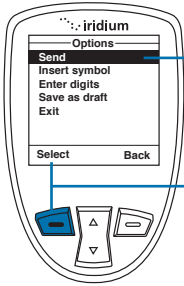

2. A **Send To** screen appears with the entry name and number.

3. Press the **left soft key**, labeled **Send**.

Note: At this time you may elect to send the message to additional recipients by highlighting **New Recipient** and pressing the **right soft key**, labeled **Add**.

Note: At this time you may elect to send the message to additional recipients by highlighting **New Recipient** and pressing the **right soft key**, labeled **Add**.

Adding an SMS Message

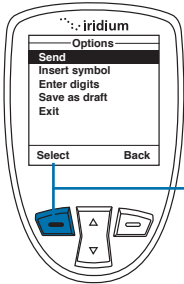

Starting at the **SMS Options** menu:

1. While **Send** is highlighted press the **left soft key**, labeled **Select**.

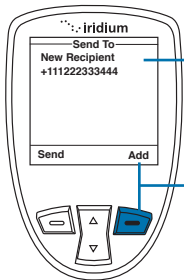

2. A **Send To** screen appears with **New Recipient** and the entry number.

3. Press the **right soft key**, labeled **Add**.

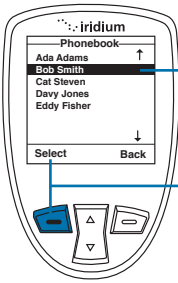

4. A list of contacts now appears. Use the **2-way Navi-key** to scroll to the desired recipient.
5. Press the **left soft key** labeled **Select**, the contact is then added to your recipient list.

Note: Repeat this procedure if you want to send the same message to more than one contact at a time.

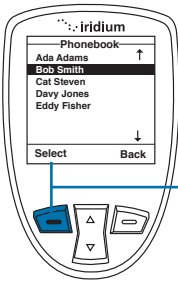

6. Once you are satisfied with the recipient(s) press **left soft key**, labeled **Send**.

Edit an Entry in My Phonebook

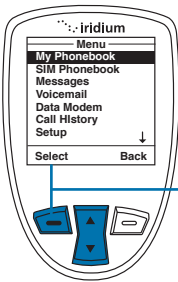

To change information in the Phonebook, use the Edit Option. Starting at the **Main Menu**, with **My Phonebook** highlighted:

1. Press the **left soft key**, labeled **Select**.

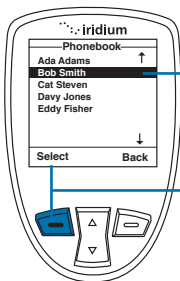

2. The Phonebook is displayed. Use the **2-way Navi-key** to scroll until the desired entry is highlighted.

3. Press the **left soft key**, labeled **Options**.

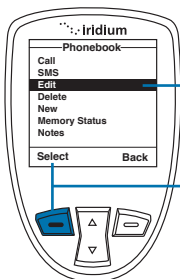

4. Use the **2-way Navi-key** until the **Edit** option is highlighted.

5. Press the **left soft key**, labeled **Select** to proceed.



6. The Edit Screen appears. Edit the entry as needed using the **2-way Navi-key** to scroll to the required field(s). Use the **side volume keys** to navigate backwards (up key) and forwards (down key) without deleting and the **right soft key**, labeled **Clear** to delete characters. Use the keypad to enter new characters.

7. Press the **left soft key**, labeled **Save**.

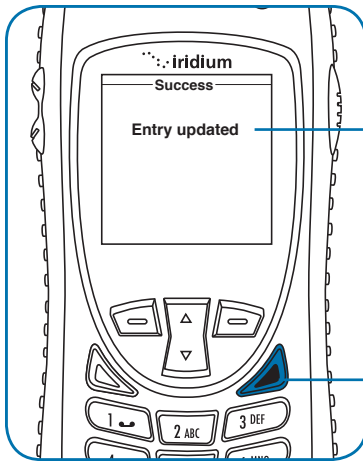

8. A message briefly appears to indicate the entry was updated. The screen then returns to the main Phonebook menu.

9. Press the **red key** to return to the **Main Screen**.

Delete an Entry

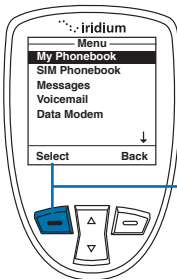

To remove an entry in the Phonebook, use the **Delete** option. Start at the **Main Menu**:

1. Press the **left soft key**, labeled **Select**.

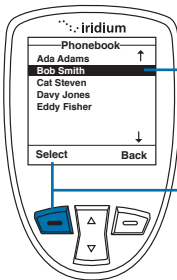

2. The Phonebook is displayed. Use the **2-way Navi-key** to scroll until the desired entry is highlighted.

3. Press the **left soft key**, labeled **Options**.

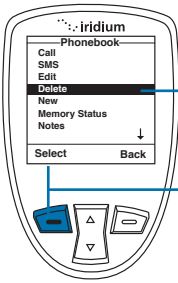

4. Use the **2-way Navi-key** until the **Delete** option is highlighted.
5. Press the **left soft key**, labeled **Select** to proceed.

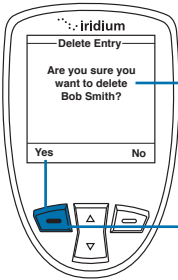

6. You receive a message asking if you want to delete the entry. Press the **left soft key**, labeled **Yes**. If you press **No**, the screen reverts to the previous menu.

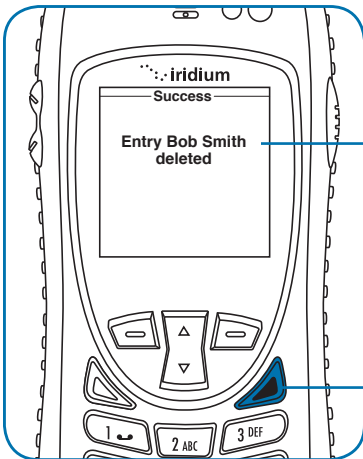

7. A message briefly appears to indicate the entry was deleted. The main Phonebook menu then appears.
8. Press the **red key** to return to the **Main Screen**.

Viewing Memory Status

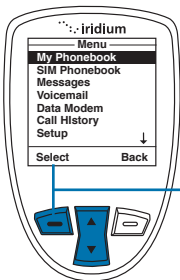

Use this capability to see how many Phonebook memory locations are available in the SIM card memory and phone memory. Start at the **Main Menu**:

1. Press the **left soft key**, labeled **Select**.

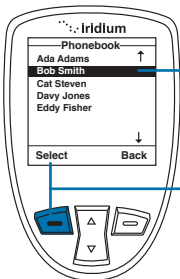

2. The Phonebook is displayed. Use the **2-way Navi-key** to scroll until the desired entry is highlighted.

3. Press the **left soft key**, labeled **Options**.

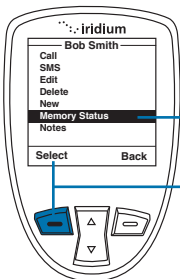

4. Use the **2-way Navi-key** until **Memory Status** is highlighted.

5. Press the **left soft key**, labeled **Select** to proceed.

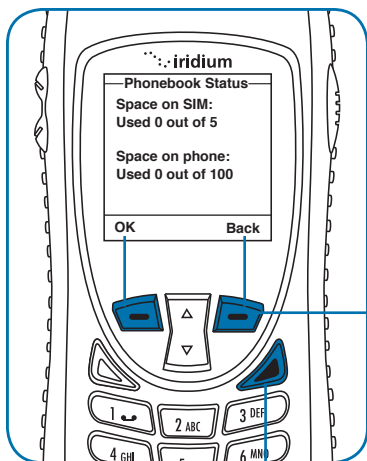

6. The **Phonebook Status** is displayed, showing the space on the SIM and the phone memory.

7. Press the **left soft key**, labeled **OK** or the **right soft key** labeled **Back** to return to the previous screen.

Press the **red key** to return to the **Main Screen**.

Adding Notes to a Phonebook Entry

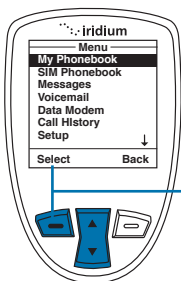

Use this capability to add information regarding an entry.

Start at the **Main Menu**:

1. Press the **left soft key**, labeled **Select**.

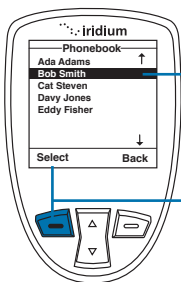

2. The Phonebook is displayed. Use the **2-way Navi-key** to scroll until the desired entry is highlighted.

3. Press the **left soft key**, labeled **Options**.

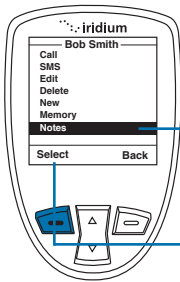

4. Use the **2-way Navi-key** until **Notes** is highlighted.

5. Press the **left soft key**, labeled **Select** to proceed.

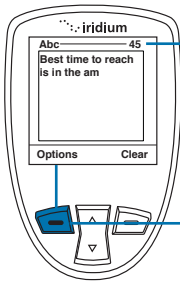

6. A text screen appears. Use the **Keypad** to enter your text.

Note: you can enter up to 64 characters. The character count in the top right corner counts down as you enter text.

7. Press the left soft key, labeled **Options**.

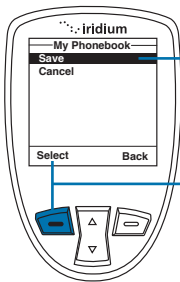

8. A **My Phonebook** screen appears with **Save** highlighted.

9. Press the **left soft key**, labeled **Options**.

Note: The text you entered is now stored in the Note option for this entry.

Restricted Phonebook

When the Phonebook is restricted, My Phonebook and SIM Phonebook do not appear. The main menu displays Fixed Phonebook only. The Fixed Phonebook cannot be edited.

9: Using the Messages Menu

Locating the Messages Menu

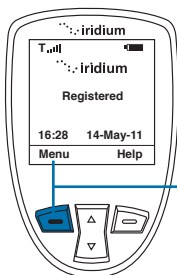

Starting from the Main Screen:

1. Press the **left soft key**, labeled **Menu**.

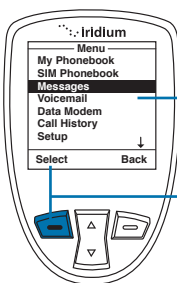

2. The **Main Menu** is displayed. Use the **2-way Navi-key** to scroll until **Messages** is highlighted.

3. Press the **left soft key**, labeled **Select**.

Note: All instructions for the **Messages** menu start from the **Main Menu** as shown.

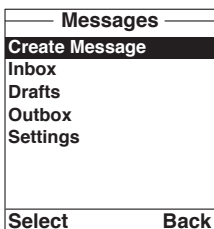

You can perform the following functions using the Messages menu:

- Create messages
- Read, reply, delete, call and forward messages
- Edit stored messages and send
- Enter service center number, set expiry period and enable or disable delivery reports.

Create and Send a new SMS Message to an Email Address not in your Phonebook

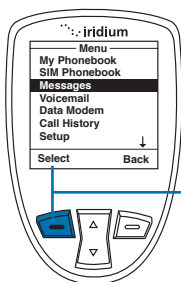

Start at the **Main Menu** with **Messages** highlighted:

1. Press the **left soft key**, labeled **Select**.

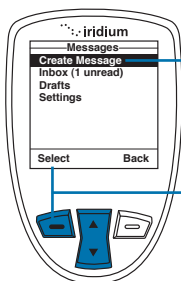

2. The **Create Message** option should be selected. If not then use the **2-way Navi-key** to scroll until it is highlighted.
3. Press the **left soft key**, labeled **Select**.

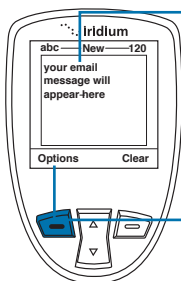

4. Enter your message.

Note: You must begin your text message with the recipients email address, leaving a space between the email address and the beginning of your message.

When your message is complete, press the **left soft key**, labeled **Options**.

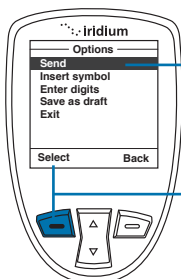

5. The **Send** option should be highlighted. If not then use the **2-way Navi-key** to scroll until it is highlighted.
6. Press the **left soft key**, labeled **Select** to send the message.

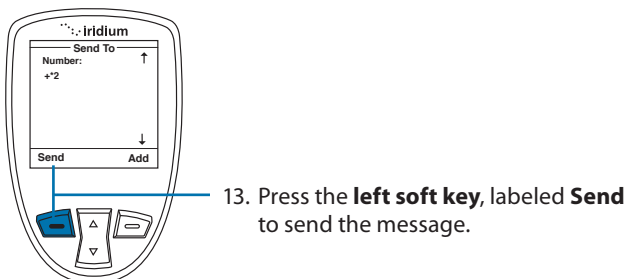
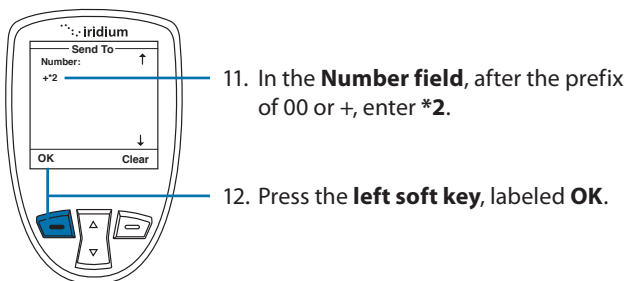
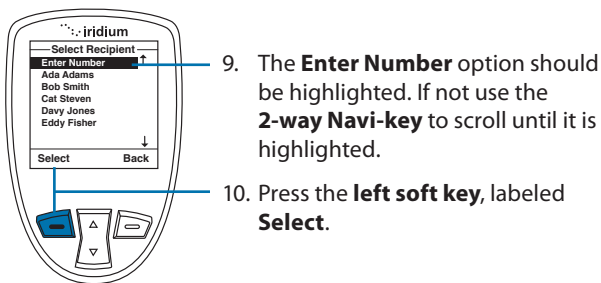
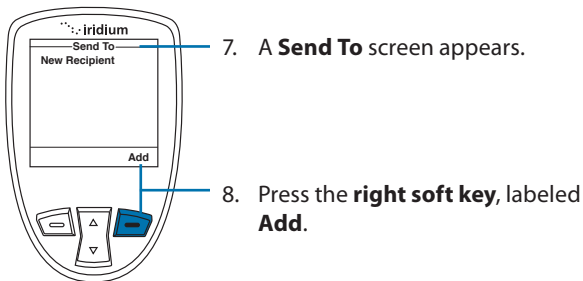

Create and Send a new SMS Message to an Email Address in My Phonebook

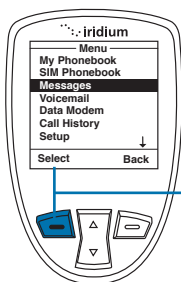

Start at the **Main Menu** with **Messages** highlighted:

1. Press the **left soft key**, labeled **Select**.

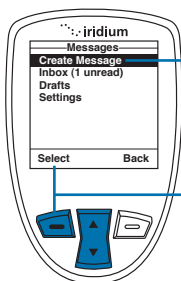

2. The **Create Message** option should be selected. If not then use the **2-way Navi-key** to scroll until it is highlighted.

3. Press the **left soft key**, labeled **Select**.

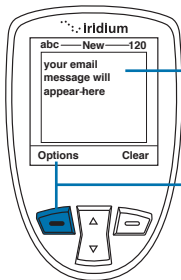

4. Enter your message.

5. When your message is complete, press the **left soft key**, labeled **Options**.

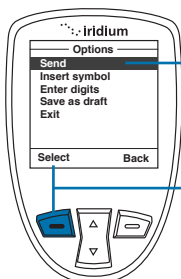

6. The **Send** option should be highlighted. If not then use the **2-way Navi-key** to scroll until it is highlighted.

7. Press the **left soft key**, labeled **Select** to send the message.

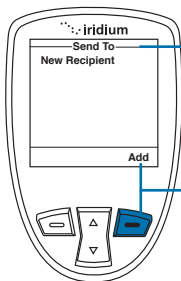

8. A **Send To** screen appears.

9. Press the **right soft key**, labeled **Add**.

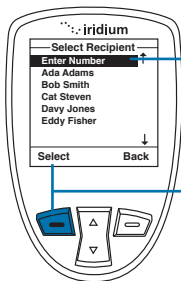

10. Use the **2-way Navi-key** to highlight your selection.

11. Press the **left soft key**, labeled **Select**.

Note: If the Contact's email address is the only information listed, the screen returns you to the **Send To** screen.

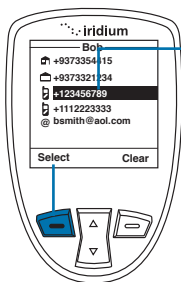

12. If the Contact has an email address as well as a phone number listed, you are presented with their phonebook entry. Use the **2-way Navi-key** to highlight their email address and press the **left soft key**, labeled **Select**.

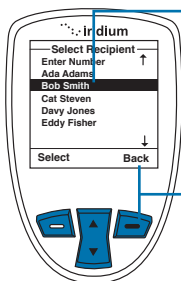

13. The **Phonebook** screen appears with the recipient's name highlighted. To add another recipient, use the **2-way Navi-key** to highlight the next recipient and repeat step 10.

14. Once all recipients have been selected, press the **right soft key**, labeled **Back**.

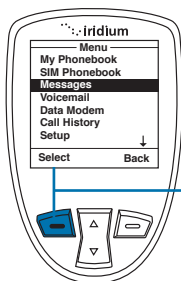

15. Press the **left soft key**, labeled **Send**.

About SMS Messaging

Message Notification

If your phone is powered ON, it notifies you of received messages in the following ways:

- An alert sounds and/or the phone vibrates.
- The message indicator is displayed
- The message **New SMS. Read Now?** is displayed.

How Messages are Stored

Your phone stores all messages on the SIM card. If the message indicator is flashing, your SIM card is full. See “Delete a Message” on page 102 to make room for the new message.

What Messages Contain

You can receive short text or numeric messages in your Personal Mailbox. Text messages may contain up to 1,000 characters. Numeric messages, typically phone numbers, may contain up to 20 digits.

Standard SMS messages are up to 160 characters. Long SMS messages up to 1000 characters are divided into smaller 160 character messages and may be billed at the standard 160 character SMS rate. For example, an SMS message with 320 characters may be billed as two standard SMS messages. Contact your service provider for additional information.

Your personal mailbox works with Call Forwarding. For more information see “Forward a Received Message” on page 99.

Using the Inbox Menu

You can do the following functions using the **Inbox** menu:

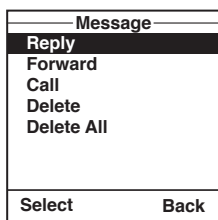

- Reply to a message
- Forward a message
- Call the number that left the message
- Delete one or all messages

Note: If the message storage space on your SIM card is full, you cannot store a message for later retrieval. See “Delete a Message” on page 96 to make room for new messages on your SIM card.

Read a Message

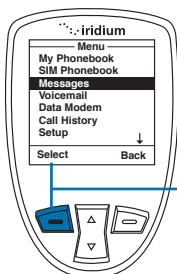

Start at the **Main Menu** with **Messages** highlighted:

1. Press the **left soft key**, labeled **Select**.

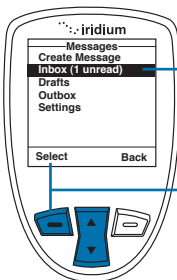

2. Use the **2-way Navi-key** to scroll until **Inbox** is highlighted.

3. Press the **left soft key**, labeled **Select**.

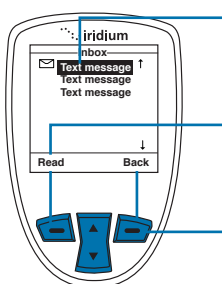

4. Use the **2-way Navi-key** to highlight a message.
5. Press the **left soft key**, labeled **Read** to view the selected message.
6. Press the **right soft key**, labeled **Back** to return to the previous menu.

Reply to Sender

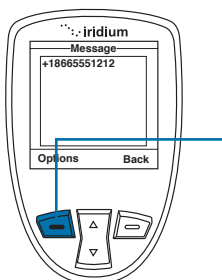

While reading the Message Screen:

1. Press the **left soft key**, labeled **Options**.

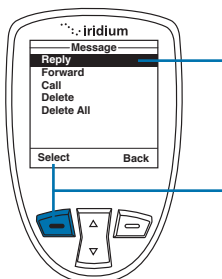

2. Use the **2-way Navi-key** to scroll until **Reply** is highlighted.
3. Press the **left soft key**, labeled **Select**.

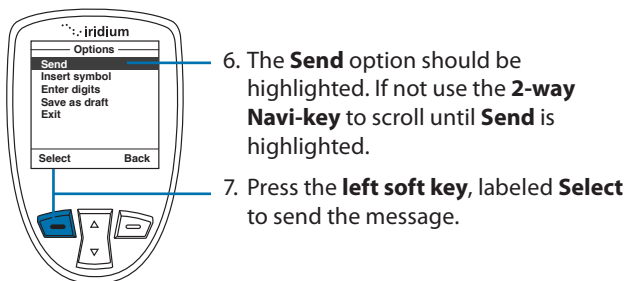
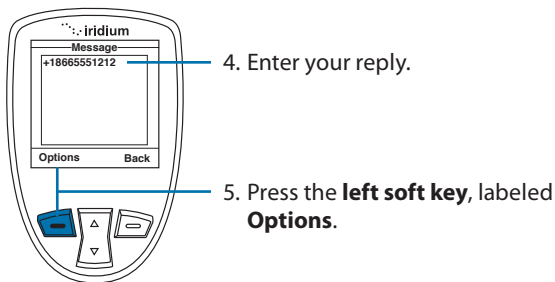

Note: If the sender's phone number is not part of your phonebook, select New Recipient to add the number.

Forward a Received Message

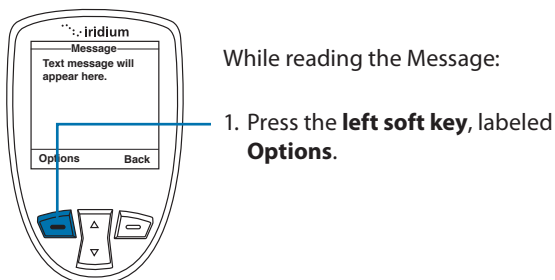

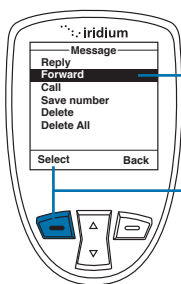

2. Use the **2-way Navi-key** to scroll until **Forward** is highlighted.

3. Press the **left soft key**, labeled **Select**.

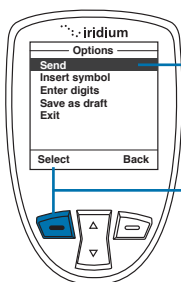

4. The **Send** option should be highlighted. If not use the **2-way Navi-key** to scroll until **Send** is highlighted.

5. Press the **left soft key**, labeled **Select** to send the message.

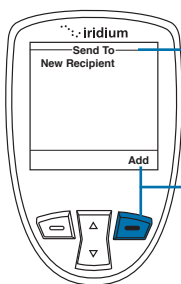

6. A **Send To** screen appears.

7. Press the **right soft key**, labeled **Add**.

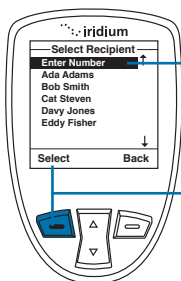

8. Use the **2-way Navi-key** until the desired recipient from your phonebook is highlighted.

9. Press the **left soft key**, labeled **Options**.

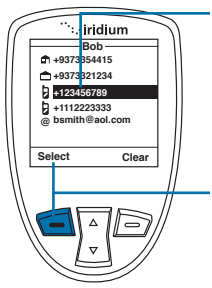

- 10. If the recipient has more than one number listed, the recipient's information screen appears. Use the **2-way Navi-key** to scroll to the number you would like to forward to.
- 11. Press the **left soft key**, labeled **Select**. The number is added to a recipient list.

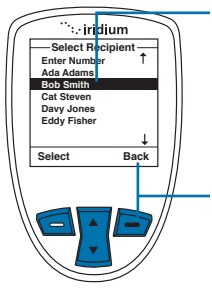

- 12. The **Phonebook** screen appears with the recipient's name highlighted. To add another recipient, use the **2-way Navi-key**, highlight the next recipient and repeat step 8.
- 13. Once all recipients have been selected, press the **right soft key**, labeled **Back**.

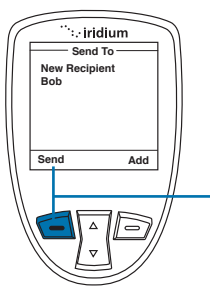

- 14. Press the **left soft key**, labeled **Send**.

Call a Number from a Received Message

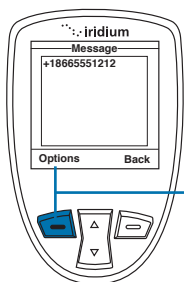

While reading the Message Screen:

1. Press the **left soft key**, labeled **Options**.

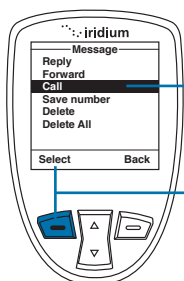

2. Use the **2-way Navi-key** to scroll until **Call** is highlighted.
3. Press the **left soft key**, labeled **Select**.

Delete a Message

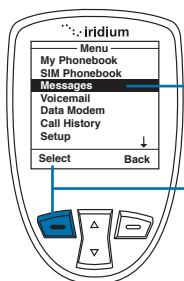

Start at the **Main Menu** with **Messages** highlighted:

1. Press the **left soft key**, labeled **Select**.

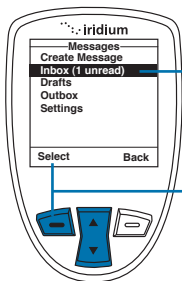

2. Use the **2-way Navi-key** to scroll until **Inbox** is highlighted.

3. Press the **left soft key**, labeled **Select**.

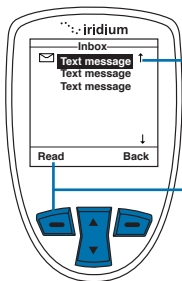

4. Use the **2-way Navi-key** to scroll to the message.

5. Press the **left soft key**, labeled **Read** to view the selected message.

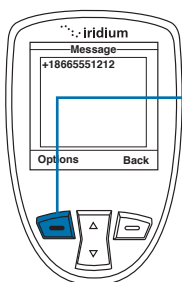

6. Press the **left soft key**, labeled **Options**.

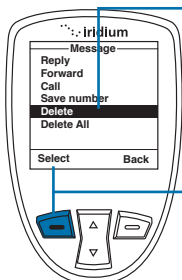

7. Use the **2-way Navi-key** to scroll until **Delete** is highlighted. To delete all messages highlight **Delete All**.

8. Press the **left soft key**, labeled **Select**.

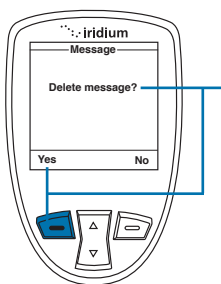

- The Satellite Phone prompts you to ensure you want to proceed. Press the **left soft key**, labeled **Yes** to delete the message.

The screen flashes **Message Deleted**, and automatically returns to the Message mailbox.

Using the Drafts Menu

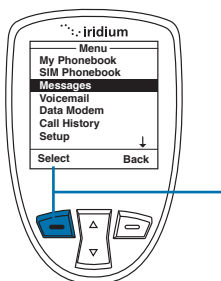

To edit and send a stored message, use the **Draft menu**. Start at the **Main Menu** with **Messages** highlighted:

- Press the **left soft key**, labeled **Select**.

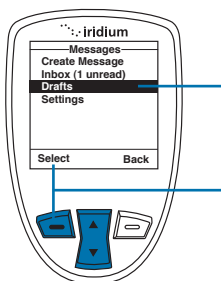

- Use the **2-way Navi-key** to scroll until the **Drafts** option is highlighted.
- Press the **left soft key**, labeled **Select**.