



Knowledge to Shape Your Future

Natural Gas Solutions

100G Installation Guide for Direct Mounting on Meters

Revision B5

Putting knowledge to work.

Identification

for Direct Mounting on Meters

Part number: PUB-0200-001 Revision B5 11/08

ERT Part Numbers: ERG-5000-001, ERG-5002-001, ERG-5000-002, ERG-5002-002, ERG-5000-003, ERG-5002-003, ERG-5000-004, ERG-5002-004, ERG-5000-005, ERG-5000-007, ERG-5000-008

Copyright

© 2005 - 2008 Itron, Inc. All rights reserved.

Trademark Notice

Itron is a registered trademark of Itron, Inc.

All other product names and logos in this documentation are used for identification purposes only and may be trademarks or registered trademarks of their respective companies.

Suggestions

If you have comments or suggestions on how we may improve this documentation, send them to TechnicalCommunicationsManager@itron.com

If you have questions or comments about the software or hardware product, contact Itron Technical Support:

Contact

- Internet: www.itron.com
- E-mail: support@itron.com
- Phone: 1 800 635 8725

Applicable Patents

U.S. Patent Numbers: 4,614,945; 4,753,169; 4,768,903; 4,799,059; 4,867,700

Canadian Patent Numbers: 1,254,949; 1,267,936; 1,282,118

Compliance Statement

This device complies with Part 15 of the FCC Rules. Operation of this device is subject to the following two conditions:

- This device may not cause harmful interference.
- This device must accept any interference that may cause undesirable operation.

This device must be permanently mounted such that it retains a distance of 20 centimeters (7.9 inches) from all persons in order to comply with FCC RF exposure levels.

Compliance Statement

This equipment has been tested and found to comply with the limits, pursuant to Part 15 of the FCC Rules. These limits are designed to provide reasonable protection against harmful interference in a residential installation. Operation is subject to the following conditions:

- This device may not cause interference.
- This device must accept any interference that may cause undesired operation of the device.

Complies with IC: R.S.S.-210

Transportation Classification

The Federal Aviation Administration prohibits operating transmitters and receivers on all commercial aircraft. When powered, the 100G ERT Module is considered an operating transmitter and receiver and cannot be shipped by air. All product returns must be shipped by ground transportation.

Modification and Repairs

To ensure system performance, this device and antenna shall not be changed or modified without the expressed approval of Itron. Any unauthorized modification will void the user's authority to operate the equipment.



Warning Only authorized Itron personnel should attempt repairs on Itron equipment. Attempts to do so by others might void any maintenance contract with your company.



Warning

- Follow these procedures to avoid injury to yourself or others.
- The lithium battery may cause a fire or chemical burn if it is not disposed of properly.
- Do not recharge, disassemble, heat, or incinerate the lithium battery.
- Keep the lithium battery away from children.

Contents

Chapter 1 Introduction	1
Transmission Modes	1
Specifications	2
Meter Compatibility	2
Chapter 2 American Meter Installation.....	9
Installation Prerequisites	9
Materials Supplied By Itron	9
Materials Supplied By You	9
Replacement Screws	10
Preinstallation Preparations	10
Installing the 100G ERT Module	10
Remove the Index	10
Assemble the ERT Module	13
Program the ERT Module	18
Attach the ERT Module to the Meter	20
Chapter 3 Sensus Meter Installation	25
Installation Prerequisites	25
Materials Supplied By Itron	25
Materials Supplied By You	26
Replacement Screws	26
Preinstallation Preparations	26
Installing the 100G ERT Module	27
Remove the Index	27
Assemble the ERT Module	29
Program the ERT	31
Attach the ERT to the Meter	33
Chapter 4 Actaris Meter Installation.....	37
Installation Prerequisites	37
Materials Supplied By Itron	37
Materials Supplied By You	38
Replacement Screws	38
Preinstallation Preparations	38
Installing the 100G ERT Module	39
Remove the Index	39
Assemble the ERT Module	41
Program the ERT	43
Attach the 100G ERT Module to the Meter	45
Attaching the 100G ERT Module to Flat-faced Model 1A Meters.....	46

Chapter 5 National/Lancaster Meter Installation	51
Index Compatibility	51
Installation Prerequisites	51
Materials Supplied By Itron	51
Materials Supplied By You	52
Replacement Screws	52
Preinstallation Preparations	52
Installing the 100G ERT Module	53
Program the ERT	58
Chapter 6 American/Actaris Commercial Meter Installation	61
Installation Prerequisites	61
Materials Supplied by Itron	62
Materials Supplied By You	62
Replacement Screws	62
Preinstallation Preparations	62
Installing the 100G ERT Module	63
Program the ERT	67
Installing 100G ERT Module on Actaris	73
Installing 100G ERT Module on ROOTS Rotary	76
Chapter 7 Sensus Commercial Meter Installation	79
Installation Prerequisites	79
Materials Supplied by Itron	80
Materials Supplied By You	80
Replacement Screws	80
Preinstallation Preparations	80
Installing the 100G ERT Module	81
Program the ERT	82
Installing 100G ERT Module on ROOTS Rotary	87

CHAPTER 1

Introduction

The 100G is Itron's latest gas encoder-receiver-transmitter (ERT®) module.

ERT modules are radio-frequency (RF) devices that transmit meter data. The RF meter data can be received by a reading device that is within transmission distance of the ERT. Itron's 100G ERT module has increased output power over legacy gas ERT modules for increased RF transmission distance.

This guide covers 100G ERT Module installation on meters from a variety of manufacturers. Refer to the Meter Compatibility List to ensure you have a meter compatible with the 100G ERT Module. See the [Meter Compatibility List](#) on page 2.

Transmission Modes

Once installed, the 100G ERT module has three available transmission modes:

- **Fixed Network Mode** In this mode, a 100G ERT module transmits a high-powered RF message every 60 seconds. Output power in this mode is 250 milliwatts or +24dBm; expected battery life is 20 years.
- **Mobile and Handheld Mode** In this mode, a 100G ERT module transmits a medium-powered RF message every 15 seconds. Output power in this mode is 10 milliwatts or +10dBm; expected battery life is 20 years.
- **(Optional) Hard to Read Mobile and Handheld Mode** In this mode, a 100G ERT module transmits a high-powered RF message every 30 seconds. Output power in this mode is 250 milliwatts or +24dBm; expected battery life decreases to 15 years in this mode, however. The *Hard to Read Mobile and Handheld Mode* should only be used for 100G ERT modules that are difficult to read under normal conditions, such as modules installed on roof tops or in sub-basements.

An FCC license is not required to read 100G ERT modules.

Specifications

The functional and operational specifications for the 100G are listed below.

Functional Specifications	Description
Power Source	Two "A" cell lithium batteries
Tamper Detection	Tilt tamper and magnetic tamper
FCC Compliance	Part 15 certified
Industry Canada Compliance	RSS-210 certified
Intrinsically Safe per	UL Class I, Division 1, Groups C and D
Product Identification	Numeric and barcoded ERT module type and serial number
Construction Materials	Gray polycarbonate housing and back plate with encapsulated electronics

Operational Specifications	Description
Operating Temperatures	-40° to 158° F (-40° to +70° C)
Operating Humidity	5 to 95 percent relative humidity
Program Frequency	908 MHz
Transmit Frequency	Spread spectrum 908 to 924 MHz ISM band
Data Integrity	Verified in every data message

Meter Compatibility

The following meters are compatible with the 100G. Due to continuous research, product improvements, and enhancements, Itron reserves the right to change this list at any time.



NOTE On rare occasions the location of ERT-to-meter mounting holes on older diaphragm gas meters might not match up with the mounting holes on the 100G ERT Module. This can prevent the 100G ERT Module from properly mounting to the meter.

To ensure you have the latest Meter Compatibility list available, contact your Itron representative.

Mfg.	Model	Desc	Class	Comments	ERT Type	ERT Part No.
American/ Canadian	W75AL		Residential	Aluminum case meters only	100G 100G Datalogging	ERG-5000-001 ERG-5002-001
American/ Canadian	AL-175		Residential	Aluminum case meters only	100G 100G Datalogging	ERG-5000-001 ERG-5002-001
American/ Canadian	AC-175		Residential	Aluminum case meters only	100G 100G Datalogging	ERG-5000-001 ERG-5002-001
American/ Canadian	AT-175		Residential	Aluminum case meters only	100G 100G Datalogging	ERG-5000-001 ERG-5002-001
American/ Canadian	ALC-175		Residential	Aluminum case meters only	100G 100G Datalogging	ERG-5000-001 ERG-5002-001
American/ Canadian	AT-210		Residential	Aluminum case meters only	100G 100G Datalogging	ERG-5000-001 ERG-5002-001
American/ Canadian	AL-225	Canada only	Residential	Aluminum case meters only	100G 100G Datalogging	ERG-5000-001 ERG-5002-001
American/ Canadian	AL-250		Residential	Aluminum case meters only	100G 100G Datalogging	ERG-5000-001 ERG-5002-001
American/ Canadian	AR-250		Residential	Aluminum case meters only	100G 100G Datalogging	ERG-5000-001 ERG-5002-001
American/ Canadian	AC-250		Residential	Aluminum case meters only	100G 100G Datalogging	ERG-5000-001 ERG-5002-001
American/ Canadian	AT-250		Residential	Aluminum case meters only	100G 100G Datalogging	ERG-5000-001 ERG-5002-001
American/ Canadian	AM-250		Residential	Aluminum case meters only	100G 100G Datalogging	ERG-5000-001 ERG-5002-001
American/ Canadian	AL-310		Residential	Aluminum case meters only	100G 100G Datalogging	ERG-5000-001 ERG-5002-001
American/ Canadian	AL-350		Residential	Aluminum case meters only	100G 100G Datalogging	ERG-5000-001 ERG-5002-001
American/ Canadian	AT-350		Residential	Aluminum case meters only	100G 100G Datalogging	ERG-5000-001 ERG-5002-001
American/ Canadian	AL-425		Residential	Aluminum case meters only	100G 100G Datalogging	ERG-5000-001 ERG-5002-001
American/ Canadian	AC-630		Residential	Aluminum case meters only	100G 100G Datalogging	ERG-5000-001 ERG-5002-001
American/ Canadian	5B 225	Aluminum case	Residential		100G 100G Datalogging	ERG-5000-001 ERG-5002-001
American/ Canadian	35B	Iron case	Commercial		100G	ERG-5000-007
American/ Canadian	60B	Iron case	Commercial		100G	ERG-5000-007
American/ Canadian	80B	Iron case	Commercial	Must have front reading index.	100G	ERG-5000-007
American/ Canadian	250B	Iron case	Commercial		100G	ERG-5000-007

American/ Canadian	500B	Iron case	Commercial		100G	ERG-5000-007
American/ Canadian	AL800		Commercial	Aluminum case meters only	100G	ERG-5000-007
American/ Canadian	AL1000		Commercial	Aluminum case meters only	100G	ERG-5000-007
American/ Canadian	AL1400		Commercial	Aluminum case meters only	100G	ERG-5000-007
American/ Canadian	AL2300		Commercial	Aluminum case meters only	100G	ERG-5000-007
American/ Canadian	AL3000		Commercial	Aluminum case meters only	100G	ERG-5000-007
American/ Canadian	AL5000		Commercial	Aluminum case meters only	100G	ERG-5000-007
Sensus/Invensys/ Equimeter/Rockwell	R-175	11 Tooth	Residential	Compatible with 2 foot drive index; 1 foot drive has 24 teeth and is not compatible.	100G 100G Datalogging	ERG-5000-002 ERG-5002-002
Sensus/Invensys/ Equimeter/Rockwell	R-200	11 Tooth	Residential		100G 100G Datalogging	ERG-5000-002 ERG-5002-002
Sensus/Invensys/ Equimeter/Rockwell	RT-200	11 Tooth	Residential		100G 100G Datalogging	ERG-5000-002 ERG-5002-002
Sensus/Invensys/ Equimeter/Rockwell	RT-230	11 Tooth	Residential		100G 100G Datalogging	ERG-5000-002 ERG-5002-002
Sensus/Invensys/ Equimeter/Rockwell	R-275	11 Tooth	Residential		100G 100G Datalogging	ERG-5000-002 ERG-5002-002
Sensus/Invensys/ Equimeter/Rockwell	RT-275	11 Tooth	Residential		100G 100G Datalogging	ERG-5000-002 ERG-5002-002
Sensus/Invensys/ Equimeter/Rockwell	R-315	11 Tooth	Residential		100G 100G Datalogging	ERG-5000-002 ERG-5002-002
Sensus/Invensys/ Equimeter/Rockwell	250	11 Tooth	Residential		100G 100G Datalogging	ERG-5000-002 ERG-5002-002
Sensus/Invensys/ Equimeter/Rockwell	310	11 Tooth	Residential		100G 100G Datalogging	ERG-5000-002 ERG-5002-002
Sensus/Invensys/ Equimeter/Rockwell	S-110	11 Tooth	Residential		100G 100G Datalogging	ERG-5000-002 ERG-5002-002
Sensus/Invensys/ Equimeter/Rockwell	S-200	11 Tooth	Residential		100G 100G Datalogging	ERG-5000-002 ERG-5002-002
Sensus/Invensys/ Equimeter/Rockwell	S-175	18 Tooth	Residential		100G 100G Datalogging	ERG-5000-004 ERG-5002-004
Sensus/Invensys/ Equimeter/Rockwell	RT-100	18 Tooth	Residential	24- or 30-tooth gears are not compatible	100G 100G Datalogging	ERG-5000-004 ERG-5002-004
Sensus/Invensys/ Equimeter/Rockwell	S-190	18 Tooth	Residential		100G 100G Datalogging	ERG-5000-004 ERG-5002-004

Sensus/Invensys/ Equimeter/Rockwell	S-120	11 Tooth	Residential		100G 100G Datalogging	ERG-5000-002 ERG-5002-002
Sensus/Invensys/ Equimeter/Rockwell	T-120	11 Tooth	Residential		100G 100G Datalogging	ERG-5000-002 ERG-5002-002
Sensus/Invensys/ Equimeter/Rockwell	T-110	11 Tooth	Residential		100G 100G Datalogging	ERG-5000-002 ERG-5002-002
Sensus/Invensys/ Equimeter/Rockwell	R-415	18 Tooth	Residential	Older meters may have ERT-to-meter mounting hole variations that can make them incompatible.	100G 100G Datalogging	ERG-5000-004 ERG-5002-004
Sensus/Invensys/ Equimeter/Rockwell	RT-360	18 Tooth	Residential		100G 100G Datalogging	ERG-5000-004 ERG-5002-004
Sensus/Invensys/ Equimeter/Rockwell	MR8 (R-275 Metric)	16 Tooth	Residential		100G 100G Datalogging	ERG-5000-003 ERG-5002-003
Sensus/Invensys/ Equimeter/Rockwell	MR12 (R-415 Metric)	16 Tooth	Residential		100G 100G Datalogging	ERG-5000-003 ERG-5002-003
Sensus/Invensys/ Equimeter/Rockwell	750		Commercial		100G	ERG-5000-008
Sensus/Invensys/ Equimeter/Rockwell	1000		Commercial		100G	ERG-5000-008
Sensus/Invensys/ Equimeter/Rockwell	1600		Commercial		100G	ERG-5000-008
Sensus/Invensys/ Equimeter/Rockwell	3000		Commercial	Vertical index only	100G	ERG-5000-008
Sensus/Invensys/ Equimeter/Rockwell	5000		Commercial	Vertical index only	100G	ERG-5000-008
Sensus/Invensys/ Equimeter/Rockwell	10000		Commercial	Vertical index only	100G	ERG-5000-008
National/ Lancaster	175		Residential	Sprague/Schlumberger/ Actaris Direct Read indexes cannot be used	100G	ERG-5000-006
National/ Lancaster	U175 UL175		Residential	Sprague/Schlumberger/ Actaris Direct Read indexes cannot be used	100G	ERG-5000-006
National/ Lancaster	250		Residential	Sprague/Schlumberger/ Actaris Direct Read indexes cannot be used	100G	ERG-5000-006
Schlumberger/ Sprague	175	3 Hole index box	Residential	Index boxes with 3 mounting holes	100G	ERG-5000-005
Schlumberger/ Sprague	175 WC	3 Hole index box	Residential	Index boxes with 3 mounting holes	100G	ERG-5000-005

Schlumberger/ Sprague	175 Combination	3 Hole index box	Residential	Index boxes with 3 mounting holes	100G	ERG-5000-005
Schlumberger/ Sprague	210		Residential		100G	ERG-5000-005
Schlumberger/ Sprague	240	Canadian Version of 250	Residential		100G	ERG-5000-005
Schlumberger/ Sprague	240 Combination		Residential		100G	ERG-5000-005
Schlumberger/ Sprague	240		Residential		100G	ERG-5000-005
Schlumberger/ Sprague	240	1 Hole cover flat face	Residential	Requires Itron 1A Adapter P/N CFG-0015- 001Kit	100G	ERG-5000-005 + CFG-0015-001
Schlumberger/ Sprague	240	2 Hole cover	Residential		100G	ERG-5000-005
Schlumberger/ Sprague	250		Residential		100G	ERG-5000-005
Schlumberger/ Sprague	250 WC		Residential		100G	ERG-5000-005
Schlumberger/ Sprague	250 Combination		Residential		100G	ERG-5000-005
Schlumberger/ Sprague	1A	Flat face	Residential	Requires Itron 1A adapter kit, CFG-0015-001	100G	ERG-5000-005 + CFG-0015-001
Actaris/ Schlumberger	METRIS S 250	3 Hole Index Box	Residential	Index boxes with 3 mounting holes Slant-faced	100G	ERG-5000-005
Schlumberger/ Sprague	400		Residential	Slant-faced	100G	ERG-5000-005
Actaris/ Schlumberger	400A		Residential	Slant-faced	100G	ERG-5000-005
Actaris/ Schlumberger	675A		Commercial	Requires Actaris adapter p/n 80005901; purchase from Actaris	100G	ERG-5000-007
Actaris/ Schlumberger	800A		Commercial	Requires Actaris adapter p/n 80005901; purchase from Actaris	100G	ERG-5000-007
Actaris/ Schlumberger	1000A		Commercial	Requires Actaris adapter p/n 80005901; purchase from Actaris	100G	ERG-5000-007
EMCO	#2 1/2		Commercial		100G	ERG-5000-008

EMCO	#3		Commercial		100G	ERG-5000-008
EMCO	#4		Commercial		100G	ERG-5000-008
EMCO	#4 1/2		Commercial		100G	ERG-5000-008
EMCO	#5		Commercial		100G	ERG-5000-008

CHAPTER 2

American Meter Installation

This chapter shows you how to install a 100G ERT Module on an American Meter.



Installation Prerequisites

The following items are required to install the Itron 100G ERT Module.

Materials Supplied By Itron

The following items are supplied by Itron:

- 100G ERT Module
- New tamper seals

Materials Supplied By You

The following tools are required to install, initialize, and check the 100G ERT Module on the meter.

- **Small and medium flat-blade or Phillips screwdrivers** Used to remove and tighten index and index-cover screws.
- **Side-cutting plier/wire snips** Used for cutting wire seals, if necessary.
- **Small putty knife** Used to remove all traces of old gaskets from the meter.
- **Meter seals, wire seals, and seal press** Used to secure the meter from tampering, if necessary.
- **11/32-inch nut driver or other blunt tool** Used to securely seat new tamper plugs over screw holes.
- **Replacement screws** Used to mount 100G ERT Module assembly to meter and index to module assembly backplates.
- **FC200SR with EndPoint-Link or EndPoint-Link Pro software** Used to program and check ERT assembly.

Replacement Screws

Replacement screws used in this procedure include:

For mounting the 100G ERT Module assembly on the meter:

- Use 1/4 - 20 x 5/8-inch slotted, Fillister head screws.

For mounting the index on the 100G ERT Module backplate:

- Use 8 - 32 x 3/16-inch slotted, round head screws.

Pre-installation Preparations

Before installing the 100G ERT Module on a meter, verify:

- All Itron 100G ERT Module gas modules are compatible with your brand of gas meter.
 - See the Meter Compatibility List for compatible meter model numbers for the 100G ERT Module

Installing the 100G ERT Module

There are four steps to installing the 100G ERT Module on a meter:

- Remove the index
- Assemble the 100G ERT Module
- Program the 100G ERT Module
- Attach the 100G ERT Module to the meter.



NOTE Properly dispose of all unused screws, old index covers, gaskets, tamper seals, and other left over materials. Do not leave any materials on customer premises.

Remove the Index

The first step to install a 100G ERT Module on the meter is to remove the index from the meter.

To remove the index

1. Remove any tamper seals from the meter.

2. Detach the index cover from the meter by removing the four screws holding it in place.

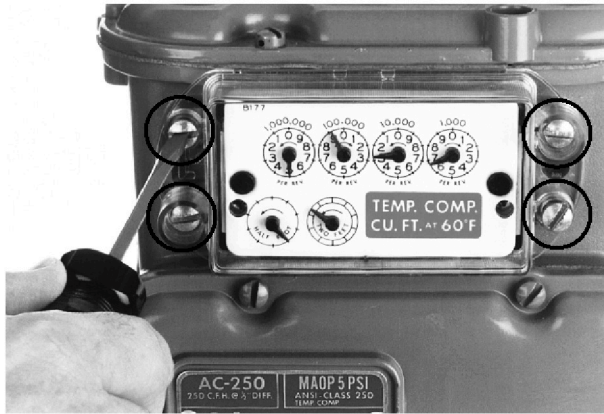

3. Examine the index cover screws you removed. Verify they are 5/8-inch long and not corroded.

- If the screws are 5/8-inch long, and are not corroded, retain for later use.
- If the screws are an incorrect length or corroded, dispose of them properly. Use 1/4 - 20 x 5/8-inch screws as described in [Replacement Screws](#) on page 10.



TIP You can use the index cover you just removed as a temporary storage location for screws.



NOTE Dispose of the index cover properly when finished with the installation procedure. Do not leave it on customer premises.

4. Unscrew one index mounting screw completely.

Hold one hand beneath the index to catch the screw when it falls out of the index assembly. If it does not fall out by itself, be sure to remove it.

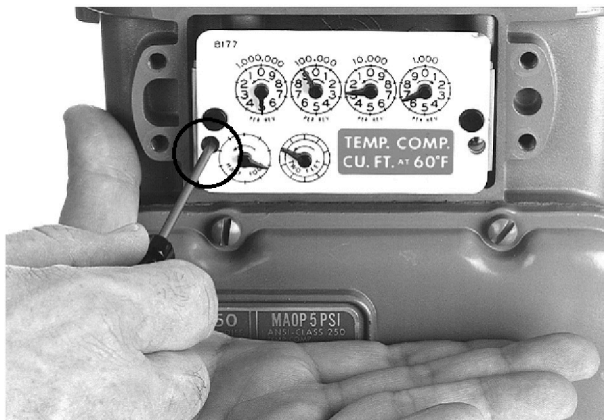

5. Unscrew the other index mounting screw.

While removing this screw, pull the index away from the meter to keep its backplate (1) against the back of the screwhead (2). This prevents the screw from falling out prematurely.

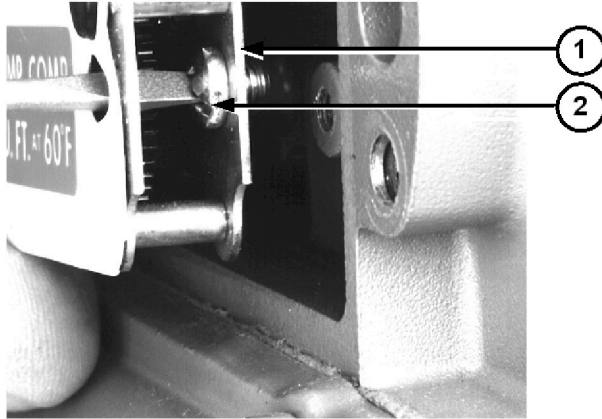

6. Remove the screw from the index once it is completely free of its hole.
7. Set the index aside for the moment. Place it where it will not be damaged; get filled with dirt, rain, or snow; or fall to the ground or floor. The index will be used later in this procedure.
8. Examine the index screws you just removed. Verify that they are 3/16-inch long and are not corroded.
 - If the screws are 3/16-inch long and are not corroded, keep them for later use.
 - If the screws are an incorrect length or are corroded, dispose of them properly. Use 8 - 32 x 3/16-inch screws as described in [Replacement Screws](#) on page 10 instead.
9. Use a putty knife or similar object to completely remove the old index gasket from the meter (if applicable). All traces of the gasket must be removed before the ERT can be installed.

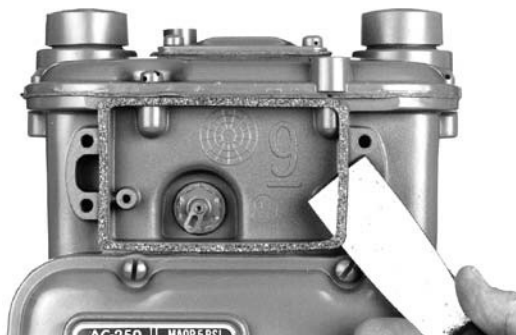

Assemble the ERT Module

The next step in the 100G ERT Module installation is to create the endpoint module assembly by attaching the endpoint backplate and cover to the meter index.

To assemble the ERT module

1. Hold the new 100G ERT Module.
2. Separate the ERT module backplate from the cover.

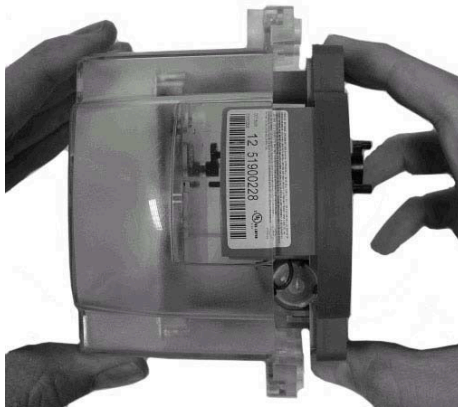

3. Place the new ERT index cover where it will not be damaged. The index cover must not get filled with dirt, rain, or snow; or fall to the ground or floor. The ERT index cover will be used later in this procedure.



IMPORTANT Before continuing with the installation, note the following information about American Meter indexes.

- Index wrigglers on one-foot meters have drive slots.

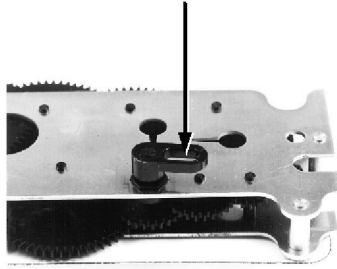

- Index wrigglers on two-foot meters have drive posts.

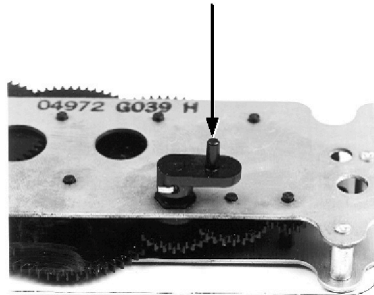

- An index may have mounting screw holes.

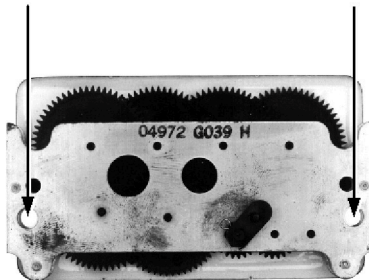

- An index may have mounting screw slots.

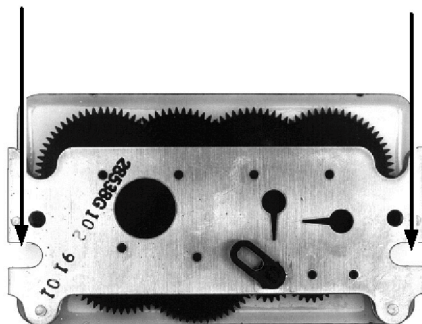

If the index has mounting screw *slots*, skip steps 4 and 5. Continue with step 6.

If the index has mounting screw *holes*, perform steps 4 and 5. Skip steps 6 and 7.

4. If the index has mounting screw *holes*, place an index mounting screw (1) in the right-hand mounting screw hole (2). Use one 8 - 32 3/16-inch screw for this step (use an original mounting screw if it was the correct size and not corroded. Use the correct size replacement screw if required).

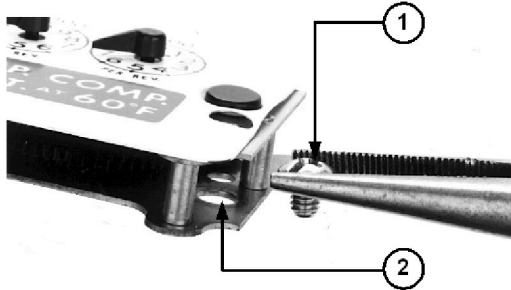

5. Attach the screw to the ERT backplate's right-hand index mounting post just enough to hold the screw end of the index in place.

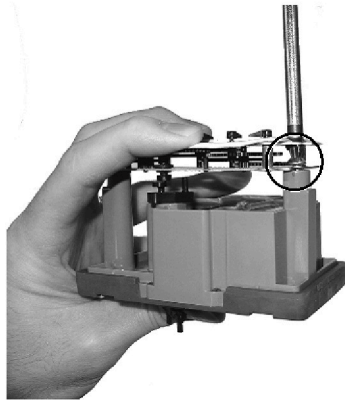

6. If the index has mounting screw *slots*, screw an index mounting screw (1) one to two turns into the ERT backplate's right-hand index mounting post (2). Use one 8 - 32 x 3/16-inch screw for this step (use an original mounting screw if it was the correct size and not corroded. Use the correct size replacement screw, if required).

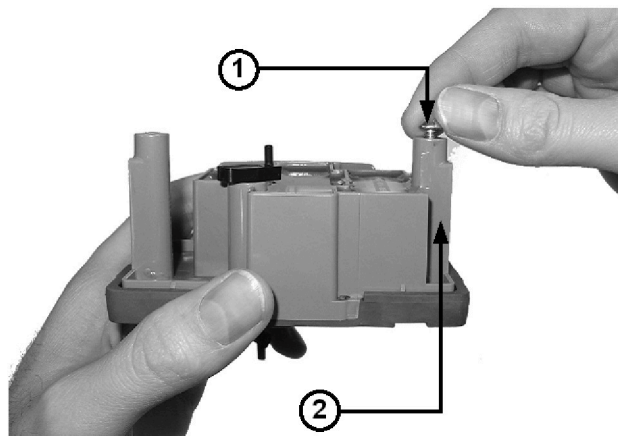

7. Place the index mounting screw slot under the screw head. *Do not* tighten the screw.



8. Attach the wiggler to the index and backplate.
 - If the index wiggler has a drive slot (1), place the backplate wiggler's drive post (2) in the index wiggler's drive slot.

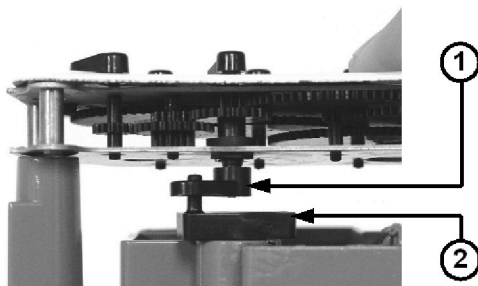

- If the index wiggler has a drive post (1), place the index wiggler's drive post in the backplate wiggler's drive slot (2).

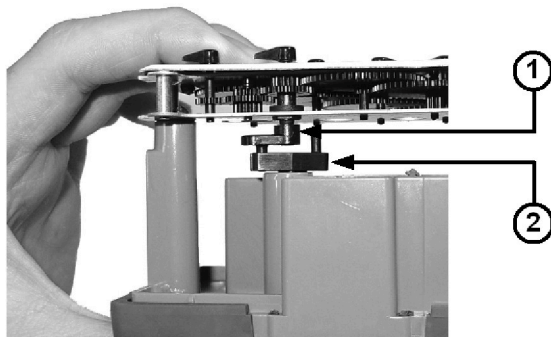

9. Install and tighten the left-hand index mounting screw (for indexes with either mounting screw slots or holes). Use one 8 - 32 x 3/16-inch screw for this step (use an original mounting screw if it is the correct size and not corroded. Use the correct size replacement screw, if required).



10. Tighten the right-hand index mounting screw.



Note To verify correct installation of the index to the ERT module housing, spin wiggler clockwise, then counter-clockwise (not more than one complete rotation). Wiggler should spin freely with little or no resistance.

11. Slide the ERT cover (1) over the index and backplate (2).

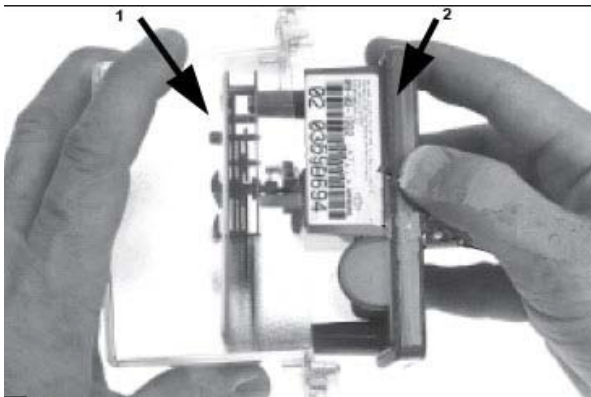

Next, program the ERT module.

Program the ERT Module

The ERT must be programmed using the FC200SR with EndPoint-Link software. See the *Endpoint-Link ERT Programming Guide (TDC-0411)* for more information.

 **IMPORTANT** You must perform the following programming procedure for the ERT module to function properly.

You must program the meter based on the drive rate shown on the index. Examples of 1-foot (1) and 2-foot (2) drive rates are shown. (The 0.05 cubic meter drive rate is not shown.) You must program the ERT based on the drive rate indicated on the index.

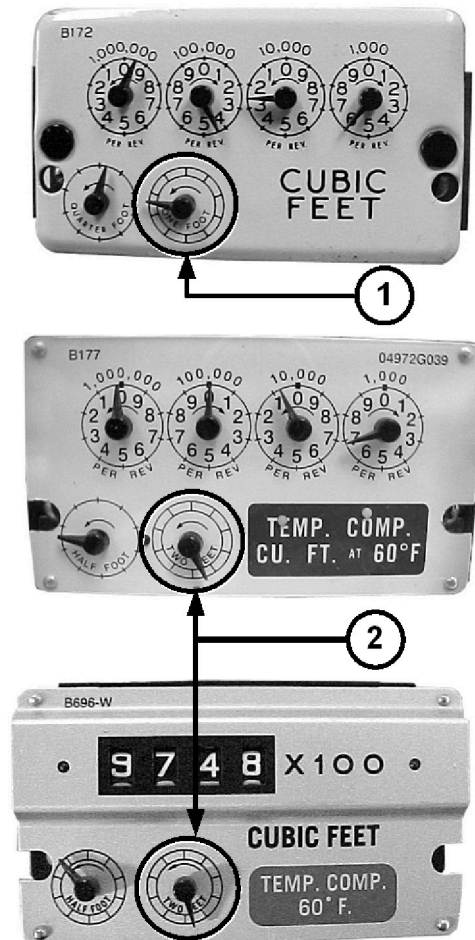

To program the ERT module

1. Using the FC200SR, program the reading of the index that was on the meter into the ERT module assembly.
 - For initial programming, hold the FC200SR approximately 1 foot away from the 100G.
 - For reprogramming (30 days or more past initial programming), hold the FC200SR approximately 4 to 5 feet away from the 100G.

Be sure to program the 100G to the correct mode for the reading technology that will be used (for example, Fixed Network Mode, Mobile/Handheld Mode, or Hard to Read Mobile/Handheld Mode). In Endpoint-Link Pro v5.0, you will have access to the one mode that was defined by your system administrator.

During programming, the 100G ERT module is programmed to the *nearest 100 cubic feet*; the last two digits (the tens and units) are programmed as zeros (0). Once programming is complete, however, the ERT module assembly can be read to the nearest cubic foot.

2. Slowly turn the ERT module drive wriggler two turns in the direction indicated on the index drive rate. This lets you verify the ERT module is counting properly after assembly.



IMPORTANT Do not turn the drive wriggler faster than *one turn per second*.

3. Read the ERT module assembly using the FC200SR. Consult the *EndPoint-Link ERT Programming Guide (TDC-0411)* or other applicable instructions for details on how to read an ERT.
 - If this reading is higher than the one you programmed in step 1 above, the ERT module assembly is counting correctly.
 - If the ERT module assembly reading is *not* higher than what was programmed in step 1, replace the ERT module with a new one.

Attach the ERT Module to the Meter

After the endpoint has been programmed and is reading correctly, it must be attached to the meter. Follow the steps below to do this.

To Attach the ERT to the Meter

1. **5B 225 Meters Only** If you are installing the ERT on a 5B 225 aluminum meter, cut 1/16-inch off each post of the ERT wiggler to prevent it from rubbing on the face of the nut that holds the wiggler in place. If you are not installing on a 5B 225 meter, continue to step 2 below.



2. Set the wiggler to the desired position for mounting the ERT module assembly to the meter.
 - **For One-Foot Meters:** Align the ERT module assembly wiggler with the meter drive post (as shown below). Make sure the ERT wiggler is perpendicular to the meter drive post.

