

- **For Two-Foot Meters:** Align the ERT module assembly wriggler with the meter drive slot (as shown below). It is acceptable for the pin on the 100G wriggler to be installed inside or outside of the meter drive slot. For ease of assembly, Itron recommends that the pin on the 100G wriggler be installed outside of the meter drive slot.

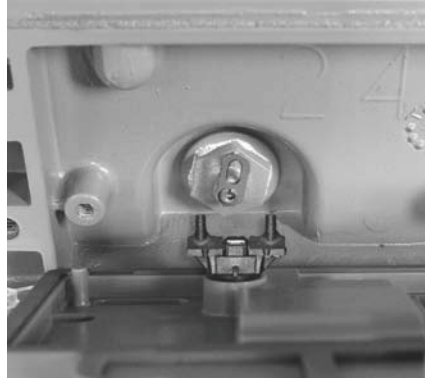

3. Gently place the ERT module assembly on the meter. Align the four screw holes on the ERT module assembly with the holes on the meter.

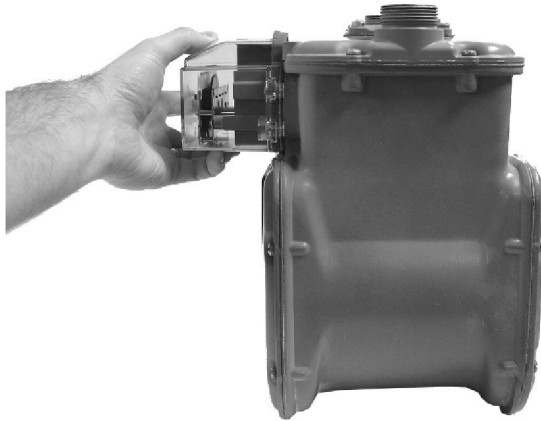

4. Turn each screw 1/4 to 1/2 turn after it contacts the cover. Use the 1/4 - 20 x 5/8-inch screws for this step. You can use the original mounting screws if they were the correct size and not corroded, otherwise, use the correct size [Replacement Screws](#) on page 10.



**IMPORTANT** Meter manufacturers should torque the mounting screws 15 to 20 inch-pounds.

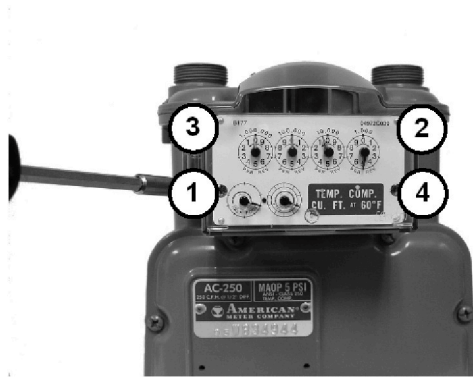

5. Place a new tamper seal over two of the mounting screws as shown below.

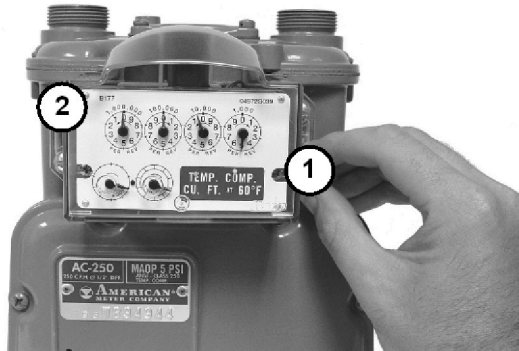

6. Press the new tamper seals into place using the 11/32-inch nut driver (or another similar blunt tool).

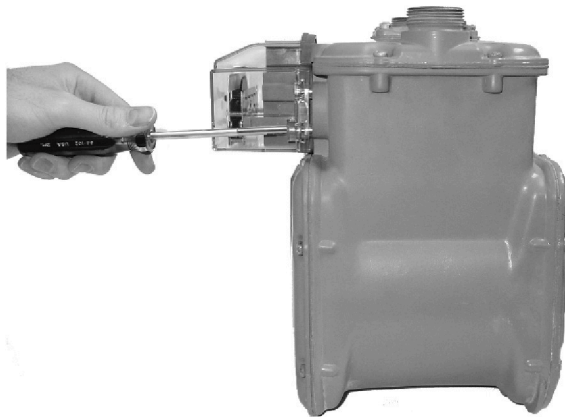

7. Complete any necessary paperwork. Make sure no excess material is left on the customer premises; dispose of it properly.

The ERT is now installed on the meter.





## CHAPTER 3

# Sensus Meter Installation

---

This chapter shows you how to install a 100G ERT Module on a Sensus meter. The instructions in this chapter apply to 11-tooth, 16-tooth, and 18-tooth Sensus endpoints.



**Sensus** meters are also known as: **Invensys**, **Equimeter**, and **Rockwell**. For consistency, these meter types will be referred to as Sensus meters for this installation procedure.



## Installation Prerequisites

The following items are required to install the Itron 100G ERT Module.

### Materials Supplied By Itron

The following items are supplied by Itron:

- 100G ERT Module
- New tamper seals

## Materials Supplied By You

The following tools are required to install, initialize, and check the 100G ERT Module on the meter.

- **Small and medium flat-blade or Phillips screwdrivers** Used to remove and tighten index and index-cover screws.
- **Side-cutting plier/wire snips** Used for cutting wire seals, if necessary.
- **Small putty knife** Used to remove all traces of old gaskets from the meter.
- **Meter seals, wire seals, and seal press** Used to secure the meter from tampering, if necessary.
- **11/32-inch nut driver or other blunt tool** Used to securely seat new tamper plugs over screw holes.
- **Replacement screws** Used to mount 100G ERT Module assembly to meter and index to module assembly backplates.
- **FC200SR with EndPoint-Link or EndPoint-Link Pro software** Used to program and check ERT assembly.

## Replacement Screws

Replacement screws used in this procedure include:

For mounting the 100G ERT Module assembly on the meter:

- Use 10 - 24 x 5/8-inch slotted, Fillister head screws.

For mounting the index on the 100G ERT Module backplate:

- Use 6 - 32 x 5/8-inch slotted, round head screws.

## Pre-installation Preparations

Before installing the 100G ERT Module on a meter, verify:

- All Itron 100G ERT Module gas modules are compatible with your brand of gas meter. See the Meter Compatibility List for compatible meter model numbers for the 100G ERT Module

## Installing the 100G ERT Module

There are four steps to installing the 100G ERT Module on a meter:

- Remove the index
- Assemble the 100G ERT Module
- Program the 100G ERT Module
- Attach the 100G ERT Module to the meter.



**NOTE** Properly dispose of all unused screws, old index covers, gaskets, tamper seals, and other left over materials. Do not leave any materials on customer premises.

### Remove the Index

The first step to install a 100G ERT Module on the meter is to remove the index from the meter.

#### *To Remove the Index*

1. Remove any tamper seals from the meter.
2. Detach the index cover from the meter by removing the four screws holding it in place.

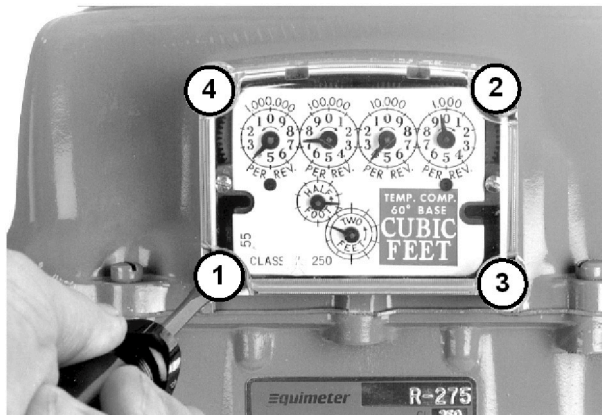

3. Examine the index cover screws you removed. Verify they are 5/8-inch long and are not corroded.
  - If the screws are 5/8-inch long and are not corroded, keep them for later use.
  - If they are an incorrect length or are corroded, dispose of them properly. Use 10 - 24 x 5/8-inch screws as described in [Replacement Screws](#) on page 26.



**TIP** Use the index cover you just removed as a temporary storage location for screws.



**NOTE** Dispose of the index cover properly when finished with the installation procedure. Do not leave it on customer premises.

4. Unscrew one index mounting screw completely.

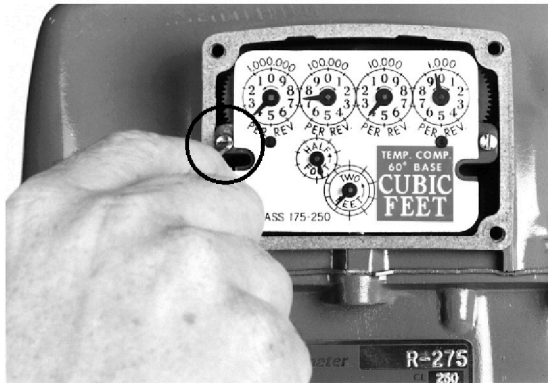

5. Remove the other index mounting screw.
6. Place the index where it will not be damaged; get filled with dirt, rain or snow; or fall to the ground or floor. The index will be used later in this procedure.
7. Examine the index screws you just removed. Verify that they are 5/8-inch long and are not corroded.
  - If the screws are 5/8-inch long and are not corroded, keep them for later use.
  - If the screws are an incorrect length or are corroded, dispose of them properly. Use 6 -32 x 5/8-inch screws as described in [Replacement Screws](#) on page 26, if required.
8. Use a putty knife or similar object to completely remove the old index gasket from the meter (if applicable). All traces of the gasket must be removed before the ERT is installed.

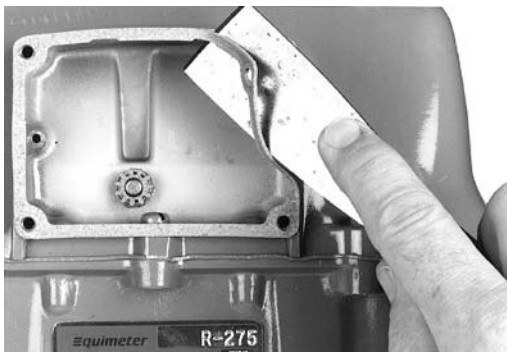



## Assemble the ERT Module

The next step in the 100G ERT Module installation is to create the endpoint module assembly by attaching the endpoint backplate and cover to the meter index.

### To Assemble the ERT

1. Obtain a new 100G ERT Module.
2. Separate the ERT module backplate from the cover.
3. Place the index drive gear (1) in the backplate wiggler gear cup (2) of the ERT. The following picture shows an 11-tooth drive gear. If your index has a 16- or 18-tooth drive gear, you must use the appropriate 100G ERT Module for your meter. See the [Meter Compatibility list](#) on page 2 for more information.

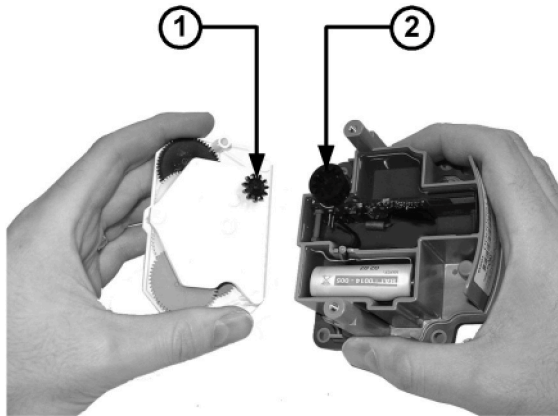

Once properly in place, the index drive gear and backplate wiggler cup should look similar to the following example.

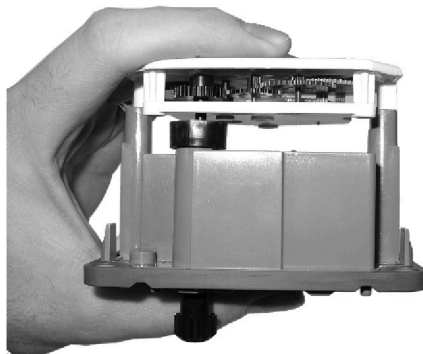

4. Attach the right-hand mounting screw to the index and meter, just far enough to hold the index in place. Use one 6 - 32 x 5/8-inch screw for this step (you can use an original mounting screw if it was the correct size and not corroded; otherwise, use the correct size [Replacement Screw](#) on page 26).



5. Install and tighten the left-hand index mounting screw.

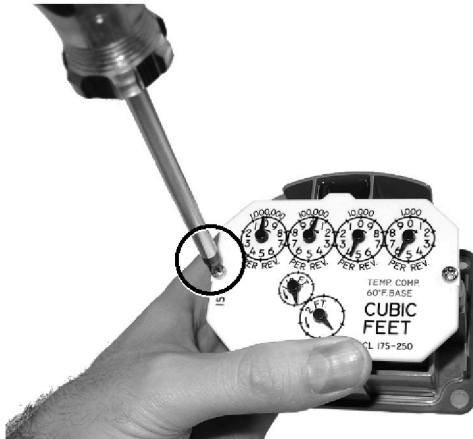

6. Tighten the right-hand index mounting screw completely.

- 7. Slide the ERT cover over the index and backplate.



- 8. Verify that the cover is installed correctly.  
Next, program the ERT module.

### Program the ERT

The ERT must be programmed using the FC200SR with EndPoint-Link software. See the *Endpoint-Link ERT Programming Guide (TDC-0411)* for more information.

 **IMPORTANT** You must perform the following programming procedure for the ERT module to function properly.

Sensus meters. Sensus meters have a 2-foot drive rate, as indicated in the example below (1), or a 0.05 cubic meter drive (not shown).

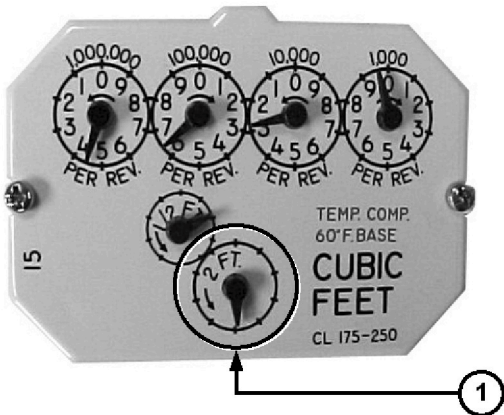

### To Program the ERT Module

1. Using the FC200SR, program the reading of the index that was on the meter into the ERT module assembly.
  - For initial programming, hold the FC200SR approximately 1 foot away from the 100G.
  - For reprogramming (30 days or more past initial programming), hold the FC200SR approximately 4 to 5 feet away from the 100G.

Be sure to program the 100G to the correct mode for the reading technology that will be used (for example, Fixed Network Mode, Mobile/Handheld Mode, or Hard to Read Mobile/Handheld Mode). In Endpoint-Link Pro v5.0, you will have access to the one mode that was defined by your system administrator.

During programming, the 100G ERT module is programmed to the *nearest 100 cubic feet*; the last two digits (the tens and units) are programmed as zeros (0). Once programming is complete, however, the ERT module assembly can be read to the nearest cubic foot.

2. Slowly turn the ERT module drive wriggler two turns in the direction indicated on the index drive rate. This lets you verify the ERT module is counting properly after assembly.



**IMPORTANT** Do not turn the drive wriggler faster than *one turn per second*.

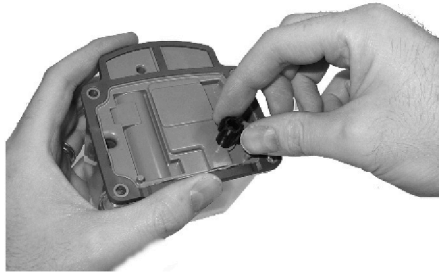

3. Read the ERT module assembly using the FC200SR. Consult the *EndPoint-Link ERT Programming Guide (TDC-0411)* or other applicable instructions for details on how to read an ERT.
  - If this reading is higher than the one you programmed in step 1 above, the ERT module assembly is counting correctly.
  - If the ERT module assembly reading is *not* higher than what was programmed in step 1, replace the ERT module with a new one.

## Attach the ERT to the Meter

After the endpoint has been programmed and is reading correctly, it must be attached to the meter. Follow the steps below to do this.

### To Attach the ERT to the Meter

1. Gently place the ERT module assembly against the front of the meter as shown. Make sure all four mounting screw holes in the ERT module assembly line up with the corresponding holes on the meter. The 100G ERT Module has molded tabs on the outer edge of its housing to make direct mounting easier.



2. Insert the top-right cover mounting screw. Tighten the screw just enough to hold the ERT module assembly in place. Use the 10 - 24 x 5/8-inch screws for this and the following step (you can use the original mounting screws if they were the correct size and not corroded; otherwise, use the correct size as described in [Replacement Screws](#) on page 26).



3. Turn each screw 1/4 to 1/2 turn after it contacts the cover.



**IMPORTANT** Meter manufacturers should torque the mounting screws 15 to 20 inch-pounds.



4. Place a new tamper seal over two of the mounting screws as shown below.

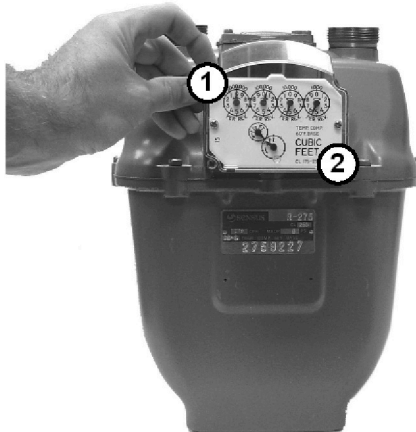

5. Press the new tamper seals into place using the 11/32-inch nut driver (or another similar blunt tool).

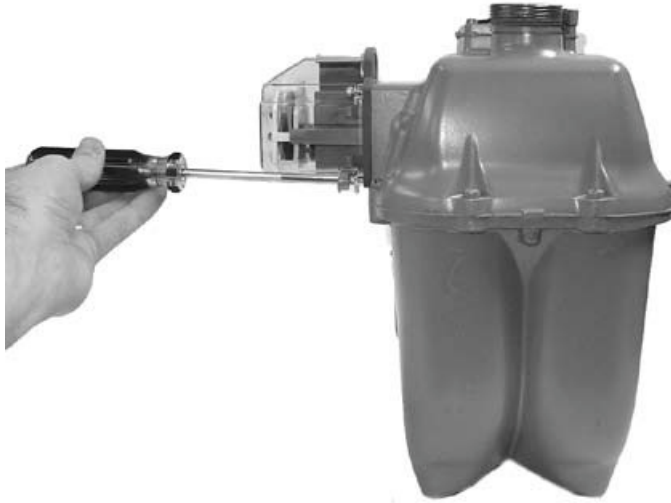

6. Complete any necessary paperwork. Make sure no excess material is left on the customer premises.

The ERT is now installed on the meter.







## CHAPTER 4

# Actaris Meter Installation

---

This chapter shows you how to install a 100G ERT Module on an Actaris meter.



**Actaris** meters are also known by the names: **Sprague**, and **Schlumberger**. For consistency, all of these meter types will be referred to as Actaris meters for this installation procedure.

## Installation Prerequisites

The following items are required to install the Itron 100G ERT Module.

### Materials Supplied By Itron

The following items are supplied by Itron:

- 100G ERT Module
- New tamper seals

## Materials Supplied By You

The following tools are required to install, initialize, and check the 100G ERT Module on the meter.

- **Small and medium flat-blade or Phillips screwdrivers** Used to remove and tighten index and index-cover screws.
- **Side-cutting plier/wire snips** Used for cutting wire seals, if necessary.
- **Small putty knife** Used to remove all traces of old gaskets from the meter.
- **Meter seals, wire seals, and seal press** Used to secure the meter from tampering, if necessary.
- **11/32-inch nut driver or other blunt tool** Used to securely seat new tamper plugs over screw holes.
- **Replacement screws** Used to mount 100G ERT Module assembly to meter and index to module assembly backplates.
- **FC200SR with EndPoint-Link or EndPoint-Link Pro software** Used to program and check ERT assembly.

## Replacement Screws

Replacement screws used in this procedure include:

For mounting 100G ERT Module assemblies on meters:

- Use 10 - 24 x 5/8-inch slotted, Fillister head screws.

For mounting indexes on 100G ERT Module backplates:

- Use 10 - 24 x 1/4-inch slotted, round head screws.

## Pre-installation Preparations

Before installing the 100G ERT Module on a meter, verify:

- All Itron 100G ERT Module gas modules are compatible with your brand of gas meter.
  - See the Meter Compatibility List for compatible meter model numbers for the 100G ERT Module

## Installing the 100G ERT Module

There are four steps to installing the 100G ERT Module on a meter:

- Remove the index
- Assemble the 100G ERT Module
- Program the 100G ERT Module
- Attach the 100G ERT Module to the meter.



**NOTE** Properly dispose of all unused screws, old index covers, gaskets, tamper seals, and other left over materials. Do not leave any materials on customer premises.

### Remove the Index

The first step to install a 100G ERT Module on the meter is to remove the index from the meter.

#### *To remove the index*

1. Remove tamper seals from the meter.
2. Remove the index cover from the meter by removing the four screws holding it in place.



3. Examine the index cover screws you removed. If they are 5/8 inches long and not corroded, you can use them to attach the 100G ERT Module to the meter.

If the screws are not the correct length, or are corroded, dispose of them properly. Replace them with the screws listed in [Replacement Screws](#) on page 38.

4. Use the removed index cover as a temporary storage location for screws.



**NOTE** Dispose of the index cover properly when finished with the installation procedure. Do not leave it on customer premises.

5. Loosen the index mounting screws one-half turn.

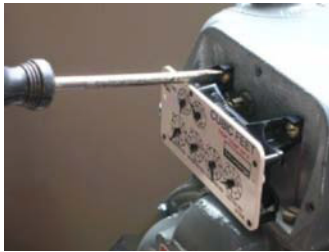

6. Slide the index off its mounting screws and remove from the meter. Set the index where it won't get damaged or dirty.



7. Remove the index mounting screws from the meter. Check the screws for length and corrosion. If they are 1/4 inches long and not corroded, you can use them to attach the index to the 100G ERT Module.

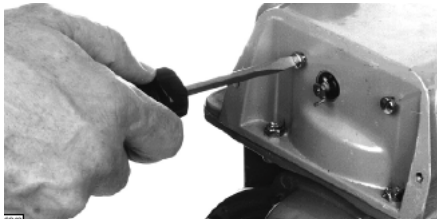

If the screws are not the correct length, or are corroded, dispose of them properly. Replace them with the screws listed in [Replacement Screws](#) on page 38.

8. Remove all traces of the old index gasket from the meter. The new 100G ERT Module has its own gasket.

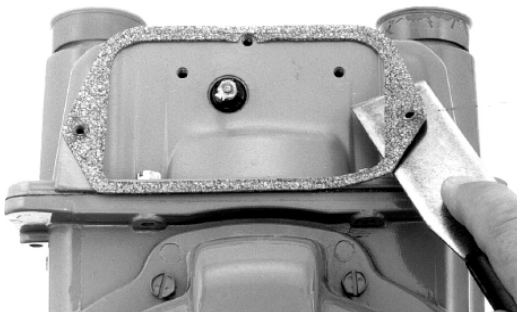

9. Dispose of the old gasket properly. Do not leave it on the customer premises.

## Assemble the ERT Module

The next step in the 100G ERT Module installation is to create the endpoint module assembly by attaching the endpoint backplate and cover to the meter index.

### *To Separate the Cover from the Backplate*

1. Obtain a new 100G ERT Module.
2. Place your thumb in the notch on the bottom of the endpoint to hold the backplate and pull the cover away from the backplate.



You can also separate the cover from the backplate by gently pulling on the wiggler until the backplate comes free.



3. Set the cover aside where it won't be damaged.
4. Put the index mounting screws about two turns into the backplate index mounting posts.



5. Position the backplate and index wrigglers as shown below.

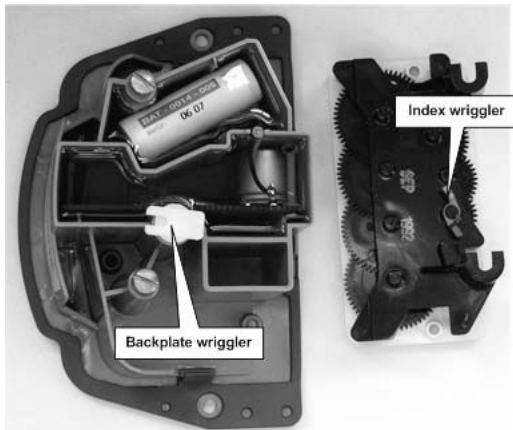

6. Slide the index mounting brackets onto the mounting screws.



7. Make sure the backplate wiggler post is below the index wiggler when lowering the index mounting brackets onto the index mounting screws.

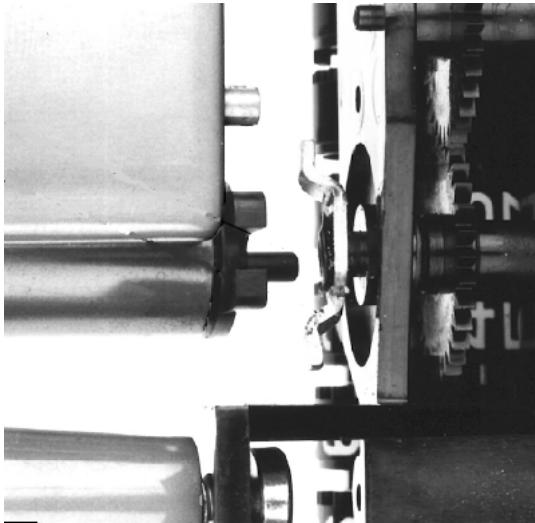

8. Hold the index in place with your thumb and tighten the index mounting screws.



9. Slide the cover over the index and onto the backplate until it is against the gasket.

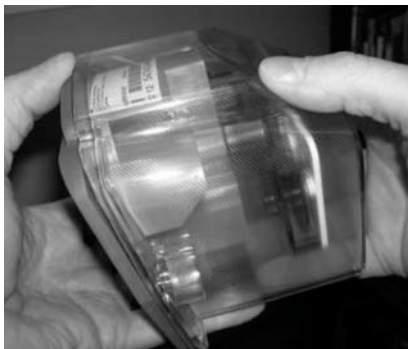

## Program the ERT

The ERT must be programmed using the FC200SR with EndPoint-Link software. See the *Endpoint-Link ERT Programming Guide (TDC-0411)* for more information.



**IMPORTANT** You must perform the following programming procedure for the ERT module to function properly.

### **To program the ERT module**

1. Using the FC200SR, program the reading of the index that was on the meter into the ERT module assembly.
  - For initial programming, hold the FC200SR approximately 1 foot away from the 100G.
  - For reprogramming (30 days or more past initial programming), hold the FC200SR approximately 4 to 5 feet away from the 100G.

Be sure to program the 100G to the correct mode for the reading technology that will be used (for example, Fixed Network Mode, Mobile/Handheld Mode, or Hard to Read Mobile/Handheld Mode). In Endpoint-Link Pro v5.0, you will have access to the one mode that was defined by your system administrator.

During programming, the 100G ERT module is programmed to the *nearest 100 cubic feet*; the last two digits (the tens and units) are programmed as zeros (0). Once programming is complete, however, the ERT module assembly can be read to the nearest cubic foot.

2. Slowly turn the ERT module drive wriggler two turns in the direction indicated on the index drive rate. This lets you verify the ERT module is counting properly after assembly.



**IMPORTANT** Do not turn the drive wriggler faster than *one turn per second*.

3. Read the ERT module assembly using the FC200SR. Consult the *EndPoint-Link ERT Programming Guide (TDC-0411)* or other applicable instructions for details on how to read an ERT.
  - If this reading is higher than the one you programmed in step 1 above, the ERT module assembly is counting correctly.
  - If the ERT module assembly reading is *not* higher than what was programmed in step 1, replace the ERT module with a new one.



## Attach the 100G ERT Module to the Meter

After the endpoint has been programmed and is reading correctly, it must be attached to the meter. Follow the steps below to do this.

### To attach the 100G ERT Module to the meter

1. Turn the white wiggler so one of its four drive slots lines up with the drive dog.

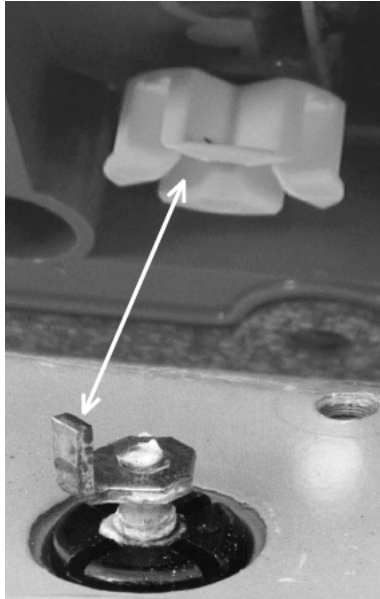

2. Gently place the 100G ERT Module on the meter.

If there is a gap between the gasket and the meter, it is probably because the drive slot of the ERT module assembly's wiggler is not properly aligned with the meter wiggler drive dog. To correct this, remove the assembly and repeat the alignment procedure in step one.

3. **WARNING!** If the drive slot of the 100G ERT Module wiggler is not properly aligned with the meter wiggler drive dog, there may be a gap between the gasket and the meter. To correct this, remove the assembly and repeat the alignment procedure. Failure to place the drive post into the drive slot can cause binding and lead to poor registration or meter failure. Turn each screw 1/4 to 1/2 turn after it contacts the cover.



**IMPORTANT** Meter manufacturers should torque the mounting screws 15 to 20 inch-pounds.