

Mounting the Remote Gas Module on a Wall or Other Flat Vertical Surface

1. Using one of the three 1-1/2-inch mounting screws from the Remote Mount Installation Kit, turn the mounting screw for the mounting lug (top of module) part way into the mounting surface.



2. Place the 100G series remote gas module mounting lug recess (on the top of the module backplate) just under the screw head.
3. Slide the module upward until the screw head fits completely inside the mounting lug recess. Several adjustments may be necessary to properly position the screw for module mounting.



4. Install the bottom two mounting screws. Fasten the screws in an alternating pattern until fully tightened to secure the module firmly in position.



Note For easier installation, drill three pilot holes in the mounting surface (use the correct size drill bit to accommodate the module mounting screws [see the drilling template below]). The drilled pilot holes for the two bottom screws must be on a horizontal line. To mount the module on a sheet metal surface, use the mounting screws included with the Remote Mounting kit. Use a comparable wood screw to mount the module on a vertical wood surface.

Carefully select a mounting location free from electrical wires. The mounting location must have the proper clearance to accommodate the 1-1/2-inch module mounting screws so nothing is damaged by the drill or mounting screws.

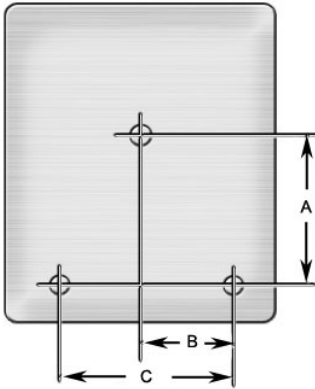

Remote module drilling template

- A 3 inches
- B 1-11/16 inches
- C 3-3/8 inches

To install tamper seals and cable ties

1. Place a new tamper seal (from the Remote Mount Installation Kit) over each ERT module mounting screw.



2. Firmly push both tamper seals into place with a 1/4-inch nut driver or similar blunt tool.

Note A tamper seal is fully seated when the top of the tamper seal is approximately 1/16-inch below the top of the screw recess.

3. To reduce the risk of cable damage, secure the excess module cable with the cable ties from the Remote Mount Installation Kit. Pull the cable tight. Remove and properly dispose the excess cable tie.

Mounting the 100G Series Remote Gas Module



100G remote module installation on a vertical flat surface or wall is complete.

CHAPTER 3

Rotary Meter Installation

This chapter provides the instructions to install the 100G series remote gas module on rotary gas meters. Reference the *Gas and Telemetry Module Meter Compatibility List* (PUB-0117-002) or see the [100G Series Remote ERT Module Meter Compatibility List](#) on page 3 for rotary meters compatible with the 100G series remote gas module.



American rotary meter



GE Dresser series LMMA rotary meter



GE Dresser series B3 meter



GE Dresser IMC/W2 meter

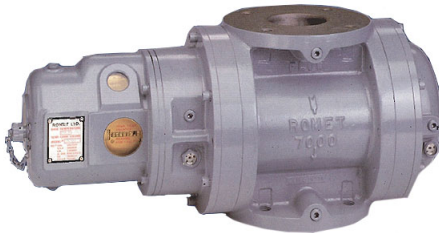

Romet Imperial series RM meter

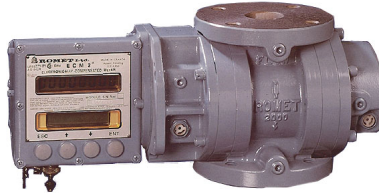

Romet Imperial ECM2 meter

Required Installation Materials Available from Itron

The materials in the following table are required to install a remote 100G DLS module.

Itron Part Number

ERG-5003-503

ERG-5006-503

Note this remote ERT module comes standard with 12-inch lead wires and may be shipped directly to the meter manufacturer for a factory-installed cable (interface). The interface cable must be purchased directly from the meter manufacturer.



ERG-5003-505

ERG-5006-505

Note this remote ERT module comes standard with 12-inch lead wires and may be shipped directly to the meter manufacturer for a factory-installed cable (interface). The interface cable must be purchased directly from the meter manufacturer.



Important You must purchase the interface cable directly from the meter manufacturer.

CFG-0005-003

Remote ERT Module Mounting Kit



Connecting the 100G Remote Gas ERT Module to the GE Dresser Rotary Meter Cable

You may ship the Itron 100G series remote gas module directly to GE Dresser for a factory-installed cable. If you connect the module to the meter using an existing cable purchased from GE Dresser, complete the following cable installation procedure.



Caution The purchased cable must have a mating connector compatible to the meter receptacle. GE Dresser cables may be wired in different configurations for specific applications. If necessary, contact GE Dresser for wiring diagrams for your specific application.

To connect the remote module to the rotary meter cable

1. Remove the backplate (4 screws) from the remote module and expose the module lead wires. The backplate and screws will be re-installed on the remote module later in this procedure so store them (temporarily) in a safe, secure place.

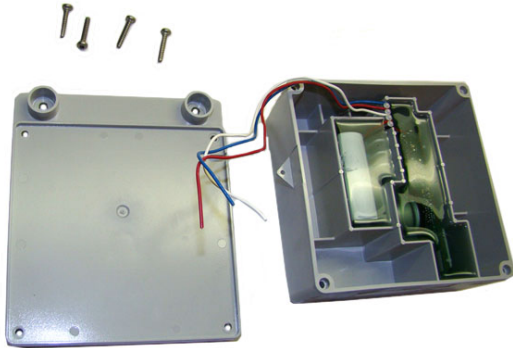

2. Insert the lead wires from the remote module into new 3M gel connectors (Itron part number CON-0023-001) together with the same colored lead wire from the meter cable (see the wiring table below) and crimp using a 3M hand-held crimping tool.

Rotary Meter to Remote	ERT Module Wire Table
Rotary meter wire	Remote ERT module wire
Red	Red
White	White
Blue	Blue

Important Use a crimping tool compatible with gel-connectors. *Do not* use a standard pliers for crimping gel-connects. The crimping tool provides an even pressured crimp to make a secure connection. Apply pressure for three seconds until the gel cap is fully crimped (collapsed) to allow time for the low viscosity silicone-based gel to flow (3). If the silicone gel flows out of the crimped connector, avoid touching the gel. Gel flowing from the connector provides environmental protection for the connection.

Note Do not strip lead wire prior to inserting the wire in the gel connector.

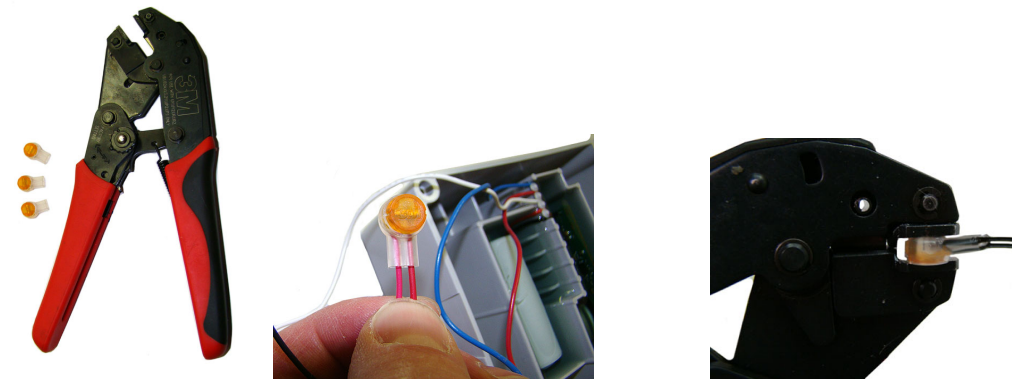

3. After completing the wiring connections, install a cable tie to the meter cable just below the exposed colored lead wires on the cable insulation. Remove the excess cable tie using a hand-held sidecutter pliers. The cable tie performs as a cable strain relief to mitigate the risk of destructive tension on the lead wires.

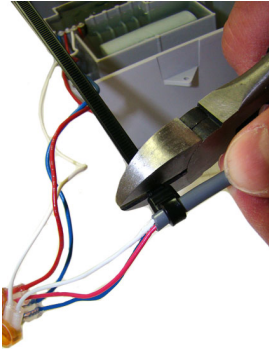

4. Tuck the three gel connectors and cable tie inside the module housing, as shown in the following placement schematic illustration.

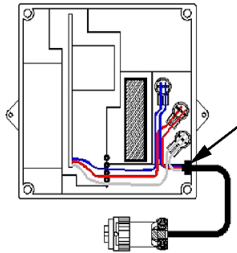

5. Install the remote 100G DLS module backplate using the four screws previously removed from the module and a Torx T-15 screwdriver.

Important Verify the cable tie and gel connectors are inside the module housing and the cable extends out of the slot in the backplate. Torque the backplate mounting screws to 9 to 12 inch-pounds.

6. Install the remote module on the wall or a pipe using the Remote Mount Kit (Itron part number CFG-0005-003). For mounting instructions, see [Mounting the 100G Series Gas ERT Module](#).



Programming the Remote ERT Module for GE Dresser Rotary Meters

To program 100G series remote gas modules for use with GE Dresser rotary meters, use the meter drive rates from the drive rate table in this section.

B3, LMMA & S3A CTR/TC Meter Drive Rates for Remote ERT Module Programming



Caution Do not use these meter drive rates to program residential direct-drive or commercial direct-drive modules. Use the information in the following tables to program 100G series remote gas modules connected to GE Dresser rotary meters.

B3, LMMA, S3A CTR/TC Meter Drive Rates			
B3 CTR Meter Size	B3 CTR Meter Pulse Rate	LMMA CTR Meter Size	LMMA CTR Meter Pulse Rate
8C	10	1.5M	10
11C	10	3M	10
15C	10	5M	10
2M	10	7M	10
3M	10	11M	10
5M	10	16M	100
7M	10	23M	100
11M	10	38M	100
16M	100	56M	100
23M	100	102M	100
38M	100		
56M	100		
LMMA CTR Meter Size	LMMA CTR Meter Pulse Rate	LMMA TC Meter Size	LMMA TC Meter Pulse Rate
1.5M	10	1.5M	10
3M	10	3M	10
5M	10	5M	10
7M	10	7M	10
11M	10	11M	10
16M	100	16M	100
23M	100		
38M	100		
56M	100		
102M	100		

Meters built 1/99 and beyond		Meters built prior to 1/99	
B3 TC Meter Size	B3 TC Meter Pulse Rate	B3 TC Meter Size	B3 TC Meter Pulse Rate
8C	10	8C	50
11C	10	11C	50
15C	10	15C	50
2M	10	2M	50
3M	10	3M	50
5M	10	5M	50
7M	10	7M	50
11M	10	11M	50
16M	100	16M	500
S3A CTR Meter Size	S3A CTR Meter Pulse Rate	S3A TC Meter Size	S3A TC Meter Pulse Rate
1.5M	10	1.5M	10
3M	10	3M	10
5M	10	5M	10
7M	10	7M	10
11M	10	11M	10
16M	100	16M	100

Installing the Remote ERT Module to the Elster American Meter RPM Series Rotary Meter

Some meter manufacturers provide ERT mounting kits and installation procedures for their meters. If 100G series remote gas module to Elster American RPM meter installation instructions are not available, follow the installation procedure in this section.



Elster American Meter RPM Series Rotary Meter

To install the 100G series remote gas module on an Elster American RPM series meter

1. Remove the meter's top plate by removing the two 5mm screws and carefully prying up on the plate. The plate is secured with an O-ring seal. Remove the O-ring from the plate.

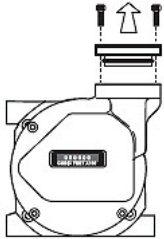

Caution If the O-ring is damaged during removal, obtain a replacement from Elster American Meter Co.

2. Look into the meter tower and find the meter switch lead and connector (4-pin).

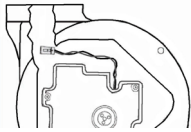

3. If the lead and connector are not visible or cannot be found, remove the four 5mm mounting screws and the register cover. The meter switch lead and connector will be visible inside the cover.

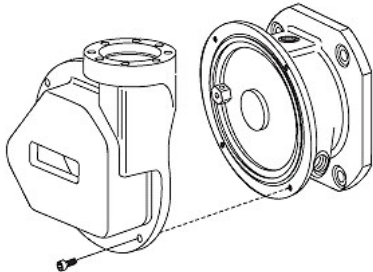

4. Feed the lead and connector into the register cover tower.

Note Save any meter tags. You will re-install them later in the installation process.

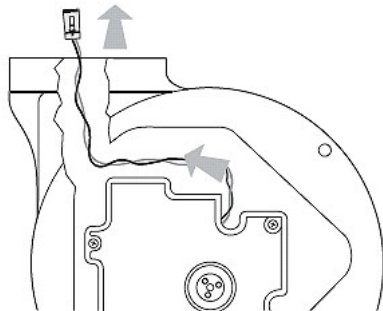

5. If you removed the register cover, replace the cover using the four (4) 5mm mounting screws.

6. Attach the 4-pin male connector on the Elster American Meter adapter plate to the 4-pin female connector inside the meter's tower. The connectors will slide together and latch.

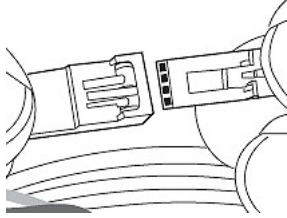

7. Carefully push the connectors and wires into the meter tower housing.

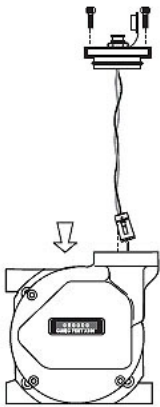

8. Lubricate the O-ring with O-ring lubricant and install the O-ring on the adapter plate. Insert the adapter plate into the tower and tighten the two 5 mm screws.

To connect the manufacturer cable to the ERT module

Note Connection to an Elster American Meter requires a cable interface compatible to an Elster American Meter RPM rotary meter.

1. Trim the ERT module wires to 3.5 inches.

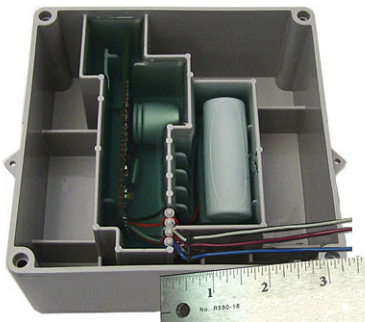

- Carefully strip the insulation covering from the meter cable (purchased from the meter manufacturer) approximately 1-1/2-inches from the end.

Caution Do not cut through the individual wire insulation.

- Separate the black, white, and blue wires for connection to the 100G series remote gas module. Cut off the unused wires even with the outer covering (insulation).

Caution Do not strip the individual wires.

- Connect the meter cable to the 100G series remote gas module using 3M gel-cap connectors. Follow the wire connection table and wiring diagrams below. See [Installation Prerequisites](#) on page 7 for appropriate 3M crimping tools.

Important Use a crimping tool compatible with gel-connectors. *Do not* use a standard pliers for crimping gel-connects. The crimping tool provides an even pressured crimp to make a secure connection. Apply pressure for three seconds until the gel cap is fully crimped (collapsed) to allow time for the low viscosity silicone-based gel to flow. If the silicone gel flows out of the crimped connector, avoid touching the gel. Gel flowing from the connector provides environmental protection for the connection.

American RPM Meter to the 100G series remote gas module Wire Connections

American RPM Meter wire	ERT module wire
Red	Red
White	White
Black	Blue

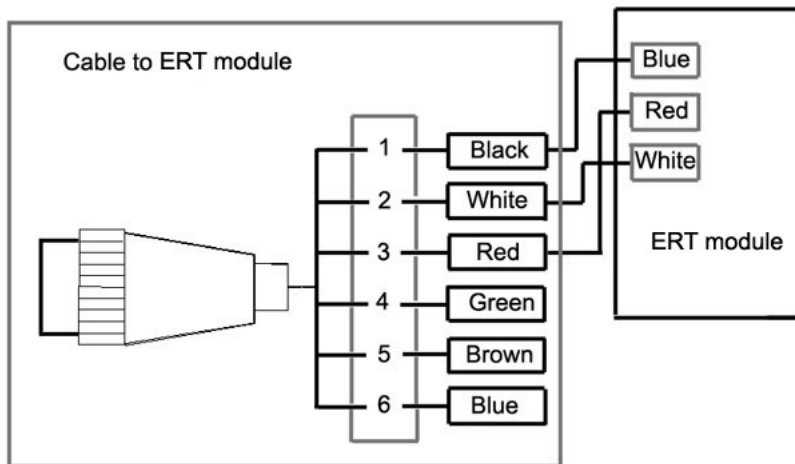
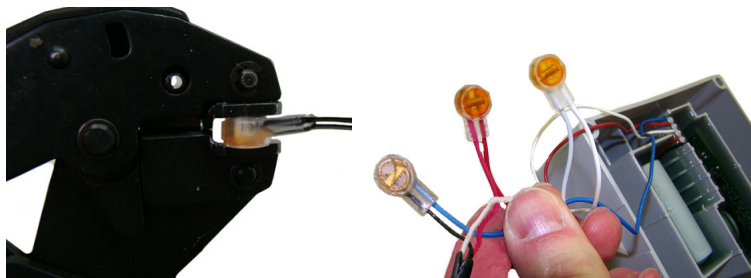

- Insert the meter cable through the slot on the ERT module backplate. Install a cable tie to the meter cable wire below the meter cable insulation to provide strain relief.

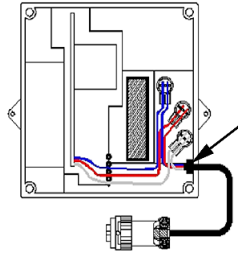
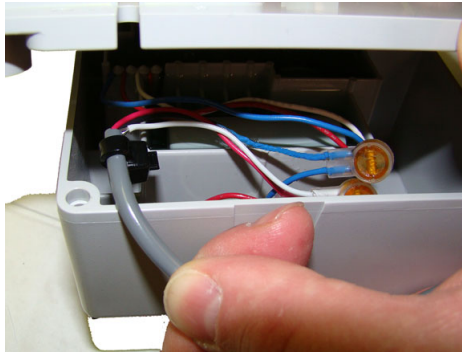

6. Tuck the connectors and cable tie into the ERT module housing. Place backplate on the assembly and tighten the four backplate screws using a size T-10 Torx screwdriver.

Important Verify the cable tie and gel connectors are inside the module housing and the cable extends out of the slot in the backplate. Torque the backplate mounting screws to 9-12 inch-pounds.



To install the 100G series remote gas module cable

1. Insert the plug on the cable connected to the ERT module into the receptacle on the meter adapter plate.

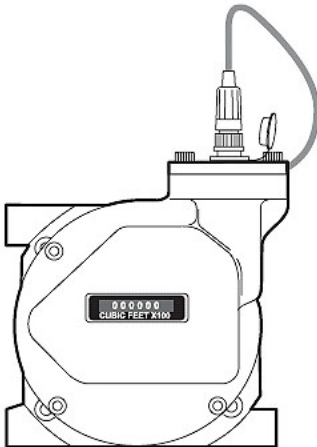

2. Tighten the threaded collar on the plug onto the American Meter interface receptacle. Verify the connection is hand-tight.

Mounting the 100G Series Remote Gas Module

Select an appropriate mounting location on adjacent piping close to the meter. Using the pipe bracket, mounting plate and band clamps from the Remote Mount Kit (Itron part number CFG-0005-003), secure the 100G series remote gas module. Use the cable ties from the kit to secure any excess wire to the piping (see [Mounting the 100G DLS Remote Gas ERT Module on a Pipe](#) on page 9).



Connecting the Remote ERT Module to the Romet Electronically Compensated Meter (ECM2®)

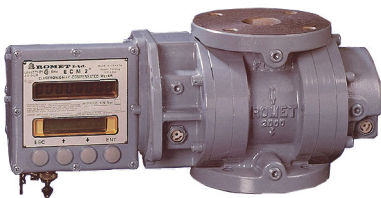

The Romet ECM2® meter has three Form "A" outputs that can be configured at the factory to provide any combination of the following three outputs:

- Uncorrected volume (UNC VOL)
- Corrected volume (COR VOL)
- Alarm

The pulse weight for the volumetric outputs is configured in *Setup Mode* at **Menu items > SET UNC OUT** and **Menu items > SET COR OUT**. Since Setup Mode is fully configurable, the ECM2® module is universally adaptable to all Romet TC meter bodies. Reference the Romet technical manual for specific details on the ECM2®.

Wiring the 100G Remote Gas ERT Module to the Romet ECM2® Meter

Connect the correct interface wirings and set the output pulse spacing to complete remote module installation with the Romet ECM2® meter. See the ECM2® interface wiring table below to complete wire connections.

Function	(+)UC	(-)UC	(+)CC	(-)CC	(+)ALM	(-)ALM	(+)Aux.CC	(-)Aux.CC	
ERT Module wire	White and	Red	White and	Red	White and	Red	White and	Red	
Pin location for Cannon Connector Part Number	34-125-20	C	B	A	B	E	D		
	34-125-40	A	B	C	D	E	F		
	34-125-41	A	B	C	D	E	F		
	34-125-42	E	F	A	B	C	D		
	34-125-43			A	B	E	F	C	D
	34-125-44							A	B
	34-125-45	A	B	E	D	C	F		
	34-125-50	3	1	2	5	6	4		
34-125-51	3	1	2	5			6	4	

Caution Set the ECM2® output pulse spacing to 750ms for operation with the remote 100G DLS module. Output spacing represents an *off-time* between pulses.

Romet ECM2/100G Remote Gas ERT Module Mounting Option

This mounting procedure requires the Romet ECM2/ERT Mounting Kit (Romet part number 34-444-1-KIT).



To mount the remote module on the Romet ECM2 meter

1. Remove the module screw from the back of the ECM2 meter and discard.

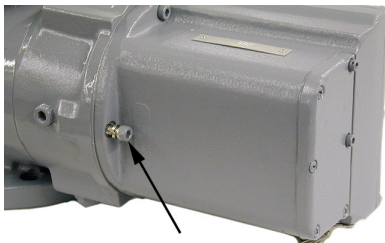

2. Insert the mounting screw fitted with the three lock washers. Two lock washers are used as spacers as shown.

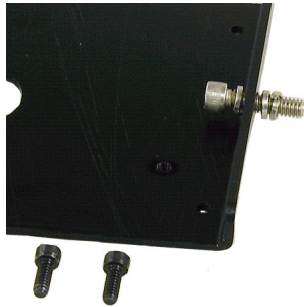

3. Attach the mounting plate to the meter. Insert the mounting screw where the module screw was removed. Torque the mounting screw to 5-7 ft. lbs. to secure the plate to the Romet meter.

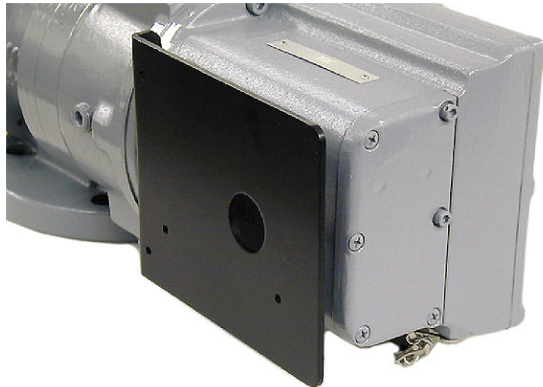

4. Mount the remote 100G module using the pre-drilled holes on the mounting plate and the module mounting screws.
5. Place new tamper seals over the two screws. Press tamper seals into place using an 11/32-inch nut driver or similar blunt tool.
6. Connect the module to the meter using the previously installed cable interface.



Programming the 100G Series Remote Gas Module



Caution You must program the 100G series remote gas module before use.

Program the 100G DLN ERT modules using:

- An FC200SR handheld computer with Field Deployment Manager (FDM) software version 1.1 or higher or
- A FC300 with SRead handheld computer with Field Deployment Manager (FDM) software version 1.1 or higher or
- A 900MHz Belt Clip Radio with Field Deployment Manager (FDM) software version 1.1 or higher and a customer-supplied laptop. The Belt Clip Radio connects to the user-supplied laptop using a USB cable or Bluetooth.

Program the 100G DLS ERT modules using:

- An FC200SR handheld computer with Field Deployment Manager (FDM) software version 3.3 or higher or
- An FC300 with SRead handheld computer with Field Deployment Manager (FDM) software version 3.3 or higher or
- A 900MHz Belt Clip Radio with Field Deployment Manager (FDM) software version 3.3 or higher and a customer-supplied laptop. The Belt Clip Radio connects to the user-supplied laptop using a USB cable or Bluetooth.

See the *Field Deployment Manager Endpoint Tools Mobile Application Guide (TDC-0934)* for more complete programming information.



FC200SR

FC300 with SRead

900MHz Belt Clip Radio