



Knowledge to Shape Your Future

Water Solutions

100W and 100WP Datalogging ERT Module Installation Guide

Identification

100W and 100WP Datalogging ERT Module Installation Guide
11/14/2011 TDC-0909-004

Copyright

© 2010 - 2011 Itron, Inc. All rights reserved.

Confidentiality Notice

The information contained herein is proprietary and confidential and provided subject to the condition that (i) it is held in confidence except to the extent required otherwise by law and (ii) it is used only for the purposes described herein. Any third party given access to this information is similarly bound in writing.

Compliance Statement

This device complies with Part 15 of the FCC Rules. These limits are designed to provide reasonable protection against harmful interference in a residential installation. Operation is subject to the following two conditions:

- This device may not cause harmful interference.
- This device must accept any interference that may cause undesirable operation.

This device must be permanently mounted such that it retains a distance of 20 centimeters (7.9 inches) from all persons in order to comply with FCC RF exposure levels.

This equipment has been tested and found to comply with the limits for a Class B digital device, pursuant to Part 15 of the FCC Rules. These limits are designed to provide reasonable protection against harmful interference in a residential installation. This equipment generates, uses, and can radiate radio frequency energy and, if not installed and used in accordance with the instructions, may cause harmful interference to radio communications. However, there is no guarantee that interference will not occur in a particular installation.

If this equipment does cause harmful interference to radio or television reception, which can be determined by turning the equipment off and on, the user is encouraged to try to correct the interference by one or more of the following measures:

- Reorient or relocate the receiving antenna.
- Increase the separation between the equipment and receiver.
- Connect the equipment into an outlet on a circuit different from that to which the receiver is connected.
- Consult the dealer or an experienced radio or TV technician for help.

Compliance Statement

This equipment complies with policies RSS-210 and RSS-GEN of the Industry Canada rules.

Operation is subject to the following two conditions:

- (1) this device may not cause interference, and
- (2) this device must accept any interference, including interference that may cause undesired operation of the device.

Compliance Statement Canada

Under Industry Canada regulations, this radio transmitter may only operate using an antenna of a type and maximum (or lesser) gain approved for the transmitter by Industry Canada. To reduce potential radio interference to other users, the antenna type and its gain should be so chosen that the equivalent isotropically radiated power (e.i.r.p.) is not more than that necessary for successful communication.

Déclaration de conformité

Le présent appareil est conforme aux CNR d'Industrie Canada applicables aux appareils radio exempts de licence. L'exploitation est autorisée aux deux conditions suivantes :

- (1) l'appareil ne doit pas produire de brouillage, et
- (2) l'utilisateur de l'appareil doit accepter tout brouillage radioélectrique subi, même si le brouillage est susceptible d'en compromettre le fonctionnement.

Déclaration de Conformité

Conformément à la réglementation d'Industrie Canada, le présent émetteur radio peut fonctionner avec une antenne d'un type et d'un gain maximal (ou inférieur) approuvé pour l'émetteur par Industrie Canada. Dans le but de réduire les risques de brouillage radioélectrique à l'intention des autres utilisateurs, il faut choisir le type d'antenne et son gain de sorte que la puissance isotrope rayonnée équivalente (p.i.r.e.) ne dépasse pas l'intensité nécessaire à l'établissement d'une communication satisfaisante.

Trademark Notice

Itron is a registered trademark of Itron, Inc.

All other product names and logos in this documentation are used for identification purposes only and may be trademarks or registered trademarks of their respective companies.



Warning To prevent ignition of flammable or combustible atmospheres, disconnect power before servicing.



Warning Follow these procedures to avoid injury to yourself or others:

- The lithium battery may cause a fire or chemical burn if it is not disposed of properly.
- Do not recharge, disassemble, heat above 100° Celsius (212° Fahrenheit), crush, expose to water, or incinerate the lithium battery. Fire, explosion, and severe burn hazard.
- Keep the lithium battery away from children.
- Replace the lithium battery only with batteries meeting Itron specifications. Any other battery may cause a fire or explosion.



Warning ELECTROMAGNETIC COMPATIBILITY

Use only approved accessories with this equipment. Unapproved modifications or operation beyond or in conflict with these instructions for use may void authorization by the authorities to operate the equipment.



Warning This unit cannot be modified and is not repairable. Attempts to modify or repair this device will void the warranty.

Transportation Classification

The Federal Aviation Administration prohibits operating transmitters and receivers on all commercial aircraft. When powered, ERT modules are considered operating transmitters and receivers and cannot be shipped by air. All product returns must be shipped by ground transportation to Itron.

Suggestions

If you have comments or suggestions on how we may improve this documentation, send them to TechnicalCommunicationsManager@itron.com

If you have questions or comments about the software or hardware product, contact Itron Technical Support:

Contact

- Internet: www.itron.com
- E-mail: support@itron.com
- Phone: 800 635 8725

Contents

Chapter 1 Before You Begin	1
Document Conventions	1
Document Purpose	1
How This Document is Organized	2
Related Documents	2
Chapter 2 About the 100W and 100WP ERT Module	3
100W and 100WP Models	4
Battery Life	4
100W and 100WP Transmission Modes	5
100W Operating Modes	5
100WP Operating Modes	6
Chapter 3 Initializing, Connecting, and Programming the ERT Module	7
Initializing the 100W	7
100W Encoder Start-up	7
Programming the 100WP	8
100WP Pulser Start-up	8
Connecting to a Meter Register Using the Inline Connector	8
Connecting to a Meter Register Using a Cable	8
Connecting the 100WP to a Remote Meter Register	10
Using an Extension Cable	10
Verifying 100W and 100WP Operation	11
Chapter 4 Installing the 100W and 100WP ERT Module	12
100W and 100WP ERT Module Mounting Accessories	12
100W and 100WP ERT Modules with Integral Connectors	13
Rod Mount Installation	13
Required Tools and Hardware	14
Wall Mount Installation	17
Required Mounting Tools and Hardware	17
Base Mount Installation	19
Required Mounting Tools and Hardware	19
Shelf Mount Installation	20
Required Tools and Hardware	21
Through Lid Mount	23
Through Lid Mount Required Tools and Hardware	23
Installing in a New Lid	26
Optional Leak Sensor Installation	26
Required Equipment	27
Pipe Preparation	30

Chapter 5 Optional Direct Connect Remote Antenna Installation	34
100W and 100WP ERT Module Models for use with Remote Antennas	34
Industry Canada Conformity	35
Installing the Remote Antenna.....	35
Appendix A Using an Inline Connector	39
Appendix B Using the Itron Splice Kit.....	41
Appendix C Troubleshooting	44
Index	45

Before You Begin

Document Conventions

Convention	Example
Itron product part numbers are noted in parentheses.	To install the ERT module (ERW-1300-XXX), do the following steps.
Hypertext links are in blue.	See How The Document is Organized on page 2 for document structure information.



Note A Note indicates neutral or positive information that stresses or supplements important points of the main text. A note supplies information that may apply only in special cases.



Caution A Caution advises users that failure to take or avoid a specified action could result in a loss of data.



Warning A Warning advises users that failure to take or avoid a specified action could result in physical harm to the user or the hardware.

Document Purpose

This document provides the installation instructions for the 100W and 100WP. Mounting options for the 100W and 100WP ERT module include rod mount, wall mount, through-lid (remote antenna), and shelf-mount installation. For available model configuration, see [100W and 100WP Models](#) on page 4.

An optional Itron Leak Sensor is available for all three configurations to provide leak monitoring capability. 100W and 100WP ERT module configurations provide an easy interface to several register types. The 20-inch cable variant allows meter manufacturers to mount the ERT module directly to their respective meter registers before delivery to the installer.



Caution Installing an integrated 100W or 100WP ERT module and meter register in a water pit box reduces the ERT module's RF signal distance significantly. If read reliability is a problem, install a remote antenna or select a new installation method.

How This Document is Organized

This document is organized into the following chapters:

Chapter	Description
1. Before You Begin	Information about this publication.
2. About the 100W and 100WP ERT module	Overview of 100W and 100WP ERT module installation.
3. Initializing, Connecting, and Programming the ERT Module	Instructions to initialize the 100W ERT module, program the 100WP ERT module, and connect the ERT modules to the water meter.
4. Installing the 100W and 100WP ERT module	Step-by-step ERT module installation instructions for: <ul style="list-style-type: none"> • Rod mount • Wall mount • Base mount • Shelf mount (kit CFG-1300-001) • Through lid mount • Optional Leak Sensor installation
5. Optional Direct Connect Remote Antenna Installation	Instructions for installing the optional remote antenna.
Appendix A Using an Inline Connector	Instructions for installing an inline connector.
Appendix B Using the Itron Splice Kit	Instructions for installing the Itron Splice Kit.
Appendix C Troubleshooting	Troubleshooting 100W and 100WP ERT module operation.

Related Documents

Document Description	Itron Part Number
<i>100W and 100G ERT Tamper Reference Guide</i>	TDC-1028-000
<i>Field Deployment Manager Endpoint Tools Mobile Application Guide</i>	TDC-0934-XXX
<i>Field Deployment Manager Field Representative's Guide</i>	TDC-0936-XXX
<i>900 MHz Belt-Clip Radio User's Guide</i>	TDC-0889-XXX
<i>FC300 Getting Started Guide</i>	TDC-0898-XXX
<i>FC200 Series Getting Started Guide</i>	TDC-0598-XXX
<i>Endpoint-Link® Programming Guide</i>	TDC-0744-XXX
<i>Water ERT Module Ordering Guide</i>	PUB-0063-001
<i>Water Meter Compatibility List</i>	PUB-0063-002
<i>mlogonline™ Network Leak Monitoring System User Guide</i>	TDC-0792-XXX



Note XXX designates the document revision and is subject to change without notice.

About the 100W and 100WP ERT Module

The 100W and 100WP ERT modules are high-power radio frequency automatic meter reading (AMR) devices that attach to water registers to collect consumption usage and tamper data the ERT module then transmits to a data collection device. The ERT module operates in both bubble-up mode and two-way mode.

The 100W and 100WP ERT modules ship in Factory Mode. The ERT modules acquire and transmit meter register data. The ERT module transfers meter data immediately if the unit is initialized or programmed with a handheld computer during installation (see [Initializing, Connecting, and Programming the ERT Module](#)).

The 100W and 100WP ERT modules support protocols for a variety of meter manufacturer's registers. Refer to the *Water Meter Compatibility List* (PUB-0063-002), for the list of supported meters and registers.

100W and 100WP ERT modules feature the following capabilities:

- **Leak Detection and Reverse Flow Detection.** 100W series ERT modules feature the same robust features as Itron's 60 series ERT modules to provide Leak Detection and Reverse Flow Detection. For more information about Leak Detection and Reverse Flow Detection, see the Itron white paper [Detecting Leaks and Reverse Flow with 60 Series Endpoints](#).
- **Communication Error Indicators.**
 - **Last Good Read (LGR Flag)** Indicates a communication error with the register.
 - 100W encoder ERT module
If this flag is set for 24 consecutive hours, it initiates a cut cable flag in the extended tampers.
The Last Good Read Flag automatically clears after the ERT module receives a successful read from the register.
 - 100WP pulser ERT module
If the Last Good Read Flag is set two consecutive times, it initiates a Cut Cable Flag in the extended tampers.
The Last Good Read Flag automatically clears after the ERT module receives a successful read from the register.
 -  **Note** Last Good Read Flag may be an indicator of a damaged register.
- **Extended Tamper Flag** (retrievable with two-way communication)
 - **Low Battery Warning.** The 100W and 100WP ERT modules include a battery life estimator. The estimator is based on the number of data packets sent at the various power levels and the age (self-discharge) of the ERT module. The low battery warning allows the utility to easily identify which ERT modules are nearing end-of-life in a mixed population and gives the opportunity to schedule replacement.

The low battery warning is a single flag set when the battery has less than 10% remaining capacity, typically 2 years life remaining Battery life is evaluated daily at midnight.

- **Cut Cable Flag**

- 100W encoder ERT module. The Cut Cable Flag sets if the LGR Flag is active for 24 hours.
- 100WP pulser ERT module. The Cut Cable Flag sets if the LGR Flag is active two consecutive times.
- The Cut Cable Flag remains active for 40 days in Mobile mode.
- The Cut Cable Flag remains active for 24 hours in Fixed Network mode.

100W and 100WP Models

100W and 100WP ERT Module Description	Itron Part Number
100W encoder, dual-port direct connect remote antenna and register integral connectors	ERW-1300-202
100W encoder, three-port direct connect remote antenna, Leak Sensor, and register integral connectors	ERW-1300-203
100W encoder, 5-ft. cable register connect, direct connect remote antenna integral connector	ERW-1300-205
100W encoder 5-ft. cable register connect, direct connect remote antenna and Leak Sensor integral connectors	ERW-1300-206
100W encoder, 20-in. cable register connect, direct connect remote antenna integral connector	ERW-1300-217
100W encoder, 20-in. cable register connect, direct connect remote antenna and Leak Sensor integral connectors	ERW-1300-218
100WP pulser dual-port direct connect remote antenna and register integral connectors	ERW-1300-208
100WP pulser, three-port direct connect remote antenna, Leak Sensor, and register integral connectors	ERW-1300-209
100WP pulser, 5-ft. cable, direct connect remote antenna integral connector	ERW-1300-211
100WP Pulser, 5-ft. cable, direct connect remote antenna and Leak Sensor integral connectors	ERW-1300-212
100WP pulser, 20-in. cable register connect, direct connect remote antenna integral connector	ERW-1300-219
100W pulser, 20-in. cable register connect, direct connect remote antenna and Leak Sensor integral connectors	ERW-1300-220



Note The 100W and 100WP ERT module works accurately with cable lengths up to 300 feet.

Battery Life

Powered by two non-replaceable, long-life lithium batteries, the 100W and 100WP ERT modules have an expected battery life of 20 years when the ERT modules operate in default Mobile or Fixed Network Operating mode. If the 100W and 100WP ERT module is programmed for Hard to Read Mobile mode, the battery life is reduced to 12 years. To pro-actively indicate the battery has reached a <10% useful battery life, a *Low Battery Flag* is set to indicate a low battery warning and alert the utility of an impending battery failure.

100W and 100WP Transmission Modes

The 100W and 100WP ERT module can be set to transmit in fixed network, mobile high power, mobile and handheld, or hard to read mobile and handheld mode.

- **Fixed Network Mode.** The 100W and 100WP ERT module transmits a high-powered NIM RF message every five minutes and a contingency SCM RF message every minute.
- **Mobile and Handheld Mode.** The 100W and 100WP ERT module transmits a medium-powered SCM RF message every 9 seconds.
- **(Optional) Mobile High Power Mode.** The 100W and 100WP ERT module transmits a high-powered SCM RF message every 60 seconds.
- **(Optional) Hard to Read Mobile Mode.** The 100W and 100WP ERT module transmits a high-powered SCM RF message every 30 seconds. *The hard to read mobile and handheld mode should only be used for exceptionally hard-to-read applications.*

Note The battery life is significantly affected in hard to read mobile mode. You may use the 900 MHz Remote Antenna to increase reading range.

An FCC license is not required to read 100W and 100WP ERT modules.

100W Operating Modes

1. Factory mode

- 100Ws ship from the factory in Factory Mode.
- The ERT module's transmitter is off.
- The ERT module's receiver bubbles-up to listen for a programming command.
- 100W encoder models attempt to read the register every hour.
- Last Good Read and Extended Tamper Flags may be set when a register is not connected.
- If the 100W reads a connected register, the ERT module automatically moves to Run Mode (100W only).

2. Run mode

- 100W normal operation mode.
- The 100W transmitted message is dependent on its factory settings or setting programmed with FDM for standard consumption messages (SCM) or network interval message (NIM).

For SCM (Mobile), the 100W default bubble-up rate is 9 seconds.

For NIM (fixed network), the 100W default bubble-up rate is five minutes. When the ERT module is set for NIM, the 100W transmits a contingency SCM message every minute. Program FN mode with a programming device to configure NIM mode.

3. Meter manufacturer quiet mode

- Meter manufacturers can configure the ERT module for quiet mode after initializing and direct mounting the 100W in the factory.
- The ERT module awakens from quiet mode and enters run mode in one of two ways:
 1. The 100W detects consumption at the top of the hour (last hourly interval >1 or <-1).
 2. The 100W receives a two-way command (for example, a **Read ERT** using FDM software).

100WP Operating Modes

The 100WP has three standard operating modes.

1. Factory mode

- 100WPs ship from the factory in factory mode.
- The 100WP's transmitter is off.
- The 100WP's receiver bubbles-up to listen for a programming command.
- Last Good Read and Extended Tamper Flags may be set when a register is not connected.
- You must program the 100WP with the initial consumption and the register type to properly move the ERT module to run mode and record consumption. You can program the 100WP in the field with FDM or in the factory using custom programming.

2. Run mode

- 100WPs normal operation mode.
- The 100W transmitted message is dependent on its factory settings or Field Deployment Manufacturer (FDM) programming for standard consumption messages (SCM) or network interval message (NIM).
 - For SCM (Mobile), the 100WP default bubble-up rate is 9 seconds.
 - For NIM (Fixed Network), the 100WP default bubble-up rate is five minutes. When the ERT module is set for NIM, the 100WP transmits a contingency SCM message every minute. NIM mode is configured by programming NIM mode with a programming device.

3. Meter manufacturer quiet mode

- Meter manufacturers can configure the 100WP for quiet mode after programming and direct mounting the 100WP in a factory.
- The 100WP is awakened from quiet mode and enters run mode in one of two ways:
 - Counting two pulses. The pulses are counted internal to the 100WP while it is in quiet mode.
 - Receiving a two-way command, such as a **Read ERT** using FDM.
- If an ERT module installed in quiet mode is not bubbling up SCM or NIM messages, it may be due to zero consumption on the ERT module, such as a vacant or vacation home. Initiate a two-way command (for example, perform a **Read ERT** with FDM) before removing the unit.

Initializing, Connecting, and Programming the ERT Module

This chapter provides the instructions to initialize and start up the 100W, program and start up the 100WP, and connect the 100W or 100WP ERT module.

Initializing the 100W



Caution To obtain an immediate reading, initialize the 100W with an approved handheld computer. Failure to initialize the ERT module may delay the initial reading up to one hour.

- To initialize the 100W immediately, use one of the following handheld computers running Field Deployment Manager (FDM) version 1.0 or later.
 - FC200SR handheld computer (Itron part number FC2-0005-004 or FC2-0006-004)
 - FC300 with SRead
- For normal activation, connect the 100W to the water meter register. The ERT module polls for a register every hour. The 100W automatically activates after the ERT module detects a register.

100W Encoder Start-up

The 100W automatically:

- Detects the connected register type at the top of the hour, exits factory mode, and enters run mode (programming is not required for the 100W to initiate run mode in the default mobile mode).
- Detects an Itron Leak Sensor.

100W encoder programming is required to:

- Change the operation mode (for example, to change the ERT module from the default mobile mode to fixed network mode).
- Enter a Utility ID or Lock Type.
- To enter an E-Coder 8-digit driver.

Itron strongly recommends performing a **Check ERT** with a handheld computer running FDM to verify the ERT module is operating correctly after installation. Performing a **Check ERT** will:

- Generate an immediate register read.
- Align the 100W's time with the handheld's time.

Important Periodically dock or cradle the handheld computer or mobile reader to keep the time current.

- Verify communication with the Leak Sensor.
- Check for tamper flags.

Programming the 100WP

Programming the 100WP requires one of the following handheld computers running Field Deployment Manager (FDM) version 1.0 or later.

- FC200SR handheld computer (Itron part number FC2-0005-004 or FC2-0006-004)
- FC300 with SRead

For normal activation, connect the 100WP to the water meter register and program the ERT module with FDM.

100WP Pulsar Start-up

The 100WP enters Run mode by completing programming with FDM. Programming sets the appropriate pulser parameters (initial consumption and Utility ID).

Itron strongly recommends performing a **Check ERT** with a handheld computer running FDM to verify the 100WP is operating correctly after installation. Performing a **Check ERT** will:

- Generate an immediate register read.
- Align the 100WP's time with the handheld's time.

Important Periodically dock or cradle the handheld computer or mobile reader to keep the time current.

- Verify communication with the Leak Sensor.
- Check for tamper flags.

Connecting to a Meter Register Using the Inline Connector

The inline connector system easily allows a separation between the ERT module and meter register and provides for general maintenance or system troubleshooting (see [Using an Inline Connector](#) on page 39).

Connecting to a Meter Register Using a Cable

You may connect the 100W and 100WP ERT module to the water meter register using the 5-foot or 20-inch flying leads cable.



Caution ERT module wire terminations must be properly sealed with a non-conductive gel material to prevent water intrusion (otherwise, this configuration should not be used in a pit box environment). Itron recommends the 5-foot or 20-inch cable configuration for OEM users only.

To connect the 100W to the register

Connect the wires from the 100W ERT module to the register screw terminals according to the following table.

Register Manufacturer	100W wire color		
	Red (data)	Black (power/clock)	White (ground)
	Register screw terminal		
Elster AMCO Invision	R	G	B
Elster AMCO Scancoder	R	G	B
Elster AMCO evoQ4 (Q4000)	R	W	B
Hersey Translator	G	R	B
Badger ADE	G	R	B
Sensus ECR	G	R	B
Sensus ICE	G	R	B
Metron Farnier	G	R	B
Itron (Actaris) Coder	G	R	B
Neptune ProRead E-Coder ARB-V	R	B	G
Performance ETR	G	R	B
Severn Trent SM700 SmartMeter (Sensus Protocol)	G	R	B

Caution Wrap the wire one complete revolution around the register screw.

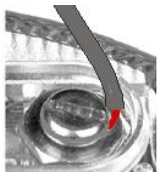

Completely tighten the register screw and verify the wire insulation is not under the screw terminal heads or intermittent electrical connection may occur. You must use a moisture-proof sealant if the meter is installed outdoors or in an environment where moisture can collect on the screw terminals.

Connect the ERT module to the register cable using the Itron Splice Kit (see [Using the Itron Splice Kit](#) on page 41).

Connecting the 100WP to a Remote Meter Register

Connect the wires from the 100WP ERT module to the register screw terminals according to the following table.

Register Manufacturer	100WP wire color		
	Red (signal)	Black (common)	White (tamper)
	Register screw color designator		
Elster Digital	BLK	GRN	R
Itron (Actaris) Cyble Sensor (2-wire)	Either wire	Remaining wire must be connected to both ERT module wires	
Badger RTR	R	BLK	Green/bare
Elster V100	BLK	R	Blue
Sensus PMM	R	BLK	Bare

Caution Wrap the wire one complete revolution around the register screw.



Completely tighten the register screw and verify the wire insulation is not under the screw terminal heads or intermittent electrical connection may occur. You must use a moisture-proof sealant if the meter is installed outdoors or in any environment where moisture can collect on the screw terminals.

Connect the ERT module to the register cable using the Itron Splice Kit (see [Using the Itron Splice Kit](#) on page 41).

Using an Extension Cable

Order the 25-foot inline connector extension cable assembly (CFG-0151-401) to extend the 100W with the inline connector.

Verifying 100W and 100WP Operation

Use one of the following handheld computers to verify consumption:

- FC200SR handheld computer (Itron part number FC2-0005-004 or FC2-0006-004)
- FC300 with SRead



Notes

- Each handheld radio requires special setup and configuration parameters to successfully read and program 100W and 100WP ERT module products. Refer to the respective meter reading application for specific instructions.
- When comparing the actual register value to that reported by the 100W and 100WP ERT module, please keep in mind the ERT module's consumption value is updated once an hour when it is in a Run Mode.



Caution Do not use ReadOne Pro, FS2PN, FS3PN, or FC200R readers to read the 100W and 100WP ERT module. These readers do not operate their receivers long enough or at the right frequency to reliably capture a 100W and 100WP ERT module transmission.

Installing the 100W and 100WP ERT Module

Install the 100W and 100WP ERT module using one of the following methods:

100W and 100WP Mounting Options

Rod mount	The ERT module mounts on a 1/2-inch outside diameter rod.
Wall mount	The ERT module mounts to a wall or other vertical surface.
Base mount	The ERT module mounts on a horizontal, flat surface.
Shelf Mount	The ERT module mounts in pre-fabricated pockets or shelves within the pit lid using a shelf mount accessory kit.
Through Lid	The ERT module mounts in lids with hole sizes from 1-3/4 inches to 2-inches. Through-lid installation requires the Pit Lid Mounting Kit (CFG-1300-004).

For water pit boxes, the type of installation method is based on two factors: the lid material and the current lid configuration. Metal lids may require a through-lid remote mount antenna for optimal ERT module radio performance. Plastic lids and other composite materials accept any installation methods described above. The 100W and 100WP ERT modules are temperature rated from -20° C to +60° C. Do not install the 100W and 100WP ERT module in locations that may exceed the temperature rating.



Caution Observe the following guidelines for mounting the 100W and 100WP ERT module:

- ERT module positioning other than upright could negatively affect radio performance and battery life.
- Use only Itron-approved splice kits or inline connectors.

100W and 100WP ERT Module Mounting Accessories

100W/100WP Mounting Accessories

Accessory	Part Number
Remote Antenna Kit (mobile applications only)	CFG-0900-003
Shelf Mount Kit	CFG-1300-001
Pit Lid Mounting Kit	CFG-1300-004
100W ERT Module Universal Environmental Cap	MSC-0019-008
Itron Security Seal	MSC-0018-001



Caution Shield unconnected ERT module ports on field installed modules with the universal environmental cover. Do not leave an exposed connector in the field. Environmental caps employ multiple seals to increase cap life.

100W and 100WP ERT Modules with Integral Connectors

If 100W and 100WP ERT modules with integral connectors (ERW-1300-X0X) and the registers are not installed at the same time, secure the protective connector cover on the ERT module using an Itron Security Seal (Itron part number MSC-0018-001). Cable ties are not shipped with the 100W and 100WP ERT module, but can be ordered from Itron. Use the protective cover (on the ERT module side) in the field for up to one year.



Warning If a three-port 100W and 100WP ERT module is installed but the Leak Sensor is not attached, the environmental cap (MSC-0019-008) must remain in place on the blue connector (Leak Sensor connector) to protect the connector from damage.

To install a security seal (MSC-0018-001) through the protective connector cover

1. Align the protective cover and connector security seal holes.
2. Insert the security seal pointed end through the security holes in the connector and protective cover.
3. Insert the pointed end of the security seal into the cap end and push until the seal locks.



Rod Mount Installation

100W and 100WP ERT modules can mount below the pit lid on a customer-supplied 1/2-inch OD rod. The example installation described in this section uses a fiberglass rod. For more information, visit www.itron.com and reference the *Water Meter Compatibility List* (PUB-0063-002).



Warning The rod installation area must be free from other pipes, wires, or facilities that may be damaged by driving a rod into the ground.



Caution You must follow local codes when using the rod mount installation method. Failure to use 1/2-inch rod and follow instructions may result in an unreliable installation.

Observe the following guidelines for mounting the 100W and 100WP ERT module using the wall mount procedure:

- ERT module positioning other than upright could negatively affect radio performance and battery life.
- Use only Itron-approved splice kits or inline connectors.

Required Tools and Hardware

- Hammer
- 1/2-inch outside diameter rod (you may use either a square or round rod)
- Tape measure
- Rod-driving tool (optional)
- Rod cutting tool

The 1/2-inch diameter rod hole is shown in the following 100W and 100WP ERT module bottom and side views.

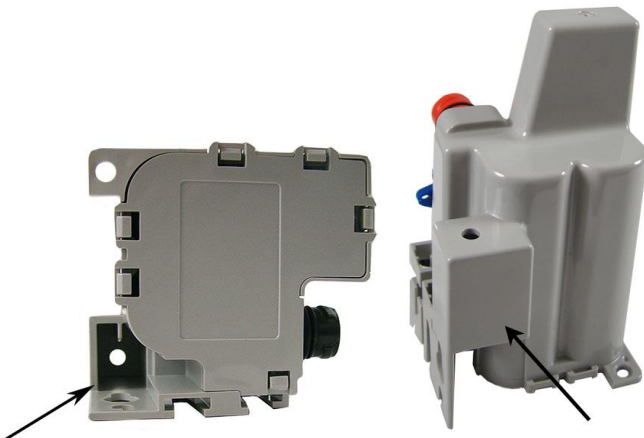

To install the 100W and 100WP ERT module on a rod

1. Remove the pit lid. Inspect the area to make sure there are no buried cables, pipes, or other obstructions.
2. Measure the pit box depth from the top of the lip (where the lid will rest) to the bottom of the pit. Be sure to measure the depth at the point where you will drive the rod into the ground.
3. Add 12 inches to the pit box depth measurement taken in step 2. The resulting total represents the minimum length of rod needed. Soil types and moisture conditions may require longer rod lengths to ensure the ERT module is well supported and remains vertical.

- Without touching the meter body or adjacent pipes, position the rod as close to the center of the pit as possible. Drive the rod into the ground. Ensure the rod remains vertical.



Note The rod shown has an end cap to protect the rod while driving it into the ground.

- Drive the rod into the ground so the top of the rod is approximately 3-1/2 inches below the bottom of the pit lid.
 - If you cannot drive the rod in enough to equal the necessary spacing, cut the remaining rod length to the proper height using an abrasive cut-off tool.

Caution Cutting fiberglass creates dust particles. Practice proper safety precautions when using cut-off tools to prevent exposure to fiberglass dust particles.

- If the rod is the correct depth but remains loose in the soil, replace the rod with a longer version.

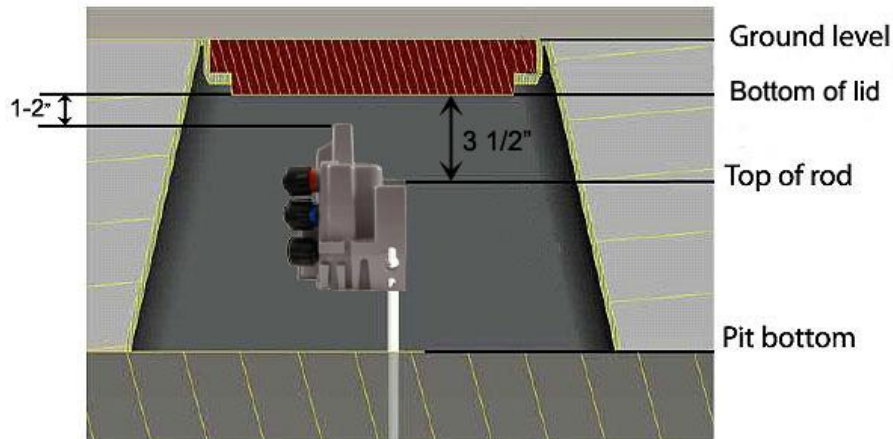

- The top of the rod must be 3-1/2 inches below the bottom of the lid. Place the ERT module on the rod. Completely insert the rod into the ERT module's rod mount hole. Do not force the ERT module onto the rod. If the ERT module does not slide freely on the rod, remove the ERT module and examine the ERT module rod hole and rod for burrs or obstructions. You may secure the ERT module to the rod with a self-drilling screw through the hole in the top of the ERT module's rod mount cavity. The screw mounting hole is shown in the following product image.



- Installation is complete when the ERT module is perpendicular to the underside of the lid. The ERT module must not contact the pit structure or lid.

Caution Verify the pit lid does not touch the ERT module when the lid is replaced. There must be a 1 to 2-inch space between the top of the ERT module and the bottom of the pit lid. If the ERT module is installed too high, too low, or is touching any of the surrounding surfaces, adjust as necessary.



Wall Mount Installation

Select a flat vertical mounting surface. Install the ERT module in an upright position. Locate the ERT module as high as possible. To mount the ERT module to the wall in a water pit box, select a mounting location on the inside of the pit box and try to maintain a distance of one to two inches from the bottom of the pit box lid.



Caution Observe the following guidelines for mounting the ERT module using the wall mount procedure:

- ERT module positioning other than upright could negatively affect radio performance and battery life.
- Do not use gel connectors in pit environments.
- Use only Itron-approved splice kits or inline connectors.

The ERT module works accurately with Itron-approved cable type and lengths up to 300 feet.

Required Mounting Tools and Hardware

- Drill and drill bits appropriate for mounting location material.
- Common hand tools for the selected fastening method.
- Mounting screws: #10 size pan head screws appropriate for the wall or pit box material.

To install the 100W and 100WP ERT module using the wall mount procedure

1. Select a vertical surface in the pit box or on a wall (for example, an ERT module mounted in a basement).
2. Position the ERT module vertically so the top of the ERT module is between 1 and 2-inches below the bottom of the lid.
3. Mark the location of the top mounting hole.

4. Drill a pilot hole in the pit box wall. Follow the screw manufacturer's recommendation for the pilot hole size.
5. For concrete-type pit boxes, it may be necessary to use a screw anchor. Choose an anchor appropriate for a #10 pan head screw.

Caution Do not over-tighten the mounting screws. Over-tightening the mounting screws may break the ERT module mounting tabs.

6. Start a screw into the pilot hole. Using the top hole of the ERT module, set the ERT module over the screw head and slide it down so the screw is now at the top of the notch (as shown). Carefully tighten the screw until snug. Over-tightening the mounting screw could crack the ERT module housing.



Note If mounting requires a screw anchor, mark the location of the bottom anchor and remove the ERT module. Drill the required mounting hole, insert the anchor, and re-attach the ERT module.

7. Holding the ERT module in the upright position, drill the second pilot hole. Use the bottom mounting hole as a template.

Caution Any ERT module position other than upright may negatively affect radio performance and battery life.

8. Screw the bottom screw into the pilot hole until snug. Do not over-tighten the mounting screw.



Base Mount Installation

The ERT module may be mounted to a flat surface using the base tab.



Caution Observe the following guidelines for mounting the ERT module using the wall mount procedure:

- ERT module positioning other than upright could negatively affect radio performance and battery life.
- Use only Itron-approved splice kits or inline connectors.

Required Mounting Tools and Hardware

- Drill and drill bits appropriate for mounting location material.
- Common hand tools for the selected fastening method.
- Mounting screws: #10 size pan head screws appropriate for the wall or pit box material.

To install the 100W and 100WP ERT module using the base mount procedure

1. Select a flat surface.
2. Position the ERT module vertically.
3. Mark the mounting-hole location.
4. Drill a pilot hole in the mounting location material. Follow the screw manufacturer's recommendation for the pilot hole size.

5. Position the ERT module and insert a #10 pan head screw in the base mounting tab. Carefully tighten the mounting screw until the ERT module is secure.

Caution Do not over-tighten the mounting screws. Over-tightening the mounting screws may break the ERT module mounting tabs.



Shelf Mount Installation

This section describes 100W and 100WP ERT module installation using a shelf mount adapter to mount the ERT module in a pit lid slot.



Caution Observe the following guidelines for mounting the ERT module using the shelf mount procedure:

- ERT module positioning other than upright could negatively affect radio performance and battery life.
- Use only Itron-approved splice kits or inline connectors.

The pit lid and slot must have the correct dimensions for the ERT module assembly to fit properly.

The following illustration and the accompanying table give pit lid slot dimensions for the shelf mount installation method.

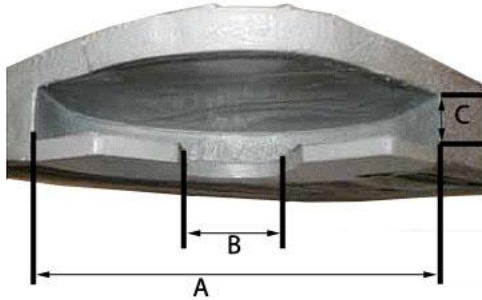

Pit Lid Slot Dimensions		
Dimension	Minimum (inches)	Maximum (inches)
A	6 3/4	N/A
B	2	5 3/4
C	3/4	1

Required Tools and Hardware

Itron 100W Shelf Mount Kit

To install using the shelf mount adapter

1. With the foam spacers facing up, insert the shelf mount adapter into the opening in the disk.



2. Push the adapter into the opening gently until the adapter snaps into place. Insert the shelf mount adapter into the ERT module antenna slot pushing firmly with your thumb until the adapter tab locks into place in the ERT module antenna slot opening.



3. Slide the adapter assembly into the pit lid with the foam spacers positioned on each side of the pit lid slot.



Correct position for foam spacers



Caution Do not install the adapter assembly in a manner that provides little or no support under disk's edge.



Incorrect mounting position for foam spacers.

- The installed ERT module position must be vertical and upright when the lid is replaced on the pit.

Caution When placing the pit lid on to the pit box after the shelf mount adapter installation, use care to avoid pinching or damaging the ERT module to meter cable. Any ERT module position other than upright may negatively affect radio performance and battery life.

Through Lid Mount

This section provides instructions to mount the 100W and 100WP ERT module in a pit lid with a drilled, round 1-3/4-inch, 1-7/8-inch, or 2-inch hole.



Caution Some pit lids have a molded, recessed cavity that allows Itron 40W-1, 50W-1, and 50W-2 ERT modules to sit flush with the top surface of the lid. However, the dome of the ERT module retainer for the 100W or 100WP ERT module has a smaller diameter and does not fill the pit lid cavity. This can cause the cavity to become a trip hazard. Itron does not recommend using this type of pit lid with 100W and 100WP ERT modules.

Through Lid Mount Required Tools and Hardware

This mounting method requires the Pit Lid Mounting Kit. Refer to the 100W Installation Methods Overview (PUB-1300-004) for guidance on which kit to install for different pit lid material and traffic conditions.

Pit Lid Mounting Kit (CFG-1300-004)



Note The Pit Lid Mounting Kit is not intended for applications involving vehicular traffic. Use the Remote Antenna Kit in incidental traffic areas (such as residential environments).

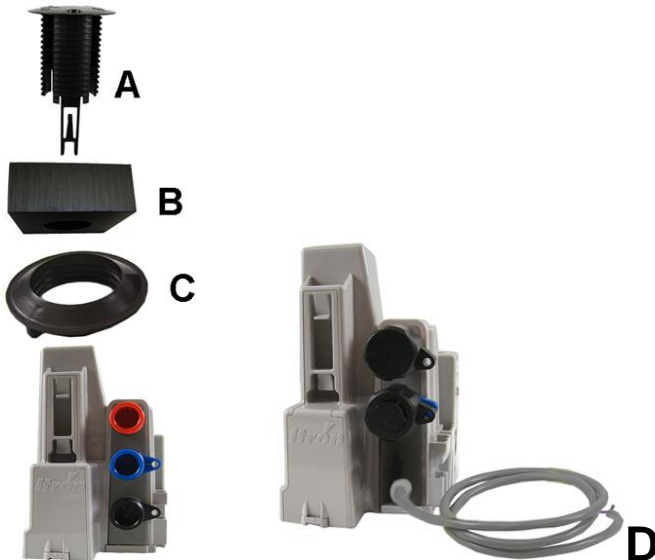

- A Retainer clip
- B Pit lid with a pre-drilled hole
(simulated pit lid material shown)
- C Retainer clip collar
- D 100W and 100WP ERT module

To install in lids with holes using the Pit Lid Mounting Kit (CFG-0771-011)

1. Verify you have the required items to complete the installation.
2. Insert the retainer clip into the pit lid hole with the convex surface on the top of the pit lid.



3. From the bottom side of the lid, screw on the threaded retainer clip collar until the beveled top rests against the pit lid.

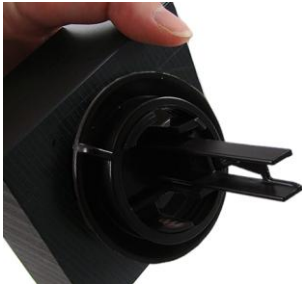

Note Ensure the beveled edge of the clip collar is toward the top of the pit lid.

4. Align and insert the retainer clip tab into the retainer clip receptacle on the ERT module housing.



5. Verify the clip locks into place in the housing.



Caution Carefully align the ERT module through lid assembly. If the assembly is improperly aligned, the pit lid may not close.

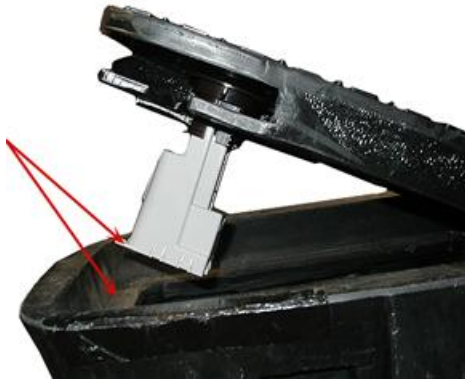

Pit Lid Mounting Kit installation is complete.

Installing in a New Lid

This section describes installation of the 100W and 100WP ERT module in a pit lid without a drilled hole.

To install the 100W in new lids

1. Select a hole location with enough clearance on the bottom side of the lid to attach the threaded clip collar.
2. Drill a 1-3/4 inch hole in the lid.
3. See [To install in lids with holes using the Pit Lid Mounting Kit](#) on page 24 to complete installation in a new lid.

Optional Leak Sensor Installation

Leak Sensors (LS) analyze water flow sound patterns to detect new, evolving, and pre-existing leaks. LS analysis data is uploaded to mlogonline™ Network Leak Monitoring for data analysis and accessed through a secure Internet portal unique to your utility. This section describes installation of the Leak Sensor (LS) in a 100W and 100WP ERT module system.

The ERT module stores 20 days of Leak Sensor data. On the 21st day, the ERT module begins to write over stored data in a first in, first out manner.

The ERT module automatically detects the presence of connected Leak Sensors. The ERT module will automatically detect the Leak Sensor within 22.5 minutes and begin reading Leak Sensor data. To immediately detect the Leak Sensor and begin reading data, perform a **Check ERT** with a handheld computer running FDM software.

The LS is used in conjunction with both indoor (basement) and outdoor (mounting on the exterior of the house) 100W and 100WP ERT module installations. LS devices are mounted on a water service pipe or meter insetter (meter horn) and connect to the Leak Sensor connector on the ERT module as described in [To connect the Leak Sensor to the 100W and 100WP ERT module](#) on page 28. The mounting bracket shipped with the Leak Sensor accommodates an (up to) 1-1/2-inch OD pipe. An optional mounting bracket is available for pipe sizes (up to 2 1/2-inch OD).

Leak Sensor Installation Equipment

Equipment	Itron Part Number	Description
Leak Sensor	LDS-0001-002	LS with inline connector, environmental connector cap; 5-foot cable, and mounting bolt (fits up to 1 1/2-inch OD pipe).
Optional mounting bracket	CFG-0349-002	Mounting bolt fits up to 2 1/2-inch OD pipe.
ERT module		
100W three-port encoder ERT module	ERW-1300-203	Three-port encoder ERT module for connection to register, Leak Sensor, and optional remote antenna.
100W, 5 ft. flying leads, three-port encoder ERT module	ERW-1300-206	Three-port encoder ERT module for connection to register using 5 ft. flying leads, Leak Sensor and optional remote antenna connection with inline connectors.
100W, 20-in. flying leads, three-port encoder ERT module	ERW-1300-218	Three-port encoder ERT module for connection to register using 20-in. flying leads, Leak Sensor, and optional remote antenna connection with inline connectors.
100WP three-port pulser ERT module	ERW-1300-209	Three-port pulser ERT module for connection to register, Leak Sensor, and optional remote antenna.
100WP, 5 Ft. flying leads, three-port pulser ERT module	ERW-1300-212	Three-port pulser ERT module for connection to register using 5 ft. flying leads, Leak Sensor and optional remote antenna connection with inline connectors.
100WP, 20-in. flying leads, three-port pulser ERT module	ERW-1300-220	Three-port pulser ERT module for connection to register using 20-in. flying leads, Leak Sensor and optional remote antenna connection with inline connectors.
25-foot extension cable (optional)	CFG-0349-101	25-foot cable with coordinating connectors (LS blue connector, register black connector).
100W universal environmental replacement cap	MSC-0019-008	Protects Leak Sensor connector when the Leak Sensor is not connected to the 100W ERT module.
Itron Security Seal	MSC-0018-001	Indicates module tampering and ensures the protective cover stays intact.



Leak Sensor

Standard mounting bracket

100W three-port

100W 20-in. cable

Optional mounting bracket



Warning When the 100W or 100WP is installed but the Leak Sensor is not attached, you must protect the blue Leak Sensor port with the environmental cap (MSC-0019-008). If you remove the Leak Sensor from the ERT module, the environmental cap must be replaced to protect the connector.

To connect the Leak Sensor to the 100W and 100WP ERT module

Caution Verify you have the correct 100W or 100WP ERT module. Leak Sensors must mount to Port B (middle blue port) of the ERT module. Connecting the LS to Port A (bottom port) or Port C (top port) will cause electrical damage to the LS and ERT module.

1. Remove the environmental cap from the ERT module's blue connector (B).

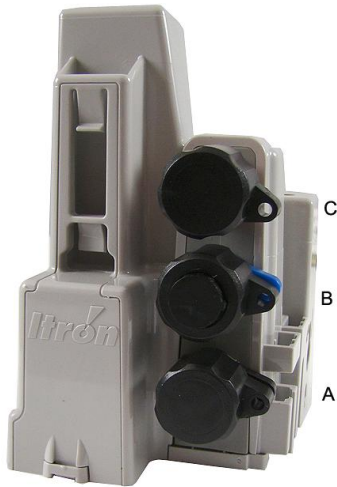

- C. **Red** connector: Optional antenna connection
- B. **Blue** connector: Leak Sensor connection
- A. **Black** connector: register connection

2. Remove the environmental cap from the Leak Sensor connector. Verify the connectors (the ERT module's LS connector and the Leak Sensor connector) are clean and dry.



3. Align the Leak Sensor connector with the ERT module's blue connector and insert.

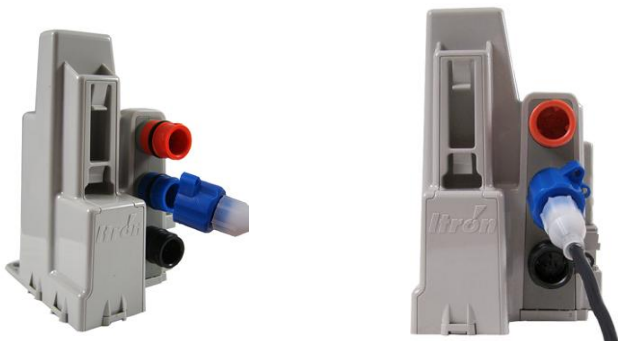

4. Rotate the connector locking ring until the security holes align.



Caution Do not force the connector ends together. While holding the LS connector, engage the ERT module's connector by rotating the locking ring until both connectors securely connect. Twist only the connector locking ring, not the body of the connector. Twisting the connector body could damage the connector's pins.

To attach an Itron security seal (MSC-0018-001) through the connector security hole

1. Insert the pointed end of the security seal through the inline connector and the ERT module connector security holes.



2. Insert the pointed end of the security seal into the capped end and push until the seal locks.



This completes the ERT module and Leak Sensor connections.

Pipe Preparation

Clean any dust or dirt from the pipe to facilitate direct contact with the LS surface.

To install the Leak Sensor on a pipe or meter insetter

1. Select a Leak Sensor mounting location within 5-feet of the ERT module. Mount the sensor on the water input side of the meter.

Caution Mount the Leak Sensor on the water input side of the meter. Failure to follow this mounting requirement could result in errors in the leak detection data. Installation requires Itron mounting hardware. Repair costs and service charges relating to the use on non-compliant mounting hardware will be charged to the customer. Contact Itron Support for more information.

2. Verify the pipe's mounting surface is free from dirt and debris. Place the curved surface of the LS against the pipe.



3. Insert the mounting U-bolt over the pipe and into the LS mounting holes.

Caution Do not mount the Leak Sensor on a pipe coupler, joint, or nut.



4. Insert the mounting plate over the U-bolt's threaded screw ends. Attach the two wing nuts over the clamp screw ends and tighten the wing nuts until snug (to a minimum of 5-inch pounds) to prevent device rotation on the pipe. After you tighten the second wing nut, check the Leak Sensor to verify the device is snug. If the sensor moves, tighten the wing nuts until there is no movement.

Caution Do not tighten the Leak Sensor to more than 20 inch-pounds. Over-tightening could damage the Leak Sensor housing and/or the pipe.



Note Leak Sensor mounting orientation is not critical. Orient the sensor to best accommodate your installation. The most important installation practice is to mount the sensor securely to the pipe.



To install the Leak Sensor on a pipe (up to 2 1/2-inch OD)

1. Select a Leak Sensor mounting location within 5 feet of the ERT module.

Note Leak Sensor mounting orientation is not critical. Orient the sensor to best accommodate your installation. The most important installation practice is to fasten the sensor securely to the pipe.

Caution Mount the Leak Sensor on the water input side of the meter. Failure to follow this mounting requirement could result in errors in the leak detection data. Installation requires Itron mounting hardware. Repair costs and service charges relating to the use on non-compliant mounting hardware will be charged to the customer. Contact Itron Support for more information.

2. Insert the mounting plate screws into the holes on the Leak Sensor's curved surface.



3. Secure the mounting plate to the Leak Sensor.



4. Verify the pipe's mounting surface is free from dirt and debris. Place the curved surface of the LS against the pipe.

Caution Do not mount the Leak Sensor on a pipe coupler, joint, or nut.

5. Insert the U-bolt around the pipe and into the holes in the plate/Leak Sensor assembly. Secure the U-bolt with the wing nuts. Tighten the wing nuts until snug (to a minimum of 5-inch pounds) to prevent device rotation on the pipe. After the second wing nut is tightened, check the Leak Sensor to verify the device is snug. If the sensor moves, tighten the wing nuts until there is no movement.



Caution Do not tighten the Leak Sensor to more than 20 inch-pounds. Over-tightening could damage the Leak Sensor housing and/or the pipe.

Optional Direct Connect Remote Antenna Installation

The optional 900 MHz remote mount antenna provides increased RF range coverage for the listed mobile applications where the meters are located deep in a pit boxes.

This section provides antenna mounting instructions through a pit lid and the instructions to connect the optional antenna to the ERT module.



Caution Only remote antenna ERT modules can be used with the remote antenna. See the following table for 100W and 100WP remote antenna ERT models.

100W and 100WP ERT Module Models for use with Remote Antennas

100W and 100WP ERT Module Description	Itron Part Number
100W encoder ERT module with optional remote antenna and register integral connectors	ERW-1300-202
100W encoder ERT module with optional remote antenna, Leak Sensor, and register integral connectors	ERW-1300-203
100W 5-ft. flying leads encoder ERT module with optional remote antenna integral connector	ERW-1300-205
100W, 5-ft. flying leads, encoder ERT module with optional remote antenna and Leak Sensor integral connectors	ERW-1300-206
100W 20-in. flying leads encoder ERT module with optional remote antenna integral connector	ERW-1300-217
100W 20-in. flying leads encoder ERT module with optional remote antenna and Leak Sensor integral connectors	ERW-1300-218
100WP pulser ERT module with optional remote antenna and register integral connectors	ERW-1300-208
100WP pulser ERT module with optional remote antenna, Leak Sensor, and register integral connectors	ERW-1300-209
100WP 5-ft. flying leads pulser ERT module with optional remote antenna integral connector	ERW-1300-211
100WP 5-ft. flying leads pulser ERT module with optional remote antenna and Leak Sensor integral connectors	ERW-1300-212
100WP 20 in. flying leads pulser ERT module with optional remote antenna integral connector	ERW-1300-219
100WP 20 in. flying leads pulser ERT module with optional remote antenna and Leak Sensor integral connectors	ERW-1300-220



Industry Canada Conformity

This radio transmitter (IC:864D-100WC) has been approved by Industry Canada to operate with the antenna types listed below with the maximum permissible gain and required antenna impedance for each antenna type indicated. Antenna types not included in this list, having a gain greater than the maximum gain indicated for that type, are strictly prohibited for use with this device.

Le présent émetteur radio (IC: 864D-100WC) a été approuvé par Industrie Canada pour fonctionner avec les types d'antenne énumérés ci-dessous et ayant un gain admissible maximal et l'impédance requise pour chaque type d'antenne. Les types d'antenne non inclus dans cette liste, ou dont le gain est supérieur au gain maximal indiqué, sont strictement interdits pour l'exploitation de l'émetteur.

Specification

Part number	CFG-0900-003
Gain	6.9 dBi
Horizontal beamwidth	Omni-directional
Impedance	50 ohms
Termination	Proprietary

Installing the Remote Antenna

Metal lids on water pit boxes require a through-lid solution for optimal ERT module radio performance. The remote antenna is designed to fit in a pit lid hole with a diameter of 3/4-inch and lid thicknesses from 1/4-inch to 1-3/4-inch.



Caution Remove cable or twist ties from the antenna cable to prevent damage to the ERT module or antenna.

To install the remote antenna through a pit lid

1. Thread the remote antenna connector and cable through the pit lid hole. Verify the antenna's convex surface is on the top of the pit lid. (These instructions show a simulated pit lid material.)



2. Insert the antenna connector through the rectangular opening in the threaded collar.



3. Turn the threaded collar until it is tight against bottom of the pit lid.

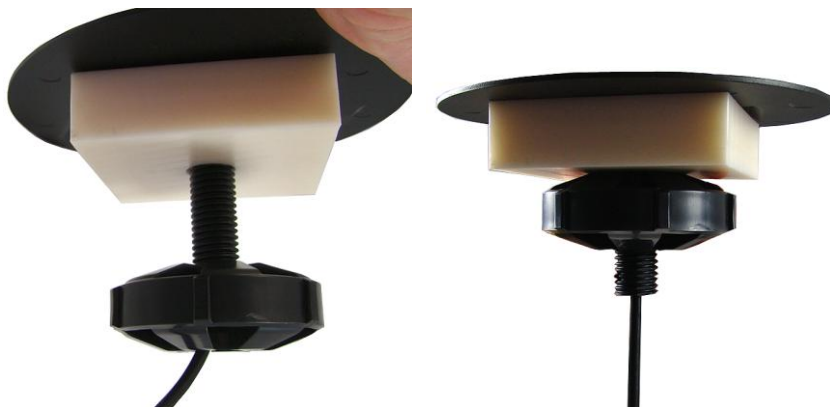

To connect the remote antenna to the ERT module

1. Align the connector pins with the top, red connector on the ERT module. The illustration shows a 3-port ERT module connection.



2. Push in the antenna connector to complete the connection. The illustration shows a two-port ERT module connection.



3. Turn the connector lock clockwise to secure the connection.

Caution Turn the connector lock-ring only. Do not twist the completed connection. Twisting the connection could damage the ERT module or antenna connector pins.



4. Follow the [Rod Mount Installation](#) on page 13 or [Wall Mount Installation](#) on page 17 instructions to mount the ERT module.



Remote antenna installation is complete.

APPENDIX A

Using an Inline Connector

This section describes the 100W connections to the water meter register using the inline connector assembly. Follow the manufacturer's recommended procedure for installing the water meter register on the meter.

To connect the inline connector

Note If an inline connector is not used and the ERT module is already connected to the water meter register, skip this step.

1. Remove the protective cover from the connector by twisting the two halves in opposite directions. Pull the halves apart.

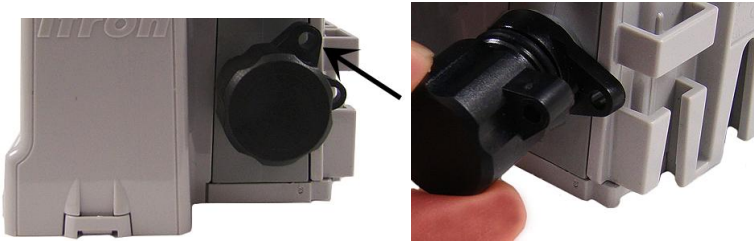

Caution Verify the connector halves are clean and dry before assembly.

If any of the following conditions occur, do not install the ERT modules:

- Any of the three pins are damaged or missing.
 - The O-ring is missing.
 - The cable is cut or nicked.
-

2. Connect the register cable to the ERT module connector:
 - Holding the connectors by the black shells, rotate one end to align the keyed slots.
 - Push until snug.
 - Slide the black coupling nut over the O-ring. Make sure the O-ring stays seated. (If the O-ring does not stay seated, disconnect and repeat this step.)
 - Twist the register cable's black coupling nut to align the two tabs.



3. Install the security seal as shown. Push it until it snaps into place.

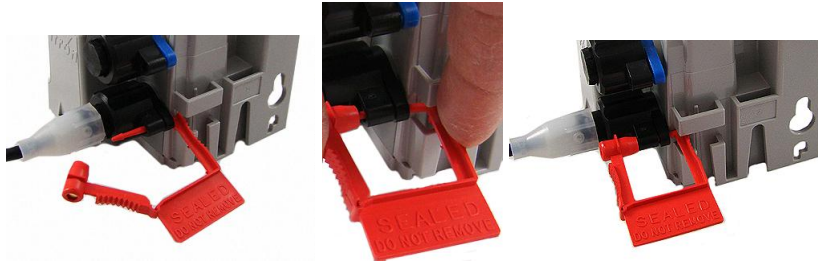

Note For future meter or ERT module servicing, break the security seal by pulling the seal apart. The original protective connector covers can be reused if kept clean and dry. Install a new security seal after servicing either device. To order replacement security seals, see the *Water ERT Module Ordering Guide* (PUB-0063-001).

Caution Shield connectors with protective environmental covers (see [100W and 100WP ERT Module Mounting Accessories](#)). Do not leave an exposed connector in the field.

Environmental caps employ multiple seals to increase cap life. Environmental cap design allows utilities to install the ERT module and install a Leak Sensor or optional remote antenna at a future date.

APPENDIX B

Using the Itron Splice Kit

This section describes connecting the 100W and 100WP ERT module with flying leads to the water meter register using the Itron Splice Kit.



Caution ERT module wire terminations must be properly sealed with a non-conductive gel material to prevent water intrusion (otherwise, this configuration should not be used in a pit box environment). Itron recommends the 5-foot or 20-inch cable configuration for OEM users or replacement installations only.

Required Materials

- E-9R 3M® gel cap crimping tool
- Itron Splice Kit (OEM-0034-002)
- 100W or 100WP with flying leads



1. Push the corresponding register and ERT module wires as far as possible into the gel cap connector.



Caution Do not strip insulation from the ends of the wires before inserting them into the connector.

2. Carefully place the connector and wires into the jaws of the crimping tool. Make sure the wires remain fully inserted in the gel-cap connector.

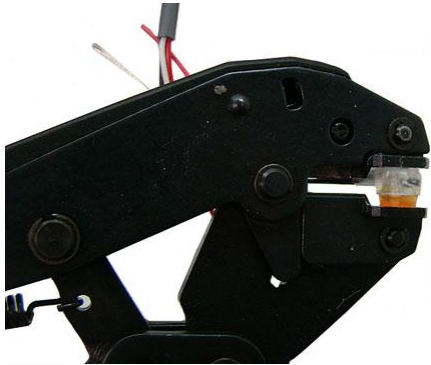

3. Crimp the connector by squeezing the handles until the connector cap is fully seated. Continue to apply pressure for three seconds.



4. A connector is crimped properly when the top of the movable yellow center (1) is flush with the top of the connector body (2).

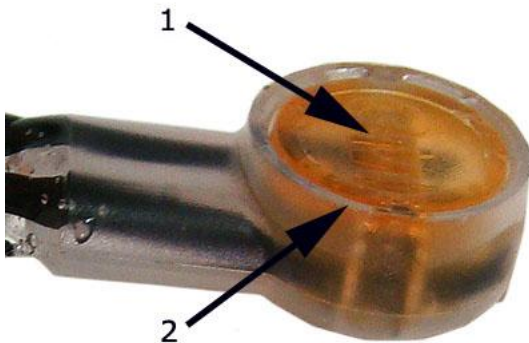

Warning Crimping the connector forces some sealant out of connector. The sealant protects the inside of the connector against insects, moisture, and other contaminants.

The sealant may cause minor eye and skin irritation. Avoid eye contact. Avoid prolonged or repeated skin contact. Contact Itron Support for Material Safety Data Sheets (MSDS).



5. After you complete all ERT module to register wire connections, arrange the connectors in a single file.



6. Insert the connectors and wires into the splice tube until the connectors and wires completely immerse in the tube's gel material.



7. Separate the cables to the sides and close the splice tube cover.



8. Discard any leftover materials from the customer premises.

APPENDIX C

Troubleshooting

This chapter provides the information to help you troubleshoot issues related to the 100W and 100WP ERT modules.

The following table describes possible issues and provides suggested actions to resolve the issue.

Issue	Action
Cannot program the ERT module.	Check the programming device and software version. Program ERT modules using the FC300 handheld computer running Field Deployment Manager (FDM) software.
Cannot read the ERT module.	An ERT module that is not programmed will not transmit an SCM. Reprogram the ERT module and perform a reread. If an ERT module is not initially programmed, it will not bubble-up and listen for an SCM.
The encoder ERT module is reporting an invalid read.	An encoder ERT module that has set the Last Good Read flag will cause an Invalid Read to display in the FDM Consumption field.
Marginal readability due to water ERT module location (for example, an ERT module deep inside a pit).	Consider reprogramming the ERT module for Hard-to-Read (H2R) mode. This increases the output power to Fixed Network levels. Note This mode will reduce battery life.
The ERT module in a Fixed Network is not reporting.	Perform a Check ERT and verify the ERT module is in FN mode. If the CCU's pathway is obstructed, consider including an 8-channel repeater. Systems that utilize Fixed Network v4.0 software and a CCU100 may require a Repeater 100.
The handheld programmer is locked up and button presses produce no response.	<i>Soft boot</i> the handheld by pressing and holding buttons A and B until the screen fades. Release the buttons and allow the handheld to reboot.

Index

Symbols & Numbers

100W and 100WP ERT module mounting
 accessories, 12
100W and 100WP models, 4
100W and 100WP transmission modes, 5
100W and 100WPs with integral connectors, 13
100W encoder start-up, 7
100W operating modes, 5
100WP operating modes, 6
100WP pulser start-up, 8

A

about the 100W and 100WP ERT module, 3

B

base mount installation, 19
battery life, 4
before you begin, 1

C

connecting the 100WP to a remote meter register,
 10
connecting to a meter register using a cable, 8
connecting to a meter register using the inline
 connector, 8

H

how this document is organized, 2

I

initializing the 100W, 7
installing in a new lid, 26
installing the 100W and 100WP ERT module, 12
installing the remote antenna, 35
installing, connecting, and programming the ERT
 module, 7

O

optional direct connect remote antenna installation,
 34
optional Leak Sensor installation, 26

P

pipe preparation, 30
programming the 100WP, 8

R

related documents, 2
required equipment, 27
required mounting tools and hardware, 17
required tools and hardware, 14, 21
rod mount installation, 13

S

shelf mount installation, 20

T

through lid mount required tools and hardware, 23
troubleshooting, 44

U

using an extension cable, 10
using an inline connector, 39
using the Itron splice kit, 41

V

verifying 100W and 100WP operation, 11

W

wall mount installation, 17