



# Water Solutions

## 100W/100W+ and 100WP/100WP+ Datalogging Water ERT Module Installation Guide

## Identification

100W/100W+ and 100WP/100WP+ Datalogging Water ERT Module Installation Guide  
07 November 2012 TDC-0909-006  
100W/100W+ and 100WP/100WP+ ERT module

## Copyright

© 2010 - 2012 Itron, Inc. All rights reserved.

## Confidentiality Notice

The information contained herein is proprietary and confidential and provided subject to the condition that (i) it is held in confidence except to the extent required otherwise by law and (ii) it is used only for the purposes described herein. Any third party given access to this information is similarly bound in writing.

## Compliance Statement

This device complies with Part 15 of the FCC Rules. These limits are designed to provide reasonable protection against harmful interference in a residential installation. Operation is subject to the following two conditions:

- This device may not cause harmful interference.
- This device must accept any interference that may cause undesirable operation.

This device must be permanently mounted such that it retains a distance of 20 centimeters (7.9 inches) from all persons in order to comply with FCC RF exposure levels.

This equipment has been tested and found to comply with the limits for a Class B digital device, pursuant to Part 15 of the FCC Rules. These limits are designed to provide reasonable protection against harmful interference in a residential installation. This equipment generates, uses, and can radiate radio frequency energy and, if not installed and used in accordance with the instructions, may cause harmful interference to radio communications. However, there is no guarantee that interference will not occur in a particular installation.

If this equipment does cause harmful interference to radio or television reception, which can be determined by turning the equipment off and on, the user is encouraged to try to correct the interference by one or more of the following measures:

- Reorient or relocate the receiving antenna.
- Increase the separation between the equipment and receiver.
- Connect the equipment into an outlet on a circuit different from that to which the receiver is connected.
- Consult the dealer or an experienced radio or TV technician for help.

## Compliance Statement

This equipment complies with policies RSS-210 and RSS-GEN of the Industry Canada rules.

Operation is subject to the following two conditions:

- (1) this device may not cause interference, and
- (2) this device must accept any interference, including interference that may cause undesired operation of the device.

## Compliance Statement Canada

Under Industry Canada regulations, this radio transmitter may only operate using an antenna of a type and maximum (or lesser) gain approved for the transmitter by Industry Canada. To reduce potential radio interference to other users, the antenna type and its gain should be so chosen that the equivalent isotropically radiated power (e.i.r.p.) is not more than that necessary for successful communication.

## Déclaration de conformité

Le présent appareil est conforme aux CNR d'Industrie Canada applicables aux appareils radio exempts de licence. L'exploitation est autorisée aux deux conditions suivantes :

- (1) l'appareil ne doit pas produire de brouillage, et
- (2) l'utilisateur de l'appareil doit accepter tout brouillage radioélectrique subi, même si le brouillage est susceptible d'en compromettre le fonctionnement.

## Déclaration de Conformité

Conformément à la réglementation d'Industrie Canada, le présent émetteur radio peut fonctionner avec une antenne d'un type et d'un gain maximal (ou inférieur) approuvé pour l'émetteur par Industrie Canada. Dans le but de réduire les risques de brouillage radioélectrique à l'intention des autres utilisateurs, il faut choisir le type d'antenne et son gain de sorte que la puissance isotrope rayonnée équivalente (p.i.r.e.) ne dépasse pas l'intensité nécessaire à l'établissement d'une communication satisfaisante.

## Trademark Notice

Itron is a registered trademark of Itron, Inc.

All other product names and logos in this documentation are used for identification purposes only and may be trademarks or registered trademarks of their respective companies.



**Warning** To prevent ignition of flammable or combustible atmospheres, disconnect power before servicing.



**Warning** Follow these procedures to avoid injury to yourself or others:

- The lithium battery may cause a fire or chemical burn if it is not disposed of properly.
- Do not recharge, disassemble, heat above 100° Celsius (212° Fahrenheit), crush, expose to water, or incinerate the lithium battery. Fire, explosion, and severe burn hazard.
- Keep the lithium battery away from children.
- Replace the lithium battery only with batteries meeting Itron specifications. Any other battery may cause a fire or explosion.



**Warning** ELECTROMAGNETIC COMPATIBILITY

Use only approved accessories with this equipment. Unapproved modifications or operation beyond or in conflict with these instructions for use may void authorization by the authorities to operate the equipment.



**Warning** This unit cannot be modified and is not repairable. Attempts to modify or repair this device will void the warranty.

**Transportation Classification**

The Federal Aviation Administration prohibits operating transmitters and receivers on all commercial aircraft. When powered, ERT modules are considered operating transmitters and receivers and cannot be shipped by air. All product returns must be shipped by ground transportation to Itron.

**Suggestions**

If you have comments or suggestions on how we may improve this documentation, send them to [TechnicalCommunicationsManager@itron.com](mailto:TechnicalCommunicationsManager@itron.com)

If you have questions or comments about the software or hardware product, contact Itron Technical Support

**Contact**

- Internet: [www.itron.com](http://www.itron.com)
- E-mail: [support@itron.com](mailto:support@itron.com)
- Phone: 800 635 8725



# Contents

---

<b>Chapter 1 Before You Begin</b> .....	<b>1</b>
Document Conventions .....	1
Document Purpose .....	1
How This Document is Organized .....	1
Related Documents .....	2
<b>Chapter 2 About the 100W/100W+ and 100WP/100WP+ ERT Module</b> .....	<b>3</b>
100W/100W+ and 100WP/100WP+ ERT Module Models .....	4
100W+ and 100WP+ ERT Module Security .....	5
Enabling 100W+ and 100WP+ ERT Module Security .....	5
Battery Life.....	6
100W/100W+ and 100WP/100WP+ ERT Module Transmission Modes .....	6
100W/100W+ Operating Modes .....	6
100WP/100WP+ Operating Modes .....	7
100W+ and 100WP+ ERT Module Geo Mode.....	8
<b>Chapter 3 Initializing, Connecting, and Programming the ERT Module</b> .....	<b>9</b>
Initializing the 100W/100W+ .....	9
100W/100W+ Encoder Start-up .....	9
Programming the 100WP/100WP+ .....	10
100WP/100WP+ Pulsar Start-up.....	10
Connecting to a Meter Register Using the Inline Connector .....	10
Connecting to a Meter Register Using a Cable.....	10
Connecting the 100WP/100WP+ to a Remote Meter Register .....	12
Using an Extension Cable .....	12
Verifying 100W/100W+ and 100WP/100WP+ ERT Module Operation .....	12
<b>Chapter 4 Installing the 100W/100W+ and 100WP/100WP+ ERT Module</b> .....	<b>13</b>
100W/100W+ and 100WP/100WP+ ERT Module Mounting Accessories .....	13
100W/100W+ and 100WP/100WP+ ERT Module with Integral Connectors .....	14
Rod Mount Installation .....	14
Required Tools and Hardware .....	15
Wall Mount Installation .....	17
Required Mounting Tools and Hardware .....	17
100W/100W+ and 100WP/100WP+ ERT Module Installation in a New Lid .....	18
Base Mount Installation .....	19
Required Mounting Tools and Hardware .....	19
Shelf Mount Installation .....	20
Required Hardware .....	20
Through Lid Installation.....	21
Through Lid Mount Required Tools and Hardware .....	22
Optional Leak Sensor Installation.....	24



<b>Chapter 5 Optional Direct Connect Remote Antenna Installation.....</b>	<b>32</b>
100W/100W+ and 100WP/100WP+ ERT Module Models for use with Remote Antennas ...	32
Industry Canada Conformity.....	33
Installing the Remote Antenna.....	33
<b>Appendix A Using an Inline Connector .....</b>	<b>37</b>
<b>Appendix B Using the Itron Splice Kit.....</b>	<b>39</b>
<b>Appendix C Troubleshooting .....</b>	<b>42</b>
<b>Index .....</b>	<b>43</b>

## Before You Begin

---

### Document Conventions

Convention	Example
Itron product part numbers are noted in parentheses.	To install the ERT module (ERW-1300-XXX), do the following steps.
Hypertext links are in blue.	See <a href="#">How The Document is Organized</a> on page 1 for document structure information.

-  **Note** A Note indicates neutral or positive information that stresses or supplements important points of the main text. A note supplies information that may apply only in special cases.
-  **Caution** A Caution advises users that failure to take or avoid a specified action could result in a loss of data.
-  **Warning** A Warning advises users that failure to take or avoid a specified action could result in physical harm to the user or the hardware.

### Document Purpose

This document provides the installation instructions for the 100W/100W+ and 100WP/100WP+. Mounting options for the 100W/100W+ and 100WP/100WP+ ERT module include rod mount, wall mount, through-lid (remote antenna), and shelf-mount installation. For available model configuration, see [100W/100W+ and 100WP/100WP+ ERT Module Models](#) on page 4.

An optional Itron Leak Sensor is available for all three configurations to provide leak monitoring capability. 100W/100W+ and 100WP/100WP+ ERT module configurations provide an easy interface to several register types. The 20-inch cable variant allows meter manufacturers to mount the ERT module directly to their respective meter registers before delivery to the installer.

-  **Caution** Installing an integrated 100W/100W+ and 100WP/100WP+ ERT module and meter register in a water pit box reduces the ERT module's RF signal distance significantly. If read reliability is a problem, install a remote antenna or select a new installation method.

### How This Document is Organized

This document is organized into the following chapters:

Chapter	Description
1. Before You Begin	Information about this publication.
2. About the 100W/100W+ and 100WP/100WP+ ERT Module	Overview of 100W/100W+ and 100WP/100WP+ ERT module installation.
3. Initializing, Connecting, and Programming the ERT Module	Instructions to initialize the 100W/100W+ ERT module, program the 100WP/100WP+ ERT module, and connect the ERT modules to the water meter.

Chapter	Description
4. Installing the 100W/100W+ and 100WP/100WP+ ERT Module	Step-by-step ERT module installation instructions for: <ul style="list-style-type: none"> <li>• Rod mount</li> <li>• Wall mount</li> <li>• Base mount</li> <li>• Shelf mount (kit CFG-1300-001)</li> <li>• Through lid mount</li> <li>• Optional Leak Sensor installation</li> </ul>
5. Optional Direct Connect Remote Antenna Installation	Instructions for installing the optional remote antenna.
Appendix A Using an Inline Connector	Instructions for installing an inline connector.
Appendix B Using the Itron Splice Kit	Instructions for installing the Itron Splice Kit.
Appendix C Troubleshooting	Troubleshooting 100W/100W+ and 100WP/100WP+ ERT module operation.

## Related Documents

Document Description	Itron Part Number
<i>100 Series Modules and CENTRON Bridge Meter Tamper Reference Guide</i>	TDC-1028-XXX
<i>Field Deployment Manager Endpoint Tools Mobile Application Guide</i>	TDC-0934-XXX
<i>Field Deployment Manager Field Representative's Guide</i>	TDC-0936-XXX
<i>900 MHz Belt-Clip Radio User's Guide</i>	TDC-0889-XXX
<i>FC300 Getting Started Guide</i>	TDC-0898-XXX
<i>FC200 Series Getting Started Guide</i>	TDC-0598-XXX
<i>Water ERT Module Ordering Guide</i>	PUB-0063-001
<i>Water Meter Compatibility List</i>	PUB-0063-002
<i>mlogonline™ Network Leak Monitoring System User Guide</i>	TDC-0792-XXX



**Note** XXX designates the document revision and is subject to change without notice.



## About the 100W/100W+ and 100WP/100WP+ ERT Module

---

100W/100W+ and 100WP/100WP+ ERT modules are high-power radio frequency automatic meter reading (AMR) devices that attach to water registers to collect consumption usage and tamper data the ERT module then transmits to a data collection device. The ERT module operates in both bubble-up mode and two-way mode.

100W/100W+ and 100WP/100WP+ ERT modules ship in factory mode. After installation and programming, the ERT modules acquire and transmit meter register data. The ERT module transfers meter data immediately if the unit is initialized or programmed with a handheld computer during installation (see *Initializing, Connecting, and Programming the ERT Module*).

The ERT modules support protocols for a variety of meter manufacturer's registers. Refer to the *Water Meter Compatibility List* (PUB-0063-002), for the list of supported meters and registers.

100W/100W+ and 100WP/100WP+ ERT modules are capable of reading 9-digit registers. The 100W/100W+ may be programmed to truncate down to eight-digit registers.

100W/100W+ and 100WP/100WP+ ERT modules feature the following capabilities:

- **Leak Detection and Reverse Flow Detection.** 100W/100W+ series ERT modules feature robust features that provide Leak Detection and Reverse Flow Detection. For more information about Leak Detection and Reverse Flow Detection, see the Itron white paper.
- *(Optional) Leak Sensor.* Itron Leak Sensors (LS) analyze water flow sound patterns to detect new, evolving, and preexisting water leaks. LS analysis data is uploaded to mlogonline Network Leak Monitoring for data analysis. Systems with optional LS devices access leak information through a utility-specific, secure mlogonline portal.

### Communication Error Indicators.

- **Last Good Read (LGR Flag).** Indicates a communication error with the register.
  - 100W/100W+ encoder ERT module  
If this flag is set for 24 consecutive hours, it initiates a cut cable flag in the extended tampers. The LGR Flag automatically clears after the ERT module receives a successful read from the register.
  - 100WP/100WP+ pulser ERT module  
If the LGR Flag is set two consecutive times, it initiates a Cut Cable Flag in the extended tampers. The LGR Flag automatically clears after the ERT module receives a successful read from the register.

---

**Note** Last Good Read Flag may be an indicator of a damaged register.

---

- **Extended Tamper Flag** (retrievable with two-way communication)
  - Low Battery Warning. 100W/100W+ and 100WP/100WP+ ERT modules include a battery life estimator. The estimator is based on the number of data packets sent at the various power levels and the age (self-discharge) of the ERT module. The low battery warning allows the utility to easily identify which ERT modules are nearing end-of-life in a mixed population and gives the opportunity to schedule replacement.

---

**Note** The low battery warning is a single flag set when the battery has less than 10% remaining capacity, typically 2 years life remaining. Battery life is evaluated daily at midnight.

---

- **Cut Cable Flag**
  - 100W/100W+ encoder ERT module. The Cut Cable Flag sets if the LGR Flag is active for 24 hours.
  - 100WP/100WP+ pulser ERT module. The Cut Cable Flag sets if the LGR Flag is active two consecutive times.
  - The Cut Cable Flag remains active for 40 days in mobile mode.
  - The Cut Cable Flag remains active for 24 hours in fixed network mode.

## 100W/100W+ and 100WP/100WP+ ERT Module Models

100W/100W+ and 100WP/100WP+ ERT Module Description	Iron Part Number
100W encoder, dual-port direct connect remote antenna and register integral connectors	ERW-1300-202
100W+ encoder, dual-port direct connect remote antenna and register integral connectors, ISM	ERW-1300-302
100W encoder, three-port direct connect remote antenna, Leak Sensor, and register integral connectors	ERW-1300-203
100W+ encoder, three-port direct connect remote antenna, Leak Sensor, and register integral connectors, ISM	ERW-1300-303
100W encoder, 5-ft. cable register connect, direct connect remote antenna integral connector	ERW-1300-205
100W+ encoder, 5-ft. cable register connect, direct connect remote antenna integral connector, ISM	ERW-1300-305
100W encoder 5-ft. cable register connect, direct connect remote antenna and Leak Sensor integral connectors	ERW-1300-206
100W+ encoder 5-ft. cable register connect, direct connect remote antenna and Leak Sensor integral connectors, ISM	ERW-1300-306
100WP pulser dual-port direct connect remote antenna and register integral connectors	ERW-1300-208
100WP+ pulser dual-port direct connect remote antenna and register integral connectors, ISM	ERW-1300-308
100WP pulser, three-port direct connect remote antenna, Leak Sensor, and register integral connectors	ERW-1300-209
100WP+ pulser, three-port direct connect remote antenna, Leak Sensor, and register integral connectors, ISM	ERW-1300-309
100WP pulser, 5-ft. cable, direct connect remote antenna integral connector	ERW-1300-211
100WP+ pulser, 5-ft. cable, direct connect remote antenna integral connector, ISM	ERW-1300-311
100WP Pulser, 5-ft. cable, direct connect remote antenna and Leak Sensor integral connectors	ERW-1300-212
100WP+ Pulser, 5-ft. cable, direct connect remote antenna and Leak Sensor integral connectors, ISM	ERW-1300-312
100W encoder, direct connect remote antenna integral connector, 20-in. flying lead cable connect	ERW-1300-217
100W+ encoder, direct connect remote antenna integral connector, 20-in. flying lead cable connect, ISM	ERW-1300-317

<b>100W/100W+ and 100WP/100WP+ ERT Module Description</b>	<b>Itron Part Number</b>
100W encoder, direct connect remote antenna integral connector, 20-in. flying lead cable connect, Leak Sensor integral connector	ERW-1300-218
100W+ encoder, direct connect remote antenna integral connector, 20-in. flying lead cable connect, Leak Sensor integral connector, ISM	ERW-1300-318
100WP pulser, 20-in. cable register connect, direct connect remote antenna integral connector	ERW-1300-219
100WP+ pulser, 20-in. cable register connect, direct connect remote antenna integral connector, ISM	ERW-1300-319
100W pulser, 20-in. cable register connect, direct connect remote antenna, and Leak Sensor integral connectors	ERW-1300-220
100W+ pulser, 20-in. cable register connect, direct connect remote antenna, and Leak Sensor integral connectors, ISM	ERW-1300-320



**Note** The 100W/100W+ and 100WP/100WP+ ERT module works accurately with cable lengths up to 300 feet.

## 100W+ and 100WP+ ERT Module Security

The 100W+ or 100WP+ ERT module is a component of a ChoiceConnect system. ChoiceConnect system security applies to the RF communications between the handheld computer, Mobile Collector, or Fixed Network system and the ERT module. There are two fundamental security processes used in the ChoiceConnect system to ensure confidentiality and validity of the system communications.

- **Authentication.** Authentication is the process of confirming that an artifact is genuine or valid. Authentication in the 100W+ and 100WP+ ERT module is the process of verifying a request is from a valid source and in its original form.
- **Encryption.** Encryption is the process of transforming information to make it unreadable to anyone who does not have a valid security key. There are two types of encryption, symmetric and asymmetric. Symmetric encryption uses a shared key to decrypt or encrypt information. Asymmetric encryption uses a private key to encrypt and a public key to decrypt.

As a component of the Itron ChoiceConnect solution, the 100W+ or 100WP+ ERT module supports the security model found in the ChoiceConnect solution for both reading and programming. If the 100W+ or 100WP+ ERT modules are shipped without ChoiceConnect security enabled, the utility can, at a later date, configure the ERT modules for security.

## Enabling 100W+ and 100WP+ ERT Module Security

When 100W+ and 100WP+ ERT modules ship from an Itron factory, each module contains a utility factory key. The presence of this utility factory key does not enable security. The installer enables 100W+ and 100WP+ ERT module security using an Itron programming device and programming commands. Initial key exchange commands are secured using the utility factory key. For more information about programming the 100W+ and 100WP+ ERT module, see the *FDM Endpoint Tools Mobile Application Guide* (TDC-0934).

## Battery Life

Powered by two non-replaceable, long-life lithium batteries, the 100W/100W+ and 100WP/100WP+ ERT modules have an expected battery life of 20 years when the ERT modules operate in default mobile or fixed network operating mode. If the 100W/100W+ and 100WP/100WP+ ERT module is programmed for hard to read mobile mode, the battery life is reduced to 12 years. To pro-actively indicate the battery has reached a <10% useful battery life, a *Low Battery Flag* is set to indicate a low battery warning and alert the utility of an impending battery failure.

## 100W/100W+ and 100WP/100WP+ ERT Module Transmission Modes

The 100W/100W+ and 100WP/100WP+ ERT module can be set to transmit in fixed network, mobile high power, mobile and handheld, or hard to read mobile and handheld mode.

- **Fixed Network Mode.** The 100W/100W+ and 100WP/100WP+ ERT module transmits a high-powered NIM RF message every six minutes and a contingency SCM+ RF message every minute.
- **Mobile and Handheld Mode.** The 100W/100W+ and 100WP/100WP+ ERT module transmits a medium-powered SCM+ RF message every 9 seconds.
- **(Optional) Mobile High Power Mode.** The 100W/100W+ and 100WP/100WP+ ERT module transmits a high-powered SCM+ RF message every 60 seconds.
- **(Optional) Hard to Read Mobile Mode.** The 100W/100W+ and 100WP/100WP+ ERT module transmits a high-powered SCM+ RF message every 30 seconds. *The hard-to-read mobile and handheld mode should only be used for exceptionally hard-to-read applications.*

---

**Note** The 100W/100W+ and 100WP/100WP+ ERT module's battery life is significantly affected in hard to read mobile mode. You may use the 900 MHz Remote Antenna to increase reading range.

---

An FCC license is not required to read 100W/100W+ and 100WP/100WP+ ERT modules.

## 100W/100W+ Operating Modes

The 100W/100W+ has three standard operating modes.

1. Factory Mode
  - 100W/100W+s are shipped from the factory in factory mode.
  - The ERT module's transmitter is turned off.
  - The ERT module's receiver is bubbling-up to listen for a programming command.
  - 100W/100W+ encoder models will attempt to read the register every hour.
  - Last good read and cut tamper flags may be set when a register is not connected.
  - If the 100W/100W+ reads a connected register, the module automatically moves to run mode.

## 2. Run Mode

- 100W/100W+'s normal operation mode.
- The 100W/100W+ transmitted message is dependent on its factory settings for standard consumption messages (SCM), standard consumption + messages (SCM+), or network interval message (NIM).
  - For SCM and SCM+, the 100W/100W+ default bubble-up rate is 9 seconds.
  - For NIM, the 100W/100W+ default bubble-up rate is 5 minutes. When the ERT module is set for NIM, the 100W/100W+ transmits a contingency SCM+ message every minute. NIM mode is configured when the module detects an attached register or by programming NIM mode with a programming device.

## 3. Audit Mode

- Audit mode is configured by sending a **Check ERT** command or a **Set Mode command #119** with a programming device.
- The 100W/100W+ operates as if in run mode but also transmits an SCM+ every 4 seconds and bubbles up the receiver every 4 seconds.
- The 100W/100W+ exits audit mode automatically after 1 hour or by configuring run mode with a programming device.

## 4. GEO mode

- To reach the head end, 100W+ establishes a communication link with a CCU.
- In the event communications are lost with the host CCU, FDM is used to enable communications (create a geo mode set) with a nearby 100W+.
- The ERT establishes communications with the new device and continues transmitting NIM messages.

# 100WP/100WP+ Operating Modes

The 100WP/100WP+ has four standard operating modes.

## 1. Factory mode

- 100WP/100WP+'s ship from the factory in factory mode.
- The 100WP/100WP+'s transmitter is off.
- The 100WP/100WP+'s receiver bubbles-up to listen for a programming command.
- Last Good Read and Extended Tamper Flags may be set when a register is not connected.
- You must program the 100WP/100WP+ with the initial consumption and the register type to properly move the ERT module to run mode and record consumption. You can program the 100WP/100WP+ in the field with Field Deployment Manager (FDM) or in the factory using custom programming.

## 2. Run mode

- 100WP/100WP+'s normal operation mode.
- The 100W transmitted message is dependent on its factory settings or FDM programming for standard consumption messages (SCM) or network interval message (NIM).
  - For SCM (mobile), the 100WP/100WP+ default bubble-up rate is 9 seconds.
  - For NIM (fixed network), the 100WP/100WP+ default bubble-up rate is five minutes. When the ERT module is set for NIM, the 100WP/100WP+ transmits a contingency SCM message every minute. NIM mode is configured by programming NIM mode with a programming device.

3. Meter manufacturer quiet mode

- Meter manufacturers can configure the 100WP/100WP+ for quiet mode after programming and direct mounting the 100WP/100WP+ in a factory.
- The 100WP/100WP+ is awakened from quiet mode and enters run mode in one of two ways:
  - Counting two pulses. The pulses are counted internal to the 100WP/100WP+ while it is in quiet mode.
  - Receiving a two-way command, such as a **Read ERT** using FDM.
- If an ERT module installed in quiet mode is not bubbling up SCM or NIM messages, it may be due to zero consumption on the ERT module, such as a vacant or vacation home. Initiate a two-way command (for example, perform a **Read ERT** with FDM) before removing the unit.

4. GEO mode

- To reach the head end, 100W+ establishes a communication link with a CPU.
- In the event communications are lost with the host CPU, the 100WP+ searches for a nearby link.
- The ERT establishes communications with the new device and continues transmitting NIM messages.

## 100W+ and 100WP+ ERT Module Geo Mode

100W+ and 100WP+ ERT module geo mode reduces infrastructure requirements by improving network coverage. The 100W+ and 100WP+ ERT module geo mode technology addresses meters with isolated RF impairments allowing hard-to-read ERT modules to be read by a neighboring ERT module with good network coverage. After geo mode communications are enabled with FDM, the neighboring ERT module forwards the hard-to-read ERT module's message to the nearest data collection device.

## Initializing, Connecting, and Programming the ERT Module

---

This chapter provides the instructions to initialize and start up the 100W/100W+, program and start up the 100WP/100WP+, and connect the 100W/100W+ or 100WP/100WP+ ERT module.

### Initializing the 100W/100W+



**Caution** To obtain an immediate reading, initialize the 100W/100W+ with an approved handheld computer. Failure to initialize the ERT module may delay the initial reading up to one hour.

- To initialize the 100W/100W+ immediately, use one of the following handheld computers running Field Deployment Manager (FDM) version 1.0 or later.
  - FC200SR handheld computer (Itron part number FC2-0005-004 or FC2-0006-004)
  - FC300 with SRead
- For normal activation, connect the 100W/100W+ to the water meter register. The ERT module polls for a register every hour. The 100W/100W+ automatically activates after the ERT module detects a register.

### 100W/100W+ Encoder Start-up

The 100W/100W+ automatically:

- Detects the connected register type at the top of the hour, exits factory mode, and enters run mode (programming is not required for the 100W/100W+ to initiate run mode in the default mobile mode).
- Detects an Itron Leak Sensor.

100W/100W+ encoder programming is required to:

- Change the operation mode (for example, to change the ERT module from the default mobile mode to fixed network mode).
- Enter a utility ID or lock type.
- To enter an E-Coder 8-digit driver.
- Commission security

Itron strongly recommends performing a **Check ERT** with a handheld computer running FDM to verify the ERT module is operating correctly after installation. Performing a **Check ERT** will:

- Generate an immediate register read.
- Align the 100W/100W+'s time with the handheld's time.

---

**Important** Periodically dock or cradle the handheld computer or mobile reader to keep the time current.

---

- Verify communication with the Leak Sensor.
- Check for tamper flags.

## Programming the 100WP/100WP+

Programming the 100WP/100WP+ requires one of the following handheld computers running Field Deployment Manager (FDM) version 3.2 or later.

- FC200SR handheld computer (Itron part number FC2-0005-004 or FC2-0006-004)
- FC300 with SRead

For normal activation, connect the 100WP/100WP+ to the water meter register and program the ERT module with FDM.

## 100WP/100WP+ Pulser Start-up

The 100WP/100WP+ enters run mode by completing programming with FDM. Programming sets the appropriate pulser parameters (initial consumption and utility ID).

Itron strongly recommends performing a **Check ERT** with a handheld computer running FDM to verify the 100WP/100WP+ is operating correctly after installation. Performing a **Check ERT** will:

- Generate an immediate register read.
- Align the 100WP/100WP+'s time with the handheld's time.

---

**Important** Periodically dock or cradle the handheld computer or mobile reader to keep the time current.

---

- Verify communication with the Leak Sensor.
- Check for tamper flags.

## Connecting to a Meter Register Using the Inline Connector

The inline connector system easily allows a separation between the ERT module and meter register and provides for general maintenance or system troubleshooting (see [Using an Inline Connector](#) on page 37).

## Connecting to a Meter Register Using a Cable

You may connect the 100W/100W+ and 100WP/100WP+ ERT module to the water meter register using the 5-foot or 20-inch cable.



**Caution** ERT module wire terminations must be properly sealed with a non-conductive gel material to prevent water intrusion (otherwise, this configuration should not be used in a pit box environment). Itron recommends the 5-foot or 20-inch cable configuration for OEM users only.



**To connect the 100W/100W+ to the register**

Connect the 100W/100W+ wires to the register screw terminals according to the following table.

Register Manufacturer	100W/100W+ wire color		
	Red (data)	Black (power/clock)	White (ground)
	Register screw terminal		
Elster AMCO Invision	R	G	B
Elster AMCO Scancoder	R	G	B
Elster AMCO evoQ4 (Q4000)	R	W	B
Hersey Translator	G	R	B
Badger ADE	G	R	B
Sensus ECR	G	R	B
Sensus ICE	G	R	B
MetronFarnier	G	R	B
Itron (Actaris) Coder	G	R	B
Neptune ProRead E-Coder ARB-V	R	B	G
Performance ETR	G	R	B
Severn Trent SM700 SmartMeter (Sensus Protocol)	G	R	B

**Caution** Wrap the wire one complete revolution around the register screw.

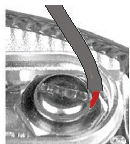

Completely tighten the register screw and verify the wire insulation is not under the screw terminal heads or intermittent electrical connection may occur. You must use a moisture-proof sealant if the meter is installed outdoors or in any environment where moisture can collect on the screw terminals.

Connect the ERT module to the register cable using the Itron Splice Kit (see [Using the Itron Splice Kit](#) on page 39).

## Connecting the 100WP/100WP+ to a Remote Meter Register

Connect the wires from the ERT module to the register according to the following table.

100WP/100WP+ Connections			
Register Manufacturer	100WP/100WP+ wire color		
	Red (signal)	Black (common)	White (tamper)
	Register screw color designator		
Elster Digital	BLK	GRN	R
Itron (Actaris) Cyble Sensor (2-wire)	Either wire	Remaining wire must be connected to both ERT module wires	
Badger RTR	R	BLK	Green/bare
Elster V100	BLK	R	Blue
Sensus PMM	R	BLK	Bare

Connect the ERT module to the cable using the Itron Splice Kit (see [Using the Itron Splice Kit](#) on page 39).

## Using an Extension Cable

Order the 25-foot inline connector extension cable assembly (CFG-0151-401) to extend the 100W/100W+ with the inline connector.

## Verifying 100W/100W+ and 100WP/100WP+ ERT Module Operation

Use one of the following handheld computers to verify consumption:

- FC200SR handheld computer (Itron part number FC2-0005-004 or FC2-0006-004)
- FC300 with SRead



### Notes

- Each handheld radio requires special setup and configuration parameters to successfully read and program 100W/100W+ and 100WP/100WP+ ERT module products. Refer to the respective meter reading application for specific instructions.
- When comparing the actual register value to that reported by the 100W/100W+ and 100WP/100WP+ ERT module, please keep in mind the ERT module's consumption value is updated once an hour when it is in a run mode.



**Caution** Verifying the 100W/100W+ and 100WP/100WP+ ERT module operation requires an FC200FR or and FC300 handheld computer running FDM v3.2 or higher. Legacy Itron handheld programming devices cannot read the 100W/100W+ and 100WP/100WP+ ERT modules.

## Installing the 100W/100W+ and 100WP/100WP+ ERT Module

Install the 100W/100W+ and 100WP/100WP+ ERT module using one of the following methods:

### 100W/100W+ and 100WP/100WP+ Mounting Options

<b>Rod mount</b>	The ERT module mounts on a 1/2-inch outside diameter rod.
<b>Wall mount</b>	The ERT module mounts to a wall or other vertical surface.
<b>Base mount</b>	The ERT module mounts on a horizontal, flat surface.
<b>Shelf Mount</b>	The ERT module mounts in prefabricated pockets or shelves within the pit lid using a shelf mount accessory kit.
<b>Through Lid</b>	The ERT module mounts in lids with hole sizes from 1-3/4 inches to 2-inches. Through-lid installation requires the Pit Lid Mounting Kit (CFG-1300-004).

For water pit boxes, the type of installation method is based on two factors: the lid material and the current lid configuration. Metal lids may require a through-lid remote mount antenna for optimal ERT module radio performance. Plastic lids and other composite materials accept any installation methods described above. The 100W/100W+ and 100WP/100WP+ ERT modules are temperature rated from -20° C to +60° C. Do not install the 100W/100W+ and 100WP/100WP+ ERT module in locations that may exceed the temperature rating.



**Caution** Observe the following guidelines for mounting the 100W/100W+ and 100WP/100WP+ ERT module:

- ERT module positioning other than upright could negatively affect radio performance and battery life.
- Use only Itron-approved splice kits or inline connectors.

## 100W/100W+ and 100WP/100WP+ ERT Module Mounting Accessories

### 100W/100W+ and 100WP/100WP+ ERT Module Mounting Accessories

<b>Accessory</b>	<b>Part Number</b>
Remote Antenna Kit (mobile applications only)	CFG-0900-003
Shelf Mount Kit	CFG-1300-001
Pit Lid Mounting Kit	CFG-1300-004
100W ERT Module Universal Environmental Cap	MSC-0019-008
Itron Security Seal	MSC-0018-001



**Caution** Shield unconnected ERT module ports on field installed modules with protective environmental covers. Do not leave an exposed connector in the field. Environmental caps employ multiple seals to increase cap life.

## 100W/100W+ and 100WP/100WP+ ERT Module with Integral Connectors

If 100W/100W+ and 100WP/100WP+ ERT modules with integral connectors (ERW-1300-X0X) and the registers are not installed at the same time, secure the protective environmental connector cover on the ERT module using an Itron Security Seal (Itron part number MSC-0018-001). Cable ties are not shipped with the 100W/100W+ and 100WP/100WP+ ERT module, but can be ordered from Itron. Use the protective cover (on the ERT module side) in the field for up to one year.



**Warning** If a three-port 100W/100W+ and 100WP/100WP+ ERT module is installed but the Leak Sensor is not attached, the environmental cap (MSC-0019-008) must remain in place on the blue connector (LS) to protect the connector from damage.

### To install a security seal through the protective connector cover

1. Align the protective cover and connector security seal holes.
2. Insert the security seal pointed end through the security holes in the connector and protective cover.
3. Insert the pointed end of the security seal into the cap end and push until the seal locks.

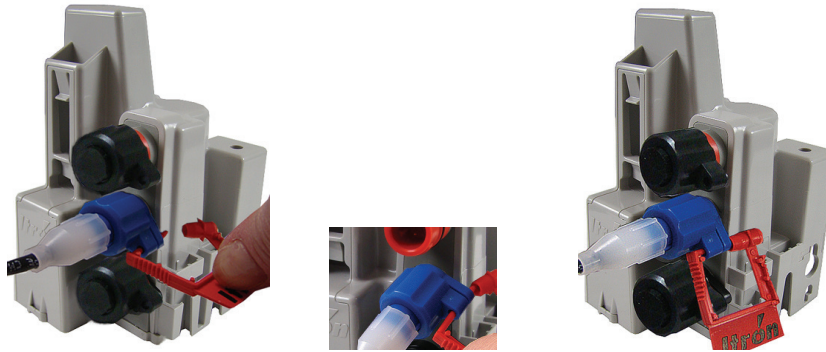

## Rod Mount Installation

100W/100W+ and 100WP/100WP+ ERT modules can mount below the pit lid on a customer-supplied 1/2-inch OD rod. The example installation described in this section uses a fiberglass rod. For more information, visit [www.itron.com](http://www.itron.com) and reference the *Water Meter Compatibility List* (PUB-0063-002).



**Warning** The rod installation area must be free from other pipes, wires, or facilities that may be damaged by driving a rod into the ground.



**Caution** You must follow local codes when using the rod mount installation method. Failure to use 1/2-inch rod and follow instructions may result in an unreliable installation.

**Caution** Observe the following guidelines for mounting the 100W/100W+ and 100WP/100WP+ ERT module using the wall mount procedure:

- ERT module positioning other than upright could negatively affect radio performance and battery life.
- Use only Itron-approved splice kits or inline connectors.

## Required Tools and Hardware

- Hammer
- 1/2-inch outside diameter rod (you may use either a square or round rod)
- Tape measure
- Rod-driving tool (optional)
- Rod cutting tool

The 1/2-inch diameter rod hole is shown in the following 100W/100W+ and 100WP/100WP+ ERT module bottom and side views.

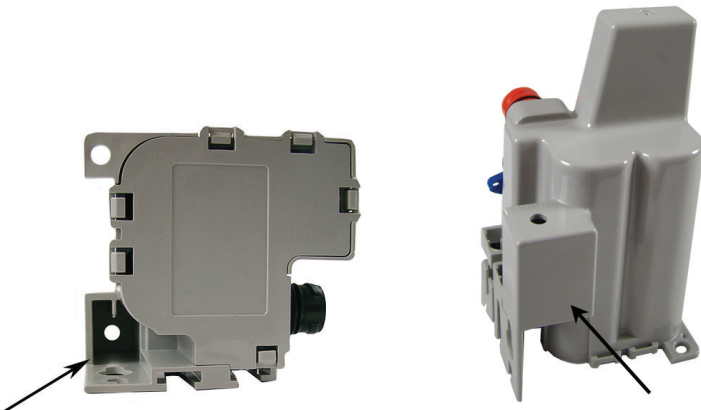

### **To install the 100W/100W+ and 100WP/100WP+ ERT module on a rod**

1. Remove the pit lid. Inspect the area to make sure there are no buried cables, pipes, or other obstructions.
2. Measure the pit box depth from the top of the lip (where the lid will rest) to the bottom of the pit. Be sure to measure the depth at the point where you will drive the rod into the ground.
3. Add 12 inches to the pit box depth measurement taken in step 2. The resulting total represents the minimum length of rod needed. Soil types and moisture conditions may require longer rod lengths to ensure the ERT module is well supported and remains vertical.
4. Without touching the meter body or adjacent pipes, position the rod as close to the center of the pit as possible. Drive the rod into the ground. Ensure the rod remains vertical.



---

**Note** The rod shown has an end cap to protect the rod while driving it into the ground.

---

5. Drive the rod into the ground so the top of the rod is approximately 3-1/2 inches below the bottom of the pit lid.

- If you cannot drive the rod in enough to equal the necessary spacing, cut the remaining rod length to the proper height using an abrasive cut-off tool.

**Caution** Cutting fiberglass creates dust particles. Practice proper safety precautions when using cut-off tools to prevent exposure to fiberglass dust particles.

---

- If the rod is the correct depth but remains loose in the soil, replace the rod with a longer version.

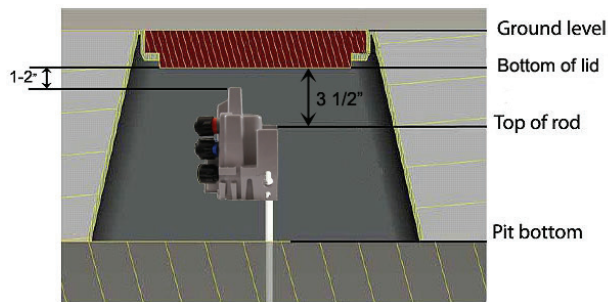

6. The top of the rod must be 3-1/2 inches below the bottom of the lid. Place the ERT module on the rod. Completely insert the rod into the ERT module's rod mount hole. Do not force the ERT module onto the rod. If the ERT module does not slide freely on the rod, remove the ERT module and examine the ERT module rod hole and rod for burrs or obstructions. You may secure the ERT module to the rod with a self-drilling screw through the hole in the top of the ERT module's rod mount cavity. The screw mounting hole is shown in the following product image.

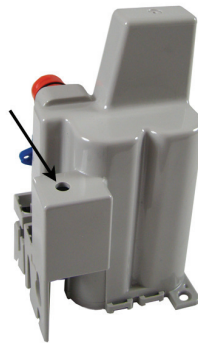

7. Installation is complete when the ERT module is perpendicular to the underside of the lid. The ERT module must not contact the pit structure or lid.

**Caution** Verify the pit lid does not touch the ERT module when the lid is replaced. There must be a 1 to 2-inch space between the top of the ERT module and the bottom of the pit lid. If the ERT module is installed too high, too low, or is touching any of the surrounding surfaces, adjust as necessary.



## Wall Mount Installation

Select a flat vertical mounting surface. Install the ERT module in an upright position. Locate the ERT module as high as possible. To mount the ERT module to the wall in a water pit box, select a mounting location on the inside of the pit box and try to maintain a distance of one to two inches from the bottom of the pit box lid.



**Caution** Observe the following guidelines for mounting the ERT module using the wall mount procedure:

- ERT module positioning other than upright could negatively affect radio performance and battery life.
- Do not use gel connectors in pit environments; use only Itron-approved splice kits or inline connectors.

The ERT module works accurately with Itron-approved cable type and lengths up to 300 feet.

## Required Mounting Tools and Hardware

- Drill and drill bits appropriate for mounting location material.
- Common hand tools for the selected fastening method.
- #10 size pan head mounting screws appropriate for the wall or pit box material.

### ***To install the 100W/100W+ and 100WP/100WP+ ERT module using the wall mount procedure***

1. Select a vertical surface in the pit box or on a wall (for example, an ERT module mounted in a basement).
2. Position the ERT module vertically so the top of the ERT module is between 1 and 2-inches below the bottom of the lid.
3. Mark the location of the top mounting hole.
4. Drill a pilot hole in the pit box wall. Follow the screw manufacturer's recommendation for the pilot hole size.
5. For concrete-type pit boxes, it may be necessary to use a screw anchor. Choose an anchor appropriate for a #10 pan head screw.

---

**Caution** Do not over-tighten the mounting screws. Over-tightening the mounting screws may break the ERT module mounting tabs.

---

6. Start a screw into the pilot hole. Using the top hole of the ERT module, set the ERT module over the screw head and slide it down so the screw is now at the top of the notch (as shown). Carefully tighten the screw until snug. Over-tightening the mounting screw could crack the ERT module housing.

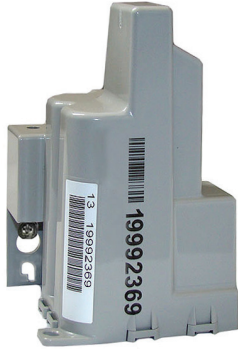

---

**Note** If mounting requires a screw anchor, mark the location of the bottom anchor and remove the ERT module. Drill the required mounting hole, insert the anchor, and re-attach the ERT module.

---

7. Holding the ERT module in the upright position, drill the second pilot hole. Use the bottom mounting hole as a template.

---

**Caution** Any ERT module position other than upright may negatively affect radio performance and battery life.

---

8. Screw the bottom screw into the pilot hole until snug. Do not over-tighten the mounting screw.

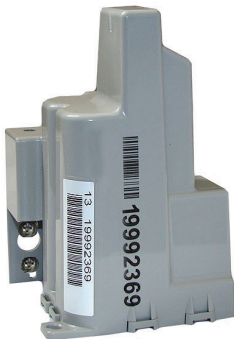

## 100W/100W+ and 100WP/100WP+ ERT Module Installation in a New Lid

This section describes installation of the 100W/100W+ and 100WP/100WP+ ERT module in a pit lid without a drilled hole.

### **To install the 100W/100W+ and 100WP/100WP+ ERT Module in new lids**

1. Select a hole location with enough clearance on the bottom side of the lid to attach the threaded clip collar.
2. Drill a 1-3/4 inch hole in the lid.
3. See [To install in lids with holes using the Pit Lid Mounting Kit](#) to complete installation in a new lid.



## Base Mount Installation

The ERT module may be mounted to a flat surface using the base tab.



**Caution** Observe the following guidelines for mounting the ERT module using the wall mount procedure:

- ERT module positioning other than upright could negatively affect radio performance and battery life.
- Use only Itron-approved splice kits or inline connectors.

## Required Mounting Tools and Hardware

- Drill and drill bits appropriate for mounting location material.
- Common hand tools for the selected fastening method.
- #10 size pan head mounting screws appropriate for the wall or pit box material.

### ***To install the 100W/100W+ and 100WP/100WP+ ERT module using the base mount procedure***

1. Select a flat surface.
2. Position the ERT module vertically.
3. Mark the mounting-hole location.
4. Drill a pilot hole in the mounting location material. Follow the screw manufacturer's recommendation for the pilot hole size.
5. Position the ERT module and insert a #10 pan head screw in the base mounting tab. Carefully tighten the mounting screw until the ERT module is secure.

---

**Caution** Do not over-tighten the mounting screws. Over-tightening the mounting screws may break the ERT module mounting tabs.

