

Repeater

Installation Guide

For use with the Fixed Network and Mobile
Collection solutions

D R A F T

Identification

Repeater Installation Guide
TDC-0613-003b 03/06
For use with the Fixed Network and Mobile Collection solutions

Trademark Notice

Itron is a registered trademark of Itron, Inc.

All other product names and logos in this document are used for identification purposes only and may be trademarks or registered trademarks of their respective companies.

Copyright Notice

Your company has the right to reproduce this contract document provided that such reproduction shall be subject to the same use and disclosure restrictions contained in the Confidentiality and Non-Disclosure paragraphs in the Sales Contract.

© 2004-2006 Itron, Inc. All rights reserved.

Compliance Statement

This equipment has been tested and found to comply with the limits for a Class B digital device, pursuant to Part 15 of the FCC Rules. These limits are designed to provide reasonable protection against harmful interference in a residential installation. This equipment generates, uses, and can radiate radio frequency energy and, if not installed and used in accordance with the instructions, may cause harmful interference to radio communications. However, there is no guarantee that interference will not occur in a particular installation.

If this equipment does cause harmful interference to radio or television reception, which can be determined by turning the equipment off and on, the user is encouraged to try to correct the interference by one or more of the following measures:

- Reorient or relocate the receiving antenna.
- Increase the separation between the equipment and receiver.
- Connect the equipment into an outlet on a circuit different from that to which the receiver is connected.
- Consult the dealer or an experienced radio or TV technician for help.

This device complies with Subpart C of Part 15 of FCC Rules. Operation of this device is subject to the following two conditions:

- This device may not cause harmful interference.
- This device must accept any interference that may cause undesirable operation.

This device complies with Part 15.247 of the FCC rules governing spread spectrum devices. The device operates in the 900 MHz unlicensed band at a maximum peak power level of 1 watt with a transmission duration that will not exceed 50 milliseconds.

This device must be permanently mounted such that it retains a distance of 20 centimeters (7.9 inches) from all persons in order to comply with FCC RF exposure levels.

Modification and Repairs

To ensure FCC compliance and system performance, this device, antenna and coaxial assembly shall not be changed or modified without the expressed approval of Itron. Any modification may void the user's authority to operate the equipment.



WARNING! This device contains no user serviceable parts. Attempts to repair this device by unauthorized personnel may subject the person to shock hazard if removal of protective covers is attempted. Unauthorized repair may void the warranty and/or maintenance contract with your company.

Meter Installation/Removal

In the event of malfunction, all repairs should be performed by Itron. It is the responsibility of users requiring service to report the need for service to Itron.



WARNING! The installation of this device may subject the installer to hazardous conditions, including the possibility of electrical shock. Trained professionals should install this device. This instruction manual should be considered supplemental and used in addition to and in accordance with your company's meter installation and removal procedures and all related safety regulations.

Customer Service

If you have questions, comments or suggestions contact Itron as follows:

- Mail: Itron, Inc.; Attention: Customer Care; 2818 N. Sullivan Road; Spokane, WA 99216
- E-mail: support@itron.com
- Phone: 1-800-635-8725



Contents

	List of Procedures	v
	Before You Begin	vii
	Overview	vii
	Audience	vii
	How This Document is Organized	vii
	Documentation Conventions	vii
Chapter 1	Getting Started	1
	What is a Repeater?	1
	Overview	1
	Repeater Identification	1
	Repeater Types	1
	Repeater Specifications	2
	Planning for Repeater Installations	6
	Installation Types	6
	Unpacking the Repeater	6
	Overview	6
	What's In the Box	6
Chapter 2	Single-Channel Repeater Installation	7
	Getting Started	7
	Overview	7
	Installing Pole-Mount Repeaters	7
	Overview	7
	Required Hardware and Tools	7
	Earth Grounding	8
	Wind Load	8
	Installing a Single-Channel Repeater on a Davit	8
	Installing Sleeve-Mount Repeaters	12
	Types of Sleeve-Mount Repeaters	12
	Required Tools	12
	Installing on a Ringless Meter Socket	12
	Installing on a Ringed Meter Socket	15
Chapter 3	Eight-Channel Repeater Installation	19
	Getting Started	19
	Overview	19
	Installing Pole-Mount Repeaters	19
	Overview	19

Required Hardware and Tools	19
Earth Grounding	20
Wind Load	20
Installing an Eight-Channel Repeater on a Davit	20
Installing Decorative-Mount Repeaters	24
Overview	24
Installing a Decorative-Mount Repeater	24



List of Procedures

Installing a Decorative-Mount Repeater 24
Installing a Single-Channel Repeater on a Davit 8
Installing an Eight-Channel Repeater on a Davit 20
Installing on a Ringed Meter Socket. 15
Installing on a Ringless Meter Socket 12



Before You Begin

Overview

This document describes the installation and configuration of repeaters for the Fixed Network and Mobile Collection solutions. This document describes the different types of repeaters; available installation kits and accessories; and the overall installation process.

Audience

This document is intended for utility field personnel and others associated with the installation and maintenance of a repeater. Installers should have previous training and experience in the following:

- Installation and maintenance of electric meters
- Electrical wiring and related skills
- All utility-specific OSHA regulations and procedures

How This Document is Organized

This document is organized as the following.

Chapter	Description
<i>List of Procedures</i>	Provides an alphabetical list of all procedures contained in this document.
<i>Chapter 1. Getting Started</i>	Describes what a repeater is, the types of repeaters, specifications, and the contents of installation kits.
<i>Chapter 2. Single-Channel Repeater Installation</i>	Provides step-by-step instructions for installing single-channel pole-mount and sleeve-mount repeaters.
<i>Chapter 3. Eight-Channel Repeater Installation</i>	Provides step-by-step instructions for installing eight-channel pole-mount and decorative-mount repeaters.

Documentation Conventions

This document uses the following conventions.

Convention	Example
Keypresses are in bold .	Press Enter when complete.
Menu paths are in bold .	From the Start menu, choose File > Save As . (This example instructs the user to choose File from the Start menu; then choose Save As from the File menu.)



Convention	Example
Computer commands to be typed by the user are in Courier New font.	At the C: prompt, type <code>cd itron/bin</code>
File names are in Courier New font.	The data is uploaded to the <code>upload.dat</code> file
Hypertext links are blue.	See Contents on page iii for the complete table of contents.
The last line in a table is defined by a thick gray line.	Note the thick gray line below this row. If the table continues on another page, the column headings are repeated on each page.

CAUTION This type of note warns the user that failure to heed the information in the note could result in loss of data. Be sure to carefully read a CAUTION note and heed the advice/instructions.



WARNING! This type of note is used to warn of potential physical harm to the user or hardware. It is critical that you pay strict attention to WARNING notes, read the information carefully, and heed the advice/instructions.

Chapter 1

Getting Started



What is a Repeater?

Overview

The repeater is a network component that collects data from nearby ERT endpoints and forwards data to a collection device, such as a cell control unit (for Fixed Network applications) or a Mobile Collector radio (for Mobile Collection applications).

A repeater expands the footprint of these devices by forwarding data between endpoints and the CCU or Mobile Collector radio. Single-channel repeaters forwards both standard consumption messages (SCM) and interval data messages (IDM), and eight-channel repeaters forward SCM, IDM, and Type 25 packets (which are used to indicate positive outage notifications and restorations).

The CCU or MC radio, in turn, communicates the data to the Fixed Network Collection Engine or Mobile Interface. The CCU or MC radio opens communication sessions at regular intervals, listening for data from the network repeaters. The CCU or MC radio then processes returned data according to the default or custom parameters configured at the Collection Engine or Mobile Interface for each meter. Repeaters communicate with ERT endpoints and the CCU or MC radio in the 900 MHz radio band.

Repeater Identification

Each repeater has a unique identification number stored in its internal flash memory. The ID number is used for remote unit communications, setting the timing for acknowledgements, setting the index into the transmit, receiving hop tables at power up, setting the random sequences in the transmit hop table, and other functions. A repeater does not track other repeaters within its communication range.

Repeater Types

Itron offers two types of repeaters: single-channel and eight-channel. Each type of repeater can be installed multiple ways.

The type of repeater you install will depend on your site characteristics and network needs. See [Planning for Repeater Installations on page 6](#) for more information.

To learn how to install these types of repeaters, see:

- [Chapter 2, “Single-Channel Repeater Installation” on page 7](#)
- [Chapter 3, “Eight-Channel Repeater Installation” on page 19](#)

Repeater Specifications

Each repeater type (single-channel or eight-channel) and installation option (pole-, sleeve-, or decorative-mount) has slightly different specifications. See the tables below for a description of each type of repeater and installation option.

Single-Channel Pole-Mount Repeater

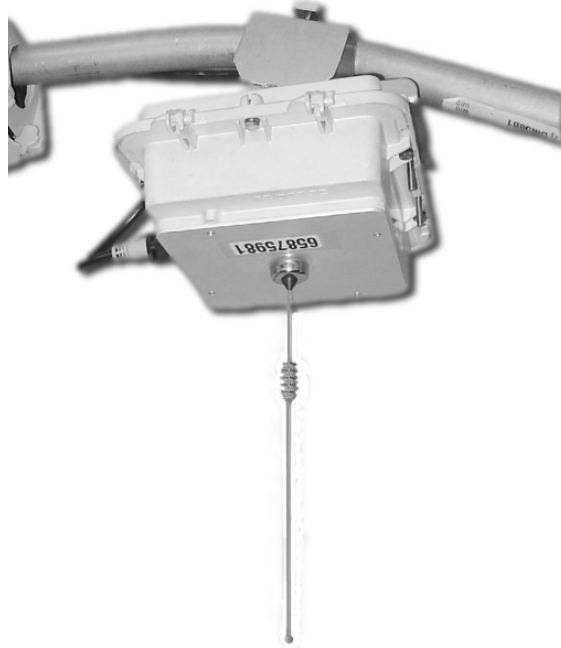

The following table lists the physical specifications for the single-channel, pole-mount repeater.

Pole-Mount Repeater Specification	Description
Power Source	Single-phase 240V or 120V AC
Operating and Storage Temperature	-40 to +75 C
Storage Temperature	-40 to +85 C
Operating humidity	5 to 95% non-condensing relative humidity
Product identification	Numeric and bar coded repeater module serial number
ANSI Compliance	C12.1 standards
Receive/Transmit Frequency Range	908-924 MHz
Data Integrity	Verified in every data message

Single-Channel Sleeve Mount Repeater



The following table lists specifications for the single-channel, sleeve-mount repeater.

Sleeve-Mount Repeater Specification	Description
Power Source	Single-phase 240V or 120V AC
Operating and Storage Temperature	-40 to +75 C
Storage Temperature	-40 to +85 C
Operating humidity	5 to 95% non-condensing relative humidity
Product identification	Numeric and bar coded repeater module serial number
ANSI Compliance	C12.1 standards
Receive/Transmit Frequency Range	908-924 MHz
Data Integrity	Verified in every data message
Meter Form Factor	2S 240V 3-wire Class 200 1S 120V 2-wire Class 100
Meter Sleeve Mount	J4S, J5S

Eight-Channel Pole-Mount Repeater



The following table lists specifications for the eight-channel, pole-mount repeater.

Sleeve-Mount Repeater Specification	Description
Power Source	Single-phase 240V or 120V AC
Operating and Storage Temperature	-40 to +75 C
Storage Temperature	-40 to +85 C
Operating humidity	5 to 95% non-condensing relative humidity
Product identification	Numeric and bar coded repeater module serial number
ANSI Compliance	C12.1 standards
Receive/Transmit Frequency Range	908-924 MHz
Data Integrity	Verified in every data message

Eight-Channel Decorative-Mount Repeater

The following table lists specifications for the eight-channel, decorative-mount repeater.

Sleeve-Mount Repeater Specification	Description
Power Source	Single-phase 240V or 120V AC
Operating and Storage Temperature	-40 to +75 C
Storage Temperature	-40 to +85 C
Operating humidity	5 to 95% non-condensing relative humidity
Product identification	Numeric and bar coded repeater module serial number
ANSI Compliance	C12.1 standards
Receive/Transmit Frequency Range	908-924 MHz
Data Integrity	Verified in every data message

Planning for Repeater Installations

Installation Types

A repeater may be installed in the field directly on a meter using a meter sleeve, on a utility pole, or on a lamppost or other decorative mount. The type of installation used affects the radio performance of the repeater. For example, a pole mounted repeater will have a greater radio coverage area than a sleeve mounted repeater.

Select an installation type based on the following criteria:

- Availability of utility poles
- Costs related to utility pole installation and future maintenance visits.
- Construction materials surrounding the selected meter installation site.
- Aesthetic considerations for development/residential installation.

Unpacking the Repeater

Overview

When you remove a repeater from its shipping carton, verify that no damage has occurred during shipment. Return the repeater to its shipping packaging for transport to the field. Transporting the repeater without protective packaging may result in damage.

What's In the Box

The contents of your repeater carton will vary, depending on the type of repeater shipped.

Pole-Mount Repeater (Single- and Eight-Channel)

- Pole-mount repeater
- Antenna
- Antenna gasket
- Hex bolts (4)
- Washers (4)
- Lock washers (4)
- Photoelectric cell power adapter
- Adjustable mounting bracket kit

Sleeve-Mount Repeater (Single-Channel)

- Sleeve-mount repeater
- Antenna, cover and tension band (the antenna and cover are integrated as one unit)
- Meter sealing ring

Decorative-Mount Repeater (Eight-Channel)

- Decorative-mount repeater
- Rubber seal

Chapter 2

Single-Channel Repeater Installation

Getting Started

Overview

This chapter shows you how to install a single-channel repeater in the field. Your repeater installation process will depend on the type of repeater (pole-mount or sleeve-mount) and the installation location.

For more information, see:

- [Installing Pole-Mount Repeaters on page 7](#)
- [Installing Sleeve-Mount Repeaters on page 12](#)

Installing Pole-Mount Repeaters

Overview

A pole-mount repeater mounts on a streetlight davit at least 6 inches behind the lamp, which allows for clearance to change the light bulb in the lamp.

Required Hardware and Tools

A pole-mount repeater installation requires the following tools and hardware:

- Adjustable Mounting Kit (CFG-003-002)

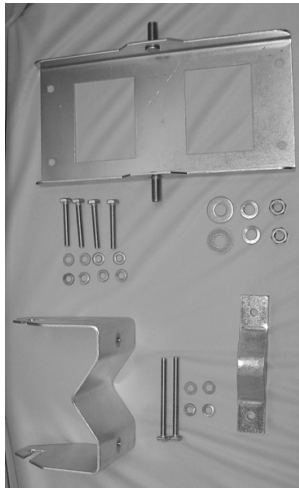

Adjustable Mounting Kit, unassembled

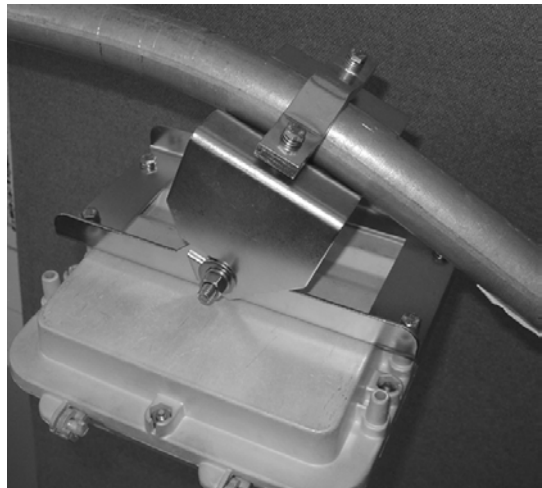

Adjustable Mounting Kit, assembled and attached to davit and repeater

- 7/16-inch nut driver, wrench, or ratchet-wrench
- Inch-pound torque wrench with 7/16-inch and 1/2-inch sockets
- 1/2-inch wrench
- Tie wraps (not supplied with mounting kit)

Earth Grounding

Depending on the local requirements for your utility company, you may need to ground each repeater to earth ground. If you need to earth ground a repeater, ground the case through one of the mounting screws that attach the repeater to the pole using a grounding cable in accordance with local utility company guidelines. The grounding cable is not supplied by Itron.

Wind Load

Prior to installing a repeater on a light pole, ensure that the weight and estimated project area (EPA) of the repeater does not exceed the wind load and total weight load of the light pole. The manufacturer of the light pole should provide wind load and weight rating specifications.

Installing a Single-Channel Repeater on a Davit

To install a repeater on a street light davit, follow the steps below.

Step	Action
1	<p>Attach the bottom plate of the mounting kit to the top of the repeater. For this procedure, use the following items from the Adjustable Mounting Kit:</p> <ul style="list-style-type: none"> • (4) small lock washers • (4) small flat washers • (4) 1 7/8-inch long bolts • Bottom plate
2	<p>Attach the adjustable bracket to the bottom plate. Use the following items from the Adjustable Mounting Kit:</p> <ul style="list-style-type: none"> • (2) large lock washers • (2) large flat washers • (2) 1/2-inch nuts • Adjustable bracket • Bottom plate (attached to repeater) <p>IMPORTANT Do not completely tighten the nuts yet. The repeater orientation will need to be adjusted once the kit is attached to the davit.</p>
3	<p>Partially bolt one end of the top plate onto the adjustable bracket of the mounting kit. Leave the bolt loose so that the bracket can swing. When you are ready to install the repeater in its final position, you will swing the bracket across the top of the davit and secure it. For this procedure, use the following items from the Adjustable Mounting Kit:</p> <ul style="list-style-type: none"> • (1) small lock washer • (1) flat washer • (1) 3 1/4" bolt
4	<p>Place the antenna gasket over the antenna mount on the repeater.</p>

Step Action

- 5 Position the repeater beneath the davit, making sure that:
- The connectors of the repeater face the street lamp.
 - The power cable can easily extend between the power connector at the repeater and the photoelectric sensor.
 - The repeater is placed is at least a 3 inches from the light fixture. This allows the casing of the fixture to open completely, providing maintenance access when necessary.
 - The bottom plate of the mounting kit is straight along the sides of the repeater lid and is securely attached.
 - The groove on the adjustable bracket of the mounting kit aligns with the davit.
 - The repeater hangs straight down.

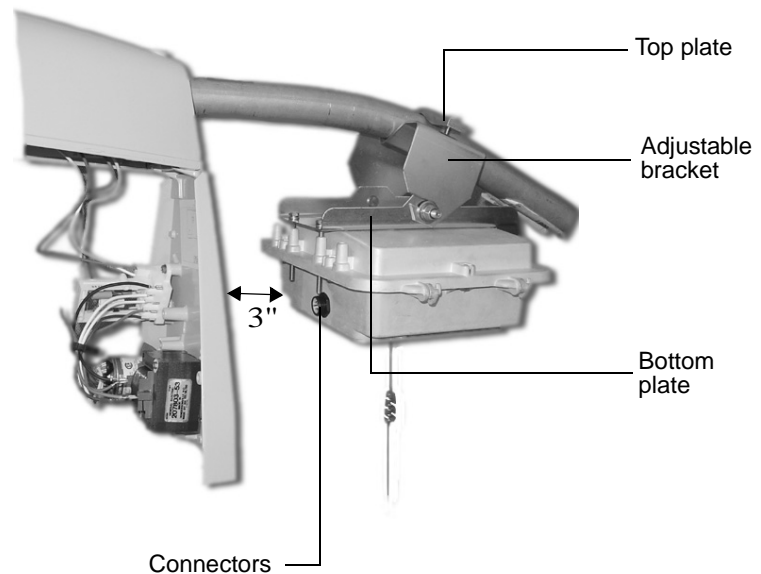

- 6 Swing the unsecured end of the top plate of the mounting kit over the davit and partially bolt it in place. Then torque both bolts to 40-inch pounds.

IMPORTANT The two hex bolts must be torqued as specified to achieve the clamping force needed to withstand 100 MPH. wind. If the bolts are under-torqued, the necessary clamping force may not be obtained. If the bolts are over-torqued, the brackets may become overstressed and clamping force may be reduced.

- 7 Use a voltmeter to verify that the unit has power. If power is not present, the repeater will not function. Make any corrections necessary to provide power before continuing with the installation.

Step	Action
------	--------

8 Provide power to the repeater. This can be done by either using a photoelectric sensor or hard-wiring the repeater with power.

To install the photoelectric power adapter, use the steps below.
To hard-wire power to the repeater, skip to step 9.

- a. Note the current orientation of the sensor window (usually it faces north), so that you can restore it to that orientation when you are done.
- b. Remove the photoelectric sensor.
- c. Insert the repeater photoelectric power adapter into the socket and turn to lock it in place.
- d. Re-insert the photoelectric sensor into the socket on the top of the power adapter.
- e. Adjust the adapter to face the photosensor window to its original orientation by pulling up on the adapter housing and swiveling the housing.
- f. Plug the power cord into the 5-pin connector on the repeater.
- g. Use tie-wraps as necessary to secure the cable away from the repeater housing.

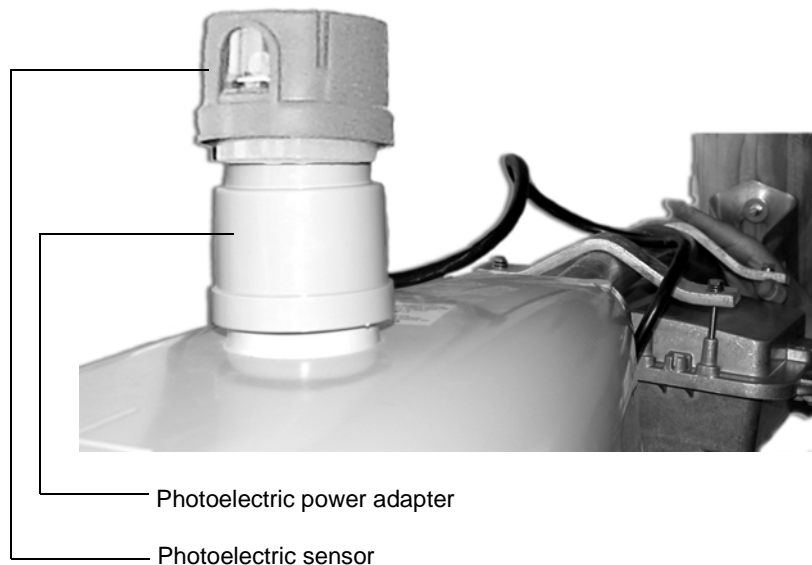

Step Action

- 9** To power the repeater when installing it on a pole without a photo-electric sensor, you must strip the power cable with wire strippers and connect the individual wires to the 120V and neutral wires on the pole.

To hard-wire power to the repeater, follow the steps below.

- a. Connect the unterminated end of the power cable to the power source on the pole. The power cable is made up of two colored wires: *black* and *white*. Connect these wires per the items below:
 - * Black (wire color) - Line side (signal name) - 5 (pin number)
 - * White (wire color) - Neutral (signal name) 1 (pin number)
- b. Wrap any excess cable around the davit or use tie-wraps (not included) to secure the cable away from the repeater.
- c. Connect the other end of the power cable to the 5-pin connector on the front of the repeater.

- 10** Before mounting the antenna, ensure the antenna gasket is seated properly.

Attach the antenna. Be sure not to cross-thread the antenna when installing it on the repeater. Attach the antenna on the bottom of the repeater, tightening with a wrench until the antenna makes contact.

TIP To test whether the antenna makes contact, try to wiggle the antenna. If it seems loose, continue tightening.



Installing Sleeve-Mount Repeaters

Types of Sleeve-Mount Repeaters

Sleeve-mount repeater installation depends on the type of meter socket.

Meter Socket Type	Description
Ringless	A ringless mounted meter installs under the meter box lid, which is hinged at the top of the box.
Ringed	A ringed meter installs on the outside of the meter box and is secured with a meter seal ring.

Required Tools

The following tools are necessary for sleeve-mount repeater installation:

- Tamper seals and associated meter installation/removal tools.
- Panduit Wave-Ty installation tool (optional). This tool cuts excess cable and applies tension to the tension band.

Installing on a Ringless Meter Socket

A ringless meter socket does not use a meter seal ring between the meter and the meter socket. Instead, the meter is secured in the meter socket by a lid. To aid installation on a ringless meter socket, the repeater antenna does not come attached to the repeater. Attach it to the repeater in the following procedure.

To install a repeater on a ringless meter socket, follow the steps below.

IMPORTANT The following instructions should be considered supplemental to the meter installation and removal procedures for your utility. Follow all applicable procedures and regulations when performing meter installation.

Step	Action
1	Remove tamper seals.
2	Verify that the service is compatible with the repeater.
3	Remove the meter socket lid.
4	Remove the meter from the socket.
5	Insert the repeater into the socket.



Step Action

- 6 Replace the meter socket lid.

NOTE If needed, trim the breakaway rim on the repeater sleeve using diagonal cuts so that the socket lid will fit over the repeater.



- 7 Remove the protective label from the double-sided tape on the bottom of the antenna (the antenna and antenna cover are one unit).

IMPORTANT Be careful to not damage or remove the tape.

- 8 Attach the antenna to the top of the sleeve.

IMPORTANT Ensure that it is attached forward against the shoulder and centered on the flat area on the top of the sleeve.

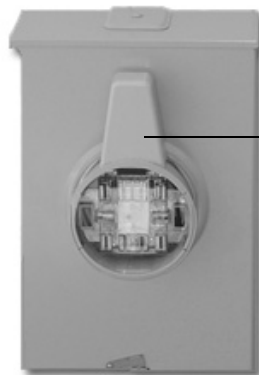

Antenna/antenna
cover attached

Step	Action
------	--------

- | | |
|---|---|
| 9 | Secure the tension band around the repeater and antenna, pulling to tighten. Ensure that the back lip of the antenna is under the tension band. |
|---|---|

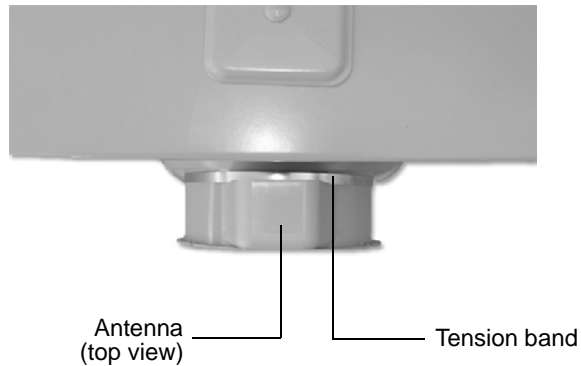

- | | |
|----|--|
| 10 | Tighten the tension band using a tension setting tool. |
| 11 | Clip off any excess material from the tension band. |
| 12 | Snap the meter into the repeater socket. |
| 13 | Attach and tighten the meter ring, making sure to catch the antenna cover lip under the ring band. |

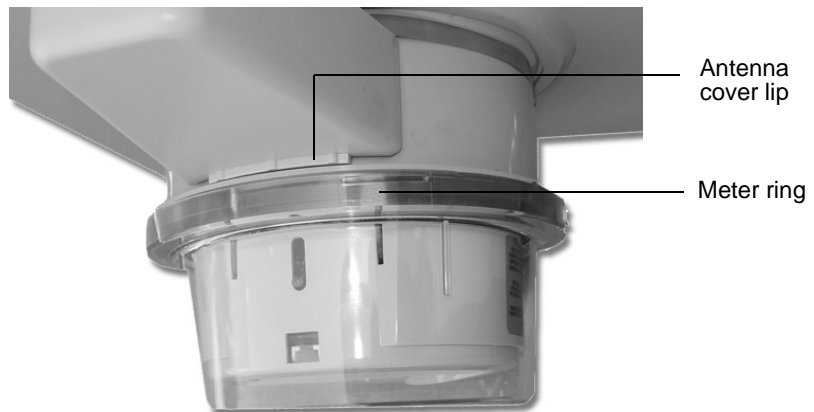

- | | |
|----|---|
| 14 | Install a tamper seal in the ring band and on the meter socket lid. |
|----|---|

Installing on a Ringed Meter Socket

A ringed meter socket uses a meter sealing ring to secure the meter to the socket. To install a repeater on a ringed meter socket, do the following steps.

Step	Action
1	Remove tamper seals.
2	Verify that the service is compatible with the repeater.
3	Remove the meter seal ring.
4	Pull the meter from the socket.
5	Insert the repeater sleeve into the meter socket.

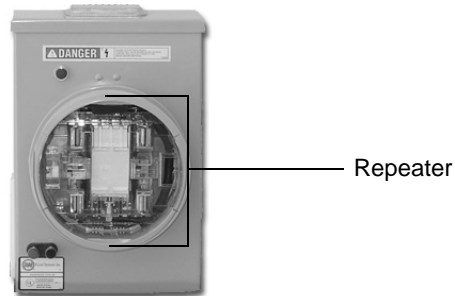

- 6 Remove the protective label from the double-sided tape on the bottom of the antenna (the antenna and antenna cover are one unit).
IMPORTANT Be careful to not damage or remove the tape.
- 7 Attach the antenna/antenna cover unit to the top of the sleeve.
IMPORTANT Ensure that it is attached forward against the shoulder and centered on the flat area on the top of the sleeve.

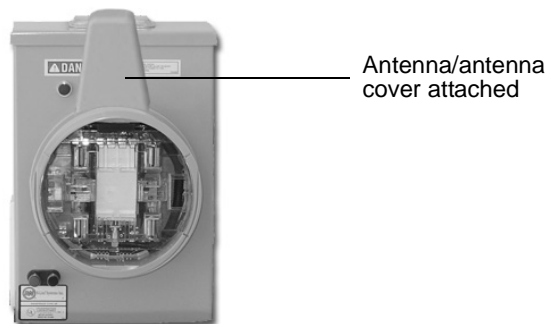

Step	Action
------	--------

- | | |
|---|---|
| 8 | Secure the tension band around the repeater and antenna, pulling to tighten. Ensure that the back lip of the antenna is under the tension band. |
|---|---|

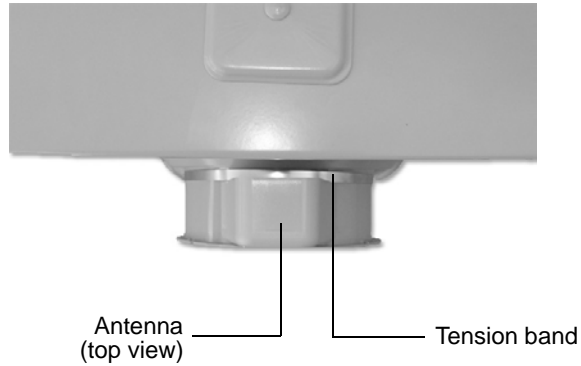

- | | |
|----|---|
| 9 | Tighten the tension band using a tension setting tool. |
| 10 | Clip off any excess material from the tension band. |
| 11 | Secure a meter seal ring between the repeater and the meter socket. |

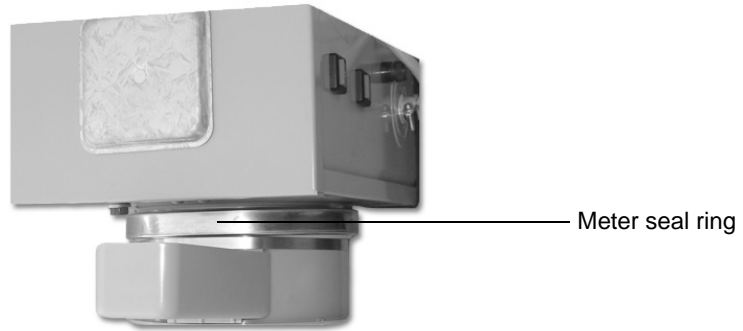

- | | |
|----|--|
| 12 | Insert the meter into the repeater socket. |
|----|--|

Step	Action
------	--------

- | | |
|----|--|
| 13 | Attach the meter seal ring making sure to catch the antenna cover lip under the ring band. |
|----|--|

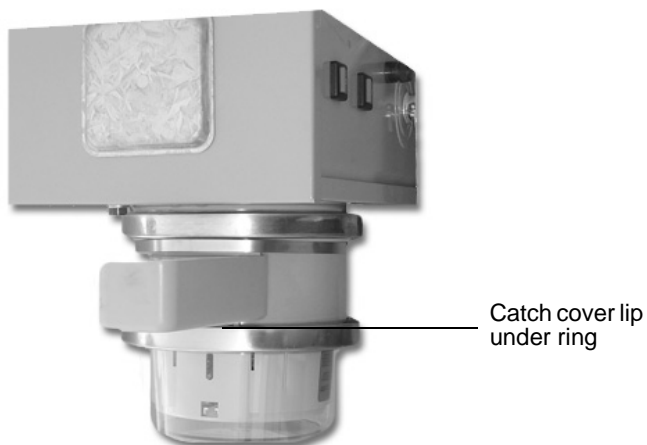

- | | |
|----|---------------------------|
| 14 | Replace the tamper seals. |
|----|---------------------------|

Chapter 3

Eight-Channel Repeater Installation

Getting Started

Overview

This chapter shows you how to install an eight-channel repeater in the field. Your repeater installation process will depend on the type of repeater (pole-mount or decorative mount) and the installation location.

For more information, see:

- [Installing Pole-Mount Repeaters on page 19](#)
- [Installing Decorative-Mount Repeaters on page 24](#)

Installing Pole-Mount Repeaters

Overview

A pole-mount repeater mounts on a streetlight davit at least 3 inches behind the lamp, which allows for clearance to change the light bulb in the lamp.

Required Hardware and Tools

A pole-mount repeater installation requires the following tools and hardware:

- Adjustable Mounting Kit (CFG-003-002)

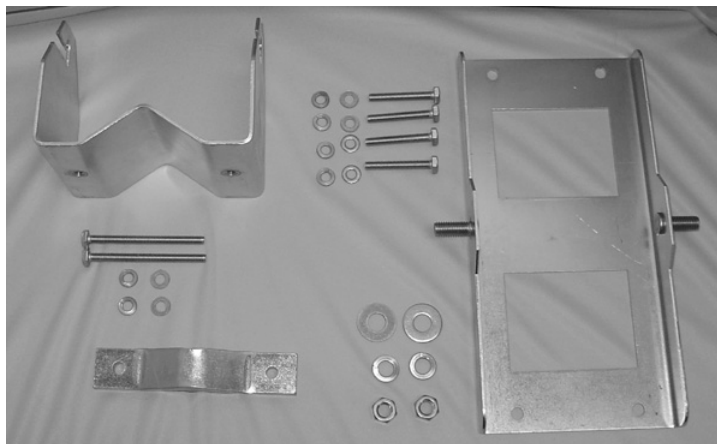

Adjustable Mounting Kit, unassembled

- 7/16-inch nut driver, wrench, or ratchet-wrench
- Inch-pound torque wrench with 7/16-inch and 1/2-inch sockets

- 1/2-inch wrench
- Tie wraps (not supplied with mounting kit)

Earth Grounding

Depending on the local requirements for your utility company, you may need to ground each repeater to earth ground. If you need to earth ground a repeater, ground the case through one of the mounting screws that attach the repeater to the pole using a grounding cable in accordance with local utility company guidelines. The grounding cable is not supplied by Itron.

Wind Load

Prior to installing a repeater on a light pole, ensure that the weight and estimated project area (EPA) of the repeater does not exceed the wind load and total weight load of the light pole. The manufacturer of the light pole should provide wind load and weight rating specifications.

Installing an Eight-Channel Repeater on a Davit

To install an eight-channel repeater on a street light davit, follow the steps below.

Step	Action
1	<p>Attach the bottom plate of the mounting kit to the top of the repeater. For this procedure, use the following items from the Adjustable Mounting Kit:</p> <ul style="list-style-type: none"> • (4) small lock washers • (4) small flat washers • (4) 1 7/8-inch long bolts • Bottom plate
2	<p>Attach the adjustable bracket to the bottom plate. Use the following items from the Adjustable Mounting Kit:</p> <ul style="list-style-type: none"> • (2) large lock washers • (2) large flat washers • (2) 1/2-inch nuts • Adjustable bracket • Bottom plate (attached to repeater) <p>IMPORTANT Do not completely tighten the nuts yet. The repeater orientation will need to be adjusted once the kit is attached to the davit.</p>
3	<p>Partially bolt one end of the top plate onto the adjustable bracket of the mounting kit. Leave the bolt loose so that the bracket can swing. When you are ready to install the repeater in its final position, you will swing the bracket across the top of the davit and secure it. For this procedure, use the following items from the Adjustable Mounting Kit:</p> <ul style="list-style-type: none"> • (1) small lock washer • (1) flat washer • (1) 3 1/4" bolt
4	<p>Place the antenna gasket over the antenna mount on the repeater.</p>

Step Action

- 5 Position the repeater beneath the davit, making sure that:
- The connectors of the repeater face the street lamp.
 - The power cable can easily extend between the power connector at the repeater and the photoelectric sensor.
 - The repeater is placed is at least a 3 inches from the light fixture. This allows the casing of the fixture to open completely, providing maintenance access when necessary.
 - The bottom plate of the mounting kit is straight along the sides of the repeater lid and is securely attached.
 - The groove on the adjustable bracket of the mounting kit aligns with the davit.
 - The repeater hangs straight down.

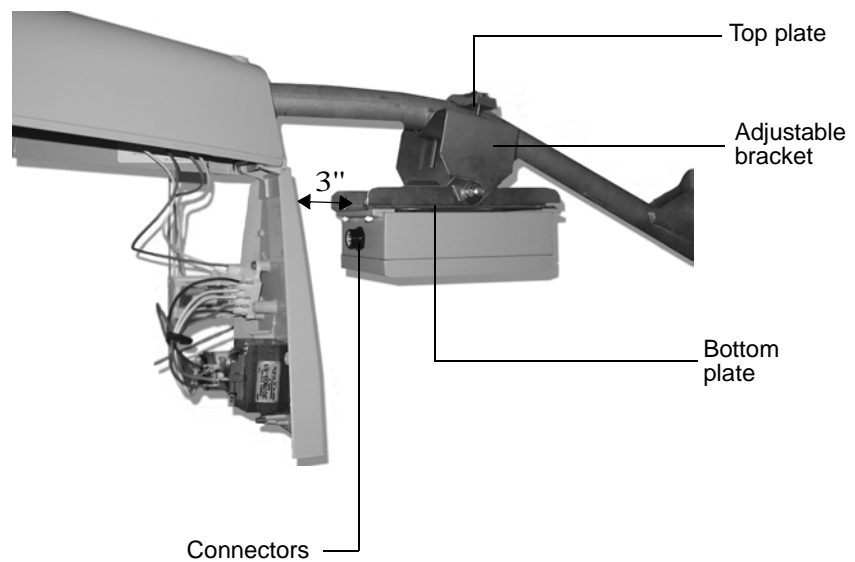

- 6 Swing the unsecured end of the top plate of the mounting kit over the davit and partially bolt it in place. Then torque both bolts to 40 inch-pounds.

IMPORTANT The two hex bolts must be torqued as specified to achieve the clamping force needed to withstand 100 MPH. wind. If the bolts are under-torqued, the necessary clamping force may not be obtained. If the bolts are over-torqued, the brackets may become overstressed and clamping force may be reduced.

- 7 Use a voltmeter to verify that the unit has power. If power is not present, the repeater will not function. Make any corrections necessary to provide power before continuing with the installation.

Step	Action
------	--------

8 Provide power to the repeater. This can be done by either using a photoelectric sensor or hard-wiring the repeater with power.

To install the photoelectric power adapter, use the steps below.

To hard-wire power to the repeater, skip to step 9.

- a. Note the current orientation of the sensor window (usually it faces north), so that you can restore it to that orientation when you are done.
- b. Remove the photoelectric sensor.
- c. Insert the repeater photoelectric power adapter into the socket and turn to lock it in place.
- d. Re-insert the photoelectric sensor into the socket on the top of the power adapter.
- e. Adjust the adapter to face the photosensor window to its original orientation by pulling up on the adapter housing and swiveling the housing.
- f. Plug the power cord into the 5-pin connector on the repeater.
- g. Use tie-wraps as necessary to secure the cable away from the repeater housing.

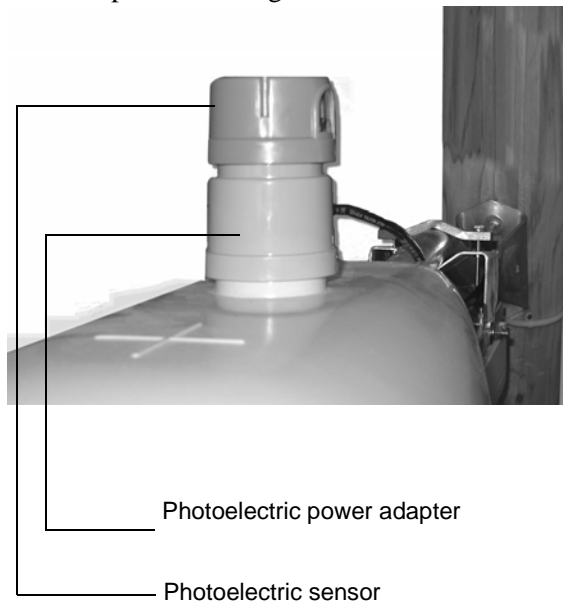

Step Action

- 9** To power the repeater when installing it on a pole without a photo-electric sensor, you must strip the power cable with wire strippers and connect the individual wires to the 120V and neutral wires on the pole.

To hard-wire power to the repeater, follow the steps below.

- a. Connect the unterminated end of the power cable to the power source on the pole. The power cable is made up of two colored wires: *black* and *white*. Connect these wires per the items below:

* Black (wire color) - Line side (signal name) - 5 (pin number)

* White (wire color) - Neutral (signal name) 1 (pin number)

- b. Wrap any excess cable around the davit or use tie-wraps (not included) to secure the cable away from the repeater.

- c. Connect the other end of the power cable to the 5-pin connector on the front of the repeater.

- 10** Before mounting the antenna, ensure the antenna gasket is seated properly.

Attach the antenna. Be sure not to cross-thread the antenna when installing it on the repeater. Attach the antenna on the bottom of the repeater, tightening with a wrench until the antenna makes contact.

TIP To test whether the antenna makes contact, try to wiggle the antenna. If it seems loose, continue tightening.



Installing Decorative-Mount Repeaters

Overview

Decorative-mount repeaters are designed to “blend in” more with their surroundings. These repeaters are typically installed in developments, residential areas, or other areas where an emphasis is placed on the appearance of the device.

Installing a Decorative-Mount Repeater

Installing a decorative-mount repeater is a relatively simple process. To install this type of repeater, follow the steps below.

Step	Action
1	Remove the existing photo-electric sensor from the decorative lamppost. Be sure to note the orientation of sensor window (this typically faces north).
NOTE The existing sensor is no longer needed. The decorative repeater has a built-in photo-electric sensor.	
2	Slide the rubber seal over the base of the repeater, as shown below. The seal should lay just below the photo-electric sensor window on the repeater.
3	If necessary, rotate the socket so that the photo-electric sensor window will be oriented properly (typically facing north) when the repeater is installed. If a photo-electric sensor was previously installed, the socket should already be oriented properly.



Step	Action
------	--------

- | | |
|---|---|
| 4 | Attach the repeater to the top of the lamppost. Be sure to align the prongs on the repeater with the corresponding sockets on the lamppost. |
|---|---|



- | | |
|---|--|
| 5 | Slide the rubber seal down to the top of the lamppost.
Verify that a tight seal around the entire repeater has been created; this will keep water from intruding into the repeater and top of the lamppost. |
|---|--|

Step	Action
------	--------

- | | |
|---|---|
| 6 | When you have finished, your lamppost should look similar to the example below. |
|---|---|

