

NEXTBASE

iN-CAR CAM™

Instruction Manual



English

4063 | **Professional**
High Definition Car DVR

TABLE OF CONTENTS

PRECAUTIONS	01
PRODUCT SPECIFICATION	02
PACKAGE CONTENTS	03
PRODUCT FEATURES	03
CONTROLS	04
INSTALLATION	05
VIDEO MODE	06
PHOTO MODE	07
PLAYBACK MODE	
VIDEO PLAYBACK	08
PHOTO PLAYBACK	08
DRIVING RECORDER PLAYER INSTALLATION	
INSTALLATION FOR WINDOWS	09
INSTALLATION FOR MAC	09
DRIVING RECORDER PLAYER FOR WINDOWS	10
DRIVING RECORDER PLAYER FOR MAC	12
MENUS AND SETTINGS	
VIDEO MODE	13
PHOTO MODE	14
PLAYBACK MODE	14
SETUP MENU	15
PC CONNECTION	16
MAC CONNECTION	16
VIDEO & AUDIO OUTPUT	
HIGH DEFINITION OUTPUT	16
STANDARD DEFINITION OUTPUT	16
FINALCAM(Wi-Fi)APP FOR ANDROID & IOS	17
MASS STORAGE & PC CAMERA	29
TROUBLING SHOOTING	30

PRECAUTIONS

Please read this manual carefully before operation and keep it for future reference. It will be helpful should you encounter any operational problem.

WARNING: Do not expose this product to rain, moisture or water under any circumstances, doing so may result in the risk of electric shock or fire.

CAUTION: To reduce the risk of electric shock, do not perform and servicing other than that contained in the instruction manual unless you are qualified to do so.

Have the unit serviced by a qualified service technician if;

The Unit has been exposed to rain or water.

The unit does not seem to operate normally.

The unit exhibits a marked changes in performance.

LCD: A Liquid Crystal Display (LCD) screen is a multilayer complex component, containing 691,200 pixels. Pixels can however fail during normal product life. 1 pixel = 0.00014% failure rate, and one pixel failures per year of operation is considered normal and not a cause for concern.

WEEE: **Disposal of Waste Electrical and Electronic Equipment and/or Battery by users in private households in the European Union.**



This symbol on the product or on the packaging indicates that this can not be dispose of as household waste. You must dispose of your waste equipment and/or battery by handing it over to the applicable take-back scheme for the recycling of electronic equipment and/or battery. For more information please contact your local household waste disposal office.

DO NOT ATTEMPT TO SERVICE THE UNIT BY YOURSELF!







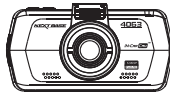

PRODUCT SPECIFICATION

Model Number / Name	NBDVR4063 / NEXTBASE iN-CAR CAM
Power Requirements	5V / 2A (USB socket)
Power Supply	12-24Vdc Car Power Cable (supplied) Fuse Type: 20mm Glass Fast Blow 2A Output: 5Vdc
Sensor Resolution	2M Pixel (2,000,000 Pixel)
Lens Type / Angle / Aperture	6G / 150° / F1.6
Recording Resolution (Max.)	1920 x 1080 @ 30fps
Screen Size	2.7"
Screen Resolution	960 (W) X 240 (H) pixels x RGB
Screen Ratio	16:9
Card Reader	MicroSD, Class 6-10, <=64GB
SD Card (Recommended Type)	8-64GB Class 10 (30mb/s) branded (not supplied)
SD Card Recorded File Capacity (based on default settings)	8GB Micro SD = 60mins of recording 16GB Micro SD = 120mins of recording 32GB Micro SD = 240mins of recording 64GB Micro SD = 480mins of recording
Recording Format	MOV
Video Out	High Definition: Type C Socket (Video / Audio) Standard Definition: 3.5mm Jack (Video / Audio)
Internal Battery	Lithium-ion 3.7V / 260mAh (approx.30mins recording time) Battery design allows the 'Auto Power Off' feature to function in event of power loss within the vehicle. It is not intended as an alternative power source to replace the supplied car adaptor.
Unit Dimensions	95.0 x49.81 x 30.23mm
Unit Weight	89g

PACKAGE CONTENTS

Please check the contents of your iN-CAR CAM product package. The actual products might appear slightly different from the pictures shown below.

<p>iN-CAR CAM</p> 	<p>Mount</p> 	<p>Car Power Cable</p> 	<p>USB Cable</p> 
<p>Installation Disk</p> 	<p>Quick Start Guide</p> 		

PRODUCT FEATURES

Thank you for purchasing this NEXTBASE iN-CAR CAM product, in this section we will outline some of the features available with this device.

2.7" 16:9 LCD Colour Screen

Large screen for ease of use and viewing the playback of both videos and photos.

2.0M PIXEL CMOS Sensor

Provides high quality recording up to 1920 x 1080P Full HD.

150° Wide Angle Lens

Wide angle lens to allow best possible recording of the vista ahead.

GPS Logger

GPS co-ordinates, date and time are recorded, the journey can then be viewed on map using the supplied PC / MAC playback software.

G Sensor / File Protection

In the event of an impact the device will automatically 'protect' the recording stopping the file from being over-written. Individual files can also be 'protected' when viewed within playback mode.

Wi-Fi

Support for smartphone connectivity, wireless download record file to smartphone.

Still Camera

Take still images with a variety of options / settings available.

Auto Shutdown Timer

Select how long you would like the device to continue recording once power has been removed.

Built-in Microphone & Speaker

Record audio to compliment the video recordings.

Motion Detection

The device will detect motion and start recording automatically, useful for car park surveillance.

Note: iN-CAR CAM needs a permanently live power source for this feature to function

High Definition Output

View files directly from your device using the supplied High Definition cable to an external screen.

Windows is a registered trademark of Microsoft Corporation in the United States and other countries.
 Mac is a trademark of Apple Inc
 2012 Google Inc. All rights reserved. Google Maps™ is a trademark of Google Inc..

CONTROLS

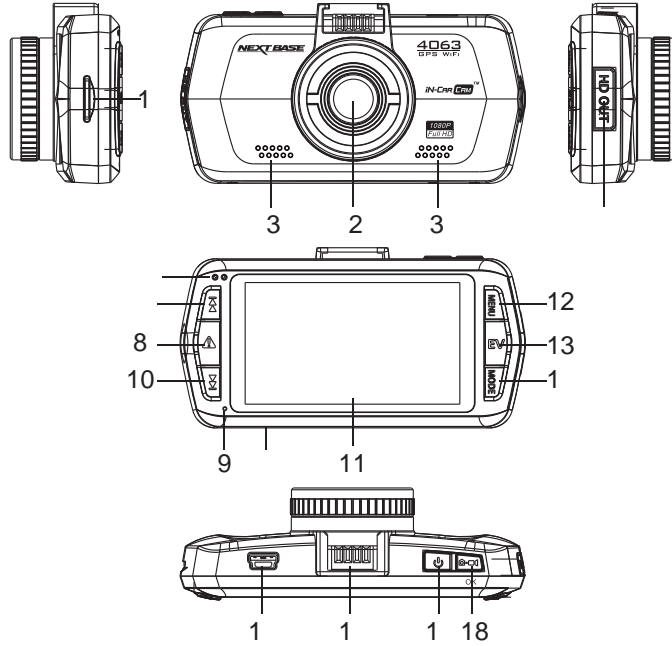

- | | |
|---|--|
| <p>1. MEMOR CARD SLOT located under dust cover. Insert MicroSD memory card here.</p> <p>2. LENS</p> <p>3. SPEAKER</p> <p>4. HD OUT SOCKET located under dust cover. For use with High Definition Cable.</p> <p>5. RESET
Press to reset the iN-CAR CAM.</p> <p>6. LED INDICATOR</p> <ol style="list-style-type: none"> 1. Discharging without car charger: When recording the red light flash, when no video has red light bright, blue light has is off. 2. With car recharging: red light flashing when recording, blue is bright. when there is no recording: red and blue lights bright together mixing. When the battery is fully charged, blue light 3. Low voltage warning red light has been light 4. If Charging: Blue light has been light, the red light is off 5. Shutdown full: No lights bright <p>7. UP
Press to navigate up within menus and to move to the next file when in playback mode</p> <p>8. SOS FILE PROTECTION
The touch button to protect current file in event an emergency situation.</p> | <p>9. MICROPHONE</p> <p>10. DOWN
Press to navigate down within menus and to move to the previous file when in playback mode.</p> <p>11. LCD SCREEN</p> <p>12. MENU
Press to open the Menu within current mode. Press twice to open the Setup menu.</p> <p>13. EXPOSURE E
Press to toggle through exposure settings.</p> <p>14. MODE
Press to select: Video / Photo / Playback modes.</p> <p>15. MINI USB 2.0 SOCKET
Connect car power cable / USB cable here.</p> <p>16. MOUNTING POINT
Attached supplied windscreen mount here.</p> <p>17. POWER
Press and to turn on/off the iN-CAR CAM.</p> <p>18. START/STOP & OK
Press start, stop a recording or to confirm selection.</p> |
|---|--|

INSTALLATION

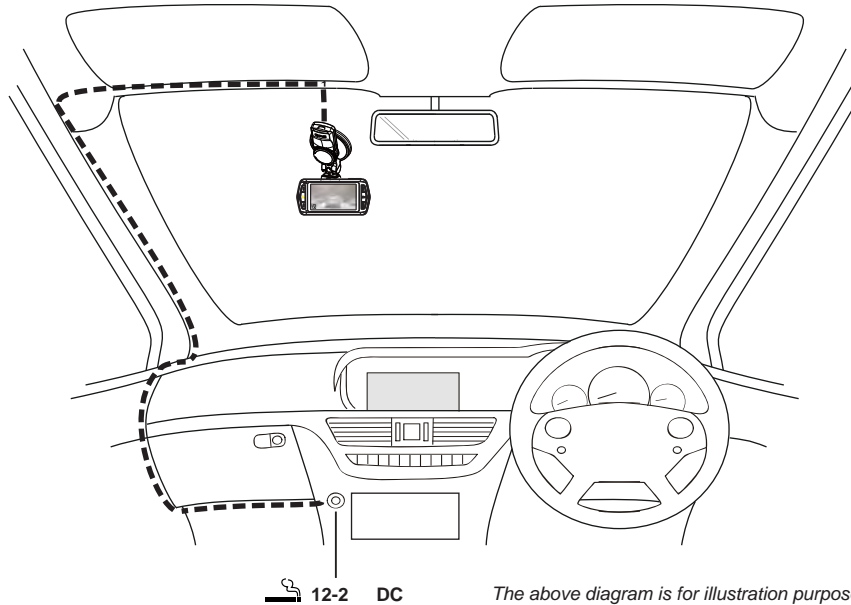

 12-2 DC

The above diagram is for illustration purposes only.

1. Open dust cover and insert a suitable memory card in to the device, taking care to follow correct orientation markings gold contacts facing the back of the device. Push the memory card until it clicks into place and close dust cover. Do not remove or insert the memory card when the iN-CAR CAM is turned on. This may damage the memory card.
2. Attach the device to the supplied windscreen mount, taking care the locking tab has clicked firmly into place.
3. Remove the protective plastic film from the suction pad. Select required position for the windscreen mount and clean windscreen with a dry / clean cloth to achieve good contact between the glass and mount. While holding the suction cup onto the glass push the locking lever upwards to secure the mount to the windscreen. Please ensure that once mounted the iN-CAR CAM is located within the area of the vehicles windscreen wipers to maintain a clear view during rainfall.
 - The angle and position of the iN-CAR CAM can be adjusted by loosening the locking clamp and moving as required, remembering to re-tighten the clamp.
 - Connect the car adaptor to mini-USB socket of the iN-CAR CAM and then plug the supplied car adaptor into the 12-2 Vdc outlet of your vehicle. The device will automatically power on and start recording once power is available. In some vehicles this will be when connections are made, for others the device will power on once the ignition has been turned on.

NOTE:

Our iN-CAR-CAM is shipped with the Screen Saver function set to Default OFF. This is for ease of initial setup. Once setup is complete, the screen saver should be set to 1 seconds, in order to blank the screen completely whilst driving. This avoids any potential distraction and may be a legal requirement in some countries. It is recommended to position your iN-CAR-CAM on the passenger side of the car, behind the rear view mirror, as shown above. Whilst the camera needs to be located in a position within the wiper swept area, do not allow the camera to obstruct your vision of the road ahead. Recommended position is no more than 100mm within the wiper swept area. Do NOT mount the camera directly in front of the driver. Do not place the iN-CAR CAM in such a way that it may interfere with the deployment of air bags or other safety equipment. Do not operate the unit while driving. To reduce the risk of theft, remove the unit and the mount from your vehicle, or position out of sight, before leaving your vehicle unattended. In vehicles where the 12V / 2 V output remains on when ignition is turned off please disconnect the device when not in use. The supplied car adaptor has a 1m long cable to allow cable to be placed neatly within the vehicle. First time use of the device will require the Time and Date to be set. See Page 10 for details.

IDEO MODE

The key below explains the various information displayed on the screen when your iN-CAR CAM is in Video mode, some icons will only be displayed once the relevant function has been selected within the Video menu, as described further down this page.



1. Motion Detection Icon: This icon appears if motion detection is switched on from within the Video menu.
2. WDR Icon: Remains on screen as iN-CAR CAM utilises WDR technology.
3. Video Mode Icon: Indicates the iN-CAR CAM is in Video mode.
 - . Resolution: Displays the current resolution as selected from within the Video menu.
 - . Loop Recording Icon: Displays current recording chunk time setting as selected from within the Video menu.
 - . Exposure Icon: Displays current exposure setting as selected from within the Video menu.
 - . Microphone Icon: Displayed on screen when Audio Recording is selected from within the Video menu.
8. Battery Indicator: Displays battery level, it is recommended to keep the car adaptor plugged in during use.
9. White Balance Icon: Displays White Balance setting as selected from within the Video menu.
10. Compass / Speed Display Icon: Shown on screen when function has been turned on within the Video menu.
11. Driver Fatigue Icon: Shown on screen when function has been turned on within the Video menu.
12. Time: Displays current time as set within the Setup menu.
13. Date: Displays current date as set within the Setup menu.
14. Recording Time: Displays the length of current recording.
15. Memory Card Icon: Icon will be marked with a red cross when there is no memory card inserted.

The Video menu is accessed by using the MENU button located on the rear of the iN-CAR CAM, use the UP and DOWN buttons to navigate through the Menu and press the ENTER button to enter the options screen. Select the required setting press ENTER to confirm, press MENU once more to exit the Video Menu.

The default settings within the iN-CAR CAM have been set to allow you to use the iN-CAR CAM without the need to change any settings, however it is recommended that you explore these settings to familiarise yourself with the product and its capabilities.

Note:

Within the SETUP menu which is accessed from within any mode by pressing the MENU button twice, there is a Default Setting option to allow you to reset the iN-CAR CAM to the factory defaults if required.

PHOTO MODE

English

The key below explains the various information displayed on the screen when your iN-CAR CAM is in Photo mode, some icons will only be displayed once the relevant function has been selected within the Video menu, as described further down this page.



1. Memory Card Icon: Icon will be marked with a red cross when there is no memory card inserted.
2. Quality: Displays the current image quality as set within the Photo menu.
3. WDR Icon: Remains on screen as iN-CAR CAM utilises WDR technology.
 - . Photo Mode Icon: Indicates the iN-CAR CAM is in Photo mode.
 - . Resolution: Displays the current resolution as set within the Photo menu.
 - . Capture Mode Icon: Displayed on screen when Capture Mode timer is selected from within the Photo menu.
 - . Anti-Shaking Icon: Displayed on screen when Anti-Shaking is active, when function is off the icon will be marked with red stop sign.
8. Exposure Icon: Displays current exposure setting as selected from within the Photo menu.
9. IS Icon: Displays the current IS setting as selected within the Photo menu.
10. Battery Indicator: Displays battery level, it is recommended to keep the car adaptor plugged in during use.
11. White Balance Icon: Displays the current White Balance setting as selected within the Photo menu.

The Photo menu is accessed by using the MENU button located on the rear of the iN-CAR CAM, use the UP and DOWN buttons to navigate through the Menu and press the OK button to enter the options screen. Select the required setting press OK to confirm, press MENU once more to exit the Photo Menu.

The default settings within the iN-CAR CAM have been set to allow you to use the iN-CAR CAM without the need to change any settings, however it is recommended that you explore these settings to familiarise yourself with the product and its capabilities.

Note:

Within the SETUP menu which is accessed from within any mode by pressing the MENU button twice, there is a Default Setting option to allow you to reset the iN-CAR CAM to the factory defaults if required.

PLA BACK MODE

The iN-CAR CAM can display both Videos and Photos stored upon the SD card when in Playback Mode. As the displays are slightly different please refer to the two sections below.

VIDEO PLA BACK

When a video is detected upon the SD Card, the screen below is shown. The key below explains the various information displayed on the screen, during video playback and how to use the control buttons.



1. Control Buttons: To scroll through the saved files use the and buttons, to view a chosen video press the button which then acts as a play / pause button. During video playback, the and buttons will serve as rewind and fast forward respectively, once the video is paused press the button to continue scrolling through the saved files.
2. Video Playback Icon: Indicates the iN-CAR CAM is displaying a video in the Playback mode.
3. Protected File Icon: Displayed when a video file has been protected by activation of the internal G Sensor during recording or by selecting Protect from within the playback menu.
 - . File Number: Displays current file number.
 - . Resolution: Displays the resolution that current video was recorded in.
 - . File Date: Displays date current file was recorded.
 - . File Time: Displays start time current file was recorded.

Recommended PC playback software, required for Windows when no internet connection is available:
 QuickTime free download from www.apple.com/uk/quicktime/download
 VLC Media Player free download from www.videolan.org/vlc

PHOTO PLA BACK

When a photo is detected upon the SD Card, then the screen below is shown. The key below explains the various information displayed on the screen, during photo playback.



1. Photo Playback Icon: Indicates the iN-CAR CAM is displaying a photo in the Playback mode.
2. Protected File Icon: Displayed when a photo file has been protected by selecting Protect from within the playback menu.
3. File Number: Displays current file number.
 - . Resolution: Displays the size of current photo.
 - . File Date: Displays date current file was recorded.
 - . File Time: Displays start time current file was recorded.

Note:
 To view the NEXT or PREVIOUS item stored upon the SD Card press the or button respectively.

DRIVING RECORDER PLAYER INSTALLATION

This section will guide you through the installation of the Driving Recorder Player software, designed to enable the viewing of recorded files as well as checking journey route / GPS data location and speed and G Sensor information. Please see following pages for guide on using the Driving Recorder Player.

INSTALLATION FOR WINDOWS**System Minimum Requirements:**

Windows XP, Vista, Windows 7, Windows 8
 Pentium III 600 MHz or Celeron at 800 MHz .
 1 Gb RAM.
 100 Mb hard drive space.
 CD-ROM Drive tray loader only
 1280 x 1024 monitor display

How to install:

Insert the supplied Driving Recorder Player disk inserted in to the CD drive, navigate to the CD and display the contents upon the disk:

Driving Recorder Player for Windows
 Driving Recorder Player for Mac
 NBDVR 03 Driving Recorder Player Installation Guide
 NBDVR 03 Instruction Manual

Should your PC not have a CD Drive or be of the slot loader type then please download the required Driving Recorder Player software from our website: <http://www.nextbase.com>

NOTE: DO NOT insert the small 5cm disk in to a slot loading player or damage may result.

Open the Driving Recorder Player for Windows folder, run the 'setup.exe' file and follow the on-screen instructions. Please refer to the NBDVR 03 Driving Recorder Player Installation Guide for further information.

INSTALLATION FOR MAC**System Minimum Requirements:**

Mac OS X 10.4

How to install:

Insert the supplied Driving Recorder Player disk inserted in to the CD drive, navigate to the CD and display the contents upon the disk:

Driving Recorder Player for Windows
 Driving Recorder Player for Mac
 NBDVR 03 Driving Recorder Player Installation Guide
 NBDVR 03 Instruction Manual

Should your MAC not have a CD Drive or be of the slot loader type then please download the required Driving Recorder Player software from our website: <http://www.nextbase.com>

NOTE: DO NOT insert the small 5cm disk in to a slot loading player or damage may result.

Open the selected folder and run the 'Driving Recorder Player for MAC' .dmg file, this will place the 'Driving Recorder Player' volume on your desktop.

Alternatively, once the required Driving Recorder Player software has been downloaded from given website open the 'Downloads' folder on your Mac. The software is saved in a compressed .zip folder, free de-compression applications are readily available, for example 'The Unarchiver' available from the Mac App Store.

Please refer to the NBDVR 03 Driving Recorder Player Installation Guide supplied with the software for further information.

Note:

Do NOT insert disk into you PC if it uses a slot loader, this will cause damage to your PC not covered under the iN-CAR CAM manufacturers warranty.
 For some operating systems the installation process may vary.
 Player will only open with Windows operating systems when an internet connection is present.

DRIVING RECORDER PLAYER FOR WINDOWS

The key below explains the various information displayed within the Driving Recorder Player when using a Windows platform01



1. **Playback window of selected video file**
View current video, to make full screen double-click on the blue bar at the top of the window.
2. **Date / Time / Model / Vehicle Registration / Speed / GPS Co-ordinates Stamp**
Data saved to the recorded file, this content will vary depending on iN-CAR CAM settings and GPS signal.
3. **Volume**
Adjust playback volume.
4. **Video playback control buttons**
Play / Pause, fast forward and rewind current file, this function is not available on Windows XP.
5. **G Sensor data**
Displays data recorded by the G Sensor across the three axes.
X left/right, Y up/down and Z acceleration / deceleration.

DRIVING RECORDER PLAYER WINDOWS CONTD.

6. Driving Recorder Player controls

 Screen Capture, this will create a still image for each frame of image seen within the playback window.

 Open screen capture folder.

7. Add / Remove files

Used to add and remove selected videos to the file list.

8. Map

Displays route travelled on map, only available when the video files were recorded when satellite connection was present.

9. Compass

Displays current direction, only available when the video files were recorded when satellite connection was present.

Using the Driving Recorder Player

Insert the SD card directly to the card reader on your PC, or connect the iN-CAR CAM as described on Page 1 Mass Storage .

Using the player controls 10 or 11 browse to the SD card and then to the folder which contains the video files you have recorded. Press .

The recorded video files upon the SD card will then appear in the File List window 12 .

Choose a video file to play, by double clicking upon it.

Once the file is playing, you can use the player controls 8 for pause, forward, reverse as required.

Note:

The driving recorder player will only open when an internet connection is available, due to the Google Map function. Should you want to view recorded files at any other time, please open with another video playback program, e.g. QuickTime or VLC.

The driving recorder player's features / functions may vary between different operating systems.

DRIVING RECORDER PLAYER FOR MAC

The key below explains the various information displayed within the Driving Recorder Player when using a MAC platform.



1. **Play back window of selected video file**
View current video.
2. **Date / Time / Model / Vehicle Registration / Speed / GPS Co-ordinates Stamp**
Data saved to the recorded file, this content will vary depending iN-CAR CAM settings and GPS signal.
3. **Volume**
Adjust playback volume.
4. **Video playback control buttons**
Play / Pause, fast forward and rewind current file.
5. **Speed display**
Displays current speed.
6. **G Force display**
Displays direction of G Force on the vehicle.
7. **G Sensor data**
Displays data recorded by the G Sensor across the three axis.
X left/right, Y up/down and Z acceleration deceleration.
8. **File Info**
Displays current file information.
9. **Add / Remove files**
Browse for files stored on your computer, add / remove selected videos to and from the file list
10. **File List**
Displays videos currently within the file list.
11. **Screen Capture**
 - Screen Capture, this will create a still image for each frame of image within the playback window.
 - Open screen capture folder to view images.
12. **GPS co-ordinates**
Displays current GPS co-ordinates, only available when the video files was recorded when satellite connection was present.
13. **Map**
Displays route travelled on map, only available when the video files was recorded when satellite connection was present.
14. **Compass**
Displays current direction, only available when the video files was recorded when satellite connection was present.

MENUS AND SETTINGS

Each mode (Video, Photo and Playback) has a menu used to access the various options and settings, press the MENU button on the rear of the device to access the menu, specific to the current mode selected. Use the UP, DOWN buttons to select chosen option and press the OK button to confirm.

1. VIDEO MODE

1.1 Resolution

Select recording resolution, this will increase or decrease the quality of the recorded video.
Default Setting: 1080P (1920x1080 @ 30Fps)

1.2 Exposure

Select exposure, used to adjust exposure level for different light conditions.
Default Setting: 0

1.3 White Balance

Adjust the white balance for different light conditions.
Default Setting: Auto

1.4 Record Audio

Turn On / Off audio recording.
Default Setting: On

1.5 Date Stamp

Turn On / Off the date stamp shown on recorded files.
Default Setting: On

1.6 Loop Recording

Select duration of recording length for the individual video files, the iN-CAR CAM will fill the SD Card then loop back to the beginning, overwriting the saved files (unless protected).
Default Setting: 3 Minutes

1.7 G Sensor

Turn Off or adjust the sensitivity of the G Sensor, it is the G Sensor that detects forces which will automatically protect the current recording in event of a collision.
Default Setting: Middle

1.8 Motion Detection

Turn On / Off the motion detection function, the device will need to remain on and will start a 10 second recording when a change to the viewed scene is detected.
Default Setting: Off

1.9 Number Plate

Enter the registration number for your vehicle, this will then be shown on the video file.
Default Setting: *****

1.10 Driver Fatigue Warning

Set the timer which will display an image of a hot beverage to serve as a reminder to take sufficient rest when on a long journey.
Default Setting: Off

1.11 GPS Track

Turn On / Off the GPS co-ordinate stamp shown on recorded files, co-ordinates and map will function as normal when viewed with the Driving Recorder Player no matter whether this function is set to On or Off.
Default Setting: On

1.12 Compass

When turned on, the screen will display current speed and a compass after the selected period of time, press any button to return to normal viewing, this function is only available when a GPS connection is present.
Default Setting: Off

1.13 Password Settings

Set a password that will need to be entered to access menus and settings, only basic functions of power on / off and start / stop remain available.

1.13 Speed Units

Select whether to record and display speed in KMH or MPH.
Default Setting: MPH

1.14 Rotate Display

Rotate the display 180°, particularly useful should iN-CAR CAM be mounted on the dashboard, the control button functions do not rotate.

MENUS AND SETTINGS (CONTD.)**2. PHOTO MODE****2.1 Image Size**

Select image size, this will increase or decrease the size of the recorded image
Default Setting: 5M

2.2 Colour

Adjust the colour effect of the recorded image.
Default Setting: Normal

2.3 Anti-Shaking

Turn On / Off the anti-shaking feature, may help reduce image being blurred under some circumstances.
Default setting: On

2.4 Capture Mode:

Turn On / Off the timer function, when this feature has been turned on, the iN-CAR CAM will take a photo the selected period of time after the OK button has been pressed.
Default Setting: Single

2.5 White Balance

Adjust the white balance for different light conditions.
Default Setting: Auto

2.6 ISO

Adjust the ISO setting, the brighter the conditions the lower the ISO required.
Default setting: Auto

2.7 Exposure

Select exposure, used to adjust the amount of light received by the sensor.
Default setting: 0

2.8 Date Stamp

Turn Off the date stamp shown on recorded photographs, can also change to date only.
Default setting: Date / Time

2.9 Quality

Increase or decrease the quality of the recorded image.
Default Setting: Normal

2.10 Sharpness

Adjust the sharpness of the recorded image.
Default Setting: Normal

3. PLAYBACK MODE

The playback menu is the same when viewing either videos or photos.

3.1 Delete

Used to delete the current file, also available is the option of deleting all files.

3.2 Protect

Used to lock or unlock the current file, also available is the option of locking and unlocking all files.

3.3 Slide Show

Used to start a slide show of images stored on the SD card, press the Menu button to exit the slide show.

MENUS AND SETTINGS CONTD.

. SETUP MENU

There is also a Setup menu for the general settings, press the MENU button twice on the rear of the device to access the menu. The options and settings available are described below.

.1 Wi-Fi

The Wi-Fi function allows you to view videos whilst recording, adjust the setting, control the basic functions record, play, pause etc. and playback videos directly to your smartphone or tablet Default Setting: ff.

.2 Format

Format the inserted memory card, this will delete all content.

. Language

Set the language as required.
Default Setting: English

. Date / Time

Adjust the date / time as required using the button to toggle through fields, **↕** and **↘** to set variables.
Note: In event of battery becoming fully dis-charged, the date will reset to 01/01/2013.

.5 Frequency

Set the Frequency as required.
Default Setting: 0H

.6 LED Light

Turn on the IR LEDs for enhanced nighttime recording.
Default Setting: ff

.7 Beep Sound

Turn ff / n the beep sound, note if Beep is turned off the audible low-battery warning will also be disabled.
Default Setting: n

. Screen Saver

Turn on the Screen Saver function, shut down the screen after a period of inactivity, with options of 10 Seconds, 30 Seconds and 2 Minutes. Press any button to re-activate the display.
Default Setting: ff

.9 TV Mode

Set the TV Mode as required.
Default Setting: PAL

.10 Speed Stamp

Turn n / ff the Speed stamp shown on recorded files.
Default Setting: n

.11 Version

Display the version number of your device's software.

.12 Default Setting

Reset the device to the default settings.

.1 Auto Power Off

Adjust the timing of the Auto Power ff function, this can be used to continue recording in event of loss of power within the vehicle, with options of 10 Seconds. 2 Minutes and Minutes.
Default Setting: 10 Seconds

PC CONNECTION

Connecting the iN-CAR CAM to a Windows based PC using the supplied USB Cable will automatically trigger the iN-CAR CAM to display the two options of:

- Mass Storage
- PC Camera

Use the UP and DOWN buttons to select preferred option and OK to confirm.

■ Mass Storage

If Mass Storage is selected, the iN-CAR CAM screen will show the words 'Mass Storage' and then take the function of an SD Card reader for your PC. Upon your PC an extra drive will appear (e.g. Drive E:) and you will be able to navigate through the SD Card and view / manage stored files.

This feature is useful if you do not have an SD Card reader built in to your PC.

■ PC Camera

If PC Camera is selected, the iN-CAR CAM screen will show the words 'PC Camera' and then take the function of a Webcam (no audio) for your PC. Start the normal application upon your PC that uses a webcam (e.g. Skype) and select the webcam which is entitled 'USB Video Device'.

This feature is useful if you do not have a Webcam built in to your PC.

Note:

The iN-CAR CAM is only compatible with the following Windows based operating systems: XP, VISTA and Windows 7.

MAC CONNECTION

Connecting the iN-CAR CAM to a MAC using the supplied USB Cable will automatically trigger the iN-CAR CAM to display the following options:

- Mass Storage
- PC Camera

Due to compatibility issues ONLY the Mass Storage function is available when used with MAC operating systems.

Press OK to confirm Mass Storage function is required.

■ Mass Storage

If Mass Storage is selected, the iN-CAR CAM screen will show the words 'Mass Storage' and then take the function of an SD Card reader for your MAC. Upon your MAC the memory card within your iN-CAR CAM will appear on your desktop labelled 'NO NAME' and you will be able to navigate through the SD Card and view / manage stored files.

This feature is useful if you do not have an SD Card reader built in to your MAC.

VIDEO & AUDIO OUTPUT

High Definition Output

As you connect a High Definition Cable between the iN-CAR CAM and your television, the iN-CAR CAM screen will blank, as all output is now visible upon your television. The external monitor can now be used for playback and as a larger viewfinder in Photo mode. Recordings can NOT be made in Video mode with HD connected. The controls upon the iN-CAR CAM operate for the Play / Pause, STOP, Next / Previous and Fwd / Rev functions as shown on screen.

Standard Definition Output

As you connect an AV Cable (sold separately) between the iN-CAR CAM and your television, the iN-CAR CAM screen will blank, as all output is now visible upon your television. All elements of the Video, Photo and Playback are available via the AV output so you can monitor your recordings upon a larger screen instantly (useful for when using your iN-CAR CAM as a rear facing camera while connected to another device for viewing). The controls upon the iN-CAR CAM operate normally.

Please contact your local NEXTBASE dealer for accessory purchases.

FINALCAM (Wi-Fi) APP FOR IOS

The Wi-Fi function allows you to use your smartphone to view videos during recording, adjust the DVR4063 settings, control the basic functions (record, play, pause, etc.) and playback videos directly to your smartphone.

The FinalCam App is available for free download from the App Store for Apple smartphones.

Installing the App on an iOS smartphone:

Open the App Store on your iOS smartphone and search for the 'FinalCam' App, tap on 'Get' to install.



Once installed, the FinalCam App will now be available on your home screen of your phone.



FINALCAM (Wi-Fi) APP FOR ANDRIOD

The Wi-Fi function allows you to use your smartphone to view videos during recording, adjust the DVR4063 settings, control the basic functions (record, play, pause, etc.) and playback videos directly to your smartphone or tablet.

The FinalCam App is available for free download from Google Play for Android smartphones.

Installing the App on an Android smartphone:

Open Google Play on your Android smartphone and search for the 'FinalCam' App, tap on 'Install' and then 'Accept'.

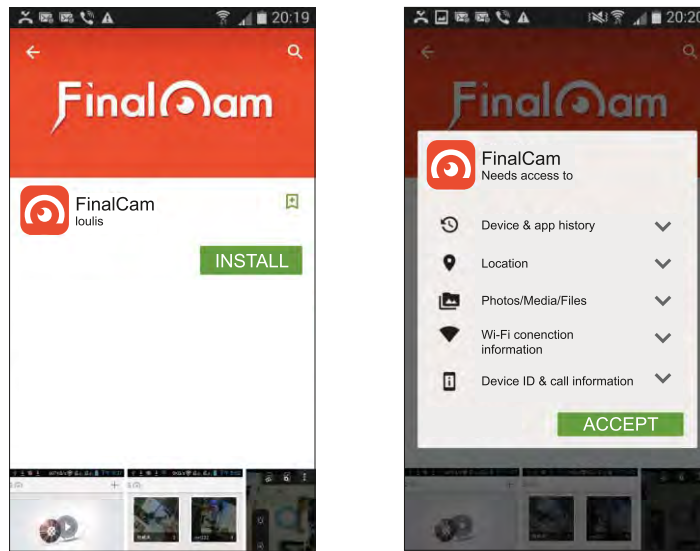

Once installed, the FinalCam App will now be available on your home screen of your phone.



FINALCAM (Wi-Fi) APP FOR ANDRIOD & IOS (CONTD.)**Turn on the DVR4063 Wi-Fi**

To turn on the Wi-Fi function on the DVR4063, go to the General Settings menu (press menu twice), select 'Wi-Fi' and press OK. The 'On' option will be highlighted, press the OK button to confirm.

The menu window will close and the 'AP Mode' (Access Point Mode) window will open, as shown below.

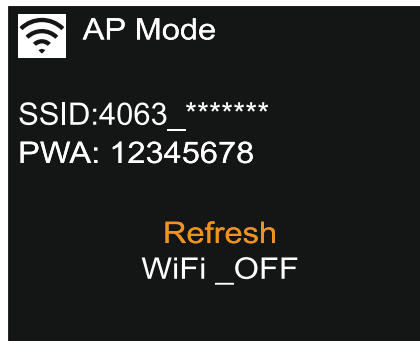

This screen gives the name of the DVR4063 SSID (network name): '4063_*****' and also the password: 12345678.

FINALCAM (Wi-Fi) APP FOR ANDRIOD & IOS (CONTD.)

Connect your phone to the DVR4063

To connect your phone to the DVR4063 open the Wi-Fi connections menu on your phone, the DVR4063 will be shown in Wi-Fi networks list as '4063_*****'.

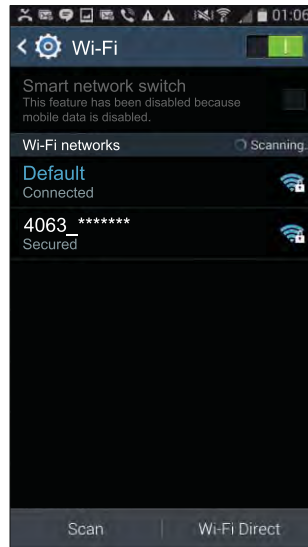

Tap on the '4063_*****' and when prompted enter the password '12345678'. Once successfully connected the 'WiFi Connected' window will appear on the DVR4063 screen.

FINALCAM (Wi-Fi) APP FOR ANDRIOD & IOS (CONTD.)**Using the FinalCam App**

Open the App by tapping on the FinalCam button on your phone, the first time the App is opened the 'Please click "+" to add camera' screen will appear, see image below.

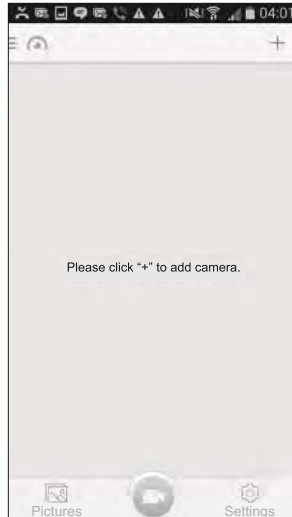

Tap on the '+' button, select '4063_*****' from the available networks, as shown below.

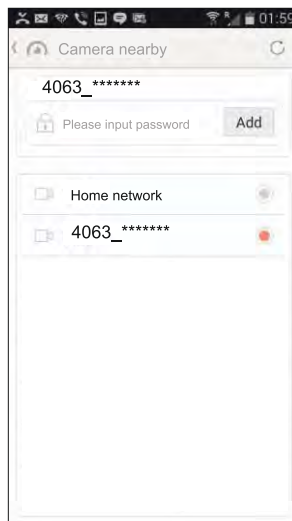

Enter the password '12345678' and tap 'Add', the live video screen will appear. Press back on your smartphone to go to the FinalCam home screen, as shown on next page.

FINALCAM (Wi-Fi) APP FOR ANDRIOD (CONTD.)

The key below describes the various information, functions and features available within the FinalCam home screen.

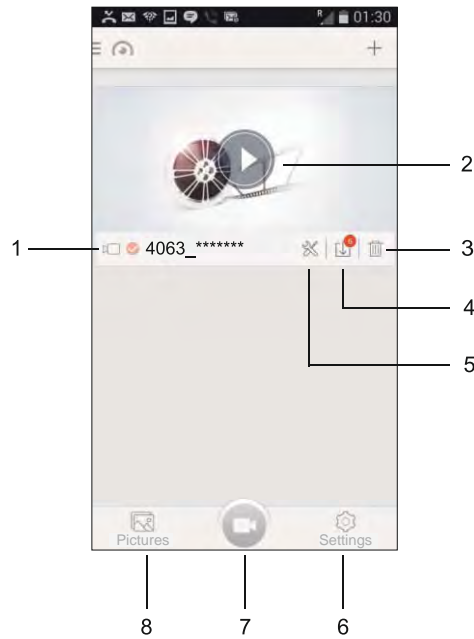

1. Camera name
2. Open camera
Tap here to control the DVR4063.
3. Remove camera
Tap here to remove the DVR4063 from the FinalCam App.
4. Recordings
Tap here to view the video files currently stored on the DVR4063 memory card. To playback a recording on your phone you will need to download the video file from the DVR4063, to do this simply tap on the preview window. The download will start immediately to your smartphone.

Multiple files can also be downloaded, tick the files for download and then tap the download icon in the bottom left of the screen. However this is not recommended as transfer time would be long.

Note:

- Downloading files to the FinalCam App will remove the files from the BikeCam, so they can be viewed on your smartphone directly thereafter.

FINALCAM (Wi-Fi) APP FOR ANDRIOD & IOS (CONTD.)

Continued from previous page.

5. Camera Settings:**Camera Name (SSID) –**

Change the SSID from the default setting of '4063_*****' and press the save icon.

Password –

Change the Password from the default setting of '12345678' and press the save icon.

Note:

- Changing the SSID or Password will disconnect the DVR4063 from your phone, simply re-connect using the new details.
- Using the 'Default Settings' option to return the DVR4063 to the default settings will NOT reset the SSID or Password.

Auto Recording –

This function is unavailable, as the DVR4063 manages the recording mode.

Video Quality –

Adjust the video quality settings used by the DVR4063.

Format –

Format the inserted memory card within the DVR4063, this will delete all content.

Advanced Settings –**G-Sensor sensitivity:**

Turn Off or adjust the sensitivity of the G Sensor used by the DVR4063 to protect files.

TV Mode:

Adjust the video output when using a television to view content from your phone.

Recording file interval:

Select duration of recording length for the individual video files, the DVR4063 will fill the SD Card then loop back to the beginning, overwriting the oldest files (unless protected).

Note:

The Off and 10 Minute functions listed within the FinalCam settings are unavailable and are not to be selected.

Factory Reset

Reset the device to the default settings.

Camera Info –

Displays the SW version of the DVR4063.

FINALCAM (Wi-Fi) APP FOR ANDRIOD & IOS(CONTD.)

Continued from previous page.

6. FinalCam settings
 - Storage Management -
Manage the storage capacity of files downloaded from the DVR4063 to the Final Cam App.

 - Language –
Select language used within the FinalCam App.

 - About –
FinalCam version, with option to check whether there is an update available.

7. FinalCam home screen
Tap here to return to the home screen from the FinalCam settings or Downloads screens.

8. Downloads
Files that have been downloaded from the DVR4063 can be viewed here.

FINALCAM (Wi-Fi) APP FOR ANDRIOD & IOS (CONTD.)

Basic operation

Tap the 'Open camera' button on the home screen to start using the DVR4063.

Please see below for a guide to the functions and features available when using the FinalCam App.

Note:

- Tap on the live image screen to bring up the menu selection as shown below.

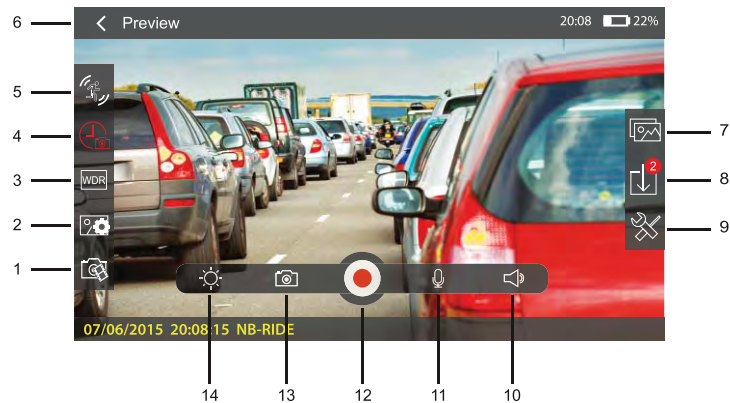

1. FinalCam resolution
Adjust the viewing resolution of the DVR4063 App.

Note:
- Options available depend on the recording resolution setting of the DVR4063 itself.
2. Image resolution
This function is unavailable, as the DVR4063 manages the resolution used for still images.
3. WDR
This function is unavailable, as the DVR4063 utilizes WDR technology permanently to optimise the image quality of the recorded files.
4. Recording length
This function is unavailable, as the DVR4063 manages the recording lengths of the video files.
5. Anti-shake
This function is unavailable, as the DVR4063 utilizes Anti-Shake technology permanently to optimise the image quality of the recorded files.
6. Back / Preview button
Tap here to return to the previous screen / menu.
7. Downloads directory
Tap here to open the downloads directory to view downloaded recordings or images.

FINALCAM (Wi-Fi) APP FOR ANDRIOD & IOS (CONTD.)

English

Continued from previous page.

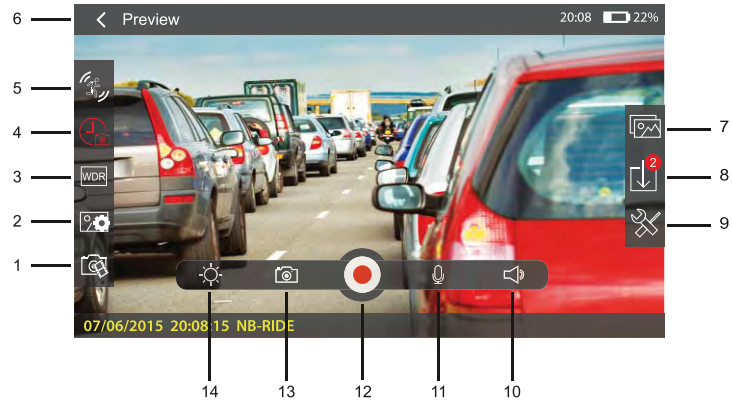

8. File List
Tap to open the file list, this will list recordings or image that are stored on the memory card and have yet to be downloaded to your phone.
9. Camera Settings
Tap here to open The Camera Settings menu (described earlier).
10. Volume
Adjust the volume level of your phone.
11. Microphone
This function is unavailable, as the DVR4063 manages the microphone on or off settings.
12. Record
Tap to start / stop recording.
13. Take a photo
Tap to take a still image, the image file will be saved to both the DVR4063 and downloaded to your smartphone immediately.
14. Brightness
Adjust the brightness of your phones screen.

FINALCAM (Wi-Fi) APP FOR ANDRIOD (CONTD.)

Playback of video files

Once a recording has been downloaded from the BikeCam to you phone you can use the FinalCam App to playback the recording.



1. **Filename**
The filename of the recording being viewed.
2. **Back button**
Tap here to return to the previous screen / menu.
3. **Favourites**
Tap to download the current file to the 'Favourites' folder within the File List directory.
4. **Repeat**
Tap to toggle through the repeat options.
5. **Delete**
Tap here to delete current file.
6. **Volume**
Adjust the volume level of your phone.
7. **Play / Pause**
Tap here play / pause
8. **Brightness**
Adjust the brightness of your phones screen.

Notes:

- When connected to the BikeCam your mobile device will not have access to the internet.
- Should your BikeCam become unresponsive (e.g. no function or no button response) whilst using the FinalCam App please use the RESET button on the rear of the BikeCam to restart the BikeCam.
- Only a single BikeCam can be connected to the App at any one time.

FINALCAM (Wi-Fi) APP FOR iOS (CONTD.)**Using the FinalCam App**

Open the App by tapping on the FinalCam button on your phone, the first time the App is opened the 'Please add a camera' screen will appear, see image below.

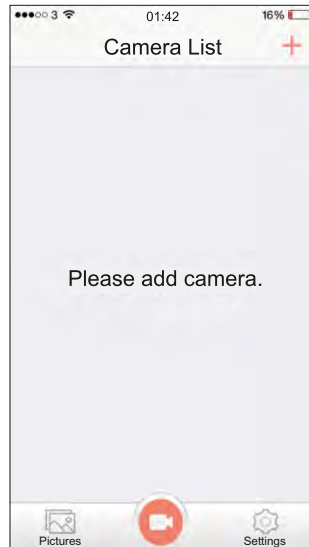

Tap on the '+' button, the 'Camera is connecting...' and then the 'Add device successful' screens will appear, as shown below.

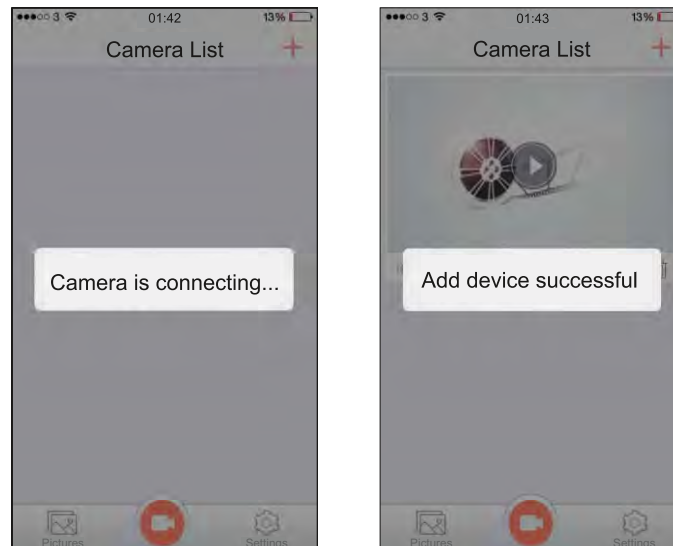

Enter the password '12345678' and tap 'Add', the live video screen will appear. Press back on your smartphone to go to the FinalCam home screen, as shown on next page.

MASS STORAGE & PC CAMERA

Use the supplied USB cable to connect the DVR4063 to your PC, doing so will power on the camera with two functions available, as described below.

Use the UP and DOWN buttons to select required function and press OK to confirm selection.

- Mass Storage
- PC Camera

Using the DVR4063 with a Windows PC:

Mass Storage

When Mass Storage is selected, the DVR-4063 screen will show the words 'Mass Storage' and then take the function of an SD Card reader for your PC.

An extra drive will appear, for example 'Removable Disk (D:)' and you will be able to view / manage the stored files upon the MicroSD card within the DVR4063, from your computer.

PC Camera

When PC Camera is selected, the DVR4063 screen will show the words 'PC Camera' and then take the function of a webcam (no audio) for your PC.

Start the normal application upon your PC that uses a webcam (e.g. Skype) and select the DVR4063 which is entitled 'CARDV'.

Note:

- Turn Off the DVR4063 before disconnecting from PC.

Using the DVR4063 with a MAC:

Mass Storage

When this option is selected, the DVR4063 will function as a card reader for your MAC. The 'NEXTBASE' external USB disk icon will appear on your MAC and you will be able to view / manage stored files upon the MicroSD card within the DVR4063, from your Mac.

Eject the disk as you would do normally before removing the cable or turning off the DVR4063.

PC Camera

When this option is selected, the DVR4063 will function as a webcam (no audio) for your Mac. Start the normal application upon your PC that uses a webcam (e.g. Skype) and select the DVR4063 which is entitled 'CARDV'.

Note:

- When Mass Storage or PC Camera modes are selected the DVR4063 screen will blank.
- When using PC Camera or Mass Storage functions turn Off the BikeCam before disconnecting the USB cable from your MAC.

TROUBLE SHOOTING

Video Image is blurred.	Remove the protective lens cover, clean the lens, clean the windscreen
I can not insert the Micro SD card.	Micro SD card are very small and require delicate use. Align the card with the diagram shown upon the device and insert the card until you feel a slight spring resistance. You now need to push the card, using your finger nail, until you hear and feel a small latch. Release pressure and the card will stay retained within the device.
I can not remove the Micro SD card.	With the card previously installed, you now need to push the card further inwards slightly, using your finger nail, until you hear and feel a small latch. Release pressure and the card will spring out sufficiently for you to take hold of it.
Video files can not be played.	The video files from the iN CAR CAM are in MOV format and may not be compatible with your PC if suitable playback software is not installed. Install the supplied Driver Recorder Player software and the additional Codecs if necessary.
Video file playback is jumpy.	Remove the SD card and reformat to remove non-contiguous files. For best recording use a branded class 10 type 30MB/s SD card of 8 to 32 GB recommended size. Recommended video playback software is the supplied Driver Recorder Player Playback. PC may not be sufficient for the playback task, try an alternative PC.
Playback upon the Driver Recorder Player is jumpy.	The Codecs upon your PC may not be compatible or the latest standard. Download the latest Codecs from http://www.next-base.com and install them accordingly
The sound is not synchronised with video during playback.	The Codecs upon your PC may not be compatible or the latest standard. Download the latest Codecs from http://www.next-base.com and install them accordingly
Video has no sound.	Ensure that Record Audio setting is turned ON within the Video Menu.
Photograph is blurred.	Hold the camera still whilst taking the photo. Please be aware the photo is taken around 1 second after the shutter noise is heard.
I can only record a few minutes of video on my SD card.	Change the recording size Loop recording function to a smaller size. Increase the size of the SD card. Max 32GB.
Mass Storage or PC Camera function does not work.	The Mass storage function will work on both Windows and Mac, however the PC camera is only Windows compatible. Restart the PC, as this may be required for the necessary driver to be loaded correctly. Disconnect and reconnect the In-CAR CAM. Contact NEXTBASE for the required driver.
The sucker will not stay in place upon my windscreen.	Ensure that the protective cover plastic film has been removed from the suction pad. Moisten the sucker slightly before affixing upon the windscreen. Ensure that the lever is fully pushed towards the windscreen. Make sure that the glass is smooth and clean. Do not stick to glass that has any non-smooth effect or paint whatsoever. Affix to the glass firmly and then push the lever to the full extent.
The AV out from my iN-CAR CAM just buzzes on my TV.	Ensure that the AV cable is correct. Use a stereo 3.5mm jack plug where the tip is the video and the ring is the audio signal.
I get the message Card Error on screen.	The SD card has become unuseable by the iN-CAR CAM. Remove useful files using your PC and then perform a FORMAT upon the SD card from within the SETUP menu.
I get the message Memory error on screen.	The SD card has become unuseable by the iN-CAR CAM. Remove useful files using your PC and then perform a FORMAT upon the SD card from within the SETUP menu.
I get the message Card Full on screen.	The SD card has become full as the Loop recording function is set to OFF. Set the Loop Recording function to 3 mins default to enable the cycle recording function and automatic deletion of older files.

TROUBLE SHOOTING CONTD.

My iN-CAR CAM shuts down by itself after a while.	Either the battery has gone flat, or there is no power to the iN-CAR CAM and the AutoPower off period which is in the SETUP menu has been triggered.
The SD card in my iN-CAR CAM can not be read.	Use a good quality branded SD card between 1GB and 32GB suggested and format the card from within the SETUP menu of the iN-CAR CAM.
I can't delete files on my SD card within the iN-CAR CAM.	Check to see if these files are 'protected', if so please follow instructions to 'un-protect'
The screen blanks after a few minutes upon my iN-CAR CAM.	The screen saver is set to 10. Change settings to 00 if required. Default setting is off.
I get the message Cluster Wrong on screen.	The SD card has been formatted in another device and the Cluster Size is not compatible. Simply use the MENU, SETUP option to re-format the SD card from within the iN-CAR CAM.
The Driving Recorder Player will not open.	For Windows operating systems the player requires an internet connection to open, if this is not available please view files using alternative playback software, i.e. QuickTime or VLC.
The iN-CAR CAM can not lock onto satellite	After power on and with the device mounted with clear view of the sky it can take up to 10 minutes to find the three satellites required to achieve a stable signal. Reception can also be affected by atmospheric conditions and the proximity of buildings / trees obscuring the sky.
I have turned on motion detection and now can't stop the recording.	The iN-CAR CAM will start a recording whenever motion is detected, when function is to be turned off firstly shutdown the iN-CAR CAM and remove the SD card, this will avoid recording being activated accidentally. Switch back on the and within the setting menu and turn off the Motion Detection .
The battery will not charge.	To protect from over-charging the battery will only charge when the iN-CAR CAM is turned on.
The battery only last 30 seconds	The battery will only receive charge when the iN-CAR CAM is turned on, please reconnect car adaptor and leave the iN-CAR CAM turned on. Charging takes approximately 90 minutes and a full charge is indicated by a red LED.
The battery only lasts 10 minutes.	This is normal, the battery design allows the 'Auto Power off' feature to function in event of power loss within the vehicle. It is not intended as an alternative power source to replace the supplied car adaptor.

This device complies with part 15 of the FCC Rules. Operation is subject to the condition that this device does not cause harmful interference. 1. This device may not cause harmful interference, and 2. This device must accept any interference received, including interference that may cause undesired operation.

Changes or modifications not expressly approved by the party responsible for compliance could void the user's authority to operate the equipment.

NOTE: This equipment has been tested and found to comply with the limits for a Class B digital device, pursuant to Part 15 of the FCC Rules. These limits are designed to provide reasonable protection against harmful interference in a residential installation. This equipment generates, uses and can radiate radio frequency energy and, if not installed and used in accordance with the instructions, may cause harmful interference to radio communications. However, there is no guarantee that interference will not occur in a particular installation.

If this equipment does cause harmful interference to radio or television reception,

which can be determined by turning the equipment off and on, the user is encouraged to try to correct the interference by one or more of the following measures:

- Reorient or relocate the receiving antenna.
- Increase the separation between the equipment and receiver.
- Connect the equipment into an outlet on a circuit different from that to which the receiver is connected.
- Consult the dealer or an experienced radio/TV technician for help.

To maintain compliance with FCC's RF Exposure guidelines, This equipment should be installed and operated with minimum distance between 20cm the radiator your body: Use only the supplied antenna.