

Uniden[®]

APPCAM23A

User's Manual



Rev. 1, October 2013

CUSTOMER CARE

At Uniden®, we care about you!

If you need assistance, please do NOT return this product to your place of purchase. Our customer care specialists are available to serve you.

Quickly find answers to your questions by:

1. Reading your owner's manual, included with this product.
2. Visiting our customer support website at www.uniden.com.
3. Calling our customer care specialists at 1-800-658-8068.

Images in this manual may differ slightly from your actual product.

CONTENTS

CUSTOMER CARE	2
PLEASE READ BEFORE YOU START	4
WIRELESS DEVICES OPERATING RANGE....	4
IMPORTANT SAFETY PRECAUTIONS	4
OVERVIEW	5
FEATURES.....	5
System.....	5
AppCam 23 Indoor/Outdoor Camera	6
Uniden's AppCam App.....	6
WHAT'S INCLUDED	7
PARTS OF THE CAMERA	8
QUICK START.....	9
PREREQUISITES.....	9
STEP 1 – CONNECT APPCAM TO THE NETWORK.....	9
STEP 2 – SET UP CAMERA	9
STEP 3 – INSTALL CAMERA	10
OPERATION OVERVIEW	10
SETUP AND INSTALLATION.....	12
DETAILED SETUP PROCEDURES.....	12
Step 1 – Connect AppCam to the Network.....	12
Step 2 – Set Up Camera	13
Step 3 - Install Cameras.....	18
DETAILED APPCAM 23 INSTALLATION PROCEDURES.....	19
Mount the AppCam 23 Base	19
Attach the Camera - AppCam 23.....	20

USING THE APP	21
ACCESSING YOUR CAMERAS	21
SNAPSHOT VS LIVE VIDEO SCREEN	21
SNAPSHOT SCREEN OVERVIEW	22
Add Another Camera.....	22
System Settings	22
Update	23
Information.....	23
System Information - Advanced Screen Details	24
Delete Camera Connection	26
Event List Details	26
LIVE VIDEO SCREEN OVERVIEW	27
View Recorded Files	28
TURN OFF THE APP	29
MAINTAINING YOUR SYSTEM.....	30
TAKING CARE OF YOUR CAMERA.....	30
TROUBLESHOOTING.....	31
HOW TO IMPROVE THE WIRELESS SIGNAL QUALITY.....	31
SPECIFICATIONS	34
MICROSD CARD APPROXIMATE RECORDING TIME	35
FCC COMPLIANCE	35
IC COMPLIANCE INFORMATION	36
CE COMPLIANCE INFORMATION	37
ONE-YEAR LIMITED WARRANTY	37

Uniden surveillance products are not manufactured and/or sold with the intent to be used for illegal purposes. Uniden expects consumer's use of these products to be in compliance with all local, state and federal law. For further information on video surveillance and audio recording legal requirements, please consult your local, state and federal law.

© 2013. All rights allowed by law are hereby reserved.

PLEASE READ BEFORE YOU START

WIRELESS DEVICES OPERATING RANGE

Ensure the signal reception viewed between the camera(s) and the WiFi router. If necessary, reduce the distance between the camera(s) and the WiFi router to improve overall system performance.

IMPORTANT SAFETY PRECAUTIONS

Damages caused by non-compliance with this operating manual will void the warranty! We will not assume any liability for damages to items or persons caused by improper handling or non-compliance with the safety notices! Any warranty claim will be null and void in such cases.

- Do not drop, puncture or disassemble the camera; otherwise the warranty will be voided.
- Never tug on the power cords. Use the plug to unplug it from the outlet.
- Do not expose the camera to high temperature or leave it in direct sunlight. Doing so may damage the camera or cause temporary camera malfunction.
- Use the devices with care. Avoid pressing hard on the camera body.
- For your own safety, avoid using the camera or power off the camera when there is a storm or lightning.
- Disconnect the power adapter during long periods between usage.
- Use only the accessories and power adapters supplied by the manufacturer.

OVERVIEW

Uniden's AppCam system works with your smartphone or wireless device to create a powerful home security network. No PC interface is needed to view video on your smartphone or wireless devices. Connect the camera through your WiFi router, setup the network on your mobile device, and install the cameras; your network is up and running. The wireless AppCam offers superior quality video with true color. It is suitable for day or nighttime use.

The AppCam 23 camera is an indoor/outdoor camera that is weatherproof and has an IP66 weather rating. Water can be sprayed on it and it will still work; however, the camera cannot be submerged underwater.

Although this camera can be exposed directly to the rain, it is recommended that, if it is used outdoors, it be mounted under some type of cover like a patio overhang or eave. As rainwater drops start to dry on the camera glass, it can create spots that will reflect the light from the infrared LEDs used for night vision, thus causing lower quality video.

Also, as dust, grime, and cobwebs accumulate on the camera glass, they can reflect light from the infrared LED and might lower video quality. Periodically clean the lens glass with a soft cloth.

FEATURES

System

- No PC required
- Direct connection to router
- WiFi connection to router
- P2P connection

- Records VGA up to 30fps
- Manual/motion recording to microSD (not included)
- Supports up to 32GB microSD (not included)
- High quality H.264 video
- Audio reception





AppCam 23 Indoor/Outdoor Camera

- IP66 weather-rated
- IR cut filter switch
- Compact design
- Night vision range – 25 feet
- Built-in microphone
- microSD card slot (microSD card not included)

Uniden's AppCam App

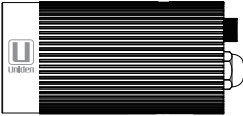
- Multiple camera viewing and management from single app
- Remote access to recorded video
- Remote snapshot & recording control
- Event notification/email alert

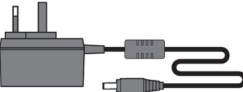
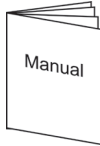
WHAT'S INCLUDED

		
Camera	Camera Stand	Antenna
		
5V/1A Power Adapter	Owner's Manual	Screws and Anchors
Not Shown - Ethernet jack cap		

If any items are missing or damaged, contact our Customer Care Line immediately at 1-800-658-8068.

Never use damaged products!

PARTS OF THE CAMERA

Front



Back

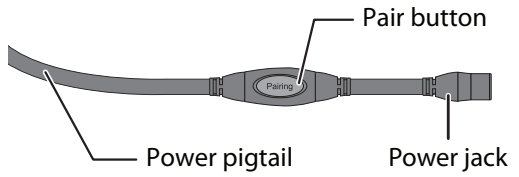
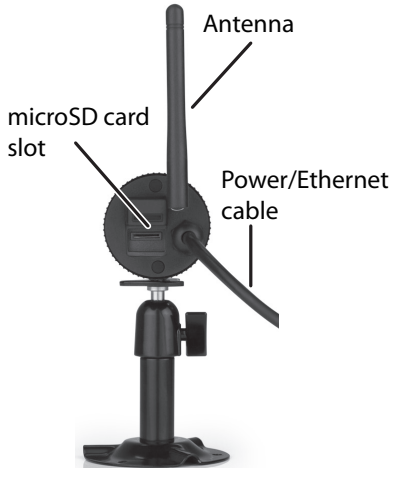

QUICK START

This section provides a basic overview on setting up your system. If you need more specific details, refer to Setup and Installation on page 13.

PREREQUISITES



- Your router security level must support DHCP protocol and the DHCP option must be turned on.
- The AppCam and your mobile device must connect to the same WiFi router for setup.
- Available WiFi-enabled mobile device such as Android or iPhone smartphone or tablet.

STEP 1 – CONNECT APPCAM TO THE NETWORK

Power up your camera and connect it to the router. Attach the antenna to the AppCam 23.

STEP 2 – SET UP CAMERA

Download Uniden’s AppCam app (“Uniden AppCam”) onto your mobile device. Follow the instructions to set up a new system on your mobile device. When the camera and mobile devices are connected and you can see video on the mobile device, set up WiFi network management.

1. Tap  to return to the *Snapshot* screen then tap the  icon.
2. Three icons display on the screen. Tap the  icon. The *System Information* screen displays with the e-mail option as well as the *Advanced* tab.

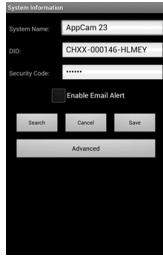

Android

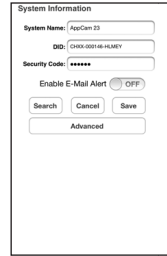

iOS

3. Tap *Advanced*. The screen prompts you to enter the system password.
4. Enter 123456 (default) or the password you have selected and tap **OK**. The *Advanced Settings* screen displays with a series of fields in individual blocks.
5. Scroll to *WiFi Setting*.

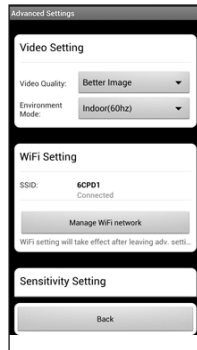

Android

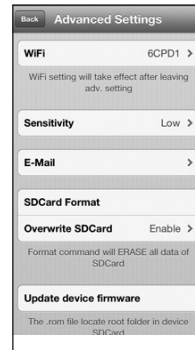

iOS

6. Tap **MANAGE WIFI NETWORK** (Android) or **WIFI** (iOS). A dropdown list displays available networks. Select the network you want to connect to and enter the password for your router. Tap **OK**, then tap **BACK** (at the bottom of the screen for Android or the top of the screen for iOS).



Android



iOS







7. The camera resets and turns on WiFi.
8. Verify that your wireless device can still view live video from the wireless camera.
9. You can now unplug the Ethernet cable connecting the camera to the router.

STEP 3 – INSTALL CAMERA

Take your camera to the location where you are considering installing it. Verify that reception from that spot is acceptable. Attach the camera stand (if needed) and install the camera. Attach the Ethernet jack cap.

Refer to page 19 for detailed camera installation procedures if needed.

OPERATION OVERVIEW

To Do This ...	Do This:
View Recorded Files	<ol style="list-style-type: none"> 1. From the <i>Snapshot</i> screen, tap . 2. Tap  from the three icons displayed on the snapshot image. 3. Tap your selection from the list of recorded files that now displays. The recorded video begins playing.
View Live Video	Tap the image on the <i>Snapshot</i> screen.
View Snapshots	Your snapshots are named with a time stamp and saved into the Photo gallery/Snapshot folder on your mobile device.
Start Recording	From the <i>Live Video</i> screen, tap  . The camera will record for 2 minutes.
Delete Recorded Files	<ol style="list-style-type: none"> 1. From the <i>Snapshot</i> screen, tap . 2. Tap  from the three icons displayed on the snapshot image. A list of recorded videos displays. 3. Android - Tap the pencil icon at the bottom of your list of recorded files. You can now tap the X to select a file to delete. iOS - Tap DELETE ALL or DELETE ONE from the icons along the bottom of the event list.
Take a Snapshot	<ol style="list-style-type: none"> 1. From the <i>Live Video</i> screen, tap . 2. The snapshot is saved on your mobile device.

SETUP AND INSTALLATION

Perform these procedures for each camera.

DETAILED SETUP PROCEDURES

Step 1 – Connect AppCam to the Network

You can attach the camera stand to the camera before beginning but it is not necessary.

1. Attach the antenna to the AppCam 23.
2. Connect the camera to power (120V AC). After a few seconds, the red LED comes on steady.

When you attached the AppCam to a network and initially power it on, the app attempts to acquire the IP address from the DHCP server. Please make sure your network supports the DHCP protocol and that the DHCP option is turned on.

3. Connect the camera to the router/modem. After a few seconds, the green LED comes on steady. Your physical connection should look like this:



Step 2 – Set Up Camera

Prerequisites

- Make sure your smartphone/device is connected to the same wireless network as your camera.
 - You must have your router password.
1. Download the Uniden AppCam app (“Uniden AppCam”) from Google Play (for Android) or the App Store (for iOS) onto your mobile device.
 2. Open the app.

If this is the first camera to be added to the system, the *Add New System* screen displays.

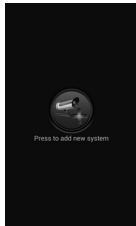

Android



iOS

If you have one camera on the system, the *Snapshot* screen displays.

If you have more than one camera on the system, a list of cameras displays.

3. Tap **ADD NEW SYSTEM**. The *System Information* screen displays.

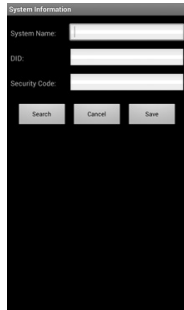

Android

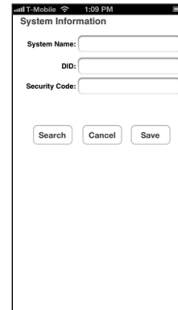

iOS

4. Enter a name for your camera (for example: Driveway).
5. Tap **SEARCH**. The app should search that network and fill in the DID code from the camera. If it doesn't see the camera, fill it in manually. The DID code is on a sticker on the camera.
6. Enter the camera's security code (Default = 123456). It is highly recommended that you change the security code.
7. Tap **SAVE**. The device and the camera are now connected. You should see a snapshot from the camera.

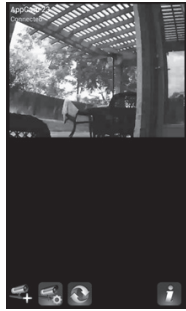

Android



iOS



8. Tap the snapshot. Live video now displays on the screen with different icons.

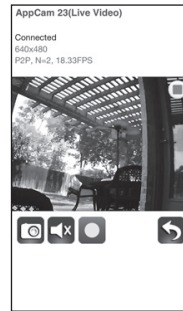

Android



iOS

9. Tap  to return to the *Snapshot* screen (see page 23) then tap the  icon
10. Three icons display on the screen (see page 24 for details). Tap the  icon. The *System Information* screen displays with the e-mail option as well as the *Advanced* tab (see page 26).

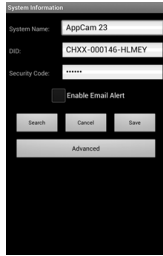

Android

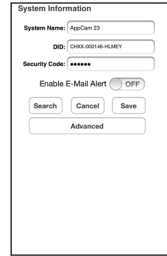

iOS

11. Tap the **ENABLE EMAIL ALERT** box (Android) or slide the **ENABLE EMAIL ALERT** button to **ON** (iOS) to turn on email notification when the camera begins recording from motion detection. Tap *Advanced*. The screen prompts you to enter the system password.
12. Enter 123456 (default) or the password you have selected and tap **OK**. The *Advanced Settings* screen displays with a series of fields in individual blocks.
13. Tap **MODIFY** (Android) or **ADMIN PASSWORD** (iOS) on the *Admin Password* screen. The *Modify admin password* screen displays.



Android

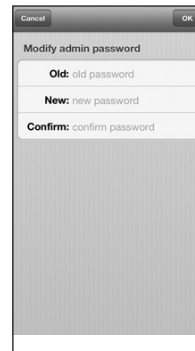

iOS

14. Change the default Admin password for advanced settings access (Default = 123456). Tap **OK**. The *Advanced Settings* screen displays again.

15. Scroll to *WiFi Setting*.

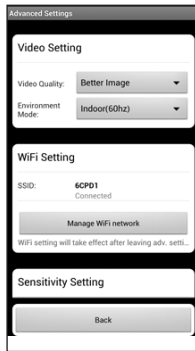

Android

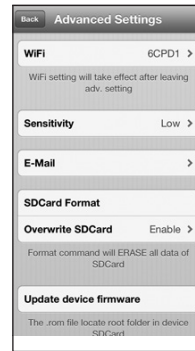

iOS

16. Tap **MANAGE WIFI NETWORK** (Android) or **WiFi** (iOS). A dropdown list displays available networks. Select the network you want to connect to and enter the password for your router. Tap **OK**, then tap **BACK** (at the bottom of the screen for Android or the top of the screen for iOS).



Android



iOS

17. The camera resets and turns on WiFi.

18. Verify that your wireless device can still view live video from the wireless camera.
19. You can now unplug the Ethernet cable connecting the camera to the router. Your connection should look like this:



Step 3 - Install Cameras

Consider the following when installing cameras:

- Clear line of sight video transmission distance is up to 500 ft.
 - Walls, especially brick and concrete, shorten the transmission distance.
 - Placement next to windows allows better transmission.
- Avoid having a direct light source in the view of the camera, including street lights, ceiling or floor lamps, spotlights in the driveway, etc.
- The camera is equipped with built-in infrared LEDs so you can use night vision for 24-hour surveillance. The LEDs will automatically activate at night and the picture viewed will turn to black and white. The night viewing range is up to 25 ft. Avoid pointing the camera lens directly at clear glass; the night vision LEDs will cause a blurred image.

- Optimized motion detection range is 6 - 18 feet for the camera. The farther away an object is, the less accurate the motion detection.
- Avoid pointing the camera directly at any bushes, tree branches, or moving objects that might naturally move due to winds. Otherwise, the motion detection feature may record unnecessarily.

You can mount the AppCam 23 with the stand on the bottom (on a flat surface such as a table-top), on the side (on a wall), or on the top (on the ceiling or under an eave or overhang).

1. Use your mobile device to test the places where you are considering mounting the camera. Hold the device in that location; if it still receives live video in that spot, the location is good.

Attach the camera stand if you have not already done so.

2. Unplug the camera from the power source and install it.
3. After the camera is installed, reconnect power.
4. Attach the Ethernet jack cap.

DETAILED APPCAM 23 INSTALLATION PROCEDURES

Mount the AppCam 23 Base

1. Hold the base of the camera stand where you want to mount it and mark the location of the screw holes.
2. Use the included screws and anchors to attach the base to the wall or ceiling. You can also screw the base into a flat surface such as a tabletop if needed.

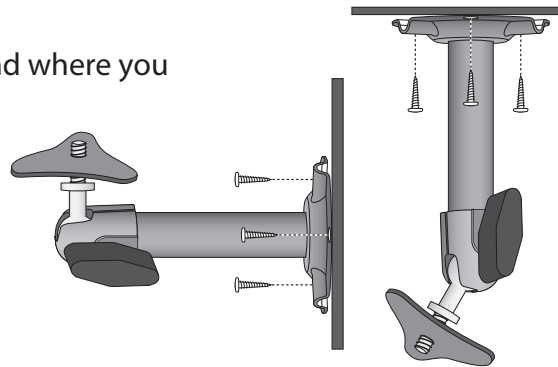

3. Before attaching the camera, tug gently on the stand to make sure it is securely in place.

Attach the Camera - AppCam 23

1. For each AppCam 23, attach the camera bracket to the mounting screw. You can attach the stand to the top or the bottom of the AppCam 23 as needed. Tighten it a few turns, then turn the AppCam 23 to face the direction you want.
2. Tighten the camera brace up against the AppCam 23 to secure it into place.
3. Unlock the mounting post by turning the wingnut to the left a few turns.
4. Set the mounting post to the correct angle, then tighten the wingnut until the post is locked into place.
5. After the AppCam 23 is installed, reconnect power.

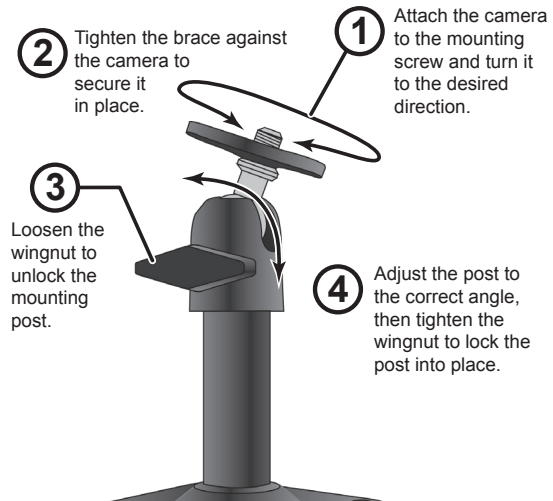

USING THE APP

After you've set up your system, use the Uniden AppCam app ("Uniden AppCam") to manage your AppCam operations and to take snapshots and remotely view live or recorded video on your smart phone or tablet device. You can have multiple independent AppCam cameras on the network. Please follow these steps to use the app.

ACCESSING YOUR CAMERAS

1. Run the Uniden AppCam app ("Uniden AppCam").
2. The *Globe* screen displays for each camera set up on the app. Review the names for each camera and tap the globe for the camera you want to view.
3. The *Snapshot* screen displays for that camera. See page 23 for actions available from the *Snapshot* screen. Tap the screen image.
4. Live video displays. See page 29 for actions available from the *Live Video* screen. Tap  to return to the *Snapshot* screen.

If only one camera is set up on your system, the app displays the Globe screen momentarily and then displays the Snapshot screen for your camera.

SNAPSHOT VS LIVE VIDEO SCREEN

The *Snapshot* and *Live Video* screens control operations. The *Snapshot* screen lets you add more cameras, configure advanced settings, access and manage recorded files, update the camera connection status and check app version. The *Live Video* screen lets you take snapshots and begin recording live video. You can also control the sound.

Android

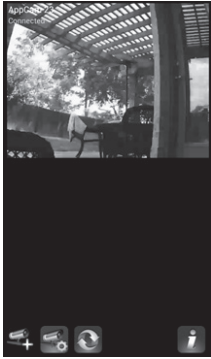

Snapshot



Live

iOS



Snapshot

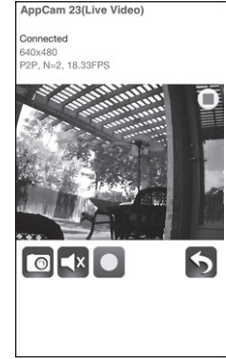

Live



SNAPSHOT SCREEN OVERVIEW

The *Snapshot* screen displays a snapshot image from the camera and four function icons.

Add Another Camera

The  icon allows you to add another camera to your network. See page 14 for details.

System Settings

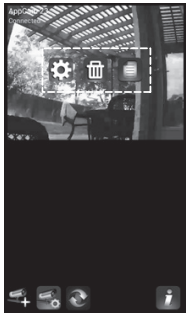

The  icon allows you to configure the advanced settings, remove the camera connection, and play back the recorded video clips. Tap  and the following three icons display in the center of the snapshot image:



Android



iOS

	Accesses <i>System Information - Advanced</i> Screen. This screen lets you configure the camera and set notification alerts. See page 26 for details.
	Deletes the camera from the app.
	Event List lets you check and play back recorded events and files. (See page 27 for details.)

Update

Tap  to update the camera's connection status.

Information

Tap  to set up and enable PIN lock or to check the app information.

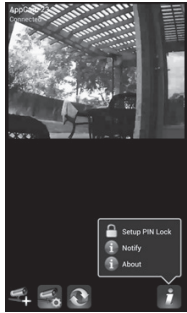

Android

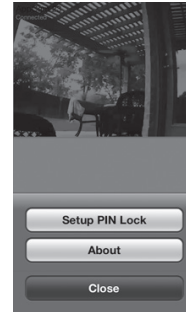

iOS

- The PIN lock is a unique security code you must enter when you turn your mobile device back on.
- APP information displayed includes APP and API version information.
- Android systems can also enable event notification through this button.

iOS systems enable event notification through the iPhone settings (Settings/Notification/UnidenAppCam/Notification Center).

System Information - Advanced Screen Details

Tap  to display the *System Information* screen again with a tab for Advanced settings. From this screen (see page 17 for an image of this screen), you can set email alerts and event notifications as well as configure specific camera settings.

Enable Email Alert

Email alerts notify you when something triggers the motion sensors on your cameras. Tap the box (Android) or move the slider (iOS) to turn this feature on.

Enable Event notify

The system generates event notifications when something triggers the motion sensors on your cameras. Tap the box to turn this feature on.

Advanced

Tap the *Advanced* tab to configure various settings in your device, such as the time zone, device password, and video setting. These settings are displayed in a list of fields, each field contained in its own block. Scroll down to find the field you want to set. You can also format the microSD card or check the device information here.

The Advanced field blocks are:

- *Admin Password*: The security code for your advanced settings. The default Admin Password is 123456. Change the default password to one you set yourself.
- *Email alert*: Setup your email for email alert.
- *Time Zone*: Setup the time zone for your system. The most commonly used time zones for this system are:
 - GMT-05:00 - Eastern Standard
 - GMT-06:00 - Central Standard
 - GMT-07:00 - Mountain Standard
 - GMT-08:00 - Pacific Standard
 - GMT-09:00 - Yukon Standard
 - GMT-10:00 - Alaska-Hawaii Standard
- *Daylight saving*: Enable or disable daylight saving time.
- *Device Security Code*: Change the default password (123456) to a security code for your camera.

- *Video Settings*: Configure the Video Quality (*Better Streaming* or *Better Image*) and Environment Mode.
- *WiFi*: Set up your WiFi connection.
- *Sensitivity*: Set the motion detection sensitivity level.
- *E-Mail*: Allows you to configure the email environment, email account, and password. You can also set up encryption for data transmission.
- *SDCard Format/ Overwrite SDCard*: Enable or disable the ability to overwrite the microSD card as space is needed.
- *Update device firmware*: Update the device's firmware. Tap **OK** at the confirmation screen to automatically reboot the device after update.
- *Device Information*: Check the model, camera's firmware version, and storage status.

Unless stated otherwise, the screen displays the main list of Advanced setting fields after you enter the requested information in a specific field.

Delete Camera Connection

Tap the Delete icon () to remove a camera from your system. Tap **NO** to keep the camera connection or **YES** to delete it. A confirmation screen displays.

Event List Details

Tap the Event List icon () to view a list of recorded video files. Tap the file you want to view and it begins to play.

Android

- Tap the pencil icon to select recorded files to delete. Tap the box on the right side of the entry to select it for deletion.

- You can set a filter to display all files recorded within the past hour, past 6 hours, etc. Tap on **SEARCH** (magnifying glass icon) to display the filter selections. Select a filter and then tap **YES**. The list of files displays again, filtered accordingly.

When you set a filter, be sure the Time Zone feature is set accurately in the Advanced fields to reflect the current time zone for the camera, not the time zone where you are. See page 26 for details.

iOS

Tap the Event List icon () to view a list of recorded video files. Tap the file you want to view and it begins to play.

Tap **DELETE ALL** to delete all of the recorded files or tap **DELETE ONE** to delete a single file. You can also set a filter to display all files recorded within the past hour, past 6 hours, etc. Tap **SEARCH** to display the filter selections.

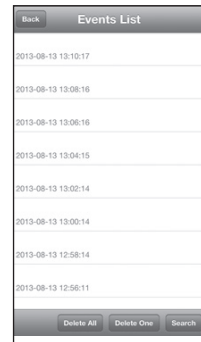

LIVE VIDEO SCREEN OVERVIEW

The *Live Video* screen lets you take snapshots, record video, and turn the sound from the live video on and off.



Android

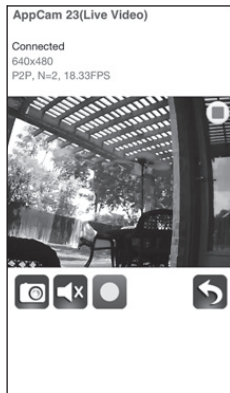

iOS

	<p>Tap this icon to take a snapshot of the current image. Snapshots are saved in your mobile device.</p>
	<p>Turn the audio on and off when you're viewing live video.</p>
	<p>Tap this icon to begin recording live video. Tap it again to stop recording.</p> <p><i>Once recording begins, the app continues recording for 2 minutes. You cannot stop recording during this period.</i></p> <p>When the system starts recording, the video clips will be saved into your camera's memory card. Please make sure the microSD card has been correctly inserted.</p>
	<p>Return to the <i>Snapshot</i> screen.</p>

View Recorded Files

Return to the Snapshot view and tap the  icon. See page 27 for Event List details.



TURN OFF THE APP

1. Tap your device's **MENU** button. The **EXIT** button displays.
2. Tap **EXIT**. The app closes and returns to the device's main screen.

For the iPhone, press the HOME button.



MAINTAINING YOUR SYSTEM

TAKING CARE OF YOUR CAMERA

When dust and grime builds up on the camera lens and glass, it affects night vision capability. The infrared light reflects off of the dust and grime, limiting the camera's "vision." Use a microfiber cloth to regularly clean the cameras or when night vision video is cloudy or unclear.



TROUBLESHOOTING

HOW TO IMPROVE THE WIRELESS SIGNAL QUALITY

If possible, remove obstacles in between camera and receiver that might reflect the signal. These could include furniture, cabinets, and walls. If the wireless signal is not improved, relocate the camera closer to the receiver.

If...	Try this...
The app cannot find the camera	<ul style="list-style-type: none">• Make sure your network supports DHCP protocol.• Make sure that the DHCP option is turned on.• Make sure the camera and your mobile device connect to the same WiFi router.• Make sure the WiFi router is activated.• Make sure the camera is properly powered on.• Use the “ADD CAMERA” function to manually add the camera.
No image appears	<ul style="list-style-type: none">• Make sure the power adaptor is not damaged or defective and is plugged into an electrical outlet with power.• Relocate the camera to obtain the best reception of wireless signals.• Make sure the camera is properly configured in the app.
Poor image quality	<ul style="list-style-type: none">• Clean the camera lens using a lens cleaning cloth. Spots or dust on the lens can also cause image quality problems.

If...	Try this...
Motion detection is not working	<ul style="list-style-type: none"> • Make sure the sensitivity setting is not turned OFF. (Set sensitivity through the Advanced tab.) • Adjust the sensitivity of the motion sensor. (Set sensitivity through the Advanced tab.) • In motion detection mode, a moving object within the camera viewing angle is necessary to trigger the motion sensor for recording. • Make sure the system date and time have been correctly set.
Bright white spots appear at nighttime	<p>The camera's infrared LEDs produce invisible light that reflects off surfaces such as glass. Install the camera on the other side of windows or place the lens flush against the surface to improve the night vision.</p> <p style="text-align: center;"><i>Please check the environment rating (Ingress) of the camera(s) before installing outdoors.</i></p>
Memory card error	<p>Make sure the memory card is correctly inserted and formatted.</p> <p style="text-align: center;"><i>Please backup the data before formatting. This Format function will erase all data on the memory card.</i></p>
Wrong date and time are shown	<ul style="list-style-type: none"> • Make sure you've selected the correct time zone. Unexpected date and time can result in an incorrect recording schedule. (See page 26) • Confirm the system date/time of the mobile device to ensure correct operation.

If...	Try this...
My smartphone or wireless device cannot find the camera during setup.	<ul style="list-style-type: none">• Make sure the router is turned on.• Refresh the connection.• Make sure your smartphone is connected to the same network as the camera.

SPECIFICATIONS

General	
Power	100~240V switching power supply DC 5V 1A
Power Consumption	650mA max
Camera Body Dimension	96mm x 48mm diam.
Weight (Main Body)	7.3 oz (210g)
Operating Temperature	14° ~ 122°F (-10° ~ 50°C)
Network	
Wireless Technology	IEEE 802.11 b/g /n

Simultaneous Views	3 Concurrent sessions
Security	WPA /WPA2 (TKIP, 128 bit AES)
Cameras	
Image Sensor	1/4" CMOS

Housing	Weather resistant metal
Environmental Rating (Ingress)	IP66
Camera Environment	Indoor (50Hz), Indoor (60Hz), Outdoor
Storage memory	microSD
Viewing Angle	H: 46° V: 35°
Min. Illumination	1~8 lux
Low-light resolution	10 IR LEDs with IR switcher
Low-light visibility	25 feet

Min. Upload Bandwidth Requirements	768 kbps per VGA resolution (per camera)
Audio/Video	
Image Compression	H.264
Image Resolution	VGA 640x480 QVGA 320x240
Recording Frame Rate	max 30 FPS
Supported Mobile Internet Device	
Android Requirement	Android 2.2 or above
iOS Requirement	iOS5.0 and above
Hardware Requirement	• Cortex A6 800MHz or above • 1GB internal memory or above

MICROSD CARD APPROXIMATE RECORDING TIME

- 1GB = 8.75 hours
- 4GB = 35 hours

Recycling and Disposal Information

- Do not dispose of electronic devices or any of their components (especially batteries and LCD displays) in your municipal trash collection.
- Consult your local waste management authority or a recycling organization like Earth911.com to find an electronics recycling facility in your area.

FCC COMPLIANCE

Part 15 Compliance Statement

This device complies with Part 15 of the FCC Rules. Operation is subjected to the following two conditions: (1) this device may not cause harmful interference, and (2) this device must accept any interference received, including interference that may cause undesired operation.

This equipment has been tested and found to comply with limits for a Class B digital device, pursuant to Part 15 of the FCC rules and ETSI (EN) 300328. These limits are designed to provide reasonable protection against harmful interference in residential installations. This equipment generates, uses, and can radiate radio frequency energy, and if not installed and used in accordance with the instructions, may cause harmful interference to radio communications.

However, there is no guarantee that interference will not occur in a particular installation. If this equipment does cause interference to radio or television equipment reception, which can be determined by turning the equipment off and on, the user is encouraged to try to correct the interference by one or more of the following measures:

- Reorient or relocate the receiving antenna.
- Move the equipment away from the monitor.
- Plug the equipment into an outlet on a circuit different from that to which the monitor is connected.
- Consult the dealer or an experienced radio/television technician for additional suggestions.

CAUTION! Any changes or modifications to this equipment not expressly approved by the party responsible for compliance could void your authority to operate the equipment.

RF Exposure Information

The antenna used for this transmitter must be installed to provide a separation distance of at least 20 cm (7.9") from all persons and must not be collocated or operating in conjunction with any other antenna or transmitter.

IC COMPLIANCE INFORMATION

Radio Equipment Notice

The term "IC:" before the radio certification number only signifies that Industry Canada technical specifications were met. Operation is subject to the following two conditions: (1) this device may not cause interference, and (2) this device must accept

any interference, including interference that may cause undesired operation of the device. "Privacy of communications may not be ensured when using this device".

CE COMPLIANCE INFORMATION

Products with CE Marking comply with EMC Directive (2004/108/EC); Low Voltage Directive (73/23/EEC); R&TTE(1999/5/EC) issued by the Commission of the European Community. Compliance with these directives implies conformity to the following European Norms:

- EMC: EN 301 489
- LVD: EN 60950
- Radio: EN 300 328

ONE-YEAR LIMITED WARRANTY

Important: Evidence of original purchase is required for warranty service.

WARRANTOR: Uniden America Corporation ("Uniden") **ELEMENTS OF WARRANTY:** Uniden warrants, for one year, to the original retail owner, this Uniden Product to be free from defects in materials & craftsmanship with only the limitations or exclusions set out below.

WARRANTY DURATION: This warranty to the original user shall terminate & be of no further effect 12 months after the date of original retail sale. The warranty is invalid if the Product is (A) damaged or not maintained as reasonable or necessary, (B) modified, altered, or used as part of any conversion kits, subassemblies, or any configurations not sold by Uniden, (C) improperly installed, (D) serviced or repaired by someone other than an authorized Uniden service center for a defect or malfunction covered by this warranty, (E) used in any conjunction with equipment or parts or as part of any system not manufactured by Uniden, or (F) installed or programmed by anyone other than as detailed by the owner's manual for this product.

STATEMENT OF REMEDY: In the event that the product does not conform to this warranty at any time while this warranty is in effect, warrantor will either, at its option, repair or replace the defective unit & return it to you without charge for parts,

service, or any other cost (except shipping & handling) incurred by warrantor or its representatives in connection with the performance of this warranty. Warrantor, at its option, may replace the unit with a new or refurbished unit.

THE LIMITED WARRANTY SET FORTH ABOVE IS THE SOLE & ENTIRE WARRANTY PERTAINING TO THE PRODUCT & IS IN LIEU OF & EXCLUDES ALL OTHER WARRANTIES OF ANY NATURE WHATSOEVER, WHETHER EXPRESS, IMPLIED OR ARISING BY OPERATION OF LAW, INCLUDING, BUT NOT LIMITED TO ANY IMPLIED WARRANTIES OF MERCHANTABILITY OR FITNESS FOR A PARTICULAR PURPOSE. THIS WARRANTY DOES NOT COVER OR PROVIDE FOR THE REIMBURSEMENT OR PAYMENT OF INCIDENTAL OR CONSEQUENTIAL DAMAGES. Some states do not allow this exclusion or limitation of incidental or consequential damages so the above limitation or exclusion may not apply to you.

LEGAL REMEDIES: This warranty gives you specific legal rights, & you may also have other rights which vary from state to state. This warranty is void outside the United States of America & Canada.

PROCEDURE FOR OBTAINING PERFORMANCE OF WARRANTY: If, after following the instructions in the owner's manual you are certain that the Product is defective, pack the Product carefully (preferably in its original packaging). The Product should include all parts & accessories originally packaged with the Product. Include evidence of original purchase & a note describing the defect that has caused you to return it. The Product should be shipped freight prepaid, by traceable means, to warrantor at:

Uniden America Service
743 Henrietta Creek Rd.
Roanoke, TX 76262

(800) 658-8068, 8 a.m. to 5 p.m., Central, Monday through Friday

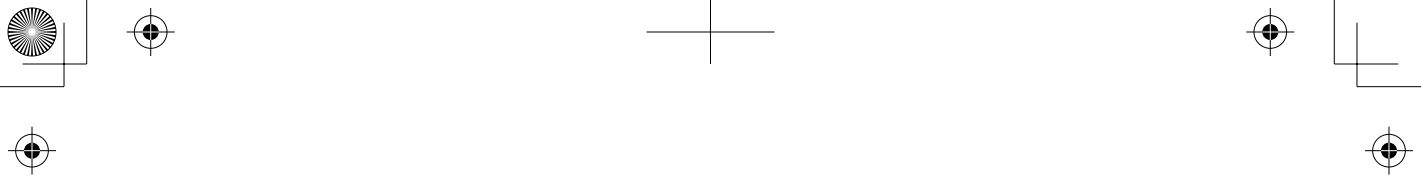

This device complies with Industry Canada licence-exempt RSS standard(s). Operation is subject to the following two conditions: (1) this device may not cause interference, and (2) this device must accept any interference, including interference that may cause undesired operation of the device.

Le présent appareil est conforme aux CNR d'Industrie Canada applicables aux appareils radio exempts de licence. L'exploitation est autorisée aux deux conditions suivantes : (1) l'appareil ne doit pas produire de brouillage, et (2) l'utilisateur de l'appareil doit accepter tout brouillage radioélectrique subi, même si le brouillage est susceptible d'en compromettre le fonctionnement.

The distance between user and products should be no less than 20cm

La distance entre l'utilisateur et de produits ne devrait pas être inférieure à 20cm

