

Navigator[®]

User's Manual

Model No.: CCD-401

Miniature Wireless Color Camera System

- **Wireless Color Westherproof IP44 Camera with Audio**

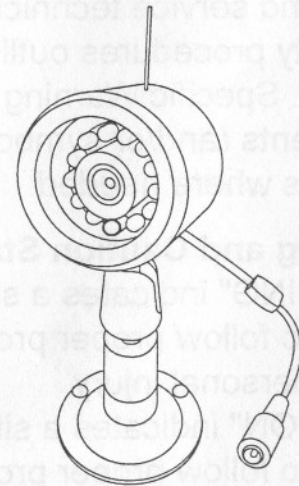

PLEASE READ CAREFULLY AND SAVE

This manual contains important information about this product's operation.
If you are installing this product for use by others you must leave this
manual -or a copy- with the end user.

Important!

Please read this booklet carefully before installing or using these units.

DANGER- HIGH VOLTAGE- These units should ONLY be opened by an authorized technician if service is required.

Safety Precautions

For correct and safe operation of this system, it is essential that installers, end-users and service technicians should follow all safety procedures outlined in this manual. Specific Warning and Caution statements (and/or symbols) are marked on the units where needed.

Warning and Caution Statements

"WARNING" indicates a situation where failure to follow proper procedures can cause personal injury.

"CAUTION" indicates a situation where failure to follow proper procedures can cause damage to the equipment.

Model No.: CCD-401 Miniature Wireless Color Camera System

Contents

Important Safety Precautions	1
Specifications	2
Parts Included with This System	3
Parts of the Miniature Wireless Color Camera System.....	3
- Parts of the Camera	3
- Parts of the Receiver.....	3
Installation	4
- Installing the Mounting Bracket (Camera Stand)	4
- Installing and Aligning the Camera on the Mounting Bracket (Camera Stand)	4
- Rotating the Camera.....	4
- Installing the Miniature Wireless Color Camera System.....	5
Troubleshooting Guide	6
Warranty	6

Important Safety Precautions

Please read before installing

Congratulations on your purchase of the Miniature Wireless Color Camera System. Please read these safety and operating instructions carefully before installing and using this system.

- Keep the camera, monitor and AC/DC adapter cord out of reach of children.
- Do not place the camera, monitor or AC/DC adapter cord in a crib or playpen.
- Do not use the camera near water or damp and wet environments, such as a bathtub, laundry tub, kitchen sink, or wet basements.
- Locate the camera, monitor and AC/DC adapter where there is adequate ventilation. Do not locate the camera in direct sunlight.
- Do not locate the camera, monitor and AC/DC adapter near heat sources such as heat registers, radiators, ovens, furnaces or other appliances with high operating temperatures.
- Do not use with extension cords. Use only the AC/DC adapter provided with this system. Use of other adapters may damage the camera or monitor and void your warranty.
- Only plug components into standard household voltage outlets (110V - 240V AC, 50Hz or 60 Hz).
- Do not place cords from the AC/DC adapters, camera or monitor where they can be pinched or stepped on. Protect the cords by keeping them out of the way of children, pets and routine household traffic. Do not place heavy objects on power cords or cover cords with rugs or carpet.
- When cleaning, use a DRY, lint-free cloth. Unplug the camera, monitor and AC/DC adapter before cleaning. NEVER immerse any components in water and do not spray cleaners or solvents on the unit. Doing so may damage the unit or cause electrical shock.
- Unplug the AC/DC adapter from the wall outlet when the system is not in use.
- Mishandling, alterations or modifications not approved by the manufacturer will void the warranty.

⚠ CAUTION!

- Connect this unit ONLY to other compatible units. Do not connect it to any other type of alarm or auxiliary device. Connecting anything else to this unit may damage it or prevent it from operating properly.

⚠ CAUTION!

- Do not paint over the camera.

⚠ CAUTION!

- This system uses public airwaves for wireless operation. The sound and video may be broadcast to and picked up by other 2.4 GHz receiving devices. Conversations and images from other rooms near the camera may be broadcast and picked up. To protect your privacy, always turn the camera off when not in use.

IMPORTANT!

ACCESSORIES- Do not place video monitor or equipment on an unstable cart, stand or table. The video monitor or equipment may fall causing serious injury to a child or adult, and serious damage to the equipment. Wall or shelf mounting should follow the manufacturer's instruction, and should use a mounting kit approved by the manufacturer.



Video monitor equipment and cart combinations should be moved with care. Quick stops, excessive force, and uneven surfaces may cause the equipment and cart combination to overturn.

VENTILATION- Slots and openings in the cabinet and the back or bottom are provided for ventilation and to ensure reliable operation of the video monitor or equipment and to protect it from overheating. These openings must not be blocked or covered. The openings should never be blocked by placing the video monitor on a bed, sofa, rug, or other similar surface. Video monitor or equipment receiver should never be placed near or over a radiator or heat register. Video monitor or equipment receiver should not be placed in a built-in installation such as a bookcase unless proper ventilation is provided.

FCC/CE WARNING

This equipment generates and uses radio frequency energy and if not installed and used properly, that is, in strict accordance with the manufacturer's instructions, may cause interference to radio and television reception. It has been tested and found to comply with limits for a Class B digital device in accordance with Part 15 of FCC Rules and CE I-ETS 300 440, which are designed to provide reasonable protection against such interference in a residential installation. However, there is no guarantee that interference will not occur in a particular installation. If this equipment does cause interference to radio or television reception, which can be determined by turning the equipment off and on, the user is encouraged to try to correct the interference by one or more of the following measures:

1. Reorient the TV/radio antenna.
2. Relocate the Receiver away from the TV/radio receiver.
3. Plug the Receiver into a different wall outlet so that the Receiver is on a different branch circuit.
4. If necessary, the user should consult the dealer or an experienced radio/television technician for additional suggestions.

The user may find the following booklet prepared by the Federal Communication Commission helpful: "How to Identify and Resolve TV Interference Problems." This booklet is available from the US Government Printing Office, Washington, D.C. 20402, Stock No. 004-000-00345-4.

FCC/CE NOTICE

The user is cautioned that changes or modifications not expressly approved by the manufacturer could void the user's authority to operate the equipment. Linear radio controls provide a reliable communications link and fill an important need in portable wireless signaling. However, there are some limitations which must be observed.

The radios are required to comply with FCC Rules and Regulations as Part 15 devices and CE I-ETS 300 440. As such, they have limited transmitter power and therefore limited range. A receiver cannot respond to more than one transmitted signal at a time and may be blocked by radio signals that occur on or near their operating frequencies. Changes or modifications to the device may void FCC and CE compliance. Infrequently used radio links should be tested regularly to protect against undetected interference or fault.

Specifications

CAMERA:

IMAGE SENSOR	1/3" Color CMOS Image Sensor
RESOLUTION	330 Horizontal TV Lines
LENS	6mm
POWER CONSUMPTION	7.5 V DC, 300 mA 1.3 Watts
ILLUMINATION	< 6 Lux with IR at F2.0 (5 meter) IR Activated Automatically
OPERATING TEMP.	32°F - 122°F 0°C - 50°C
DIMENSIONS	Approx. 4.5" x 2.8" x 2.4" 11.4 x 7.3 x 6cm (LxWxH)
WEIGHT	Approx. 0.46LB/206g

Parts Included with This System

- Camera with Built-In Transmitter
- 2.4 GHz Audio/Video Receiver
- 12V AC/DC Adapter for the Receiver
- 7.5V 300 mA Adapter for the Camera
- 1.5m A/V Cable

Parts of the Miniature Wireless Color Camera System

Parts of the Camera

1. Camera Lens
2. 12 pcs IR LED
3. Antenna
4. Power Jack
5. Camera Stand
6. IR Auto Control for Night Vision
7. Microphone
8. Channel Switch

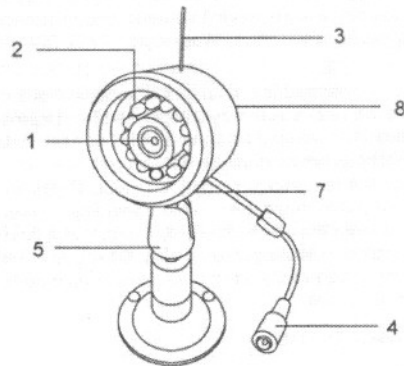

Installation

Tools you will need: Pencil, Drill, Drill Bits, Phillips-head Screwdriver, Hammer

Installing Mounting Bracket (Camera Stand)

1. Select a mounting location. Use the mounting bracket as a guide and mark the screw holes with a pencil.
2. Align the bracket over the holes or wall anchors and tighten the screws to secure the bracket to the wall or ceiling.

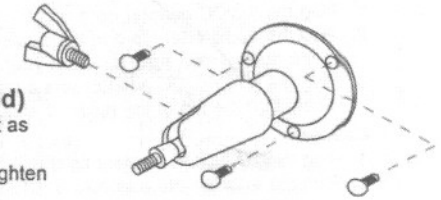

Attach Stand to Mounting Surface

Installing and Aligning the Camera on the Mounting Bracket (Camera Stand)

1. Slide the camera into the camera holder.
2. Line up mounting holes of the camera holder and the bracket.
3. Insert thumb screw, adjust camera to desired angle and tighten screw.

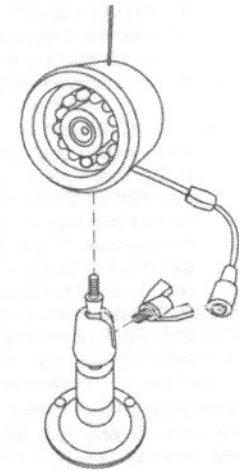

Rotating the Camera

Loosen up the Thumb Screw and adjust the camera to desired angle, then tighten the screw.

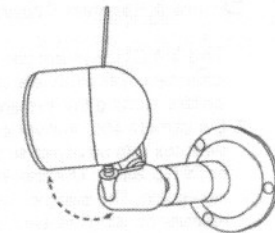

180° rotation availability,
30° of aiming availability for the lens.

Installing the Miniature Wireless Color Camera System

To install the system, follow these steps:

Receiver:

1. Plug the AC/DC adapter cord into the DC input jack on the back of the receiver.
2. Plug the audio/video cord to the audio/video output jack of the receiver. Plug the other end of the cord to the audio/video input jacks on your TV or monitor.
3. Plug the 12V AC/DC adapter into a standard (110V-240V) outlet. The power indicator LED located on the top of the receiver should light.

Camera:

1. Plug the 7.5V AC/DC adapter cord into the DC input jack on the back of the camera.
2. Plug the adapter into a standard (110V-240V) AC outlet.

System Setup:

1. Select the channel (Channel 1-4) to be used on both the camera and receiver.
NOTE: Make sure the camera and receiver are set to the **same** channel (1, 2, 3 or 4).
2. Set the selected channel by gently pushing the dip-switch for that channel to the ON position on both the camera and the receiver.

For example, to set both the camera and receiver on Channel 1:

- (a) Push the Channel 1 dip-switch located on the bottom of the camera and the receiver to the ON position.
- (b) Make sure the remaining dip-switches are in the OFF position. In this case, channels 2, 3 and 4 should be in the OFF position.

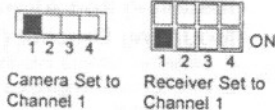

If more than one camera is to be installed and operated at the same time:

Simply follow steps (a) and (b) and set the dip-switches for the other channels on the camera and receiver to ON.

For example, to operate two cameras: set Camera 1 to Channel 1 (other channels off), set Camera 2 to Channel 2 (other channels off), and on the receiver, set channels 1 and 2 to ON.

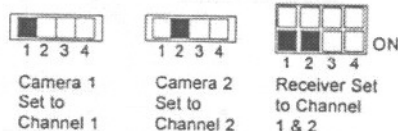

3. Position the camera antenna toward the receiver antenna. Rotate/adjust the antennas on both the camera and receiver for best performance.

Additional Notice- When installing the camera, check the reception of the receiver before final installation. Have someone hold the camera in the area to be monitored and another person to check the reception with your TV or monitor. If interference or other problems occur, refer to the Troubleshooting Guide.

Camera & Receiver Channel Setting Chart

1. This 2.4 GHz system can be connected with up to 4 channels. Set channels on the camera and receiver before starting the system.
2. Set camera and receiver channels by gently pushing the switches with an object such as a pen or pencil to the ON or OFF position. Use the illustrations shown on the right as a guide. The switches are inset into the camera and receiver housings to avoid accidentally changing the channel settings.
3. The Auto Sequential Scanning feature automatically activates when more than one switch is set to ON.

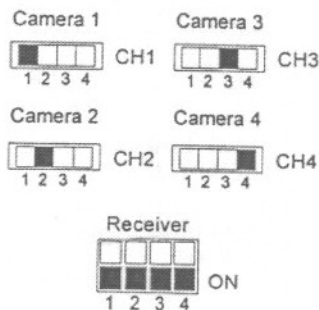

Troubleshooting Guide

If the Camera and/or Monitor...	You should...
No Power	<ol style="list-style-type: none"> 1. Check that the power cord(s) is properly connected. 2. Check that the monitor is turned ON. 3. Wrong AC/DC adapter used. Check that the adapter labeled OUTPUT: 7.5VDC. is connected to the receiver, and adapter labeled OUTPUT: 5V DC is connected to the Camera.
No sound or picture. Distorted sound or picture	<ol style="list-style-type: none"> 1. Check the channel switch settings on the camera(s) and monitor. Make sure the channels match on both units. 2. Signal interference from a microwave oven. Check if a microwave oven is in use or located in the path between the camera and monitor. If so, turn it off or move it out of the path. 3. Signal interference from other signal producing devices. <ol style="list-style-type: none"> (a) Change the channel setting on both camera and monitor. (b) Identify and eliminate the source of the interference. (c) Relocate the camera and/or monitor closer to each other. 4. Camera and monitor are too far apart. Relocate the camera and/or monitor. 5. Antenna is positioned improperly. Adjust the antenna on the camera and/or monitor.

1 Year Limited Warranty:

JSW Pacific Corp., the maker of **Navigator** brand products, warrants that for a period of 1 year from the date of purchase, this product will be free from defects in material and workmanship. JSW, at its option, will repair or replace this product or any component of the product found to be defective during the warranty period. Replacement will be made with a new or remanufactured product or component. If the product is no longer available, replacement may be made with a similar product of equal or greater value. This is your exclusive warranty. This warranty is valid for the original purchaser from the date of initial purchase with JSW and is not transferable. This warranty does not cover normal wear of parts or damage resulting from any of the following: negligent use or misuse of the product, use on improper voltage or current, use contrary to the operating instructions, disassembly, repair or alteration by anyone other than JSW or an authorized service center. Further, the warranty does not cover acts of God, such as fire, flood, hurricanes and tornadoes or any batteries that are included with this unit. JSW shall not be liable for any incidental or consequential damages caused by the breach of any express or implied warranty.

Federal Communication Commission Interference Statement

This equipment has been tested and found to comply with the limits for a Class B digital device, pursuant to Part 15 of the FCC Rules. These limits are designed to provide reasonable protection against harmful interference in a residential installation.

This equipment generates, uses and can radiate radio frequency energy and, if not installed and used in accordance with the instructions, may cause harmful interference to radio communications. However, there is no guarantee that interference will not occur in a particular installation. If this equipment does cause harmful interference to radio or television reception, which can be determined by turning the equipment off and on, the user is encouraged to try to correct the interference by one of the following measures:

- Reorient or relocate the receiving antenna.
- Increase the separation between the equipment and receiver.
- Connect the equipment into an outlet on a circuit different from that to which the receiver is connected.
- Consult the dealer or an experienced radio/TV technician for help.

FCC Caution :To assure continued compliance, any changes or modifications not expressly approved by the party responsible for compliance could void the user's authority to operate this equipment. (Example - use only shielded interface cables when connecting to computer or peripheral devices).

This device complies with Part 15 of the FCC Rules. Operation is subject to the following two conditions:

(1) This device may not cause harmful interference, and (2) This device must accept any interference received, including interference that may cause undesired operation.