

Music
Life **INFINITY**

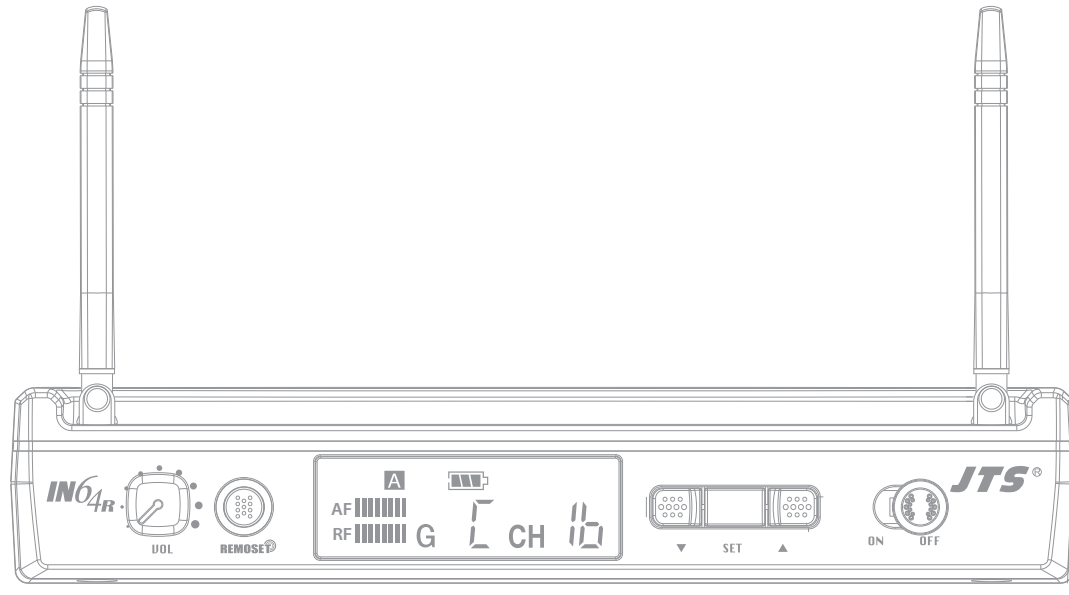
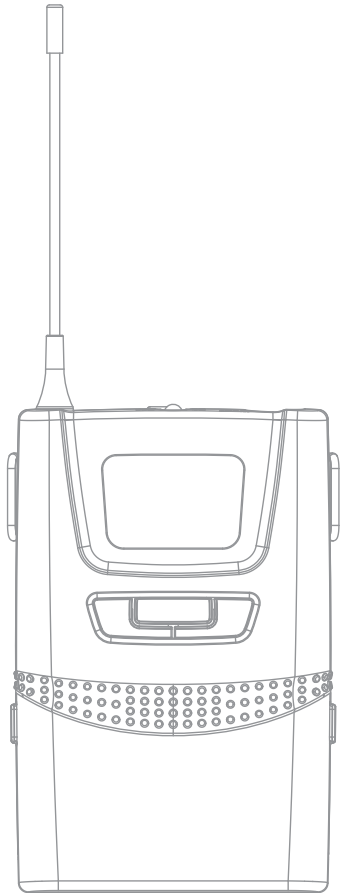

UHF PLL Single Channel Diversity Wireless System

- * The system is the initiative design to allow changing the transmitter's frequency by long-distance worldwide.
- * Preset 4 groups each of 16 UHF channels.

REMOSET **IN64**

1. Important Caution	01
2. Features	01
3. Parts Identification	02
3-1 IN64R	02
3-2 IN64TH	03
3-3 IN64TB	04
3-4 Power supply unit	04
4. Connection	05
1. Connect to the subsequent unit	05
2. Connect the power supply unit	05
5. Operation	06
1. Set up the system	06
2. Set up ID code	06
3. Synchronize the channel	07
4. Check system status	08
5. Adjust output volume	09
6. Manual select channel	09
7. REMOSET button lock	10
8. Adjust the sensitivity of the microphone	11
6. Specification	13

1. Important Caution

- Always make all connections before plugging the unit into an AC power outlet.
- Do not leave the devices in a place with high temperature or high humidity.
- Always do not handle the power cord with wet hands !
- Keep the devices away from fire and heat sources.

2. Features

JTS IN64 wireless microphone system is designed with the world first RF remote setting function (REMOSET). A user can set the receiver with desired frequency and press the "REMOSET" Key; then the transmitter will automatically be set. The operation distance can reach 10 meters. This brings great convenience to sound engineers during live performance.

A new capsule has been developed for IN64TH (Optional) . The capsule, SAM-8W, is designed for large venue with hundreds of thousands watt power. The SAM-8W delivers vivid details of vocal and instruments.

The IN64 is of stylish industry design. Yet JTS bombproof quality remains as always.

3. Parts Identification

3-1 IN64R

Front panel

- 1 Receiving Antennas
- 2 Power Switch
- 3 Channel Select: including "▲ up", "▼ down" and "Set" button
- 4 LCD Panel
- 5 REMOSET Key: press it to send a desired channel data to a transmitter
- 6 Volume Control

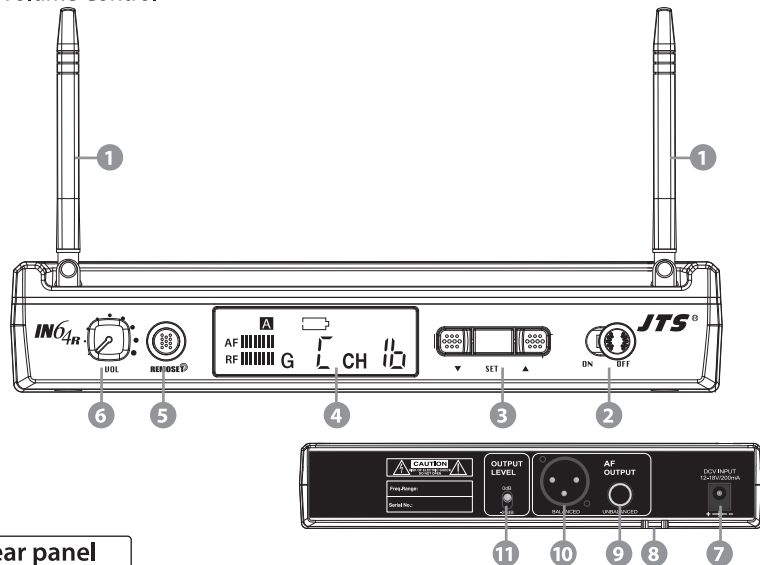

Rear panel

- 7 Power Supply Jack (12-18V/600mA): for connecting the power supply unit
- 8 Strain Relief: for the connection cable of the power supply unit, which lead the cable around the hook to prevent accidental disconnection of the plug from the jack.
- 9 AF Output (6.3mm jack, unbalance): for connection to a unbalance input, e.g. of a mixer or amplifier
- 10 Balanced XLR Output: for connection to the balanced input, e.g. of a mixer or an amplifier
- 11 Output Level Attenuation(-20dB): to attenuate the balanced output level by 20dB

LCD Panel of the Receiver

- a AF Level: display the strength of audio signal
- b RF Level: display the strength of radio signal
- c Antenna Status: the receiver will automatically select an antenna with stronger signal level
- d Low battery indicator: display the low battery status of its transmitter
- e Group & Channel: there are four groups, A, B, C, and D with 16 Channels each

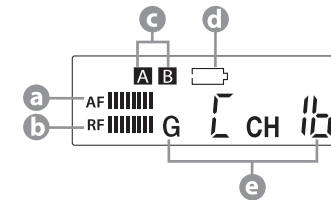

3-2 IN64TH

- 12 LCD Display
- 13 Battery Tray
- 14 Set button: set the configuration of handheld transmitter
- 15 Up button: select the settings of transmitter
- 16 Down button: select the settings of transmitter
- 17 Power and Mute Switch

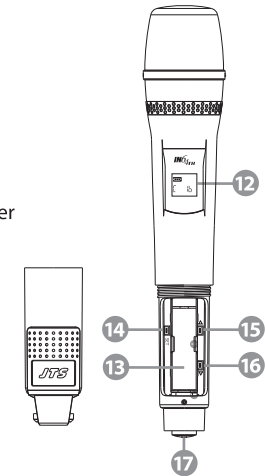

LCD Panel of the Handheld Transmitter

- f Battery status: display battery status
- g Group & Channel: there are four groups, A, B, C, and D with 16 Channels per group

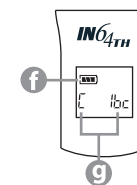

3-3 IN64TB

- 18 LCD Display
- 19 Battery Tray
- 20 Set button: set the configuration of bodypack transmitter
- 21 Up button: select the settings of transmitter
- 22 Down button: select the settings of transmitter
- 23 Power and Mute Switch

LCD Panel of the Body-Pack Transmitter

- h Battery status: display battery status
- i Group & Channel: there are four groups, A, B, C, and D with 16 Channels per group

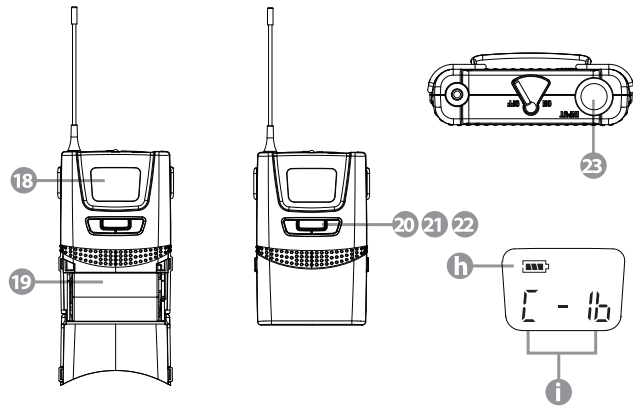

3-4 Power supply unit

- 24 AC/DV adaptor

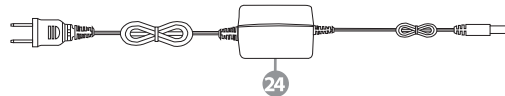

4. Connection

1. Connect to the subsequent unit (e.g. mixer, or amplifier)

Connect one end of a proper AF cable to the AF Output 9 or Balanced XLR Output socket 10, then plug another end to the "MIC IN" input socket of a mixer or a amplifier (Step 1 of Figure 1)

2. Connect the power supply unit

Plug in one end of AC/DC adaptor cable 24 to Power Supply Jack 7 in the rear panel of receiver, and plug another end into an AC outlet (Step 2 of Figure 1)

Caution

To prevent accidental disconnection of the plug of the power supply unit from the jack, lead the cable around the hook for strain relief 8

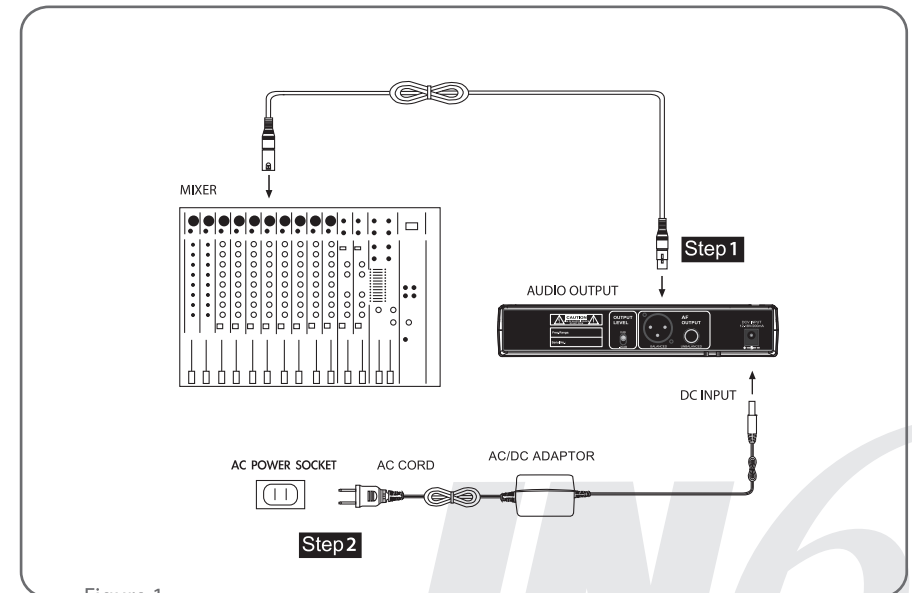

Figure 1

5. Operation

1. Set up the system

A) Turn on the power of the receiver

Switch the "Power Switch" ② to "ON". The "LCD Panel" ④ and "REMOSET" Key ⑤ will light up.

Turn on the power of the transmitter

Hold the "Power Switch" ⑰ ⑳ for 3 seconds. The "LCD Display" ⑫ ⑱ will light up.

Mute Function

After the transmitter's power is on, short pressing the "Power Switch" ⑰ ⑳ will mute the microphone. Press the "Power Switch" again will re-activate the microphone.

Notice: You have to hold the "Power Switch" for 3 seconds in order to turn off the transmitter.

B) Put the antennas ① in a vertical position

2. Set up ID code

In order to match one receiver to only one transmitter, IN64 is designed with "ID code". If and only if both ID codes of a receiver and a transmitter match each other, the "REMOSET" function works. There are 100 ID codes available.

Receiver

- Press "Set" button ③ for 3 seconds, LCD Panel will begin flashing.
- Press "Set" twice to enter "ID Code" setting window. (Figure 2)
- Press "▲Up" or ▼Down" button to select a distinct ID code from "id 0" to "id 99"
- After setting, press "Set" again to save the settings.

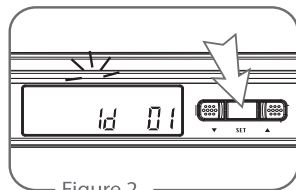

Figure 2

Handheld and BodyPack transmitter

ID code ON/OFF setting

- Press "Set" button ③ for 3 seconds, LCD Panel will begin flashing.
- Press "Set" couple times until "ID Code ON/OFF" setting window shows.
- Press "▲Up" or ▼Down" button to select between "ID ON" and "ID OFF".
- After setting, press "Set" again to save the settings.

Caution

When ID code is off (idOFF), the transmitter will accept any synchronization from any receiver.

ID code selecting

- Press "Set" button ③ for 3 seconds, LCD Panel will begin flashing.
- Press "Set" couple times until "ID Code" setting window shows.
- Press "▲Up" or ▼Down" button to select a distinct ID code from "id 0" to "id 99". (Figure 3)
- After setting, press "Set" again to save the settings.

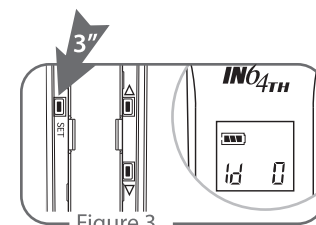
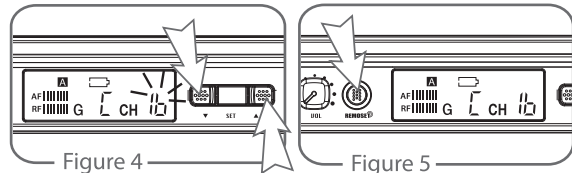

Figure 3

3. Synchronize the channel

- Press "Set" button for 3 Seconds, the group (G) in the "Group & Channel" area will flash. (Figure 4)
 - Press "▲Up" or "▼Down" button to select a desired group
 - Press "Set" again and the Channel (CH) in the "Group & Channel" area will flash.
 - Press "▲Up" or "▼Down" button to select a desired channel.
 - After setting, press "Set" again to save the settings.
 - Press "REMOSET" **5** to synchronize the channel of a transmitter. (Figure 5)
 - If the channel of the transmitter fails to change, the "REMOSET" key will keep flashing.
- Notice: The transmitter has to be set to "synchronization on (SYnOn)" in order to allow the receiver to synchronize.**(Handheld and body Pack Setting List p.12)



4. Check system status

- Antenna Status:** the receiver will automatically select an antenna with stronger signal reception and highlight that antenna **C** (Figure 6)
- Low Battery indicator:** when synchronization succeeds, if the transmitter is under low battery status, the "low battery indicator" will appear. (Figure 7)

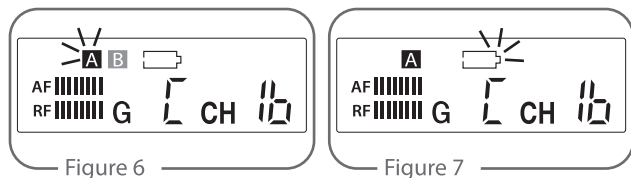

5. Adjust output volume:

Adjust output volume by twisting the Volume Control **6**

6. Manual select channel:

Receiver

- Press "Set" button for 3 seconds, the group (G) in the "Group & Channel" area will flash. (Figure 8)
- Press "▲Up" or "▼Down" button to select a desired group
- Press "Set" again and the Channel (CH) in the "Group & Channel" area will flash.
- Press "▲Up" or "▼Down" button to select a desired channel.
- After setting, press "Set" again to save the settings.

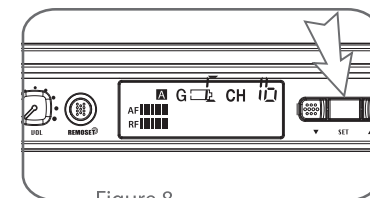

Handheld and BodyPack transmitter

- Press "Set" button for 3 seconds, the group (G) will flash. (Figure 9)
- Press "▲Up" or "▼Down" button to select a desired group
- Press "Set" again and the Channel (CH) will flash.
- Press "▲Up" or "▼Down" button to select a desired channel.
- After setting, press "Set" again to save the settings.

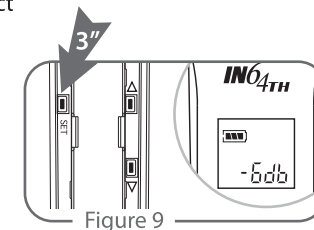

7. Lock ON Function:

Receiver

- Press "Set" button for 3 seconds to enter setting window
- Press "Set" again until the Lock setting window shows. (Figure 10)

Notice: Original setting is lock off (Lo OF).

- Press "▲ Up" or "▼ Down" button to select the mode between "Lock On" and "Lock off".
- After setting, press "Set" again to save the settings.

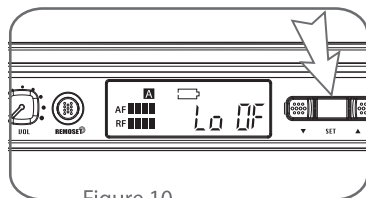

Figure 10

To release the "Lock ON"

- Press "Set" for 2 seconds.
- Press "down" to select "Lock OFF".
- Press "Set" to store.

Handheld and BodyPack transmitter

- Press "Set" button for 3 seconds to enter setting window. (Figure 11)
- Press "Set" again until the Lock setting window shows.

Notice: Original setting is lock off (Lo OF).

- Press "▲ Up" or "▼ Down" button to select the mode between "Lock On" and "Lock off".
- After setting, press "Set" again to save the settings.

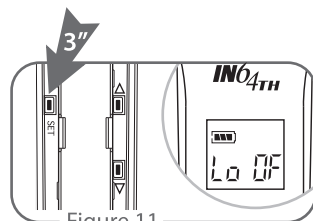

Figure 11

To release the "Lock ON"

- Press "Set" for 2 seconds.
- Press "down" to select "Lock OFF".
- Press "Set" to store.

8. Adjust the sensitivity of the microphone

- Press "Set" button for 3 seconds to enter setting window. (Figure 12)
- Press "Set" again until the Sensitivity setting window shows.
- Press "▲ Up" or "▼ Down" button to select the sensitivity among 0db, -6db, -12db, and -18db.
- After setting, press "Set" again to save the settings.

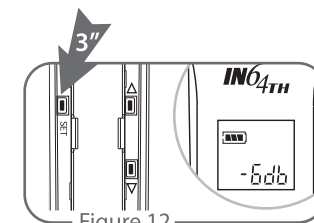

Figure 12

Notice : The changes or modifications not expressly approved by the party responsible for compliance could void the user's authority to operate the equipment.

IMPORTANT NOTE: To comply with the FCC RF exposure compliance requirements, no change to the antenna or the device is permitted. Any change to the antenna or the device could result in the device exceeding the RF exposure requirements and void user's authority to operate the device.

This device complies with Part 15 of the FCC Rules. Operation is subject to the following two conditions: (1) this device may not cause harmful interference, and (2) this device must accept any interference received, including interference that may cause undesired operation.

Handheld and body Pack Setting List

Manual Channel Select	A-1 ~ A-16 B-1 ~ B-16 C-1 ~ C-16 D-1 ~ D-16	There are 4 groups with 16 channel per group
Sensitivity Settings	0db -6db -12db -18db	0 dB is the highest sensitivity
Synchronization ON/OFF	SynOn SynOff	"On" means "REMOSET" function always opens; "Off" means "REMOSET" function is turned off
ID code ON/OFF	idOff idOn	When ID code is OFF (id OFF), the transmitter will accept any synchronization from any receiver.
ID code select	id 0 ~ id 99	There are 100 ID codes.
Lock ON	LocOff LocOn	button unlock button lock

6. Specification

6-1 IN64R

Frequency Preparation	PLL Synthesized Control
Remoset	Radio Frequency, 2.4GHz
Carrier Frequency Range	494MHz~960MHz
S/N Ratio	>105dB
T.H.D (1 KHz)	<0.6%@1KHz
Display	LCD
Display Contents	Channel, Antenna A/B, Mute Display, RF/AF Level Meter, Low battery, ID Number
Controls	Power On/Off, Frequency Up/Down, Audio Level, Lock-on, ID Pairing, Remoset
Audio Output Level	-12dB
AF Output Impedance	600Ω
Squelch	Pilot Tone & Noise Mute
Operation Voltage	12-18 VDC, 600 mA
Output Connector	1 XLR Balanced Socket
Dimension(m/m)	1 φ6.3mm Unbalanced phone jack 212mm(W) * 44mm(H) * 215mm(D)

6-2 IN64TH

IN64THSM

Frequency Preparation	PLL Synthesized Control
Carrier Frequency Range	494MHz~960MHz
RF Outputs	10mW
Stability	±0.005%
Frequency Deviation	±48kHz
LCD Display	Channel, Battery Fuel Gauge, ID Number
Controls	Power On/Off, AF Level, Frequency Up/Down, Lock-on Mode, ID Pairing
Spurious Emissions	<-50 dBC
Audio Frequency Response	50Hz~16kHz
Battery	UM3, AA 1.5V*2

6-3 IN64TB

Frequency Preparation	PLL Synthesized Control
Carrier Frequency Range	494MHz~960MHz
RF Outputs	10mW
Stability	±0.005%
Frequency Deviation	±48kHz
LCD Display	Channel, Battery Fuel Gauge, ID Number
Controls	Power On/Off, AF Level, Frequency Up/Down, Lock-on Mode, ID Pairing
Spurious Emissions	<-50 dBC
Audio Frequency Response	40Hz~18kHz
Battery	UM3, AA 1.5V*2