

FCC Statement

FCC INFORMATION

The equipment has been tested and found to comply with the limits for a Class B Digital Device, pursuant to part 15 of the FCC Rules. These limits are designed to provide reasonable protection against harmful interference in a residential installation. This equipment generates, uses and can radiate radio frequency energy and, if not installed and used in accordance with the instruction, may cause harmful interference to radio communication. However, there is no grantee that interference will not occur in a particular installation. If this equipment does cause harmful interference to radio or television reception, which can be determined by turning the equipment off and on, the user is encouraged to try to correct the interference by one or more of the following measures:

- Reorient or relocate the receiving antenna.
- Increase the separation between the equipment and receiver.
- Connect the equipment into an outlet on a circuit different from that to which the receiver is connected.
- Consult the dealer or an experienced radio/TV technician for help.

Notice:

The changes or modifications not expressly approved by the party responsible for compliance could void the user's authority to operate the equipment.

This device complies with part 15 of the FCC Rules. Operation is subject to the following two conditions: (1) This device may not cause harmful interference, and (2) this device must accept any interference received, including interference that may cause undesired operation.

IMPORTANT NOTE:

To comply with the FCC RF exposure compliance requirements, no change to the antenna or the device is permitted. Any change to the antenna or the device could result in the device exceeding the RF exposure requirements and void user's authority to operate the device.



UF-20R / UF-20S / JSS-20 / UF-20TB

Professional Wideband (75MHz)
True Diversity System

JTS[®] PROFESSIONAL CO., LTD
No.148, 9th Industry Road, Ta-Li Industrial
Park, Taichung City 41280, Taiwan (R.O.C.)
Tel: 886-4-24938803 Fax: 886-4-24914890
Email: jts@jts.com.tw
www.jts.com.tw

UF-20R / UF-20S / JSS-20 / UF-20TB

Product manual

One year product warranty

Product Model		Equipment serial number	
Customer name		Contact number	
Address			
Purchase date			
Selling store stamp	Be sure to put store stamp and fill in purchase date for the warranty to be effective!		

Warranty description

1. Be sure to put the warranty label indicating purchase date on the bottom of equipment to ensure your interest in maintenance and service.
2. Product warranty, starting on the purchase date indicated on “warranty label”, will last for one year; if the equipment does not have “warranty label”, the warranty period is 15 months from the manufacturing date. If a microphone is broken but not sent back with the equipment, the warranty period is 15 months from the manufacturing date of the microphone.
3. Within the warranty period, if the equipment is broken under normal use as instructed in manual, please contact the original selling store for repair.
4. When the product is returned for repair, to facilitate proper determination of cause of malfunction and of whether repair fee is needed, please ship back the equipment and microphone together.
5. Within the warranty period, our company provides repair service at no cost except for the following conditions that parts and repair may be charged:
 - a. Damages due to natural disaster or irresistible outside forces.
 - b. Damages due to drop, water, moisture, corrosion, foreign objects, missing components.
 - c. The warranty does not cover consumable parts. (such as microphone capsule, ball grille etc.)
 - d. Those without “warranty label” on equipment or with “warranty label” being damaged and failing to identify warranty period.
6. Please keep the warranty properly. No replacement will be made if the warranty is missing.

1. System operation instructions	1
2. Features	1
2-1 Receiver// UF-20R/UF-20S	1
2-2 Handheld Transmitter // JSS-20	2
2-3 Body-Pack Transmitter // UF-20TB	2
3. Specification	3
3-1 Receiver// UF-20R/UF-20S	3
3-2 Handheld Transmitter // JSS-20	5
3-3 Body-Pack Transmitter // UF-20TB	5
3-4 Charger For JSS-20 & UF-20TB & PS-20	6
3-5 Optional Condenser Microphone	6
4. Parts Identification & Accessories	9
4-1 Receiver // UF-20R/UF-20S	9
4-2 Handheld Transmitter // JSS-20	15
4-3 Body-Pack Transmitter // UF-20TB	17
4-4 Optional 2-Slot Charger / 8-Slot Charger // CH-2/CH-8	19
4-5 Optional Condenser Microphone	20
4-6 Accessories	24
5. Connection method	26
6. Operation	29
6-1 Receiver// UF-20R/UF-20S	29
6-2 Handheld Transmitter // JSS-20	41
6-3 Body-Pack Transmitter // UF-20TB	47
6-4 Installation of Condenser Microphones	53
7. Product notes	55
8. Important Notice	56

1. System operation instructions

- Before connecting to power, make sure the voltage marked on equipment is the same as that on the power socket.
- Do not place the equipment in damp and hot environment.
- Prior to operation, please dry your hands.
- Keep the equipment away from fire and heat source.
- Transmitter and receiver need to be adjusted to the same “default channel” or “frequency”.

2. Features

2-1 UHF PLL Wideband True Diversity Receiver // UF-20R/UF-20S

- UHF true diversity technology renders 200-480 meters of operation distance
- Maximum 2400 to 3000 selectable frequencies across 60 to 75 MHz
- Preset 15 groups each of up to 63 compatible channels
- User programmable 6 groups each of 64 channels
- Free space scan function
- JTS Patented obstacle-free RF **REMOSE**® function synchronizes a transmitter by pushing a button
- JTS LCX circuit design technology minimizes Companding noise

NEWEST FEATURE:

- The **REMOSE**® now sends not only the frequency data but also transmitter’s RF power, sensitivity, low cut, key lock and user’s name.
- RF “NO SIGNAL” alert function.
- AF “MUTE” alert function.
- Transmitter “LOW BATTERY” alert function.
- Built in equalizer
- Power / Antenna cascading output provided. (UF-20R Only)

2-2 UHF PLL Handheld Transmitter // JSS-20

- 2400 to 3000 selectable frequencies
- Preset 15 groups each of up to 63 compatible channels
- Phase-Locked Loop (PLL) synthesized tune
- Extended dynamic range and smooth frequency response.
- Adjustable transmission power between Low and High
- The panel Lock-On function prevents tampering and RF interruption

NEWEST FEATURE:

- Low cut function.
- JTS newest development SAM-8WLN capsule assures outstanding acoustic performance while minimizes touching noise.
- Interchangeable capsule design for various choices including some classic capsule modules.
- It is designed with slot-in charging feature with two AA NiMH rechargeable batteries.

2-3 UHF PLL Body-Pack Transmitter // UF-20TB

- 2400 to 3000 selectable frequencies
- Preset 15 groups each of up to 63 compatible channels
- Phase-Locked Loop (PLL) synthesized tune
- Extended dynamic range and smooth frequency response.
- Adjustable transmission power between Low and High
- The panel Lock-On function prevents tampering and RF interruption
- Together with JTS various music instrument mics, headset mics and tie clip mics this bodypack is versatile for all applications.

NEWEST FEATURE:

- It is designed with slot-in charging feature with two AA NiMH rechargeable batteries.

3. Specification

3-1-1. Dual Channel Wideband True Diversity Receiver // UF-20R

Frequency Preparation.....	PLL Synthesized Control
Frequency Setting.....	JTS patented obstacles-free RF REMOSET
Carrier Frequency Range.....	UHF 470~960MHz
Channel.....	Dual
Bandwidth.....	60~75MHz Wideband
S/N Ratio.....	>108dB(A)
T.H.D.	<0.5%@1KHz
Chassis.....	1U standard metal chassis
Preset Channels / Group.....	*From group 1 ~ 15 up to 63 interference-free compatible channels. *844 preset channels/group and 3000 selectable frequencies across 60 to 75 Hz Bandwidth. *User programmable from U1 ~ U6 each of 64 channels reserved.
Display.....	LCD and LED
Display Contents.....	Group, Channel, Frequency, Antenna A/B ,RF/AF Level Meter, Mute Display, Transmitter Battery Status, REMOSET ID Number, User Name, Squelch
Sensitivity.....	6dB μ V, at S/N>80dB
Receiving Mode.....	True diversity
Audio Output Level.....	Maximum 6dBu
XLR AF Output Impedance	150/600 Ω (mic/Line)
Frequency Response.....	50Hz~18kHz, with high-pass filter
Squelch.....	Pilot Tone & Noise Mute
Power Supply.....	100~240V or 12V DC
Output Connector.....	2 XLR Balanced Socket / 2 \varnothing 6.3mm Balanced phone jack
Dimension(mm).....	480mm(W)x45Mmm(H)x260mm(D)

3-1-2. Single Channel Wideband True Diversity Receiver // UF-20S

Frequency Preparation.....	PLL Synthesized Control
Frequency Setting.....	JTS patented obstacles-free RF REMOSET
Carrier Frequency Range.....	UHF 470~960MHz
Channel.....	Single
Bandwidth.....	60~75MHz Wideband
S/N Ratio.....	>108dB(A)
T.H.D.	<0.5%@1KHz
Chassis.....	1/2U standard metal chassis
Preset Channels / Group.....	*From group 1 ~ 15 up to 63 interference-free compatible channels. *844 preset channels/group and 3000 selectable frequencies across 60 to 75 Hz Bandwidth. *User programmable from U1 ~ U6 each of 64 channels reserved.
Display.....	LCD and LED
Display Contents.....	Group, Channel, Frequency, Antenna A/B ,RF/AF Level Meter, Mute Display, Transmitter Battery Status, REMOSET ID Number, User Name, Squelch
Sensitivity.....	6dB μ V, at S/N>80dB
Receiving Mode.....	True diversity
Audio Output Level.....	Maximum 6dBu
XLR AF Output Impedance	150/600 Ω (mic/Line)
Frequency Response.....	50Hz~18kHz, with high-pass filter
Squelch.....	Pilot Tone & Noise Mute
Power Supply.....	100~240V or 12V DC
Output Connector.....	1 XLR Balanced Socket / 1 \varnothing 6.3mm Balanced phone jack
Dimension(mm).....	212mm(W)x44Mmm(H)x213.9mm(D)

3-2 Professional Wideband Handheld Transmitter // JSS-20

Frequency Preparation..... PLL Synthesized Control
 Carrier Frequency Range..... UHF 470-960 MHz
 Bandwidth..... 60~75MHz Wideband
 RF Outputs..... Low / High
 Stability..... <±10KHz
 Frequency Deviation..... ±48KHz (Peak)
 LCD Display..... Group, Channel, Frequency, Battery Status, User Name,
 GAIN Adjust
 Controls..... Power ON/OFF, AF Level, Frequency (Up/Down), Lock-on
 Mode, REMOSET ID, RF Output Adjust
 Spurious Emissions..... <-50 dBC
 Audio Frequency Response... 50Hz~18k Hz
 Capsule Module..... Interchangeable
 Battery..... AA NiMH x2
 Dimension(mm)..... 50mm(W)x253mm(H)x35.5mm(D)
 Weight..... 350g

3-3 UHF PLL Body-Pack Transmitter // UF-20TB

Frequency Preparation..... PLL Synthesized Control
 Carrier Frequency Range..... UHF 470-960 MHz
 Bandwidth..... 60~75MHz Wideband
 RF Outputs..... Low / High
 Stability..... <±10KHz
 Frequency Deviation..... ±48KHz (Peak)
 Chassis..... Aluminium alloy
 LCD Display..... Group, Channel, Frequency, Battery Status, User Name ,
 GAIN Adjust
 Controls..... Power ON/OFF, AF Level, Frequency (Up/Down), Lock-on
 Mode, REMOSET ID, RF Output Adjust
 Output Connector..... 4P Mini XLR
 Spurious Emissions..... <-50 dBC
 Audio Frequency Response... 50Hz~18k Hz
 Battery..... AA NiMH x2
 Dimension(mm)..... 62mm(W)x80.3mm(H)x22.6mm(D)
 Weight..... 93g

3-4 Optional Charger For JSS-20 & UF-20TB & PS-20

Model No..... CH-2 (2-Slot Charger)
 Input..... AC 100~240V, 0.4A max
 Output..... DC 12V, 1A

Model No..... CH-8 (8-Slot Charger)
 Input..... AC 100~240V, 1.2A max
 Output..... DC 15V, 3A

3-5 Optional Condenser Microphone

Lavaliere Microphone

Model No.....	CM-501	CM-201i	CM-125i
Connector.....	4P Mini XLR	4P Mini XLR	4P Mini XLR
Frequency Response....	100~15,000 Hz	60~15,000 Hz	50~18,000 Hz
Polar Pattern.....	Cardioid	Omni-directional	Omni-directional
Sensitivity (at 1000Hz)	-60±3 dB	-60±3 dB	-53±3 dB
Impedance.....	2.2kΩ	2.2kΩ	4.4kΩ
Max. SPL for 1% THD	130dB	130dB	130dB
Dimension(mm).....	Ø10.1mm(W) * 26.4mm(H)	Ø5mm(W) * 9mm(H)	Ø4mm(W) * 11mm(H)
Net Weight.....	21.5g	20.7g	7g (cable excluded)

Headset Microphone

Model No.....	CM-214i	CM-214Ui	CM-214ULi
Connector.....	801C4 (4P Mini XLR)	801C4 (4P Mini XLR)	801C4 (4P Mini XLR)
Frequency Response.....	60~15,000 Hz	30~18,000 Hz	100 ~ 18,000Hz
Polar Pattern.....	Omni-directional	Cardioid	Cardioid
Sensitivity (at 1000Hz)	-60±3 dB	-68±3 dB	-65±3 dB
Impedance.....	1.8kΩ	680Ω	1.8kΩ
Max. SPL for 1% THD	130dB	130dB	120dB
Dimension(mm).....	125mm(W) * 134mm(H) * 157mm(D)	205mm(W) * 134mm(H) * 157mm(D)	125mm(W) * 134mm(H) * 157mm(D)
Net Weight.....	32.9g	38.4g	18g (cable excluded)

Model No.....	CM-235i	CX-504
Connector.....	801C4 (4P Mini XLR)	4P Mini XLR
Frequency Response.....	50~18,000 Hz	30~18,000 Hz
Polar Pattern.....	Omni-directional	Cardioid
Sensitivity (at 1000Hz)	-53±3 dB	-68±3 dB
Impedance.....	1.8kΩ	680Ω
Max. SPL for 1% THD	130dB	130dB
Dimension(mm).....	155mm(W) * 134mm(H) * 157mm(D)	285mm(W) * 55mm(H) * 111.3mm(D)
Net Weight.....	17g (cable excluded)	56.3g

Ear-hook Microphone

Model No.....	CM-801/CM-804i	CM-8015/CM-825i
Connector.....	801C4 (4P Mini XLR)	801C4 (4P Mini XLR)
Frequency Response.....	60~15,000 Hz	50~18,000 Hz
Polar Pattern.....	Omni-directional	Omni-directional
Sensitivity (at 1000Hz)	-64±3 dB	-53±3 dB
Impedance.....	1.8kΩ	1.8kΩ
Max. SPL for 1% THD	130dB	130dB

Compatible Instrument Microphone

Model No.....	CX-500	CX-500F	CX-520
Connector.....	4P Mini XLR	4P Mini XLR	4P Mini XLR
Frequency Response.....	20~20,000 Hz	20~20,000 Hz	50~16,500 Hz
Polar Pattern.....	Omni-directional	Omni-directional	Supercardioid
Sensitivity (at 1000Hz)	-58±3dB	-58±3dB	-78±3dB
Impedance.....	1.5kΩ	1.5kΩ	600Ω
Max. SPL for 1% THD	130 dB	130 dB	148 dB
Good For.....	Violin	Flutes	Harmonica

Model No.....	CX-508W	CX-516W
Connector.....	4P Mini XLR	4P Mini XLR
Frequency Response.....	50~18,000 Hz	30~18,000 Hz
Polar Pattern.....	Cardioid	Cardioid
Sensitivity (at 1000Hz)	-67±3 dB	-67±3 dB
Impedance.....	220Ω	220Ω
Max. SPL for 1% THD	130 dB	130 dB
Good For.....	Winds	Accordion

4. Parts Identification & Accessories

4-1 Buttons and LCD Displays of Wideband True Diversity Receiver// UF-20R/UF-20S

(1) Front panel

- ① Power : Power on: Push the Power button to turn on
Power off: Push and hold the Power button until “Power Off” shows on the LCD
- ② EXIT key: Push EXIT to cancel the selection and exit the menu when the UF-20R is in the “Setting Menu.”
- ③ Rotary switch: When in the “Function Setting Menu,” the rotary switch allows the selection of the desired functions up and down; push the rotary switch (or the SETUP) to enter the selection, rotate the switch to select the desired setting and push SETUP to save it.
- ④ SETUP: Push and hold for 2 seconds to enter the “Setting Menu;” when the selection and setting is done with [3. Rotary Switch], push SETUP to save the setting.
- ⑤ REMOSET: When the setting is done on the receiver, push REMOSET to transmit the settings to the handheld or body-pack transmitter.
- ⑥ LCD display: See [4-1-2. Description of receiver LCD display].
- ⑦ AF indication: shows the strength of current audio signal.
- ⑧ RF indication: shows the strength of current radio signal.
- ⑨ Antenna

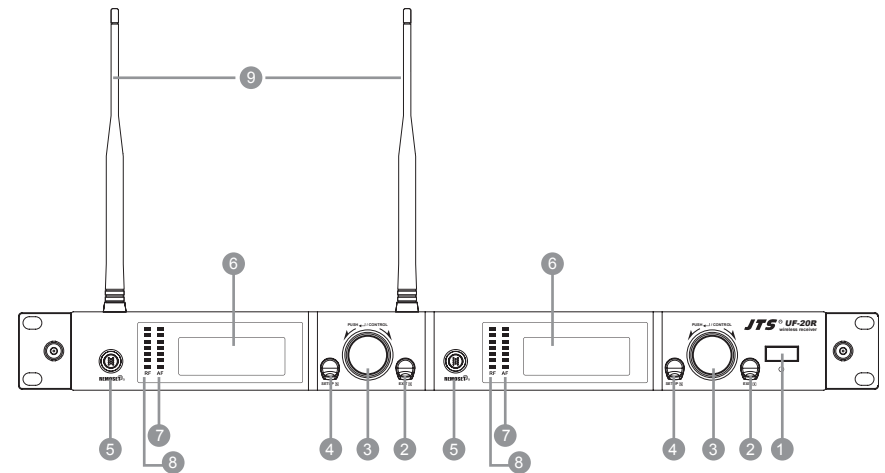

UF-20R

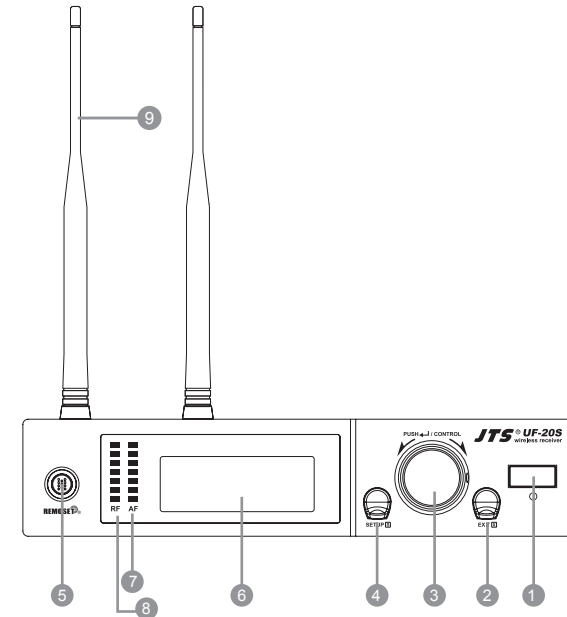

UF-20S

4-1-2. Description of receiver LCD display

Display color:

Red: (1) No RF signal is received from any transmitter, and the LCD shows:

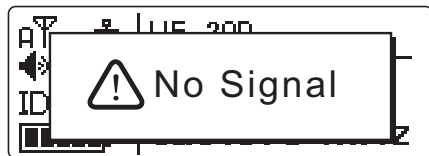

(2) Transmitter on mute.



(3) Transmitter battery low.

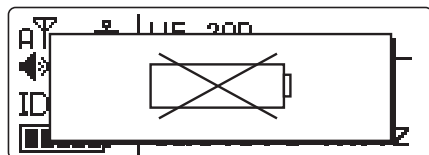

Orange: RF and AF signals are received from transmitters.

- ⑩ : Panel Lock On activated on receiver.
- ⑪ : It indicates antenna A or B is receiving signal; is shown when no signal is received from a microphone.
- ⑫ -19 : receiver volume.
- ⑬ ID: 0 : device ID: from 0 to 255.
- ⑭ : transmitter battery level
- MUTE** is shown when no signal is received from transmitter or the transmitter is mute.
- ⑮ G: the current group in use; from 1 to 15
CH: the current channel in use, up to 63
Frequency: the current frequency in use
- ⑯ User's Name (defined in the username setting in the menu)

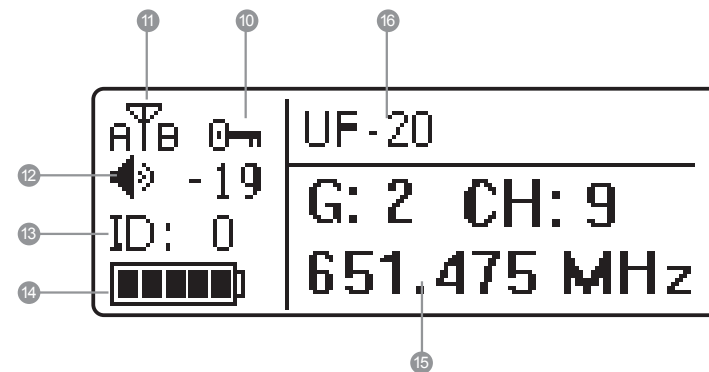

4-1-3. Back panel // UF-20R

- 17 POWER: AC power, 100 ~ 240VAC
- 18 AC power outlet(for cascading): it allows power connection to next receiver with an extension AC power cable.
- 19 AF OUTPUT BALANCED: XLR balanced audio output jack
- 20 AF OUTPUT BALANCED: Ø6.3mm balanced audio output jack
- 21 Antenna A (or B) In: antenna input (or antenna booster jack + 12VDC/150mA); it connects to antenna or antenna booster through a BNC signal cable.
- 22 RF A (or B) Out: RF signal output socket(for cascading): Provide RF signal to next receiver.

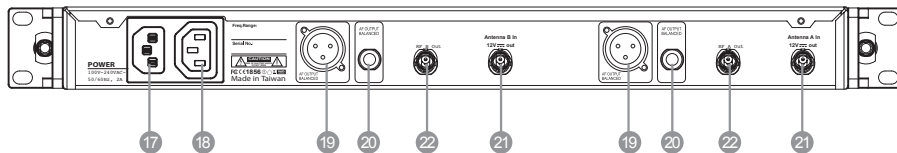

4-1-4. Back panel // UF-20S

- 23 Power receptacle: connect to power supply (DC12V/1000mA)
- 24 Balanced XLR MIC output
- 25 Ø 6.3mm balanced output
- 26 BNC antenna socket: ANT 1 and ANT 2, set antennas vertical or sloping for better reception.

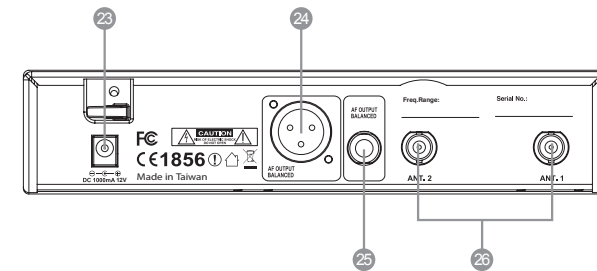

4-2 Buttons and LCD Displays of UHF PLL Handheld Transmitter // JSS-20

4-2-1. Panel functions

- 27 LCD display
- 28 SET: set and save handheld transmitter
- 29 ▲ ` ▼ : up and down buttons to select the desired function of the handheld device.
- 30 Power
 - (1) Handheld transmitter on
Power on: push the Power button.
Power off: push and hold the power button for one second till the display shows "Power Off"
 - (2) Mute: the handheld transmitter is in use (with main screen on display)
To mute: Short push the power button display "to activate mute."
To cancel: Short push the power button display again "to deactivate mute."
 - (3) Exit Setting Menu:
Already in the Setting Menu: push the power button to return to main screen.
Already in a function setting: push the power button to return to the Setting Menu and again to return to the main screen.
- 31 Battery tray
- 32 Recharging jack: for power charging.(Charger is optional)
- 33 Slide cover
- 34 Ball grille
- 35 LED status display
Green: power on
Blue: Remoset transmitting (approximately 5 seconds)
Red: battery low
Flashing red: mute
Flashing red/green: battery low and mute

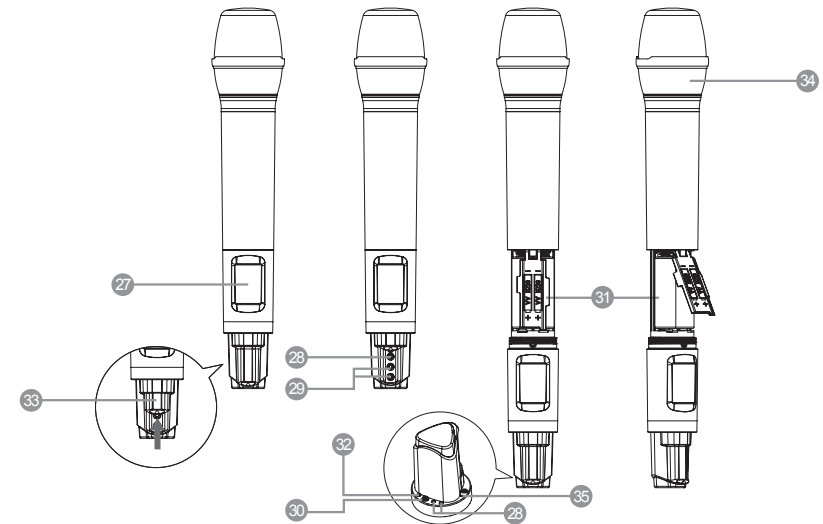

4-2-2. Description of LCD display

- 36 Device ID: from 0 to 255
- 37 Sensitivity: -15dB ~ +15dB
- 38 Low Cut indication
- 39 Transmission Power: Hi (High) and Lo (Low)
- 40 User name
- 41 Battery level: in 5 levels
G: the group in use, from 1 to 15
CH: the channel in use, up to 63
- 42 Lock On Statue
- 43 Frequency: it shows the RF frequency

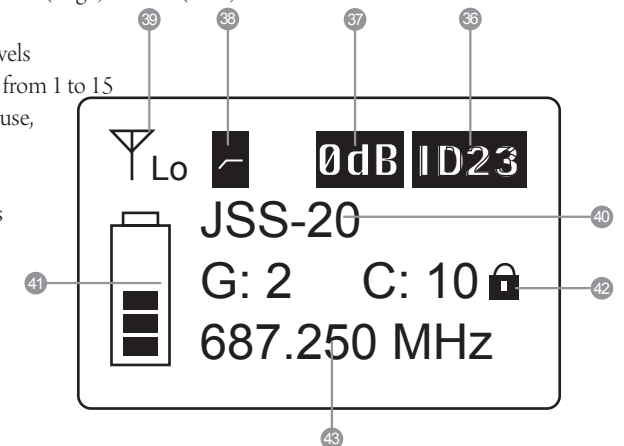

4-3 Buttons and LCD Displays of UHF PLL Body-Pack Transmitter // UF-20TB

4-3-1. Panel functions

- 44 LCD display
- 45 Battery level
Red: battery low; replace battery
- 46 REMOSET indicators
Blue: Remoset transmitting (approximately 5 seconds)
- 47 Power:
 - (1) On: push the power button
 - Off: push and hold the power button for 2 seconds till the display shows "Power Off"
 - (2) Exit Setting Menu: when in the Setting Menu, push the power button to return to the main screen.
- 48 ▲ ▾ : up and down buttons for selection
- 49 SET: to set and save
- 50 Mute: switch to "MUTE" to mute the transmitter and the red indicator starts to flash.
- 51 Battery tray

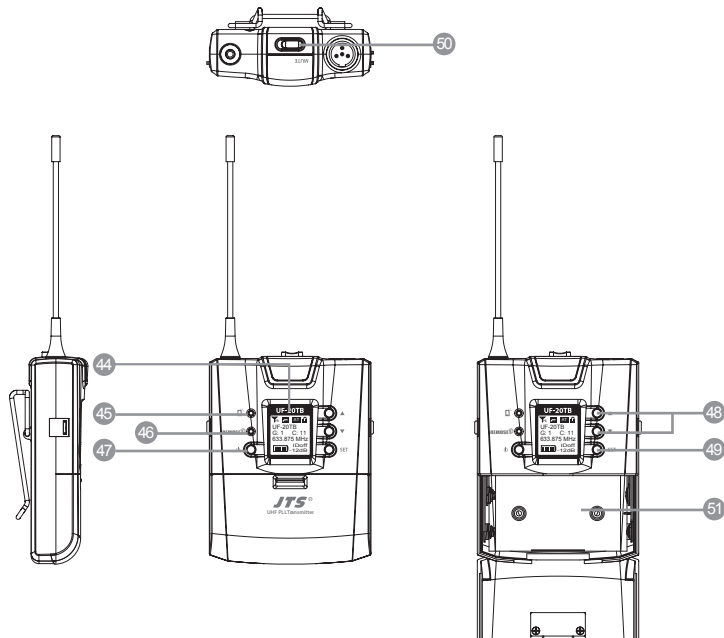

4-3-2. Description of LCD display

- 52 Transmission Power: Hi (High) and Lo (Low)
- 53 User Name
- 54 Indicate current Group and current Channel
- 55 Frequency: it shows the RF frequency
- 56 Battery level: in 5 levels
- 57 Sensitivity Value
- 58 Low Cut indication
- 59 Attenuate Indication
- 60 Lock On Statue

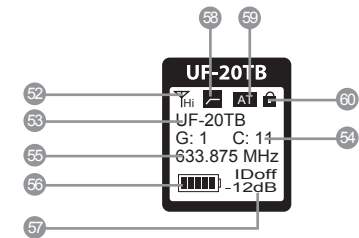

For screen display and operation please refer to "6-3. System operation setup for Body-Pack transmitter".

4-4 Optional 2-Slot Charger / 8-Slot Charger // CH-2/CH-8

- 61 LED Indicator
 - Full Charged / Standby: Green
 - Charging: Flash Green
 - Fault: Flash Red
- *Charging Time: 3 hours

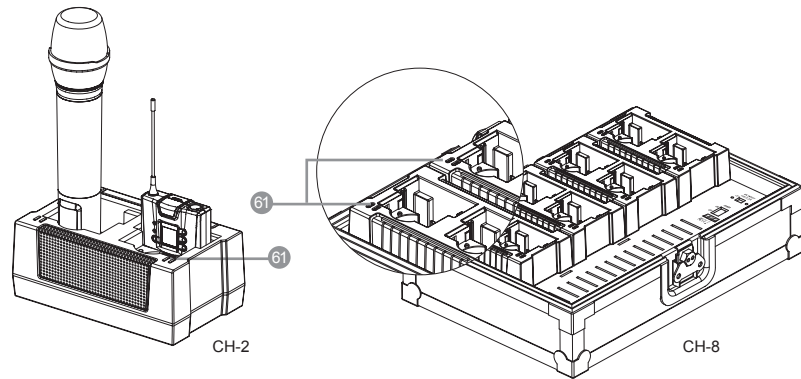

4-5 Optional Condenser Microphone

Lavalier Microphone // CM-501 / CM-201i / CM-125i

- 62 Clip
- 63 4 Pin Mini XLR
- 64 Windscreen

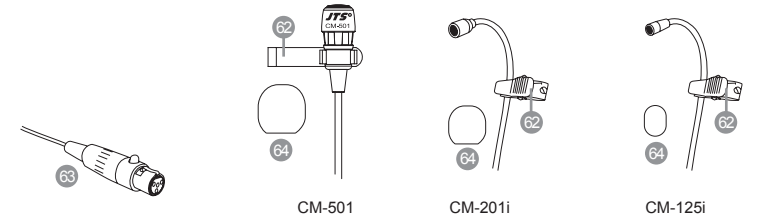

Headset Microphone // CM-214i / CM-214Ui / CM-214ULi / CM-235i / CX-504

- 65 Gooseneck
- 66 Adjustable headband
- 67 Headband
- 68 4 Pin Mini XLR
- 69 Windscreen

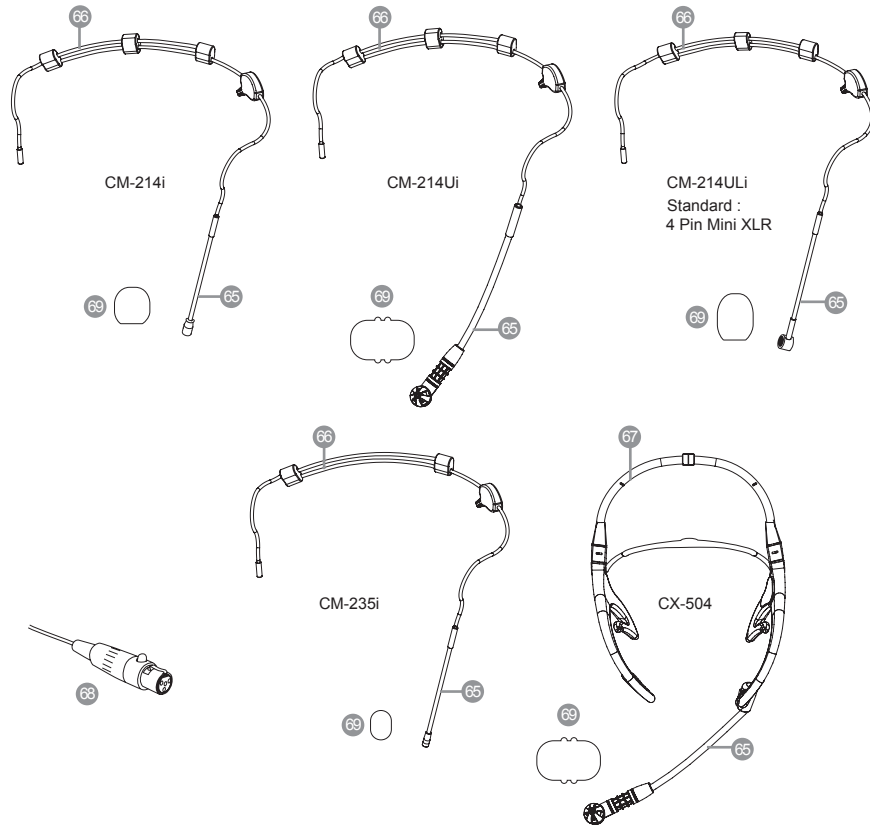

Ear-hook Microphone // CM-801 / CM-804i / CM-8015 / CM-825i

- 70 Boom
- 71 Adjustable Headband
- 72 Adjustable ear hook
- 73 Detchable Cable
- 74 Cable Clip
- 75 Windscreen
- 76 4 Pin Mini XLR

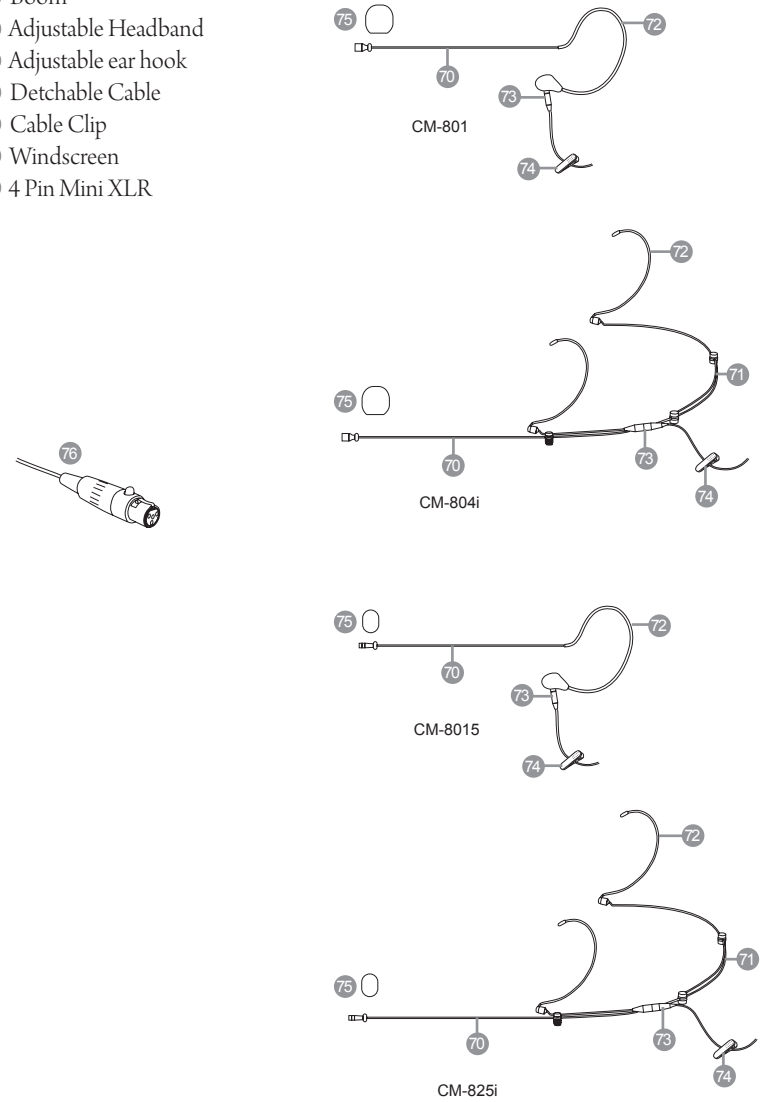

Compatible Instrument Microphone // CX-500 / CX-500F / CX-520 / CX-508W / CX-516W

- 77 Gooseneck
- 78 Clip
- 79 Bracket
- 80 Volume Control
- 81 Windscreen
- 82 4 Pin Mini XLR

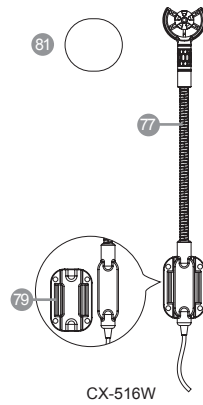
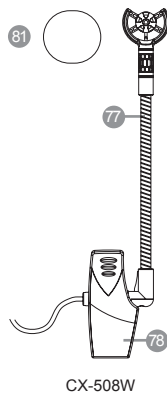
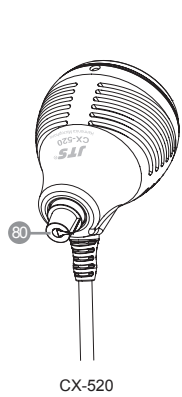
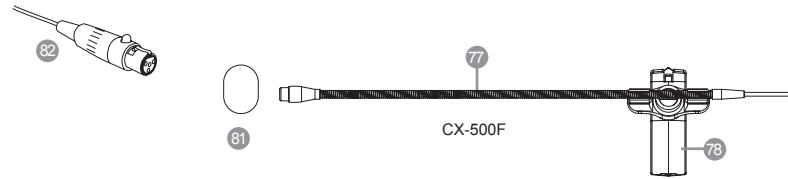
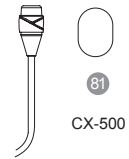

4-6-1. Accessories for UF-20R

- 83 AC power cable * 1
- 84 BNC/BNC RF extension cable for cascading * 2
- 85 Front antenna signal cable **Option**
- 86 Extension AC power cable for series connection * 1
- 87 XLR(M)/XLR(F) Audio cable * 2
- 88 MA-935 Capsule adaptor **Option**
- 89 PS-20 rechargeable battery module **Option**
- 90 CH-2 double-slot charger **Option**
- 91 CH-8 8-slot charger **Option**
- 92 Antenna * 2
- 93 MH-56 Microphones Holder * 2
- 94 Color ID housing * 7

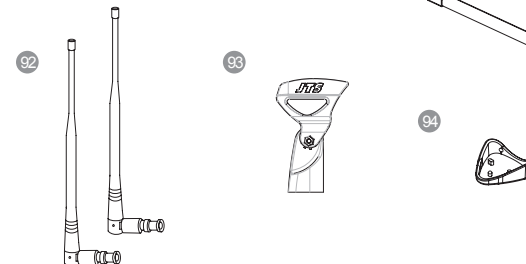
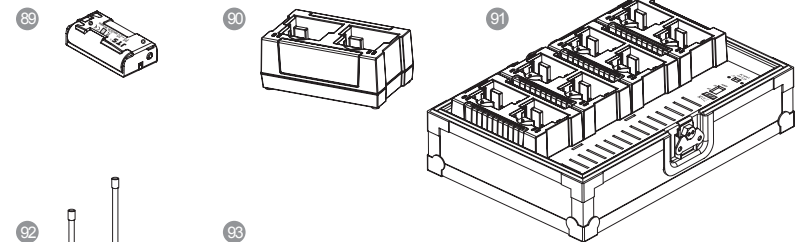
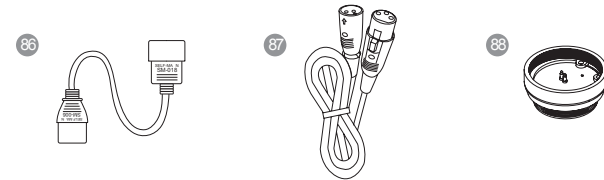

5. Connection method

4-6-2. Accessories for UF-20S

- 95 AC/DC power adapter * 1:
Switching power adapter
AC IN: AC100~240V/50~60Hz
DC OUT: DC12V/1000 mA
- 96 XLR(M)/XLR(F) Audio cable * 1
- 97 MA-935 Capsule adaptor Option
- 98 PS-20 rechargeable battery module Option
- 99 CH-2 double-slot charger Option
- 100 CH-8 8-slot charger Option
- 101 Antenna * 2
- 102 MH-56 Microphones Holder * 1
- 103 Color ID housing * 7

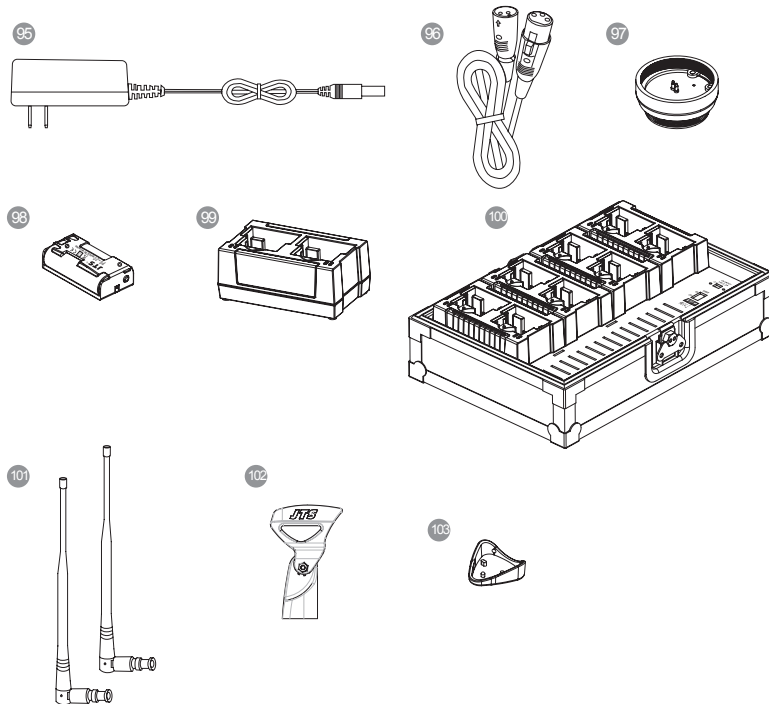

5-1-1. Receiver connection method // UF-20R

1. UF-20 output to a mixer or an amplifier:
Audio cable: XLR or Ø 6.3mm audio cable, one end connects to audio output of UF-20R “AF OUTPUT BALANCED”, while the other end connects to audio input of a mixer or an amplifier.
2. Connect to power
Connect to AC outlet: one end connects to receiver “power input”, while the other end connects to AC power receptacle.

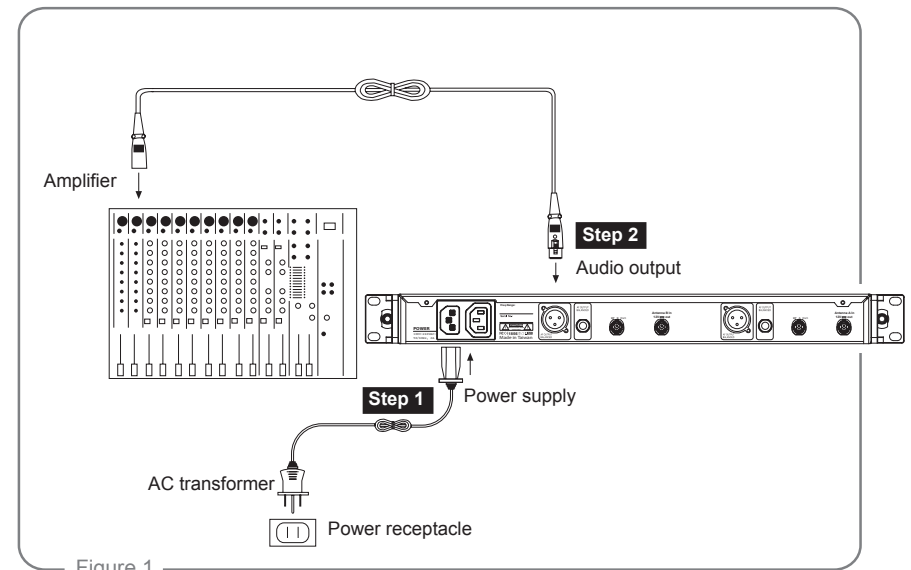

Figure 1

5-1-2. Receiver connection method // UF-20S

1. UF-20S output to a mixer or an amplifier:
Audio cable: XLR or Ø 6.3mm audio cable, one end connects to audio output of UF-20S “AF OUTPUT BALANCED”, while the other end connects to audio input of a mixer or an amplifier.
2. Connect to power
Connect to AC/DC adapter: one end connects to receiver “DCV INPUT”, while the other end connects to AC power receptacle.

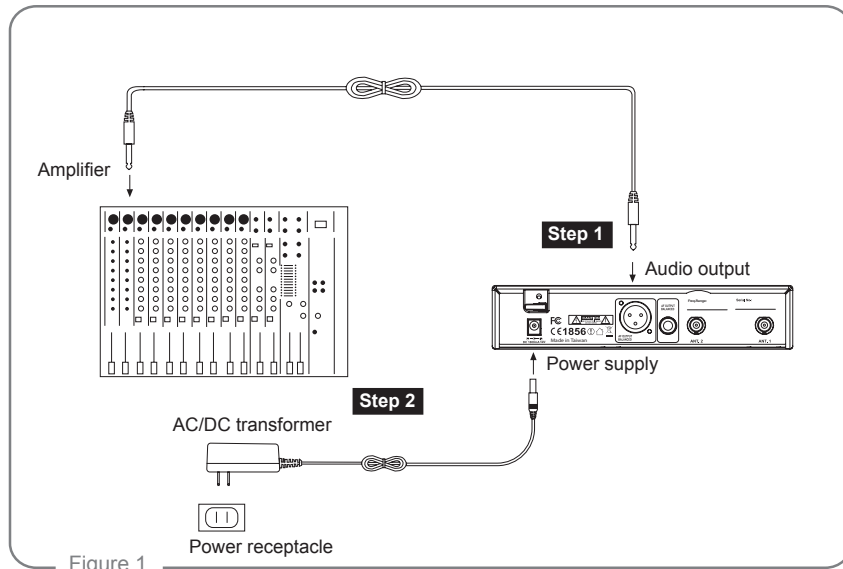
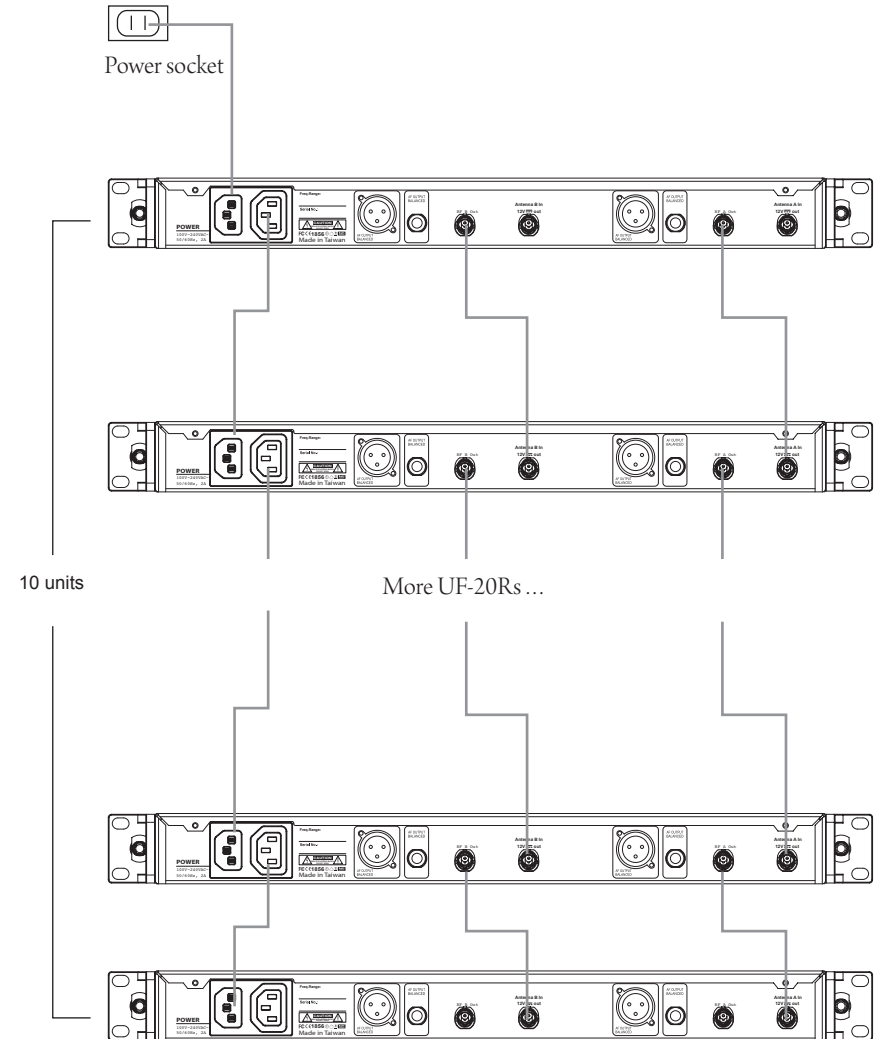

Figure 1

5-2 Cascading of AC power cable and antenna (UF-20R Only)

It is allowed to cascade power and antennas for 10 units.



6. Operation

6-1 Operation settings for Wideband True Diversity Receiver // UF-20R/UF-20S

6-1-1. Turn the receiver power on.

- (1) Install the receiver antenna.
- (2) Push the power button ❶ to turn the power on
- (3) To turn off: push and hold the power button till the display shows "Power Off."

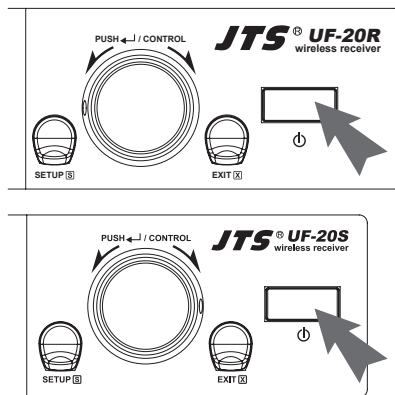

6-1-2. REMOSET function:

- (1) Push the REMOSET button and the blue indicator starts to flash, indicating the receiver is transmitting data (Figure 1).

*When using the REMOSET function of UF-20R, it is recommended to carry out REMOSET one by one. This is to prevent the interference between the REMOSET signals and the failure of data transmitting.

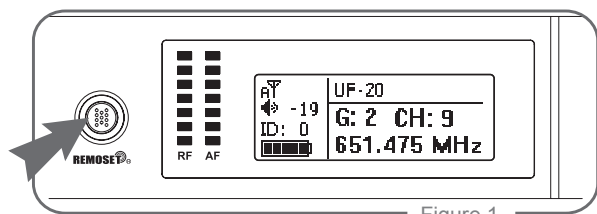

Figure 1

- (2) REMOSET successful: the blue indicator on the transmitter is on for 3 seconds and that on the receiver stops flashing.

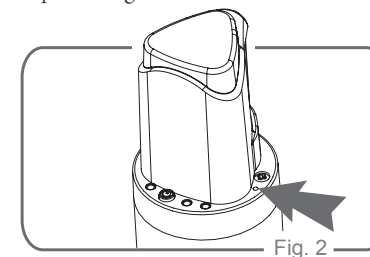

Fig. 2

- (3) REMOSET failed: Check the following when the blue indicator on the receiver flashes in a slow pace:
 - 1) If the receiver and the transmitter are of the same frequency band.
 - 2) The "RemoSet Function" on in the function menu of Transmitter is "activated;"
 - 3) The "Device ID" is the same on both the receiver and transmitter.
 - 4) The transmitter battery is low (synchronization is not possible if it is too low).

Notes:

- (1) For receiver settings, please see: "6. Device ID" and "7. Microphone Setting" of 6-1 Operation settings for Wideband True Diversity Receiver.
- (2) For handheld transmitter settings, please see: "5. Device ID" and "6. RemoSet Function" of 6.2 Operation settings for handheld transmitter system.
- (3) For body-pack transmitter settings, please see: "5. Device ID" and "6. RemoSet Function" of 6.3 Operation settings for body-pack transmitter system.

6-1-3. Menu setting

Push and hold the SETUP button for 2 seconds to enter the menu.

- (1) Turn the rotary switch clockwise or counterclockwise to select the desired function. Push the switch (or the SETUP button) to enter the setting screen. Push EXIT to return to the main menu if nothing is done.
- (2) In the setting screen, turn the rotary switch to the desired value or function, and push SETUP to save the setting.
- (3) EXIT: return to main menu or main screen; no saving or modification of settings is made; push EXIT once to return to the menu and again to return to the main screen.

1. Frequency : this is to define the frequency.

- (1) Rotate the rotary switch to "1. Frequency" Push the rotary switch (or SETUP) to enter the frequency adjustment screen.

M	1. Frequency
E	2.Group/Channel
N	3.User Group
U	4. Scan

- (2) Adjust the left three digits of frequency: rotate the switch [+/-] in steps of 1MHz. Push the rotary switch to save the selected value.

Setup Frequency	
687.	250 MHz
G: 1	CH: 1

- (3) Adjust the right three digits of frequency: rotate the switch [+/-] in steps of 0.025MHz: Push the rotary switch to save the selected value.
Note: you may select to adjust the left or right part of frequency by pushing the rotary switch.

Setup Frequency	
687	250 MHz
G: 1	CH: 1

2. Group/Channel : this is to define groups and channels.

- (1) Rotate the rotary switch to "2. Group/ Channel." Push SETUP (or the rotary switch) to enter the setting screen.

M	1. Frequency
E	2.Group/Channel
N	3.User Group
U	4. Scan

- (2) Rotate the switch to select a group "G:" from 1 to 15. Push the rotary switch to save the selected value.

Setup Group	
G: 2	CH: 10
633.625MHz	

- (3) Rotate the switch to select a channel "CH:" from up to 63 channels. Push the rotary switch to save the selected value.
Note: you may select to adjust the group or channel by pushing the rotary switch.

Setup Group	
G: 2	CH: 10
633.625MHz	

3. User Group: groups and channels defined by user

Rotate the rotary switch to "3. User Group." Push the rotary switch (or SETUP) to enter the setting screen.

M	1. Frequency
E	2.Group/Channel
N	3.User Group
U	4. Scan

#1. Custom Group: the user is to define a group

- (1) Rotate the rotary switch to "1. Custom Group." Push the rotary switch to enter the setting screen.

1. Custom Group
2. Clear Group
3. Return

- (2) For "every push" of the rotary switch, the display jumps from group (G), channel (CH) to frequency (the left or right three digits): when the frequency shows "---- MHz," it means that this channel (G/CH) is not in use.

Setup User Group	
G: U1	CH: 1
---- MHz	

- (3) Rotate the rotary switch to select the group, channel or frequency for setting; push SETUP to save the setting.

Setup User Group	
G: U1	CH: 1
---- MHz	

Setup User Group	
G: U1	CH: 1
624.000 MHz	

Setup User Group	
G: U1	CH: 1
624.025 MHz	

#2. Clear Group: delete a group defined by us er

(1) Rotate the rotary switch to “2. Clear Group.” Push the rotary switch to enter the “Clear Group” screen.

(2) Rotate the rotary switch to select the group to be deleted and push the rotary switch.

Select “Confirm” and all the channels and frequencies of that group is returned to “---.---MHz.” Select confirm or cancel and push the rotary switch.

1. Custom Group
2. Clear Group
3. Return

Group: U1
Rotary to select
Push “Enter” to clear
Push “Exit” to return

Group “U1” will be cleared continues?
<input checked="" type="radio"/> Yes <input type="radio"/> NO

#3. Return: return to main menu

Rotate the rotary switch to “3. Return,” and push the switch to return to the main menu.

1. Custom Group
2. Clear Group
3. Return

4. Scan: scan for channels

(1) Rotate the rotary switch to “4. Scan.” Push the rotary switch (or SETUP) to enter the channel scanning screen.

M	1. Frequency
E	2.Group/Channel
N	3.User Group
U	4. Scan

#1. All Groups: scan all groups

(1) Rotate the rotary switch to “1. All Groups.” Push the rotary switch (or SETUP) to enter the menu.

(2) Enter the “All Groups” (push EXIT to go back up a level) and push the rotary switch to scan.

(3) The progress in % is shown on the screen during the scanning. To stop scanning, just push EXIT.

(4) The display goes to the “2. Result List” screen automatically after the scanning is completed. User may select the list in the menu.

1. All Groups
2. Result List
3. Current Group
4. Return

Scan All Groups
Press Setup or Enter to start scan.
Press Exit to quit.

Scan All Groups
Scanning... 2%

The user may view the scan result in the screen. Rotate the rotary switch to select an available channel. Push SETUP to save settings.

#2. Result List: view the scan result list

Rotate the rotary switch to “2. Result List.” Push the rotary switch and enter the menu screen to view the result. Select an available channel and push SETUP to save the settings.

1. All Groups
2. Result List
3. Current Group
4. Return

Scan Result List
G: 1 CH: 1
Open Channel : 48

#3. Current Group: scan a single group

(1) Rotate the rotary switch to “3. Current Group.” Push the rotary switch to enter the menu screen.

(2) Push the rotary switch to start scanning a single group.

(3) The display shows OK after scanning; for “every push” of the rotary switch, the unit starts to scan the next group. Select and push SETUP to save the setting. Push EXIT to go back to the previous level.

1. All Groups
2. Result List
3. Current Group
4. Return

Scan Current Group
G: 1 CH:1

Scan Current Group
G: 1 CH: 1 OK
Press Setup to Save.

#4. Return: return to main menu

Rotate the rotary switch to “4. Return.” Push the rotary switch to return to the main menu.

1. All Groups
2. Result List
3. Current Group
4. Return

5. Squelch: adjust the receiver sensitivity

(1) Rotate the rotary switch to “5. Squelch.” Push the rotary switch (or SETUP) to enter the adjustment menu.

(2) Rotate the rotary switch to adjust the sensitivity. 0dB is the standard value. Push SETUP to save the setting. The higher the value, the lower the receiver sensitivity, and the lower the value, the higher the receiver sensitivity.

M	5. Squelch
E	6. Device ID
N	7. Mic Config
U	8. Volume

Setup Squelch
0

6. Device ID: define the ID code of device

(1) Rotate the rotary switch to “6. Device ID.” Push the rotary switch (or SETUP) to enter the ID setting menu.

(2) Rotate the rotary switch to select the ID from 0-255; push SETUP to save the setting.

This setting determines the use of REMOSET. The receiver and transmitter must have the same “device ID” in order to use REMOSET.

Note: this is not a problem if the microphone ID is not activated.

M	5. Squelch
E	6. Device ID
N	7. Mic Config
U	8. Volume

Setup Device ID	
23	[0~255]

7. Mic Config: Adjust the REMOSET setting of transmitter.

(1) Rotate the rotary switch to “7. Mic Config.” Push the rotary switch (or SETUP) to enter the adjustment menu.

(2) Rotate the rotary switch to select the desired item.

(1. Sensitivity

(1) Rotate the rotary switch to “1. Sensitivity.” Push the rotary switch (or SETUP) to enter the adjustment menu.

Rotate the rotary switch to select and set the value. Push SETUP to save the setting; range: -15dB - +15dB

(2. Attenuate: it sets the attenuation of microphone input volume from body-pack transmitter.

Rotate the rotary switch to “2. Attenuate.” Push the rotary switch (or SETUP) to enter the adjustment menu. Rotate the rotary switch to activate or deactivate.

Push SETUP to save the setting.

Note: this is not supported by handheld transmitters.

M	5. Squelch
E	6. Device ID
N	7. Mic Config
U	8. Volume

1. Sensitivity
2. Attenuate
3. Low Cut
4. RF Power

Mic Sensitivity	
0 dB	

1. Sensitivity
2. Attenuate
3. Low Cut
4. RF Power

Mic Attenuate	
<input checked="" type="radio"/> ON	
<input type="radio"/> OFF	

Mic Attenuate	
<input type="radio"/> ON	
<input checked="" type="radio"/> OFF	

(3. LowCut: base attenuation

Rotate the rotary switch to “3. LowCut.” Push the rotary switch (or SETUP) to enter the adjustment menu.

The Low Cut is not set.

Rotate the rotary switch one notch clockwise to select Low Cut (as shown on the right). Push SETUP to save the setting.

1. Sensitivity
2. Attenuate
3. Low Cut
4. RF Power

Mic Low Cut	

Mic Low Cut	
/_____	

(4. RF Power: RF frequency

Rotate the rotary switch to “4. RF Power” Push the rotary switch (or SETUP) to enter the adjustment menu.

Rotate the rotary switch to select RF Power.

High → high RF Power

Low → low RF Power

Push SETUP to save the setting.

1. Sensitivity
2. Attenuate
3. Low Cut
4. RF Power

Mic RF Power	
<input checked="" type="radio"/> High	
<input type="radio"/> Low	

(5. KeyLock

Rotate the rotary switch to “5. KeyLock.” Push the rotary switch (or SETUP) to enter the adjustment menu.

Rotate the rotary switch to select lock or unlock.

Push SETUP to save the setting.

4. RF Power
5. Kry Lock
6. Remoset Config
7. Return

Mic KeyLock	
<input checked="" type="radio"/> Lock ON	
<input type="radio"/> Lock OFF	

(6. Remoset Config: to select or unselect REMOSET settings.

(1) Rotate the rotary switch to “6. Remoset Config.” Push the rotary switch (or SETUP) to enter the setting menu.

4. RF Power
5. Kry Lock
6. Remoset Config
7. Return

(2) Rotate the rotary switch to select and push the switch to check the selection; REMOSET only synchronizes on checked selections.

- Frequency
- Sensitivity
- Attenuate
- Low Cut
- RF Power
- Key lock
- UserName
- Save and Exit
- Exit Without Save

Select and push SETUP to save the settings.

*At least one item must be selected.

(7. Return: to main menu

Rotate the rotary switch to “7. Return” and push the switch to return to main menu.

4. RF Power
5. Kry Lock
6. Remoset Config
7. Return

8. Volume: volume adjustment

(1) Rotate the rotary switch to “8. Volume.” Push the rotary switch (or SETUP) to enter the volume adjustment menu.

M	5. Squelch
E	6. Device ID
N	7. Mic Config
U	8. Volume

(2) Rotate the rotary switch to locate the desired volume from Mute, -50dB to 0dB. Push SETUP to save the setting.

Setup Volume
-10dB

M	9. Equalizer
E	a. Output Level
N	b. Antenna Power
U	c. User Name

9. Equalizer: equalizer settings

(1) Rotate the rotary switch to “9. Equalizer.” Push the rotary switch (or SETUP) to enter the setting menu.

M	9. Equalizer
E	a. Output Level
N	b. Antenna Power
U	c. User Name

(2) Rotate the rotary switch to select one of the following:
Equalizer deactivated

Setup Equalizer

Decrease low frequency gain

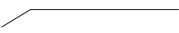
Setup Equalizer

Increase high frequency gain

Setup Equalizer

Decrease low frequency gain and increase high frequency gain

Setup Equalizer

Push SETUP to save the setting.

a. Output Level: XLR audio output level setting

(1) Rotate the rotary switch to “a. Output Level.” Push the rotary switch (or SETUP) to enter the setting menu.

M	9. Equalizer
E	a. Output Level
N	b. Antenna Power
U	c. User Name

(2) Rotate the rotary switch to choose line or mic level:
When “Mic.” is selected, the volume of XLR audio output drops by “-20dB.”

Output Level
<input type="radio"/> Line
<input checked="" type="radio"/> Mic.

Push SETUP to save the setting.

b. Antenna Power: power settings for antenna booster (for antenna A (or B) IN jack)

- (1) Rotate the rotary switch to “b. Antenna Power.” Push the rotary switch (or SETUP) to enter the setting menu.
- (2) Rotate the rotary switch to select:
ON: voltage output +12VDC
OFF: voltage output 0V

Push SETUP to save the setting.

M	9. Equalizer
E	a. Output Level
N	b. Antenna Power
U	c. User Name

Antenna Power	
<input checked="" type="radio"/>	ON
<input type="radio"/>	OFF

c. User Name: user name settings

- (1) Rotate the rotary switch to “c. User Name.” Push the rotary switch (or SETUP) to enter the setting menu.
- (2) Rotate the rotary switch to select the desired characters. Push the rotary switch to confirm the selection, and the screen jumps to the next character to be selected. Select “blank” for positions where no character is needed. Push SETUP to save the setting. The user name could contain up to 10 characters.

Push SETUP to save the setting.

M	9. Equalizer
E	a. Output Level
N	b. Antenna Power
U	c. User Name

User Name	
	UF-20R
	Char: 1/10

Up to 10 characters are allowed

Current character to be selected

d. Contrast: screen contrast settings

- (1) Rotate the rotary switch to “d. Contrast.” Push the rotary switch (or SETUP) to enter the setting menu.
- (2) Rotate the rotary switch to make the screen darker or brighter. Push SETUP to confirm and save the setting. The higher the value, the darker the color tone. There are 7 levels available.

Push SETUP to save the setting.

M	c. User Name
E	d. Contrast
N	e. Reset
U	f. Key Lock

Setup Contrast	
<input type="checkbox"/>	
<input type="checkbox"/>	
<input type="checkbox"/>	
<input type="checkbox"/>	
<input type="checkbox"/>	
<input type="checkbox"/>	
<input type="checkbox"/>	
	3/7

e. Reset

- (1) Rotate the rotary switch to “e. Reset” Push the rotary switch (or SETUP) to enter the setting menu.
*Once reset, all the settings will be returned to factory defaults. If REMOSET is needed, please check that the ID is the same as that of transmitter.

- (2) Push SETUP to reset.

M	c. User Name
E	d. Contrast
N	e. Reset
U	f. Key Lock

This will erase all data from receiver's Internal Storage.	
Press [S] 2 sec to Reset	

f. Key Lock: to set the keypad lock

- (1) rotate the rotary switch to “f. Key Lock” and press the rotary switch (or select SETUP) to enter into the setting screen.
- (2) Rotate the rotary switch to select “Lock ON”. After confirmation, select SETUP to save the setting; “Lock ON” can lock up the keypad of the receiver panel and prevent misoperation touch.

Right side receiver can lock up: REMOSET, SETUP, rotary switch, EXIT and POWER.
Left side receiver can lock up: REMOSET, SETUP, rotary switch and EXIT.

- (3) After KEYPAD LOCK, press any of the keypad the screen will show the Unlocked information.
- (4) Lock OFF: press SETUP for two seconds and enters directly into “KeyLock” setting screen. Rotate the rotary switch to select “Lock OFF” and press SETUP to save the keypad setting.

M	c. User Name
E	d. Contrast
N	e. Reset
U	f. Key Lock

Setup KeyLock	
<input checked="" type="radio"/>	Lock ON
<input type="radio"/>	Lock OFF

Press Setup for 2 Sec. to unlock keypad	
---	--

Setup Key Lock	
<input type="radio"/>	Lock On
<input checked="" type="radio"/>	Lock Off

6-2 Handheld transmitter system operation setting // JSS-20

6-2-1 Power button

(1) Turn on the power

Power On: press POWER 

Power Off: press POWER for approx.

1 second till the screen displays "Power OFF."

Note: when pressing the POWER button, "Mute ON" or "Mute OFF"(in mute state) will first appear and then "Power OFF"

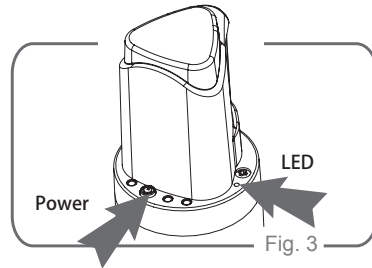

(2) Mute mode: when using the transmitter (screen at the main screen)

To set mute status: short press power button and the screen will display "Mute ON." When it is in mute status, the power indicator light will flashing in red. The screen will go to mute screen.

Mute OFF: short press power button and the screen will display "Mute OFF".

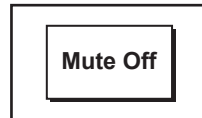

(3) Exist setting menu

When it is in the setting menu: press Power button to go back to the main screen.

When it is in the setting page of menu: press Power button to go back to the main setting menu, press again to go back to the main screen.

** When the battery level is too low, the screen will display "Battery Low." The transmitter will automatically shut down after 30 minutes (approximately).

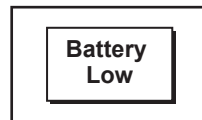

6-2-2 Menu function setting:

press SET and it will enter into menu function setting after two seconds.

(1) Press ▲、▼ Select the desired item.

Press SET to enter into the pre-set option.

(2) After entering into the menu, press ▲、▼ to adjust the values. Press SET to save the setting.

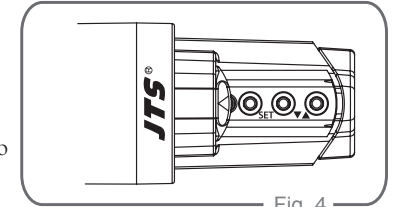

1. Frequency

(1) Press ▲、▼ to enter into "1. Frequency". Press SET to enter into the setting screen.

1. Frequency
2. Group/Channel
3. Sensitivity
4. Low Cut

(2) Adjust the left three digits of frequency.

Press ▲、▼. Use "+/-" with 1MHz as unit adjustment.

After adjustment, press SET to change the right three digits of frequency.

Frequency
624.000 MHz
G: 1 CH: 1

(3) Adjustment of the right three digits of frequency: press ▲、▼ and use "+/-" with 0.025MHz as unit adjustment. After adjustment, press SET to save the setting.

Frequency
624.000 MHz
G: 1 CH: 1

2. Group / Channel

(1) Press ▲、▼ to enter into "2. Group / Channel." Press SET to enter into the setting screen.

1. Frequency
2. Group/Channel
3. Sensitivity
4. Low Cut

(2) After entering into the screen, press ▲、▼ to select desire group. Press SET for saving and change into the channel setting.

Group/Channel
G: 1 C: 1
625.500 MHz

(3) Press ▲、▼ to select desire channel. Press SET to save the setting.

Group/Channel
G: 1 C: 1
625.500 MHz

3. Sensitivity

(1) Press ▲、▼ to “3. Sensitivity.” Press SET to enter into the setting screen.

(2) Press ▲、▼ to adjust the sensitivity. Use 3 dB as unit modification. After adjustment, press SET to save the setting; the range of sensitivity is -15dB~+15dB.

1. Frequency
2. Group/Channel
3. Sensitivity
4. Low Cut

Sensitivity
0 dB

4. Low Cut

Press ▲、▼ to “4. Low Cut” Press SET to enter into the setting screen.

Press ▲: Turn off the Low Cut function.

Press ▼: Turn on the Low Cut function.

After adjustment, press SET to save the setting.

1. Frequency
2. Group/Channel
3. Sensitivity
4. Low Cut

Low Cut
Off <input type="checkbox"/>

Low Cut
ON <input checked="" type="checkbox"/>

5. Device ID

(1) Press ▲、▼ to select “5. Device ID.” Press SET to enter into the setting screen.

(2) Press ▲、▼ to adjust the device ID. The range is from 0 ~ 255. After the adjustment, press SET to go to ID setting: On / Off

Press ▲: ON, The ID of the microphone and the ID of the receiver shall be the same as to use the REMOSET function.

Press ▼: OFF, Ignore the ID value. The microphone will receive all REMOSET information transmitted by “receivers with ID code”

Press SET to save the setting.

5. Device ID
6. Remoset
7. RF Power
8. Contrast

Device ID
0
ID: OFF

Device ID
0
ID: OFF

6. Remoset

Press ▲、▼ to select “6. Remoset” function. Press SET to enter into the setting screen.

Press ▲: to turn on and use REMOSET.

Press ▼: to turn off and REMOSET function cannot be used. The microphone will be more power-saving when not using REMOSET function.

Press SET to save the setting.

5. Device ID
6. Remoset
7. RF Power
8. Contrast

Remoset
<input checked="" type="radio"/> ON
<input type="radio"/> OFF

Remoset
<input type="radio"/> ON
<input checked="" type="radio"/> OFF

7. RF Power

Press ▲、▼ to select “7. RF Power.” Press SET to enter into the screen for RF Power setting.

Press ▲: High: High RF Power

Press ▼: Low: Low RF Power.

Press SET to save the setting.

Note: When it is in “High RF Power”, the power consumption of the microphone is larger which would shorten the usage time of the battery.

5. Device ID
6. Remoset
7. RF Power
8. Contrast

RF Power
<input checked="" type="radio"/> High
<input type="radio"/> Low

RF Power
<input type="radio"/> High
<input checked="" type="radio"/> Low

8. Contrast

(1) Press ▲、▼ to select "8. Contrast." Press SET to enter into the screen for contrast adjustment.

5. Device ID
6. Remoset
7. RF Power
8. Contrast

(2) Press ▲、▼ to adjust the contrast. The higher the value, the darker the color; on the contrary, it would be lighter. There is a total of 0~20.

LCD Contrast
10

9. Light Time

(1) Press ▲、▼ to select "9. Light Time." Press SET to enter into the setting screen.

9. Light Time
a. User Name
b. Reset
c. KeyLock

(2) Press ▲、▼ to select the backlight time: you can select "closed", "5~30 seconds" (having 5 seconds as the unit of change" or "constant light." The longer the backlight time, the shorter the usage time of the battery.

Light Time
10

a. User Name

(1) Press ▲、▼ to select "a. User Name." Press SET to enter into "User Name" screen for the setting.

9. Light Time
a. User Name
b. Reset
c. KeyLock

(2) Press ▲、▼ to select the characters. After confirmation, press SET to select the next character. If no character is needed, select "space". After confirmation, press SET to save the setting; there is a total of 10 characters for setting.

User Name
JSS-20
Char: 1/10

Up to 10 characters are allowed

Current character to be selected

User Name
JSS-20
Char: 1/10

b. Reset

Press ▲、▼ to "b. Reset" and select SET to enter the screen setting.

9. Light Time
a. User Name
b. Reset
c. KeyLock

Press ▲: select CONFIRM to reset the internal information of the handheld transmitter.

Press ▼: select Cancel to cancel the Reset setting

This will erase all date from Mic Internal Storage.
Yes / No

Press SET to save the setting.

c. KEY LOCK: press ▲、▼ to "c. Key lock" and press SET to enter into the setting screen.

9. Light Time
a. User Name
b. Reset
c. KeyLock

(1) Press ▲: ON, to lock up all the buttons and to prevent misoperation touch. Pressing SET for saving.

KeyLock
<input checked="" type="radio"/> ON
<input type="radio"/> OFF

Press ▼: select "OFF" to unlock LOCK. Press SET to save the setting.

KeyLock
<input type="radio"/> ON
<input checked="" type="radio"/> OFF

(2) Unlock: When the main screen is displayed at the screen, press SET for two seconds to get directly into the Lock setting. Press ▼ to unlock and press SET to save the setting.

d. Exit

Press ▲、▼ to "d. Exit" and press SET to go back to the main screen.

a. User Name
b. Reset
c. KeyLock
d. Exit

6-3 Body-pack transmitter system operation setting // UF-20TB

6-3-1 To turn on UF-20TB body-pack transmitter (diagram 5)

- (1) To turn on the power: press the Power button.
- (2) To turn off the power: press the Power button for a while. The screen will display "Power OFF" after approx. 2 seconds. The body-pack transmitter will be turned off.
- (3) To exit the function setting menu: when you are at the function setting menu, press Power button to go back to the main screen.

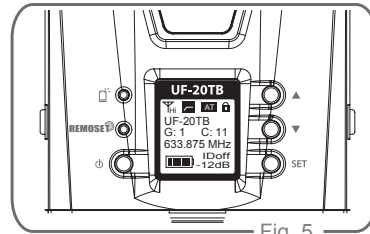

Fig. 5

6-3-2 Function setting menu:

Press SET for a while. After two seconds, it will go into the function setting menu.

- (1) Press ▲、▼ and select the desired item. Press SET to enter into the menu.
- (2) After entering into the menu, press ▲、▼ to adjust the values. Press SET to save the setting.

1. Frequency: set the frequency

(1) Press ▲、▼ to frequency setting. Press SET to enter into the frequency setting screen.

Frequency
Group/Chan
Sensitivity
Attenuate
Low Cut

(2) When entering into the frequency adjustment screen, adjust the first three digits of frequency at the left. Press ▲、▼ using "+/-" with 1MHz as the unit of modification. After adjustment, press SET to adjust the three frequency at the right.

Frequency
624.750
G: 1 C: 1

(3) Adjust the three digits of frequency at the right: Press ▲、▼ using "+/-" with 0.025MHz as the unit of modification. After the adjustment, press SET to save the setting.

Frequency
624.750
G: 1 C: 1

2. Group / Channel

(1) Press ▲、▼ to select "2. Group / Channel." Press SET to enter into the setting screen.

Frequency
Group/Chan
Sensitivity
Attenuate
Low Cut

(2) After entering into the screen, press ▲、▼ to select desire Group. Press SET for saving and change into the channel setting.

Group/Chan
G: 1
C: 1
624.750MHz

(3) Press ▲、▼ to select desire channel. Press SET to save the setting.

Group/Chan
G: 1
C: 1
624.750MHz

3. Sensitivity

(1) Press ▲、▼ to "Sensitivity." Press SET to enter into the "Sensitivity" setting screen.

Frequency
Group/Chan
Sensitivity
Attenuate
Low Cut

(2) Press ▲、▼ to adjust the sensitivity. Use 3 dB as unit of modification. After adjustment, press SET to save the setting; the range of sensitivity is -15dB~-15dB.

Sensitivity
0 dB

Sensitivity
-3 dB

4. Attenuate

(1) Press ▲、▼ to enter into "Attenuate." Press SET to enter into the "Attenuate" setting screen.

Frequency
Group/Chan
Sensitivity
Attenuate
Low Cut

(2) Press ▲ to turn on

Attenuate
<input checked="" type="radio"/> ON
<input type="radio"/> OFF

(3) Press ▼ to turn off

After adjustment, press SET to save the setting.

Attenuate
<input type="radio"/> ON
<input checked="" type="radio"/> OFF

5. Low Cut

(1) Press ▲、▼ to select “Low Cut.” Press SET to enter into the “Low Cut” setting screen.

(2) Press ▲ to turn on the Low Cut function.

(3) Press ▼ to turn off the Low Cut function.

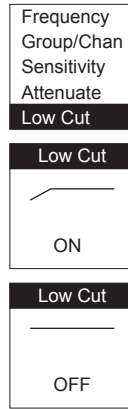

5. Device ID: to set the Device ID

(1) Press ▲、▼ to set the ID. Press SET to enter into “Device ID” setting screen.

(2) Press ▲、▼ to adjust the pre-set ID value. The range is from 0 ~ 255. After the adjustment, press SET to go to ID setting: On / Off

ID: On → The ID of the microphone and the ID of the receiver shall be the same as to use the REMOSET function.

ID: OFF → Ignore the ID value. The microphone will receive all REMOSET information transmitted by “receivers with ID code”

Press SET for setting.

This setting will affect the usage of REMOSET.

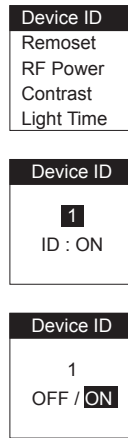

6. RemoSet: to turn on/off the REMOSET

(1) Press ▲、▼ to select REMOSET function. Press SET to enter into “RemoSet” setting screen.

(2) Press ▲: to turn on and REMOSET function can be used.

(3) Press ▼: to turn off. REMOSET function cannot be used. The microphone will be more power-saving. When not using REMOSET function, it can prolong the usage time of the battery when it is “OFF.”

7. RF Power: setting of RF power

(1) Press ▲、▼ to select RF power. Press SET to enter into “RF Power” screen for RF power setting.

(2) Press ▲: High → High RF power

(3) Press ▼: Low → Low RF power.

Press SET to save the setting.

Note: When It is in “High RF power”, the power consumption of the microphone is larger which would shorten the usage time of the battery.

8. Contrast: adjustment of screen contrast

(1) Press ▲、▼ to select “Contrast.” Press SET to enter “Contrast” screen for contrast adjustment.

(2) Press ▲、▼ to adjust the contrast. The higher the value, the darker the color; on the contrary, it would be lighter. There is a total of 0~20, 21 level of adjustment.

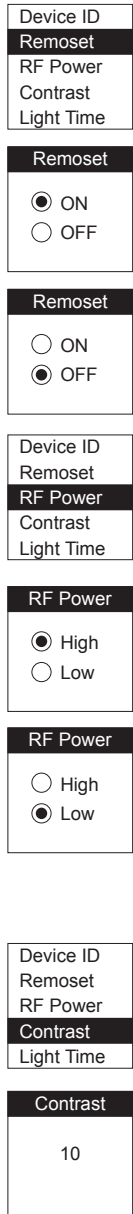

9. Light Time: the setting of the backlight time

(1) Press ▲、▼ to select backlight time. Press SET to enter into "Light Time" screen.

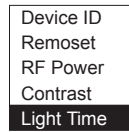

(2) Press ▲、▼ to select the backlight time; you can select "closed", "5~30 seconds"(having 5 seconds as the unit of change) or "constant light." The longer the backlight time, the shorter the usage time of the battery.

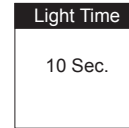

10. User Name: the setting of the user's name

(1) Press ▲、▼ to select user name. Press SET to enter into "User Name" screen for the setting of the user's name.

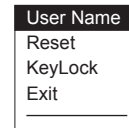

(2) Press ▲、▼ to select the characters. After confirmation, press SET to select the next character. If no character is needed, select "space". After confirmation, press SET to save the setting; there is a total of 10 characters for setting.

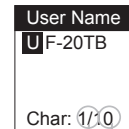

The character in the process of setting

A total of 10 characters for setting

11. Reset

- (1) Press ▲、▼ to select reset. Press SET to enter into "Reset" screen.
- (2) Press ▲ to select confirm as to reset the internal information of the handheld transmitter. Press SET to save the setting.
- (3) Press ▼ to select cancel as to cancel the reset setting. Press SET to save the setting.

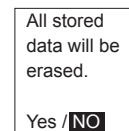
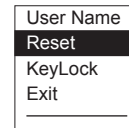

12. Key Lock: setting of the keypad lock

(1) Press ▲、▼ to the keypad lock. Press SET to enter into "key Lock" screen for keypad lock setting.

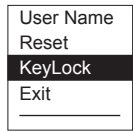

(2) Press ▲、▼ to select lock "ALL", "Set & Power" only or lock "OFF". Press SET to save the setting.

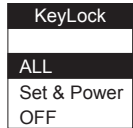

ALL: All the buttons are locked as to prevent any misoperation touch.(include Mute switch)

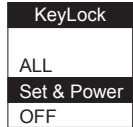

Set & Power: Only function buttons are locked, Mute switch will not be locked.

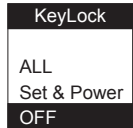

(3) Press ▲、▼ to select lock off. Press SET to save the setting.

(4) To unlock: press SET for two seconds and it will directly go into the key lock screen. Press ▼ to select OFF. Press SET to save the setting.

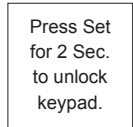

13. Exit

Press ▲、▼ to select exit setting. Press SET to go back to the main screen.

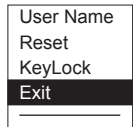

6-4 Installation of Condenser Microphones

(1) Lavalier microphone

Attach lavalier microphone to a tie, lapel, where is suitable for sound pick-up. Plug the connector into input socket on the body-pack transmitter.

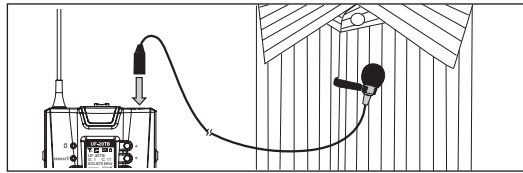

(2) Headset microphone

Put the headband behind your head, and fix the temples on your ears as shows, then adjust the gooseneck to have best miking. Plug the connector into input socket on the body-pack transmitter.

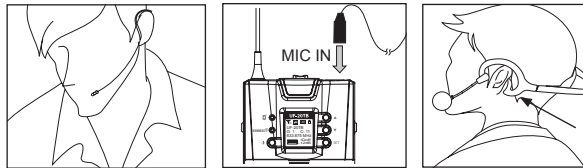

(3) Instrument Microphones

The system is compatible with JTS various instrument microphones. For detail please refer to user's manuals of these microphones.

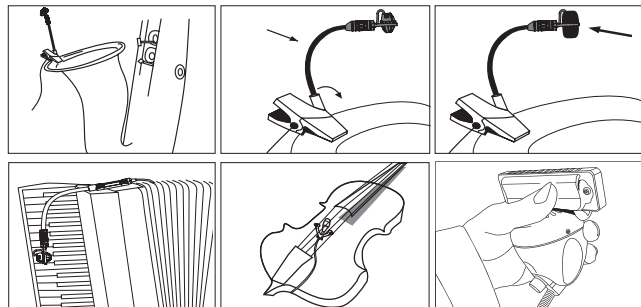

(4) Ear-hook Microphone

1. Lightweight Dual Ear Hook Microphone

Try on whether the headset is fit.
Adjust the headband to a suitable width.
Tighten or loosen the curve of the ear-hook by twisting the loop or expanding it.
Curve and bend the boom to fit your face.
Attach the detachable cable to a suitable place by a cable clip.

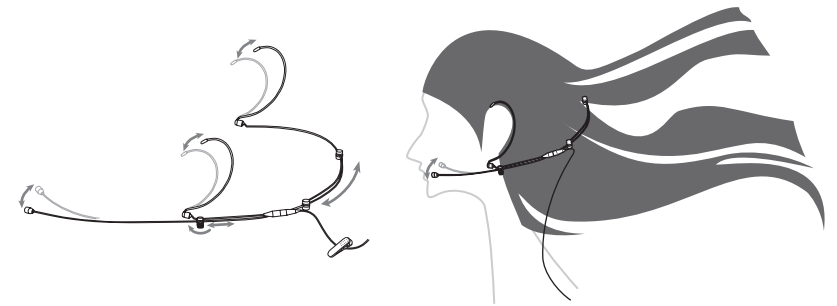

2. Lightweight Single Ear Hook Microphone

Try on whether the original curve is tight or loose.
Re-try and push the fixed curve against your earlobe.
Curve and Bend the boom to fit your face.
Attach the detachable cable to a suitable place by a cable clip.

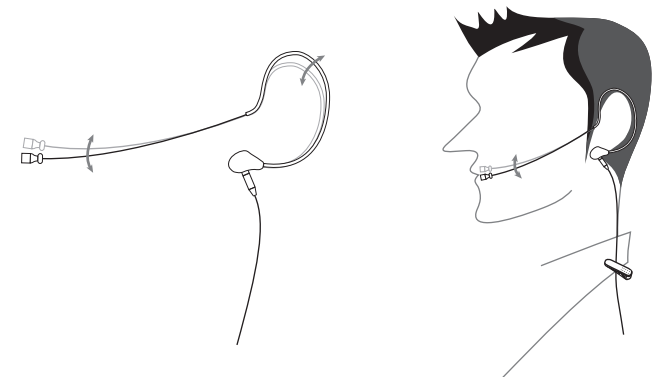

7. Product notes

- (1) To get the best signal performance, please keep at least 3 meters between a receiver and a transmitter.
- (2) Keep a receiver and transmitter from other metal object for at least 50cm.
- (3) To prevent feedback and whistle, please do not aim transmitter to speaker.
- (4) It is suggested to hold the middle section of transmitter (microphone) body to achieve the best pickup effect.
- (5) When transmitter is not used for a long time, please remove batteries from battery compartment to avoid leakage of electrolyte solution to damage transmitter.
- (6) When replacing batteries, please replace two batteries at the same time and use the same brand of battery, to assure the best power performance.

8. Important Notice

- (1) JTS offers wireless systems in a selection of bands that conform to the different government regulations of specific nations or geographic regions. These regulations help limit radio frequency (RF) interference among different wireless devices and prevent interference with local public communications channels, such as television and emergency broadcasts.
- (2) For information on bands available in your area, consult your local dealer or phone JTS. More information is also available at JTS's website (www.jts.com.tw).
- (3) This Radio apparatus may be capable of operating on some frequencies not authorized in your region. Please contact your national authority to obtain information on authorized frequencies and RF power levels for wireless microphone products.