

KENWOOD

**TK-7160/ TK-8160
TK-7160H/ TK-8160H**

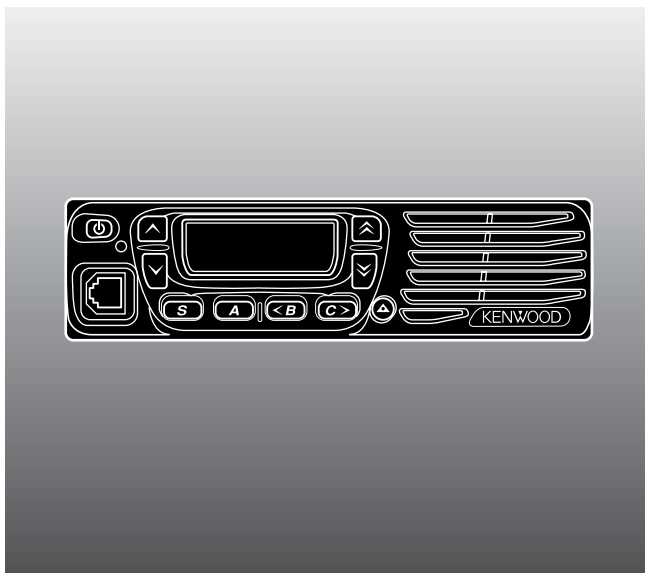

VHF FM TRANSCEIVER/ UHF FM TRANSCEIVER

INSTRUCTION MANUAL

ÉMETTEUR-RÉCEPTEUR FM VHF/ ÉMETTEUR-RÉCEPTEUR FM UHF

MODE D'EMPLOI

TRANSCÉPTOR FM VHF/ TRANSCÉPTOR FM UHF

MANUAL DE INSTRUCCIONES

KENWOOD CORPORATION

© B62-1829-00 (K,M)
09 08 07 06 05 04 03 02 01 00

VHF FM TRANSCEIVER/
UHF FM TRANSCEIVER

TK-7160/ TK-8160

TK-7160H/ TK-8160H

INSTRUCTION MANUAL

KENWOOD CORPORATION

ENGLISH

THANK YOU

We are grateful you chose **KENWOOD** for your personal mobile applications. We believe this easy-to-use transceiver will provide dependable communications to keep personnel operating at peak efficiency.

KENWOOD transceivers incorporate the latest in advanced technology. As a result, we feel strongly that you will be pleased with the quality and features of this product.

MODELS COVERED BY THIS MANUAL

The models listed below are covered by this manual:

- **TK-7160:** VHF FM Transceiver
- **TK-7160H:** High Power VHF FM Transceiver
- **TK-8160:** UHF FM Transceiver
- **TK-8160H:** High Power UHF FM Transceiver

NOTICES TO THE USER

- ◆ Government law prohibits the operation of unlicensed transmitters within the territories under government control.
- ◆ Illegal operation is punishable by fine and/or imprisonment.
- ◆ Refer service to qualified technicians only.

SAFETY: It is important that the operator is aware of, and understands, hazards common to the operation of any transceiver.



WARNING

- ◆ **EXPLOSIVE ATMOSPHERES (GASES, DUST, FUMES, etc.)**
Turn OFF your transceiver while taking on fuel or while parked in gasoline service stations. Do not carry spare fuel containers in the trunk of your vehicle if your transceiver is mounted in the trunk area.
- ◆ **INJURY FROM RADIO FREQUENCY TRANSMISSIONS**
Do not operate your transceiver when somebody is either touching the antenna or standing within 2 to 3 feet (60 to 90 cm) of it, to avoid the possibility of radio frequency burns or related physical injury.
- ◆ **DYNAMITE BLASTING CAPS**
Operating the transceiver within 500 feet (150 m) of dynamite blasting caps may cause them to explode. Turn OFF your transceiver when in an area where blasting is in progress, or where "TURN OFF TWO-WAY RADIO" signs have been posted. If you are transporting blasting caps in your vehicle, make sure they are carried in a closed metal box with a padded interior. Do not transmit while the caps are being placed into or removed from the container.

PRECAUTIONS

Observe the following precautions to prevent fire, personal injury, and transceiver damage.

- Do not attempt to configure the transceiver while driving; it is too dangerous.
- Do not disassemble or modify the transceiver for any reason.
- Do not expose the transceiver to long periods of direct sunlight, nor place it near heating appliances.
- Do not place the transceiver in excessively dusty, humid, or wet areas, nor on unstable surfaces.
- If an abnormal odor or smoke is detected coming from the transceiver, switch the transceiver power off immediately, and contact your **KENWOOD** dealer.
- Use of the transceiver while you are driving may be against traffic laws. Please check and observe the vehicle regulations in your area.
- Do not use options not specified by **KENWOOD**.

One or more of the following statements may be applicable:

FCC WARNING

This equipment generates or uses radio frequency energy. Changes or modifications to this equipment may cause harmful interference unless the modifications are expressly approved in the instruction manual. The user could lose the authority to operate this equipment if an unauthorized change or modification is made.

INFORMATION TO THE DIGITAL DEVICE USER REQUIRED BY THE FCC

This equipment has been tested and found to comply with the limits for a Class B digital device, pursuant to Part 15 of the FCC Rules. These limits are designed to provide reasonable protection against harmful interference in a residential installation.

This equipment generates, uses and can generate radio frequency energy and, if not installed and used in accordance with the instructions, may cause harmful interference to radio communications. However, there is no guarantee that the interference will not occur in a particular installation. If this equipment does cause harmful interference to radio or television reception, which can be determined by turning the equipment off and on, the user is encouraged to try to correct the interference by one or more of the following measures:

- Reorient or relocate the receiving antenna.
- Increase the separation between the equipment and receiver.
- Connect the equipment to an outlet on a circuit different from that to which the receiver is connected.
- Consult the dealer for technical assistance.

CONTENTS

UNPACKING AND CHECKING EQUIPMENT	1
SUPPLIED ACCESSORIES	1
PREPARATION	2
TOOLS REQUIRED	2
POWER CABLE CONNECTION	2
INSTALLING THE TRANSCEIVER	3
CONNECTING A MICROPHONE	4
GETTING ACQUAINTED	5
FRONT PANEL	5
DISPLAY	7
REAR PANEL	7
PROGRAMMABLE FUNCTIONS	8
BASIC OPERATIONS	10
SWITCHING POWER ON/ OFF	10
ADJUSTING THE VOLUME	10
SELECTING A ZONE AND CHANNEL	11
TRANSMITTING	11
RECEIVING	11
SCAN	12
PRIORITY SCAN	12
ADD TO SCAN/ DELETE FROM SCAN	13
REVERT CHANNEL	13
DTMF CALLS	14
STORE & SEND	14
MANUAL DIALING	14
STORING DTMF NUMBERS	14
DIALING STORED DTMF NUMBERS	15
CLEARING STORED DTMF NUMBERS	15
REDIALING	15
STUN	15
QUIET TALK (QT)/ DIGITAL QUIET TALK (DQT)	16
OPERATOR SELECTABLE TONE (OST)	16

CODE SQUELCH (ID CODE)	17
RECEIVING	17
TRANSMITTING	17
SELECTIVE CALL	18
RECEIVING	18
TRANSMITTING	18
2-TONE SIGNALING	19
RECEIVING	19
TRANSMITTING	19
FleetSync: ALPHANUMERIC 2-WAY PAGING SYSTEM	20
GPS REPORT	20
SELCALL (SELECTIVE CALLING)	20
STATUS MESSAGE	21
EMERGENCY OPERATION	22
ADVANCED OPERATIONS	23
TALK-AROUND	23
DTMF NUMBER DISPLAY	23
HORN ALERT	23
PUBLIC ADDRESS (PA) SYSTEM	24
MONITOR	24
VOICE SCRAMBLER	25
KEY LOCK	25
BACKGROUND OPERATIONS	26
TIME-OUT TIMER (TOT)	26
BUSY CHANNEL LOCKOUT (BCL)	26
BEGINNING/ END OF TRANSMIT SIGNAL	26

UNPACKING AND CHECKING EQUIPMENT

Note: The following unpacking instructions are for use by your **KENWOOD** dealer, an authorized **KENWOOD** service facility, or the factory.

Carefully unpack the transceiver. We recommend that you identify the items listed in the following table before discarding the packing material. If any items are missing or have been damaged during shipment, file a claim with the carrier immediately.

SUPPLIED ACCESSORIES

Item	Part Number	Quantity
Microphone (with cable) (K type only)	T91-0639-XX	1
Microphone hanger (with 4 x 16 mm self-tapping screws) (K type only)	J19-1584-XX	1
DC power cable (with fuses) • 10 A fuse (TK-7160/ TK-8160 only) • 15 A fuse (TK-7160H/ TK-8160H only)	E30-3339-XX	1
	F51-0016-XX	2
	F51-0017-XX	
Mounting bracket	J29-0662-XX	1
Screw set: • 5 x 16 mm self-tapping screw (4 pieces) • Hex-headed screw with washer (4 pieces) • Spring washer (4 pieces) • Flat washer (4 pieces)	N99-0395-XX	1
Instruction manual	B62-1829-XX	1

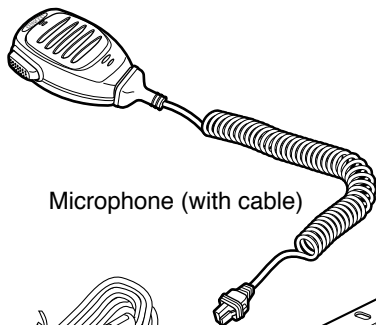

Microphone (with cable)

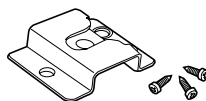

Microphone hanger
(with 4 x 16 mm self-tapping screws)

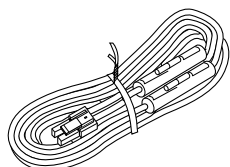

DC power cable (with fuses)

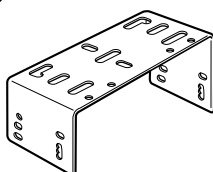

Mounting bracket

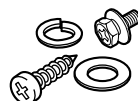

Screw set

PREPARATION



WARNING

Various electronic equipment in your vehicle may malfunction if they are not properly protected from the radio frequency energy which is present while transmitting. Electronic fuel injection, anti-skid braking, and cruise control systems are typical examples of equipment that may malfunction. If your vehicle contains such equipment, consult the dealer for the make of vehicle and enlist his/her aid in determining if they will perform normally while transmitting.

Note: The following preparation instructions are for use by your **KENWOOD** dealer, an authorized **KENWOOD** service facility, or the factory.

TOOLS REQUIRED

Note: Before installing the transceiver, always check how far the mounting screws will extend below the mounting surface. When drilling mounting holes, be careful not to damage vehicle wiring or parts.

The following tools are required for installing the transceiver:

- 6 mm (1/4 inch) or larger electric drill
- 4.2 mm (5/32 inch) drill bit for the 5 x 16 mm self-tapping screws
- 3.2 mm (1/8 inch) drill bit for the 4 x 16 mm self-tapping screws
- Circle cutters

POWER CABLE CONNECTION



CAUTION

The transceiver operates in **12 V** negative ground systems only! Check the battery polarity and voltage of the vehicle before installing the transceiver.

- 1 Check for an existing hole, conveniently located in the firewall, where the power cable can be passed through.
 - If no hole exists, use a circle cutter to drill the firewall, then install a rubber grommet.
- 2 Run the two power cable leads through the firewall and into the engine compartment, from the passenger compartment.
- 3 Connect the red lead to the positive (+) battery terminal and the black lead to the negative (-) battery terminal.
 - Locate the fuse as close to the battery as possible.
- 4 Coil the surplus cable and secure with a retaining band.
 - Be sure to leave enough slack in the cables so the transceiver can be removed for servicing while keeping the power applied.

INSTALLING THE TRANSCEIVER



WARNING

For passenger safety, install the transceiver securely using the supplied mounting bracket, so the transceiver will not break loose in the event of a collision.

- 1 Mark the position of the holes in the dash by using the mounting bracket as a template. Drill the holes, then attach the mounting bracket using the supplied 5 x 16 mm self-tapping screws.
 - Be sure to mount the transceiver in a location where the controls are within easy reach of the user and where there is sufficient space at the rear of the transceiver for cable connections.
- 2 Connect the antenna and the supplied power cable to the transceiver.
- 3 Slide the transceiver into the mounting bracket and secure it using the supplied hex-headed screws.
- 4 Mount the microphone hanger in a location where it will be within easy reach of the user.
 - The microphone and microphone cable should be mounted in a place where they will not interfere with the safe operation of the vehicle.



CAUTION

When replacing the fuse in the DC power cable, be sure to replace it with a fuse of the same value. Never replace a fuse with one that is rated with a higher value.

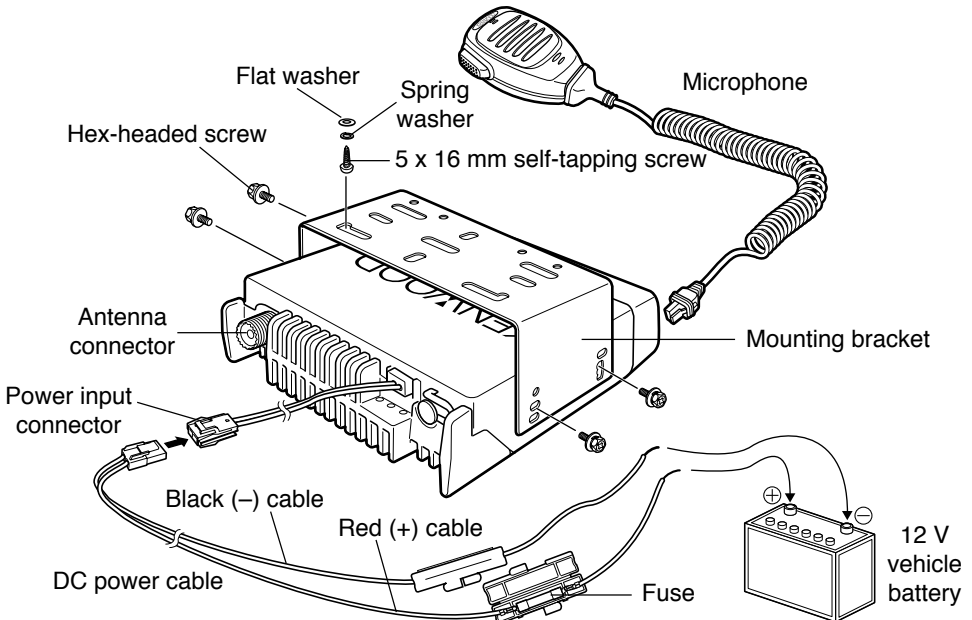

Note: The microphone is supplied only with K type models; it is not supplied with M type models. The model type is marked on the carton.

CONNECTING A MICROPHONE

- 1 Insert the microphone plug into the jack on the front panel of the transceiver.
 - Be sure the tab on the microphone plug is facing the left hand side.
- 2 Mount the microphone on the microphone hanger where it will be within easy reach of the user.
- 3 To remove the microphone plug, press the tab on the connector while pulling the plug out of the transceiver jack.

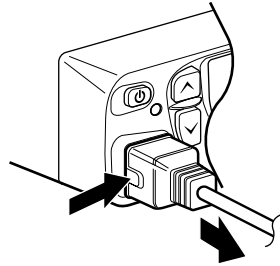
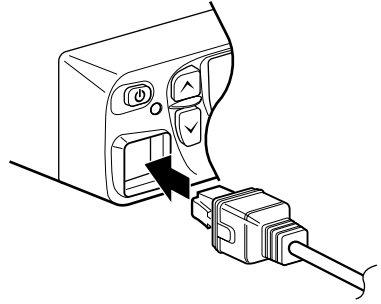

GETTING ACQUAINTED

FRONT PANEL

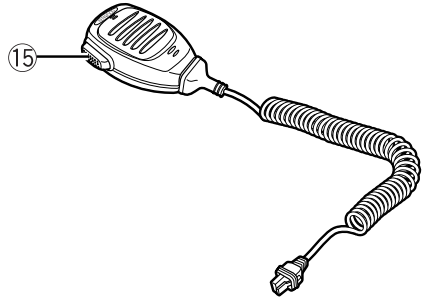
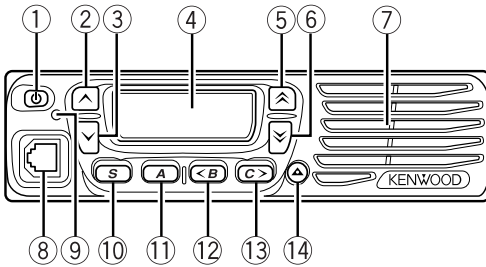

- ① **⏻ (Power) switch**
Press to switch the transceiver ON or OFF.
- ② **^ key**
Press to activate its programmable function {page 8}. The default setting is Volume Up.
- ③ **∨ keys**
Press to activate its programmable function {page 8}. The default setting is Volume Down.
- ④ **Display**
Refer to page 7.
- ⑤ **⤴ key**
Press to activate its programmable function {page 8}. The default setting is Zone Up.
- ⑥ **⤵ key**
Press to activate its programmable function {page 8}. The default setting is Zone Down.
- ⑦ **Speaker**
Internal speaker.
- ⑧ **Microphone jack**
Insert the microphone plug into this jack {page 4}.
- ⑨ **TX/RX Indicator**
Lights red while transmitting. Lights green while receiving a signal.
- ⑩ **S key**
Press to activate its programmable function {page 8}. The default setting is Squelch Off Momentary.

- ⑪ **A key**
Press to activate its programmable function {page 8}. The default setting is None (no function).
- ⑫ **<B key**
Press to activate its programmable function {page 8}. The default setting is Channel Down.
- ⑬ **C> key**
Press to activate its programmable function {page 8}. The default setting is Channel Up.
- ⑭ **▲ key**
Press to activate its programmable function {page 8}. The default setting is None (no function).
- ⑮ **PTT switch**
Press this switch, then speak into the microphone to call a station.

DISPLAY

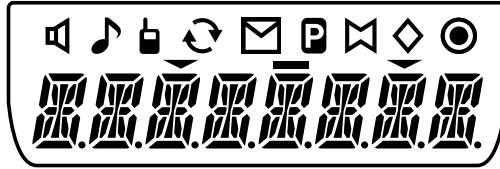

Indicator	Description
	Appears when the key programmed as Monitor or Squelch Off is pressed.
	Appears when the DTMF or 2-tone code of a call matches the code in your transceiver.
	Appears while using the Talk Around function.
	The selected zone is added to the scanning sequence.
	Appears while scanning.
	Appears when a message is stored in the transceiver stack memory. Appears and blinks when a new message has arrived.
	Appears when the AUX port has been activated.
	The selected channel is set as a Priority channel.
	Appears when the Horn Alert function has been activated.
	The selected channel is added to the scanning sequence.
	Appears when Scrambler function has been selected.
	Appears when the Public Address function has been activated.
	Displays the currently selected zone and channel number, or the channel name.

REAR PANEL

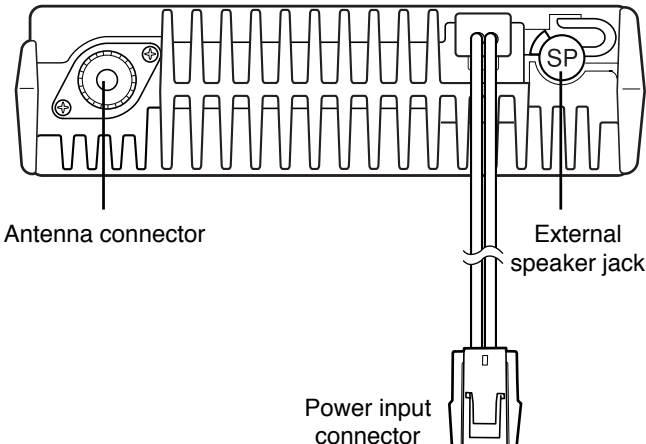

PROGRAMMABLE FUNCTIONS

The ^, v, ^, v, S, A, <B, C>, and ▲ keys can be programmed with the functions listed below:

- **2-tone Encode**
Press to enter 2-tone Encode Select mode. Refer to page 19 for details.
- **AUX**
Press to activate the auxiliary port. Press again to deactivate the auxiliary port. (The auxiliary port is used with optional boards.) While the auxiliary port is activated, the  icon appears on the display.
- **Call 1**
Press to transmit the programmed FleetSync Status message, DTMF code, or 2-tone code.
- **Call 2**
Press to transmit the programmed FleetSync Status message, DTMF code, or 2-tone code.
- **Channel Down**
Press to decrease the channel number.
- **Channel Up**
Press to increase the channel number.
- **Direct Zone Channel ¹**
Press and hold for 3 seconds to store the currently selected zone and channel as the Direct Zone Channel. Press at any time to immediately jump to the transceiver's Direct Zone Channel. (The default Direct Zone Channel is the lowest channel of the lowest zone.)
- **Display Character**
Press to toggle the display between the zone number/ channel number and the channel name. If no channel name has been programmed for the selected channel, the zone number/ channel number will be displayed.
- **Emergency ²**
Press and hold to enter Emergency mode. Refer to page 22 for details.
- **Horn Alert**
Press to toggle the Horn Alert function ON and OFF. Refer to page 23 for details.
- **Key Lock**
Press to lock or unlock the transceiver keys. Refer to page 25 for details.
- **LCD Brightness**
Press to toggle the display brightness between high and low. The default setting is high.
- **Monitor**
Press to turn the transceiver signaling OFF. Press again to return to normal operation. Refer to page 24 for details.

- **None**
No function is programmed onto the key.
- **Operator Selectable Tone**
Press to enter OST (Operator Selectable Tone) Select mode. Refer to page 16 for details.
- **Public Address**
Press to activate the Public Address (PA) system. Refer to page 24 for details.
- **Scan Del/Add**
Press to add or remove the selected channel to/from the Scan list. Refer to page 13 for details.
- **Scan On/Off**
Press to toggle the Scan function ON and OFF. Refer to page 12 for details.
- **Scrambler**
Press to toggle the Voice Scrambler ON and OFF. Refer to page 25 for details.
- **Selcall**
Press to enter FleetSync Selcall mode. Refer to page 20 for details.
- **Selcall + Status**
Press to enter FleetSync Selcall mode. Press again to enter FleetSync Status mode. Refer to pages 20 and 21 for details.
- **Send GPS**
Press to send GPS data using FleetSync. Refer to page 20 for details.
- **Squelch Level**
Press to enter Squelch Level Adjustment mode. Refer to page 24 for details.
- **Squelch Off**
Press to open the squelch, to hear weak signals or adjust the volume level when no signal is present. Press again to return to normal operation.
- **Status**
Press to enter FleetSync Status mode. Refer to page 21 for details.
- **Talk Around**
Press to communicate with other transceivers without the use of a repeater. Press again to return to normal operation. Refer to page 23 for details.
- **Volume Down**
Press to decrease the volume level.
- **Volume Up**
Press to increase the volume level.
- **Zone Down**
Press to decrease the zone number.
- **Zone Up**
Press to increase the zone number.

¹ Direct Zone Channel can be programmed only on the **S**, **A**, **<B**, **C>**, and **▲** keys.

² Emergency can be programmed only on the **▲** key.

BASIC OPERATIONS

SWITCHING POWER ON/ OFF

Press the **⏻** switch to switch the transceiver ON.

- A beep sounds. If programmed, an 8-character power-on message is also momentarily displayed.
- If the Transceiver Password function is programmed, “*PASSWORD*” will appear on the display when the power is turned ON. Refer to “Transceiver Password”, below.

Press the **⏻** switch again to switch the transceiver OFF.

■ Transceiver Password

To enter the password:

- 1 Press the **⤴** and **⤵** keys to select a digit.
- 2 Press the **C>** key to accept the entered digit and move to the next digit.
 - Press the **A** key to delete an incorrect character. Press and hold the **A** key to delete all entered characters.
 - Repeat steps 1 and 2 to enter the entire password.
- 3 Press the **S** key to confirm the password.
 - If you enter an incorrect password, an error tone sounds and the transceiver remains locked.

To enter the password using an optional DTMF keypad:

- 1 Press the DTMF keys corresponding to the password digits.
 - Press the **A** or DTMF # key to delete an incorrect character. Press and hold the **A** or DTMF # key to delete all entered characters.
- 2 Press the **S** or DTMF * key to confirm the password.
 - If you enter an incorrect password, an error tone sounds and the transceiver remains locked.

ADJUSTING THE VOLUME

Press the **Volume Up** (**⤴**) key to increase the volume. Press the **Volume Down** (**⤵**) key to decrease the volume.

If Squelch Off has been programmed onto a key, you can press and hold the **Squelch Off** key to listen to background noise while adjusting the volume level.

SELECTING A ZONE AND CHANNEL

Select the desired zone using the keys programmed as **Zone Up** and **Zone Down**.

- The default setting for the \wedge key is **Zone Up**.
- The default setting for the \vee key is **Zone Down**.

Select the desired channel using the keys programmed as **Channel Up** and **Channel Down**.

- The default setting for the **<B** key is **Channel Down**.
- The default setting for the **C>** key is **Channel Up**.

Names of up to 8 characters in length can be programmed for channels.

TRANSMITTING

Note: Before transmitting, first monitor the channel to make sure it is not already in use.

- 1 Select your desired zone and channel (above).
 - If the channel is busy, wait until it becomes free.
- 2 Press the microphone **PTT** switch and speak into the microphone in your normal voice. Release the **PTT** switch when you have finished speaking.
 - For best sound quality at the receiving station, hold the microphone approximately 1.5 inches (3 ~ 4 cm) from your mouth.

RECEIVING

- 1 Select your desired zone and channel (above).
- 2 When you hear a signal, readjust the volume level if necessary.
 - Your dealer may have programmed an encode and decode tone pair on your transceiver. If your selected channel is programmed with these tones, you will hear calls only when another party in your system makes a call. All other calls will not be heard.
- 3 Respond to the call as described in step 2 of “TRANSMITTING”, above.

SCAN

Scan is useful for monitoring signals on the transceiver channels. Scan can be used as either Single Scan or Multi Scan and is programmed by your dealer.

- Single Scan monitors only the channels of a single zone. To monitor other zones, press the **Zone Up** or **Zone Down** key during Scan. Scan will then begin monitoring the channels of the newly selected zone.
- Multi Scan monitors the channels of every zone that has been added to the Scan list.

To activate Scan, press the key programmed as **Scan**.

- “SCAN” and the  icon appear on the display.
- When a signal is detected on a channel, “SCAN” is replaced with the zone number/channel number or the channel name. The transceiver will remain on the channel until the signal is no longer present.
- When the signal is no longer present, the transceiver will remain on the channel momentarily before Scan resumes. The delay time is programmed by your dealer. If a signal is received during the delay time, the transceiver will remain on the same channel.

To stop scanning, press the **Scan** key again.

Note: In order for Scan to function, there must be at least 2 channels added to the scanning sequence. If there are less channels than this, Scan will not operate.

PRIORITY SCAN

Your dealer may have set up a Priority channel on your transceiver.

During Priority Scan, the transceiver will continuously monitor the Priority channel while receiving a signal on another channel. When a signal is received on the Priority channel, the transceiver immediately switches to that channel. The  icon appears on the display, indicating that the Priority channel is the current channel.



The transceiver remains on the Priority channel until the signal is no longer present. When the signal “drops out”, the transceiver will remain on the channel momentarily before scan resumes. This delay time is programmed by your dealer.

ADD TO SCAN/ DELETE FROM SCAN

Depending on how your transceiver has been set up, a key may have been programmed with the **Scan Del/Add** function. This function allows you to scan only those channels which you desire.

To add or remove a channel to/from the Scan list, select the desired channel then press the **Scan Del/Add** key.

To temporarily remove a channel from the Scan list, during Scan, press the **Scan Del/Add** key while Scan is paused on the undesired channel. After switching the Scan function OFF, or switching the transceiver OFF and then ON again, the Scan settings return to normal.

The  icon appears on the display when the selected channel is added to the Scan list. The  icon disappears when the selected channel is removed from the Scan list.

To add or remove a zone to/from the Scan list, select the desired zone then press and hold the **Scan Del/Add** key for approximately 1 second.

To temporarily remove a zone from the Scan list, during Scan, press and hold the **Scan Del/Add** key for approximately 1 second while Scan is paused on a channel in the undesired zone. After switching the Scan function OFF, or switching the transceiver OFF and then ON again, the Scan settings return to normal.

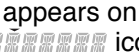
The  icon appears on the display when the selected zone is added to the Scan list. The  icon disappears when the selected zone is removed from the Scan list.

REVERT CHANNEL

During Scan, pressing the **PTT** switch to transmit will cause the transceiver to select the Revert channel. Your dealer programs the Revert channel for your transceiver with one of the following six types:

- **Selected:** The last channel selected prior to Scan is the Revert channel.
- **Selected + Talkback:** While the transceiver is paused on a channel during Scan, pressing the **PTT** switch will allow you to transmit (talk back) on the current channel. Otherwise, the last channel selected prior to Scan is the Revert channel.
- **Priority:** If your dealer has programmed a Priority channel, this channel is the Revert channel.
- **Priority + Talkback:** While the transceiver is paused on a channel during Scan, pressing the **PTT** switch will allow you to transmit (talk back) on the current channel. Otherwise, the Priority channel is the Revert channel.
- **Last Called:** The last channel on which a call was received is the Revert channel, even if Scan has already resumed.
- **Last Used:** The last channel on which you transmitted is the Revert channel.

DTMF CALLS

Note: To make DTMF calls, you must have an optional microphone with a DTMF keypad.

STORE & SEND

- 1 Enter the desired digits on the microphone keypad.
 - You can enter a maximum of 16 digits (**0 ~ 9**, **A ~ D**, *****, and **#**).
 - The digits appear on the display as you enter them.
 - If Keypad Auto-PTT is enabled by your dealer, this method of entering a string of digits will not function. Refer to “MANUAL DIALING”, below.
- 2 Press the **PTT** switch to transmit the entered digits.

MANUAL DIALING

- 1 Press and hold the **PTT** switch.
- 2 Enter the desired digits on the microphone keypad.
 - You can enter the digits **0 ~ 9**, **A ~ D**, *****, and **#**. (**A ~ D** may be disabled by your dealer.)
 - If Keypad Auto-PTT is enabled by your dealer, you do not need to press the **PTT** switch while entering digits; the transceiver will transmit the DTMF tones automatically as you enter the digits.

STORING DTMF NUMBERS

If Auto Dialing has been activated by your dealer, you can store DTMF numbers (16 digits maximum) in each of the 9 Auto Dial memory locations (1 ~ 9).

- 1 Press the microphone **#** key.
 - “**J**” appears on the display.
- 2 Enter the desired digits on the microphone keypad.
 - You can enter the digits **0 ~ 9**, **A ~ D**, *****, and **#**.
 - To enter “**#**”, press and hold the **PTT** switch while entering the **#** key.
 - To cancel, press any key on the transceiver front panel.
- 3 Press the microphone **#** key, then enter a memory location number (1 ~ 9).

DIALING STORED DTMF NUMBERS

- 1 Press the microphone * key.
 - “R” appears on the display.
- 2 Enter the desired memory location number (1 ~ 9).
 - The digits stored in the selected location number appear on the display.
 - To cancel, press any key other than the **PTT** switch.
- 3 Press the **PTT** switch.
 - If programmed by your dealer, no DTMF tone will sound when “D” is transmitted. “D” can be used for a pause duration. The pause duration is programmed by your dealer.

CLEARING STORED DTMF NUMBERS

- 1 Press the microphone # key.
 - “J” appears on the display.
- 2 Press the microphone # key again.
 - “J-LLR” appears on the display.
 - To cancel, press any key other than 1 ~ 9.
- 3 Enter the memory location number (1 ~ 9) you want to clear.
 - The memory location number is cleared and the display returns to normal.

REDIALING

- 1 Press the microphone * key.
 - “R” appears on the display.
- 2 Press the microphone 0 key.
 - The digits last dialed appear on the display.
 - If there is no data in the redial memory, an error tone will sound.
 - To cancel, press any key other than the **PTT** switch.
- 3 Press the **PTT** switch.

Note: Switching the transceiver power OFF clears the redial memory.

STUN

This function is used when a transceiver is stolen or lost. When the transceiver receives a call containing a stun code, either transmit mode will be disabled, or both receive mode and transmit mode will be disabled. The stun code is cancelled when the transceiver receives a call with a revive code.

QUIET TALK (QT)/ DIGITAL QUIET TALK (DQT)

Your dealer may have programmed QT or DQT signaling on your transceiver channels. A QT tone/ DQT code is a sub-audible tone/code which allows you to ignore (not hear) calls from other parties who are using the same channel.

When a channel is set up with a QT tone or DQT code, squelch will only open when a call containing a matching tone or code is received. Likewise, signals that you transmit will only be heard by parties whose QT/ DQT signaling matches your transceiver.

If a call containing a different tone or code is made on the same channel you are using, squelch will not open and you will not hear the call. This allows you to ignore (not hear) these calls. Although it may seem like you have your own private channel while using QT/ DQT, other parties can still hear your calls if they set up their transceiver with the same tone or code.

OPERATOR SELECTABLE TONE (OST)

You can change the preset encode and decode tones for the selected channel. Up to 40 tones can be pre-programmed by your dealer.

- 1 Select your desired channel.
- 2 Press the key programmed as **Operator Selectable Tone**.
 - "TONE OFF" or the OST name or number appears on the display.
- 3 Press the **<B and C>** keys to select the desired OST name/ number.
- 4 Use the transceiver the same as in a regular call; press the **PTT** switch to transmit and release it to receive.
- 5 To exit OST mode and return to the preset encode and decode tones, press the **S** key.

CODE SQUELCH (ID CODE)

Code Squelch is enabled or disabled by your dealer. This function turns the transceiver squelch OFF only when it receives the DTMF ID code that has been set up in your transceiver. Transceivers that do not transmit the correct code will not be heard. Consequently, you can communicate with a specific party without listening to other parties using the same channel.

Your dealer may also activate Group Call for your transceiver. This is useful when you want to send information to a number of units in a fleet. Ask your dealer for details.

Note: Code Squelch cannot be used on this transceiver if Selective Call {page 18} or DTMF Number Display {page 23} have been programmed.

RECEIVING

When you receive a signal containing the correct ID code, the squelch opens and you will hear the call.

- The 🎵 icon appears on the display and blinks.
- The TX/RX indicator flashes orange.
- To mute the speaker after the squelch opens, press the key programmed as **Monitor**.
- Your dealer can program the transceiver to mute the speaker after a specified time period elapses.
- If Transpond is programmed, an acknowledgment signal is returned to the calling station. Transpond does not function when you are called with a Group code. Transpond can send an alert tone, a transceiver ID code, or autodial memory location number 1 (refer to “STORING DTMF NUMBERS” on page 14).
- If Call Alert is programmed, an alert tone will sound when the correct ID code is received.

TRANSMITTING

- 1 Press and hold the **PTT** switch.
- 2 Enter the ID code of the transceiver you want to call or enter a Group code on the microphone keypad.
- 3 Use the transceiver the same as in a regular call; press the **PTT** switch to transmit and release it to receive.
 - The 🎵 icon appears on the display.
 - When you release the **PTT** switch, the squelch opens. If no signal is received for a pre-determined time, the speaker will mute.
 - Pressing the key programmed as **Monitor** at any time will mute the speaker.

SELECTIVE CALL

Selective Call is enabled or disabled by your dealer. This function is similar to Code Squelch {page 17}. The differences from Code Squelch are:

- You can send or receive Status codes containing up to 5 digits.
- Selective Call opens the squelch only when the transceiver receives a predetermined DTMF code in the correct sequence (3-digit or 4-digit ID code — 1-digit Intermediate code — Status code of up to 5 digits).

Your dealer may also activate Group Call for your transceiver. This is useful when you want to send information to a number of units in a fleet. Ask your dealer for details.

Note: Selective Call cannot be used on this transceiver if Code Squelch {page 17} or DTMF Number Display {page 23} have been programmed.

RECEIVING

When you receive the correct ID and Intermediate codes, the squelch opens and you will hear the call. If a Status code is also received, the code will appear on the display. For example, if the Status code “12345” was received, “*[12345*” appears on the display. (“*[*” appears in place of “*[*” for group calls.)

- The  icon appears on the display and blinks.
- When no Status code is received “*NO DATA*” appears on the display.
- You can clear the Status code by pressing any key or returning the microphone to its hook.
- To mute the speaker after squelch opens, press the key programmed as **Monitor**.
- Your dealer can program the transceiver to mute the speaker after a specified time period elapses.
- If Transpond is programmed, an acknowledgment signal is returned to the calling station. Transpond does not function when you are called with a Group code. Transpond can send an alert tone, a transceiver ID code, or autodial memory location number 1 (refer to “STORING DTMF NUMBERS” on page 14).
- If Call Alert is programmed, an alert tone will sound when the correct code is received.

TRANSMITTING

- 1 Press and hold the **PTT** switch.
- 2 Enter the ID code (or Group code) and Intermediate code of the transceiver you want to call on the microphone keypad.
 - If desired, you can also enter a Status code of up to 5 digits.
 - You can send codes the same way you make DTMF calls {page 14}.
- 3 Use the transceiver the same as in a regular call; press the **PTT** switch to transmit and release it to receive.
 - The  icon appears on the display.
 - When you release the **PTT** switch, the squelch opens. If no signal is received for a pre-determined time, the speaker will mute.
 - Pressing the key programmed as **Monitor** at any time will mute the speaker.

2-TONE SIGNALING

2-tone Signaling is enabled or disabled by your dealer. This function opens the squelch only when the transceiver receives the 2 tones corresponding to the 2-tone code set up on your transceiver. Transceivers that do not transmit the correct tones will not be heard.

RECEIVING

When you receive a signal containing the correct code, the squelch opens and you will hear the call.

- The 🎵 icon appears on the display and blinks.
- To mute the speaker after the squelch opens, press the key programmed as **Monitor**.
- Your dealer can program the transceiver to mute the speaker after a specified time period elapses.
- If Transpond is programmed, an acknowledgment signal is returned to the calling station. Transpond does not function when you are called with a Group code. Transpond can send an alert tone.
- If Call Alert is programmed, an alert tone will sound when the correct 2-tone code is received.

TRANSMITTING

- 1 Press the key programmed as **2-tone Encode** to enter 2-tone Encode Select mode.
- 2 Press the **<B and C>** keys to select your desired 2-tone Encode code.
 - Your dealer can program up to 10 different 2-tone codes on your transceiver.
- 3 Use the transceiver the same as in a regular call; press the **PTT** switch to transmit and release it to receive.
 - The 🎵 icon appears on the display.
 - When you release the **PTT** switch, the squelch opens. If no signal is received for a pre-determined time, the speaker will mute.
 - Pressing the key programmed as **Monitor** at any time will mute the speaker.

FleetSync: ALPHANUMERIC 2-WAY PAGING FUNCTION

FleetSync is an Alphanumeric 2-way Paging Function and is a protocol owned by **KENWOOD** Corporation. FleetSync enables a variety of paging functions on your transceiver, some of which depend on dealer programming.

GPS REPORT

If a GPS unit (NMEA-0183 format) is installed on your transceiver and the Send GPS function has been programmed onto a key by your dealer, press the **Send GPS** key to send your location data.

SELCALL (SELECTIVE CALLING)

A Selcall is a voice call to a particular station or to a group of stations.

■ Transmitting

- 1 Select your desired zone and channel.
- 2 Press the key programmed as **Selcall** or **Selcall + Status** to enter Selcall mode.
- 3 Enter the ID of the station you want to call using the microphone keypad.
- 4 Press the **PTT** switch and begin your conversation.

■ Receiving

An alert tone will sound, the transceiver will automatically enter Selcall Mode, and the calling station's ID will appear when a Selcall is received.

To respond to the call, press the **PTT** switch and speak into the microphone.

■ Identification Codes

An ID code is a combination of a 3-digit Fleet number and a 4-digit ID number. Each transceiver must have its own Fleet and ID number.

- Enter a Fleet number (100 ~ 349) to make a group call.
- Enter an ID number (1000 ~ 4999) to make an individual call in your fleet.
- Enter a Fleet number to make a call to all units in the selected fleet (Interfleet call).
- Enter an ID number to make a call to the selected ID in all fleets (Supervisor call).
- Select "ALL" Fleet and "ALL" ID to make a call to all units (Broadcast call).

Note: The ID range may be limited by programming.

STATUS MESSAGE

You can send and receive 2-digit Status messages which may be decided in your talk group. Messages can contain up to 16 alphanumeric characters. Status messages range from 10 to 99 (80 ~ 99 are reserved for special messages).

A maximum of 5 received messages can be stored in the stack memory of your transceiver. These saved messages can be reviewed after reception. Depending on your dealer settings, when the stack memory is full, either the oldest message will be erased when a new message is received or the new message will not be stored in the stack memory. The  icon lights when a message is stored in the stack memory.

■ Transmitting

- 1 Select your desired zone and channel.
- 2 Press the key programmed as **Status** to enter Status mode or **Selcall + Status** to enter Selcall mode.
 - When using the **Status** key to enter Status mode, the station ID is fixed and cannot be selected. Skip to step 5 to continue.
- 3 In Selcall mode, enter the ID of the station you want to call using the microphone keypad.
- 4 Press the **S** key to enter Status Mode.
- 5 Enter the status ID you want to transmit using the microphone keypad.
- 6 Press the **PTT** switch to initiate the Status call.

■ Receiving

The  icon will flash and a calling ID or text message will appear when a Status call is received.

Press any key to return to normal operation.

■ Reviewing Messages in the Stack Memory

- 1 Press and hold the key programmed as **Selcall**, **Status**, or **Selcall + Status** for 1 second to enter Stack mode.
 - The last received message is displayed with the message number.
- 2 Press the **<B** and **C>** keys to select your desired message.
- 3 Press the **S** key to return to normal operation.
 - To delete the selected message, press the **A** or **#** key. To confirm the deletion, press the **S** or ***** key.
 - To delete all messages, press and hold the **A** or **#** key for 1 second. To confirm the deletion, press the **S** or ***** key.

EMERGENCY OPERATION

If your transceiver has been programmed with the Emergency function, you can make emergency calls.

- 1 Press and hold the key programmed as **Emergency**.
 - Depending on the delay time programmed into your transceiver, the length of time you must hold the **Emergency** key will vary.
 - When the transceiver enters Emergency mode, the transceiver will change to the Emergency channel and begin transmitting based on how the transceiver is set up by your dealer. Transmit periods are also set by your dealer.
- 2 To exit Emergency mode, press and hold the **Emergency** key again.
 - If the Emergency mode completes the preset number of cycles, Emergency mode will automatically end and the transceiver will return to the channel that was in use before Emergency mode was entered.

Note:

- ◆ Your dealer can set the transceiver to emit a tone when Emergency mode starts and stops
 - ◆ Your dealer can set the transceiver to emit tones and received signals as normal or mute the speaker during Emergency operation.
-

ADVANCED OPERATIONS

TALK AROUND

You may occasionally experience an interruption in service (due to a power failure, etc.). During such an occurrence, you can continue communication by using the Talk Around feature if it has been programmed by your dealer. Talk Around allows you to communicate directly with other transceivers without the use of a repeater. However, if the station you want to contact is too far away, or there are geographical obstacles in the way, you may not be able to contact the station.

Press the key programmed as **Talk Around** to activate the Talk Around function.

- The  icon appears on the display while the Talk Around function is ON.
- When using Talk Around, the receive frequency is used for both transmission and reception, and the decode signalling is used for both encoding and decoding.

Press the **Talk Around** key again to deactivate the Talk Around function.

DTMF NUMBER DISPLAY

Note: This feature can only be activated when DTMF Signalling is turned OFF.

When you receive a DTMF code containing at least 3 digits, it will appear on the display. Each successive digit will continue to scroll across the display, as long as each digit is received within 1 second of the previous digit. If no digit is received for more than 1 second, then a new digit is received, the display will clear and begin with the new digit.

- The transceiver can display a maximum of 8 digits at a time.

Cancel the DTMF Number Display by pressing any key other than the **Volume Up** and **Volume Down** keys (^ / v).

You can transmit DTMF codes by entering them into an optional microphone with a DTMF keypad.

HORN ALERT

Horn Alert is a useful feature that will notify you of a received call while you are away from your vehicle. The transceiver is programmed to sound the vehicle horn or activate some other external alert device (such as the vehicle headlights) when a call is received that has correct signaling.

Press the key programmed as **Horn Alert** to activate the Horn Alert function.

- The  icon appears on the display while the Horn Alert function is active.

Press the **Horn Alert** key again to deactivate the Horn Alert function.

PUBLIC ADDRESS (PA) SYSTEM

To use the Public Address system, your dealer must install an optional KAP-2 unit and an external speaker. This function causes all audio input via the microphone to be amplified and output from the external speaker.

To use the PA system:

- 1 Press the key programmed as **Public Address**.
 - The  icon appears on the display while the PA system is active.
- 2 Press the microphone **PTT** switch, then speak into the microphone.
 - Use the **Volume Up** and **Volume Down** keys to adjust the audio output from the external speaker.
- 3 Press the **Public Address** key again to return to normal operation.

Note: While the PA system is in use, you cannot transmit to other transceivers.

MONITOR

Press the key programmed as **Monitor** to turn the transceiver signaling OFF. While signaling is OFF, you can hear all signals received on your current channel. With signaling ON, you can hear only signals that match the signaling programmed in your transceiver. Press the **Monitor** key again to return to normal operation.

- The  icon appears on the display while Monitor is activated.

■ Squelch Level

If a key has been programmed as Squelch Level, you can readjust your transceiver's squelch level:

- 1 Press the key programmed as **Squelch Level**.
 - The  icon and the current squelch level appears on the display.
- 2 Press the **<B** and **C>** keys to select the desired squelch level.
- 3 Press the **S** or **▲** key to store the new setting and exit Squelch Level Adjustment mode.

VOICE SCRAMBLER

Note: There are 2 options for using the scrambler. Your dealer can activate or deactivate the built-in scrambler function of the transceiver, or they can add a more secure optional scrambler board to your transceiver. Ask your dealer for details.

Although the built-in scrambler function does not offer complete privacy with your calls, it does prevent others from easily listening in on your calls. When activated, the transceiver distorts your voice so that anybody listening to your conversation will not be able to clearly hear what you are saying.

In order for members of your own group to clearly hear your call while you are using the scrambler, all other members must also activate the scrambler functions on their transceivers. This distorts everybody's voice while transmitting and corrects the voice message on your own transceiver when you receive the call.

Press the key programmed as **Scrambler** to activate the Scrambler.

- The  icon appears on the display while the scrambler is active.

Press the **Scrambler** key again to deactivate the Scrambler.

On the optional scrambler board, you can change the scrambler code set up on your transceiver using the **Scrambler** key:

- 1 Press and hold the key programmed as **Scrambler** for 2 seconds.
 - The current scrambler code appears on the display.
- 2 Press the **<B and C>** keys to select the desired scrambler code.
- 3 Press the **Scrambler** or **▲** key to store the new setting and exit Scrambler Code Select mode.
 - After changing your scrambler code, be sure to inform all members of your group of the new code so they can reset their transceivers as well. The scrambler function will not perform correctly between transceivers that are set up with different scrambler codes.

KEY LOCK

Press the key programmed as **Key Lock** to lock the keys of the transceiver. Locking the transceiver keys prevents you from accidentally changing the channel and channel settings.

While Key Lock is active, you can still use the microphone **PTT** switch, the **⏻** (power) switch, and the **Emergency**, **Monitor**, and **Squelch Off** keys. If set up by your dealer, you can also use the **Volume Up** and **Volume Down** keys (**^ / v**).

- "LOCKED" momentarily appears on the display when the Key Lock function is activated or when a key is pressed while the Key Lock function is ON.

Press the **Key Lock** key again to turn this function OFF.

BACKGROUND OPERATIONS

TIME-OUT TIMER (TOT)

The purpose of the Time-out Timer is to prevent any caller from using a channel for an extended period of time. If you continuously transmit for a period of time that exceeds the programmed time, the transceiver will stop transmitting and an alert tone will sound. To stop the tone, release the **PTT** switch.

The default TOT duration is 1 minute. Your dealer can set the duration to last from 15 seconds to 20 minutes.

Your dealer can also program a warning function to alert you before the TOT expires. Continuously transmitting for the time specified by your dealer will cause this warning tone to sound, allowing you to finish your transmission before the TOT expires.

BUSY CHANNEL LOCKOUT (BCL)

The Busy Channel Lockout feature is activated or deactivated by your dealer.

When activated, BCL prevents you from interfering with other parties who may be using the same channel that you selected. Pressing the **PTT** switch while the channel is in use will cause your transceiver to emit an alert tone and transmission will be inhibited (you cannot transmit). Release the **PTT** switch to stop the tone and return to receive mode.

BEGINNING/ END OF TRANSMIT SIGNAL

Your dealer can enable or disable the Beginning/ End of Transmit identification signals. These signals are used to access and release some repeaters and telephone systems.

A Beginning of Transmit (BoT) Signal is sent when you press the **PTT** switch.

An End of Transmit Signal (EoT) is sent when you release the **PTT** switch.

KENWOOD

MANDATORY SAFETY INSTRUCTIONS TO INSTALLERS AND USERS

- Use only manufacturer or dealer supplied antenna.
- **Antenna Minimum Safe Distance: 120 cm (4 feet), 50% duty Cycle.**
- Antenna Gain: **0** dBd referenced to a dipole.

The Federal Communications Commission has adopted a safety standard for human exposure to RF (Radio Frequency) energy which is below the OSHA (Occupational Safety and Health Act) limits.

- **Antenna Mounting:** The antenna supplied by the manufacturer or radio dealer must not be mounted at a location such that during radio transmission, any person or persons can come closer than the above indicated minimum safe distance to the antenna, i.e. **120 cm (4 feet), 50% duty Cycle.**
- To comply with current FCC RF Exposure limits, the antenna must be installed at or exceeding the minimum safe distance shown above, and in accordance with the requirements of the antenna manufacturer or supplier.
- Vehicle installation: The antenna can be mounted at the center of a vehicle metal roof or trunk lid, if the minimum safe distance is observed.
- Base Station Installation: The antenna should be fixed-mounted on an outdoor permanent structure. RF Exposure compliance must be addressed at the time of installation.

Antenna substitution: Do not substitute any antenna for the one supplied or recommended by the manufacturer or radio dealer.

You may be exposing person or persons to excess radio frequency radiation. You may contact your radio dealer or the manufacturer for further instructions.

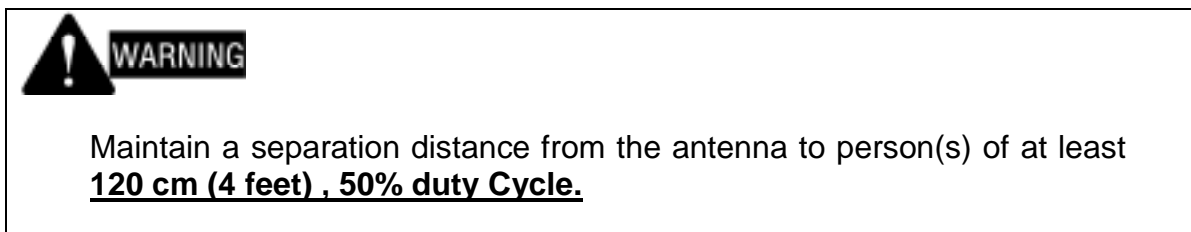

“This transmitter is authorized to operate with a maximum duty factor of 50%, in typical push-to-talk mode, for satisfying FCC RF exposure compliance requirements.”

You, as the qualified end-user of this radio device must control the exposure conditions of bystanders to ensure the minimum separation distance (above) is maintained between the antenna and nearby persons for satisfying RF Exposure compliance. The operation of this transmitter must satisfy the requirements of Occupational/Controlled Exposure Environment, for work-related use, transmit only when person(s) are at least the minimum distance from the properly installed, externally mounted antenna. Transmit only when people outside the vehicle are at least the recommended minimum lateral distance away from the antenna/vehicle