

KENWOOD

KTI-5

NETWORK BOX
INSTRUCTION MANUAL

MODULE RÉSEAU
MODE D'EMPLOI

UNIDAD DE RED
MANUAL DE INSTRUCCIONES

INTERFACCIA IP NETWORK
MANUALE DI ISTRUZIONI

NETZWERK INTERFACE
BEDIENUNGSANLEITUNG

NETWERK EENHEID
GEBRUIKSAANWIJZING

NETWORK BOX
KULLANIM KILAVUZU

JVCKENWOOD Corporation

B5A-0555-00 (M)

One or more of the following statements may be applicable:

FCC WARNING

This equipment generates or uses radio frequency energy. Changes or modifications to this equipment may cause harmful interference unless the modifications are expressly approved by the party responsible/JVC KENWOOD. The user could lose the authority to operate this equipment if an unauthorized change or modification is made.

INFORMATION TO THE DIGITAL DEVICE USER REQUIRED BY THE FCC

This equipment has been tested and found to comply with the limits for a Class B digital device, pursuant to Part 15 of the FCC Rules. These limits are designed to provide reasonable protection against harmful interference in a residential installation.

This equipment generates, uses and can generate radio frequency energy and, if not installed and used in accordance with the instructions, may cause harmful interference to radio communications. However, there is no guarantee that the interference will not occur in a particular installation. If this equipment does cause harmful interference to radio or television reception, which can be determined by turning the equipment off and on, the user is encouraged to try to correct the interference by one or more of the following measures:

- Reorient or relocate the receiving antenna.
- Increase the separation between the equipment and receiver.
- Connect the equipment to an outlet on a circuit different from that to which the receiver is connected.



Authorized Representative in Europe:

JVCKENWOOD Nederland B.V.
Amsterdamseweg 37, 1422 AC Uithoorn, The Netherlands

Manufacturer:

JVCKENWOOD Corporation
1-16-2 Hakusan, Midori-ku, Yokohama-shi, Kanagawa,
226-8525 Japan

THANK YOU

We are grateful you chosen **KENWOOD** network box.

WARNING

- Do not install the unit in explosive atmospheres (inflammable gas, dust particles, metallic powders, grain powders, etc.).

PRECAUTIONS

- This unit operates in 13.6 V negative ground systems only!. Check voltage of DC power supply before installing the unit.
- Do not expose the unit to rain or moisture; to prevent fire or electric shock.
- Do not open the unit under any circumstances; to avoid risk of electric shock.
- Do not expose the unit to long periods of direct sunlight, nor place it close to heating appliances.
- Do not place the unit in excessively dusty and/or humid areas, nor on unstable surfaces.
- If you detect an abnormal odor or smoke coming from the unit, disconnect the power from the unit immediately. Contact your **KENWOOD** service center or dealer.

Information on Disposal of Old Electrical and Electronic Equipment (applicable for countries that have adopted separate waste collection systems)



Products with the symbol (crossed-out wheeled bin) cannot be disposed as household waste.

Old electrical and electronic equipment should be recycled at a facility capable of handling these items and their waste byproducts. Contact your local authority for details in locating a recycle facility nearest to you.

Proper recycling and waste disposal will help conserve resources whilst preventing detrimental effects on our health and the environment.

UNPACKING AND CHECKING EQUIPMENT

Note: The following unpacking information is for use by your **KENWOOD** dealer, an authorized **KENWOOD** service center, or the factory.

Carefully unpack the unit. We recommend that you identify the items listed in the following table before discarding the packing material. If any items are missing or have been damaged during shipment, file a claim with the carrier immediately.

Item	Part Number	Quantity
N SYNC Cable	E30-7717-XX	1
Cushion	G1D-0077-XX	2
Cushion	G13-2339-XX	4
Instruction Manual	B5A-0555-XX	1

INSTALLATION & CONNECTION

Note: Please consult your dealer for installing the KTI-5 and repeater.

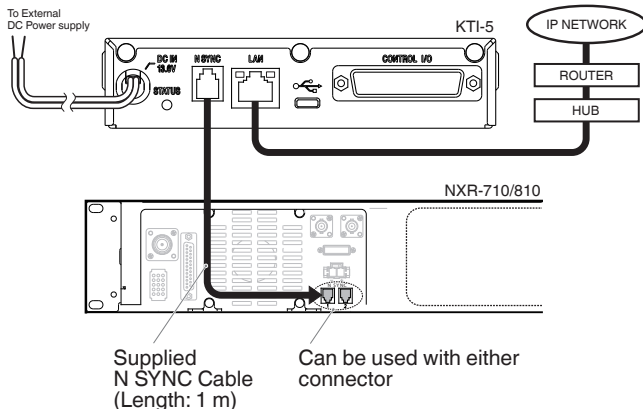

Attach the KT1-5 to the repeater Accessory Cabinet using the supplied cushion.

1. Attach 4 cushions on the 4 base corners of the KT1-5, and place it into the Accessory Cabinet.
2. Attach the cushion to the base of the KT1-5, and attach it to the Accessory Cabinet.

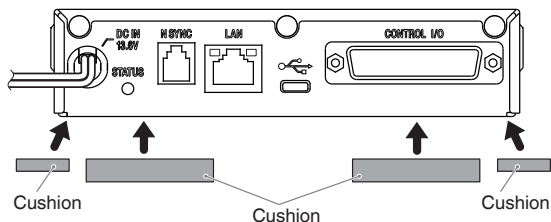

ORIENTATION

Rear Panel

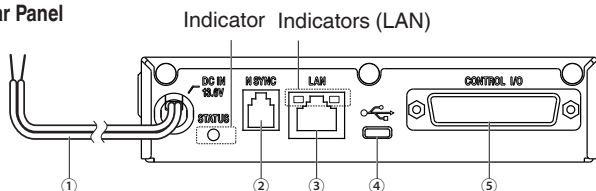

- ① **DC Power supply connector cable (Length: 2 m)**
Connect to an external DC power supply.
- ② **N SYNC jack**
Connect to Repeater.
- ③ **LAN jack**
Connect to Ethernet. Use a shielded, Category 5e or higher standard LAN cable shorter than 3 meters.
- ④ **micro USB connector**
This connector is currently not used.
- ⑤ **CONTROL I/O connector**
This connector is currently not used.

Indicators

Indicator	Color	Meaning
STATUS	Green	Lights while the power is ON.
	Green/ Red/ Yellow/ Blue/ Purple	Indicates status condition.
LAN : Right (100Mbps)	Green	Lights when in 100Base-TX mode.
LAN : Left (Link)	Green	Lights when link effective. Blinks when carrier sense operation.

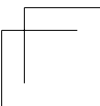
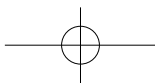
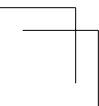
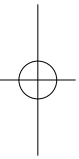
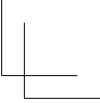
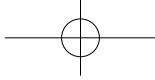
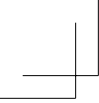



KENWOOD

© 2015 JVC KENWOOD Corporation

