

15 NETWORK/KNS OPERATION

LAN

Configure the LAN settings if the clock is to be corrected by connecting this transceiver to the NTP server. Establish a LAN connection from this transceiver using an Ethernet (LAN) cable (straight type).

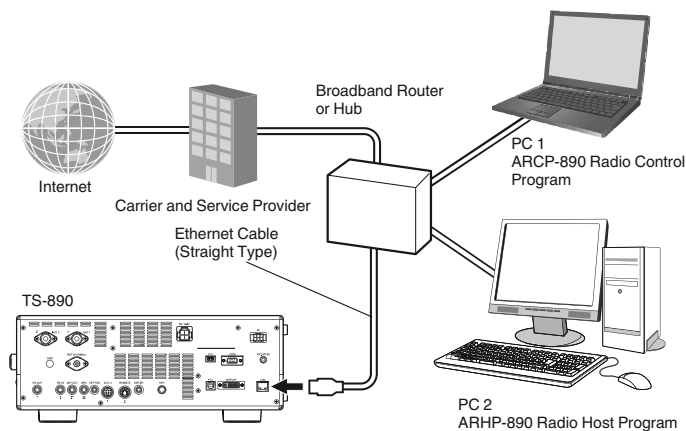

When operating this transceiver via the KNS (Kenwood Network Command System), configure the IP address, administrator ID and password. For operations using KNS, please refer to “KNS Operation”.

To access this transceiver through access via the network, log in with the preconfigured ID and password.

Configuring the IP Address

DHCP, which is the abbreviation for Dynamic Host Configuration Protocol, is a means for acquiring network information (IP address, DNS server, gateway, etc.) from the DHCP server. Besides acquiring the IP address manually, this DHCP can also be used to configure the IP address.

Configuring the IP Address Automatically (Using DHCP)

- 1 Press F [LAN] on the menu screen to display the LAN menu item list screen.
- 2 Press F2 [▲], F3 [▼] or turn the [MULTI/CH] control to select LAN Menu [0] “DHCP”.
- 3 Press F4 [SELECT].



- 4 Press F2 [-]/ F3 [+] to select “On”.
The default setting is “On”.
- 5 Press F1 [↵].

Configuring the IP Address Manually (Without Using DHCP)

- 1 Select LAN Menu [0] “DHCP”.
- 2 Press F4 [SELECT].
- 3 Press F2 [-]/ F3 [+] to select “Off”.



- 4 Press F1 [↵].
- 5 Press F2 [▲] / F3 [▼] to select LAN Menu [1] “IP Address”.
- 6 Press F4 [EDIT].
- 7 Press F4[◀|||]/ F5[|||▶] to select an address block (set of 3 digits) to input.
- 8 Press F2 [-], F3 [+] or a key on the numeric keypad, or turn the [MULTI/CH] control to increase or decrease the 3-digit value of the address block.
- 9 Press F4[◀|||]/ F5[|||▶] to select the next 3 digits.
Repeat steps 8 to 9 to configure the IP address.
- 10 Press F6 [OK].
- 11 Press F2 [▲] / F3 [▼] to select LAN Menu [2] “Subnet Mask”.
Repeat steps 3 to 10 to configure the subnet mask ([2]). Follow the same steps to configure default gateway ([3]), primary DNS server ([4]) and secondary DNS server ([5]).

Description	Setting Range	Default
DHCP	Off/ On	On
IP Address	1.0.0.0 to 223.255.255.255	192.168.1.100
Subnet Mask	0.0.0.0 to 255.255.255.252	255.255.255.0
Default Gateway	1.0.0.0 to 223.255.255.255	Blank
Primary DNS Server	1.0.0.0 to 223.255.255.255	Blank
Secondary DNS Server	1.0.0.0 to 223.255.255.255	Blank



- This transceiver does not support IPv6.
- This transceiver supports ping and other ICMP responses.
- The Ethernet standard used on this transceiver is 100BASE-TX. Use a commercially available cable that is Category 5 (Cat5) or higher.
- When connecting to a hub or broadband router, make use of a commercially available straight cable.
- Turn off the power of this transceiver and the device to connect to before connecting the cable.
- Even when the IP address is acquired automatically, IP address cannot be configured in an environment where a DHCP server is not used.
- When the IP address is acquired automatically, the IP address, subnet mask, default gateway, primary DNS server and secondary DNS server are grayed out and a parameter cannot be input.
- When an IP address is automatically acquired and configured for this transceiver, the configured IP address is displayed in the IP address setting.
- Setting DHCP to ON updates the parameter. If an address is not acquired, the address field will remain blank.
- The address may not be acquired immediately after DHCP is set to ON.
- Even when the IP address is configured while DHCP is OFF, this IP address will be displayed when DHCP is set to ON.

Viewing the MAC Address

The MAC address of this transceiver which is necessary for its operation via LAN can be identified in this menu item.

● Check LAN Menu [6] "MAC Address".

The MAC address of this transceiver can be identified here. This menu item is intended for viewing only, and the setting in LAN Menu [6] "MAC Address" cannot be altered.

KNS Operation

KNS (Kenwood Network Command System) is a collective term that refers to the system for remotely operating a Kenwood transceiver via the network such as the Internet or LAN. Operation using this system is referred to as "KNS operation".



- Details on the operation method of KNS are described in "KENWOOD NETWORK COMMAND SYSTEM TS-890S Remote Operation System", which can be downloaded from the URL below.
http://www.kenwood.com/i/products/info/amateur/software_download.html
- This manual describes only the explanation on the areas of configuration. For details on specific configurations, please refer to "KENWOOD NETWORK COMMAND SYSTEM Setting Manual".

System Configuration Overview

Basic Configuration for Remote Operation through the Internet

To operate the TS-890S remotely through the Internet using KNS, configure the system as shown in Figure 1.

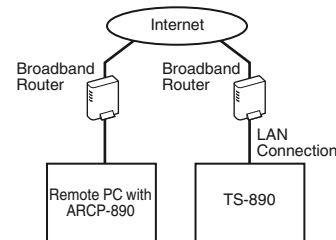

Figure 1: Basic System Configuration

Under this configuration, the TS-890S performs login authentication of the remote user (administrator and registered user) operating the ARCP-890, followed by control command communication after authentication is complete. Voice communication is carried out by the TS-890S and ARCP-890 via the built-in VoIP.



- Administrator refers to the owner of or person in charge of managing the transceiver. Registered user refers to a user other than the administrator who is authorized to operate this transceiver remotely via KNS. A registered user needs to be registered in advance by the administrator to the KNS users list in the TS-890S.

Configuration when Using ARVP-10 or a Non-Kenwood VoIP for Voice Communication

When using ARVP-10 or a non-Kenwood VoIP application software program for voice communication, configure the system as shown in Figure 2.

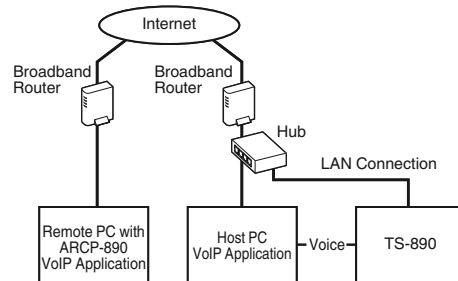

Figure 2: System Configuration when Using a Non-Kenwood VoIP Application

Under this configuration, voice communication between the remote PC and host PC is carried out using the ARVP-10 or a non-Kenwood VoIP application software.

Voice communication between the host PC and the TS-890S is carried out using the USB audio function (via USB cable connection) or by extracting analog audio output signal (ANO) and analog audio input signal (ANI) from the ACC 2 connector, followed by connecting to the audio input/output connector of the PC sound card. The configuration of components other than that for voice communication are the same as the basic configuration.

Configuration Using ARHP-890

To manage remote users and perform login authentication using ARHP-890 as with the TS-990 and TS-590 series, configure the system as shown in Figure 3.

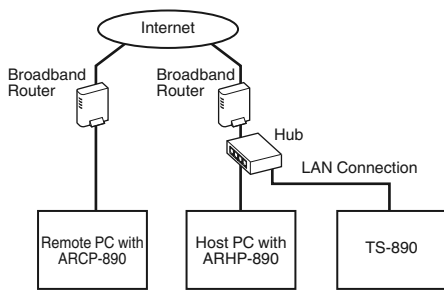

Figure 3: System Configuration for Remote User Management and Login Authentication via ARHP

Under this configuration, the registered users list is managed by the ARHP-890. ARHP-890 performs login authentication of the remote user, while at the same time logs in to the TS-890S as an administrator. After logging in, command communication and voice communication between the TS-890S and ARCP-890 are relayed.

- The built-in VoIP of TS-890 is used for voice communication (ARVP-10 or a non-Kenwood VoIP can also be used for voice communication).



- It is necessary to configure the settings to transmit incoming control commands and VoIP data via Internet from the broadband router to each device. Please refer to the "KENWOOD NETWORK COMMAND SYSTEM Setting Manual".

Configuration for KNS Operation in a Home LAN Environment

To operate the TS-890S remotely in a home LAN environment, configure the system as shown in Figure 4.

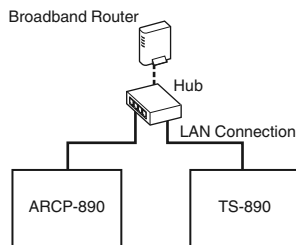

Figure 4: KNS System Configuration in a Home LAN Environment

Under this configuration, ARCP-890 logs in to the TS-890S as an administrator (login as a registered user is also possible).

- The built-in VoIP of TS-890 is used for voice communication. It is also possible to make use of the USB audio function by connecting a USB cable (ARUA-10 is needed).
- Another alternative option is to extract analog audio output signal (ANO) and analog audio input signal (ANI) from the ACC 2 connector and connect to the audio input/output connector of the PC sound card.

Configuring for KNS Operation

LAN Connection Settings

Follow the steps below to configure the LAN connection environment for KNS operation.

- 1 Press F [KNS] on the menu screen.**
The KNS status screen for confirming the settings is displayed.
- 2 Press F4 [CONFIG].**
The KNS configuration screen appears.



3 Press F2 [▲] / F3 [▼] to select KNS Menu [0] "KNS Operation (LAN Connector)".

4 Press F4 [SELECT].

5 Press F2 [-] / F3 [+] to select the setting.

Setting Value	Off (default)/ On (LAN)/ On (Internet)
---------------	--

On (LAN): When operating KNS in a home LAN environment.

On (Internet): When operating KNS via the Internet.

- Pressing **F[KNS TOP]** returns the display to the KNS status screen.



- The KNS Operation cannot be changed to a value other than "Off" without first configuring the administrator settings

Administrator Settings

Administrator refers to the owner of the transceiver (manager of the transceiver in the case of a club station).

- To connect the transceiver to LAN and perform remote operation from a PC via LAN, login authentication is needed. An administrator ID and password are configured for the transceiver in advance by the administrator, which are then used to log in to the transceiver from ARCP-890.
- Upon logging in with the administrator ID, the KNS menu can be operated from ARCP-890.

1 Select KNS Menu [1] "Administrator ID" and KNS Menu [2] "Administrator Password".

2 Press F4[EDIT].

3 Use the function keys, [MULTI/CH] control or USB keyboard to enter a character string.

Key	Behavior
F1 [SPACE]	Inserts a space.
F2 [-] / F3 [+]	Selects a character.
F4 [◀] / F5 [▶]	Moves the cursor.
F [BACK SPACE]	Deletes the character to the left of the cursor.
F [DEL]	Deletes the character to the right of the cursor.
F [CHAR]	Switches the type of character to edit. Pressing the key each time switches the selection in the following sequence: ABC (upper case) → !"# (symbols) → ABC (upper case)

4 Press F6 [SAVE] to save the administrator ID and password.

- Each of the ID and password must not be longer than 32 characters.



- When the KNS Operation is ON, the KNS "Administrator ID" and "Administrator Password" cannot be edited or reset.

15 NETWORK/KNS OPERATION

Built-in VoIP Function

Follow the steps below to configure whether to use the built-in VoIP function for voice communication between the remote PC and transceiver during KNS operation.

Set this function to ON (default setting) to use the built-in VoIP function for voice communication between the remote PC and transceiver. Set this function to OFF when using ARVP-10 or a non-Kenwood VoIP software program.

- 1 Select KNS Menu [3] “Built-in VoIP”.
- 2 Press F4 [SELECT].
- 3 Press F2 [-]/ F3 [+] to select “On” or “Off”.

Setting Value	Off/ On (default)
---------------	-------------------



- When the setting is changed while a connection is established (logged in), the new setting will be applied at the next connection.
- When using the built-in VoIP, check the following settings as well. For more details, please refer to the “KENWOOD NETWORK COMMAND SYSTEM Setting Manual”.
 - Check that the TX operation setting in the modulation line selection for ARCP-890 matches the audio input of the modulation line configured on this transceiver.
 - Check that audio input of the modulation line configured on this transceiver in the “Switching the Audio Source Input” section matches the TX operation setting selected in the modulation line selection for ARCP-890.

Audio Input/Output Level of Built-in VoIP

The audio input and output level when using the VoIP can be adjusted as follows. Use the default setting under normal circumstances.

- 1 Select KNS Menu [4] “Audio Input Level (VoIP)” and KNS Menu [5] “Audio Output Level (VoIP)”.
- 2 Press F4 [SELECT].
- 3 Press F2 [-]/ F3 [+] to select the level.

Setting Value	0 to 50 (default: Menu 4) to 100 (default: Menu 5) (1 step)
---------------	---

Built-in VoIP Jitter Absorption Buffer

Follow the steps below to configure the duration of the jitter absorption buffer of the VoIP. When there is jitter in the audio due to delay in packet forwarding, configure the jitter absorption buffer to a longer duration.

- 1 Select KNS Menu [6] “VoIP Jitter Buffer”.
- 2 Press F4 [SELECT].
- 3 Press F2 [-]/ F3 [+] to select a jitter absorption time.

Setting Value	200 (default)/ 500/ 800 [ms]
---------------	------------------------------



- When the setting is changed while the built-in VoIP is in use, the new setting will be applied the next time VoIP is used.

Prohibition of Remote Volume Control

Adjustment of the volume via remote operation can be prohibited to prevent a loud sound from being accidentally output from the transceiver.

This function is used when the volume at the location where the transceiver is installed is a matter of concern.

- 1 Select KNS Menu [7] “Prohibit AF Gain Control”.
- 2 Press F4 [SELECT].
- 3 Press F2 [-]/ F3 [+] to select “On” or “Off”.

Setting Value	Off (default)/ On
---------------	-------------------

KNS Communication Log

Logs recording communication with remote station during KNS operation can be recorded to a file.

- 1 Select KNS Menu [8] “Access Log”.
- 2 Press F4 [SELECT].
- 3 Press F2 [-]/ F3 [+] to select “On”.
 - When a USB flash drive is selected as the destination for storing the file, create a communication log file in the “\KENWOOD\TS-890\KNS_LOG” folder and record the logs to this file.
 - When the built-in memory is selected as the destination, the communication log file is saved to “KNS_LOG” in the built-in memory.
 - The log file is named kns_log.csv.
 - It is possible to switch the destination for storing the communication log files from the built-in memory to “\KENWOOD\TS-890\KNS_LOG” in the USB flash drive. (Please refer to “Destination for Saving Files”)
 - If writing of the KNS communication log failed due to insufficient memory (including the case where the destination for writing data to is the USB flash drive and the USB flash drive is not recognized), a message indicating that writing has failed appears on the KNS information screen.

KNS User Registration

Follow the steps below to register a new KNS user.

KNS Users List

This is a list of the registered users.

- 1 Press F [KNS] on the menu screen to display the KNS status screen.
- 2 Press F7 [U.LIST] to display the KNS Users List screen.



Registering User Information

- 1 Press F6 [ADD] to display the user registration screen.



- 2 Press F2[▲] / F3[▼] to select the item to register.
- 3 Press F4 [EDIT].
 - For the “User Name”, “Password” and “Description” fields, use the function keys, [MULTI/CH] control or USB keyboard to enter a character string.



- 4 After input is complete, press F6[OK].
The edited information is now set.

- Up to 32 characters can be entered for “User Name” and “Password”, and up to 128 characters for “Description”.
- A maximum of 100 users can be registered.
- The “User Name” and “Password” fields must be entered.
- Input of a user name that is already registered is not allowed.
- Both “User Name” and “Password” are case-sensitive.

Key	Behavior
F1 [SPACE]	Inserts a space.
F2 [-] / F3 [+]	Selects a character.
F4 [◀] / F5 [▶]	Moves the cursor.
F [BACK SPACE]	Deletes the character to the left of the cursor.
F [DEL]	Deletes the character to the right of the cursor.
F [CHAR]	Switches the type of character to edit. Pressing the key each time switches the selection in the following sequence: ABC (upper case) → !"# (symbols) → ABC (lower case)

- The “RX Only” and “Disabled” options can be selected or deselected using F4 [☐] [☑].
- 5 Press F6 [SAVE] to complete the registration.
 - Pressing F7 [CANCEL] discards information that is input on the user registration screen and returns the display to the KNS Users List screen.

Editing User Information

- 1 Press F7 [U.LIST] to display the KNS Users List screen.
- 2 Press F2[▲] / F3[▼] to select the user to edit.
- 3 Press F4 [EDIT] to display the user registration screen.
Follow the same steps for registering a new user to edit the user information.

Deleting a User

- 1 Press F7 [U.LIST] to display the KNS Users List screen.
- 2 Press F2[▲] / F3[▼] to select the user to delete.
- 3 Press and hold F5 [(DELETE)].
Information registered for the selected user is deleted, and all users below are shifted upward to replace the deleted row.

 • Information that is altered or deleted will take effect at the next login.

15 NETWORK/KNS OPERATION

Remote Operation by Registered User

A registered user may be authorized by the administrator to remotely operate the transceiver using KNS.

1 Select KNS Menu [9] “Registered Users' Remote Operation”.

2 Press F4 [SELECT].

3 Press F2 [-]/ F3 [+] to select “On” or “Off”.

On: Authorizes login by a registered user. However, this excludes users for which the “Disabled” checkbox is selected in the user information.

Off: Prohibits login by a registered user. Only the administrator is allowed to log in in this setting.

- <<[]>> lights up when a registered user is logged in.
- When someone is already logged in, another remote user (regardless of an administrator or registered user) cannot log in.
- If connection is lost while the transceiver is in the TX mode, the transmission ends automatically.

Session Time

The maximum duration for a registered user to log in and use the transceiver can be configured as follows.

1 Select KNS Menu [10] “Session Time”.

2 Press F4 [SELECT].

3 Press F2 [-]/ F3 [+] to select a time.

Setting Value	1 [min]/ 2 [min]/ 3 [min]/ 5 [min]/ 10 [min]/ 15 [min]/ 20 [min]/ 30 [min]/ 40 [min]/ 50 [min]/ 60 [min]/ 90 [min]/ 120 [min]/ Unlimited (default)
---------------	--



- There is no time restriction when the administrator is logged in.
- The altered settings of the information will take effect at the next login.

KNS Welcome Message

A text message notification for the remote user can be written to the transceiver in advance and displayed on the ARCP-890 used by the remote user.

A text message notification from a remote user to other remote users can be written to the transceiver via remote operation.

1 Select KNS Menu [11] “KNS Welcome Message”.

2 Press F4 [EDIT].

3 Use the function keys, [MULTI/CH] control or USB keyboard to enter a character string.

Key	Behavior
F1 [SPACE]	Inserts a space.
F2 [-]/ F3 [+]	Selects a character.
F4 [◀ / F5 [▶]	Moves the cursor.
F [BACK SPACE]	Deletes the character to the left of the cursor.
F [DEL]	Deletes the character to the right of the cursor.
F [CHAR]	Switches the type of character to edit. Pressing the key each time switches the selection in the following sequence: ABC (upper case) → !"# (symbols) → ABC (upper case)

4 Press F6 [SAVE] to save the message.



- This message can be rewritten by the administrator or a registered user via command access.

16 OTHER FUNCTIONS

Configuring the Power-on Message

A power-on message can be displayed on the screen after the power of this transceiver is turned on and before it starts up. A text message such as the call sign can be configured as the power-on message according to the user's preferences.

● Configure in Menu [0-06] "Power-on Message"

Use the function keys, [MULTI/CH] control or USB keyboard to enter a message.

- Enter a message that contains not more than 15 characters. The default setting is "HELLO".

Key	Behavior
F1 [SPACE]	Inserts a space.
F2 [-]/ F3 [+]	Selects a character.
F4 [◀]/ F5 [▶]	Moves the cursor.
F [BACK SPACE]	Deletes the character to the left of the cursor.
F [DEL]	Deletes the character to the right of the cursor.
F [CHAR]	Switches the type of character to edit. Pressing the key each time switches the selection in the following sequence: ABC (upper case) → abc (lower case) → !"# (symbols) → ABC (upper case)
F6 [SAVE]	Registers the edited characters.

Configuring the Screen Saver

A screen saver is launched automatically if this transceiver is not operated for a duration as configured in the time for activating the screen saver.

This transceiver comes with 3 types of screen savers. Configuring to the Type 2 screen saver allows a manually input text to be displayed on the screen.

Configuring the Screen Saver Type

The type of screen saver to use can be selected as follows.

● Configure in Menu [0-03] "Screen Saver"

Setting Value	Off (default)/ Type 1/ Type 2/ Type 3/ Display Off
---------------	--

Type 1: Displays only an image.

Type 2: Displays both image and text.

Type 3: Displays an image stored in the built-in memory.

- When screen saver is set to "Display Off", the backlight of the screen turns off and output to an external display is also turned off temporarily after a specific period of inactivity.



- The screen saver display can be cleared by operating any key or control or touching the screen of this transceiver.
- If images for used by Type 3 are not saved, the screen saver cannot be displayed even when Type 3 is selected.

Saving Images for Use by Type 3 Screen Saver

Follow the steps below to save the image to display as the Type 3 screen saver from a USB flash drive to the built-in memory of the transceiver.

- Image files that are used as the screen saver must be of the jpg or jpeg extension with a resolution not higher than 20 megapixels (1920 × 1080 pixels).

- 1 Copy the images into the "KENWOOD\TS-890\IMAGE" folder of the USB flash drive using a PC.
- 2 Connect the USB flash drive to this transceiver.

3 Press F [USB /FILE] on the menu screen to display the USB/File Management menu screen.

4 Select "Image Files for Screen Saver (Type 3)".

5 Press F4 [SELECT].

A confirmation screen on the reading of image files is displayed.

- Pressing F7 [CANCEL] returns the display to the USB/File Management menu screen without starting the reading.

6 Press F4 [OK].

The reading of files starts.



- When image files are imported into the built-in memory of the transceiver, all images that were previously imported will be erased. (Please note that if the specified folder of the USB flash drive that is imported is empty, all image files in the built-in memory of the transceiver will be erased.)
- The display sequence during a slideshow follows the sequence of the character codes (ISO-8859-1). For instance, when files are named in running numbers, they will be displayed in the ascending order as follows: 001_aaa.jpg, 002_bbb.jpg, 003_ccc.jpg.



All image data that are imported to the built-in memory of the transceiver will be erased when standard reset or full reset is performed.

Configuring the Time for Launching the Screen Saver

The timing for launching the screen saver after the keys or controls are last operated can be configured on this transceiver.

● Configure in Menu [0-04] "Screen Saver Wait Time"

Setting Value	Preview (5 [sec]) (default)/ 5 [min]/ 15 [min]/ 30 [min]/ 60 [min]
---------------	--

Configuring the Displayed Screen Saver Text

When Type 2 screen saver is selected, a text to be displayed on the screen can be manually input. The input text will be displayed at random positions on the screen when the screen saver is activated.

● Configure in Menu [0-05] "Screen Saver Message"

Use the function keys, [MULTI/CH] control or USB keyboard to enter a message.

- Enter a message that contains not more than 10 characters. The default text is "TS-890".

Key	Behavior
F1 [SPACE]	Inserts a space.
F2 [-]/ F3 [+]	Selects a character.
F4 [◀]/ F5 [▶]	Moves the cursor.
F [BACK SPACE]	Deletes the character to the left of the cursor.
F [DEL]	Deletes the character to the right of the cursor.
F [CHAR]	Switches the type of character to edit. Pressing the key each time switches the selection in the following sequence: ABC (upper case) → abc (lower case) → !"# (symbols) → ABC (upper case)
F6 [SAVE]	Registers the edited characters.

Configuring the Long-press Behavior of Keys

Select the length of the response time when a key is pressed and held down.

● **Configure in Menu [0-13] “Long Press Duration of Panel Keys”**

Setting Value	200 to 500 (default) to 2000 [ms] (100 [ms] step)
---------------	---

Configuring the Beep Volume

A beep tone is output when a key is operated or activated. Selecting “OFF” mutes the beep tone.

● **Configure in Menu [1-00] “Beep Volume”**

Setting Value	Off/ 1 to 10 (default) to 20 (1 step)
---------------	---------------------------------------

PF Keys (Programmable Function Keys)

The PF keys can be assigned with different functions of this transceiver. Assigning frequently-used functions or menus to the PF keys allows these functions or menus to be invoked quickly simply by pressing the corresponding key.

PF keys that can be assigned with frequently-used functions are largely divided into those for access to the menu screens, the front panel keys, and those for access to the memory channels. For more details, please refer to “List of Assignable Functions”. PF keys that can be assigned with a function are as follows.

PF Keys on the Front Panel:

[PF A], [PF B], [PF C]

PF Keys on the Microphone:

MIC [PF 1] to MIC [PF 4], MIC [DWN], MIC [UP]

External PF Keys (Self-made PF Keys by Users):

EXT [PF 1] to EXT [PF 8]

Assigning Functions to PF Keys (Front Panel)

There are 3 keys on the front panel that can be assigned with functions.

- **Configure using one of the menus between [0-15] “PF A: Key Assignment” and [0-17] “PF C: Key Assignment”.**

Assigning Functions to PF Keys (Microphone)

When one of the microphones below or a self-made selector is connected to the MIC connector on the front panel, up to 6 functions can be assigned to the PF keys.

MC-43S: MIC [DWN], MIC [UP]

MC-47: MIC [PF 1] to MIC [PF 4], MIC [DWN], MIC [UP]

MC-60S8: MIC [DWN], MIC [UP]

MC-90: MIC [DWN], MIC [UP]

- **Configure using one of the menus between [0-26] “Microphone PF 1: Key Assignment” and [0-31] “Microphone UP: Key Assignment”.**

- To create a self-made selector, please refer to the circuit diagram below.

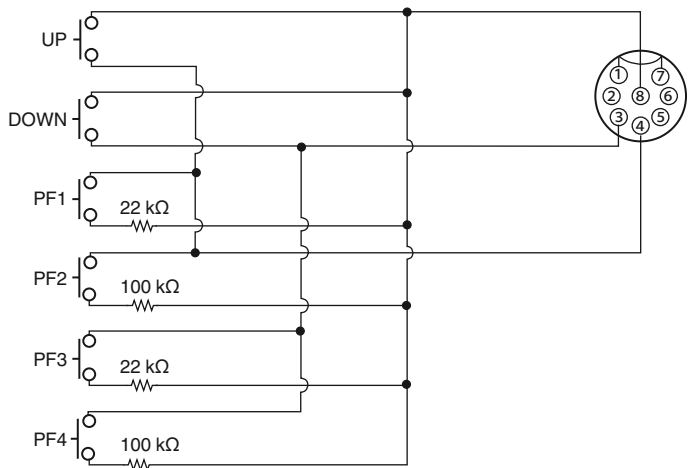

● Production of the MC-47 microphone has been discontinued.

Assigning Functions to the PF Keys (KEYPAD Jack)

The KEYPAD jack on the rear panel can be used to connect a self-made selector.

- **Configure using one of the menus between [0-18] “External PF 1: Key Assignment” and [0-25] “External PF 8: Key Assignment”.**

To create a self-made PF keypad, please refer to the circuit diagram below.

φ3.5 mm plug

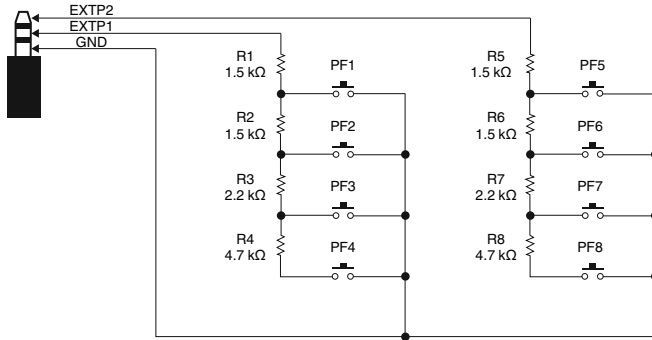

List of Assignable Functions

Parameter	Behavior of Assigned Functions	
MENU 0-00 ⋮ MENU 9-03	Press	Calls up or closes Menu No. 0-0 ⋮ Calls up or closes Menu No. 9-03
ADVANCED MENU 0 ⋮ ADVANCED MENU 27	Press	Calls up or closes Advanced Menu No. 00 ⋮ Calls up or closes Advanced Menu No. 27
A/B, A=B	Press	Switches between VFO A and VFO B
	Press and hold	Combines VFO A and VFO B
AGC	Press	Switches AGC constant to FAST/MID/SLOW
	Press and hold	Starts up or exits the AGC configuration screen
AGC OFF	Press	Switches AGC to ON or OFF
ANT	Press	Switches ANT
APF	Press	Switches audio peak filter to ON or OFF
	Press and hold	Starts up or exits the audio peak filter configuration screen
AT	Press	Switches antenna tuner to ON or OFF
	Press and hold	Starts tuning
ATT	Press	Selection of attenuator
Band Direct (1.8 MHz)	Press	Band Direct selection (1.8 MHz band)
Band Direct (3.5 MHz)	Press	Band Direct selection (3.5 MHz band)
Band Direct (7 MHz)	Press	Band Direct selection (7 MHz band)
Band Direct (10 MHz)	Press	Band Direct selection (10 MHz band)
Band Direct (14 MHz)	Press	Band Direct selection (14 MHz band)
Band Direct (18 MHz)	Press	Band Direct selection (18 MHz band)
Band Direct (21 MHz)	Press	Band Direct selection (21 MHz band)

Parameter	Behavior of Assigned Functions	
Band Direct (24 MHz)	Press	Band Direct selection (24 MHz band)
Band Direct (28 MHz)	Press	Band Direct selection (28 MHz band)
Band Direct (50 MHz)	Press	Band Direct selection (50 MHz band)
BC	Press	Beat Cancel selection (BC1/BC2/OFF)
Capture	Press	Captures a screen shot
CAR	Press	Starts up or exits the carrier level configuration screen
CL	Press	Clears RIT/XIT
Contest Number Decrement	Press	Contest number decrement
CW T.	Press	Starts or stops CW auto tune
CW/CW-R	Press	Switches CW/CW-R mode (sideband)
DATA	Press	Switches DATA mode to ON or OFF
	Press and hold	Starts up or exits the TX audio source input configuration screen
DATA SEND	Press	Transmits the audio source configured on the TX audio source input configuration screen (→ TX audio input setting corresponding to the method of transmission)
DATA VOX	Press	Switches DATA VOX (OFF/ACC 2/USB/LAN)
DIMMER	Press	Switches the dimmer
	Press	Starts up or exits the dimmer configuration screen
DOWN Key (Microphone)	Press	Decreases the frequency (in VFO mode) Moves to a smaller channel number (in memory channel mode) Moves down the menu or to a smaller setting value (on menu configuration screen)
	Press	Switches drive output to ON or OFF
DSP Monitor	Press and hold	Switches DSP monitor (widens the IF filter to the maximum) to ON or OFF <This behavior is only applicable when the key is pressed and held down>
Emergency Frequency	Press	Calling up the preconfigured emergency frequency
ESC	Press	Exits the configuration screen
Extended Memory Channel	Press	Calls up expanded memory channel 0
FIL CLR	Press	Resets the RX filter to the preset state
FINE	Press	Switches the FINE-tuning function to ON or OFF
FM/AM	Press	Switches between the FM and AM modes
	Press and hold	Switches between FM narrow and FM normal
FSK/PSK	Press	Switches between the FSK and PSK modes
	Press and hold	Switches to the reverse mode
GENE	Press	Band Direct selection (GENE)
	Press and hold	Switches the transverter to ON or OFF
IF FIL	Press	Switches between RX filters A, B and C
	Press and hold	Starts up or exits the RX filter configuration screen
LOCK	Press	Switches the frequency lock function to ON or OFF
LSB/USB	Press	Switches between the LSB and USB modes
M.IN	Press	Starts up the memory scroll mode and registers a memory channel
M/V, M>V	Press	Switches between memory and VFO
	Press and hold	Memory shift
MAX-Po	Press	Switches the TX output power limiter to ON or OFF
	Press and hold	Starts up or exits the TX output power limit configuration screen

16 OTHER FUNCTIONS

Parameter	Behavior of Assigned Functions	
Message Memory CH 1	Press	Starts transmission of CW/RTTY/PSK message 1
Message Memory CH 2	Press	Starts transmission of CW/RTTY/PSK message 2
Message Memory CH 3	Press	Starts transmission of CW/RTTY/PSK message 3
Message Memory CH 4	Press	Starts transmission of CW/RTTY/PSK message 4
Message Memory CH 5	Press	Starts transmission of CW/RTTY/PSK message 5
Message Memory CH 6	Press	Starts transmission of CW/RTTY/PSK message 6
Message Memory CH 7	Press	Starts transmission of RTTY/PSK message 7
Message Memory CH 8	Press	Starts transmission of RTTY/PSK message 8
METER	Press	Switches the meter type
MHz	Press	Switches to the MHz mode
MONI	Press	Switches the TX monitor function to ON or OFF
Mute (Sub Receiver)	Press	Switches the sub-receiver audio mute to ON or OFF (use for Split Transfer 2)
NB1	Press	Switches NB1 to ON or OFF
	Press and hold	Starts up or exits the NB1 level configuration screen
NB2	Press	Switches NB2 to ON or OFF
	Press and hold	Starts up or exits the NB2 level configuration screen
NCH	Press	Switches the notch filter to ON or OFF
NR	Press	Switches the noise reduction mode (NR1/NR2/OFF)
	Press and hold	Starts up or exits the NR1 level configuration screen or NR2 level configuration screen
PLAY	Press	Starts or pauses playback of a file recording
PRE	Press	Preamplifier selection
PROC	Press	Switches the speech processor to ON or OFF
	Press and hold	Starts up or exits the speech processor configuration screen
Q-M.IN	Press	Registers to a quick memory
Q-MR	Press	Calls up a quick memory
	Press and hold	Deletes all quick memory data
REC	Press	Starts or pauses manual recording
	Press and hold	Writes full-time recording data to a file
RIT	Press	Switches RIT to ON or OFF
RX ANT	Press	Switches the RX antenna to ON or OFF
	Press and hold	Switches the antenna output for the external receiver to ON or OFF
RX EQ	Press	Switches the RX DSP equalizer to ON or OFF
	Press and hold	Starts up or exits the RX equalizer screen
RX Monitor	Press	Switches the RX monitor to ON or OFF
	Press and hold	Switches the RX monitor (to open the squelch forcibly) to ON or OFF <only while the key is pressed and held down>
Safe Removal of USB Flash Drive	Press	Unmounts the USB flash drive
SCAN	Press	Starts or stops scanning
	Press and hold	Starts up or exits VFO/Program Scan segment configuration screen/Memory Scan group configuration screen
SCP	Press	Switches to the SCOPE screen
SEND	Press	Enables or disables the TX mode

Parameter	Behavior of Assigned Functions	
SPLIT	Press	Switches split operation to ON or OFF
	Press and hold	Starts configuration of the frequency for split operation
STOP	Press	Stops recording or playback
SWL	Press	Switches SWL display mode to ON or OFF
TF-SET	Press	Switches TF-SET to ON or OFF
TX EQ	Press	Turning ON/OFF TX Equalizer
	Press and hold	Starts up or exits the TX equalizer screen
TX TUNE1	Press	Starts or ends TX Tune 1
TX TUNE2	Press and hold	Starts or ends TX Tune 2 <This behavior is only applicable when the key is pressed and held down>
UP Key (Microphone)	Press	Increases the frequency (in VFO mode) Moves to a larger channel number (in memory channel mode) Moves up the menu or to a larger setting value (on menu configuration screen)
VOICE1	Press	Starts the voice guide (VOICE1 function)
VOICE2	Press	Starts the voice guide (VOICE2 function)
VOICE3	Press	Starts the voice guide (VOICE3 function)
VOX	Press	Switches VOX to ON or OFF
	Press and hold	Starts up or exits the VOX configuration screen
XIT	Press	Switches XIT to ON or OFF
Off	Press	Does not assign any function

PC Control

The ARCP-890 radio control program, ARHP-890 radio host program, ARUA-10 USB audio control program and PC commands are used to control this transceiver or to enable the use of a PC speaker or microphone.

- This manual describes only the procedures for configuring the baud rate of the COM/USB port used for PC control. For more details on the necessary preparations and method of operation, please refer to the descriptions of the respective program software (Help text) and PC command list.
- To control this transceiver via USB cable connection, download the virtual COM port driver.
- To output the RX audio from the PC speaker using the USB audio function or transmit the audio input to the PC microphone, download the ARUA-10 audio controller. (In principle, delay occurs when USB audio is used. Make use of it for communication where time lag does not constitute an issue.)
- The abovementioned program, virtual COM port driver and PC command list can be downloaded from the website below.
http://www.kenwood.com/i/products/info/amateur/software_download.html



- Make sure not to connect this transceiver and the PC with the USB cable until the installation of the virtual COM port driver downloaded from the above URL is completed.
- If this transceiver is connected to the PC without installing the virtual COM port driver, a wrong driver that is not compatible with this transceiver may be installed and communication with the PC may not be established properly. To prevent a wrong driver from being installed, the virtual COM port driver must be installed before connecting to the PC.
- Before connecting this transceiver with a PC, make sure to turn off the power of this transceiver.

Configuring the COM/USB (Rear Panel) Baud Rate

This is used to configure the baud rate of the COM/USB port used for PC control.

- **Configure in Menu [7-00] “Baud Rate (COM Port)” (COM) or Menu [7-01] “Baud Rate (Virtual Standard COM)” (USB)**

COM

Setting Value	4800/ 9600 (default)/ 19200/ 38400/ 57600/ 115200 [bps]
----------------------	---

USB

Setting Value	9600/ 19200/ 38400/ 57600/ 115200 (default) [bps]
----------------------	---



- To use the baud rate of 38400, 57600 or 115200 bps, configure the baud rate of the RS-232C port of the PC you are using to a high speed.
- When using the ARCP-890, use a transfer rate that is as fast as possible.
- To display the bandscope at the normal speed during remote control of this transceiver using the ARCP-890 and ARHP-890, it is necessary to use an even higher baud rate. Connect a home LAN to the LAN connector on the rear panel.

Configuring the USB Keyboard

A USB keyboard can be used by connecting it to the (USB-A) port on the front or rear panel. It can be used to transmit or play back the voice or message assigned to a function key or to enter and transmit a text in the RTTY (FSK) or PSK mode.

When connected to this transceiver, the USB keyboard can be used for text input. The behavior (key repeat) when a key on the USB keyboard is pressed and held can also be configured.

Sending Message from the USB Keyboard

When this transceiver is configured as follows, a voice or message can be sent out by pressing the corresponding function key on the USB keyboard.

- When message sending from the USB keyboard is ON
- A voice or message has been assigned to a function key on the USB keyboard

- **Configure in Menu [9-00] “Send Message by Function Keys”**

Setting Value	Off/ On (default)
----------------------	-------------------



- When 2 USB keyboards are connected, only the one that is first connected to this transceiver is recognized.
- Channels not registered with a message cannot be selected.
- Message in the CW, FSK or PSK mode is sent out according to the settings of the channel in which the message is registered.
- While in the CW, FSK or PSK mode, a message can be sent out when the RTTY communication screen is displayed.

Selecting a USB Keyboard Language

Configure the type of USB keyboard (language or region) that is connected to this transceiver.

- **Configure in Menu [9-01] “Keyboard Language”**

Setting Value	Japanese/ English(US) (default)/ English(UK)/ French/ French(Canadian)/ German/ Portuguese/ Portuguese(Brazilian)/ Spanish/ Spanish(Latin American)/ Italian
----------------------	--

Configuring the Time for Activating Key Repeat

Configure the time interval before activating the key repeat operation of the USB keyboard.

- **Configure in Menu [9-02] “Repeat Delay Time”**

Setting Value	1 to 2 (default) to 4 (1 step)
----------------------	--------------------------------

Configuring the Key Repeat Speed

Configure the key repeat speed of the USB keyboard.

- **Configure in Menu [9-03] “Repeat Speed”**

Setting Value	1 (default) to 32 (1 step)
----------------------	----------------------------

Saving a Screen Shot

This transceiver comes with a screen capture function to capture an image of the screen display and save the image data in the PNG format (.png) to the built-in memory or a USB flash drive.

1 Assign “Capture” to a PF key.

- To save the image data to a USB flash drive, insert a USB flash drive into  (USB-A).

2 Press PF [Capture].

- The memory icon being selected as the storage destination blinks. A shot of the screen is captured at the same time when the key is pressed, and the captured data is saved to a USB flash drive. The directory of the storage destination is “KENWOOD\TS-890\CAPTURE”.
- When removing the USB flash drive, make sure to execute “Safe Removal of USB Flash Drive”. (See 11-6)



- The saved file is named as follows.
 yyyyymmdd_hhmmss.png
 (Example)
 20180215_102030.png
 (When the screen shot is saved on February 15, 2018, 10:20:30 a.m.)
 - When saving the screen capture to a USB flash drive, check the following in advance.
 The USB flash drive is formatted by this transceiver.
 The USB flash drive is correctly inserted into this transceiver.
 There is sufficient free space on the USB flash drive.
 The USB flash drive is not write-protected or the file system is not corrupted.
- A screen shot can also be captured and saved by pressing [Print Screen] on the USB keyboard.
- A screen shot cannot be captured when the screen saver is active.
- When screen capture fails, an error tone is output.
- It might take some time before the captured image is written to a USB flash drive. If there is an attempt to safely remove the USB flash drive, a message will be displayed asking the user to wait until the captured image file is saved to the USB flash drive before attempting to remove it.

Configuring Output to an External Meter

The TX or RX signal level can be displayed by connecting an analog meter to the METER terminal on the rear panel of this transceiver. A different output signal format can be configured for each of External Meter 1 and External Meter 2.

The signal to be output to the external meter during transmission can be configured as follows. During reception, the signal strength will be output as signals to the external meter.

Output rating of METER terminal:

Voltage: 0 to 5 V (no load)
 Impedance: 4.7 kΩ

Configuring the Output Signal Format of the External Meter

Configure the signal that is output from the METER terminal to the external meter.

● Configure in Advanced Menu [0] “Indication Signal Type (External Meter 1)” (External Meter 1) or Menu [1] “Indication Signal Type (External Meter 2)” (External Meter 2)

Setting Value	Automatic (default: External Meter 2)/ TX Power (default: External Meter 1)/ ALC/ Drain Voltage (Vd)/ Compression Level (COMP)/ Current (Id)/ SWR
---------------	---

Automatic: Outputs the S meter level during reception, and the signal level or meter value displayed on **F [METER]** during transmission.

TX Power: Outputs the TX output power value.

ALC: Outputs the ALC level.

Drain Voltage (Vd): Outputs the drain voltage of power amplification (FET).

Compression Level (COMP): Outputs the degree of audio signal enhancement by the speech processor.

Current (Id): Outputs the drain current of power amplification (FET).

SWR: Outputs the standing wave ratio (SWR).

Configuring the External Meter Output Level

External Meter 1 and External Meter 2 can be configured to different signal levels that are output from this transceiver according to the rating of the external meter that is connected to the METER terminal.

● Configure in Advanced Menu [2] “Output Level (External Meter 1)” (External Meter 1) or Menu [3] “Output Level (External Meter 2)” (External Meter 2)

Setting Value	0% to 50% (default) to 100% (1 step)
---------------	--------------------------------------

- At “100%”, the voltage is 5 V.

External Monitor Output

Connecting an external monitor to the DISPLAY connector enables the image displayed on the screen of this transceiver to be displayed on the external monitor at the same time.

● Configure in Advanced Menu [21] “External Display”

Setting Value	Off/ On (default)
---------------	-------------------

Configuring the External Monitor Resolution

The resolution of the external monitor that is connected to the DISPLAY connector can be configured.

● Configure in Advanced Menu [22] “Resolution (External Display)”

Setting Value	800 x 600 (default)/ 848 x 480
---------------	--------------------------------



- When the resolution of the external monitor is changed, a resolution switch screen will appear for approximately 5 seconds before the change is applied.

Configuring Audio Input/Output

Configuring the USB Connector Input/Output Signal

The input/output level of the audio signal when an external device is connected to the (USB-B) connector on the rear panel can be configured.

Configuring the Audio Signal Input Level

Configure the audio input level for the (USB-B) connector on the rear panel.

● Configure in Menu [7-06] “USB: Audio Input Level”

Setting Value	0 to 50 (default) to 100 (1 step)
---------------	-----------------------------------

Configuring the Audio Signal Output Level

Configure the audio output level for the (USB-B) connector on the rear panel.

● Configure in Menu [7-08] “USB: Audio Output Level”

Setting Value	0 to 100 (default) (1 step)
---------------	-----------------------------



- When using a Windows PC, wait for the PC to recognize this transceiver, then select Control Panel → Hardware and Sound → Sound → Recording → Microphone (USB Audio CODEC) → Properties, followed by selecting “2 channel”.
- Windows is a registered trademark of Microsoft Corporation in the United States and other countries.

Configuring the ACC 2 Connector Input/Output Signal

The input/output level of the audio signal when an external device is connected to the ACC 2 connector on the rear panel can be configured.

Configuring the Audio Signal Input Level

Configure the level of audio signal input to the ACC 2 connector on the rear panel.

● Configure in Menu [7-07] “ACC 2: Audio Input Level”

Setting Value	0 to 50 (default) to 100 (1 step)
---------------	-----------------------------------

Configuring the Audio Signal Output Level

Configure the input/output level of the audio signal when an external device is connected to the ACC 2 connector on the rear panel.

● Configure in Menu [7-09] “ACC 2: Audio Output Level”

Setting Value	0 to 50 (default) to 100 (1 step)
---------------	-----------------------------------

Configuring the TX Monitor Level for External Audio Output

Configure the level of the TX monitor audio that is output from the rear connector.

● Configure in Menu [7-10] “TX Monitor Level (Rear Connectors)”

Setting Value	Linked (default)/ 0 to 20 (1 step)
---------------	------------------------------------

- Configuring to “Linked” changes the level in tandem with the level configured during TX monitor level adjustment.

Configuring Audio Mixing for the External Audio Output Connector

Configure whether to mix the audio produced by this transceiver with the RX audio that is output from the (USB-B) connector and ANO terminal of the ACC 2 connector.

● Configure in Menu [7-11] “Audio Output Type (Rear Connectors)”

Setting Value	All (default)/ Received Audio only
---------------	------------------------------------

All: Enables output of beep tone, voice guidance, audio of voice message memory and recorded audio or sidetone.

Received Audio Only: Select this setting when having an external device decode the digital modulation signals.

- When the RX audio is mixed with the beep tone, voice guidance or error tone emitted from this transceiver, the command response or error tone produced by this transceiver can also be heard at a remote location during, for example, KNS (Kenwood Network Command System) operation with this transceiver installed at a remote location.



- Audio output to LAN is used for the purpose of listening to the audio output from the transceiver speaker on a remote PC during remote operation. As such, audio such as the beep sound is always mixed regardless of the setting in this menu.

Switching the Reference Signal

External frequency input (10 MHz) from the REF IN connector on the rear panel can be used as the reference frequency of this transceiver. The input impedance is 50 Ω.

- Inputting a reference signal with a high degree of accuracy from an external source to this transceiver and using it as the reference frequency helps to enhance the frequency accuracy of this transceiver.
- The standard input level is 0 dBm ±10 dB.

● **Configure in Advanced Menu [4] “Reference Signal Source”**

Setting Value	Internal (default)/ External
----------------------	------------------------------

Internal: Uses the built-in reference signal transmitter of this transceiver.

External: Uses the external frequency input from the REF IN connector as the reference frequency.

- This transceiver may not function properly if the reference input level from the external source is low or if there is deviation in the frequency.
- Please refer to (17-2) for the adjustment of internal reference frequency.

Switching the CTCSS Mute Operation

● **Configure in Advanced Menu [13] “CTCSS Unmute for Internal Speaker”**

Setting Value	Mute (default)/ Unmute
----------------------	------------------------

- When combining the use of CTCSS to prevent unwanted signals such as noise from being transmitted from the base station to the Internet while operating this transceiver as a VoIP amateur radio base station, configure to “Unmute” so that the status of the operating frequency can be verified. Doing so outputs all RX audio signals from the speaker regardless of the matching status of the CTCSS frequency. Only RX signals with a matching CTCSS frequency are output from the ACC 2/USB port.

Configuring the SQL Control Signal

When operating this transceiver with an external device such as TNC or PC connected to the ACC 2 connector on the rear panel, the status of the SQL control signal for the PSQ pin of the ACC 2 connector can be configured.

Configuring the Logic of PSQ

Configure the SQL control signal logic of the PSQ pin.

● **Configure in Advanced Menu [14] “PSQ Logic State”**

Setting Value	Low (default)/ Open
----------------------	---------------------

- Configure to “Open” to enable the VoIP application installed on the PC to detect a busy state even when the power of this transceiver is OFF. Also, configure the busy detection logic of the VoIP application so that it matches that of this transceiver.

Configuring the PSQ Output Conditions

Configure the transition in the status of the SQL control signal output from the PSQ pin.

● **Select Advanced Menu [15] “PSQ Reverse Condition”.**

Setting Value	Off/ Busy/ Sql (default)/ Send/ Busy-Send/ Sql-Send
----------------------	---

- The PSK behavior in each of the setting is as follows.

Setting Value	Behavior
Off	Fixed in the low (inactive) state.
Busy	Switches the SQL control signal to the high (active) state regardless of the matching status of the CTCSS frequency received.
Sql	When CTCSS is ON, SQL control signal switches to the high state when the CTCSS received matches the CTCSS configured on this transceiver. When CTCSS is OFF, SQL control signal switches to the high state when a signal is received by this transceiver regardless of the matching status of CTCSS.
Send	Switches the SQL control signal to the high state when this transceiver transmits a signal.
Busy-Send	Switches the SQL control signal to the high state when this transceiver transmits or receives a signal.
Sql-Send	Switches the SQL control signal to the high state in the same way as when the setting is configured to “Sql” and “Send”.

Switching the COM Connector Signal

The CTS/RTS terminal of the COM connector on the rear panel can be configured such that it operates in the same way as the PSQ/PKS terminal of the ACC 2 connector.

1 **Configure in Advanced Menu [16] “PSQ/PKS Pin Assignment (COM Connector)”.**

Setting Value	Off (default)/ On
----------------------	-------------------

Off: The COM connector processes both the CTS and RTS signals.

On: The signals of the CTS and RTS pins of the COM connector are replaced by PSQ and PKS signals respectively.

- A message to confirm the behavior of the COM connector is displayed.

2 **Reboot this transceiver.**

After this transceiver reboots, the new settings are applied.

Split Transfer

This function allows frequency information to be transferred by connecting another transceiver to this transceiver as a sub-receiver. There are two modes for this function: Split Transfer 1 and Split Transfer 2.

Split Transfer 1

This function transfer information on the TX VFO frequency during split operation from the transceiver (TX/RX end) to the transceiver that functions as a sub-receiver. This is a convenient function for simultaneous dual-frequency reception by having the sub-receiver receive the split frequencies from the TX/RX end. It also supports the standby mode.

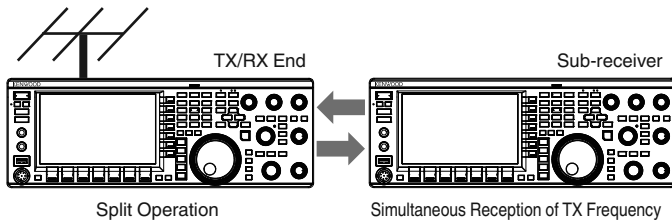

The usable transceiver models are TS-890S, TS-590SG and TS-590S. TS-590SG and TS-590S can be used only as a sub-receiver.



- Firmware update is needed when TS-590S/ TS-590G is used as a sub-receiver.

Split Transfer 2

This mode is used for connecting another transceiver to this transceiver as a sub-receiver during two-man operation while contesting. This is a convenient function that allows the sub-operator at the sub-receiver end to transmit frequency information to the main operator at the TX/RX end.

Operating data can be transferred by the following transceiver models.

- TS-890S
- TS-990S
- TS-590S
- TS-590SG
- TS-480 series
- TS-2000 series
- TS-570 series
- TS-870S



- Some functions may not be usable during split transfer between this transceiver and another transceiver.

Connection

Connect the 2 transceivers to enable transfer of frequency data and sharing of antenna.



- Cables for connection need to be prepared separately by the user.

Connection for Data Transfer:

Connect the COM connector of the 2 transceiver units using a RS-232C cross cable (female-female).

Connection for Antenna Sharing:

Connect the ANT OUT connector at the TX/RX end to the ANT or RX IN connector at the sub-receiver end using a coaxial cable. Turn on the ANT OUT function at the TX/RX end. Select the connected ANT connector at the sub-receiver end or make use of the RX ANT function.

Split Transfer 1

Below is an example of using this transceiver at both the TX/RX end and sub-receiver end in the standard settings. Before using the TS-590/TS-590 G series as a sub-receiver, please read through the instruction manual and update documents.

Configuration

Using TS-890 at the TX/RX End

- 1 Enable this transceiver to function as a TX/RX end transceiver.**
Select "1 (TX/RX)" in Menu [7-04] "Quick Data Transfer".
- 2 Configure the baud rate to 115200 bps.**
Select "115200 [bps]" in Menu [7-00] "Baud Rate (COM Port)".
- 3 Set to the VFO mode.**
If the transceiver is in the memory channel or quick memory channel mode, switch it to the VFO mode.

Using TS-890 as a Sub-receiver

- 1 Enable this transceiver to function as a sub-receiver.**
Select "1 (Sub RX)" in Menu [7-04] "Quick Data Transfer".
- 2 Configure the baud rate to 115200 bps.**
Select "115200 [bps]" in Menu [7-00] "Baud Rate (COM Port)".
- 3 Set to the VFO mode.**
If the transceiver is in the memory channel or quick memory channel mode, switch it to the VFO mode.
- 4 Set to simplex mode.**



- This transceiver functions only at the transfer rate of 115200 [bps].
- It does not function in the memory channel and quick memory channel modes.
- This function cannot be used in the split mode.

Operation

1 Transfer the TX frequency information during split operation from the TX/RX end to the sub-receiver end.

By pressing [SPLIT] at the TX/RX end to switch to the split mode, the TX frequency and mode information is transferred to the VFO of the sub-receiver and enables the TX frequency to be received by the sub-receiver.

Subsequently, when there is a change in the TX frequency at the TX/RX end, the new TX frequency information will be transferred automatically, and the RX frequency at the sub-receiver will be adjusted accordingly. Below are some examples.

- When the TX frequency is changed using the XIT function
- When the RX band and TX band are changed at the same time using the Band Direct key (“RX/ TX Band” needs to be selected in advance in Menu [3-13] “Band Direct Keys in Split Mode”.)
- When the split TX frequency is changed via operation of the RIT/XIT control (“TX Frequency Offset while RX” needs to be selected in advance in Menu [3-12] “Split Frequency Offset by RIT/XIT Control”.)

2 Change the RX frequency that is transferred from the TX/RX end at the sub-receiver end.

The frequency that is transferred to the sub-receiver end can be adjusted independently without affecting the value at the TX/RX end.

To restore the state where the frequency matches with the TX frequency at the TX/RX end, press [SPLIT] at the TX/RX end to reactivate the split function.

3 Transfer the frequency detected at the sub-receiver end to the TX frequency at the TX/RX end.

Pressing [Q-M.IN] at the sub-receiver end transfers the current frequency information to the TX VFO at the TX/RX end.



- Upon transmission from the TX/RX end, the sub-receiver switches to the standby mode.
- The transceiver at the sub-receiver end is inhibited from transmission.
- When XIT at the TX/RX end is ON, the XIT frequency is added to the frequency to be transferred.
- When RIT at the sub-receiver end is ON, the RIT frequency is added to the frequency to be transferred.
- Frequency information cannot be received from the sub-receiver if the TX/RX end is not configured to the split mode.

Muting the Sub-receiver

The RX audio at the sub-receiver can be muted by the TX/RX end.

1 Assign “Mute (Sub Receiver)” to a PF key at the TX/RX end.

2 Press PF [Mute (Sub Receiver)].

The RX audio at the sub-receiver end is muted.

- Pressing the PF [Mute (Sub Receiver)] key again unmutes the RX audio.

Split Transfer 2

This function supports the “split transfer” function on models before the TS-890S. It allows existing users of the “split transfer” function to continue using it after changing to TS-890S. Follow the steps below to operate this transceiver. To combine the use of a transceiver other than this transceiver, please refer to the instruction manual of the model to be used.

Using TS-890S at the Sub-receiver End (Master)

1 Turn ON Split Transfer 2.

Select “2” in Menu [7-04] “Quick Data Transfer”.

2 Tune to the frequency of the party to communicate with in the VFO mode.

Operate the Tuning control to tune to the frequency of the party to communicate with.

3 Transfer the frequency information to the TX/RX end.

Pressing [Q-M.IN] saves the frequency information to channel 0 of the quick memory and transfers it to quick memory channel 0 or VFO at the TX/RX end.

Using TS-890S at the TX/RX End (Slave)

1 Turn ON Split Transfer 2.

Select “2” in Menu [7-04] “Quick Data Transfer”.

2 Configure whether frequency information transferred from the sub-receiver is to be received by the quick memory channel or VFO.

Select “VFO” or “Quick Memory” in Menu [7-05] “Overwrite Location (Quick Data Transfer)”.

3 Receive frequency information from the sub-receiver.

Upon receiving frequency information that is transferred from the sub-receiver, channel 0 of the quick memory or VFO is updated according to the setting in step 2.



- Configure the 2 transceivers that are connected to each other to the same COM connector baud rate.
- To prevent malfunction, reboot both transceivers after configuring the settings.
- When using this transceiver as a sub-receiver, configure Menu [6-03] “TX Inhibit” to “On” to prevent erroneous transmission.

TX Inhibit

This function prevents erroneous transmission. When TX Inhibit is ON, this transceiver does not carry out transmission even when [PTT] on the microphone is pressed.

The RX audio also becomes inaudible while [PTT] is pressed. Inhibit transmission in the following cases.

- When you want to operate the master transceiver unit as a receive-only unit during operation in the Split Transfer 2 mode. Transmission is not carried out even when this is attempted using the master transceiver. Audio is also not output.
- When you do not wish to transmit signals to the host transceiver while controlling the transceiver via PC using KNS (KENWOOD NETWORK COMMAND SYSTEM).

● Configure in Menu [6-03] "TX Inhibit"

Setting Value	Off (default)/ On
---------------	-------------------



- When TX Inhibit is ON, RX audio is muted when the SS terminal signal level of the ACC 2 connector is low. RX audio is also muted while [PTT] is pressed as the signal level of the SS terminal becomes low.
- When TX Inhibit is ON, tuning cannot be performed by the antenna tuner.
- When using this transceiver as a receive-only unit at all times, configure this setting to "On" to prevent erroneous transmission.

Tuning the Packet Cluster

Packet cluster tuning can be performed by connecting this transceiver to another transceiver. The following transceivers can be connected for this purpose.

- TM-D710 (discontinued)
- TM-D710G
- TM-D700 (G version or later) (discontinued)
- TH-D72

Connection

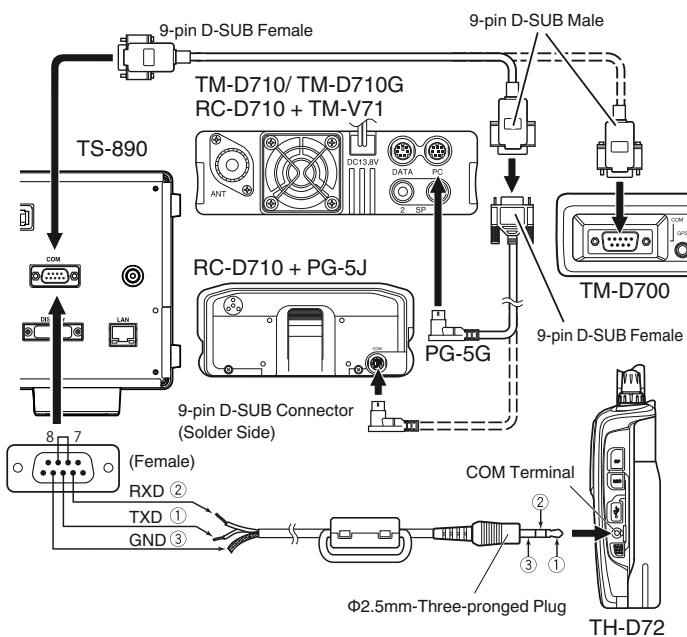

Receiving Packet Cluster Data

Follow the steps below to operate the transceiver that is connected to this transceiver.

- 1 Switch to the APRS or Navitra mode to receive the DX packet cluster data.
- 2 Display the DX packet cluster and align the cursor with the frequency to tune to.
- 3 Press the corresponding key to output the frequency value selected in step 2.

The operating frequency (VFO) is configured based on the packet cluster data received if the frequency is configurable by this transceiver.

- TM-D710, TM-D710G, RC-D710: [TUNE] key
- TM-D700: [MHz] key
- TH-D72: [MENU] key



- In the VFO mode, the operating frequency (VFO) that is currently in use is configured. In the memory channel mode, the most recent operating frequency (VFO) is configured.

16 OTHER FUNCTIONS

Control of External Devices

TX Inhibit in Busy State (when Squelch is Open)

When transmission is inhibited in the busy state, pressing [SEND] on the front panel or [PTT] on the microphone does not execute transmission while this transceiver is busy.

- **Configure in Advanced Menu [12] “TX Inhibit While Busy”**

Setting Value	Off (default)/ On
---------------	-------------------

Reversing the PKS Signal Polarity

Short-circuiting the PKS terminal to GND places this transceiver in the TX mode. This polarity can be reversed according to the device to be connected.

- **Configure in Advanced Menu [11] “PKS Polarity Reverse”**

Setting Value	Off (default)/ On
---------------	-------------------

Off: Short-circuiting the PKS terminal of the ACC 2 connector to GND places this transceiver in the TX mode.

On: Applying a voltage of 3 V to 5 V to the PKS terminal of the ACC 2 connector places this transceiver in the TX mode.

USB Keying

This function is compatible with PC applications for controlling the different behaviors including CW keying, RTTY frequency shift and PTT/SEND (TX/RX switching) using the RTS/DTR signal of the COM port.

It allows the above behaviors to be assigned to the RTS and DTR signals of the 2 virtual COM ports (Standard and Enhanced) during USB connection.

Off: Disabled

Flow Control: Behaves as a hardware flow control signal for command communication.

CW Keying: Behaves as a CW keying signal.

RTTY Keying: Behaves as an RTTY frequency shift key signal.

PTT: Behaves in the same way as PTT (END).

DATA SEND: Behaves in the same way as DATA SEND (PKS).

- **Configure in Advanced Menu [17] “Virtual Standard COM Port – RTS”**

Setting Value	Flow Control (default)/ CW Keying/ RTTY Keying/ PTT/ DATA SEND
---------------	--

- **Configure in Advanced Menu [18] “Virtual Standard COM Port – DTR”, [19] “Virtual Standard COM Port – RTS” or [20] “Virtual Standard COM Port – DTR”**

Setting Value	Off (default)/ CW Keying/ RTTY Keying/ PTT/ DATA SEND
---------------	---

-  “RTTY Keying” can only be configured for 1 out of the 4 signals (duplicate configuration is not allowed).
- When this menu is configured to RTTY Keying (during RTTY operation via USB keying), RTK of the ACC 2 connector will be disabled.

Decoded Character Output

This function outputs characters decoded by the built-in decoder of CW/ RTTY/ PSK from the virtual COM port (Enhanced). The baud rate is also variable.

Turning ON/OFF Decoded Character Output

- **Configure in Menu [7-03] “Decoded Character Output”**

Setting Value	Off (default)/ On
---------------	-------------------

Configuring the Baud Rate of the Virtual COM (Enhanced) Connector

- **Configure in Menu [7-02] “Baud Rate (Virtual Enhanced COM)”**

Setting Value	9600/ 19200/ 38400/ 57600/ 115200 (default) [bps]
---------------	---

Controlling the Linear Amplifier

This section describes the procedures for configuring the control signal and TX/RX delay when using a linear amplifier. Outputs of the mechanical relay (MKE, BRK, COM) and semiconductor switch (RL) are output to the REMOTE connector on the rear panel, which allows users to combine the use of this transceiver with their linear amplifier. The control signal status and whether to enable TX delay time can be configured on the menu screen. HF band, 50 MHz band and 70 MHz band (E type only) can be configured separately.

Connection

- Use the supplied 7-pin DIN plug to make your own connection cable.

TL-922 Connection

Connect terminal no. 2 (COM) of the REMOTE connector to GND of TL-922, and terminal no.4 (MKE) of the REMOTE connector to RL CONT of TL-922. Connect terminal No. 6 (ALC) of the REMOTE connector to ALC OUT of TL-922.

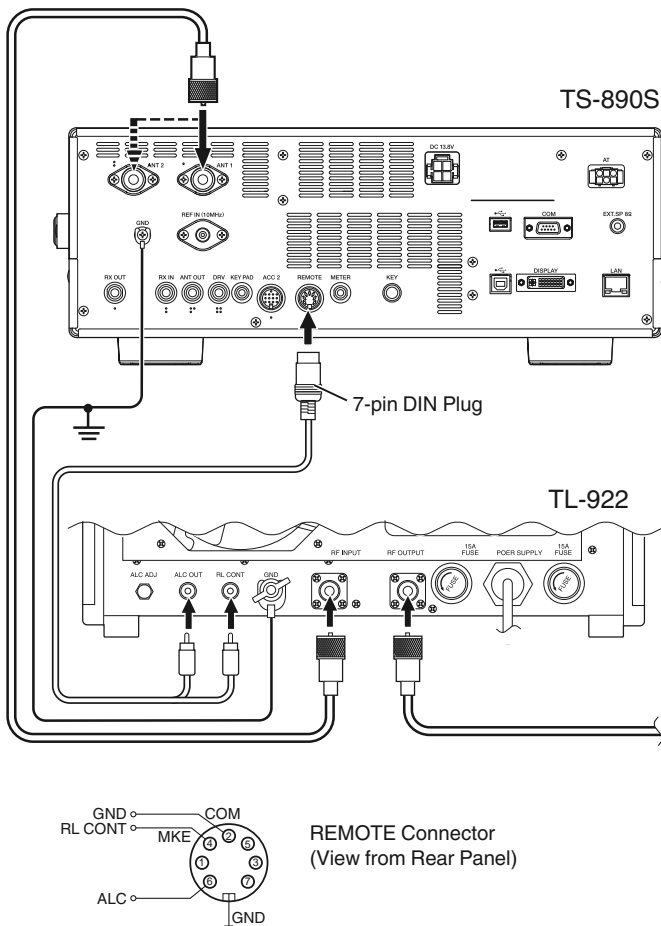

General Linear Amplifier Connection

Follow the diagram below to connect a commercially available linear amplifier.

- The ALC circuit of this transceiver is activated when the output voltage from the linear amplifier is between -7 and -10 V. To enhance the stability of the output and ALC operation, it is recommended that the TX output power limiter function be configured.
- For more details on connection with a linear amplifier, please refer to the instruction manual of the linear amplifier to be used.

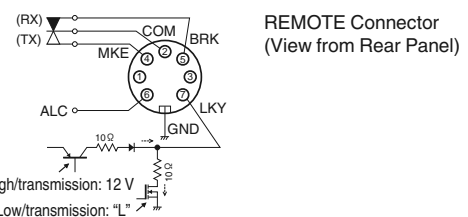
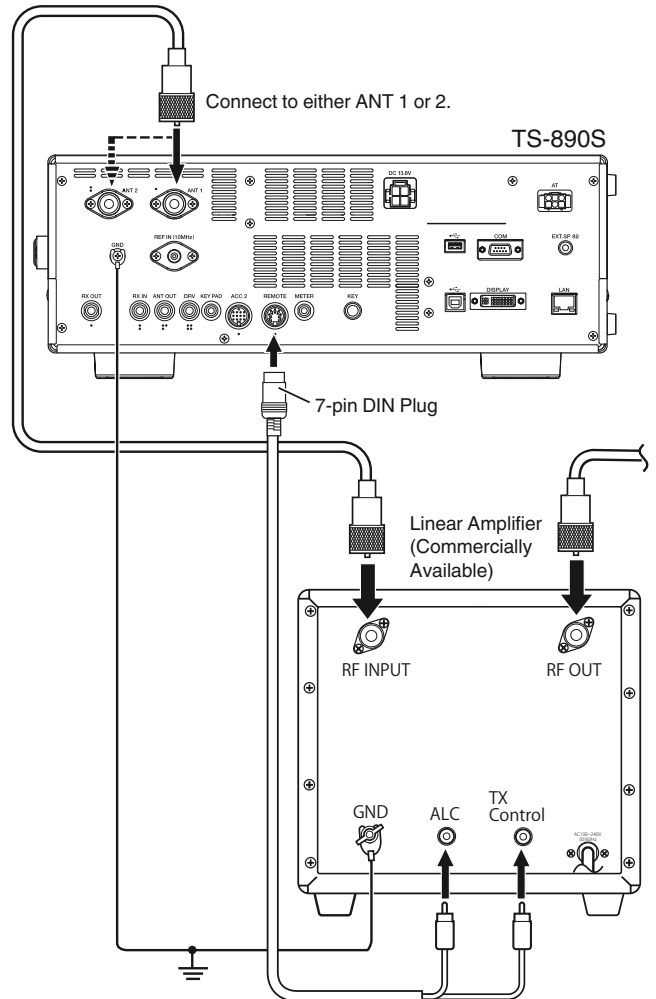

- The method for controlling linear amplifiers varies with the type of linear amplifier in use. There are some linear amplifiers that place this transceiver in the TX mode once the control terminal is connected to GND. When using such types of linear amplifiers, connect terminal no. 2 (COM) of the REMOTE connector to GND of the linear amplifier, and terminal no. 4 (MKE) of the REMOTE connector to the control terminal of the linear amplifier.

Linear Amplifier Menu Screen

- 1 Press **F** [**LINEAR AMP**] on the menu screen to display the Linear Amplifier menu screen.



- 2 Press **F6** [**BAND**] to switch to the target band. Pressing **F6** [**BAND**] each time toggles the selection to “HF Band”, “50 MHz Band” and “70 MHz Band” (E type only) in sequence.
- 3 Press **F2** [**▲**] / **F3** [**▼**] to select the setting item.
- 4 Press **F4** [**-**] / **F5** [**+**] or turn the [**MULTI/CH**] control to select the setting value.
 - The following settings are recommended when using the TL-922 (discontinued).

Settings Menu	TL-922
Linear Amplifier	On
Keying Logic	Active Low
TX Delay	On
TX Delay Time (CW/FSK/PSK)	15
TX Delay Time (SSB/FM/AM)	35
Internal Relay Control	On
External ALC Voltage	-6 [V]

Turning ON/OFF Linear Amplifier

Switch the linear amplifier function for each target band to ON or OFF.

- **Configure “Linear Amplifier” in Linear Amplifier Menu**

Setting Value	Off (default)/ On
---------------	-------------------

Linear Amplifier TX Control

TX control of the linear amplifier without using relay control can be performed via the 7-pin LKY terminal of the REMOTE connector. This function is used for TX control when using a linear amplifier that supports full break-in.

- **Configure “Keying Logic” in Linear Amplifier Menu**

Setting Value	Active Low (default)/ Active High
---------------	-----------------------------------

Turning ON/OFF Linear Amplifier TX Delay

Delay the switching operation by the transmission system of this transceiver when there is a long time lag before transmission starts on the linear amplifier in use.

- **Configure “TX Delay” in Linear Amplifier Menu**

Setting Value	Off (default)/ On
---------------	-------------------

-  When the TX delay of the linear amplifier is ON, TX delay time is added to the time from when transmission is started until the radio wave is output (usually about 15 ms).

Linear Amplifier TX Delay Time

The TX delay time when using a linear amplifier can be configured separately for the CW/FSK/PSK and SSB/FM/AM modes.

CW/FSK/PSK Mode

- **Configure “TX Delay Time (CW/FSK/PSK)” in Linear Amplifier Menu**

Setting Value	5/ 10/ 15 (default)/ 20/ 25/ 30/ 35/ 40 [ms]
---------------	--

SSB/FM/AM Mode

- **Configure “TX Delay Time (SSB/FM/AM)” in Linear Amplifier Menu**

Setting Value	5/ 10/ 15/ 20/ 25/ 30/ 35 (default)/ 40/ 45/ 50 [ms]
---------------	--

Linear Amplifier Relay Control

When using a linear amplifier that requires TX control via a mechanical relay, the built-in mechanical relay terminals of this transceiver (pin 4 MKE terminal, pin 5 BRK terminal, pin 2 COM terminal of the REMOTE connector) are used.

- **Configure “Internal Relay Control” in Linear Amplifier Menu**

Setting Value	Off (default)/ On
---------------	-------------------

On: Activates the following relay control.

- The BRK terminal is connected to the COM terminal during transmission.
- The MKE terminal is connected to the COM terminal when there is no transmission.

Off: Relay control is not activated and the MKE terminal remains connected to the COM terminal at all times.

-  When using a linear amplifier that does not require control via a mechanical relay, configure to “Off” to minimize the relay sound.

External ALC Voltage of Linear Amplifier

Adjust the response of the ALC terminal (pin 6) of the REMOTE connector on this transceiver according to the linear amplifier in use.

- **Configure “External ALC Voltage” in Linear Amplifier Menu**

Setting Value	-1/ -2/ -3/ -4 (default)/ -5/ -6/ -7/ -8/ -9/ -10/ -11/ -12 [V]
---------------	---

- Under normal circumstances, make adjustments on the linear amplifier without changing the default setting.

Operating the Transverter/Exciter

This is a handy function when combining this transceiver with a transverter that can be used to convert the operating frequency of the exciter (this transceiver) to a different frequency. For details on the procedures for connecting the exciter with a transverter, please refer to the instruction manual of the transverter in use.



- Some functions on this transceiver are not usable when a transverter is used.



- Turn off the power of both this transceiver and the transverter before connecting them. Check the connection between this transceiver and the transverter before turning on the power of both devices.

Connecting to a Transverter

There are 2 ways of connecting the exciter with a transverter. The first is via the ANT connector (for both TX and RX and output is fixed at 5 W), while the other is via the RX IN connector (RX input) and DRV connector (drive output). Both types of connection allow the frequency display of this transceiver to be changed to the operating frequency display of the transverter.

To input a signal exceeding 5 W from the ANT connector to the transverter, set the TX output power limit during transverter operation to OFF in Advanced Menu [08] "TX Power Down with Transverter Enabled".

Connecting to the RX IN and DRV Connectors

- Connect the transverter to the RX IN and DRV connectors.
- Press [RX ANT] to set reception from the RX IN connector to ON.
<<[RX] >> is displayed.
- Press [DRV] to set output from the DRV connector to ON.
The [DRV] LED lights up in green.

Connecting to the ANT Connector

- Connect the transverter to the ANT connector.
- Press [RX ANT] to set reception from the RX IN connector to OFF.
<<[RX] >> is displayed.
- Press [DRV] to set output from the DRV connector to OFF.
<<[DRV] >> LED goes off.



- When the RX IN and DRV connectors are selected, transmission and reception via the ANT connector are disabled.

Turning off Power Down during Transverter Operation

When the RF input level of the transverter is 5 W or higher and signal of 5 W or higher is output from the ANT connector to the transverter, configure Power Down while the transverter is in use to "Off" (turn off fixed output at 5 W).

- Configure in Advanced Menu [6] "TX Power Down with Transverter Enabled"

Setting Value	Off/ On (default)



- When "Off" is selected, a maximum power of 100 W is supplied to the device that is connected to the ANT connector. This may damage the connected device or cause it to malfunction so switching the power down setting is entirely at your own risk.

Displaying the Operating Frequency Configured for the Transverter

When the transverter is ON, the last digit of the frequency display is not shown and the operating frequency configured for the transverter is displayed.

- Turn the Tuning control to select an operating frequency for the exciter (this transceiver).
The transverter converts this frequency for output. Configure the frequency such that it falls within the transmission range.
- Press and hold [GENE] to set the transverter to ON.
<<[XVTR] >> is displayed and the frequencies that can be configured for the transverter are displayed.
- Press and hold [GENE] again.
The transverter is now OFF.



- Some functions on this transceiver are not usable when a transverter is used.

Configuring the Operating Frequency of the Transverter

- Press and hold [GENE] to set the transverter to ON.
<<[XVTR] >> is displayed.
- Press [ENT] to enable input of a frequency value.
- Enter the output frequency of the transverter using the numeric keypad.
- Press [ENT] to confirm the input.
Instead of the actual operating frequency of this transceiver, the output frequency of the transverter is now displayed.

Operation Example: Operation by entering a 28 MHz signal to a 430 MHz transverter

- Connect a 430 MHz transverter to this transceiver.
- Configure the RX frequency of this transceiver to "28.000.000".
- Press and hold [GENE] to set the transverter to ON.
- Press [ENT] for band selection using the numeric keypad.
- Next, enter "430.000.00" and press [ENT].
- Turn the Tuning or [MULTI/CH] control on this transceiver to select a frequency.

Antenna Output for External Receivers

When this function is ON, the RX signal that enters the transceiver from the currently selected antenna (ANT 1, ANT 2 or RX ANT) is split along the way. A part of the split signal is input to the RX circuit, while the other part to the ANT OUT terminal.

- Press and hold [RX ANT] to set the antenna output for external receiver to ON or OFF.
 - When it is ON, <<[G] >> lights up.



- When the antenna output function is used, the RX sensitivity and gain lower by approximately 3 dB due to signal loss in the splitter.
- During transmission, there is a very slight amount of output leakage due to internal isolation (approximately -20 dBm in the 50 MHz band).
- The ON/OFF status of the antenna output function is stored separately for the HF band and 50/70 MHz band.

Emergency Call (K Type Only)

Section 97.401(d) of the regulations governing amateur radio in the United States permit emergency amateur communications on 5167.5 kHz by stations in or within 92.6 km of the state of Alaska. This frequency is for use only when the immediate safety of human life and/or property are threatened, and is never to be used for routine communications.

Press **[EMERGENCY]** to change to the Emergency channel (5167.5 kHz/ USB).

- **[EMERGENCY]** can be assigned to a PF key.
- When entering Emergency mode, "EMERGENCY" momentarily appears on the screen.



- RIT/XIT turns OFF automatically when entering Emergency mode.
- The transceiver will not switch to the Emergency channel if you are using the constant recorder and are either transmitting, receiving a voice call, or receiving a CW call.

Crossband Repeater

If you have a KENWOOD FM transceiver (K type) with a 6 pin mini DIN connector, you can set up the TS-890S transceiver and the FM transceiver as a crossband repeater. The FM transceiver will receive signals you transmit from the additional VHF or UHF transceiver when both transceivers are set with the same frequency. The signal is then routed to the TS-890S transceiver and retransmitted on the frequency you have set on the TS-890S transceiver. Likewise, signals received on the TS-890S transceiver are routed to the FM transceiver and retransmitted to the transceiver you have with you, allowing you to hear the received call in a distant location.



- For the repeater function to operate, the squelch levels of both transceivers (TS-890S and FM transceiver) must be adjusted properly so that no background noise can be heard; the transmission is controlled by monitoring the squelch status only.

Connection

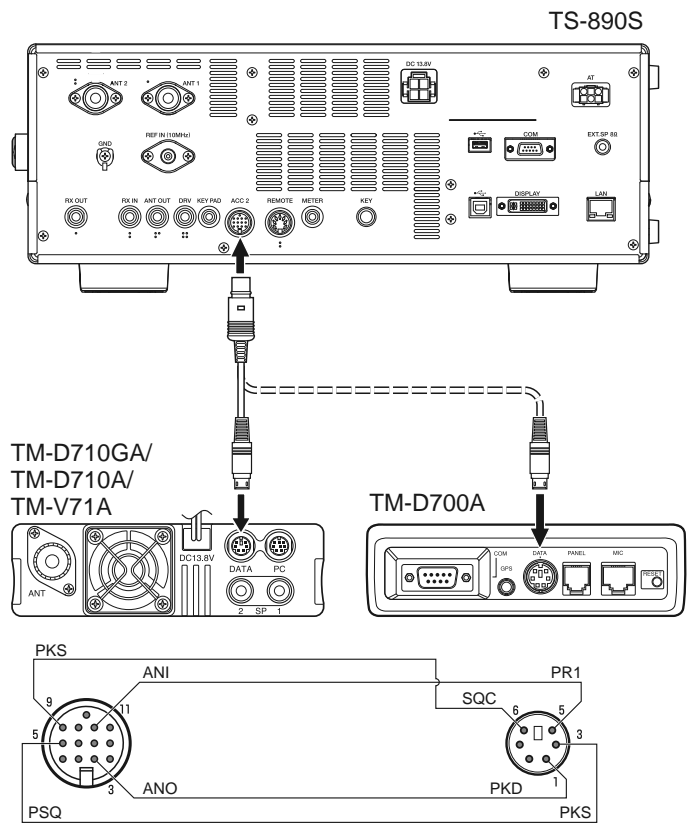

Operation

The crossband repeater function uses 2 frequency bands to receive and transmit signals. When a signal is received on one band, it is retransmitted on the other band.

- 1 Select a transmission/reception VHF or UHF frequency on the FM transceiver.
- 2 Confirm the PTT icon is visible on the crossband repeater frequency on the FM transceiver.
- 3 Select the same frequency for the terminal transceiver.
- 4 Select a HF/50 MHz frequency on the TS-890S transceiver.
- 5 Adjust the squelch threshold level so that both the TS-890S and FM transceivers mute.
- 6 On the TS-890S, press **[MENU]**, then access **Advanced Menu [11] (PKS Polarity Reverse)** and **[12] (TX Inhibit While Busy)**.
- 7 Select "On".
 - When the TS-890S transceiver's squelch opens, the FM transceiver simultaneously retransmits the incoming audio signal on the VHF or UHF frequency.
 - When the FM transceiver's squelch opens, the TS-890S transceiver retransmits the incoming audio signal on the HF/50 MHz frequency.
- 8 Access **Menu [7-07] (ACC2: Audio Input Level)** and **[7-09] (ACC2: Audio Output Level)** and adjust the input/ output audio level.
- 9 To quit the FM repeater operation, disconnect the interface cable between the transceivers, then access **Advanced Menu [11]** and **[12]** on the TS-890S transceiver and select "Off".

Sky Command System II

Sky Command System II allows you to remotely control the TS-890S transceiver from a separate location.

- If you have more than 2 TH-D7A/ TH-D72(A/E)/ TM-D710/G(A/E)/ TM-V71A + RC-D710/ TM-D700A transceivers, you can perform Sky Command System II operation to remotely control your TS-890S transceiver.
- You will use one transceiver (TH-D7A, TH-D72(A/E)/ TM-D710/G(A/E), TM-V71A + RC-D710, or TM-D700A) as a remote control unit, called a “Commander”. The other VHF/ UHF transceiver (TH-D7A, TH-D72(A/E)/ TM-D710/G(A/E), TM-V71A + RC-D710, or TM-D700A) with the TS-890S transceiver is called the “Transporter”. This TH-D7A, TH-D72(A/E)/ TM-D710/G(A/E), TM-V71A + RC-D710, or TM-D700A transceiver will function as an interface between the Commander (a remote control unit) and the band of the TS-890S transceiver.
- This system allows you, for example, to watch for and hunt DX while washing your car, or to operate the HF transceiver while relaxing in your car, living room, or patio, instead of actually operating inside your shack.



- Operation of Sky Command System II may not be permitted in certain countries. Check your local laws before operating.

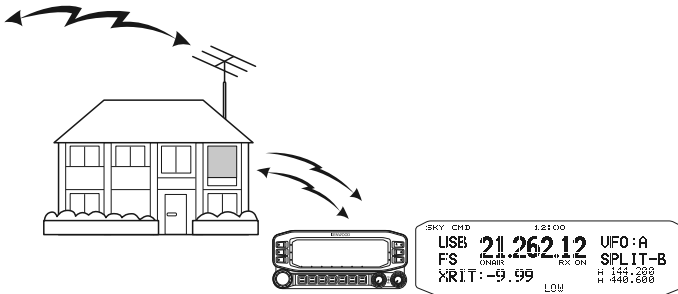

Sky Command System II Diagram

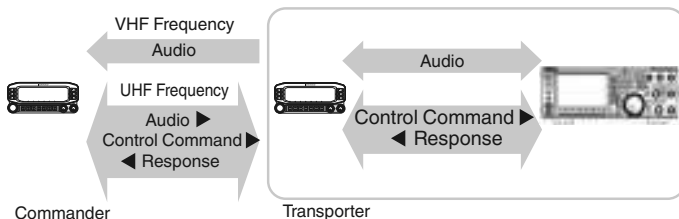

Preparation

Although you can use a TH-D7A, TH-D72(A/E)/ TM-D710/G(A/E), TM-V71A + RC-D710, or TM-D700A transceiver as a “Commander” (an external remote control unit), the following procedure shows how to set up your TS-890S and TH-D7A, TH-D72(A/E)/ TM-D710/G(A/E), TM-V71A + RC-D710, or TM-D700A transceivers as a “Transporter” at a base station and the TH-D72(A/E)/ TM-D710/G(A/E), TM-V71A + RC-D710, or TM-D700A transceiver as a “Commander”.

Starting Sky Command System II Operation

After you have completed setting up the following, you can start Sky Command System II operation. Without programming these parameters, you cannot use Sky Command System II.

TS-890S + TH-D7A/ TH-D72(A/E)/ TM-D700A/ TM-D710/G(A/E)/ TM-V71A + RC-D710 (Transporter) Setup

- 1 Configure the TH-D7A, TH-D72(A/E)/ TM-D710/G(A/E), TM-V71A + RC-D710, or TM-D700A as a “Transporter” and connect all the necessary cables to the TS-890S transceiver.
- 2 Select a frequency on the TS-890S transceiver.
- 3 On the TS-890S, press [MENU], then access Menu [7-00] (Baud Rate (COM Port)).
- 4 Select the desired communication speed.
- 5 Select the same communication parameters to match the TH-D7A, TH-D72(A/E)/ TM-D710/G(A/E), TM-V71A + RC-D710, or TM-D700A transceiver.
- 6 Press [MENU] to exit Menu mode.
- 7 Configure and start the Transporter mode on the TH-D7A, TH-D72(A/E)/ TM-D710/G(A/E), TM-V71A + RC-D710, or TM-D700A transceiver.
 - Refer to the respective instruction manuals of the TH-D7A, TH-D72(A/E)/ TM-D710/G(A/E), TM-V71A + RC-D710, or TM-D700A for information on how to connect, configure, and operate the transceivers for Sky Command System II.



17 MAINTENANCE AND ADJUSTMENT

Reset

Settings data that are stored on this transceiver can be saved easily to another data storage media. Also, when overwriting settings saved in the memory of this transceiver with new settings, 5 types of reset options are available which can be chosen freely according to the user's intentions.

Menu Reset:

Resets only the settings configured in the menu.

- The settings for TX inhibit, clock menu, LAN menu, advanced menu, linear amplifier menu, KNS menu, dimmer menu, timer menu and auto mode are not reset.

Memory Channel Reset:

Resets the settings data of the memory channels and quick memory channels.

VFO Reset:

Resets only the VFO information.

Standard Reset:

Resets the settings data while partially retaining the settings of this transceiver.

Full Reset:

Resets all settings to the factory settings.

 All image data that are stored in the built-in memory of the transceiver will be erased after Full Reset.

-  • Data of the memory channels and quick memory channels, menu data, antenna tuner preset values, auto mode frequency setting and the different level settings will not be reset during VFO Reset.
- When any of the reset options starts, all the past settings data will be erased. Thus, make sure to perform reset after saving the settings to another data storage media.
- In Menu [1-06], the default setting for auto voice guide is configured to OFF. When performing a reset other than Memory Channel Reset and VFO Reset, the settings in Menu [1-06] are reset and auto voice guide will not be output.

The transceiver is reset as follows.

- 1 Press F [RESET] on the menu screen to display the Reset screen.**



- 2 Press F2 [▲] / F3 [▼] or turn the [MULTI/CH] control to select a reset type.**

- 3 Press F4 [SELECT].**

A message to confirm the start of the reset process is displayed.



- Pressing **F7 [CANCEL]** clears the reset confirmation message without starting reset.

- 4 Press F4 [RESET].**

Reset is performed and this transceiver reboots automatically.

-  • When this transceiver cannot be operated properly or the screen cannot be displayed properly when the power is turned on, press **[A/B]** and **[CLR]** while turning on the power to perform Full Reset. A "Full Reset in progress" message is displayed and all settings are reset to the factory settings.

Firmware Update

There are occasions when the firmware is updated following additions or enhancements made to the functions.

The latest firmware version can be obtained from our company website.

http://www.kenwood.com/jp/faq/com/ts_890/

For more details on firmware update, please visit our website.

Firmware Version Check

Check the current firmware version before updating the firmware.

- **Check in Advanced Menu [27] "Firmware Version"**

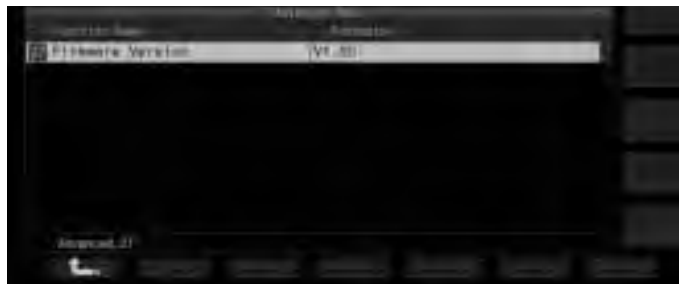

-  • If a "firmware update failed" screen constantly appears while update is in progress, this could be due to system failure. Please contact KENWOOD service center.

17 MAINTENANCE AND ADJUSTMENT

Calibration of Internal Reference Frequency

The internal reference frequency of this transceiver is preadjusted at the factory. However, if calibration of the internal reference frequency is necessary due to changes over time or other reasons, this can be done by receiving WWVH (Hawaii), WWV (Colorado), BPM (Xi'an) or other types of standard radio wave.

First of all, follow the steps below to set this transceiver to the mode for receiving the standard radio wave signals. The following is an example of the calibration procedure when the pitch frequency is 700 Hz.

- 1 Press [CW/ CW-R] to select CW mode.
- 2 Press [RIT] to turn off the RIT function.
- 3 Press [VOX] to turn off break-in.
 - If semi break-in is turned on, press [VOX] to turn it off.
 - If full break-in is turned on, turn the [DELAY] control to select a value other than full break-in.
- 4 Turn the [AF] control to move to the 12 o'clock position.
- 5 Turn the [MIC/PITCH] control to adjust the pitch to a level for easy listening.
Turn the [MIC/PITCH] control until the pitch frequency reading shows "700".
- 6 Turn the [LO/WIDTH] and [HI/SHIFT] controls.
Turn the [HI/SHIFT] control until the shift frequency (SHIFT) becomes "0", followed by turning the [LO/WIDTH] control to adjust the bandwidth (WIDTH) to "1000".



- For details on the REF I/O connector settings, please refer to "Switching the Reference Signal". (16-8)

Calibration Procedure

Once the preparation is complete, follow the steps below to configure the internal reference frequency of this transceiver.

- 1 Receive the standard radio wave signals.
To receive 10 MHz standard radio wave signals, turn the Tuning control to adjust the value to exactly "10.000.00". A 700 Hz beat is heard.

$$f_{AF} = \frac{f_{\text{display [MHz]}}}{19.2 \text{ [MHz]}} \times \Delta f_{\text{reference}} + 700 \text{ [Hz]}$$

$\Delta f_{\text{reference}}$: Reference Frequency Shift

Adjust such that the received beat is audible on the CW pitch frequency.

- 2 Press F [ADV.] on the menu screen to select Advanced Menu [05] "Reference Oscillator Calibration".
- 3 Press F4 [SELECT].



- 4 Press F7 [CAL.T].
A 700 Hz calibration sidetone is generated. This sidetone overlaps with the RX audio and a double beat is formed by the difference in frequency.
If the double beat is not clearly audible, turn the [AF] control to adjust the RX audio.

$$f_{\text{sidetone}} = 700 \text{ [Hz]} \pm 8 \text{ [ppm]} (700 \pm 0.006 \text{ [Hz]})$$

5 Press the F4 [-]/ F5 [+] or turn the [MULTI/CH] control.

- Perform adjustment until the cycle of the double beat between the RX beat and sidetone reaches the maximum and the double beat is no longer audible. At this point, the difference in frequency between the RX audio and sidetone is at the minimum level.
- To restore the default setting, press and hold F2 [(RESET)].

6 Release F7 [CAL.T].

7 Press [ESC] to end the process.



- If the signal used for calibration falls outside the range of the reference signal input from an external source (-10 dBm to +10 dBm) or frequency accuracy (10 MHz \pm 10 ppm), the internal reference frequency may not be calibrated correctly.

Adjusting the Touchscreen

Follow the steps below to adjust the contact points on the touchscreen to prevent false recognition when touching the touchscreen. Adjust the touchscreen if the frequency of false recognitions has increased with time.

- 1 Select Advanced Menu [23] “Touchscreen Calibration”.
- 2 Press F4 [SELECT].
- 3 Touch the “+” marks that are displayed on the screen in sequence.
A “+” mark is displayed in sequence at the four corners of the screen. After touching all the “+” marks at the four corners and the center, touchscreen adjustment is complete and the Advanced menu screen is displayed.

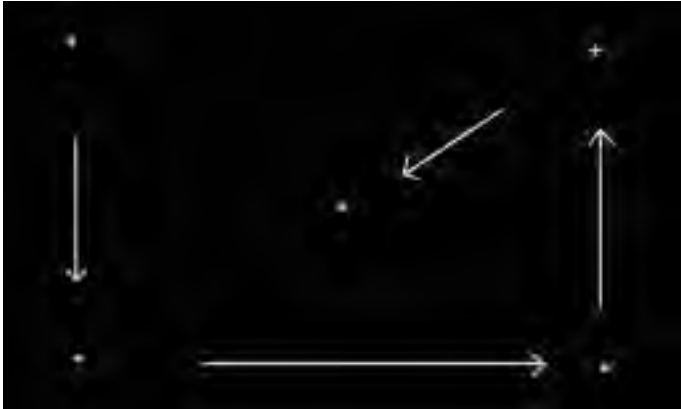

- Touchscreen adjustment cannot be performed during transmission.
- Touchscreen adjustment cannot be stopped halfway. Make sure to touch the “+” marks at the four corners and the center in sequence.
- If touchscreen adjustment is interrupted due to unforeseen circumstances such as power outage, perform the adjustment again.

Adjusting the Display Color

The color tone of the display can be adjusted as follows.

- 1 Turn off the power of this transceiver.
- 2 Pressing and holding [CLR] while turning on the power displays the display color adjustment screen.

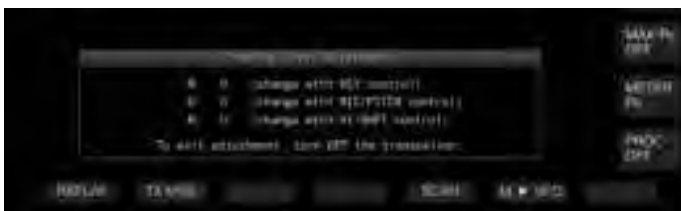

- 3 Use the controls below to adjust the color.

Control	Behavior
[KEY]	Changes the red level. (Turning the [DELAY] control resets the value to “0”.)
[MIC/PITCH]	Changes the green level. (Turning the [POWER] control resets the value to “0”.)
[HI/SHIFT]	Changes the blue level. (Turning the [LO/WIDTH] control resets the value to “0”.)

Setting Value	-15 to 0 (default) to +15 (1 step)
---------------	------------------------------------

- 4 Turn off the power of this transceiver.



- When this transceiver is operated with a control other than those above, the display color adjustment screen disappears temporarily and the adjusted color tone can be previewed on the normal screen.

Replacing the Fuse

- The circuit of this transceiver for connecting to an external antenna tuner comes with a fuse. If the fuse blows while using the external antenna tuner, replace the fuse after addressing the cause.
- There is also a fuse in the DC power cable. Similarly, if this fuse blows, replace it after addressing the cause.

Replacing the Fuse of the External Antenna Tuner

- 1 Unplug the DC power cable.
- 2 Remove the screws (x12) at the bottom case and remove the bottom case.
- 3 Remove the screws (x8) at the top case and remove the top case.
- 4 Remove the screws (x8) securing the shield plate and remove the shield plate.
- 5 Replace the fuse (4 A).

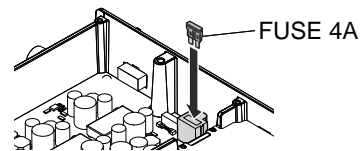

- 6 Install the shield plate.
- 7 Install the top case.
- 8 Install the bottom case.



- If only the top case is removed, scratches may result when aligning it with the bottom case during the assembly.
- The 4 A fuse that comes supplied with this transceiver is to be used for the external antenna tuner. Do not use a fuse other than the one supplied.



- Be careful not to misplace the screw after it is removed.
- Be careful when handling the case to prevent being injured by the edges.

Replacing the Fuse of the DC Power Cable

Open the fuse cover and replace the fuse (25 A).

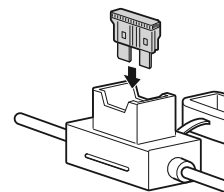

- The 25 A fuse that comes supplied with this transceiver is to be used for the DC power cable. Do not use a fuse other than the one supplied.



18 TROUBLESHOOTING

General Information

Your transceiver has been factory aligned and tested to specification before shipment. Under normal circumstances, the transceiver will operate in accordance with these operating instructions. All adjustable trimmers, coils, and resistors in the transceiver are preset at the factory. They should only be readjusted by a qualified technician who is familiar with this transceiver and has the necessary test equipment. Attempting service or alignment without factory authorization may void the transceiver warranty.

When operated properly, the transceiver will provide years of service and enjoyment without requiring further realignment. The information in this section gives some general service procedures requiring little or no test equipment.

Service

If it is ever necessary to return the equipment to your dealer or service center for repairs, pack the transceiver in its original box and packing material. Include a full description of the problems experienced. Include both your telephone number and fax number (if available) along with your name and address in case the service technician needs to call for further information while investigating your problem. Don't return accessory items unless you feel they are directly related to the service problem. Please do not send subassemblies or printed circuit boards. Send the complete transceiver.

You may return your transceiver for service to the authorized **KENWOOD** dealer from whom you purchased it or any authorized **KENWOOD** service center. A copy of the service report will be returned with the transceiver.

Tag all returned items with your name and call sign for identification. Please mention the model and serial number of the transceiver in any communication regarding the problem.

Service Note

If you desire to correspond on a technical or operational problem, please make your note short, complete, and to the point. Help us help you by providing the following:

- Model and serial number of equipment
- Question or problem you are having
- Other equipment in your station pertaining to the problem
- Meter readings
- Other related information (Menu setup, mode, frequency, key sequence to induce malfunction, etc.)



- Do not pack the equipment in crushed newspapers for shipment. Extensive damage may result during rough handling or shipping.



- Record the date of purchase, serial number, and dealer from whom the transceiver was purchased.
- For your own information, retain a written record of any maintenance performed on the transceiver.
- When claiming warranty service, please include a photocopy of the bill of sale or other proof-of-purchase showing the date of sale.

Cleaning

The keys, controls, and case of the transceiver are likely to become soiled after extended use. Remove the controls from the transceiver and clean them with a neutral detergent and warm water. To clean the case, use a neutral detergent (no strong chemicals) and a damp cloth.

18 TROUBLESHOOTING

Troubleshooting

Check the following before requesting for repair of the transceiver.

Problems Related to Reception and Transmission

Symptom	Probable Cause	Corrective Action	Refer to
Power does not turn on when [⏻] is pressed.	The power switch of the regulated DC power supply is not turned on.	Set the power switch to ON.	4-1
	The DC power cable is not correctly connected.	Check the DC power cable to ensure that the polarity is correct. (Red: +, black: -)	1-1
	The DC power cable is not fully inserted.	Ensure that the cable is fully inserted.	1-1
	The fuse of the DC power cable is blown.	Address the cause of the blown fuse and replace it with a new fuse according to the designated capacity.	17-3
	A voltage exceeding the 13.8 V DC \pm 15% range is applied.	Check the output voltage of the regulated DC power supply and configure it to the rated voltage (DC 13.8 V).	1-1
The screen is not displayed normally when this transceiver is powered on.	The microcomputer is malfunctioning.	Reset this transceiver.	17-1
A backup data damage detected screen is displayed.	The initialization data was not configured correctly for some unknown reason.	Press F4 [OK] on the "backup data damage detected screen" to perform Full Reset again.	
Signals cannot be received even when an antenna is connected. The RX sensitivity is low.	The squelch is closed.	Turn the [SQL] control and adjust accordingly.	4-2
	The attenuator is ON.	Set the attenuator to OFF.	6-1
	The preamplifier is OFF.	Set the preamplifier to ON.	5-6
	The antenna 1/2 selection is wrong.	Select the correct antenna.	4-10
	RX ANT is ON.	Check whether RX ANT is set to ON.	4-10
	Unable to perform tuning even though the antenna tuner is ON.	Press and hold [AT] to perform tuning. Alternatively, stop the tuning operation.	4-11
	The gain level is lowered using the [RF] control.	Turn the [RF] control all the way to the right.	4-2
	The transverter settings are not correctly configured.	If the transverter is ON, check whether the settings are correctly configured and whether it is functioning properly.	16-15
Signals received are not correctly demodulated.	The transverter is ON.	If the transverter is ON, check whether it is functioning properly.	16-15
	The operating mode is incorrectly selected.	Try switching to a different mode.	4-4
The frequency does not change when the [RIT]/[XIT] control is turned.	The AGC function settings are not correctly configured.	Configure the AGC function settings correctly.	5-2
	The RIT/XIT function is OFF.	Press [RIT] or [XIT] .	5-7
The cutoff frequency of the RX audio in the SSB mode is extremely high or extremely low.	The RX DSP filter settings are not suitable for operation.	Change them to the appropriate settings.	6-2
There is significant distortion in the audio.	The AGC function is OFF.	Set the AGC function to ON, or turn the [RF] control to adjust RF gain.	5-2
	The [AF] control is set to a loud volume level.	Turn the [AF] control to adjust the volume.	4-2
No sound is output from the speaker.	The [AF] control is turned all the way to the left.	Turn the [AF] control to the right.	4-2
	The [SQL] control is turned all the way to the right.	Turn the [SQL] control to the left.	4-2
	Headphones are connected.	Unplug the headphones.	1-2
	CTCSS is set to ON in the FM mode.	Set CTCSS to OFF.	5-30
The S meter deflection is small in the FM mode.	The S meter sensitivity level is low.	Configure the S meter sensitivity to "High" in Menu [0-07].	4-9
"SCP.OVF" is displayed on the bandscope.	The bandscope is receiving excessive signal.	Use the attenuator for the bandscope.	7-1

Symptom	Probable Cause	Corrective Action	Refer to
There is no TX output power. The level of TX output power is low.	The microphone connector is not fully inserted.	Insert the microphone connector fully.	1-2
	The antenna connector is not properly connected.	Connect the antenna properly.	2-6
	The microphone gain level is turned down.	Adjust the microphone gain.	4-7
	The TX output power is set to the minimum level.	Adjust the TX output power.	4-8
	High-temperature protection is activated.	End the transmission and allow the temperature of this transceiver to go down.	0
	The carrier level is low.	Turn the [CAR] control on the Carrier Level configuration screen until the pointer of the ALC meter falls within the appropriate range.	5-8
	The speech processor output level is low.	Turn the [MIC/PITCH] control until the pointer of the ALC meter falls within the appropriate range.	8-4
	The TX audio source used for transmission is different from the input path of the TX audio source input.	Check the input path of the TX audio to be modulated.	8-1
	Drive output (DRV) is enabled.	Press [DRV] to switch off drive output.	4-10
	The straight key or paddle is not correctly connected.	Check the connection.	1-2 1-3
	The transverter function is turned on.	Press [GENE] to cancel the transverter function.	16-15
	This transceiver is transmitting in a band (135 kHz or 475 kHz) that is not compatible with the output from the antenna connector.	Press [DRV] to output from the DRV connector (drive output).	16-15
There is no transmission. The PWR meter is not displayed.	The [PTT] switch is locked while it is ON when a desk microphone is used.	Turn off the PTT lock.	2-8
	The frequency has deviated from the amateur band.	Set the frequency to an amateur band.	4-3
	TX Inhibit is ON.	Configure TX Inhibit to "Off" in Menu [6-03].	16-11
Significant background noise can be heard when there is no sound during transmission in the SSB and AM modes.	Microphone gain is too high.	Carry out audio transmission while monitoring the ALC meter and adjust the microphone gain such that a small amount of ALC voltage is applied.	4-7
	The input level setting of the speech processor is high.	Turn the [MIC/PITCH] control until the pointer of the COMP meter falls within the appropriate range.	8-4
The VOX function is not functioning.	The VOX gain setting is too low.	Adjust the VOX gain.	8-1
	The anti VOX gain setting is too high.	Adjust the anti VOX gain.	8-2
Transmission starts by itself when this transceiver is not operated.	The VOX function is ON or the VOX gain level is not properly adjusted.	Set the VOX function to OFF or adjust the VOX gain level.	8-1
	The signal level of the TX audio source that is input from the rear panel terminal is high.	Lower the level of the signal input.	
	Audio signal is input from a connector for which the audio source setting of the TX audio is enabled and the same audio source is also specified for Data VOX.	Set Data VOX to OFF or review the audio source setting before adjusting the VOX gain level.	8-1
The receiving station has reported that the audio sound is distorted or clipped.	Microphone gain is high.	Use the TX monitor function or adjust the microphone gain while having the receiving station monitor the transmission.	4-7
	The input level of the speech processor is high.	Use the TX monitor function or adjust the speech processor input level while having the receiving station monitor the transmission.	8-4
The linear amplifier is not functioning.	The REMOTE connector is not properly connected.	Reconnect the connector properly.	16-13
	The audio source selected in Data VOX is different from the audio source input, or the input level of the input signal is low.	Check the Data VOX settings or check the input level of the input signal.	
	Control relay of the linear amplifier is turned off.	Configure to a setting suitable for the linear amplifier, such as "Active High + Relay Control" for "Keying Logic" in the Linear Amplifier menu.	16-14
When a linear amplifier is used for full break-in operation in the CW mode, the SWR may deteriorate suddenly or an abnormal ALC voltage may be applied when the linear amplifier starts up.	The linear amplifier in use requires some time to start up (TL-922, etc.).	Operate in the semi break-in mode by configuring to a setting that includes an appropriate delay time for the linear amplifier, such as "Active High + Relay Control" for "Keying Logic" in the Linear Amplifier menu.	16-13

18 TROUBLESHOOTING

Symptom	Probable Cause	Corrective Action	Refer to
AT-300 is not functioning.	It is connected to antenna input connector 2 (ANT 2).	Connect it to antenna input connector 1 (ANT 1).	4-12
	The fuse inside this transceiver is blown.	Check the fuse, address the cause and replace the blown fuse with a new one.	17-3
Modulation is too shallow. (FM mode)	Microphone gain is low.	Configure the microphone gain in Advanced Menu [10].	5-28
When a commercially available power meter is used, the TX output power reading for SSB is low compared to the other modes.	The peak power of SSB is not correctly measured.	To ensure correct measurement of the peak power for SSB, the use of devices such as an oscilloscope which are capable of displaying instantaneous waveforms is recommended. Commercially available power meters may not be able to measure the peak power fully in some cases. Please use them as reference values.	
Transmission is still held after AT tuning is complete.	TX hold after AT tuning is configured to ON.	Configure TX hold after AT tuning to OFF in Advanced Menu [9].	4-11
VFO scan does not start.	Program Scan is selected.	Configure all the settings for memory channels P0 to P9 to OFF in the Program Scan/VFO Scan configuration mode. Alternatively, press [VFO/PRG] to select VFO Scan.	10-1
Memory Scan is not functioning.	No data is registered in the memory channels.	Register data to the memory channels.	9-2
Group Scan is not functioning.	No data is registered in the memory channels within the group.	Register data to the memory channels of the corresponding group number.	10-3
	All the memory channels within the group are locked out.	Cancel the lockout for the memory channels to be scanned.	10-4
Memory Scan is only performed on specific channels.	Group Memory Scan is selected.	Reconfigure or cancel the group selection.	10-3
Voice guidance does not start automatically.	Auto voice guidance is OFF.	Configure auto voice guidance to "On" in Menu [1-06].	13-1
Voice guidance is not output automatically after Full Reset is performed.	Menu [1-06] is configured to "Off".	Turn on the power while pressing [PF A] , or configure Menu [1-06] to "On".	13-1
The [POWER] LED is blinking and the power of this transceiver does not turn on.	This transceiver is preparing to activate the program timer operation.	Wait for the program timer operation to start. To stop the program timer operation, press [⏻] for 4 seconds.	14-3
Program timer is not activated.	The timer operation is not configured to ON.	Check whether the timer operation has been temporarily turned off ("TIMER icon" goes off) by pressing F [TIMER] after the timer operation is configured to ON.	14-3
A firmware version confirmation screen is displayed and this transceiver does not start up.	The firmware of this transceiver cannot be detected.	Rewrite the firmware. If the same symptom persists after rewriting the firmware, please send an inquiry to KENWOOD service center together with the number that is displayed at the bottom right corner of the message.	17-1
Firmware cannot be updated.	The name of the zip file is changed.	Update the firmware without changing the name of the zip file. The file name may be changed if the file is downloaded to the PC multiple times.	
	The zip file is uncompressed.	Update the firmware without uncompressing the zip file.	

Problems Related to Data Communication, PC and Network

Symptom	Probable Cause	Corrective Action	Refer to
Errors and retries occur frequently during transmission in the DATA mode.	The audio output level of the auxiliary equipment is too high and modulation signals are distorted as a result.	Lower the output of the auxiliary equipment such that the ALC zone is not exceeded.	/
	The audio input sensitivity of the data communication terminal on this transceiver does not match the input signal.	Adjust the audio input sensitivity of the data communication terminal in menus [7-06] (USB) and [7-07] (ACC 2) such that the ALC zone is not exceeded.	16-7
	High-frequency signal sneaks in and causes distortion of the modulation signals. a. The auxiliary equipment uses the same regulated DC power supply as this transceiver. b. The antenna SWR is high. c. High-frequency signal from the antenna is induced by this transceiver. d. High-frequency signal sneaks in due to the high audio input sensitivity of the ACC 2 connector.	Introduce measures to prevent high-frequency signal from sneaking in. a. Use a different power supply for the auxiliary equipment and this transceiver. b. Perform antenna matching again. c. Try changing the earth of the antenna, this transceiver and the auxiliary equipment. d. Lower the audio input sensitivity of the ACC 2 connector in Menu [7-07].	16-7
Audio input to the data communication terminal is not transmitted.	The audio source input path setting does not match the terminal in use.	Press and hold [DATA] to configure the settings on the DATA mode audio source input screen.	8-1
	The method of transmission is not appropriate.	Transmit signals using one of the following methods. a. Transmit by controlling the PKS terminal of the ACC 2 connector. b. Transmit using the [PF] key configured for the DATA SEND function. c. Transmit using the "TX1;" PC command.	16-2
	The level of the audio input to the data communication terminal is low.	Raise the audio output level of the connected auxiliary equipment, or raise the audio input level of the terminal in use in menus [7-06] (USB) and [7-07] (ACC 2).	16-7
Errors occur frequently during reception in the DATA mode.	Decoding cannot be performed as the audio output level of the data communication terminal on this transceiver does not match the input level of the auxiliary equipment.	Adjust the audio output level of the terminal in use in menus [7-08] (USB) and [7-09] (ACC 2).	16-7
	There is multi-path distortion or fading at short intervals. (The RX signal strength is not necessarily the best when it is strongest.)	When using a beam antenna, change the orientation of the antenna to look for a position that is less likely to cause errors.	/
Unable to communicate with ARCP-890 or ARHP-890 using the COM port.	The baud rates do not match each other.	Check the baud rate of the TS-890S and ARCP-890.	16-5
	The COM port is unable to handle CTS/RTS.	Configure Advanced Menu "PSQ/PKS Pin Assignment (COM Connector)" so that the COM port can handle CTS/RTS.	16-8
Unable to communicate with ARCP-890 or ARHP-890 using the USB port.	The driver is not installed on the PC.	Download the driver from our website and install it on the PC.	16-5
	The correct driver is not installed on the PC because the PC is connected to this transceiver before the driver is installed.	Reinstall the driver.	16-5
	The baud rates do not match each other.	Check the baud rate of the TS-890S and ARCP-890.	16-5
	① Flow control is not configured. ② The COM ports of PC and ARCP/ARHP are not matching.	① Check that Advanced Menu "Virtual Standard COM Port - RTS" is configured to "Flow Control". ② Check that the COM port number assigned by the Device Manager of the OS for communication between this transceiver and ARCP/ARHP is the same as the number specified by ARCP/ARHP. (ARCP/ARHP uses the Standard COM port number displayed in the Device Manager of the OS.)	16-12
Unable to communicate with ARCP-890/ARHP-890 using the LAN port. (For operation within the LAN)	① The IP address cannot be acquired. ② The IP address of this transceiver is not configured in ARCP/ARHP. ③ The administrator ID, password and the LAN connection are not configured. ④ The users to be connected are not registered in the KNS user list.	① Same corrective actions as "Clock correction by the NTP server is not performed". ② Configure the IP address of this transceiver in the ARCP/ARHP. ③ Configure the administrator ID, password and "KNS Operation (LAN Connector)" in the KNS menu. ④ Register the information to the user list.	15-1

18 TROUBLESHOOTING

Symptom	Probable Cause	Corrective Action	Refer to
Unable to perform PC keying in the CW mode using the USB port. Or unable to transmit.	<ul style="list-style-type: none"> ① CW keying is not configured. ② PTT is not configured. ③ The PC application settings are wrong. 	<ul style="list-style-type: none"> ① Configure Advanced Menu "Virtual Enhanced COM Port - DTR" to CW keying. ② Configure Advanced Menu "Virtual Enhanced COM Port - RTS" to PTT. ③ Reconfigure the PC application settings as follows. <ul style="list-style-type: none"> a. Check that the COM port number assigned by the Device Manager of the OS for communication between this transceiver and the PC application is the same as the number specified by the PC application. b. Check that the keying output and PTT output are the same as those configured in ① and ② respectively. 	16-12
Unable to perform PC keying in the RTTY mode using the USB port. Or unable to transmit.	<ul style="list-style-type: none"> ① RTTY keying is not configured. ② PTT is not configured. ③ The PC application settings are wrong. 	<ul style="list-style-type: none"> ① Configure Advanced Menu "Virtual Enhanced COM Port - DTR" to RTTY keying. ② Configure Advanced Menu "Virtual Enhanced COM Port - RTS" to PTT. ③ Reconfigure the PC application settings as follows. <ul style="list-style-type: none"> a. Check that the COM port number assigned by the Device Manager of the OS for communication between this transceiver and the PC application is the same as the number specified by the PC application. b. Check that the keying output and PTT output are the same as those configured in ① and ② respectively. 	16-12
When this transceiver is connected to a PC with a USB cable, the COM port number assigned to the PC becomes larger.	When our transceiver (TH-D72/TS-590S/TS-590SG/TS-990S/TS-890S) is connected to a USB port that is different from the previously connected port, the OS will assign a new COM port.	With our transceiver unit connected to the PC, delete the unwanted COM port number from "Device Manager" of the OS. For more details, please refer to the website below. http://www.kenwood.com/i/products/info/amateur/software_download.html	/
Clock correction by the NTP server is not performed.	The IP address cannot be acquired.	Check whether the DHCP of this transceiver is configured to ON. Check whether the DHCP server function on the broadband router is configured to ON or whether it is functioning normally.	14-2
	The NTP server address is not configured.	Configure the NTP server address.	14-2
	NTP information is not transmitted from WAN.	Open the port of communication devices such as the broadband router to ensure that the port used for communicating with the NTP server is not blocked.	14-2
	LAN cable is not connected.	Check the LAN cable connection.	2-7
Date and time cannot be configured.	Auto clock correction is ON.	Set auto clock correction to OFF.	14-3
The USB flash drive cannot be recognized.	The USB flash drive is not formatted by this transceiver.	Format on this transceiver.	11-5
	Poor connection.	Connect the USB flash drive.	1-2
	The USB flash drive is security-enabled.	This transceiver does not support security-enabled USB flash drive.	11-1
	The USB flash drive is damaged.	Check on the PC to determine whether the USB flash drive connected to this transceiver is functioning properly.	/
	The USB flash drive in use does not conform to the USB specifications.	Use a USB flash drive that conforms to the USB specifications.	11-1
	Multiple USB flash drive devices are connected.	Use only the USB flash drive that is first recognized by this transceiver.	/
	The file system of the USB flash drive is corrupted.	Format on this transceiver.	11-5

Symptom	Probable Cause	Corrective Action	Refer to
Unable to write files to the USB flash drive.	The USB flash drive is write-protected.	Remove the write protection.	
	The USB flash drive is not formatted by this transceiver.	Format on this transceiver.	11-5
	Poor connection.	Reconnect the USB flash drive.	1-2
	The USB flash drive is security-enabled.	This transceiver does not support security-enabled USB flash drive.	11-1
	The USB flash drive is damaged.	Check on the PC to determine whether the USB flash drive connected to this transceiver is functioning properly.	
	The USB flash drive in use does not conform to the USB specifications.	Use a USB flash drive that conforms to the USB specifications.	11-1
	The file system of the USB flash drive is corrupted.	Format on this transceiver.	11-5
	There is no remaining space available.	Use a USB flash drive with sufficient remaining space.	
	There are too many files in a folder.	Not more than 255 files can be stored in each folder. Delete the unwanted files and before saving.	11-1
USD flash drive formatting failed.	Formatting of the USB flash drive started while << [] >> was blinking and formatting failed.	Follow the procedures in "Safely Removing the USB Flash Drive" to safely remove the USB flash drive followed by inserting it again to format it.	11-5
Steps to safely remove the USB flash drive failed.	Safe removal failed for some unknown reason.	Turn off the power of this transceiver and remove the USB flash drive. Some data may not be saved depending on the data processing status of this transceiver.	11-1
<< [] >> continues to blink for several minutes.	The USB flash drive is not recognized by this transceiver.	Format on this transceiver.	11-5
No output to the external monitor.	The output of the external display is OFF.	Configure the output of the external display to ON in Advanced Menu [21].	16-7
No output to the external monitor during startup.	Depending on the specifications of the monitor in use, delay in the display may occur when this transceiver is powered on.	Wait for the startup screen of this transceiver to disappear.	
No output to the external monitor.	"Display Off" is selected for the screen saver type.	Configure the screen saver type to "Off".	
RX audio from the PC cannot be heard (during USB/ACC 2 connection).	The microphone setting on the OS is configured to monaural.	When using a Windows PC, wait for the PC to recognize this transceiver, then select Control Panel → Hardware and Sound → Sound → Recording → Microphone (USB Audio CODEC) → Properties, followed by selecting "2 channel".	

Troubles Related to Recording and Playback

Symptom	Probable Cause	Corrective Action	Refer to
A message is displayed when [] is pressed during timer recording.	Timer recording is in progress.	To stop timer recording and allow this transceiver to be operated, press and hold F4 [(BREAK)] . To continue with timer recording, press [].	14-3
A file is created after executing timer recording but the RX audio cannot be heard.	The mute function is ON when timer recording is performed.	Check whether the mute function is ON when timer recording is performed. RX audio will not be recorded if mute is ON.	14-3
Voice messages cannot be recorded.	The input path for the audio is not correctly configured.	Check on the voice message recording standby screen to ensure that the audio input path is correct and the level is not too high or too low.	12-1
The voice message repeat interval is not functioning.	An attempt has been made to execute repeat interval for playing back voice messages only.	Repeat interval functions during playback with transmission. It does not function during playback without transmission.	12-2
	Repeat is turned off.	Configure repeat to ON for the channel to repeat.	12-2
RX audio can only be recorded for 30 seconds.	Full-time recording is enabled.	Full-time recording records only up to 30 seconds regardless of the destination for saving the file.	12-3
WAV files cannot be played.	The format is not supported by this transceiver.	The format supported by this transceiver is as follows. No. of channels: 1 (monaural), No. of bits: 16, sampling frequency: 16 kHz	
The playback volume is very soft.	The [AF] control is turned all the way to the left.	Turn the [AF] control to the right to adjust the volume.	4-2

18 TROUBLESHOOTING

Error Messages

The following error messages are displayed when an abnormality is detected on this transceiver. Follow the steps described for each error message to resolve the problem.

ID	Message	Description/Corrective Action
0012	Configurations for the Local Clock have not been completed. (ERR: 0012) Associated functions cannot be used until the timer configurations have been completed.	Appears when attempting to launch the program timer while a local clock is not configured. Configure the local clock in Clock menus [00] to [03].
0015	Connection to an NTP server has failed. (ERR: 0015) Ensure that the NTP server address and the network have been correctly configured.	Appears when date/time data cannot be successfully acquired from the NTP server. Follow the instructions in the error message.
001B	A file is invalid. (ERR: 001B)	Appears when a file error is detected while reading a file that contains the RX equalizer, TX equalizer and settings data.
001C	An error occurred while a file was being read from a USB flash drive. (ERR: 001C)	Appears when a file error is detected while reading a file stored in the USB flash drive that contains the RX equalizer, TX equalizer and settings data.
002F	A USB flash drive cannot be detected. (ERR: 002F) Failure to detect the USB flash drive may be caused by the following: <ul style="list-style-type: none"> The USB flash drive is not correctly connected to a USB connector. The USB flash drive is not in the specified format. The USB flash drive must be formatted in the "USB/File Management" screen. 	Appears when some unknown problem has occurred on the USB flash drive. Follow the instructions in the error message.
0030	An error occurred while a file is being written to an internal memory area or a USB flash drive. (ERR: 0030)	Appears when the file name is duplicated or an unexpected error has occurred. Follow the instructions in the error message.
003B	Failure in Deleting of a File. (ERR: 003B)	Appears when the deletion of file failed. Make sure the USB flash drive is not write-protected.
003C	Safe Removal of USB Flash Drive was failed. (ERR: 003C) The data file may not be stored onto the USB flash drive. Turn OFF the DC power supply, and then disconnect the USB flash drive.	Appears when some problem has occurred while unmounting the USB flash drive. Follow the instructions in the error message.
003E	A failure in detecting the firmware file will terminate the firmware updating process. (ERR: 003E) The termination of the firmware update may be caused by the following: <ul style="list-style-type: none"> The firmware file is not stored in the specified folder. The USB flash drive is not in the specified format. The USB flash drive must be formatted in the "USB/File Management" screen. The newer version firmware has already been applied to the transceiver. The firmware file is not legitimate. Restart the transceiver and then execute the firmware update again from the beginning.	Appears when some unknown problem has occurred while reading the firmware file. Follow the instructions in the error message.
003F	The selected file cannot be read by this transceiver with the earlier version firmware installed. (ERR: 003F) Update the transceiver firmware using the latest version of the firmware.	Appears when attempting to read a settings file written by a transceiver installed with a new firmware using a transceiver with an old firmware. Follow the instructions in the error message.
0040	A failure in updating the firmware terminates the firmware updating process. (ERR: 0040) Refer to "Troubleshooting" in the instruction manual.	Appears when some unknown problem has occurred while rewriting the firmware file.
0046	The storage location cannot be changed while an audio recording. (ERR: 0046)	Appears when attempting to change the destination for saving the file while manual recording is in progress.
0047	The storage location cannot be changed while a CW QSO log recording. (ERR: 0047)	Appears when attempting to change the destination for saving the file while CW communication log recording is in progress.
0048	The storage location cannot be changed while a RTTY QSO log recording. (ERR: 0048)	Appears when attempting to change the destination for saving the file while RTTY communication log recording is in progress.

ID	Message	Description/Corrective Action
0049	The storage location cannot be changed while a PSK QSO log recording. (ERR: 0049)	Appears when attempting to change the destination for saving the file while PSK communication log recording is in progress.
004D	Audio files cannot be copied while an audio recording. (ERR: 004D)	Appears when attempting to copy files to a PC or USB while manual recording is in progress.
004E	Communication log files (CW) cannot be copied while a CW QSO log recording. (ERR: 004E)	Appears when attempting to copy files to a PC or USB while CW communication log recording is in progress.
004F	Communication log files (RTTY) cannot be copied while a RTTY QSO log recording. (ERR: 004F)	Appears when attempting to copy files to a PC or USB while RTTY communication log recording is in progress.
0050	Communication log files (PSK) cannot be copied while a PSK QSO log recording. (ERR: 0050)	Appears when attempting to copy files to a PC or USB while PSK communication log recording is in progress.
0051	KNS log files cannot be copied while a KNS log recording. (ERR: 0051)	Appears when attempting to copy files to a PC or USB while KNS log recording is in progress.
0055	Audio files cannot be deleted while an audio recording. (ERR: 0055)	Appears when attempting to delete files while manual recording is in progress.
0056	Communication log files (CW) cannot be deleted while a CW QSO log recording. (ERR: 0056)	Appears when attempting to delete files while CW communication log recording is in progress.
0057	Communication log files (RTTY) cannot be deleted while a RTTY QSO log recording. (ERR: 0057)	Appears when attempting to delete files while RTTY communication log recording is in progress.
0058	Communication log files (PSK) cannot be deleted while a PSK QSO log recording. (ERR: 0058)	Appears when attempting to delete files while PSK communication log recording is in progress.
0059	KNS log file cannot be deleted while a KNS log recording. (ERR: 0059)	Appears when attempting to delete files while KNS log recording is in progress.
005B	Copying was aborted due to the number of files exceeded 255 in the destination folder. (ERR: 005B) Reduce the number of files in UBS flash drive and then copy again.	Appears when the number of files at the copy destination has exceeded the maximum limit of 255 files while copy is in progress.
005C	The selected file cannot be read by this transceiver. (ERR: 005C)	The transceiver type does not match the transceiver type that created the settings data file.
0103	The current sourced from the USB connector exceeds the upper limit value. (ERR: 0103) Remove the USB device and then restart the transceiver.	Appears when overcurrent is detected at the USB connector. Disconnect unused USB devices.
0105	PLL unlock was detected. (ERR: 0105) Refer to "Troubleshooting" in the instruction manual.	Perform Full Reset. If PLL unlock is still detected after Full Reset, note down the error message number (ERR:0105) and send an inquiry to KENWOOD service center.
0107	No reference signal has been detected. (ERR: 0107) Ensure that the reference signal has been sourced to the REF IN (10 MHz) connector.	Appears when there is no reference signal input from an external source. Check whether there is signal input to the REF IN terminal and whether the level of the signal is high enough.
0109	Corruption of the data was detected. (ERR: 0109) Executing the Full Reset will initialize the transceiver to the defaults. Press [OK] (F) to start the Full Reset.	Appears when damage is found in the backup data. Press F [OK] to perform Full Reset.
010A to 010F, 0110 to 0115	A DSP error was detected. (ERR: 010A to 010F, 0110 to 0115) Refer to "Troubleshooting" in the instruction manual.	Perform Full Reset. If the same error message appears again after Full Reset, note down the error message number (ERR: 010A to 010F, 0110 to 0115) and send an inquiry to KENWOOD service center.
0117	A hardware error was detected. (ERR: 0117) Refer to "Troubleshooting" in the instruction manual.	Perform Full Reset. If the same error message appears again after Full Reset, note down the error message number (ERR:0117) and send an inquiry to KENWOOD service center.



- Turn off the power of the regulated DC power supply after "A system error has occurred." message is displayed.
- If error occurs frequently, try updating to the latest firmware. If the same problem persists, this transceiver could be faulty. Please contact KENWOOD service center.

18 TROUBLESHOOTING

Warning Messages

The following warning messages are displayed in the event of an erroneous operation or when a problem on this transceiver is detected. Follow the steps described for each warning message to resolve the problem. If "Troubleshooting" is indicated in the warning message or when the problem cannot be resolved, please refer to the list of error messages and troubleshooting section.

ID	Message	Description/Corrective Action
000C	This audio file cannot be reproduced. (WR: 000C)	Appears when the format of the wav file is not supported by this transceiver. Check the file format on a PC to see if the file is in the wav format that can be played on this transceiver.
0031	Due to insufficient memory of the data storage or the write protection of the USB flash drive, the data storing process was terminated. (WR: 0031) Ensure that there is sufficient memory and that data storage has been enabled.	Appears when the maximum number of files in each folder has been exceeded, insufficient memory space or writing forbidden is detected when writing a file.
0032	Selects the days of the week. (WR: 0032)	Appears when [OK] is pressed with all the days of the week unchecked on the program timer configuration screen.
0033	A maximum of 4 hours of recording time can be configured. (WR: 0033) Ensure that the Power-on Time and Power-off time are appropriate.	Appears when [OK] is pressed with the time limit exceeded when configuring the Power-on Time and Power-off Time on the program timer configuration screen.
0034	The same clock time cannot be configured for both the Power-on Time and Power-off Time. (WR: 0034) Ensure that the Power-on Time and Power-off Time are appropriate.	Appears when [OK] is pressed with an invalid time range configured for this transceiver on the program timer configuration screen.
0039	Failure in formatting of a USB flash drive has been detected. (WR: 0039) The failure may be caused by one or more of the following: <ul style="list-style-type: none"> • The write protected USB flash drive is connected to a USB connector. • The USB flash drive is not correctly connected to a USB connector. • The security-protected USB flash drive is connected to a USB connector. 	Appears when formatting of the USB flash drive failed. Follow the instructions in the message.
0043	The file cannot be accessed while recording data.	Appears when attempting to read a log file for which recording is currently in progress.
004A	Select copy item. (WR: 004A)	Appears when attempting to copy files to a PC with all the files unchecked on the screen for selecting the files to copy.
0053	Select delete item. (0053)	Appears when attempting to delete files while all the files are unchecked on the screen for selecting the files to delete.
0101	The Programmable Timer is about to start recording the received audio. (WR: 0101) The recording can begin if the transceiver has been turned OFF. If the USB flash drive has selected as the file storage location, connect a USB flash drive to the USB connector before recording starts.	Appears when the power of this transceiver is turned on approximately 3 minutes and 1 minute before timer recording starts. Follow the instructions in the message.
0102	Recording by the Programmable Timer.(WR: 0102) To stop recording, press and hold [(BREAK)] (F).	Appears when [⏻] is pressed and held down during timer recording while the screen is turned off.
0104	High temperature has been detected in the transmitter. Refer to "Troubleshooting" in the instruction manual (WR: 0104). To prevent the transmitter from being damaged, the transmit power has been reduced to 5 W.	Stop the transmission and allow the temperature of this transceiver to go down.
0106	Very high temperature has been detected in the transceiver. Refer to "Troubleshooting" in the instruction manual (WR: 0106). Transmission capability is disabled until the transceiver cools down.	Is the ambient temperature of this transceiver high (such as when the transceiver is exposed to direct sunlight)? Please operate it in a well-ventilated place.

Internal Beats

Internal beats may occur within some of the amateur band frequencies. This is due to the frequency configuration of this transceiver and is not a malfunction.

Spurious Signals on the Bandscope

Signals that are unrelated to the RX signals may sometimes appear on the bandscope (waterfall). This is due to the frequency configuration of this transceiver and is not a malfunction. Adjusting the reference level or attenuator of the bandscope may sometimes help to minimize the appearance of spurious signals.

Example:

- A frequency that is +24 kHz or -24 kHz away from the RX frequency
- A frequency that is +150 kHz or -150 kHz away from the RX frequency (The spurious signal varies depending on the RX band and mode.)
- When internal beats are received



19 OTHERS

Optional Accessories

- ARCP-890.....Radio Control Program (Free software)
- ARHP-890.....Radio Host Program (Free software)
- ARVP-10.....VoIP Program (Freeware)
- ARUA-10.....USB Audio Controller (Freeware)
- SP-890.....External Speaker
- YG-82CN-1.....270 Hz CW Filter
- HS-5.....Open-air Headphones
- HS-6.....Light Weight Headphones
- MC-43S.....Hand Microphone
- MC-60A.....Desk Microphone
- MC-90.....Desk Microphone
- PS-60.....Regulated DC Power Supply (22.5 A)



- The ARCP-890 Radio Control Program, ARHP-890 Radio Host Program, ARVP-10 VoIP Program and ARUA-10 USB Audio Controller can be downloaded from the following web site.
http://www.kenwood.com/i/products/info/amateur/software_download.html
- Optional accessories that can be used along with this transceiver may from time to time be added or discontinued.
Refer to the JVC KENWOOD web site and catalog for details of the optional accessories.

Installing the YG-82CN-1 Roofing Filter

1 Remove the bottom case.

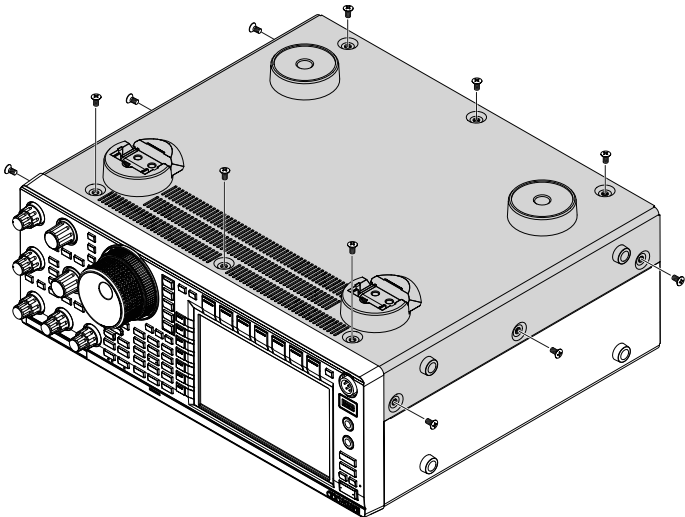

2 Remove the shield plate of the TX/RX unit.

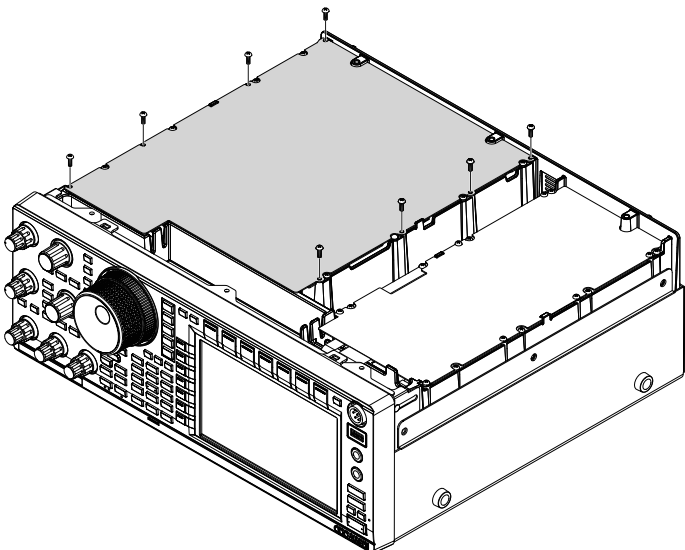

3 Insert YG-82CN-1 into the socket.

- There is a supplied filter on the board panel and the 3 sockets for YG-82CN-1 are located just in front of it.



- Align the direction of the supplied filter with that of the KENWOOD logo (● mark at the top left) and insert the pins at the bottom of the YG-82CN-1 board into the sockets.
- Align the pins at the bottom of the YG-82CN-1 board with the sockets and insert YG-82CN-1.



- To remove YG-82CN-1, hold the YG-82CN-1 board at the two sides and pull it out.

4 Stick the cushion that is supplied with YG-82CN-1 on the shield plate of the TX/RX unit.

- Stick the cushion at the location indicated by the guide on the back of the shield plate.

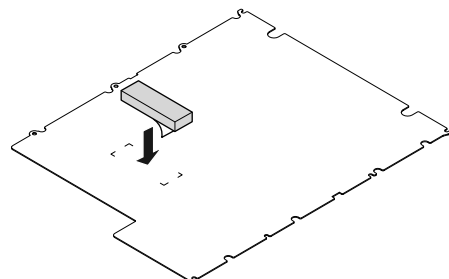

5 Install the shield plate of the TX/RX unit and the bottom case.

19 OTHERS

Specifications

General		
Frequency range (Transmitter)	160 m band	1.8 to 2.0 MHz (K type)/ 1.81 to 2.0 MHz (E type)
	80 m band	3.5 to 4.0 MHz (K type)/ 3.5 to 3.8 MHz (E type)
	60 m band	5.1675 MHz (K type) 5.25 to 5.45 MHz (E type: Refer to applicable Amateur Radio regulations to your country.)
	40 m band	7.0 to 7.3 MHz (K type)/ 7.0 to 7.2 MHz (E type)
	30 m band	10.1 to 10.15 MHz
	20 m band	14.0 to 14.35 MHz
	17 m band	18.068 to 18.168 MHz
	15 m band	21.0 to 21.45 MHz
	12 m band	24.89 to 24.99 MHz
	10 m band	28.0 to 29.7 MHz
	6 m band	50.0 to 54.0 MHz (K type)/ 50.0 to 52.0 MHz (E type)
4 m band	70.0 to 70.5 MHz (E type: Refer to applicable Amateur Radio regulations to your country.)	
Frequency range	0.1 to 30 MHz, 50 to 54 MHz VFO: Continuous 30 kHz to 60 MHz/ 74.8 MHz (E type)	
Mode	J3E (LSB, USB)/ A1A (CW)/ A3E (AM)/ F3E (FM)/ F1B (FSK)/ G1B (PSK)	
Frequency stability	±0.1 ppm (0°C to +50°C)	
Antenna impedance	50 Ω	
Antenna tuneable range	16.7 Ω to 150 Ω	
Microphone impedance	600 Ω	
Supply voltage	DC 13.8 V ±15%	
Grounding method	Negative ground	
Current	Transmit	22.5 A or less
	Receive	3 A or less
Usable temperature range	0°C to +50°C (+32 °F to +122 °F)	
Dimensions	Projections not included	W396.0 × H141.3 × D340.0 mm (W15.59 × H5.56 × D13.39 in)
	Projections included	W409.6 × H158.3 × D387.4 mm (W16.13 × H6.23 × D15.25 in)
Weight	Approx. 17 kg (37.5 lbs)	

Transmitter		
Output power	CW/SSB/FSK/PSK/FM (AM)	100 W (50 W)/ 70 MHz: 50 W (12.5 W)
Modulation	SSB: Balanced, AM: Low Power, FM: Reactance	
Maximum frequency deviation (FM)	Wide: ±5 kHz or less, Narrow: ±2.5 kHz or less	
Spurious emissions	HF (Harmonics): -50 dB or less 50 MHz: -63 dB or less 70 MHz: -60 dB or less	
Carrier suppression	-60 dB or less	
Unwanted sideband suppression	-60 dB or less	
Transmit frequency response	Within -6 dB (300 to 2700 Hz)	
XIT shift frequency range	±9.999 kHz	

Receiver		
Circuit type		Double conversion superheterodyne
Intermediate frequency	1st IF	8.248 MHz
	2nd IF	24 kHz (except FM), 36 kHz (FM)
Sensitivity (Typical)	SSB/ CW/ FSK/ PSK (S/N 10 dB)	0.5 μ V (0.1 to 0.522 MHz) 4 μ V (0.522 to 1.705 MHz) 0.2 μ V (1.705 to 24.5 MHz) 0.13 μ V (24.5 to 30.0 MHz) 0.13 μ V (50.0 to 54.0 MHz) 0.13 μ V (70.0 to 70.5 MHz)
	AM (S/N 10 dB)	6.3 μ V (0.13 to 0.522 MHz) 31.6 μ V (0.522 to 1.705 MHz) 2 μ V (1.705 to 24.5 MHz) 1.3 μ V (24.5 to 30.0 MHz) 1.3 μ V (50.0 to 54.0 MHz) 1.3 μ V (70.0 to 70.5 MHz)
	FM (12 dB SINAD)	0.22 μ V (28.0 to 30.0 MHz) 0.22 μ V (50.0 to 54.0 MHz) 0.22 μ V (70.0 to 70.5 MHz)
Squelch sensitivity	SSB/ CW/ FSK/ AM	5.6 μ V or less (0.13 to 0.522 MHz) 18.0 μ V or less (0.522 to 1.705 MHz) 1.8 μ V or less (1.705 to 30 MHz) 1.1 μ V or less (50.0 to 54.0 MHz) 1.1 μ V or less (70.0 to 70.5 MHz)
	FM	0.2 μ V or less (28.0 to 30.0 MHz) 0.2 μ V or less (50.0 to 54.0 MHz) 0.2 μ V or less (70.0 to 70.5 MHz)
Spurious response	Image ratio	70 dB or more (HF), 60 dB or more (50/ 70 MHz),
	IF rejection	70 dB or more
Selectivity	SSB/ FSK/ PSK	2.4 kHz or more (-6 dB), 4.4 kHz or less (-60 dB)
	CW	500 Hz or more (-6 dB), 1.2 kHz or less (-60 dB)
	AM	6.0 kHz or more (-6 dB), 12.0 kHz or less (-50 dB)
	FM	12.0 kHz or more (-6 dB), 25.0 kHz or less (-50 dB)
RIT shift frequency range		\pm 9.999 kHz
Notch filter attenuation		70 dB or more
Beat cancel attenuation (at 1 kHz)		40 dB or more
Audio output		1.5 W (8 Ω)
Audio output impedance (EXT.SP)		8 Ω

Specifications are subject to change without notice due to advancements in technology.

KENWOOD

© 2018 JVCKENWOOD Corporation