

# JVC



## COMPACT COMPONENT SYSTEM

# EX-D11

Consists of CA-EXD11 and SP-EXD11

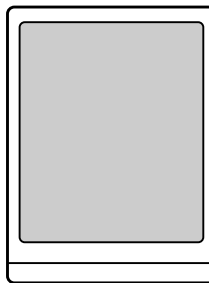
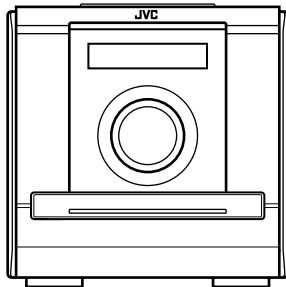
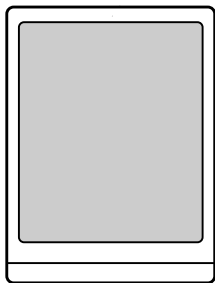
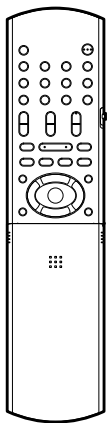

WOOD CONE



## INSTRUCTIONS

**For Customer Use:**

Enter below the Model No. and Serial No. which are located either on the rear, bottom or side of the cabinet. Retain this information for future reference.

Model No. \_\_\_\_\_

Serial No. \_\_\_\_\_

GNT0066-001A

[J]

# Warnings, cautions and others Mises en garde, précautions et indications diverses

**CAUTION**

RISK OF ELECTRIC SHOCK  
DO NOT OPEN

CAUTION: TO REDUCE THE RISK OF ELECTRIC SHOCK,  
DO NOT REMOVE COVER (OR BACK).  
NO USER SERVICEABLE PARTS INSIDE.  
REFER SERVICING TO QUALIFIED SERVICE PERSONNEL.

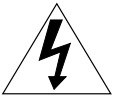

The lightning flash with arrowhead symbol, within an equilateral triangle is intended to alert the user to the presence of uninsulated "dangerous voltage" within the product's enclosure that may be of sufficient magnitude to constitute a risk of electric shock to persons.



The exclamation point within an equilateral triangle is intended to alert the user to the presence of important operating and maintenance (servicing) instructions in the literature accompanying the appliance.

**WARNING: TO REDUCE THE RISK OF FIRE OR ELECTRIC SHOCK, DO NOT EXPOSE THIS APPLIANCE TO RAIN OR MOISTURE.**

### CAUTION

To reduce the risk of electrical shocks, fire, etc.:

1. Do not remove screws, covers or cabinet.
2. Do not expose this appliance to rain or moisture.

### ATTENTION

Afin d'éviter tout risque d'électrocution, d'incendie, etc.:

1. Ne pas enlever les vis ni les panneaux et ne pas ouvrir le coffret de l'appareil.
2. Ne pas exposer l'appareil à la pluie ni à l'humidité.

### CAUTION — (Standby/on) button!

Disconnect the mains plug to shut the power off completely (the STANDBY lamp goes off). When installing the apparatus, ensure that the plug is easily accessible.

The (Standby/on) button in any position does not disconnect the mains line.

- When the system is on standby, the STANDBY lamp lights red.
- When the system is turned on, the STANDBY lamp goes off.

The power can be remote controlled.

### ATTENTION—Touche (attente/sous tension)

Déconnectez la fiche secteur pour mettre l'appareil complètement hors tension (le témoin STANDBY I s'éteint). Lors de l'installation de l'appareil, assurez-vous que la fiche soit facilement accessible.

La touche (attente/sous tension) dans n'importe quelle position ne déconnecte pas l'appareil du secteur.

- Quand l'appareil est en mode d'attente, le témoin STANDBY est allumé en rouge.
- Quand l'appareil est sous tension, le témoin STANDBY s'éteint.

L'alimentation ne peut pas être commandée à distance.

### Note to CATV system installer:

This reminder is provided to call the CATV system installer's attention to Section 820-40 of the NEC which provides guidelines for proper grounding and, in particular, specifies that the cable ground shall be connected to the grounding system of the building, as close to the point of cable entry as practical.

### Caution

Changes or modifications not approved by JVC could void the user's authority to operate the equipment.

### Attention

Des changements ou modifications non approuvés par JVC pourront invalider l'autorité de l'utilisateur à opérer cet appareil.



[European Union only]

[Union européenne seulement]

### FOR U.S.A.

This equipment has been tested and found to comply with the limits for a Class B digital device, pursuant to part 15 of the FCC Rules. These limits are designed to provide reasonable protection against harmful interference in a residential installation. This equipment generates, uses and can radiate radio frequency energy and, if not installed and used in accordance with the instructions, may cause harmful interference to radio communications. However, there is no guarantee that interference will not occur in a particular installation. If this equipment does cause harmful interference to radio or television reception, which can be determined by turning the equipment off and on, the user is encouraged to try to correct the interference by one of the following measures:

Reorient or relocate the receiving antenna.

Increase the separation between the equipment and receiver.

Connect the equipment into an outlet on a circuit different from that to which the receiver is connected.

Consult the dealer or an experienced radio/TV technician for help.

### For Canada/pour le Canada

THIS DIGITAL APPARATUS DOES NOT EXCEED THE CLASS B LIMITS FOR RADIO NOISE EMISSIONS FROM DIGITAL APPARATUS AS SET OUT IN THE INTERFERENCE-CAUSING EQUIPMENT STANDARD ENTITLED "DIGITAL APPARATUS", ICES-003 OF THE DEPARTMENT OF COMMUNICATIONS.

CET APPAREIL NUMERIQUE RESPECTE LES LIMITES DE BRUITS RADIOELECTRIQUES APPLICABLES AUX APPAREILS NUMERIQUE DE CLASSE B PRESCRITES DANS LA NORME SUR LE MATERIEL BROUILLEUR: "APPAREILS NUMERIQUE", NMB-003 EDICTEE PAR LE MINISTRE DES COMMUNICATIONS.

### Declaration of Conformity:

Trade Name: JVC

Model Number: EX-D11

Responsible Party: JVC American Corp.

Address: 1700 Valley Road, Wayne  
New Jersey 07470

Telephone Number: 973-317-5000

This device complies with Part 15 of the FCC Rules.

Operation is subject to the following two conditions:

- (1) This device may not cause harmful interference.
- (2) This device must accept any interference received, including interference that may cause undesired operation.

### IMPORTANT FOR LASER PRODUCTS

#### 1. CLASS 1 LASER PRODUCT

2. **CAUTION:** Do not open the top cover. There are no user serviceable parts inside the unit; leave all servicing to qualified service personnel.

#### 3. CAUTION:

(For U.S.A.) Visible and/or invisible class II laser radiation when open. Do not stare into beam.

(For Canada) Visible and/or invisible class 1M laser radiation when open. Do not view directly with optical instruments.

4. REPRODUCTION OF LABEL: CAUTION LABEL, PLACED INSIDE THE UNIT.

### IMPORTANT POUR PRODUITS LASER

#### 1. PRODUIT LASER CLASSE 1

2. **ATTENTION:** N'ouvrez pas le couvercle supérieur. Il n'y a aucune pièce réparable par l'utilisateur à l'intérieur de l'appareil; confiez toute réparation à un personnel qualifié.

#### 3. ATTENTION:

(Pour les Etats-Unis) Radiation laser de classe II visibles et/ou invisible si l'appareil est ouvert. Ne regardez pas le rayon.

(Pour le Canada) Rayonnement laser visible et/ou invisible de classe 1M une fois ouvert. Ne pas regarder directement avec des instruments optiques.

4. REPRODUCTION DE L'ÉTIQUETTE: ÉTIQUETTE DE PRÉCAUTION PLACÉE À L'INTERIEUR DE L'APPAREIL.

CAUTION	ATTENTION	AVISO	WARNING	注意	CAUTION
VISIBLE AND/OR INVISIBLE CLASS II LASER RADIATION WHEN OPEN. DO NOT VIEW DIRECTLY WITH OPTICAL INSTRUMENTS. (EN) (EN) (EN) (EN)	RADIATION LASER DE CLASSE II VISIBLE ET/OU INVISIBLE DE CLASSE II. NE PAS REGARDER DIRECTEMENT AVEC INSTRUMENTS OPTIQUES. (FR) (FR) (FR) (FR)	RADIACION LASER DE CLASE II VISIBLE E/ O INVISIBLE. NO MIRAR DIRECTAMENTE CON INSTRUMENTOS OPTICOS. (ES) (ES) (ES) (ES)	VISIBLE AND/OR INVISIBLE CLASS II LASER RADIATION WHEN OPEN. DO NOT STARE INTO BEAM. (EN) (EN) (EN) (EN)	レーザー光線が放射される場合があります。直射して見ないでください。 (JP) (JP) (JP) (JP)	VISIBLE AND/OR INVISIBLE CLASS II LASER RADIATION WHEN OPEN. DO NOT STARE INTO BEAM. (EN) (EN) (EN) (EN)

# Table of contents

---

## Introduction

---

Special cautions .....	2
Notes on handling .....	2
Supplied accessories .....	2
About discs .....	3
Playable disc types .....	3
Disc structure .....	4
Description of parts .....	5
Front panel .....	5
Display window .....	5
Rear panel .....	5

## Getting started

---

Using the remote control .....	6
Putting the batteries in the remote control .....	6
Operating the TV using the remote control .....	7
Connecting up .....	8
Connecting antennas .....	8
Connecting speakers .....	9
Connecting other devices .....	10
Connecting with TV .....	11
Connecting the power cord .....	11

## Basic operations

---

Playing discs .....	12
Playback .....	12
To switch the display .....	13
Select an item on the disc by using the number buttons .....	14
To stop playback .....	14
To pause playback .....	14
To advance picture frame-by-frame .....	14
Fast reverse/Fast forward search .....	14
Playing back from a position 10 seconds before (One Touch Replay) .....	15
Slow Motion Playback .....	15
Skip to the beginning of the selection .....	15
To change the brightness of the display window (DIMMER) .....	16
Adjusting the volume .....	16
Adjusting sound quality .....	16
Turning off the sound temporarily (MUTING) ...	16
Playing audio/video files .....	16
Playback .....	17
Repeat playback .....	17
Resume Playback .....	18
Select the scene to be played .....	19
Select the scene from the menu .....	19
Designate the time (Time search) .....	20

## Advanced operations

---

Program/Random Playback .....	20
Play the disc in the desired order (Program Playback) .....	20
Playing the disc in a random order (Random Playback) .....	21
Repeat Playback .....	22
Playing the title/chapter/group/track/all tracks repeatedly (REPEAT) .....	22
Playing the designated part repeatedly (A-B Repeat Playback) .....	23

Other convenient functions .....	24
Selecting the subtitles .....	24
Selecting the audio language .....	24
Selecting a view angle .....	24
Enlarging the picture (ZOOM) .....	25
Adjusting the picture quality (VFP) .....	25
Making dialogues clear (CLEAR VOICE) .....	25
Creating realistic sound (3D PHONIC) .....	26
Adjusting playback level (DVD LEVEL) .....	26
Enjoying better pictures (SCAN MODE) .....	26
Functions specific to DVD AUDIO .....	27
Playing the Bonus Group .....	27
Browsable Still Pictures (B.S.P.) .....	27
Using the menu bar .....	28
Preferences .....	29
Basic operations .....	29
LANGUAGE .....	29
PICTURE .....	29
AUDIO .....	30
OTHERS .....	30

## Listening to the radio

---

Listening to a radio broadcast .....	31
Selecting a station .....	31
Presetting stations .....	31
Tuning in to a preset station .....	31

## Convenient functions

---

Playing Back from the PC .....	32
Listening to the sound of other audio device ...	33
Listening to the sound of external audio device ...	33
Listening to the sound of portable audio device ...	33
Adjusting the audio input level .....	34
Setting the Various Timer .....	34
Setting the built-in clock .....	34
Setting the daily timer .....	35
Auto Standby .....	36
Sleep Timer .....	36
Tray Lock .....	36

## Reference

---

Troubleshooting .....	37
Language codes .....	38
Specifications .....	39

# Special cautions

## Notes on handling

### ■ Important cautions

#### Installation of the system

- Select a place which is level, dry and neither too hot nor too cold; between 5°C and 35°C (between 41°F and 95°F).
- Leave sufficient distance between the system and the TV.
- Do not use the system in a place subject to vibration.

#### Power cord

- Do not handle the power cord with wet hands.
- A small amount of power is always consumed while the power cord is connected to the wall outlet.
- When unplugging the power cord from the wall outlet, always pull on the plug, not the power cord.

#### To prevent malfunctions of the system

- There are no user-serviceable parts inside. If anything goes wrong, unplug the power cord and consult your dealer.
- Do not insert any metallic object into the system.
- Do not use any non-standard shape disc (like a heart, flower or credit card, etc.) available on the market, because it may damage the system.
- Do not use a disc with tape, stickers, or paste on it, because it may damage the system.

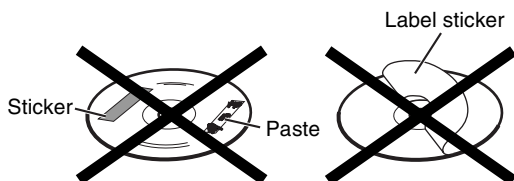

#### Note about copyright laws

Check the copyright laws in your country before recording from DVDs, VCDs, SVCDs, and CDs. Recording of copyrighted material may infringe copyright laws.

#### Note about copy guard system

DVDs are protected by copy guard system. When you connect the system to your VCR directly, the copy guard system activates and the picture may not be played back correctly.

### ■ Safety precautions

#### Avoid moisture, water and dust

Do not place the system in moist or dusty places.

#### Avoid high temperatures

Do not expose the system to direct sunlight and do not place it near a heating device.

#### When you are away

When away on travel or for other reasons for an extended period of time, disconnect the power cord plug from the wall outlet.

#### Do not block the vents

Blocking the vents may damage the system.

#### Care of the cabinet

When cleaning the system, use a soft cloth and follow the relevant instructions on the use of chemically-coated cloths. Do not use benzene, thinner or other organic solvents including disinfectants. These may cause deformation or discoloring.

#### If water gets inside the system

Turn the system off and disconnect the power cord plug from the wall outlet, then call the store where you made your purchase. Using the system in this condition may cause fire or electrical shock.

### ■ When condensation or water drops adhere to the lens

In any of the following cases, condensation or water drops may adhere to the lens to prevent the system from working properly:

- Immediately after starting to heat the room
- When the system is installed in a steamy or damp space
- When the system is suddenly moved from a cold place to a warm place

In any of these cases, leave the system turned on for 1 or 2 hours before use.

## Supplied accessories

Check to be sure you have all of the supplied accessories.

The number in parentheses is the quantity of the pieces supplied. If anything is missing, contact your dealer immediately.

- Remote control (1)
- Batteries (2)
- FM antenna (1)
- AM loop antenna (1)
- Power cord (1)
- Composite video cord (1)
- Speaker cords (2)

#### How to read this manual





- Operations are described by mainly using the remote control buttons. If there are the same marks on the main unit, the buttons on the main unit can also be used.
- The following marks tell you for which type of the discs the operation can be made.



- The illustrations and TV screens may be different between the actual case and the description.
- "DVD VR" means a DVD recorded in DVD Video Recording (DVD VR) format.
- "VCD" is an abbreviation of "Video CD".
- "SVCD" is an abbreviation of "Super Video CD".

## Playable disc types

Discs you can play:

Disc Type	Mark (Logo)	Video Format
DVD VIDEO		NTSC
DVD AUDIO		—
VCD		NTSC
SVCD		NTSC
CD		—

The “Playable” in the following list shows available disc types and recording formats.

Disc type Recording format	CD-R/-RW <sup>*1</sup>	DVD-R <sup>*1</sup>	DVD-RW <sup>*1</sup>
DVD Video	—	Playable	Playable
DVD Audio	—	Playable	Playable
DVD VR <sup>*2</sup>	—	Playable <sup>*2</sup>	Playable <sup>*2</sup>
VCD/SVCD	Playable	—	—
Audio CD	Playable	—	—
MP3/WMA/JPEG	Playable	Playable <sup>*3</sup>	Playable <sup>*3</sup>
MPEG1/MPEG2	Playable	Playable <sup>*3</sup>	Playable <sup>*3</sup>

- A DVD VR formatted DVD-ROM is also playable.

\*1 This system can play finalized discs only.

\*2 Only when a DVD-R/-RW is compatible with CPRM (Content Protection for Recordable Media), DVD VR format can be used.

\*3 Recorded with UDF Bridge format.

However, some discs may not be played back because of their disc characteristics, recording conditions, or damage or stain on them.

Only sounds can be played back from the following discs:

MIX-MODE CD	CD-G
CD-EXTRA	CD TEXT



is a trademark of DVD Format/Logo Licensing Corporation.

- It is possible to playback finalized +R/+RW (DVD Video Format only) discs, “DVD” lights on the front display panel when a +R/+RW disc is loaded.

### Caution for DualDisc playback

The non-DVD side of a “DualDisc” does not comply with the “Compact Disc Digital Audio” standard. Therefore, the use of Non-DVD side of a DualDisc on this product may not be recommended.

### Note on Region Code

DVD VIDEO players and DVD VIDEO discs have their own Region Code numbers. This system can play back DVD VIDEO discs whose Region Code numbers include the system’s Region Code, which is indicated on the rear panel.

Examples:



If a DVD VIDEO with an improper Region Code number is loaded, “REGION CODE ERROR!” appears on the TV screen and playback cannot start.

- On some DVD VIDEOS, DVD AUDIOS, VCDs or SVCDs, their actual operation may be different from what is explained in this manual. This is due to the disc programming and disc structure, not a malfunction of this system.

### Notes on CD-R and CD-RW

- This system supports “multi-session” discs (up to 20 sessions).
- This system cannot play “packet write” (UDF format) discs. Some discs may not be played back because of their disc characteristics, recording conditions, or damage or stain on them.

### Discs that cannot be played back

- DVD-RAM, CD-ROM, CD-I (CD-I Ready), Photo CD, SACD, etc.  
Playing back these discs will generate noise and damage the speakers.

Damaged discs and discs in an extraordinary shape (other than a disc of 12 cm or 8 cm (5 inches or 3 inches) in diameter) cannot be played back.

### Notes on all files

- The system can only recognize and play files with one of the following extensions, which can be in any combination of upper and lower case;
  - MP3: “.mp3”
  - WMA: “.wma”
  - JPEG: “.jpg”, “.jpeg”
  - MPEG1/MPEG2: “.mpg”, “.mpeg”
- If a character other than single byte English characters is used in the file name, the track/file name will not be displayed correctly.
- The system recognizes up to 150 tracks (files) per group, 99 groups per disc, and the total number of the tracks (files) that the system can play is 4 000.
- Since the unit ignores the tracks/files whose numbers are exceeding 150 and the groups whose numbers are exceeding 99, they cannot be played back.
- Some files may not be played back normally because of their disc characteristics or recording conditions.

## For MP3/WMA files

- An off-the-shelf MP3 disc may be played in an order different from that indicated on the label attached to the disc.
- The system supports MP3/WMA files recorded with a bit rate of 32 – 320 kbps and a sampling frequency of 16 kHz, 22.05 kHz, 24 kHz (WMA only), 32 kHz, 44.1 kHz, or 48 kHz.
- If the tag information (album name, artist, and track title, etc.) is recorded on a disc, it appears in the file control display on the TV screen.
- We recommend to record each piece of material (song) at a sample rate of 44.1 kHz and at a data transfer rate of 128 (96 for WMA only) kbps.
- This system cannot play back files encoded with Multiple Bit Rate (MBR). (MBR is a format to encode a file content at several different bit rates.)

## For JPEG files

- We recommend to record a file at 640 x 480 resolution.
- This system can play a baseline JPEG file, excluding monochromatic JPEG files.
- This system can play JPEG data taken with a digital camera conforming to the DCF (Design Rule for Camera File System) standard (when a function is applied such as the automatic rotation function of a digital camera, data goes beyond the DCF standard, so the image may not be displayed).
- If data has been processed, edited and restored with PC image editing software, the data may not be displayed.
- This system cannot play animations such as MOTION JPEG, or still images (TIFF etc.) other than JPEG, and image data with sound.
- An image with a resolution of more than 8 192 x 7 680 pixels cannot be displayed.

## For MPEG-1/MPEG-2 files

- The stream format should conform to MPEG system/program stream.
- 720 x 576 pixels (25 fps)/720 x 480 pixels (30 fps) is recommended for the highest resolution.
- This system also supports the resolutions of 352 x 576/ 480 x 576/ 352 x 288 pixels (25 fps) and 352 x 480/ 480 x 480/ 352 x 240 pixels (30 fps).
- The file format should be MP@ML (Main Profile at Main Level)/SP@ML (Simple profile at Main Level)/MP@LL (Main Profile at Low Level).
- Audio streams should conform to MPEG1 Audio layer-2 or MPEG2 Audio Layer-2.

# Disc structure

## DVD VIDEO/DVD VR

A DVD VIDEO consists of “titles” and each title may be divided into “chapters”.

A DVD VR consists of “original programs” or “playlists” and each original program/playlist may be divided into “chapters”.

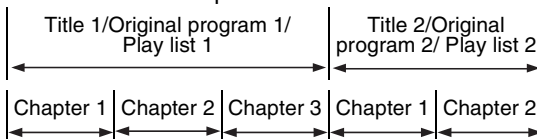

## DVD AUDIO

A DVD AUDIO consists of “groups” and each group may be divided into “tracks”.

Some discs include a “bonus group” that requires a password for playing (page 27).

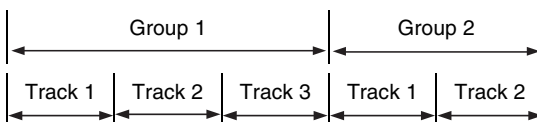

## VCD/SVCD/CD

VCD, SVCD and CD consist of “tracks”.

In general, each track has its own track number. (On some discs, each track may also be further divided by indexes.)

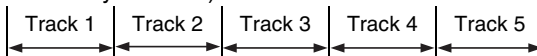

## MP3/WMA/JPEG/MPEG1/MPEG2 discs

On an MP3/WMA/JPEG/MPEG1/MPEG2 disc, each still picture (material) is recorded as a track/file. Tracks/Files are usually grouped into a folder. Folders can also include other folders, creating hierarchical folder layers.

This unit simplifies the hierarchical construction of a disc and manages folders by “groups”.

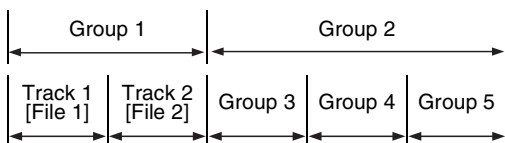

- If there is any type of files other than MP3/WMA/JPEG/MPEG1/MPEG2 files in a folder, those files are also counted in the total file number.

The numbers represent the page numbers.

## Front panel

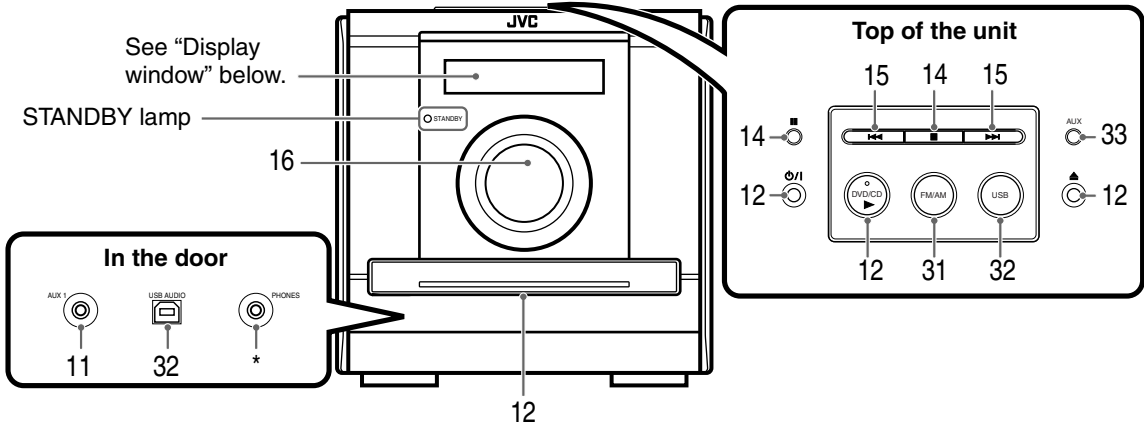

\* Connect headphones (not supplied) with a stereo mini plug. If the headphones are connected, the speakers and subwoofer will not produce any sound.

## Display window

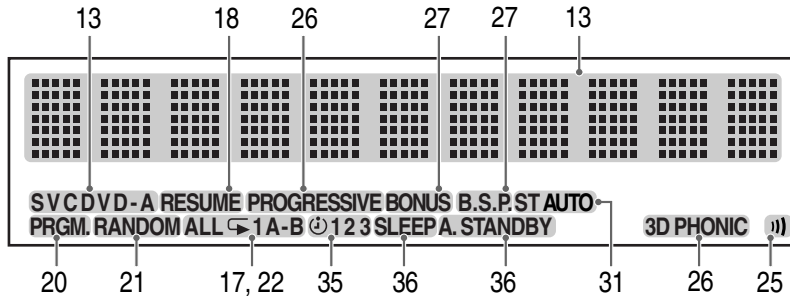

## Rear panel

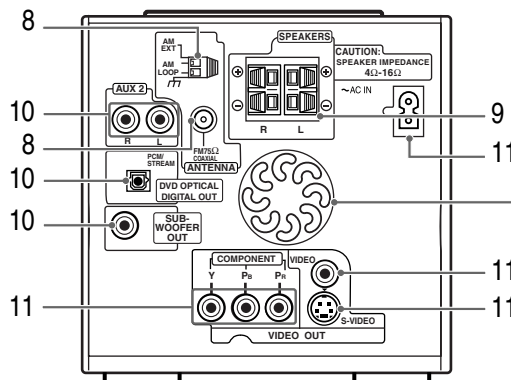

These holes discharge heat generated inside the unit. Do not cover up these holes.



# Using the remote control

The numbers represent the page numbers.

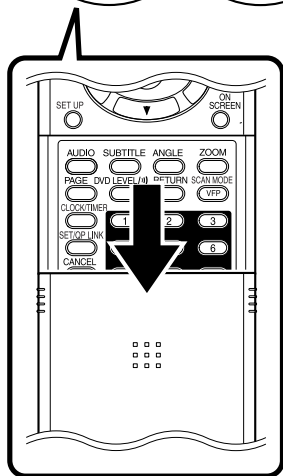
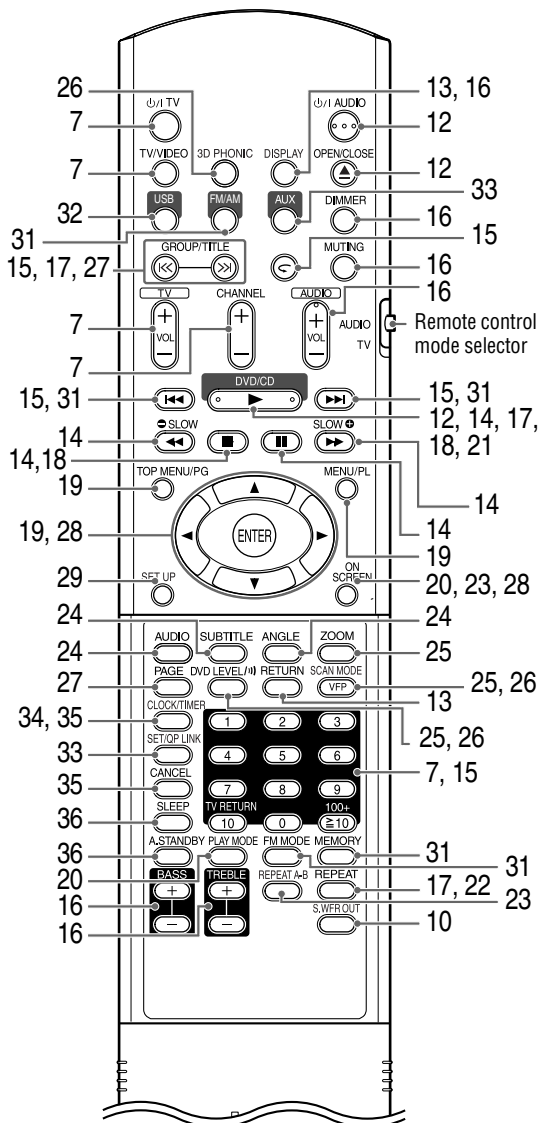

## Putting the batteries in the remote control

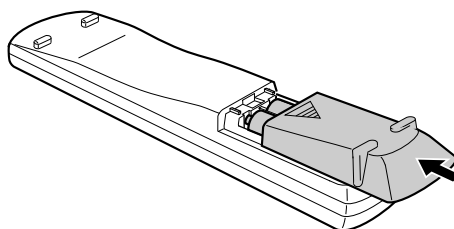
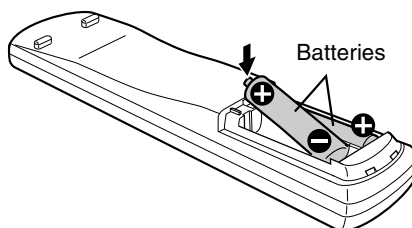
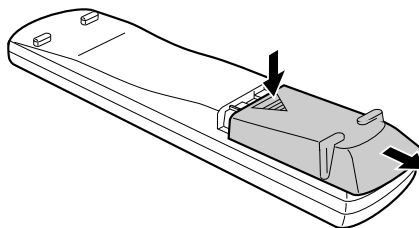

If the range or effectiveness of the remote control decreases, replace the batteries. Use two R6 (SUM-3)/AA(15F) type dry-cell batteries.

### CAUTION

- Do not use a used battery and a new battery together.
- Do not use different types of batteries at the same time.
- Take out the batteries if the remote control is not to be used for a long time. Otherwise it may cause a leakage.

### Remote control operation

When operating the remote control, point it towards the front panel of the main unit. If the remote control is operated from a direction that is extremely oblique or when there is an obstacle in the way, signals may not be transmitted.

If the remote control sensor is exposed to a strong light such as direct sunlight, correct operation may not be carried out.



This page is for when operating your TV using the remote control of this product.

## Operating the TV using the remote control

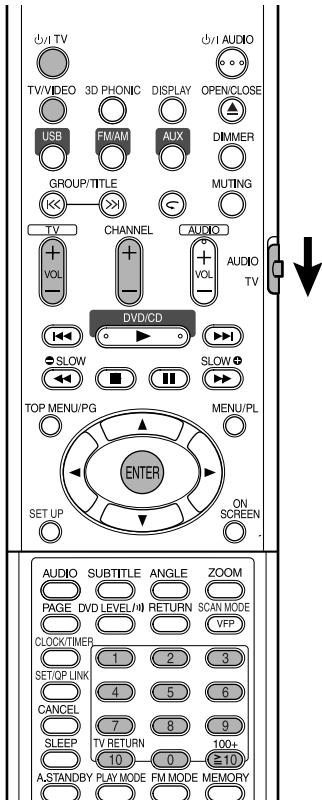

### Setting the manufacturer's code

- Slide the remote control mode selector to the TV side.



- Keep pressing down  $\text{TV}$ .

#### NOTE

Keep pressing down  $\text{TV}$  until Step 4 is complete.

- Press ENTER.

- Press number buttons (1-9, 0).

#### Ex.:

For a Hitachi TV: Press 1, then 0.  
For a Toshiba TV: Press 0, then 8.

If there are more than one manufacturer's codes, try them in turn and select the one that causes the product to work properly.

Manufacturer	Code	Manufacturer	Code
JVC	01	Samsung	12
Hitachi	10	Sanyo	13, 14
Magnavox	02	Sharp	06
Mitsubishi	03	Sony	07
Panasonic	04, 11	Toshiba	08
Philips	15	Zenith	09
RCA	05		

#### NOTE

Manufacturer's codes may be changed without notice. You may not be able to operate a TV produced by the manufacturer shown above.

## 5 Release $\text{TV}$ .

### For TV operation

Operate the remote control by pointing it towards the TV.

$\text{TV}$	Turn ON/OFF the power.
CHANNEL	Change channels.
TV VOL	Adjust volume.
1 ~ 9 / 0 / 100+ / 10	Select channels. *1
TV RETURN	Alternates between the previously selected channel and the current channel.
TV/VIDEO	Switch TV and video input.

\*1 Make sure to slide the remote control mode selector to the TV side in advance.

#### NOTE

When the batteries are replaced, perform the manufacturer's code setting again.

## Connecting antennas

### Connecting AM loop antenna (supplied)

1 Set up the AM loop antenna.

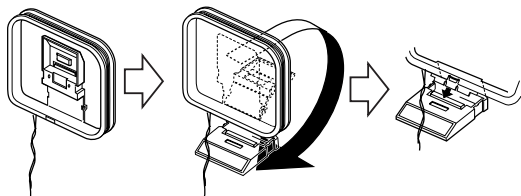

2 Connect antenna cords.

Main unit (rear panel)

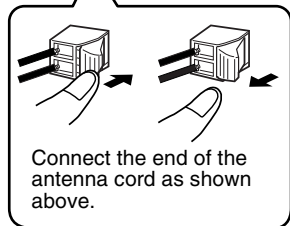
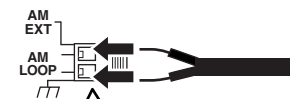

Connect the end of the antenna cord as shown above.

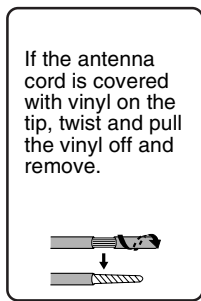

If the antenna cord is covered with vinyl on the tip, twist and pull the vinyl off and remove.

3 Turn the AM loop antenna to the direction of the best radio reception.

Locate the AM loop antenna as far away from the main unit as possible.

- Do not locate the AM loop antenna on a metallic table or close to a TV, personal computer, etc. Otherwise it may result in bad radio reception.

#### ■ When good radio reception cannot be obtained with the supplied AM loop antenna

Electric wire: 3 - 5 m (9 feet 10 inches - 16 feet 5 inches) (not supplied)

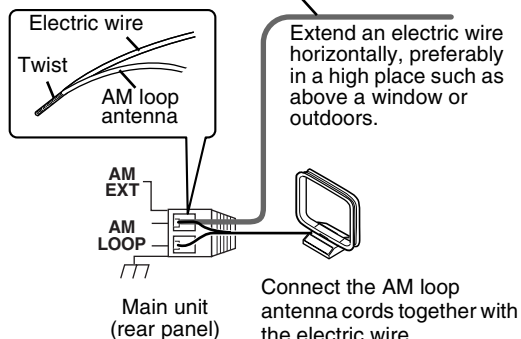

Extend an electric wire horizontally, preferably in a high place such as above a window or outdoors.

Connect the AM loop antenna cords together with the electric wire.

When positioning the antenna, find the best position for reception while listen to an actual radio program (refer to "Listening to a radio broadcast" on page 31).

### Connecting FM antenna (supplied)

Main unit (rear panel)

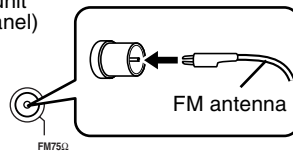

Put the antenna up straight in the direction where the best radio reception can be obtained, and fix by using tape.

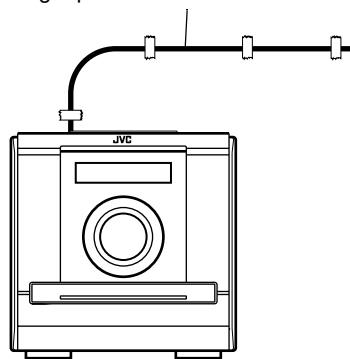

#### ■ When good radio reception cannot be obtained with the supplied antenna or when using a communal antenna

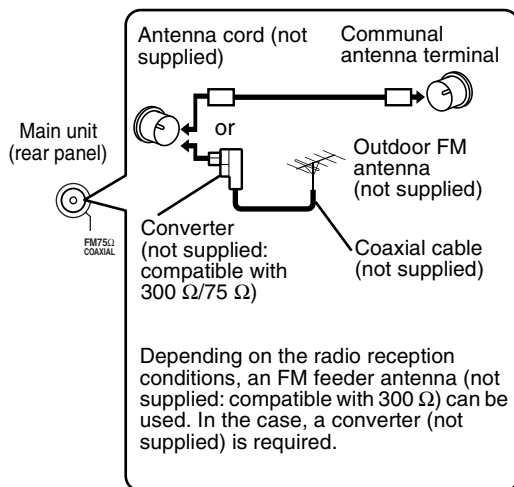

Depending on the radio reception conditions, an FM feeder antenna (not supplied: compatible with 300 Ω) can be used. In the case, a converter (not supplied) is required.

For details of connecting a separately sold antenna, refer to the user guide for the antenna or converter.

## Connecting speakers

There is no difference between the left and right speakers.

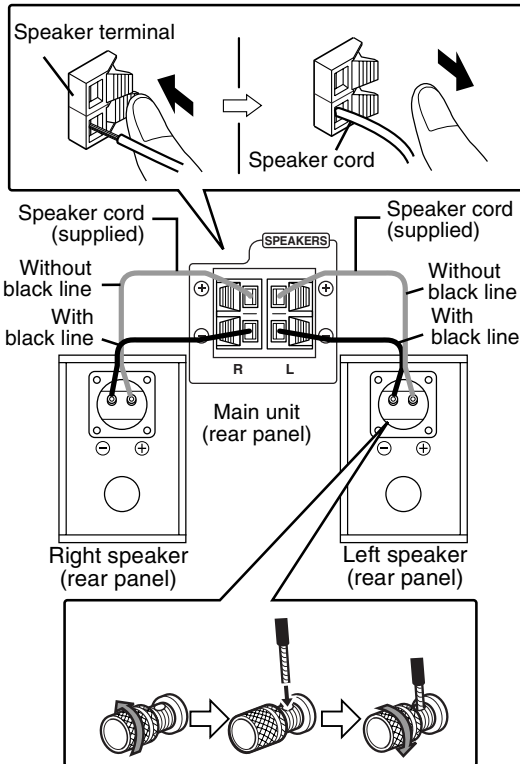

### CAUTION

- **DO NOT** connect more than one speaker to one speaker terminal.
- The speakers of this product are magnetically shielded, but color irregularities may occur on the TV depending on how the speakers are installed. Keep in mind the following.
  1. Turn off the main power of your TV before installing the speakers. Wait for about 30 minutes before turning on the TV again.
  2. If color irregularity occurs in pictures, keep a distance of more than 10 cm ( $3^{15}/16$  inches) between the TV and the speakers.

The speakers employ natural wood for the diaphragm and the cabinet in order to reproduce the original sound faithfully. The appearance will therefore be different for each unit.

Speaker grille can be detached.

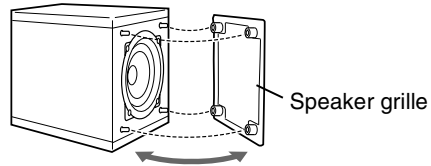

### NOTE

- Impedance of speaker that can be connected to the main unit is within a range of  $4 \Omega$  to  $16 \Omega$ .
- In order to have a sufficient cooling effect, leave a space of more than 1 cm ( $3/8$  inches) between the main unit and the speakers or other objects.

## Connecting other devices

This page is for when connecting the main unit with other devices.

### Connecting subwoofer

With an amplifier-built-in subwoofer (not supplied), you can enjoy a more dynamic bass sound. Refer to the manual of the subwoofer for details.

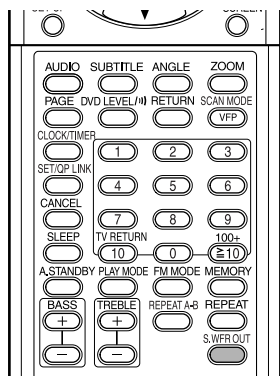
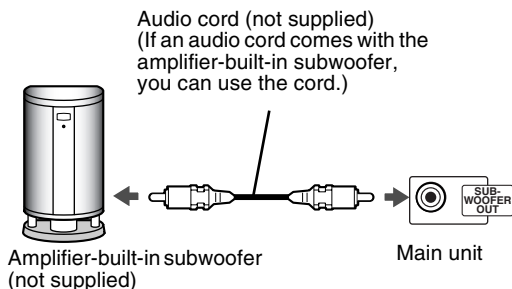

When you want to hear sound from the subwoofer, press **S.WFR OUT** on the remote control to display “SUBWOOFER” on the display window on the main unit. Each time you press the button, the display toggles between “SUBWOOFER” and “OFF”.

#### NOTE

When “SUBWOOFER” is selected, bass sound from the left and right speakers will be automatically lowered and the bass sound will be emitted mainly from the subwoofer.

### Connecting with other audio device

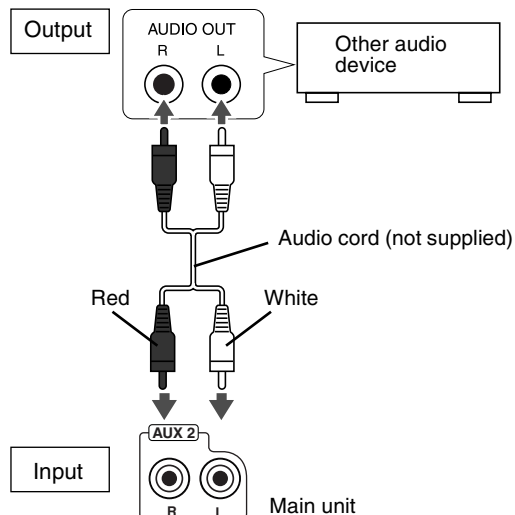

### Connecting with a digital device

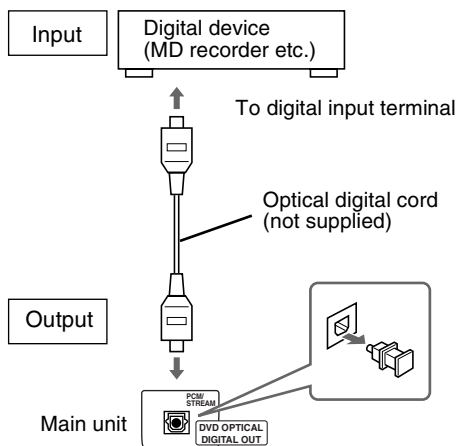

Digital audio signals are output from this system only when DVD/CD is selected as the source.

#### CAUTION

- For details of signals to be output, refer to page 30.
- If connecting the main unit with equipment with the function of a Dolby Digital decoder, the setting in “D. RANGE COMPRESSION” of “AUDIO” (page 30) will be invalid regarding sound from the digital audio output of the main unit.

## Connecting with a portable audio device

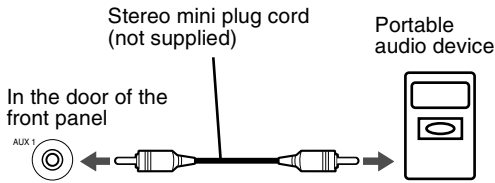

- By using QP Link (Quick Portable Link), you can easily start playing back a portable audio device on this unit. See page 33 for details.
- If an external device is not equipped with a stereo mini plug audio output, use a plug adaptor to convert the stereo mini plug to the corresponding plug of the audio output.

## Connecting with TV

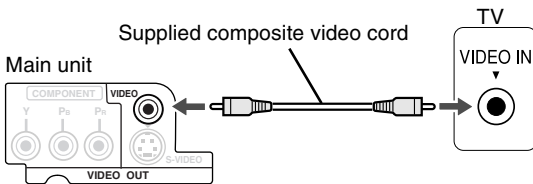

### CAUTION

Connect the main unit directly with a TV (or a monitor) without routing through a VCR. Otherwise it may cause picture distortion while playing.

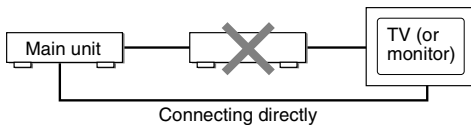

Also, when connecting the main unit to a TV with a VCR built in, there may be picture distortion while playing.

You can enjoy pictures of better quality using the following cord instead of the supplied video cord.

## Connecting by using the S-Video cord

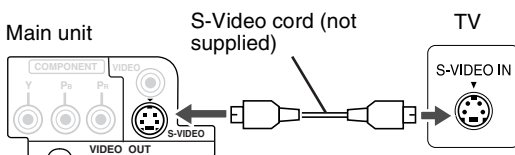

## Connecting by using the component video cord

You can enjoy better quality pictures than when using the S-Video cord.

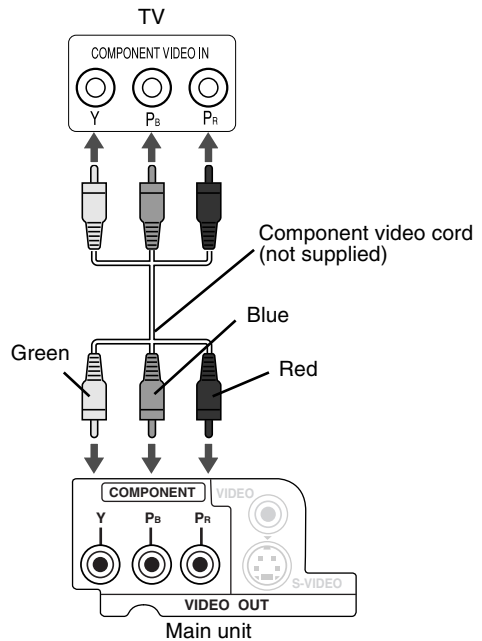

### CAUTION

Use either the S-Video cord or the component video cord. If both cords are used, pictures may not be played properly.

### NOTE

- In order to enjoy pictures with Progressive mode (page 26), the TV is required to have Progressive video input.
- If the component video input jacks of your TV are BNC type, use a plug adaptor (not supplied) to convert the plugs.

## Connecting the power cord

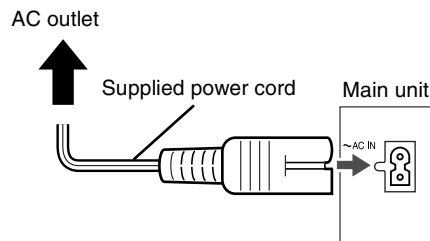

- Connect the power cord after all other connections are complete.
- The STANDBY lamp (on the front panel) will be lit.

# Playing discs

## Playback

**DVD VIDEO** **DVD AUDIO** **DVD VR** **VCD** **SVCD** **CD** (Refer also page 17 for playing MP3/WMA/JPEG/MPEG1/MPEG2.)

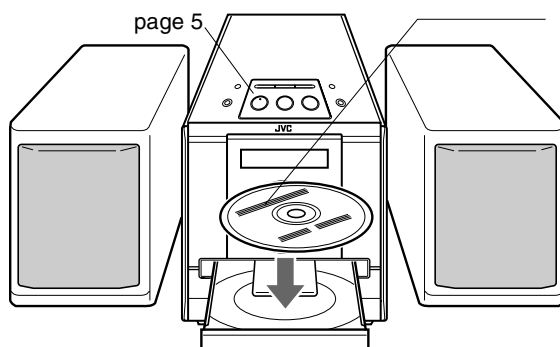

Place a disc with the label side facing up.

- Place an 8 cm (3 inches) disc in to the hollow part in the center.

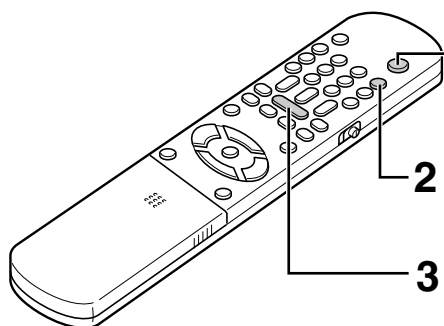

### 1 Press **⏻**/AUDIO.

- The power will be turned on and the STANDBY lamp will go off.
- Press **⏻**/AUDIO again to turn off the power.

### 2 Press **⏏** OPEN/CLOSE to open the disc tray to load a disc.

### 3 Press **DVD/CD** ▶.

The disc tray will close and playback will start.

- The power will be turned on when any of DVD/CD ▶, USB, FM/AM, AUX, or **⏏** on the main unit and DVD/CD ▶, USB, FM/AM, AUX, or **⏏** OPEN/CLOSE on the remote control is pressed while the power is off.
- If any button other than **⏏** or **⏏** OPEN/CLOSE is pressed, the source will also be changed (if there is a disc loaded, playback will start by pressing the DVD/CD ▶ on the main unit or the remote control).

### NOTE

- A menu screen may be displayed on the TV after starting playback of a DVD/VCD/SVCD. In this case, select a desired item to playback by using the following buttons on the remote control.
  - Select a desired item using cursor **⬆**/**⬇**/**⬅**/**➡** and press **ENTER**.
  - Select a desired item using the number buttons.
- Depending on the disc, actual operation may be different from the description.

### Screens displayed on the TV when the power is turned ON.

The following messages appear depending on the status of the system. (When FM, AM, USB or AUX is selected as a source, the messages do not appear.)

NOW READING	Appears when the system is reading the disc information. Wait for a while.
REGION CODE ERROR!	Appears when the Region Code of the DVD VIDEO does not match the code the system supports. (page 3)
NO DISC	Appears when no disc is loaded.
OPEN	Appears when opening the disc tray.
CLOSE	Appears when closing the disc tray.
CANNOT PLAY THIS DISC	Appears when trying to playback an unplayable disc.

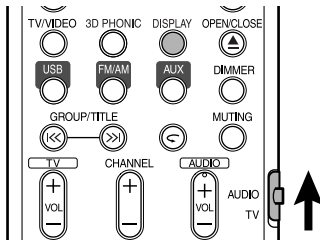

## Display window during disc playback

Ex.: When a DVD VIDEO is played

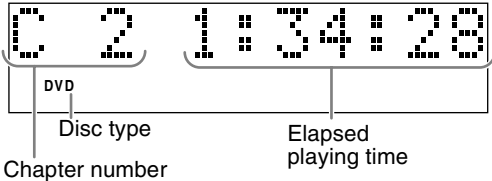

When a DVD VR is played back, PG (original program) /PL (play list) number is displayed.

Ex.: When a DVD AUDIO is played

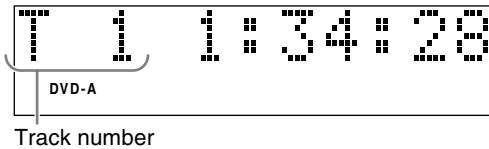

If "BONUS" or "B.S.P." is displayed during a DVD AUDIO playback, refer to page 27.

Ex.: When an SVCD or VCD is played

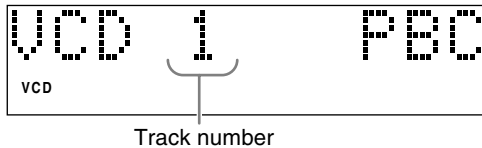

- When playing an SVCD, the SVCD indicator lights instead of the VCD indicator.
- PBC (Play Back Control): A signal recorded in a VCD (version 2.0) for controlling playback. It is possible to enjoy interactive software or software with a search function using a menu screen recorded in a PBC compatible VCD. To play a disc with the PBC function OFF, carry out the following operations.
  - Designate the track number using the number buttons while the disc is stopped.
  - Designate the track number using **▶▶** while the disc is stopped, and then press **DVD/CD ▶**.
- Press **RETURN** to go back to the upper layer during the PBC playback of a VCD or SVCD.

Ex.: When a CD is played

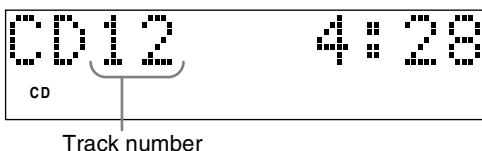

Ex.: When an MP3/WMA/MPEG1/MPEG2 file is played

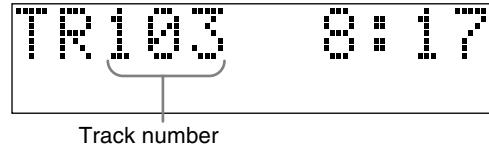

Ex.: When a JPEG file is played

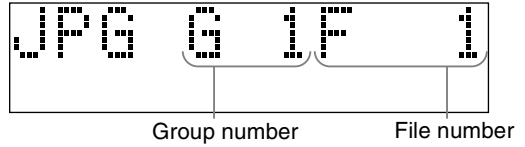

## To switch the display

Press **DISPLAY**.

Each time you press the button, the display indication changes temporarily as follows:

### • For DVD VIDEO

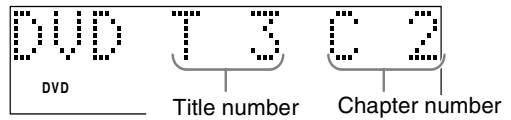

### • For DVD VR

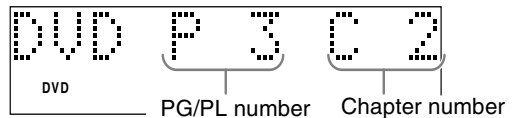

### • For DVD AUDIO

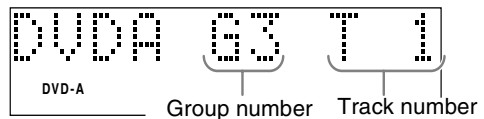

### • For MP3/WMA

EX.: When an MP3 is played

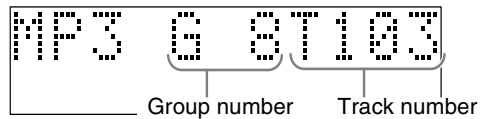

- When playing a WMA track, "WMA" appears instead of "MP3".

### • For MPEG1/MPEG2

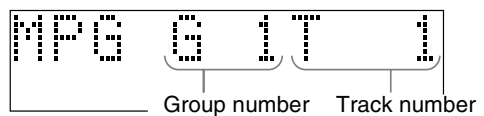

### • For SVCD/VCD/CD/JPEG

The clock time indication appears on the display window.

- Before setting the clock (page 34), "AM 12:00" appears.
- When the unit is turned off, pressing **DISPLAY** turns off the clock indication to save the power consumption.



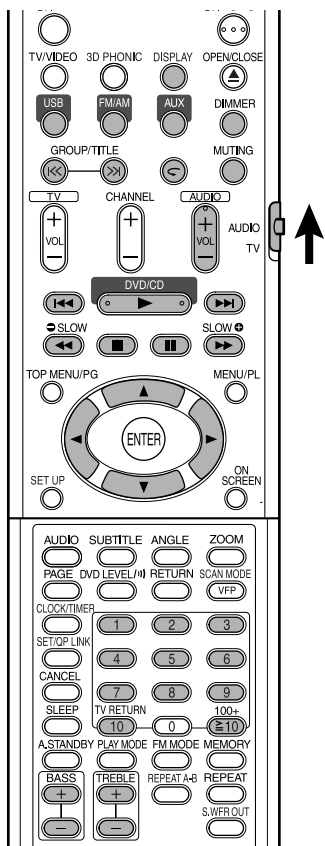

## Select an item on the disc by using the number buttons



### NOTE

- Set the remote control mode selector to **AUDIO** before using the number buttons. 
- For a VCD or SVCD, this operation can be carried out when the disc is stopped, or during playback without the PBC function.
- For a DVD AUDIO, CD, MP3/WMA or JPEG, this operation can also be carried out when the disc is stopped.
- For a DVD VIDEO, you can select the title before playing, and you can select chapter while playing.
- This operation may not be carried out for some discs.

## Use number buttons to select the item you want to play.

- Refer to "How to use the number buttons" on page 15.

## To stop playback



Press **■** during playback.

## To pause playback



Press **⏸** during playback.

- To start normal playback again, press DVD/CD **▶**.
- For JPEG slide-show, pressing DVD/CD **▶** starts playback from the next file.

## To advance picture frame-by-frame



Press **⏮** during pause.

- Each time you press the button, picture will be advanced frame-by-frame.

## Fast reverse/Fast forward search



Press **⏮** or **⏭** during playback.

- Each time you press the button, the speed increases (X2, X5, X10, X20, X60). To restore the normal speed, press DVD/CD **▶**.

### NOTE

- For MP3 and WMA discs/files, the search speed shown on the TV is different from described above.
- While playing moving pictures, no sound comes out during Fast reverse/Fast forward search.
- For a CD or DVD AUDIO, sound is intermittent during Fast reverse/Fast forward search.

## Playing back from a position 10 seconds before (One Touch Replay)



Press **◀** during playback.

### NOTE

- This function may not be available for some discs.
- It is not possible to go back to the previous title.

## Slow Motion Playback



Press **SLOW** **⊖** or **SLOW** **⊕** during pause.

- Each time you press the button, the playback speed increases (  $\times 1/32$ ,  $\times 1/16$ ,  $\times 1/8$ ,  $\times 1/4$ ,  $\times 1/2$ ).
- Press **DVD/CD** **▶** to start normal playback again.

### NOTE

- No sound will be produced.
- The picture motion in the reverse direction may not be smooth.
- For a VCD, SVCD and DVD VR, Slow Motion Playback can be carried out in the forward direction only.

## Skip to the beginning of the selection



Press **◀◀** or **▶▶** during playback\*.

- Press **▶▶** to skip the next chapter or track.
- Press **◀◀** once to skip back to the beginning of the chapter or track currently being played (except for JPEG).
- Press **GROUP/TITLE** **◀◀** or **▶▶** to select the title or group.
- During playback of a MP3/WMA/JPEG discs, press **▶▶** or cursor **▼** to play the next file, or press **◀◀** or cursor **▲** to play the previous file.

### NOTE

- \* For a VCD or SVCD, this operation can be carried out during playback without the PBC function.
- Except for a DVD VIDEO, this operation can also be carried out while the disc is stopped.
- This operation may not be carried out for some discs.

## How to use the number buttons

Ex.: 5: **5**      15: **10** → **1** → **5**      126: **10** → **10** → **1** → **2** → **6**  
 20: **10** → **2** → **0**      25: **10** → **2** → **5**



### Guide icons displayed on the TV screen (On-screen guide)



: Play



: Pause



: Fast reverse/Fast forward search



: Slow Motion Playback (reverse/forward directions)



: Containing multi-angle views (page 24)



: Containing multi-audio languages (page 24)



: Containing multi-subtitle languages (page 24)



: The disc cannot accept the operation you have attempted.

## To change the brightness of the display window (DIMMER)

Press **DIMMER** repeatedly.

- Each time you press the button, the dimmer mode changes as follows:

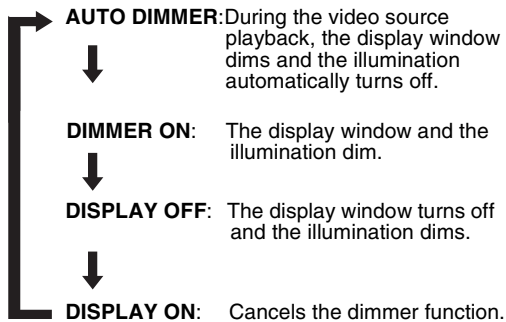

- When the unit is turned off, pressing **DISPLAY** turns off the clock indication to save the power consumption. At this time, QP Link will be canceled automatically.
- The items above can be carried out for all sources.

## Adjusting the volume

Press **AUDIO VOL +/-**.

**NOTE**

The volume can be also adjusted by turning the **VOLUME** control on the main unit.

## Adjusting sound quality

**Bass:** Press **BASS +/-**.

**Treble:** Press **TREBLE +/-**.

- Adjustable range: -5 to +5

## Turning off the sound temporarily (MUTING)

Press **MUTING**.

- No sound will come out from the speakers, headphones and the subwoofer.
- Press **MUTING** again to restore the sound. In this function, the sound will not be restored by following operations.
  - Turn off the system directly.
  - Press **AUDIO VOL +/-** directly.

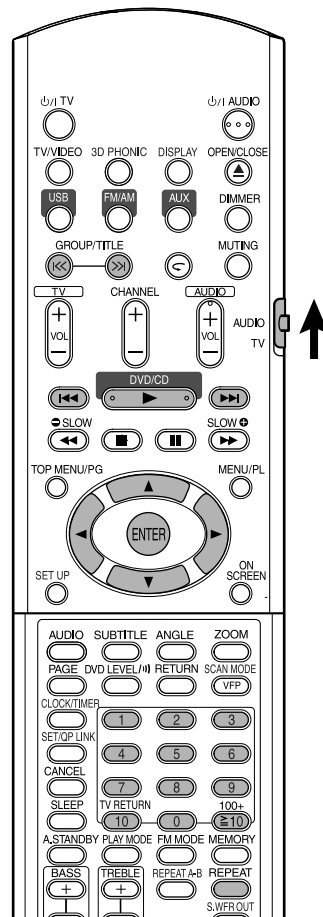

**NOTE**

Set the remote control mode selector to **AUDIO** before using the number buttons.



## Playback

MP3 WMA JPEG MPEG1 MPEG2

Display of an MP3/WMA disc is described here as an example.

For a JPEG disc, read "track" as "file".

### NOTE

When playing a disc containing both MP3/WMA/ MPEG1/MPEG2 and JPEG files, set one of them to be played, then turn on the system again (page 29).

## 1 Load a disc.

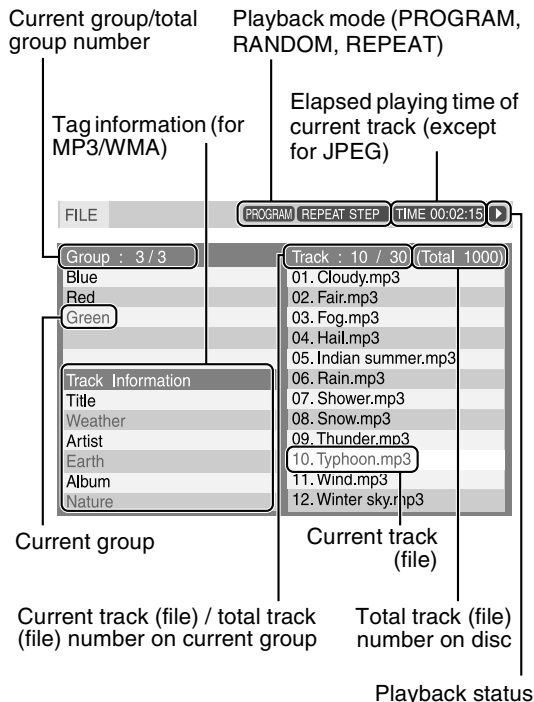

## 2 Press cursor ▲/▼ to select a group.

## 3 Press cursor ► to move to the track list.

- Press cursor ◀ to go back to the group list.

## 4 Press cursor ▲/▼ to select a track.

## 5 Press DVD/CD ► or ENTER.

### NOTE

- **GROUP/TITLE** ◀, ▶ can also be used in Step 2.
- The number buttons can also be used in Step 4. In this case, Step 5 is not needed. (For how to use the number buttons, refer to page 15.)
- ◀◀ or ▶▶ can also be used in Step 4.

## Repeat playback

MP3 WMA JPEG MPEG1 MPEG2

## 1 Press REPEAT.

- Each time you press the button, the Repeat mode and its indication change as follows:

Repeat items	On the TV	On the display window
Current track (except for JPEG)	REPEAT TRACK	REP TRK ↺ 1
Current group	REPEAT GROUP	REP GRP ↺
Entire disc All tracks during Program/Random play (MP3/WMA only)	REPEAT ALL	REP ALL ALL ↺
Current track during Program/Random play (MP3/WMA only)	REPEAT STEP	REP STEP ↺ 1
Cancel	REPEAT OFF	REP OFF

## 2 Press DVD/CD ►.

### NOTE

- The Repeat types can be changed during playback.
- The Repeat mode will be automatically canceled if there is a file that cannot be played (page 3).

## Slide-Show Playback JPEG

- In Step 5, for a JPEG disc, when **DVD/CD ►** is pressed, files will be continuously played from the selected file (Slide-Show Playback), and when **ENTER** is pressed, only a selected file will be played.
- Display time for a file in Slide-Show Playback is about 3 seconds.
- When all files are played through, the playback will be automatically stopped.

# Resume Playback

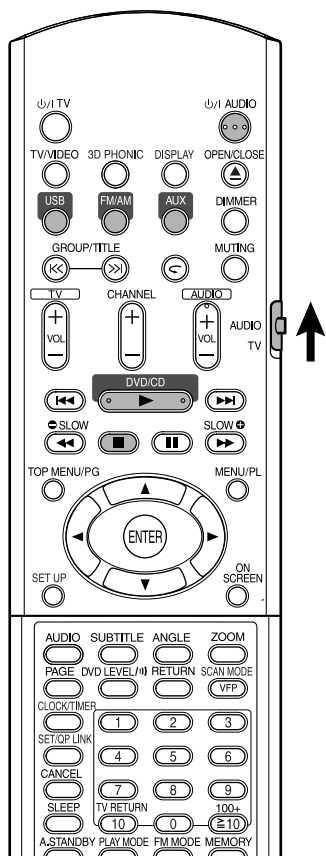

**NOTE**  
Set the remote control mode selector to **AUDIO** before using the number buttons.



This system can store the stop point, and when you start playback again by pressing DVD/CD ► (even while on standby), it starts from the position where you have stopped—Resume Play. The RESUME indicator lights on the display window when you stop playback.

## To suspend playback

Perform any of the following operations during playback.

Press ■ once.*
Press 0/I AUDIO to turn off the power.
Change the source to USB, FM/AM or AUX.*

\* Even if the power is turned off by pressing 0/I AUDIO after this, the position where playback has been stopped will be stored.



## To start playback from the stored position

Press DVD/CD ►.

### NOTE

- This function does not work in Program Playback or Random Playback.
- The position where playback starts again may be a little different from the stopped position.
- When a disc menu is displayed, the Resume function may not work.
- The system also stores the settings of the audio language, the subtitle language, and the angle selected when playback is stopped.
- To stop completely while Resume is set to ON, press ■ twice. (To cancel Resume, see “RESUME” on page 30)
- At the time of purchase, Resume is set to ON. Resume can be set to OFF (page 30).
- If you open the tray, the stored position will be erased.

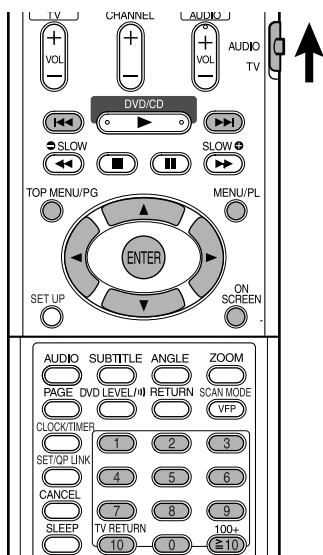

### NOTE

Set the remote control mode selector to **AUDIO** before using the number buttons.



## Select the scene from the menu

**DVD VIDEO** **DVD AUDIO** **VCD** **SVCD**

**1** Press **MENU/PL** or **TOP MENU/PG** while the disc is stopped or during playback\*<sup>1</sup>.

- The disc menu screen will be displayed.
- To display the disc menu while playing back a VCD or SVCD with PBC function, press **RETURN** repeatedly.
- Only **TOP MENU/PG** can be used for DVD AUDIOS.

**2** Press cursor **▲/▼/◀/▶** (only for a DVD VIDEO or DVD AUDIO) or the number buttons to select the scene to be played.

- Refer to “How to use the number buttons” (page 15).
- When the menu screen has a couple of pages, press **◀◀** or **▶▶** to change the page (only for a VCD and SVCD).

**3** Press **ENTER**.

### NOTE

\*<sup>1</sup> For a VCD and SVCD, this operation can be carried out only when the PBC function is off.

- This operation cannot be carried out for a disc without a menu screen.
- Playback may start for some discs without pressing **ENTER**.

**DVD**  
**VR**

**1** While the disc is stopped or during playback, press **TOP MENU/PG** to display the original program or press **MENU/PL** to display the play list.

■ Original program

ORIGINAL PROGRAM				
No	Date	Ch	Time	Title
1	03/04/06	L 1	12:15	La fleur
2	09/04/06	L 1	23:05	The last struggle
3	18/04/06	L 1	08:17	free flyer
4	20/04/06	L 1	07:47	BOOM!
5	25/04/06	L 1	19:38	Mr. Lawrence
6	28/04/06	L 1	14:20	Satisfy U

Labels for the table:  
 - Title name: Title  
 - Recording time: Time  
 - Channel information: Ch  
 - Recording date: Date

■ Play list

PLAY LIST				
No	Date	Chap	Length	Title
1	03/04/06	2	0:23:24	Nebula G.
2	15/04/06	4	1:04:39	CDJ
3	24/04/06	13	0:41:26	Secret Garden
4	27/04/06	17	0:09:08	S. Walker

Labels for the table:  
 - Recording date: Date  
 - Total playback time for the title: Length  
 - Number of chapters included in the title: Chap

- The play list will not appear when a play list has not been recorded to the disc.

**2** Press **▲/▼** to select the desired title.

**3** Press **ENTER**.

- When you have selected the original program by pressing **TOP MENU/PG** in step **1**, playback will start from the selected title to the following titles.
- When you have selected the play list by pressing **MENU/PL** in step **1**, only the selected title will be played back.

## Designate the time (Time search)

DVD VIDEO DVD AUDIO DVD VR VCD SVCD CD

**1** Press **ON SCREEN** twice during playback\*2.





The menu bar will be displayed (page 28).

**2** Press cursor **◀/▶** to select .

**3** Press **ENTER**.

**4** Input the time\*3 using the number buttons (1-9, 0).

Ex.: When you want to play a DVD VIDEO from the position of (0 hour) 23 minutes 45 seconds, press the buttons in the order:

 →  →  →  → 

- If you input wrong numbers, press cursor **◀** to delete the numbers and re-input.

**5** Press **ENTER**.

To remove the menu bar, press **ON SCREEN**.

### NOTE

- This function does not work for a DVD VIDEO with no time information recorded.
- This function does not work during Program or Random Playback.
- \*2 For a VCD and an SVCD, the operation can be carried out when the disc is stopped or during playback without the PBC function.
- \*3 Time search for a DVD VIDEO is from the beginning of the title, for a DVD AUDIO from the beginning of the track being played. Time search for a VCD, an SVCD and a CD is as follows:
  - When the disc is stopped, time search is from the beginning of the disc.
  - When the disc is being played, time search is within the track currently being played.

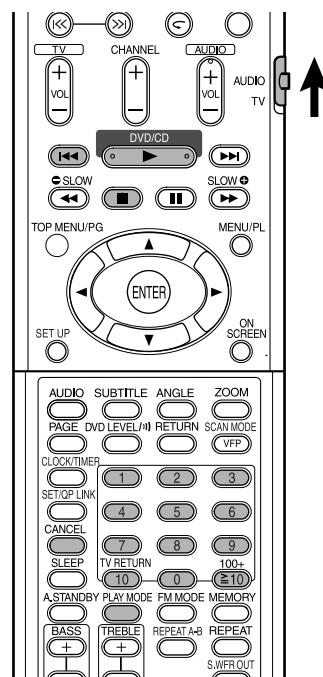

### NOTE

Set the remote control mode selector to **AUDIO** before using the number buttons.



## Play the disc in the desired order (Program Playback)

DVD VIDEO DVD AUDIO VCD SVCD CD MP3 WMA

It is possible to program a maximum of 99 chapters or tracks. The same chapter or track can be programmed more than once.

**1** While the disc is stopped, press **PLAY MODE** repeatedly to display “PROGRAM” on the display window on the main unit.

TV screen

PROGRAM		
No.	Group / Title	Track / Chapter
1		
2		
3		
4		
5		
6		
7		
8		

Program screen



## 2 Create a program following the description on the TV screen.

Refer to “How to use the number buttons” (page 15).

- The input content varies depending on the disc type.
  - DVD VIDEO: Titles and chapters
  - VCD, SVCD, CD: Tracks
  - DVD AUDIO, MP3/WMA: Groups and tracks
- To select a DVD AUDIO bonus group, carry out the operations of “Playing the Bonus Group” on page 27 in advance to erase the display “BONUS”.
- If the input number of chapters or tracks is greater than 99, “MEM FULL” will be displayed.

**To program on the display window on the main unit, operate as follows:**

- (1) Select a title/group using the number buttons.
- (2) Designate a chapter/track number using the number buttons.
  - Refer to “How to use the number buttons” (page 15).
  - The program number will be displayed on the display window (Ex.: “P2”).
- (3) Repeat the above operations (1) and (2) to complete the program. Then, advance to Step 3.

### NOTE

- The group/title number flashes on the display window after making each program step.
- Only for a DVD VIDEO, DVD AUDIO, or an MP3/WMA: If you press **ENTER** instead of designating a track/chapter number, “ALL” is displayed and all of the tracks/chapters in the selected group/title are programmed.

## 3 Press DVD/CD ►.

- To resume normal playback, press **PLAY MODE** repeatedly to show the playback indication on the display window on the main unit while the disc is stopped. The program content will not be erased.
- The following operations erase the program content:
  - Press **CANCEL** repeatedly (Programs will be erased one by one)
  - Press **■** while the disc is stopped
  - Open the disc tray
  - Turn off the power

## Playing the disc in a random order (Random Playback)



### 1 Press PLAY MODE repeatedly to display “RANDOM” on the display window on the main unit while the disc is stopped.

- “RANDOM” will also be displayed on the TV screen.

### 2 Press DVD/CD ►.

- The same chapter or track will not be played twice.
- To resume normal playback, press **PLAY MODE** repeatedly to show the playback indication on the display window on the main unit while the disc is stopped.
- Random Playback will also be canceled by carrying out the following operations:
  - Open the disc tray
  - Turn off the power
- The previous track will not be returned to even if **◀◀** is pressed repeatedly during Random Playback (the beginning of the current chapter or track will be returned to).

# Repeat Playback

Refer to page 17 for Repeat Playback of MP3/WMA/JPEG/MPEG1/MPEG2 files.

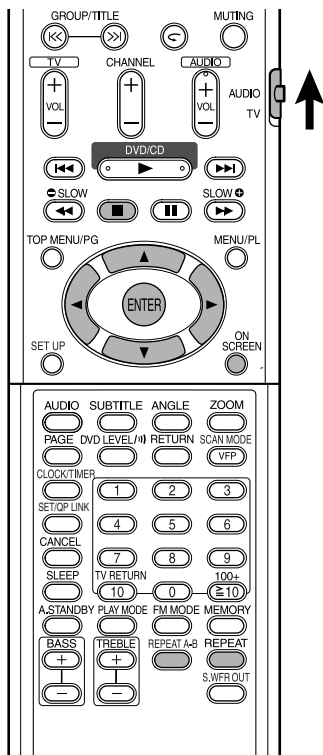

## Playing the title/chapter/group/track/all tracks repeatedly (REPEAT)

DVD VIDEO DVD AUDIO DVD VR VCD SVCD CD

Press REPEAT during playback.

- Each time you press the button, the Repeat mode and its indication change as follows:

For DVD VIDEO

Repeat items	On the TV	On the display window
Current chapter	CHAP	REP CHAP ↺ 1
Current title	TITLE	REP TTL ↺
Cancel	OFF	REP OFF

For DVD VR

Repeat items	On the TV	On the display window
Current chapter	CHAP	REP CHAP ↺ 1
Current original program	PG	REP PG ↺
All original programs	ALL	REP ALL ALL ↺
Current play list	PL	REP PL ↺
Cancel	OFF	REP OFF

For DVD AUDIO

Repeat items	On the TV	On the display window
Current track	TRACK	REP TRK ↺ 1
Current group	GROUP	REP GRP ↺
Cancel	OFF	REP OFF

For CD/VCD/SVCD

Repeat items	On the TV	On the display window
Current track	TRACK	REP TRK ↶ 1
All tracks	ALL	REP ALL ALL ↶
Cancel	OFF	REP OFF

**NOTE**

- For a VCD and SVCD, the operation can be carried out only when the disc is stopped or during playback without the PBC function.
- It is possible to set Repeat mode on the menu bar. For how to operate, refer to “Playing the designated part repeatedly (A-B Repeat Playback)” (See the right column).
- For a DVD VIDEO and DVD AUDIO, if the source is switched to FM, AM, USB or AUX, the Repeat mode will be canceled.

**Repeat Playback during Program or Random Playback**

Repeat items	On the TV	On the display window
Current chapter/track	STEP or REPEAT STEP	REP STEP ↶ 1
All tracks during Program/Random play	ALL or REPEAT ALL	REP ALL ALL ↶
Cancel	OFF or no indication	REP OFF

**Playing the designated part repeatedly (A-B Repeat Playback)**



**1 Press ON SCREEN twice during playback.**

The menu bar (page 28) will be displayed.

**2 Press cursor ◀/▶ to select**



**3 Press ENTER.**

**4 Press cursor ▲/▼ to display**

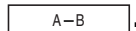

Other Repeat modes can be selected here. For other Repeat modes, refer to “Playing the title/chapter/group/track/all tracks repeatedly (REPEAT)” (page 22).

**5 Press ENTER at the start point of the part to be repeated (designating A point).**

- The icon on the menu bar will be .

**6 Press ENTER at the end point of the part to be repeated (designating B point).**

- The icon on the menu bar will be and the part between A and B points will be played repeatedly.
- A-B Repeat Playback will be canceled by carrying out the following operations:
  - Press .
  - Select and press **ENTER** twice.
  - Change the current track/file.

**NOTE**

- A-B Repeat Playback is possible only within the same title or track. A-B Repeat Playback cannot be carried out during PBC playback, Program Playback, Random Playback and Repeat Playback.
- You can use the A-B Repeat Playback using the REPEAT A-B button on the remote control.
- For some DVD discs, A-B Repeat Playback does not work.

# Other convenient functions

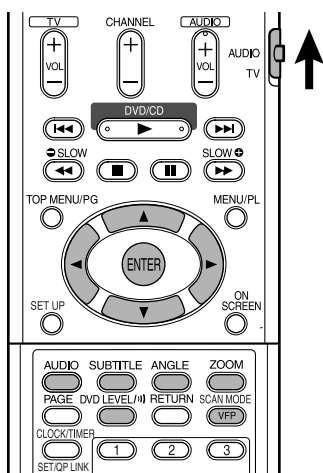

## Selecting the subtitles



(only for moving image)

- 1 Press **SUBTITLE** during playback of a disc containing subtitles in several languages.

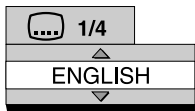
Ex.:  TV screen

- Each time you press the button, the subtitle will be alternated between ON and OFF.

- 2 Press cursor **▲/▼** to select a subtitle language.

- For a language code such as "AA", refer to "Language codes" (page 38).
- The manner of displaying subtitle languages may be different depending on the disc.

- 3 Wait for a few seconds or press **ENTER** to remove the window.

### NOTE

- It is also possible to operate by using the menu bar (page 28).
- For an SVCD, each time you press **SUBTITLE** in Step 1, the subtitle type and OFF will be alternated.

## Selecting the audio language



- 1 Press **AUDIO** during playback of a disc containing several audio languages.

Ex.:  TV screen

- Each time you press the button, the audio language will be alternated. Also, the audio language can be changed by pressing cursor **▲/▼**.
- For a language code such as "AA", refer to "Language codes" (page 38).
- "ST", "L" and "R" displayed when playing a VCD, SVCD or DVD VR respectively represent "Stereo", "Left sound" and "Right sound".

- 2 Wait for a few seconds or press **ENTER** to remove the window.

### NOTE

It is also possible to operate by using the menu bar (page 28).

## Selecting a view angle



(only for moving image)

- 1 Press **ANGLE** during playback of a scene containing multi-view angles.

Ex.:  TV screen

- Each time you press the button, the angle will be alternated. Also, the angle can be changed by pressing cursor **▲/▼**.

- 2 Wait for a few seconds or press **ENTER** to go off the window.

### NOTE

It is also possible to operate by using the menu bar (page 28).

## Enlarging the picture (ZOOM)

DVD VIDEO DVD VR VCD SVCD MPEG1 MPEG2 DVD AUDIO JPEG

(only for moving image)

### 1 Press ZOOM during playback or while paused.

- Each time you press the button, the picture magnification will be changed.
- For JPEG, you cannot change the picture magnification during slide-show playback.

### 2 Select the portion you want to see by using cursor ▲/▼/◀/▶.

- To resume normal playback, select "ZOOM OFF" in Step 1.

## Adjusting the picture quality (VFP)

DVD VIDEO DVD VR VCD SVCD JPEG MPEG1 MPEG2 DVD AUDIO

(only for moving image)

### 1 Press VFP during playback or while paused.

The current setting will be displayed on the TV screen.

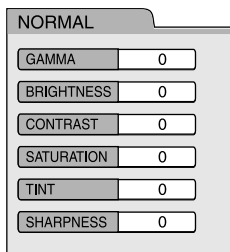

### 2 Press cursor ◀/▶ to select VFP mode.

- It is recommended to select "NORMAL" usually, or "CINEMA" in a dark room. When either "NORMAL" or "CINEMA" is selected, go to Step 7.
- When either "USER 1" or "USER 2" is selected, the adjustment can be carried out in detail in the operations after Step 3.

### 3 Press cursor ▲/▼ to select an item to be adjusted.

### 4 Press ENTER.

Ex.: TV screen



### 5 Press cursor ▲/▼ to change the value.

- **GAMMA:** Adjust this if the neutral color is bright or dark. The brightness of dark and bright portion is maintained.
- **BRIGHTNESS:** Adjust this if the picture is bright or dark on the whole.
- **CONTRAST:** Adjust this if the far and near position is unnatural.
- **SATURATION:** Adjust this if the picture is whitish or blackish.
- **TINT:** Adjust this if the appearance of flesh tone is unnatural.
- **SHARPNESS:** Adjust this if the picture is indistinct.

### 6 Press ENTER.

To adjust other items, go back to Step 3.

### 7 Press VFP to go off the window.

#### NOTE

- If no operation is made for several seconds during the procedure, the settings made so far will be automatically stored.
- "VFP" is an abbreviation of "Video Fine Processor".

## Making dialogues clear (CLEAR VOICE)

DVD VIDEO DVD AUDIO DVD VR VCD SVCD C D MP3 WMA  
MPEG1 MPEG2

### Press and hold DVD LEVEL/⏸ during playback.

The singer's voices or dialogues of the movie will be heard clear.

- Each time you press and hold the button, the clear voice function turns on and off alternately.

#### NOTE

Clear voice function only works for center-channel encoded multi-channel disc.

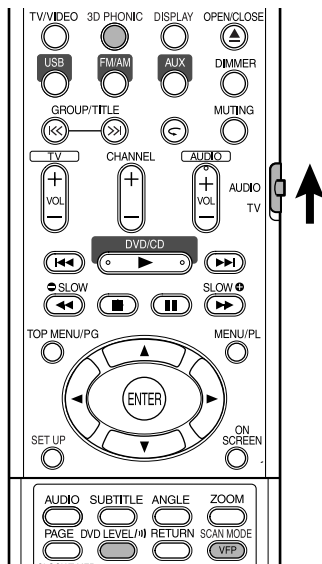

## Adjusting playback level (DVD LEVEL)



The audio of a DVD VIDEO may be recorded at a lower level (volume) than for other types of disc. If the difference is not to your liking, adjust the DVD Level.

### 1 Press DVD LEVEL during playback.

- Each time you press the button, the level will be alternated among “NORMAL”, “MIDDLE” and “HIGH”.
- Select the level while listening to the sound played.

#### NOTE

- DVD Level is effective only for playback of a DVD VIDEO or DVD VR.
- Even if the DVD Level is changed, the output level from the digital audio output terminal will not be changed.

## Creating realistic sound (3D PHONIC)



The two speakers produce an effect resembling surround-sound.

### 1 Press 3D PHONIC during playback.

Ex.: TV screen

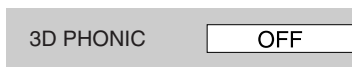

- Each time you press the button, the 3D PHONIC will be alternated as follows:
  - ACTION** : Suitable for action movies, sport programs or other lively programs.
  - DRAMA** : You can relax with a natural atmosphere.
  - THEATER** : You can enjoy the sound effect as if you were watching the movie in a theater.
  - OFF** : Cancels 3D PHONIC (initial setting).
- While 3D PHONIC is activated, “3D PHONIC” appears and the 3D PHONIC indicator lights on the display window.

#### NOTE

- 3D PHONIC is effective for the speakers and headphones.
- When noise is produced or sound is distorted, set 3D PHONIC to “OFF”.
- You cannot use this functions for some DVD AUDIO discs.
- For an MPEG1/MPEG2 disc, 3D Phonic does not work and creates no sound effect even when “ACTION”, “DRAMA”, “THEATER” is displayed.

## Enjoying better pictures (SCAN MODE)

In the Progressive mode, better pictures can be enjoyed.

#### IMPORTANT

- In order to enjoy pictures in the Progressive mode, connect this system and your TV with component video cord.
- If your TV does not have component video input terminal, leave the setting Interlace mode.

### Press and hold SCAN MODE for 4 seconds when there is no disc loaded or while the disc is stopped.

- Each time you press and hold the button, the scan mode alternates between the “PROGRESSIVE” mode and the “INTERLACE” mode.

#### NOTE

*Progressive mode:*

All scanning lines will be displayed at once. Pictures of higher resolution than those in the Interlace mode can be realized.

*Interlace mode:*

This is a conventional image method. Half of the scanning lines displayed in the Progressive mode will appear, alternating with the other half.

**DVD  
AUDIO**

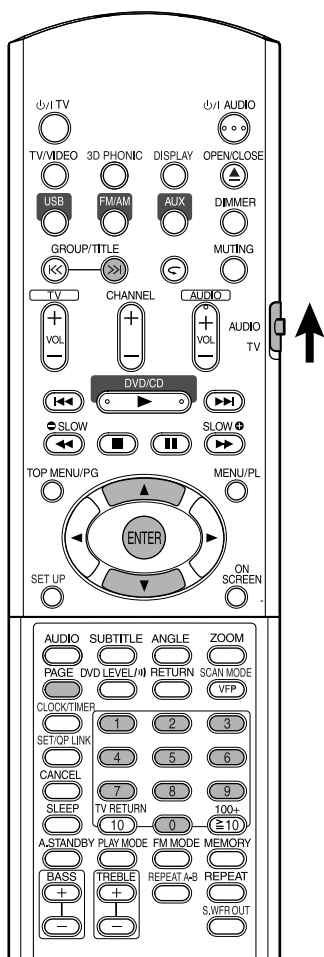

**NOTE**

Set the remote control mode selector to **AUDIO** before using the number buttons.



### Playing the Bonus Group

There are some DVD AUDIO discs with a special group, called "Bonus Group", recorded.

**NOTE**

This operation can be carried out when "BONUS" is lit on the display window on the main unit.

**1 Press GROUP/TITLE >> repeatedly during playback to select a bonus group.**

"KEY\_ \_ \_ \_" appears on the TV screen, and on the display window on the main unit.

- The bonus group is usually recorded as the last group.

**2 Press the number buttons to enter a pin code (4 digits).**

The method of getting a pin code may be different depending on the disc.

**3 Press ENTER.**

- When a correct pin code is entered, "BONUS" disappears and the playback of the bonus group starts.
- If an incorrect pin code is entered, try entering a correct pin code again.

### Browsable Still Pictures (B.S.P.)

There are some DVD AUDIO discs with still pictures recorded. Among the still pictures, there are pictures called B.S.P. (Browsable Still Pictures). With these pictures, it is possible to switch a picture as if turning over pages.

**NOTE**

This operation can be carried out when "B.S.P." is lit on the display window on the main unit.

**1 Press PAGE during playback.**

Each time you press the button, the still picture will be switched over. It is also possible to switch the picture using cursor ▲/▼.

Ex.: TV screen

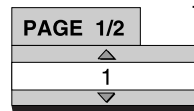

**2 Wait for a few seconds or press ENTER to remove the window.**



# Using the menu bar

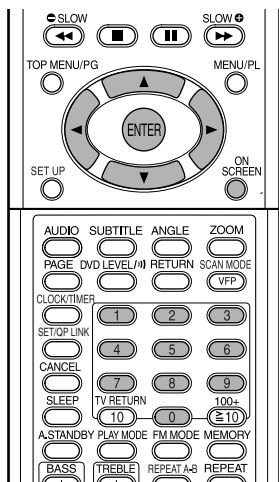

## NOTE

- Set the remote control mode selector to **AUDIO** before using the number buttons.
- This operation can be carried out when there is a disc loaded. There are some functions that may not work while the disc is stopped.



## 1 Press ON SCREEN twice.

The status bar and the menu bar will appear on the TV screen.

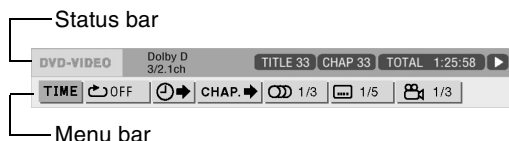

The above is an example for a DVD VIDEO.

## 2 Press cursor ◀/▶ to select an item to be operated.

## 3 Press ENTER.

- The selected function can be set. For the setting content, refer to the following "Functions list".
- The function currently activated is shown in blue.
- To remove the menu bar, press **ON SCREEN**.

## Functions list

For the functions with no special description for the operations, press cursor ▲/▼ to select, and press **ENTER** to determine.

<b>TIME</b> Time display selection	Select this to change time information displayed on the display window on the main unit and the status bar. Each time <b>ENTER</b> is pressed, the display will be alternated. <b>DVD VIDEO/DVD AUDIO (operating during playback)</b> TOTAL : Elapsed playing time of current title/group. T.REM : Remaining time of current title/group. TIME : Elapsed playing time of current chapter/track. REM : Remaining time of current chapter/track. <b>DVD VR (operating during playback)</b> TOTAL : Elapsed playing time of current title/group. T.REM : Remaining time of current title/group. <b>CD (operating during playback)/VCD/SVCD</b> TIME : Elapsed playing time of current track. REM : Remaining time of current track. TOTAL : Elapsed playing time of disc. T.REM : Remaining time of disc.
Repeat mode	See page 22.
Time search	See page 20.
<b>CHAP. ▶ / TRACK ▶</b> Chapter search (DVD VIDEO/DVD VR)/Track search (DVD AUDIO)	Select a chapter/track. Press the number buttons to input the chapter/track number and press <b>ENTER</b> . Ex.: 5: <b>5</b> 24: <b>2</b> → <b>4</b>
Audio language/Audio (DVD VIDEO/DVD AUDIO/VCD/SVCD)	See page 24.
Subtitle language (DVD VIDEO/DVD VR/SVCD)	See page 24.
View angle (DVD VIDEO/DVD AUDIO)	See page 24.
<b>PAGE</b> Page switch (DVD AUDIO)	Switch the still pictures (B.S.P.) recorded on a DVD AUDIO disc (page 27).

## Information displayed on the status bar

DVD VIDEO/DVD AUDIO/DVD VR (the example below is for a DVD VIDEO)

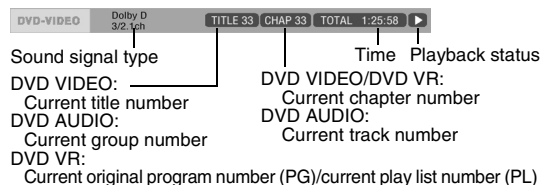

VCD/SVCD/CD/MPEG1/MPEG2 (the example below is for a CD)

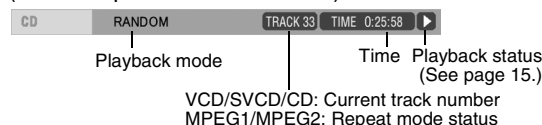

VCD/SVCD/CD: Current track number  
MPEG1/MPEG2: Repeat mode status

### NOTE

The playback status mark has the same meaning of the mark on the On-screen guide (page 15).

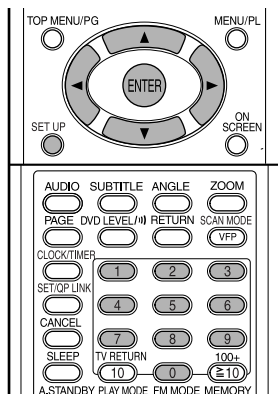

The initial settings of the system can be changed according to the environment the system is used in.

### NOTE

- Set the remote control mode selector to **AUDIO** before using the number buttons.
- The top and bottom of the preference screen may not be displayed on a wide TV. Adjust the picture size on the TV.



## Basic operations

Press **SET UP** while the disc is stopped or no disc is loaded (“**NO DISC**” is displayed).

- The following screen will be displayed on the TV.

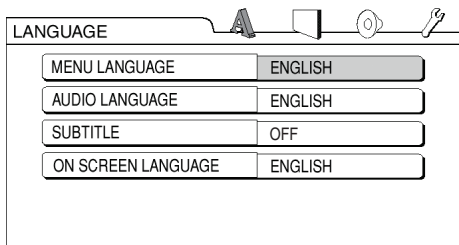

- Proceed with operations by following the description on the TV screen.



## LANGUAGE



### NOTE

- If the selected language is not recorded on the disc, the optimum language set for the disc will be displayed.
- For a language code such as “AA”, refer to the “Language codes” (page 38).

Items	Contents
<b>MENU LANGUAGE</b>	Select the language for the DVD VIDEO menu.
<b>AUDIO LANGUAGE</b>	Select the audio language for the DVD VIDEO.
<b>SUBTITLE</b>	Select the subtitle language for the DVD VIDEO.
<b>ON SCREEN LANGUAGE</b>	Select the language displayed on the preference screens.



## PICTURE

Items	Contents (  : initial setting)
<b>MONITOR TYPE</b>	<p>Select a display method suitable for your TV.  <b>16 : 9</b> :                      Select this for an ordinary wide TV.</p>  <p><b>4 : 3 LB (Letter Box)</b> :                      Select this when the aspect ratio of your TV is conventional 4:3. While viewing a wide screen picture, the black bars appear on the top and bottom of the screen.</p>  <p><b>4 : 3 PS (Pan Scan)</b> :                      Select this when the aspect ratio of your TV is conventional 4:3. While viewing a wide screen picture, the left and right edges of the picture will not be shown on the screen. (If the disc is not compatible with Pan Scan, the picture will be displayed at the Letter Box ratio.)</p> 
<b>PICTURE SOURCE</b>	<p>Select an item suitable to the video source.</p> <p><b>AUTO</b> :                      The video source type (a video or film) is automatically selected.</p> <p><b>FILM</b> :                      Select this item when you want to view a film or video recorded with the progressive scan method.</p> <p><b>VIDEO</b> :                      Select this item when you want to view a normal video.</p>
<b>SCREEN SAVER</b>	<p>Select the Screen Saver mode between <b>ON</b> / <b>OFF</b> (Screen Saver activates when there is no operation made for about 5 minutes since a still picture was last displayed).</p>
<b>FILE TYPE</b>	<p>Select an item suitable to the file type.</p> <p><b>AUDIO</b> :                      Select this item when you want to play back MP3/WMA files.</p> <p><b>STILL PICTURE</b> :                      Select this item when you want to play back JPEG files.</p> <p><b>VIDEO</b> :                      Select this item when you want to play back MPEG1/MPEG2 files.</p>



## AUDIO

Items	Contents ( <input type="checkbox"/> : initial setting)
<b>DIGITAL AUDIO OUTPUT</b>	<p>Select an output signal type from the following in accordance with the device connected to the digital audio output terminal (AV amplifier, etc.). (See the table below for the preference items and output signal.)</p> <p><b>PCM ONLY:</b> Device corresponding only to linear PCM.</p> <p><b>DOLBY DIGITAL/PCM:</b> Dolby digital decoder or a device having the same function.</p> <p><b>STREAM/PCM :</b> DTS/Dolby digital decoder or a device having the same function.</p>
<b>DOWN MIX</b>	<p>Switch signal from the digital output terminal of the DVD VIDEO according to the connected device. Select this when "DIGITAL AUDIO OUTPUT" is set to "PCM ONLY".</p> <p><b>DOLBY SURROUND:</b> A Dolby Pro Logic decoder-built-in device.</p> <p><b>STEREO :</b> An ordinary audio device.</p> <ul style="list-style-type: none"> <li>When 3D PHONIC is activated, Down Mix does not work.</li> </ul>
<b>D (Dynamic). RANGE COMPRESSION</b>	<p>To make adjustments for the difference between a high volume and a low volume when playing back with low volume (only for a DVD recorded with Dolby digital).</p> <p><b>AUTO :</b> D. Range Compression automatically works.</p> <p><b>ON:</b> D. Range Compression always works.</p>



## OTHERS

Items	Contents ( <input type="checkbox"/> : initial setting)
<b>RESUME</b>	Select <b>ON</b> /OFF. (page 18)
<b>ON SCREEN GUIDE</b>	Select <b>ON</b> /OFF. (page 15)

**Table of relationships of DIGITAL AUDIO OUTPUT preference items and output signal**

Playback disc	DIGITAL AUDIO OUTPUT		
	STREAM/PCM	DOLBY DIGITAL/PCM	PCM ONLY
48 kHz, 16/20/24 bits Linear PCM DVD VIDEO 96 kHz linear PCM DVD VIDEO	48 kHz, 16 bits stereo linear PCM		
48/96/192 kHz, 16/20/24 bits linear PCM DVD AUDIO			
44.1/88.2/176.4 kHz, 16/20/24 bits linear PCM DVD AUDIO	44.1 kHz, 16 bits stereo linear PCM		
DTS DVD VIDEO	DTS bit stream	48 kHz, 16 bits stereo linear PCM	
DOLBY DIGITAL DVD VIDEO/ DVD AUDIO	DOLBY DIGITAL bit stream		48 kHz, 16 bits stereo linear PCM
CD/VCD/SVCD	44.1 kHz, 16 bits stereo linear PCM/48 kHz, 16 bits linear PCM		
DTS CD	DTS bit stream	44.1 kHz, 16 bits linear PCM	
MP3/WMA/MPEG1/MPEG2 disc	32/44.1/48 kHz, 16 bits stereo linear PCM		

**NOTE**

While playing some DVD, digital signals may be emitted at 20 bits or 24 bits (at their original bit rate) through the OPTICAL DIGITAL OUT terminal if the discs are not copy-protected.

# Listening to a radio broadcast

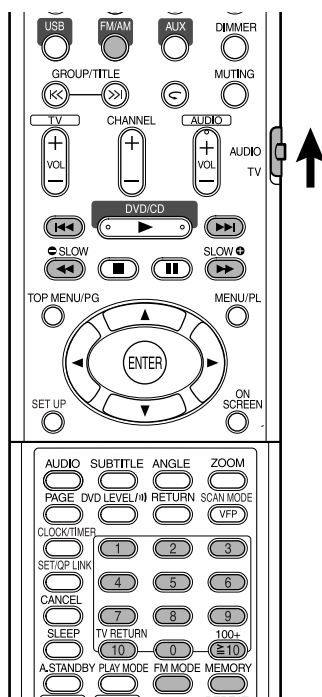

## NOTE

Set the remote control mode selector to **AUDIO** before using the number buttons.



## Selecting a station

### 1 Press FM/AM.

Each time you press the button, FM and AM change alternately.

### 2 Press **◀◀/▶▶** to select the station (frequency).

#### Automatic tuning:

Hold down **◀◀/▶▶** until the system starts searching, and then release the button. (The AUTO indicator lights while searching.) When a station of sufficient signal strength is tuned in to, the system stops searching automatically.

To stop searching manually, press **◀◀/▶▶**.

#### Manual tuning:

Each time you press **◀◀/▶▶**, the frequency changes.

- When an FM stereo program is received, the ST (Stereo) indicator lights.

## NOTE

If the stereo FM program currently tuned in to is noisy, you can improve the reception by pressing **FM MODE** to switch to the monaural mode. If you press **FM MODE** again, or tune in to another station, the receiving mode returns automatically to the stereo mode.

## Presetting stations

Presetting stations in the system allows you to easily tune in to a station.

The system stores up to 30 FM stations and up to 15 AM stations.

### 1 Select a station you want to store (page 31 for how to select).

### 2 Press **MEMORY**.

"MEMORY" is flashing on the display window for a while.

### 3 Select the number you want to store by pressing number buttons while "MEMORY" is flashing.

- Refer to "How to use the number buttons" (page 15).
- You can also select by pressing **◀◀/▶▶**.

### 4 Press **MEMORY** while the selected number is flashing.

"STORED" appears on the display window and the selected station is stored.

## NOTE

- Storing a new station to a used number erases the previously stored station.
- After storing new stations, do not unplug the AC power cord to turn off the system. If you do so, the new preset stations will be cleared.

## Tuning in to a preset station

### 1 Press **FM/AM** to select either FM or AM.

### 2 Press the number buttons to select the memory number of a station you want to tune in to.

- Refer to "How to use the number buttons" (page 15).
- You can also select by pressing **◀◀/▶▶**.

# Playing Back from the PC

This system is equipped with a USB terminal in the door of the front panel. You can connect your PC to this terminal and enjoy the sound out of your PC.

When you connect your PC for the first time, follow the procedure below.

Remember you cannot send any signal or data to your PC from this system.

## IMPORTANT

Always set volume to "VOL MIN" when connecting or disconnecting the other equipment.

## How to install the USB drivers

The following procedure is described using the English version of Windows® XP. If your PC is running on a different version of operation system or language, the screens shown on your monitor may differ from the ones used in the following procedure.

### 1 Turn on your PC and start running Windows® 98SE, Windows® Me, Windows® 2000 or Windows® XP.

- If the PC has been turned on, quit all the applications running.

### 2 Turn on the System and press USB.

### 3 Connect the System to the PC using a USB cable (not supplied).

(in the door of the front panel)

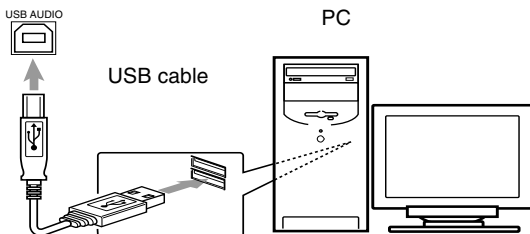

- Use "USB series A plug to B plug" cable (version 1.1 or later) less than 3 m (10.7 ft.).

## 4 The USB drivers are installed automatically.

- If the USB drivers are not installed automatically, install the USB drivers following the instructions on the PC's monitor.

## 5 Check if the drivers are correctly installed.

- 1 Open the Control Panel on your PC: Select [Start] → [Control Panel]
- 2 Click [System] → [Hardware] → [Device Manager] → [Sound, video and game controllers] and [Universal Serial Bus controllers].
- 3 Check whether the following items appear.
  - USB Audio Device
  - USB Composite Device

If the items cannot be shown, disconnect the USB cable and connect it again. If it does not work yet, turn off your PC and repeat from Step 1.

## To play back sounds on the PC

Refer to the manuals supplied with the music application software installed in the PC.

## Start the application.

### NOTE

- *Noise and static electricity may stop the sound through the USB connection. In this case, do the following operations:*
  - Disconnect and connect the USB cable again
  - Restart the music software on your PC
  - Turn off and on the system
- *DO NOT turn off the system and disconnect the USB cable while installing drivers and playing back, and for several seconds after your PC is recognized the system.*
- *The installed drivers can be shown only when the system is connected to the PC.*

\* Microsoft®, Windows® 98SE, Windows® Me, Windows® 2000 and Windows® XP are registered trademarks of Microsoft corporation.

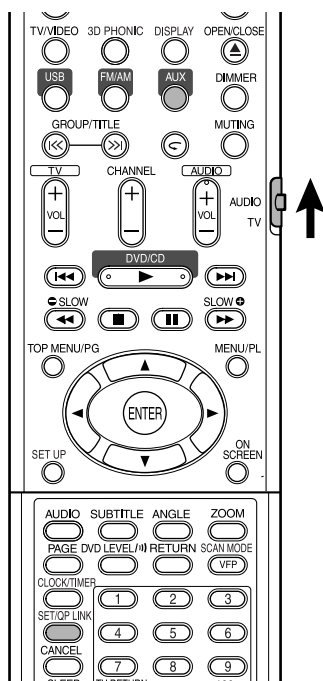

## Listening to the sound of external audio device

Connect the other audio device to this system in advance (page 10).

### 1 Press AUX.

The source changes to AUX.

Each time you press the button, the source changes between AUX 1 (front) and AUX 2 (rear).

### 2 Play the other audio device.

For details, refer to the manual of the device connected.

### 3 Adjust the volume and the sound quality of the system (page 16).

## Listening to the sound of portable audio device

By using QP Link (Quick Portable Link), you can easily start playing back a portable audio device connected to the AUX 1 jack.

- Make sure to set the volume of your portable audio device loud enough so that system can detect the sound signal.
- QP Link is available even if the system is on standby.

### Press and hold SET/QP LINK.

- Each time you press and hold the button, the QP Link function turns on and off alternately.
- QPL ON appears when QP Link is activated.

When QP Link is activated, connecting the portable audio device to the AUX 1 jack and starting playback performs the following:

- **While listening to another source...**  
Changes the source to AUX 1 automatically. (If you change from AUX 1 to another source, QP Link will be canceled.)
- **While the system is on standby...**  
Turns on the system and activates the AUX 1 source automatically (except when the display is turned off.)

### NOTE

- *Changing from AUX 1 to another source while QP Link works will deactivate QP Link temporarily. In this case, the following reactivates QP Link:*
  - Pressing and holding **SET/QP LINK** on the remote control.
  - Unplug the device from the AUX 1 jack, then plug it in again.
- *If you press **OFF/| AUDIO** to turn the system off or if preset Timer turns the system off while QP Link works, the system will deactivate QP Link temporarily. In such cases, the following reactivates QP Link:*
  - When the sound signal from the AUX 1 jack stops or is too weak for about 30 seconds after the system is turned off.
  - When you turn on the power again.
- *QP Link may start working when you just plug in the device to the AUX 1 jack or unplug it. This is not a malfunction.*

## Adjusting the audio input level

If the sound from the audio device connected to the AUX 1 or AUX 2 jack is too loud or is too quiet when changing from another source to "AUX," you can change the audio input level through the AUX 1 or AUX 2 jack (without changing the volume level).

**Press and hold AUX for 2 seconds while the AUX is selected as the source.**

Each time you press and hold the button, the audio input level alternates between AUX LEVEL 1 and AUX LEVEL 2.

### AUX LEVEL 1:

Select this when the sound is too loud with "AUX LEVEL 2" selected. This setting is recommended when connecting an audio device other than a portable audio device to AUX 1 jack.

### AUX LEVEL 2:

Select this when listening to a portable audio device.

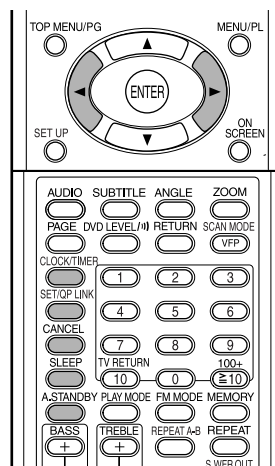

## Setting the built-in clock

Without setting the built-in clock, you cannot use any timers.

- To exit from the clock setting, press **CLOCK/TIMER** as required.
- To correct a misentry during the procedure below, pressing **CANCEL** can return to the previous step.

### 1 Press CLOCK/TIMER.

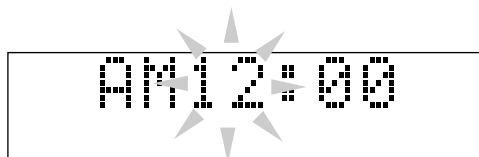

- If you have already adjusted the clock before, press the button repeatedly until the clock time starts flashing.

### 2 Press cursor ◀/▶ to adjust the hour, then press SET/QP LINK.

### 3 Press cursor ◀/▶ to adjust the minute, then press SET/QP LINK.

Now the built-in clock starts to work.

## Setting the daily timer

Using the daily timer, you can wake up with your favorite song.

- You can store the three daily timer settings; however, you can activate only one of the daily timer.
- To correct a misentry during the procedure below, pressing **CANCEL** can return to the previous step.

### How the daily timer works:

Once the daily timer has been set, the timer indicator and timer number indicator (1/2/3) are lit on the display window. Daily timer turns on the system at the same time everyday until the timer setting is canceled manually or another daily timer is activated.

### When the on-time comes:

The system turns on, tunes in to the specified station or starts playback the loaded disc with the specified chapter or track, and sets the volume level gradually to the preset level after about 30 seconds.

- The timer setting remains in memory until you change it.
- Without canceling the daily timer, you can change the source or adjust the volume after the daily timer starts playback.

## 1 Press **CLOCK/TIMER** repeatedly to show "DAILY 1."

- Each time you press the button, the clock setting changes as follows:

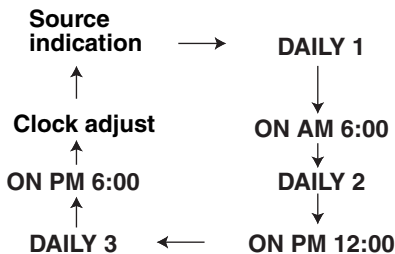

## 2 Press cursor **◀/▶** to adjust the hour of the timer-on time, then press **SET/QP LINK**.

## 3 Press cursor **◀/▶** to adjust the minute of the timer-on time, then press **SET/QP LINK**.

## 4 Repeat Step 2 and 3 to set the timer-off time.

## 5 Press cursor **◀/▶** to select the playback source, then press **SET/QP LINK**.

- Each time you press the button, the clock setting changes as follows:

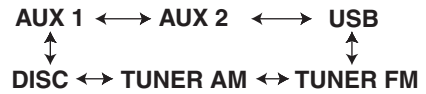

- When selecting the tuner, press cursor **◀/▶** to select a preset channel.
- When selecting "DISC", you can specify the group and track. For the discs other than MP3/WMA, the group selection does not take effect.

## 6 Press cursor **◀/▶** to adjust the volume level, then press **SET/QP LINK**.

## 7 Turn off the system.

### To turn off the timer setting

## 1 Press **CLOCK/TIMER** repeatedly to select the timer setting.

## 2 Press **CANCEL** to turn off the selected setting.

- Pressing **SET/QP LINK** activates the timer setting again.



### Auto Standby

If there is no operation for 3 minutes while the disc is stopped, the power will be automatically turned off.

**Press A.STANDBY during playback or while the disc is stopped, or no disc is loaded (“NO DISC” appears).**

The A.STANDBY indicator lights on the display window on the main unit.

When a stopped state is entered (after playback is finished, for example), the A.STANDBY indicator starts blinking.

This means that the power will be turned off automatically if there is no operation for 3 minutes. And 10 seconds before the power is turned off, “A.STANDBY” starts flashing.

### Releasing Auto Standby

---

Press **A.STANDBY**.

“A.STANDBY” will be turned off on the display window on the main unit.

#### **NOTE**

*When the source is FM, AM, USB or AUX, Auto Standby does not work.*

### Sleep Timer

When the time you specify elapses, the system will be turned off by itself.

**Press SLEEP.**

Each time you press the button, the time indicated on the display window on the main unit changes (in minutes).

### Changing the time

---

Reselect the time by pressing **SLEEP** repeatedly.

### Confirming the time

---

Press **SLEEP** once while Sleep Timer is set.

### Releasing

---

Press **SLEEP** repeatedly until “SLEEP OFF” appears.

#### **NOTE**

*Sleep Timer will also be released when the power is turned off.*

### Tray Lock

---

You can lock the disc tray to prevent the disc from being ejected.

### Setting

---

While the system is turned off, press **▲** (Open/Close) with **■** (Stop) on the main unit held. “LOCKED” appears on the display window on the main unit.

### Releasing

---

Carry out the same operations as those for setting. “UNLOCKED” appears on the display window on the main unit.

When you encounter a problem that seems to be a fault, check the following points before contacting your JVC service center.

## Power source

---

### ■ Power does not come on.

- The power cord is not connected to the main unit or an AC outlet.  
→ Connect the power cord correctly (page 11).

## Operation

---

### ■ You cannot operate any button.

- Some specific operations may be inhibited for some discs.

### ■ The remote control does not work.

- The dry-cell batteries have run out.  
→ Replace the batteries (page 6).

### ■ A disc cannot be played back.

- In the case of DVD VIDEO discs  
→ Check the Region Code number of the discs (page 3).
- “NO PLAY” is displayed on the display window.  
It is not a disc that can be played on this system.  
→ Check the disc type (page 3).

### ■ MP3/WMA/JPEG/MPEG1/MPEG2 files cannot be played back.

- The loaded disc may include files of different types (MP3, WMA, JPEG, MPEG1 or MPEG2). You can play back only the files whose types selected in “FILE TYPE”. (page 29).

## About images

---

### ■ No picture appears.

- The video cord is not connected correctly.  
→ Page 11
- Both of the component video jack and S-video jack are connected.  
→ Connect either (page 11).

### ■ The picture is distorted.

- A VCR is connected between the main unit and the TV set.  
→ Connect the main unit directly to the TV set (page 11).
- Although this system is connected to a non-Progressive TV set, DVD's scan mode is set to “PROGRESSIVE”.  
→ Set the scan mode to “INTERLACE” (page 26).

### ■ The screen size is abnormal.

- The screen size is set improperly.  
→ Set “MONITOR TYPE” according to the TV set you are using (page 29).

### ■ The TV screen darkens.

- “SCREEN SAVER” is set.  
→ Press any button to deactivate the function (page 29).

## About sound

---

### ■ There is no sound.

- Speakers are not connected correctly.  
→ Page 9
- The sound is muted.  
→ Page 16
- “NO AUDIO” is displayed on the display window.  
The disc may have been produced through illegal copying.  
→ Confirm at the store where you bought the disc.

### ■ The sound is weak compared with TV or Video.

- “DVD LEVEL” is set to “NORMAL”.  
→ Set to other than “NORMAL” (page 26).

### ■ The sound is distorted.

- The volume is turned up too high.  
→ Turn down the volume (page 16).

### ■ No sound comes out of the subwoofer.

- “SUBWOOFER” is turned off.  
→ Press **S.WFR OUT** to turn on (page 10).

### ■ The sound through the USB connection stops.

- Noise and static electricity may stop the sound through the USB connection. In this case, do the following operations:  
→ Disconnect and connect the USB cable again  
→ Restart the music software on your PC  
→ Turn off and on the system

**About radio**

■ **The sound is noisy while receiving/Receiving is disabled.**

- The antenna is not connected correctly.  
→ Connect the antenna correctly (page 8).

**Others**

■ **It is not possible to switch audio or subtitles between languages.**

- The disc does not contain 2 or more languages.  
→ If only a single language is recorded on the disc, switching to another language is impossible (page 24).

■ **No subtitle is displayed.**

- The disc does not contain any subtitles.  
→ A DVD VIDEO without subtitles cannot display any subtitles.
- The subtitle language is set to “OFF”.  
→ Specify a language (page 29).
- Before or after A point or B point in A-B Repeat Playback, no subtitle may be displayed.

■ **The disc cannot be ejected.**

- Tray Lock is set.  
→ page 36

■ **“LR ONLY” is displayed on the display window (for a DVD AUDIO).**

- Because, for the track being played back, down mix is inhibited for multi-channel sound, the sound of L and R is output directly (a normal action).

■ **The system automatically turns on even if the Timer turn the system to standby or if you turn the system to standby while playback is going on the portable audio device.**

- In this case, deactivate QP Link or stop playback on the device connected to the AUX 1 jack.

**If the system does not work properly despite correction measures above**

Many functions of this system are implemented by microcomputers. If pressing any button does not result in the normal action, disconnect the power plug from the outlet, wait for a while, and reconnect the system.

Code	Language	Code	Language
AA	Afar	MK	Macedonian
AB	Abkhazian	ML	Malayalam
AF	Afrikaans	MN	Mongolian
AM	Ameharic	MO	Moldavian
AR	Arabic	MR	Marathi
AS	Assamese	MS	Malay (MAY)
AY	Aymara	MT	Maltese
AZ	Azerbaijani	MY	Burmese
BA	Bashkir	NA	Nauru
BE	Byelorussian	NE	Nepali
BG	Bulgarian	NL	Dutch
BH	Bihari	NO	Norwegian
BI	Bislama	OC	Occitan
BN	Bengali, Bangla	OM	(Afan) Oromo
BO	Tibetan	OR	Oriya
BR	Breton	PA	Panjabi
CA	Catalan	PL	Polish
CO	Corsican	PS	Pashto, Pushto
CS	Czech	PT	Portuguese
CY	Welsh	QU	Quechua
DA	Danish	RM	Rhaeto-Romance
DZ	Bhutani	RN	Kirundi
EL	Greek	RO	Rumanian
EO	Esperanto	RW	Kinyarwanda
ET	Estonian	SA	Sanskrit
EU	Basque	SD	Sindhi
FA	Persian	SG	Sangho
FI	Finnish	SH	Serbo-Croatian
FJ	Fiji	SI	Singhalese
FO	Faroese	SK	Slovak
FY	Frisian	SL	Slovenian
GA	Irish	SM	Samoan
GD	Scots Gaelic	SN	Shona
GL	Galician	SO	Somali
GN	Guarani	SQ	Albanian
GU	Gujarati	SR	Serbian
HA	Hausa	SS	Siswati
HI	Hindi	ST	Sesotho
HR	Croatian	SU	Sundanese
HU	Hungarian	SV	Swedish
HY	Armenian	SW	Swahili
IA	Interlingua	TA	Tamil
IE	Interlingue	TE	Telugu
IK	Inupiak	TG	Tajik
IN	Indonesian	TH	Thai
IS	Icelandic	TI	Tigrinya
IW	Hebrew	TK	Turkmen
JI	Yiddish	TL	Tagalog
JW	Javanese	TN	Setswana
KA	Georgian	TO	Tonga
KK	Kazakh	TR	Turkish
KL	Greenlandic	TS	Tsonga
KM	Cambodian	TT	Tatar
KN	Kannada	TW	Twi
KO	Korean (KOR)	UK	Ukrainian
KS	Kashmiri	UR	Urdu
KU	Kurdish	UZ	Uzbek
KY	Kirghiz	VI	Vietnamese
LA	Latin	VO	Volapuk
LN	Lingala	WO	Wolof
LO	Laothian	XH	Xhosa
LT	Lithuanian	YO	Yoruba
LV	Latvian, Lettish	ZU	Zulu
MG	Malagasy		
MI	Maori		

## General

Power source:	AC 120 V ~ , 60 Hz
Power consumption:	25 W (in operation)/ 4.0 W (on standby/display on) 1.0 W (on standby/display off)
Weight:	2.6 kg (5.7 lbs)
External dimensions (W x H x D):	150 mm x 152.6 mm x 252.9 mm (5 <sup>15</sup> / <sub>16</sub> in. x 6 <sup>1</sup> / <sub>16</sub> in. x 10 in.)

## DVD player

Playable discs:	DVD VIDEO, DVD AUDIO, VCD, SVCD, CD CD-R/RW (VCD/SVCD/CD/MP3/WMA/JPEG/MPEG1/MPEG2 format) DVD-R/-RW (MP3/WMA/JPEG/DVD VIDEO/DVD VR [CPRM]/MPEG1/MPEG2 format) DVD-ROM (MP3/WMA/JPEG/MPEG1/MPEG2/DVD VR [CPRM] format)
-----------------	--

## Video output

Color system:	NTSC
Horizontal resolution:	500 lines
Composite x1:	1.0 V (p-p)/75 Ω, synchronization negative
S-video x1:	Y output: 1.0 V (p-p)/75 Ω, synchronization negative C output: 0.286 V (p-p)/75 Ω
Component x1:	Y output: 1.0 V (p-p)/75 Ω P <sub>B</sub> /P <sub>R</sub> output: 0.7 V (p-p)/75 Ω

## Audio output

Analog sound output:	
Speakers x2	
<b>Output power:</b>	<b>20 W per channel min., RMS, at 4 Ω at 1 kHz with no more than 10% total harmonic distortion</b>
Fitting impedance:	4 Ω to 16 Ω
Headphones x1:	11 mW/32 Ω
Fitting impedance:	16 Ω to 1 kΩ
Subwoofer x1:	500 mVrms/10 kΩ
Digital sound output:	
Optical x1:	-21 dBm to -15 dBm

## Audio input

Sound input:	AUX 1: 400 mV/50 kΩ 200 mV/50 kΩ AUX 2: 1.5 V/50 kΩ 750 mV/50 kΩ USB: AUDIO x 1
--------------	---

## Tuner

FM tuner:	
Receiving frequency:	87.5 MHz to 108.0 MHz
Antenna:	75 Ω Unbalanced type
AM (MW) tuner:	
Receiving frequency:	530 kHz to 1 710 kHz
Antenna:	External antenna jack (loop antenna)

## Speaker

Type:	Full range 1-way bass-reflex type Magnetically shielded type
Speaker:	8 cm (3 <sup>3</sup> / <sub>16</sub> inches) wood cone x1
Frequency response:	55 Hz to 20 000 Hz
Power handling capacity:	20 W
Impedance:	4 Ω
Sound pressure level:	80 dB/W·m
Dimension (W x H x D):	120 mm x 150.5 mm x 243 mm (4 <sup>3</sup> / <sub>4</sub> in. x 6 in. x 9 <sup>5</sup> / <sub>8</sub> in.)
Weight:	1.8 kg (4.0 lbs) each

- Manufactured under license from Dolby Laboratories. “Dolby”, “Pro Logic”, “MLP lossless”, and the double-D symbol are trademarks of Dolby Laboratories.
- “DTS” and “DTS 2.0+ Digital Out” are trademarks of Digital Theater Systems, Inc.
- This product incorporates copyright protection technology that is protected by U.S. patents and other intellectual property rights. Use of this copyright protection technology must be authorized by Macrovision, and is intended for home and other limited viewing uses only unless otherwise authorized by Macrovision. Reverse engineering or disassembly is prohibited.

Designs and Specifications are subject to change without notice.

# ***TO OUR VALUED CUSTOMER*** ———

THANK YOU FOR PURCHASING THIS JVC PRODUCT.  
WE WANT TO HELP YOU ACHIEVE A PERFECT EXPERIENCE.

**NEED HELP ON HOW TO HOOK UP?  
NEED ASSISTANCE ON HOW TO OPERATE?  
NEED TO LOCATE A JVC SERVICE CENTER?  
LIKE TO PURCHASE ACCESSORIES?**

**JVC<sup>®</sup> IS HERE TO HELP!**  
**TOLL FREE: 1(800)252-5722**  
**<http://www.jvc.com>**

Remember to retain your Bill of Sale for Warranty Service.

————— **Do not attempt to service the product yourself** —————

**Caution**

To prevent electrical shock, do not open the cabinet.  
There are no user serviceable parts inside.  
Please refer to qualified service personnel for repairs.

---



# LIMITED WARRANTY

AUDIO-1 **USA ONLY**

**ONLY FOR PRODUCT PURCHASED IN U.S.A.**

JVC COMPANY OF AMERICA (JVC) warrants this product and all parts thereof, except as set forth below ONLY TO THE ORIGINAL RETAIL PURCHASER to be FREE FROM DEFECTIVE MATERIALS AND WORKMANSHIP from the date of original purchase for the period shown below. ("The Warranty Period")

PARTS	<b>1 YR</b>	LABOR	<b>1 YR</b>
-------	-------------	-------	-------------

**THIS LIMITED WARRANTY IS VALID ONLY IN THE FIFTY (50) UNITED STATES, THE DISTRICT OF COLUMBIA AND IN THE COMMONWEALTH OF PUERTO RICO.**

**WHAT WE WILL DO:**

If this product is found to be defective within the warranty period, JVC will repair or replace defective parts with new or rebuilt equivalents at no charge to the original owner. Such repair and replacement services shall be rendered by JVC during normal business hours at JVC authorized service centers. Parts used for replacement are warranted only for the remainder of the Warranty Period. All products may be brought to a JVC authorized service center on a carry-in basis. Color televisions with a screen size of 27" or greater qualify for in-home service. In such cases, a technician will come to your home and either repair the TV there or remove and return it if it cannot be repaired in your home.

**WHAT YOU MUST DO FOR WARRANTY SERVICE:**

*Please do not return your product to the retailer*

Instead, return your product to the JVC authorized service center nearest you. If shipping the product to the service center, please be sure to package it carefully, preferably in the original packaging, and include a brief description of the problem(s). Please call 1-800-252-5722 to locate the nearest JVC authorized service center. Service locations can also be obtained from our website <http://www.jvc.com>. If your product qualifies for in-home service, the service representative will require clear access to the product.

If you have any questions concerning your JVC Product, please contact our Customer Relations Department at 800-252-5722

**WHAT IS NOT COVERED:**

This limited warranty provided by JVC does not cover:

1. Products which have been subject to abuse, accident, alteration, modification, tampering, negligence, misuse, faulty installation, lack of reasonable care, or if repaired or serviced by anyone other than a service facility authorized by JVC to render such service, or if affixed to any attachment not provided with the products, or if the model or serial number has been altered, tampered with, defaced or removed;
2. Initial installation, installation and removal from cabinets or mounting systems.
3. Operational adjustments covered in the Owner's Manual, normal maintenance, video and audio head cleaning;
4. Damage that occurs in shipment, due to act of God, and cosmetic damage;
5. Signal reception problems and failures due to line power surge;
6. Video Pick-up Tubes/CCD Image Sensors are covered for 90 days from the date of purchase;
7. Accessories;
8. Batteries (except that Rechargeable Batteries are covered for 90 days from the date of purchase);
9. Products used for commercial purposes, including, but not limited to rental.

There are no express warranties except as listed above.

THE DURATION OF ANY IMPLIED WARRANTIES, INCLUDING THE IMPLIED WARRANTY OF MERCHANTABILITY, IS LIMITED TO THE DURATION OF THE EXPRESS WARRANTY HEREIN.

JVC SHALL NOT BE LIABLE FOR ANY LOSS OF USE OF THE PRODUCT, INCONVIENCE, OR ANY OTHER DAMAGES, WHETHER DIRECT, INCIDENTAL OR CONSEQUENTIAL (INCLUDING, WITHOUT LIMITATION, DAMAGE TO TAPES, RECORDS OR DISCS) RESULTING FROM THE USE OF THIS PRODUCT, OR ARISING OUT OF ANY BREACH OF THIS WARRANTY. ALL EXPRESS AND IMPLIED WARRANTIES, INCLUDING THE WARRANTIES OF MERCHANTABILITY AND FITNESS FOR PARTICULAR PURPOSE, ARE LIMITED TO THE WARRANTY PERIOD SET FORTH ABOVE.

Some states do not allow the exclusion of incidental or consequential damages or limitations on how long an implied warranty lasts, so these limitations or exclusions may not apply to you. This warranty gives you specific legal rights and you may also have other rights which vary from state to state.

JVC COMPANY OF AMERICA  
 DIVISION OF JVC AMERICAS CORP.  
<http://www.jvc.com>

1700 Valley Road  
 Wayne, NJ 07470

REFURBISHED PRODUCTS CARRY A SEPARATE WARRANTY, THIS WARRANTY DOES NOT APPLY. FOR DETAIL OF REFURBISHED PRODUCT WARRANTY, PLEASE REFER TO THE REFURBISHED PRODUCT WARRANTY INFORMATION PACKAGED WITH EACH REFURBISHED PRODUCT.

**For customer use:**

Enter below the Model No. and Serial No. which is located either on the rear, bottom or side of the cabinet. Retain this information for future reference.

Model No. :	Serial No. :
Purchase date :	Name of dealer :

**JVC**

