

JVC

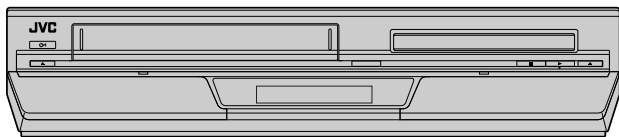

DVD PLAYER &
VIDEO CASSETTE RECORDER

HR-XV38SAG HR-XV38SAS



G-CODE® / SHOWVIEW™

Hi-Fi

VHS
PAL NTSC

SQPB

3D
3D-PHONIC

DVD
VIDEO™

dt
2.0+DIGITAL OUT

DOLBY
DIGITAL

COMPACT
disc
DIGITAL VIDEO

COMPACT
disc
SUPER VIDEO

COMPACT
disc
DIGITAL AUDIO



INSTRUCTIONS

LPT1016-001B

EN

Safety Precautions

The rating plate and the safety caution are on the rear of the unit.

WARNING: DANGEROUS VOLTAGE INSIDE

WARNING: TO PREVENT FIRE OR SHOCK HAZARD, DO NOT EXPOSE THIS UNIT TO RAIN OR MOISTURE.

CAUTION

- When you are not using the unit for a long period of time, it is recommended that you disconnect the power cord from the mains outlet.
- Dangerous voltage inside. Refer internal servicing to qualified service personnel. To prevent electric shock or fire hazard, remove the power cord from the mains outlet prior to connecting or disconnecting any signal lead or aerial.

ATTENTION (VHS deck only)

1. This recorder can also receive SECAM colour television signals for recording and playback.
2. Recordings made of SECAM television signals produce monochrome pictures if played back on another video recorder of SECAM standard, or do not produce normal colour pictures if played back on another video recorder of PAL standard.
3. SECAM prerecorded cassettes or recordings made with a SECAM video recorder produce monochrome pictures when played back with this recorder.

IMPORTANT

- Please read the various precautions on pages 2 and 3 before installing or operating the unit.
- It should be noted that it may be unlawful to re-record pre-recorded tapes, DVDs, or discs without the consent of the owner of copyright in the sound or video recording, broadcast or cable programme and in any literary, dramatic, musical, or artistic work embodied therein.

CAUTION

A DVD/VCR IS A CLASS 1 LASER PRODUCT. HOWEVER THIS DVD/VCR USES A VISIBLE LASER BEAM WHICH COULD CAUSE HAZARDOUS RADIATION EXPOSURE IF DIRECTED. BE SURE TO OPERATE THE UNIT CORRECTLY AS INSTRUCTED.

WHEN THIS DVD/VCR IS PLUGGED INTO THE WALL OUTLET, DO NOT PLACE YOUR EYES CLOSE TO THE OPENING OF THE DISC TRAY AND OTHER OPENINGS TO LOOK INTO THE INSIDE OF THIS DVD/VCR. USE OF CONTROLS OR ADJUSTMENTS OR PERFORMANCE OF PROCEDURES OTHER THAN THOSE SPECIFIED HEREIN MAY RESULT IN HAZARDOUS RADIATION EXPOSURE. DO NOT OPEN COVERS AND DO NOT REPAIR YOURSELF. REFER SERVICING TO QUALIFIED PERSONNEL.

CLASS 1 LASER PRODUCT

REPRODUCTION OF LABELS

WARNING LABEL INSIDE OF THE UNIT

<p>CAUTION: Visible and invisible laser radiation when open and interlock failed or defeated. AVOID DIRECT EXPOSURE TO BEAM.</p>	<p>ADVARSEL: Synlig og usynlig laserstråling når maskinen er åben eller interlocken fejler. Undgå direkte eksponering til stråling.</p>	<p>VARNING : Synlig och osynlig laserstråling när den öppnas och spårren är urkopplad. Betrakta ej strålen.</p>	<p>VARO: Avattaessa ja suojalukitus ohitettuna tai viallisena olet alttina näkyvälle ja näkymättömälle lasersäteilylle. Vältä säteeen kohdistumista suoraan itseesi. (f)</p>
---	--	--	---

Use only discs marked with the following.



DVD
(8 cm /12 cm disc)



Video CDs
(8 cm /12 cm disc)



Audio CDs
(8 cm /12 cm disc)



Super Video CDs
(8 cm /12 cm disc)



- Manufactured under license from Dolby Laboratories. "Dolby" and the double-D symbol are trademarks of Dolby Laboratories.
 - "DTS" and "DTS 2.0+ Digital Out" are trademarks of Digital Theater Systems, Inc.
 - Cassettes marked "VHS" (or "S-VHS") can be used with this video cassette recorder. However, S-VHS recording is not possible with this model.
 - This model is equipped with SQPB (S-VHS QUASI PLAYBACK) that makes it possible to play back S-VHS recordings in the SP mode with regular VHS resolution.
 - HQ VHS is compatible with existing VHS equipment.
 - G-CODE is a trademark of Gemstar Development Corporation and is registered in the following countries: Australia, China, Hong Kong, Japan, South Korea, New Zealand, and Taiwan. SHOWVIEW is a trademark of Gemstar Development Corporation and is registered in the following countries: Austria, Belgium, Czech Republic, Denmark, Finland, France, Germany, Hungary, Iceland, Italy, Luxembourg, Netherlands, Norway, Poland, Portugal, Russia, Slovakia, South Africa, Spain, Sweden and Switzerland. The G-CODE/SHOWVIEW system is manufactured under license from Gemstar Development Corporation.
- G-CODE and SHOWVIEW are different trademarks used to represent the same easy recording feature. However, for simplicity, only the term G-CODE will be used in the instructions. If you use SHOWVIEW system, follow the same steps listed for the G-CODE system.
- This product incorporates copyright protection technology that is protected by U.S. patents and other intellectual property rights. Use of this copyright protection technology must be authorized by Macrovision Corporation, and is intended for home and other limited viewing uses only unless otherwise authorized by Macrovision. Reverse engineering or disassembly is prohibited.

LP41077-001A

Contents

SAFETY FIRST	2
Safety Precautions	2
DISC INFORMATION	4
About Discs	4
INDEX	6
INSTALLING YOUR NEW UNIT	9
Basic Connections	9
Component Video Connection (DVD deck)	10
Scan Mode Set (DVD deck)	11
S-VIDEO Connection (DVD deck)	12
INITIAL SETTINGS	13
Video Channel Set	13
Auto Set Up	14
Monitor Set (DVD deck)	15
Language	16
Clock Set	19
OPERATIONS ON VHS DECK	20
Basic Playback	20
Playback Features	21
Basic Recording	23
Recording Features	24
B.E.S.T. Picture System	25
G-CODE [®] /SHOWVIEW [™] System Setup	26
G-CODE [®] /SHOWVIEW [™] Timer Programming	27
Express Timer Programming	29
Automatic Satellite Programme Recording	32
OPERATIONS ON DVD DECK	33
Basic Playback	33
Playback Features	34
Using the on-screen bar	40
MP3/JPEG files Playback	42
EDITING (VHS DECK)	45
Edit From A Camcorder	45
Edit To Or From Another Video Recorder	46
Dubbing (from DVD to VHS)	47
EDITING (DVD DECK)	48
Digital Audio Dubbing	48
REMOTE CONTROL	49
Remote Control Functions	49
SYSTEM CONNECTIONS	51
Connecting To A Satellite Receiver	51
Connecting To A Dolby Digital Decoder or An Amplifier With A Built-in DTS (DVD deck)	52
SUBSIDIARY SETTINGS	53
Function Set (VHS deck)	53
Mode Set (DVD deck)	56
Tuner Set	60
Information on Multi-System Compatibility (VHS deck)	65
TROUBLESHOOTING	67
SPECIFICATIONS	70
LIST OF TERMS	71

POWER SYSTEM:

This set operates on voltage of AC110 – 240 V~ (Rating), AC90 – 260 V ~ (Operating), 50Hz/60Hz with automatic switching.

The $\phi/1$ button does not completely shut off mains power from the unit, but switches operating current on and off. “ ϕ ” shows electrical power standby and “1” shows ON.

The socket outlet shall be installed near the equipment and easily accessible, or the mains plug or an appliance coupler shall remain readily operable.

Video tapes recorded with this unit in the LP (Long Play) or EP (Extended Play) mode cannot be played back on a single-speed video recorder. (VHS deck only)

When the equipment is installed in a cabinet or a shelf, make sure that it has sufficient space on all sides to allow for ventilation (10 cm or more on both sides, on top and at the rear.)

When discarding batteries, environmental problems must be considered and the local rules or laws governing the disposal of these batteries must be followed strictly.

Failure to heed the following precautions may result in damage to the unit, remote control or video cassette.

- DO NOT place the unit** —
 - in an environment prone to extreme temperatures or humidity.
 - in direct sunlight.
 - in a dusty environment.
 - in an environment where strong magnetic fields are generated.
 - on a surface that is unstable or subject to vibration.
- DO NOT block the unit's ventilation openings or holes.** (If the ventilation openings or holes are blocked by a newspaper or cloth, etc., the heat may not be able to get out.)
- DO NOT place heavy objects on the unit or remote control.**
- DO NOT place anything which might spill on top of the unit or remote control.** (If water or liquid is allowed to enter this equipment, fire or electric shock may be caused.)
- DO NOT expose the apparatus to dripping or splashing.**
- DO NOT use this equipment in a bathroom or places with water.** Also **DO NOT** place any containers filled with water or liquids (such as cosmetics or medicines, flower vases, potted plants, cups, etc.) on top of this unit.
- DO NOT place any naked flame sources, such as lighted candles, on the apparatus.**
- AVOID violent shocks to the unit during transport.**

MOISTURE CONDENSATION

Moisture in the air will condense on the unit when you move it from a cold place to a warm place, or under extremely humid conditions—just as water droplets form on the surface of a glass filled with cold liquid. Moisture condensation on the head drum will cause damage to the tape. In conditions where condensation may occur, keep the unit turned on for a few hours to let the moisture dry.

ATTENTION

To mobile phone user:

Using a mobile phone in the vicinity of the unit may cause picture vibration on the TV screen or change the screen to a blue back display.





On placing the unit:

Some TVs or other appliances generate strong magnetic fields. Do not place such appliances on top of the unit as it may cause picture disturbance.

About Discs





Playable Discs

You can use discs with the following logos for playback only.

DVD VIDEO 	Video CD/Super Video CD 
Audio CD 	

- The following discs also can be played back.
 - DVD-R/-RW discs recorded in DVD VIDEO format and finalized.
 - CD-R/RW discs recorded in Video CD, SVCD (Super Video CD), or Audio CD format and finalized.
 - CD-R/RW discs written in MP3 or JPEG in accordance with the "ISO 9660" format. (See page 42 for details.)
- This unit can also play back audio signals recorded in MIX-MODE CD, CD-G, CD-EXTRA, and CD TEXT.
- The image may be sometimes poor or noisy due to defects in the disc itself.
- With some discs, operations may not be possible.

Marks of discs in this instruction manual

 Allows operation with a DVD VIDEO disc.	 Allows operation with a Video CD disc.
 Allows operation with a SVCD disc.	 Allows operation with an Audio CD disc.

Unplayable Discs

The following types of discs cannot be played using this unit.

- CD-ROM discs (including PHOTO-CD)
- DVD AUDIO discs
- Super Audio CDs (SACD)
- DVD-RW discs recorded in VR format
- DVD-RAM discs
- DVD-ROM discs

In addition, this unit does not play:

- Unfinalized discs
- Discs of irregular shape or discs with tape, seals, or paste on either the label side or playback side. Playing back these discs may damage the unit.

The Non-DVD side of a "DualDisc" does not comply with the "Compact Disc Digital Audio" standard. Therefore, the use of Non-DVD side of a DualDisc on this product may not be recommended.

Region Number

The world is divided into 6 regions for DVD VIDEO discs. DVD VIDEO discs are assigned a region number to indicate which region they may be played back in. A disc cannot be played back on your unit unless the region number of the disc matches the one on the rear of your unit. The region number for your unit is as follows:

HR-XV38SAG: "3"

Examples of DVD VIDEO labels which can be played back with HR-XV38SAG.



HR-XV38SAS: "2"







Examples of DVD VIDEO labels which can be played back with HR-XV38SAS.





DVD VIDEO Marks

Sometimes marks are printed on a DVD disc and/or on its packaging to indicate information regarding the contents and functions of a disc. Check marks indicating the contents and functions of a disc. Note, however, that in some cases a disc may not include a mark even for a function it supports.

Marks related to video

	Number of subtitles		Number of angles
	Recorded under the standard 4:3 aspect ratio		Screen includes black bands at top and bottom of image which has a standard 4:3 aspect ratio (letter box)
	Video playback is in Wide video mode (16:9) on wide televisions, but in letter box on televisions with standard 4:3 aspect ratio.		
	Video playback is in Wide video mode (16:9) on wide televisions, but pan and scan is used on televisions with standard 4:3 aspect ratio (either the left or right side of the image is cut-out).		

Marks related to audio

	Number of audio tracks
	Dolby Digital mark Dolby Laboratories has developed a digital surround system for the home. This mark indicates that you may enjoy 5.1-channel audio (front left and right, center, rear left and right, and a channel for LFE (Low-Frequency Effects)).
	DTS (Digital Theater System) You can enjoy DTS audio if you connect an amplifier with a built-in DTS decoder to the DIGITAL AUDIO OUT connector of the unit.

File Structure of Discs

DVD VIDEO

Typically, DVD VIDEO discs are made up of larger units called "titles." Each title has a number (title number) that can be used to select desired titles. Titles are further divided into units called "chapters." Each chapter has a number (chapter number) that can also be used to select desired chapters. Note that some discs are not divided into titles and chapters.

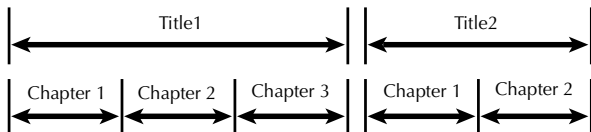

Audio CD/Video CD

Typically, Audio CD discs are divided into separate tracks each containing one song. Each track is assigned a number. For example, the third track is Track 3. The same is true for Video CD discs.

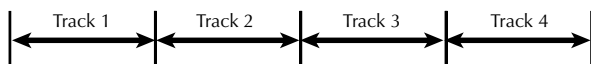

NOTE:

Video CD discs that support Playback Control (PBC)

The still image or motion image which follows a menu screen is called a "scene." Each scene has a scene number.

For more details, refer to "Locating a Desired Scene Using the Menu of the Video CD with Playback Control (PBC) Function" (pg. 34).

Placing a Disc

1 Open the disc tray.

Press  on the DVD deck to open the disc tray.

- The unit's power comes on automatically.
- Do not block the disc tray with your hand while it is opening or closing as this may result in hardware failure.
- Do not place unplayable discs or any object other than a disc in the disc tray.
- Do not press down strongly on the disc tray or place any heavy objects on it.

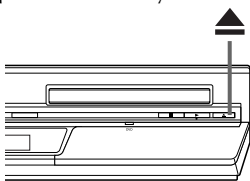

2 Place the disc.

Place the disc in the disc tray with the label side facing up.

- Since disc size changes depending on the disc to be played back, be sure to correctly align the disc with the grooves for its size. If the disc is not in its groove, it may be scratched or otherwise damaged.
- To insert an 8 cm disc, place it according to the inner groove.

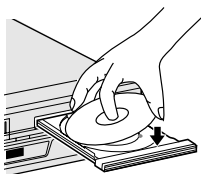

3 Press on the DVD deck to close the disc tray.

- Pressing  also closes the disc tray.
- Playback begins automatically if an auto-playback DVD disc is loaded. Although the VHS deck is selected, the DVD deck is selected automatically (except when the VHS deck is in the timer mode or the Automatic Satellite Programme Recording mode.)

Care and Handling of Discs

How to handle discs

When handling a disc, do not touch the surface of the disc. Since discs are made of plastic, they are easily damaged. If a disc gets dirty, dusty, scratched or warped, the images and sound will not be picked up correctly, and such a disc may cause the unit to malfunction.

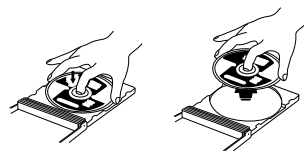

Label side

Do not damage the label side, stick paper to or use any adhesive on its surface.

Storage

Make sure that discs are kept in their cases. If discs are piled on top of one another without their protective cases, they can be damaged. Do not put discs in a location where they may be exposed to direct sunlight, or in a place where the humidity or temperature is high. Avoid leaving discs in your car!

Maintenance of discs

If there are fingerprints or other dirt adhering to a disc, wipe with a soft dry cloth, moving from the center outwards.

If a disc is difficult to clean, wipe with a cloth moistened with water. Never use record cleaners, petrol, alcohol or any anti-static agents.



CAUTION

Sometimes during playback, noise or images may be garbled. This is sometimes due to the disc. (It may not be up to industry standards.)

These symptoms are caused by the discs, not by the malfunction of the unit.

FRONT VIEW

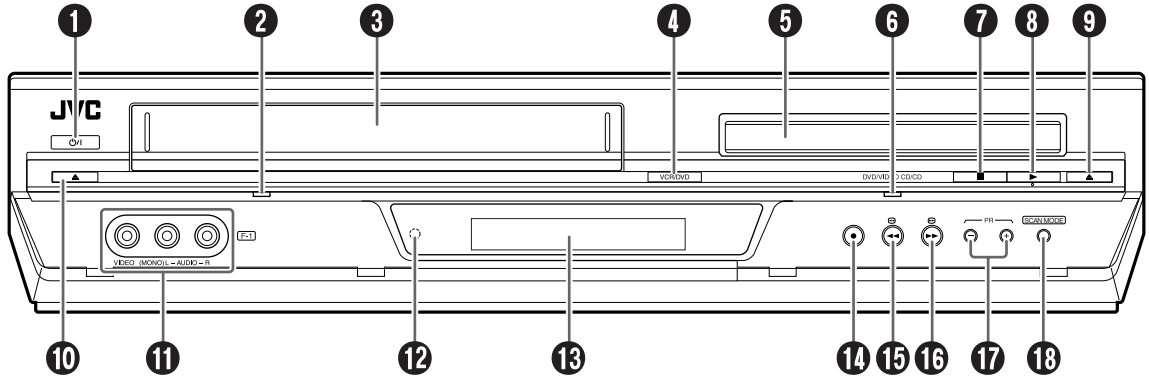

- ❶ STANDBY/ON Button (⏻/⏻) ☞ pg. 11, 14, 21, 49
- ❷ VCR Indicator ☞ pg. 20, 23
- ❸ Cassette Loading Slot
- ❹ VCR/DVD Button ☞ pg. 20, 23, 33, 43
- ❺ Disc Tray ☞ pg. 5
- ❻ DVD Indicator ☞ pg. 33
- ❼ Stop Button (■) ☞ pg. 20, 23, 33, 43
- ❽ Play Button (▶) ☞ pg. 20, 23, 33, 43, 49
- ❾ DVD Open/Close Button (▲) ☞ pg. 5, 33, 43
- ❿ Cassette Eject Button (▲) ☞ pg. 20, 21, 23
- ⓫ Video/Audio Input Connectors (F-1 VIDEO/AUDIO) ☞ pg. 45
- ⓫ Infrared Beam Receiving Window

- ⓫ Front Display Panel ☞ pg. 7
- ⓫ Record Button (●) ☞ pg. 23, 24
- ⓫ Rewind Button (◀◀) ☞ pg. 20, 21, 35
- ⓫ Fast Forward Button (▶▶) ☞ pg. 20, 21, 35
- ⓫ Programme Button (PR +/-) ☞ pg. 21, 23, 29
- ⓫ SCAN MODE Button ☞ pg. 11

To access covered connectors or buttons, pull and open the cover.

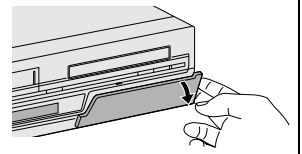

REAR VIEW

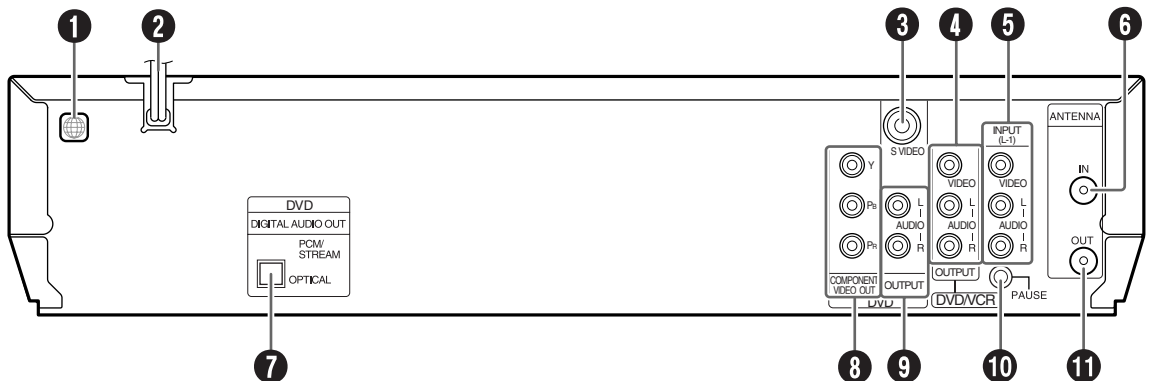

- ❶ Region Number Label ☞ pg. 4
- ❷ Mains Power Cord ☞ pg. 9, 10, 12
- ❸ S-Video Output Connector (S-VIDEO OUTPUT)* ☞ pg. 12, 51
- ❹ Audio/Video Output Connector (AUDIO/VIDEO OUTPUT) ☞ pg. 9, 10, 12, 46, 51
- ❺ L-1 Input Connector (INPUT (L-1)) ☞ pg. 9, 46, 51
- ❻ Antenna Input Connector (ANTENNA IN) ☞ pg. 9, 10, 12, 51

- ❼ Digital Audio Output Connector (DIGITAL AUDIO OUT)* ☞ pg. 48, 52
- ❽ Component Video Output Connectors (COMPONENT VIDEO OUT)* ☞ pg. 10
- ❾ Audio Output Connectors (AUDIO OUT (L/R))* ☞ pg. 10
- ❿ Remote Pause Connector (PAUSE) ☞ pg. 45
- ⓫ Antenna Output Connector (ANTENNA OUT) ☞ pg. 9, 10, 12, 51

* These connectors are only for DVD deck.

FRONT DISPLAY PANEL

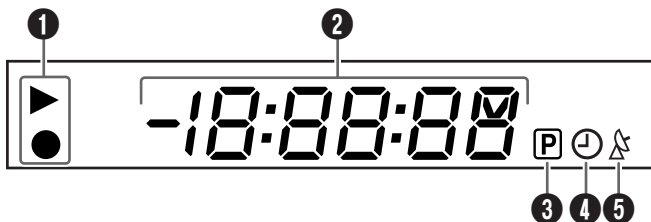

- ❶ Operation Mode Indicator
- ❷ Channel/Clock Display
Mode Display (L-1 or F-1)
Counter Display
Tape Speed (SP/LP or EP*) [pg. 23](#)
** EP is for NTSC only.*
Multi-information window*
** The current group/title/track/chapter number(s), time and status information.*
- ❸ Progressive Mode Indicator [pg. 11](#)
- ❹ "Timer" Indicator [pg. 28, 29, 32](#)
- ❺ Satellite Auto Recording Indicator (△) [pg. 32](#)

ON-SCREEN DISPLAY (VHS deck)

If you press **--:--** on the remote control when "O.S.D." is set to "ON" ([pg. 54](#)), various operational indicators appear on the TV screen.

For On-screen display for DVD deck, refer to "Using the on-screen bar" ([pg. 40](#)).

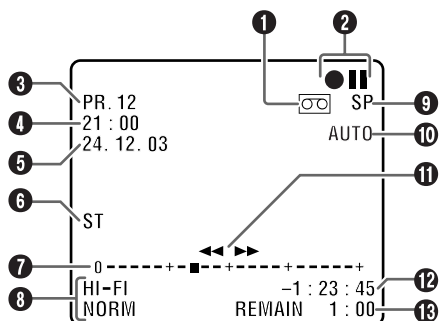

- ❸ Audio Mode Display [pg. 22](#)
- ❹ Tape Speed (SP/LP or EP*)
** EP is for NTSC only.*
- ❺ Colour System Indicator [pg. 54](#)
- ❻ Tape Direction
- ❼ Counter Display
- ❽ Tape Remaining Time Indicator [pg. 24](#)
- ❶ "Cassette Loaded" Mark
- ❷ Operation Mode Indicators
- ❸ Channel Position Number and Station Name/Auxiliary Input Indicator (L-1 or F-1)
- ❹ Clock Display
- ❺ Current Day/Month/Year
- ❻ Type of Broadcast [pg. 25](#)
- ❼ Tape Position Indicator

The tape position indicator appears on the TV screen when you press **◀◀** or **▶▶** from the Stop mode or perform an Index Search. ([pg. 21](#)) The position of "I" in relation to "0" (beginning) or "+" (end) shows you where you are on the tape.

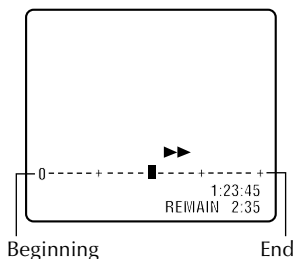

NOTE:

Depending on the type of tape being used, the tape position indicator may not appear correctly.

REMOTE CONTROL

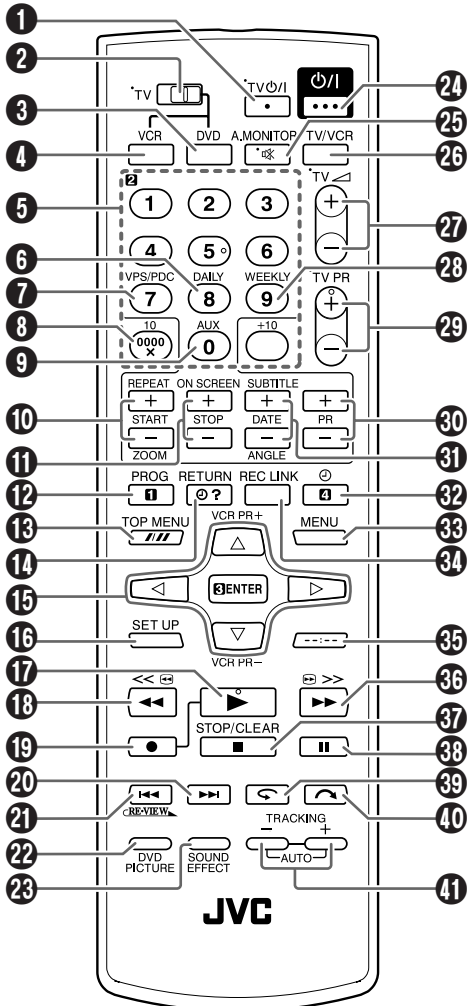

Buttons with a small dot on the left side of the name can also be used to operate your JVC TV. (☞ pg. 50)

How To Use

The remote control can operate most of your unit's functions, as well as basic functions of TV sets of JVC. (☞ pg. 49)

- Point the remote control toward the receiving window.
- The maximum operating distance of the remote control is about 8 m.

NOTES:

- When inserting the batteries, be sure to insert in the correct directions as indicated under the battery cover.
- If the remote control doesn't work properly, remove its batteries, wait a short time, replace the batteries and then try again.

- TV Standby/On Button (TV ψ /I) ☞ pg. 50
- TV/VCR/DVD switch ☞ pg. 11, 13-16, 19, 20, 33, 43, 50
- DVD Button ☞ pg. 11, 15, 33, 43, 56
- VCR Button ☞ pg. 14, 16, 19, 20, 53
- Number Keys
- Daily Button (DAILY) ☞ pg. 28, 29, 31
- VPS/PDC Button
 - *Does not function with this unit.
- Reset Button (0000) ☞ pg. 24
- Cancel Button (X) ☞ pg. 27, 30, 31
- Auxiliary Button (AUX) ☞ pg. 45
- Start Time Button (START +/-) ☞ pg. 29
- Repeat Button (REPEAT) ☞ pg. 36, 44
- Zooming Button (ZOOM) ☞ pg. 35, 44
- Stop Time Button (STOP +/-) ☞ pg. 28, 29, 30, 31
- On Screen Button (ON SCREEN) ☞ pg. 40
- Programming Button (PROG) ☞ pg. 27, 29, 31
- Tape Speed Button *SP/LP* or *EP** (///) ☞ pg. 23, 27, 29, 30, 31
 - * EP is for NTSC only.
- Top Menu Button (TOP MENU) ☞ pg. 34
- Programme Check Button (\odot ?) ☞ pg. 30
- Return Button (RETURN) ☞ pg. 34
- \triangleleft \triangleright Button
- \triangle ∇ Button
- ENTER Button
- VCR Programme Button (VCR PR +/-)
- Set Up Menu Button (SET UP) ☞ pg. 15, 19, 53, 56, 60
- Play Button (\blacktriangleright) ☞ pg. 20, 23, 33, 43
- Rewind Button (\blacktriangleleft) ☞ pg. 20, 21, 35
- Record Button (\bullet) ☞ pg. 23, 24
- Forward Skip/Index Button (\blacktriangleright) ☞ pg. 21, 34, 35
- Reverse Skip/Index Button (\blacktriangleleft) ☞ pg. 21, 34, 35
- Review Button ($\overleftarrow{\text{REVIEW}}$) ☞ pg. 22
- DVD Picture Button (DVD PICTURE) ☞ pg. 39
- Sound Effect Button (SOUND EFFECT) ☞ pg. 39
- Standby/On Button (ψ /I) ☞ pg. 11, 14, 21
- TV Muting Button (M) ☞ pg. 50
- Audio Monitor Button (A.MONITOR) ☞ pg. 22, 38
- TV/VCR Button ☞ pg. 24, 50
- TV Volume Button (TV ∇ /+/-) ☞ pg. 50
- Weekly Button (WEEKLY) ☞ pg. 28, 29, 31
- TV Programme Button (TV PR +/-) ☞ pg. 50
- Programme Button (PR +/-) ☞ pg. 21, 23, 29, 30, 31
- Date Button (DATE +/-) ☞ pg. 29, 30, 31
- Subtitle Button (SUBTITLE) ☞ pg. 37
- Angle Button (ANGLE) ☞ pg. 38
- Timer Button (\odot) ☞ pg. 28, 29, 30
- Menu Button (MENU) ☞ pg. 34
- Automatic Satellite Programming Button (REC LINK) ☞ pg. 32
- Display Button ($--:--$) ☞ pg. 24, 33
- Fast Forward Button (\blacktriangleright) ☞ pg. 20, 21, 35
- Stop/Clear Button (\blacksquare) ☞ pg. 20, 23, 33, 43
- Pause Button (\parallel) ☞ pg. 21, 23, 33, 35, 43
- One Touch Replay Button ($\overleftarrow{\text{O.T.R.}}$) ☞ pg. 21, 35
- Skip Search Button (\curvearrowright) ☞ pg. 21
- Tracking Button (TRACKING +/-) ☞ pg. 22

Basic Connections

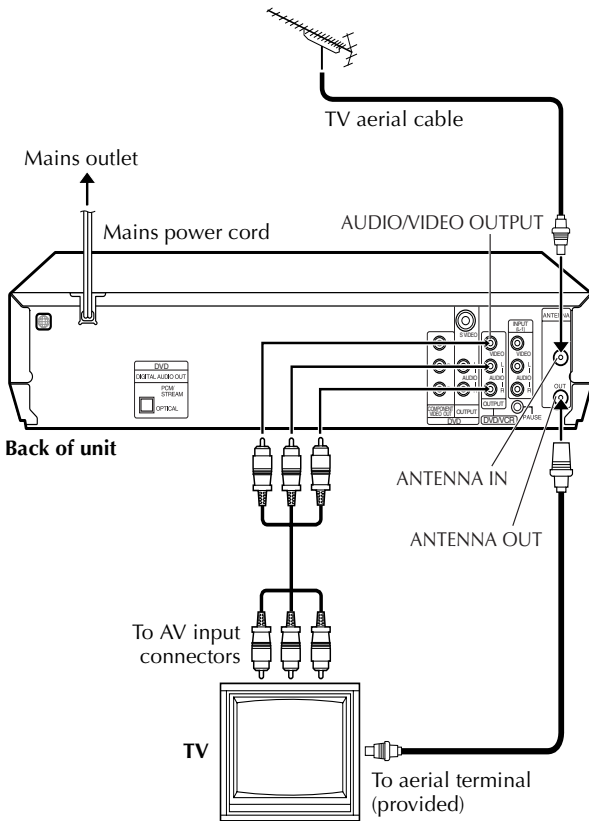

It's essential that your unit be properly connected.

THESE STEPS MUST BE COMPLETED BEFORE ANY VIDEO OPERATION CAN BE PERFORMED.

1 Check the contents.

Make sure the package contains all of the accessories listed in "SPECIFICATIONS" on page 70.

2 Situate the unit.

Place the unit on a stable, horizontal surface.

3 Connect the unit to TV.

The connection method you use depends on the type of TV you have.

RF Connection

■ To connect to a TV with NO AV input connectors —

- 1 Disconnect the TV aerial cable from the TV.
- 2 Connect the TV aerial cable to the ANTENNA IN connector on the rear panel of the unit.
- 3 Connect the provided RF cable between the ANTENNA OUT connector on the rear panel of the unit and the TV's aerial connector.

AV Connection

■ To connect to a TV with AV input connectors —

If your TV is equipped with a AV input connectors, perform AV connection to improve picture quality during tape playback.

- 1 Connect the aerial, unit and TV as per "RF Connection."
- 2 Connect an optional AV cable between the AUDIO/VIDEO OUT connectors on the rear panel of the unit and the TV's AV input connectors.

4 Connect the unit to mains.

Plug the end of the mains power cord into a mains outlet.

After the connection is completed, perform "Video Channel Set" on page 13.

Component Video Connection

(DVD deck)

ATTENTION

Be sure to connect the unit's VIDEO OUT or S VIDEO OUT connector to the TV's VIDEO IN or S-VIDEO IN connector.

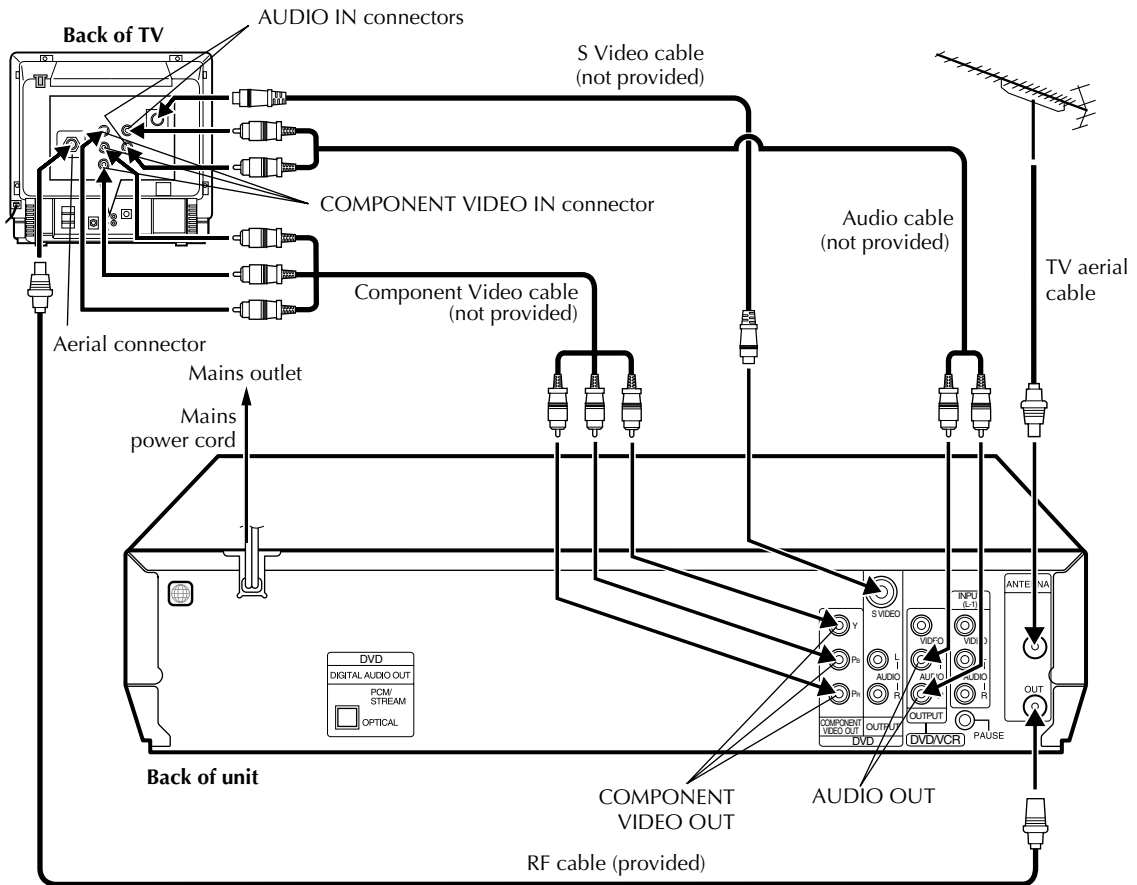

■ To connect to a TV with COMPONENT VIDEO IN connectors . . .

1 Connect the unit to TV.

- 1 Connect the aerial, unit and TV as per "AV Connection" or "S-VIDEO Connection". (☞ pg. 12,13)
- 2 Connect the unit's COMPONENT VIDEO OUT connectors to the TV's COMPONENT VIDEO IN connectors.
- 3 Connect the unit's AUDIO OUT connectors to the TV's AUDIO IN connectors.

2 Connect the unit to mains.

Plug the end of the mains power cord into a mains outlet.

NOTES:

- You can obtain high-quality component video pictures.
- If your TV is not stereo-capable, use the unit's AUDIO OUT connectors to connect to an audio amplifier for Hi-Fi stereo sound reproduction.
- For switching the TV's mode, refer to the instruction manual of your television.
- By using the component video connection, you can view the images in the progressive mode. For switching to the progressive mode, refer to "Scan Mode Set (DVD deck)" (☞ pg. 11).

After the connection is completed, perform "Video Channel Set" on page 13.

Scan Mode Set

(DVD deck)

This unit supports the progressive scan system (eg. 480p*) as well as the conventional interlaced scan system (eg. 480i*).

If your TV equipped with component video connectors supports the progressive video input, you can enjoy a high quality picture by setting the progressive scan mode to active.

- Refer also to the instruction manuals supplied with your TV.
- If your TV equipped with component video connectors does not support the progressive video input, do not change the scan mode to the "PROGRESSIVE."

* 480p and 480i indicate the number of scanning lines and scanning format of an image signal.

- 480p indicates 480 scanning lines with progressive format.
- 480i indicates 480 scanning lines with interlaced format.

- Turn on the TV and select the VCR channel (or AV mode).
- Slide the TV/VCR/DVD switch on the Remote to the right.

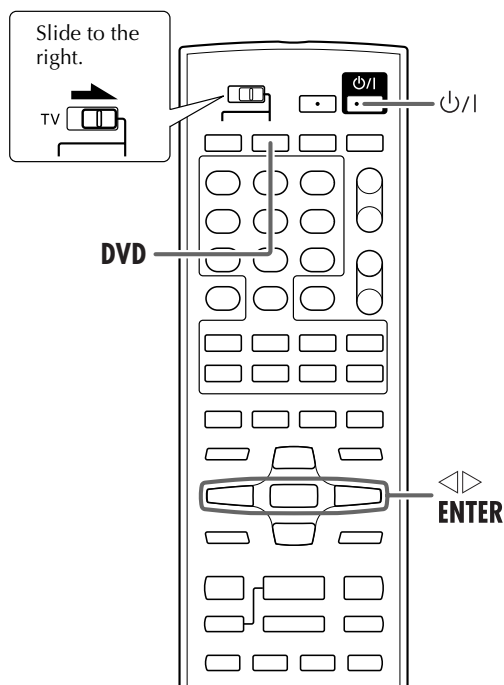
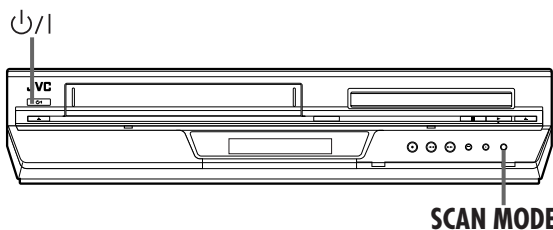

1 Turn on the unit.

Press ⏻/⏮.

2 Select the DVD deck.

On the unit

Press **VCR/DVD** repeatedly so that the DVD indicator lights up.

On the Remote

Press **DVD** so that the DVD indicator lights up.

3 Switch the mode.

- 1 Press and hold **SCAN MODE** on the unit for more than 3 seconds.
The current scan mode blinks on the front display panel.
- 2 While the current scan mode blinks, press ◀▶ to select "ProGr" (for the progressive scan mode) or "IntEr" (for the interlaced scan mode), then press **ENTER**.
 - If the current scan mode stops blinking before you make the setting, start from step 1 again.

NOTE:

When the progressive scan mode is selected, the Progressive mode indicator (P) lights up on the front display panel.

S-VIDEO Connection

(DVD deck)

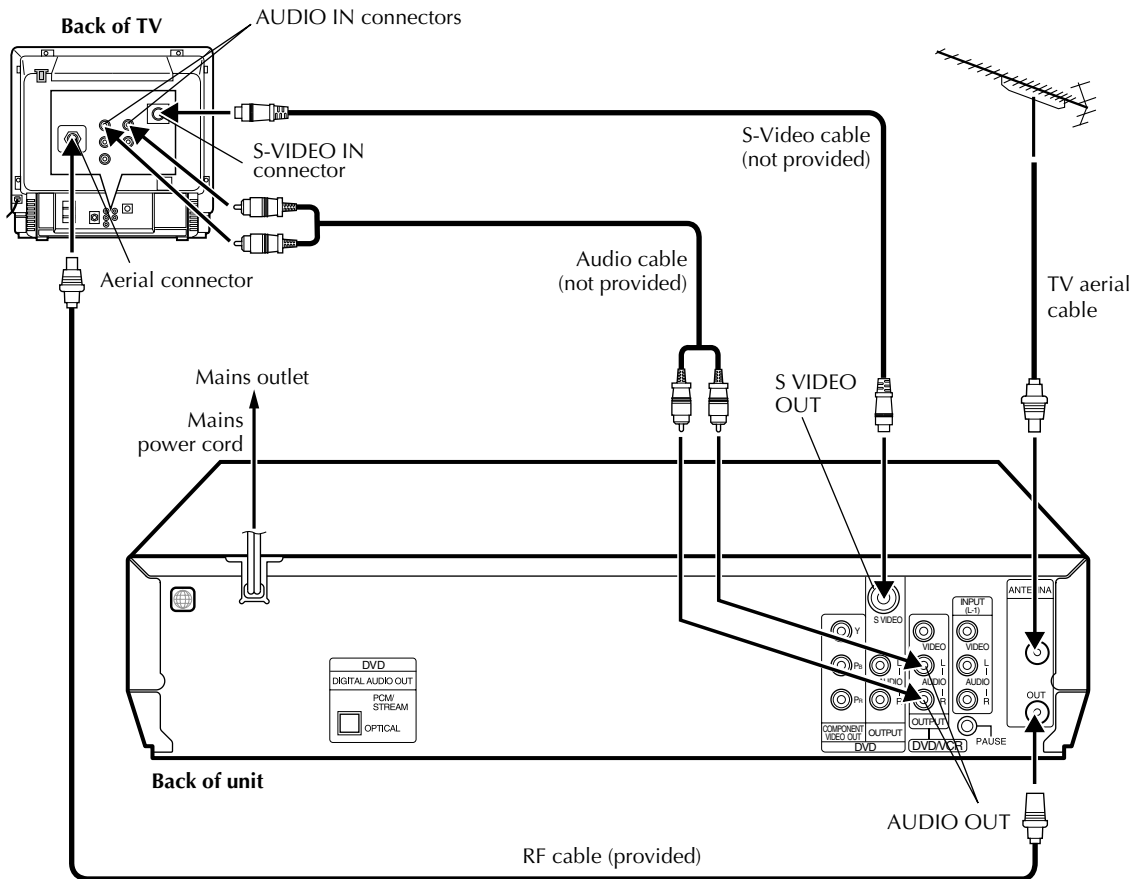

■ To connect to a TV with S-VIDEO/AUDIO IN connectors . . .

1 Connect the unit to TV.

- 1 Connect the aerial, unit and TV as per "RF Connection". (☞ pg. 13)
- 2 Connect the unit's S VIDEO OUT connector to the TV's S-VIDEO IN connector.
- 3 Connect the unit's AUDIO OUT connectors to the TV's AUDIO IN connectors.

2 Connect the unit to mains.

Plug the end of the mains power cord into a mains outlet.

NOTES:

- You can obtain high-quality S-VHS pictures.
- If your TV is not stereo-capable, use the unit's AUDIO OUT connectors to connect to an audio amplifier for Hi-Fi stereo sound reproduction.
- For switching the TV's mode, refer to the instruction manual of your television.

After the connection is completed, perform "Video Channel Set" on page 13.

Video Channel Set

Video channel (RF output channel) is the channel on which your TV receives picture and sound signals from the unit through the RF cable.

Before performing the following steps:

- Make sure there is no cassette inserted in the unit and the power is off.
- Slide the TV/VCR/DVD switch on the remote control to the right.

1 Access the Video Channel Set mode.

Hold down **■** on the unit until the front display panel shows the following.



2 Set the TV system (RF Connection only)

Press **PR +** or **-** on the remote control to set the appropriate TV system that matches the system of TV being used (refer to the table below).



1:B/G 2:D/K 3:I 4:H

Major Countries/Areas	TV System
New Zealand, Kuwait, U.A.E., Indonesia, Singapore, Thailand, Malaysia, Iran, Saudi Arabia, Egypt, Morocco, Lebanon, Iraq	B/G
China, Mongolia, Russia	D/K
Hong Kong	I
Australia	H

3 Set the video channel.

With AV Connection

Press **ENTER**, then press **PR -** until the front display panel shows "--".

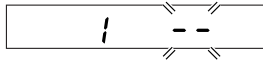

- Now the video channel is set to off.

With RF Connection

Set your TV to UHF channel 36.

- If the two vertical white bars appear clearly on the TV screen as shown on the right, press **ENTER** and then go to step 4.
- If the two vertical white bars do not appear clearly, press **ENTER** and then **PR +** or **-** to set the unit to a vacant channel between 28 and 60 which is not occupied by any local station in your area.

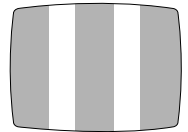

(Example) If channel 50 is available in your area

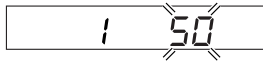

Then set your TV to UHF channel 50 and check if the two vertical white bars appear clearly on the TV screen ; if so, go to step 4. If not, re-set the unit to another vacant channel and try again.

NOTES:

- If you set the unit to a channel which is occupied by a local station or has neighbouring channels that are occupied by local stations, the picture reception quality will be affected and some interference noise will appear on the TV screen. Be sure to select a vacant channel which has no broadcast on neighbouring channels.
- If you cannot obtain the two vertical white bars clearly with any channel between 28 and 60, consult your JVC dealer.

4 Exit the Video Channel Set mode.

Press **ENTER** on the remote control.

- If Auto Set Up (pg. 14) or Tuner Set (pg. 60) has not previously been performed, the Clock Set screen appears and Auto Set Up takes place automatically.

With AV Connection

To view picture signals from the unit, set your TV to its AV mode.

With RF Connection

The channel you have set in step 3 above is your video channel.

To view picture signals from the unit, set your TV to the video channel.

Auto Set Up

The Auto Set Up simplifies installation by guiding you through the procedures of setting the clock and tuner channels – simply follow the on-screen menus that appear.

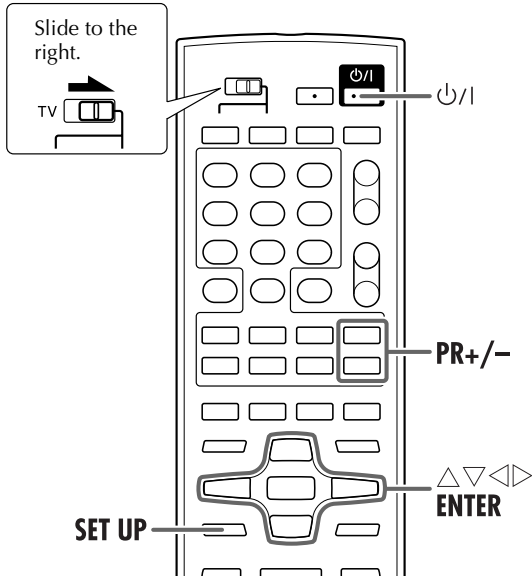

Before starting, make sure of the following:

- The TV aerial cable should be connected to the unit.
- The unit's mains power cord should be connected to a mains outlet.
- The "Video Channel Set" (see pg. 13) should be performed and the TV should be set to its AV mode (with AV connection see pg. 9) or UHF channel (with RF connection see pg. 9).
- Slide the TV/VCR/DVD switch on the remote control to the right.

1 Turn on the unit.

Press **Power/Standby** on the unit or remote control. The Language Select screen appears on the TV screen.

2 Select language

Press **Up/Down** to place the pointer next to your desired language (English, Russian or Arabic), then press **ENTER** or **Right**.

- The Clock Set screen appears.

3 Set the date and time.

Press **Up/Down** to set the time, then press **ENTER** or **Right**. The "DATE" display begins blinking. Repeat the same procedure to set the date and year.

- When you set the time/date, press and hold **Up/Down** to change the time by 30 minutes/15 days.

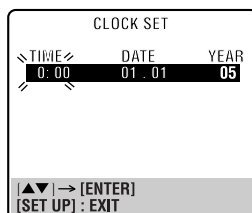

4 Select the TV system.

Press **Up/Down** to place the pointer next to the appropriate TV system (refer to the table below).

Major Countries/Areas	TV System
Australia, New Zealand, Kuwait, U.A.E., Indonesia, Singapore, Thailand, Malaysia, Iran, Saudi Arabia, Egypt, Morocco, Lebanon, Iraq	B/G
China, Mongolia, Russia	D/K
Hong Kong	I

5 Start Auto Channel Set.

Press **ENTER** or **Right**.

DO NOT press any button on the unit or remote control while Auto Set Up is in progress.

Auto Channel Set is performed next. Auto Channel Set scans all the channels that are receivable by your unit. During Auto Channel Set, the channel numbers are displayed as they are scanned and set.

- As Auto Set Up progresses, the "■" mark on the TV screen moves from left to right.
- When Auto Set Up is completed, the lowest position number will appear on the front display panel. If "SCAN COMPLETED -NO SIGNAL-" is displayed on the TV screen, make sure that the aerial cable is connected to the unit properly and press **ENTER** on the remote control. The unit will try Auto Set Up again.

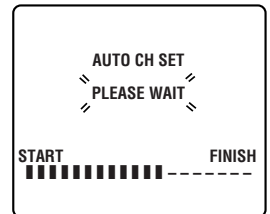

NOTES:

- If there is a power cut, or if you press **Power/Standby** or **SET UP** while Auto Set Up is in progress, Auto Set Up will be interrupted; be sure to turn off the unit power once and try again from step 1.
- If no sound accompanies the picture or the audio sounds unnatural on some channels that have been stored by Auto Set Up, the TV system setting for those channels may be incorrect. Select the appropriate TV system for those channels. "TV System Selection — When you see the picture but the audio can't be heard or sounds unnatural" (see pg. 63).

ATTENTION

If you perform Auto Set Up successfully during installation, there's no need to separately perform the Clock Set or Channel Set procedures, but if adjustments become necessary, they can be performed as follows:

- Tuner setting see pg. 60
- Clock setting see pg. 19

Monitor Set (DVD deck)

You can select the monitor type depending on the TV used when you play back DVD VIDEO discs recorded for wide-screen TVs.

For the multi colour system TV

When you use a multi colour system TV, you can change the colour system of this unit automatically by selecting "MULTI" options as the monitor type. In this case, the setting of this unit is changed to match the colour system of the loaded disc regardless the TV system setting. (☞ "ATTENTION" below)

ATTENTION

How to change the TV system between PAL and NTSC

- Press and hold **SCAN MODE** on the unit for more than 3 seconds while the unit is turned off. The current TV system blinks on the front display panel.
- While the current TV system blinks, press $\triangleleft \triangleright$ to select "ntSc" (for NTSC) or "PAL" (for PAL), then press **ENTER**.
 - If the current TV system stops blinking before you make the setting, start from step 1 again.

- Turn on the TV and select the video channel (or AV mode).
- Slide the **TV/VCR/DVD** switch on the remote control to the right.

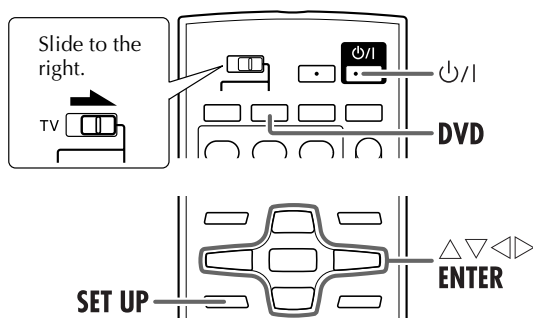

1 Turn on the unit.

Press ϕ/I .

2 Select the DVD deck.

On the unit

Press **VCR/DVD** repeatedly so that the DVD indicator lights up.

On the remote control

Press **DVD** so that the DVD indicator lights up.

3 Access the DVD Set Up menu screen.

- Press **SET UP**.
- Press $\triangleleft \triangleright$ to select "PICTURE."

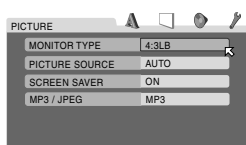

4 Select the mode.

Press $\triangle \nabla$ to move \boxtimes to "MONITOR TYPE," then press **ENTER**.

5 Select the mode setting.

Press $\triangle \nabla$ to select the desired setting, then press **ENTER**.

6 Return to the normal screen.

Press **SET UP**.

* The default setting is **bold** in the table below.

MONITOR TYPE

16:9 / 16:9 MULTI (Wide television conversion):

Select this when the aspect ratio of your TV is 16:9 (wide TV).

4:3 LB / 4:3 MULTI LB (Letter Box conversion):

Select this when the aspect ratio of your TV is 4:3 (conventional TV). While viewing a wide screen picture, the black bars appear on the top and the bottom of the screen.

4:3 PS / 4:3 MULTI PS (Pan&Scan):

Select this when the aspect ratio of your TV is 4:3 (conventional TV). While viewing a wide screen picture, the black bars do not appear; however, the left and right edges of the pictures will not be shown on the screen.

Pan&Scan/Letter Box

In general, DVD VIDEO disc are produced for a wide-screen TV with 16:9 aspect ratio. Material with this ratio will not fit to a TV with 4:3 aspect ratio. There are two styles to display the image, "Pan&Scan" and "Letter Box."

Pan&Scan

The right and left side of the image are cut off. The image fills the screen.



Letter Box

Black bands appear at the top and bottom of the image. The image itself appears in 16:9 aspect ratio.



NOTES:

- Even if "4:3 PS" or "4:3 MULTI PS" is selected, the screen size may become "4:3 LB" or "4:3 MULTI LB" with some DVD VIDEO. This depends on how they are recorded.
- When you select "16:9" or "16:9 MULTI" for a picture whose aspect ratio is 4:3, the picture slightly changes due to the process for converting the picture width.

Language

- Turn on the TV and select the video channel (or AV mode).
- Slide the **TV/VCR/DVD** switch on the remote control to the right.

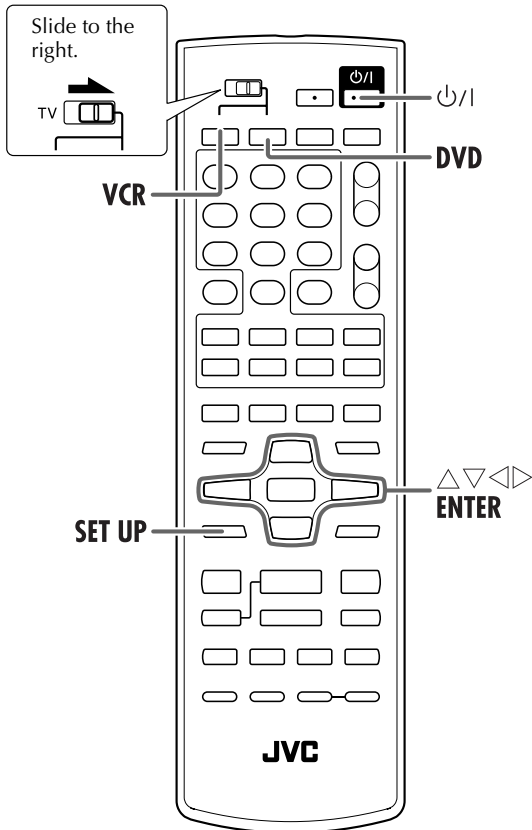

On-screen Language Set (VHS deck)

1 Turn on the unit.

Press ⏻/⏻.

2 Select the VHS deck.

On the unit

Press **VCR/DVD** repeatedly so that the VCR indicator lights up.

On the remote control

Press **VCR** so that the VCR indicator lights up.

3 Access the Main Menu screen.

- 1 Press **SET UP**.
- 2 Press \triangle / ∇ to move the highlight bar (pointer) to "INITIAL SET," then press **ENTER** or \triangleright .

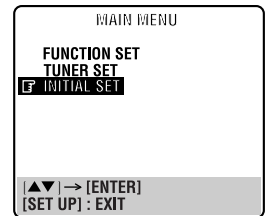

4 Select your country.

Press \triangle / ∇ to move the highlight bar (pointer) to "LANGUAGE," then press **ENTER** or \triangleright .

5 Select the language.

Press \triangle / ∇ to move the highlight bar (pointer) to the language of your choice (English, Russian or Arabic).



6 Return to the normal screen.

Press **SET UP**.

On-screen Language Set (DVD deck)

This DVD deck offers you the choice to view on-screen messages in 3 different languages. You can change the language setting manually as required.

1 Turn on the unit.

Press $\odot/1$.

2 Select the DVD deck.

On the unit

Press **VCR/DVD** repeatedly so that the DVD indicator lights up.

On the remote control

Press **DVD** so that the DVD indicator lights up.

3 Access the DVD Set Up menu screen.

- 1 Press **SET UP**.
- 2 Press $\triangleleft \triangleright$ to select "LANGUAGE."

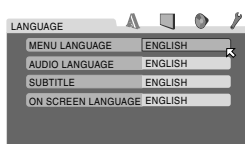

4 Select the mode.

Press $\triangle \nabla$ to move \leftarrow to "ON SCREEN LANGUAGE," then press **ENTER**.

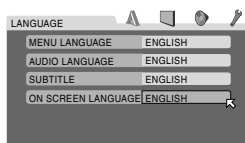

5 Select the mode setting.

Press $\triangle \nabla$ to select the desired setting, then press **ENTER**.

6 Return to the normal screen.

Press **SET UP**.

Menu/Audio/Subtitle Language Set

Some DVD discs contain the DVD menu display, audio, subtitle in multiple languages. With these discs, you can set the default language as you like.

- The procedure shows how to set "MENU LANGUAGE" on the DVD menu screen as an example.

1 Turn on the unit.

Press $\odot/1$.

2 Select the DVD deck.

On the unit

Press **VCR/DVD** repeatedly so that the DVD indicator lights up.

On the remote control

Press **DVD** so that the DVD indicator lights up.

3 Access the DVD Set Up menu screen.

- 1 Press **SET UP**.
- 2 Press $\triangleleft \triangleright$ to select "LANGUAGE."

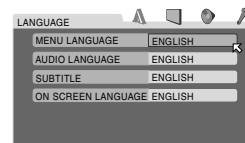

4 Select the mode.

Press $\triangle \nabla$ to move \leftarrow to "MENU LANGUAGE," then press **ENTER**.

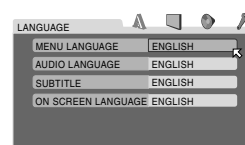

5 Select the mode setting.

Press $\triangle \nabla$ to select the desired setting, then press **ENTER**.

- See "Language Code List" (☞ pg. 18).

6 Return to the normal screen.

Press **SET UP**.

NOTE:

When the selected language is not available on the disc, the disc's default menu language is played back.

Language Code List

AA	Afar	IK	Inupiak	RN	Kirundi
AB	Abkhazian	IN	Indonesian	RO	Rumanian
AF	Afrikaans	IS	Icelandic	RU	Russian
AM	Ameharic	IW	Hebrew	RW	Kinyarwanda
AR	Arabic	JJ	Yiddish	SA	Sanskrit
AS	Assamese	JW	Javanese	SD	Sindhi
AY	Aymara	KA	Georgian	SG	Sangho
AZ	Azerbaijani	KK	Kazakh	SH	Serbo-Croatian
BA	Bashkir	KL	Greenlandic	SI	Singhalese
BE	Byelorussian	KM	Cambodian	SK	Slovak
BG	Bulgarian	KN	Kannada	SL	Slovenian
BH	Bihari	KO	Korean (KOR)	SM	Samoa
BI	Bislama	KS	Kashmiri	SN	Shona
BN	Bengali, Bangla	KU	Kurdish	SO	Somali
BO	Tibetan	KY	Kirghiz	SQ	Albanian
BR	Breton	LA	Latin	SR	Serbian
CA	Catalan	LN	Lingala	SS	Siswati
CO	Corsican	LO	Laothian	ST	Sesotho
CS	Czech	LT	Lithuanian	SU	Sundanese
CY	Welsh	LV	Latvian, Lettish	SV	Swedish
DA	Danish	MG	Malagasy	SW	Swahili
DZ	Bhutani	MI	Maori	TA	Tamil
EL	Greek	MK	Macedonian	TE	Telugu
EO	Esperanto	ML	Malayalam	TG	Tajik
ET	Estonian	MN	Mongolian	TH	Thai
EU	Basque	MO	Moldavian	TI	Tigrinya
FA	Persian	MR	Marathi	TK	Turkmen
FI	Finnish	MS	Malay (MAY)	TL	Tagalog
FJ	Fiji	MT	Maltese	TN	Setswana
FO	Faroese	MY	Burmese	TO	Tonga
FY	Frisian	NA	Nauru	TR	Turkish
GA	Irish	NE	Nepali	TS	Tsonga
GD	Scots Gaelic	NL	Dutch	TT	Tatar
GL	Galician	NO	Norwegian	TW	Twi
GN	Guarani	OC	Occitan	UK	Ukrainian
GU	Gujarati	OM	(Afan) Oromo	UR	Urdu
HA	Hausa	OR	Oriya	UZ	Uzbek
HI	Hindi	PA	Panjabi	VI	Vietnamese
HR	Croatian	PL	Polish	VO	Volapuk
HU	Hungarian	PS	Pashto, Pushto	WO	Wolof
HY	Armenian	PT	Portuguese	XH	Xhosa
IA	Interlingua	QU	Quechua	YO	Yoruba
IE	Interlingue	RM	Rhaeto-Romance	ZU	Zulu

Clock Set

- Turn on the TV and select the video channel (or AV mode).
- Slide the **TV/VCR/DVD** switch on the remote control to the right.

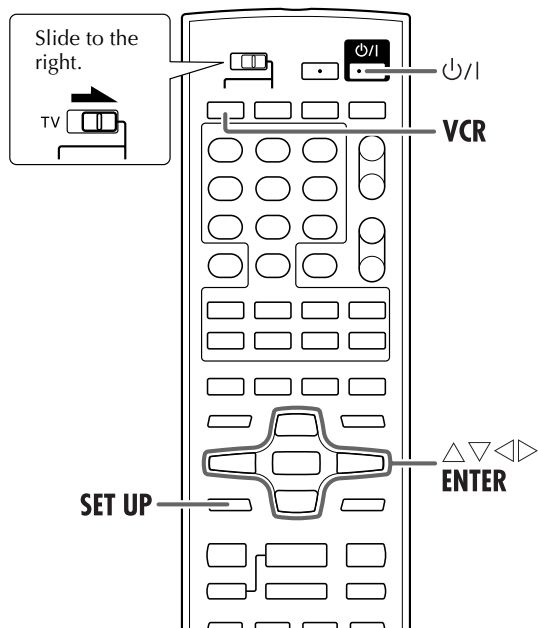

1 Turn on the unit.

Press ϕ/I .

2 Select the VHS deck.

On the unit

Press **VCR/DVD** repeatedly so that the VCR indicator lights up.

On the remote control

Press **VCR** so that the VCR indicator lights up.

3 Access the Main Menu screen, then Initial Set screen.

Press **SET UP**. Press \triangle/∇ to place the pointer next to "INITIAL SET," then press **ENTER** or \triangleright .

4 Access the Clock Set screen.

Press \triangle/∇ to move the highlight bar (pointer) to "CLOCK SET," then press **ENTER** or \triangleright . The Clock Set screen appears.

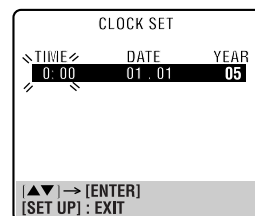
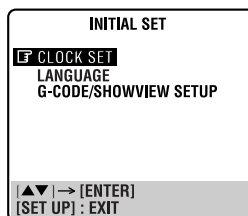

5 Set the date and time.

Press \triangle/∇ to set the time, then press **ENTER** or \triangleright . The "DATE" display begins blinking. Repeat the same procedure to set the date and year.

- When you set the time/date, press and hold \triangle/∇ to change the time by 30 minutes/15 days.

NOTE:

If the year digits are automatically cleared, it is possible that you have input February 29th in a non-leap year. Input the correct data.

6 Start the clock operation.

Press **SET UP**.

To make corrections anytime during the process

Press **ENTER** or \triangleright repeatedly until the item you want to change blinks, then press \triangle/∇ .

Basic Playback

- Turn on the TV and select the video channel (or AV mode).
- Slide the TV/VCR/DVD switch on the remote control to the right.

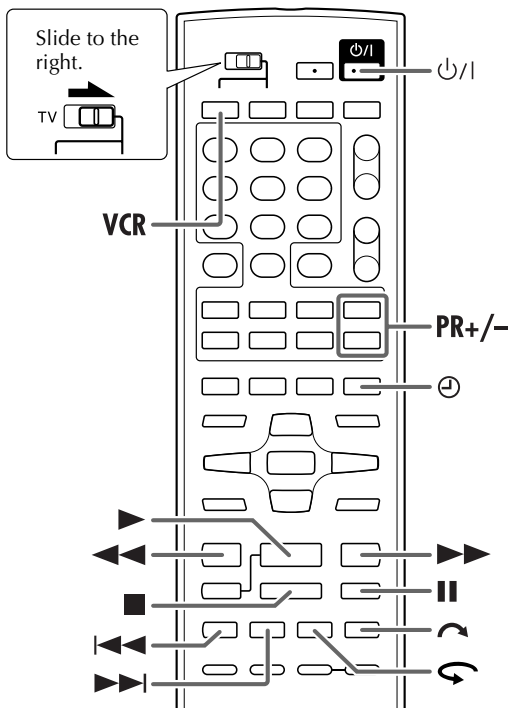
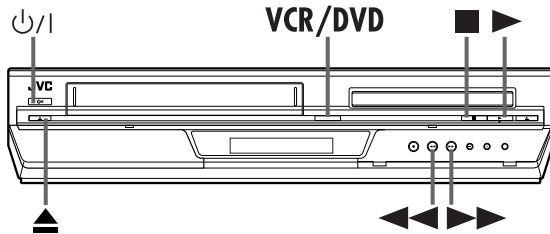

Clean the video heads using a dry cleaning cassette — ECL-3F — when:

- Rough, poor picture appears while a tape is played back.
- The picture is unclear or no picture appears.
- "USE CLEANING CASSETTE" appears on the screen (only with "O.S.D." set to "ON"). (☞ pg. 54)

NOTE:

The heads get dirty in the following cases:

- in an environment prone to extreme temperature or humidity
- in a dusty environment
- flaw, dirt or mold on video tapes
- continuous usage for a long time

1 Load a cassette.

Make sure the window side is up, the rear label side is facing you and the arrow on the front of the cassette is pointed toward the unit.

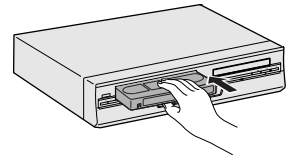

- Do not apply too much pressure when inserting.
- If the record safety tab has been removed, playback begins automatically. Although the DVD deck is selected, the VHS deck is selected automatically if the DVD deck is in stop mode.
- Select the appropriate colour system with "PAL/MESECAM" and "NTSC" in Function Set. (☞ pg. 54)
- The unit's power comes on automatically and the counter is reset to 0:00:00.

2 Select the VHS deck.

On the unit

Press **VCR/DVD** repeatedly so that the VCR indicator lights up.

On the remote control

Press **VCR** so that the VCR indicator lights up.

3 Find the programme start point.

If the tape is advanced past the start point, press ◀◀. To go forward, press ▶▶.

4 Start playback.

Press ▶. "bEst" appears blinking on the front display panel during automatic tracking. (☞ pg. 25)

5 Stop playback.

Press ■. Then press ▲ on the VHS deck to remove the cassette.

Usable cassettes

- Compact VHS camcorder recordings can be played on this unit. Simply place the recorded cassette into a VHS Cassette Adapter and it can be used just like any full-sized VHS cassette.
- This video recorder is equipped with SQPB (S-VHS QUASI PLAYBACK) that lets you watch tapes recorded in the S-VHS format and the SP mode with regular VHS resolution.
 - * SQPB does not deliver Super VHS resolution.
- This video recorder can record on regular VHS and Super VHS cassettes. However, it will record regular VHS signals only.
 - * S-VHS recording is not possible with this recorder.

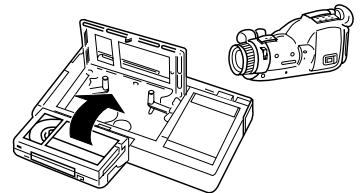

Playback Features

- Turn on the TV and select the video channel (or AV mode).
- Slide the **TV/VCR/DVD** switch on the remote control to the right.

ATTENTION

In the search, still, slow-motion or frame-by-frame playback mode,

- the picture will be distorted.
- the noise bars will appear.
- there may be a loss of colour.
- you cannot hear the sound.

Still Picture/Frame-By-Frame Playback

1 Pause during playback.

Press **II**.

- If there is vertical jitter, press **PR +/-** on the remote control to correct the picture.

2 Activate frame-by-frame playback.

Press **II**.

NOTE:

Still picture playback stops automatically after 5 minutes to protect the heads.

Slow Motion

While playback is paused, press and hold **II** for 2 seconds, then release. Press **II** and release again to return to still picture.

NOTE:

During slow motion playback, some noise may appear on the TV screen. Press **PR +** or **-** on the remote control to eliminate the noises.

Variable Speed Search

During playback, press **▶▶** for forward variable speed search, or **◀◀** for reverse variable speed search.

- The speed changes for each direction by pressing **◀◀** or **▶▶** repeatedly.

When pressing **▶▶**: +5x ↔ +7x/
NTSC-EP +11x ↔ +21x

When pressing **◀◀**: -1x ↔ -5x ↔ -7x/
NTSC-EP -1x ↔ -11x ↔ -21x

(Once **◀◀** is pressed, reverse search starts in -1x normal playback speed. After this process, each press of **◀◀** changes the search speed between -5x and -7x/NTSC-EP -11x and -21x.)

NOTE:

The search speed changes in the same way for SP, LP, and EP modes.

To resume normal playback, press **▶**.

Skip Search

During playback, press **⏮** 1 to 6 times to skip over unwanted sections.

Each press initiates a 30-second period of fast-motion playback. Normal playback resumes automatically.

To resume normal playback during a Skip Search, press **▶**.

Index Search

Your unit automatically marks index codes at the beginning of each recording. This function gives you quick access to any one of 9 index codes in either direction.

NOTE:

Before starting, make sure the unit is in the Stop mode.

Activate Index Search.

Press **◀◀** or **▶▶**. "◀◀ 1" or "▶▶ 1" is displayed on the TV screen and search begins in the corresponding direction.

- To access index codes 2 through 9, press **◀◀** or **▶▶** repeatedly until the correct index number is displayed.

Example:

To locate the beginning of B from the current position, press **◀◀** twice.

To locate the beginning of

D from the current position, press **▶▶** once.

- When the specified index code is located, playback begins automatically.

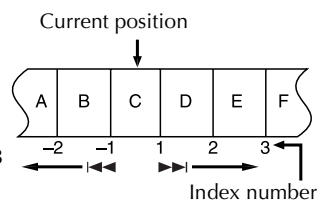

Next Function Memory

The Next Function Memory "tells" the unit what to do after rewinding. Before continuing, make sure the unit is in the Stop mode.

- For Automatic Start Of Playback
Press **◀◀**, then press **▶** within 2 seconds.
- For Automatic Power Off
Press **◀◀**, then press **⏻** within 2 seconds.
- For Automatic Timer Standby
Press **◀◀**, then press **⌚** within 2 seconds.
- For Automatic Cassette Ejection After Tape Rewind
Press **◀◀**, then press **⏮** within 2 seconds.

One Touch Replay

Press **⏮** during playback.

Pressing **⏮** once moves the playback position back to about 7 seconds before the current position. You can press **⏮** up to 4 times each One Touch Replay.

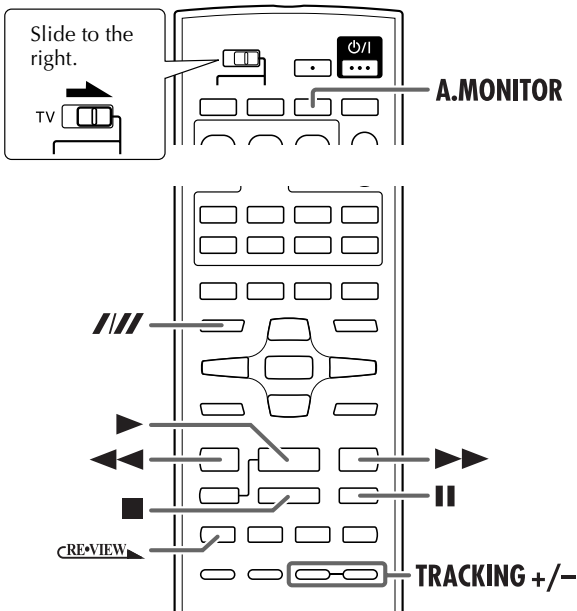

Instant ReView

Simply by pressing a single button, the unit power comes on, rewinds, and begins playback of the last timer-recorded programme. If you have several programmes recorded, you can easily access any of them.

NOTE:

Before starting, make sure that the unit is off and that the Timer mode is disengaged.

Activate Instant ReView.

Press **REVIEW**. The unit power comes on and the unit searches for the index code indicating the start of the last timer-recorded programme. Once it's found, playback begins automatically.

- To watch the first of the 3 programmes, press **REVIEW** three times. The unit searches and begins playback automatically. You can access a programme as far as 9 index codes away from the current tape position.

Repeat Playback

Your unit can automatically play back the whole tape 100 times repeatedly.

1 Start playback.

Press **▶**.

2 Activate Repeat Playback.

Press **▶** and hold for over 5 seconds, then release.

- The Play indicator (▷) on the front display panel blinks slowly.
- After playing back a tape 100 times, the unit stops automatically.

3 Stop Repeat Playback.

Press **■** at any time.

- Pressing **▶**, **◀**, **▶▶** or **||** also stops Repeat Playback.

NOTE:

Repeat playback is not possible with a cassette recorded in EP mode.

Manual Tracking

Your unit is equipped with automatic tracking control. During playback, you can override this and adjust the tracking manually by pressing the **TRACKING +/-** buttons.

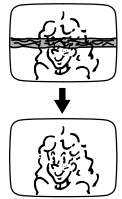

1 Override automatic tracking.

During playback, press **TRACKING +** and **-** at the same time.

2 Adjust the tracking manually.

Press **TRACKING +/-**.

- Press **TRACKING +** and **-** at the same time again to return to automatic tracking.

NOTE:

When a new tape is inserted, the unit enters the automatic tracking mode automatically.

Soundtrack Selection

Your unit is capable of recording three soundtracks (HI-FI L, HI-FI R and NORM) and will play back the one you select.

During Playback

Pressing **A.MONITOR** changes the soundtrack as follows:

TRACK	USE
On-Screen Display	
HI FI L R	For Hi-Fi stereo tapes
HI FI L	For main audio of Bilingual tapes
HI FI R	For sub audio of Bilingual tapes
NORM	For audio-dubbed tapes
HI FI NORM	For audio-dubbed tapes

NOTES:

- "HI-FI L R" should normally be selected. In this mode, Hi-Fi stereo tapes are played back in stereo, and the normal audio track is played back automatically for tapes with only normal audio.
- For instructions on recording stereo and bilingual programmes, refer to page 25.
- "O.S.D." must be set to "ON" or the on-screen displays will not appear. (▶ pg. 54)

Basic Recording

- Turn on the TV and select the video channel (or AV mode).
- Slide the **TV/VCR/DVD** switch on the remote control to the right.

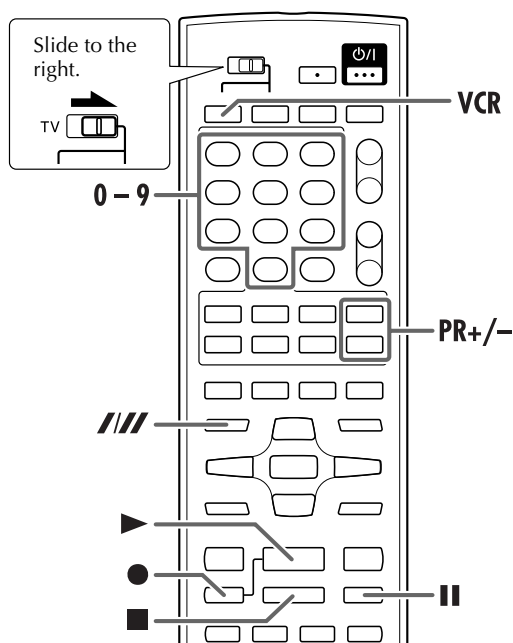
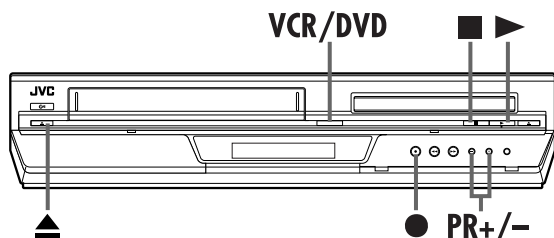

1 Load a cassette.

Insert a cassette with the record safety tab intact.

- The unit's power comes on automatically and the counter is reset to 0:00:00.
- Select the appropriate colour system with "PAL/MESECAM" and "NTSC" (pg. 54).

2 Select the VHS deck.

On the unit

Press **VCR/DVD** repeatedly so that the VCR indicator lights up.

On the remote control

Press **VCR** so that the VCR indicator lights up.

3 Choose a programme.

Press **PR +/-** or the **number keys** to select the channel you wish to record.

4 Set the tape speed.

Press **///**. The current setting appears on the front display panel or TV screen. Press **///** again to change the setting while the tape speed is displayed on the TV screen.

- Each time you press **///**, the mode changes as follows.

SP ↔ LP (or EP*)

*EP is for NTSC only.

5 Start recording.

Press and hold **●** and press **▶** on the remote control, or press **●** on the unit.

B.E.S.T. works at the beginning of both the first SP and the first LP recording after inserting the cassette. (pg. 25)

6 Pause/Resume recording.

Press **||**. Press **▶** to resume recording.

- You can select channel during the Record Pause mode.

7 Stop recording.

Press **■**. Then press **▲** on the VHS deck to remove the cassette.

Recording Resume Function

If there is a power outage during recording, Instant Timer Recording, or timer recording (pg. 24, 29), the recording will resume automatically when power is restored to the unit unless the unit's memory backup has expired.

Accidental erasure prevention

To prevent accidental recording on a recorded cassette, remove its safety tab. To record on it later, cover the hole with adhesive tape.

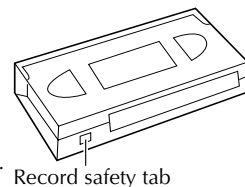

Recording Features

- Turn on the TV and select the video channel (or AV mode).
- Slide the TV/VCR/DVD switch on the remote control to the right.

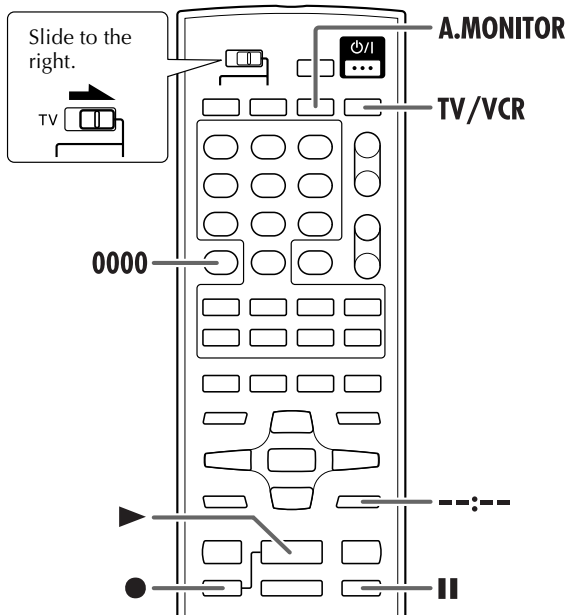

Record One Programme While Watching Another

Once recording is in progress, all you need to do is to set the channel controls on the TV for the station you wish to view.

- The programme selected with the TV's channel controls appears on the TV screen, while the one selected with the unit's PR buttons is recorded on the tape.

NOTE:

You can also use the DVD deck in the following cases. Before use, be sure to turn on the unit and select the DVD deck.

- During recording
- During timer recording
- During timer standby mode

Instant Timer Recording (ITR)

This easy method lets you record for from 30 minutes to 6 hours (selectable in 30-min. increments), and shuts the unit off after recording is finished.

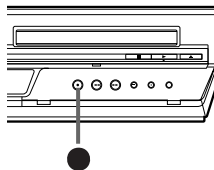

1 Start recording.

Press ● on the unit.

2 Engage the ITR mode.

Press ● again. "0" blinks and "0:30" appears on the front display panel.

3 Set the recording duration.

If you want to record for more than 30 minutes, press ● to extend the time. Each press extends recording time by 30 minutes.

NOTES:

- You can only perform ITR using the ● button on the unit's front panel.
- When the end of the tape is reached during Instant Timer Recording, the unit is turned off and "0" and "▷" blink on the front display panel.
- When the end of the tape is reached during timer recording, the unit is turned off and "●", "▶" and "⊖" blink on the front display panel.

Elapsed Recording Time Indication

1 Set the counter display.

Press --:-- until a counter reading appears on the front display panel.

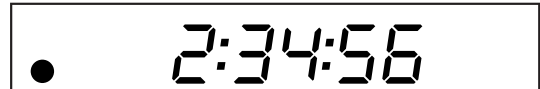

2 Reset the counter.

Press 0000 before starting recording or playback.

- The counter is reset to "0:00:00" and shows the exact elapsed time as the tape runs. You can check the exact time of a recording or playback.

Tape Remaining Time

Press --:-- until the time remaining on the tape appears.

- The front display panel shows the tape remaining time with ":" displayed.

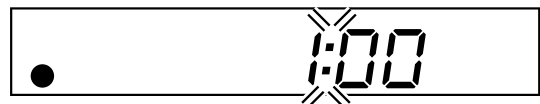

- By pressing the --:-- button, you can change the display to show the channel position, clock time, counter reading, and tape remaining time.

* The channel position is not displayed during playback.

NOTES:



- When you press --:-- , the on-screen display appears on the TV screen for 5 seconds.
- Depending on the type of tape being used, the tape remaining time reading may not appear right away, or is not correct. "--:--" may sometimes appear with ":" blinking, or the display may blink on occasion.

Receiving Stereo and Bilingual Programmes

Your unit is equipped with a Sound-Multiplex decoder (A2) and a Digital stereo sound decoder (NICAM) making reception of stereo and bilingual broadcasts possible.

When the channel is changed, the type of broadcast being received will be displayed on the TV screen for a few seconds.

Type of Broadcast Being Received	On-screen Display
A2 Stereo	ST
A2 Bilingual	BIL.
Regular Monaural	(none)
NICAM Stereo	ST NICAM
NICAM Bilingual	BIL. NICAM
NICAM Monaural	NICAM

- To listen to a stereo programme, press **A.MONITOR** until "HIFI L  R" appears on the TV screen.
- To listen to a bilingual programme, press **A.MONITOR** until "HIFI L  R" or "HIFI  R" appears on the TV screen.
- To listen to the standard (Regular Monaural) audio while receiving a NICAM broadcast, press **A.MONITOR** until "NORM" appears on the TV screen.

NOTE:

"O.S.D." must be set to "ON," or the on-screen displays will not appear. (📖 pg. 54)

To Record Stereo and Bilingual Programmes (A2)

Stereo programmes are automatically recorded in stereo on the Hi-Fi audio track (with the normal audio track recording mixed L and R channel sound).

- Bilingual programmes are automatically recorded in bilingual on the Hi-Fi audio track. The main soundtrack will be recorded on the normal audio track.

To Record NICAM Stereo and Bilingual Programmes

The NICAM audio programme will be recorded on the Hi-Fi audio track, and the standard audio programme will be recorded on the normal audio track.

NOTES:

- If the quality of stereo sound being received is poor, the broadcast will be received in monaural with better quality.
- Before playing back a programme recorded in stereo, or a bilingual programme, refer to "Soundtrack Selection" on page 22.

B.E.S.T. Picture System

The B.E.S.T. (Biconditional Equalised Signal Tracking) system checks the condition of the tape in use during playback and recording, and compensates to provide the highest-possible playback and recording pictures. You can set "B.E.S.T." to "ON" or "OFF" to your preference.

(📖 pg. 54)

Playback

The unit assesses the quality of the tape once you initiate playback.

- The unit adjusts the playback picture quality based on the quality of the tape in use.
- B.E.S.T. is active during automatic tracking. "bEST" appears blinking on the front display panel.
- "bEST" only appears at the beginning of automatic tracking. Even though it doesn't appear after that, the B.E.S.T. function is operative.

Recording

The unit assesses the quality of the tape once you initiate recording.

- The unit spends approximately 7 seconds assessing the condition of the tape, then begins recording.

ATTENTION

Since the B.E.S.T. system works before recording actually starts, there is a delay of approximately 7 seconds after ● and ► on the remote control are pressed, or ● on the unit is pressed. To make sure you record the desired scene or programme in its entirety, first perform the following steps:

- 1 Press and hold  and press ● to engage the Record Pause mode.
- The unit then automatically checks the condition of the tape and, after approximately 7 seconds, re-enters Record Pause mode.
- 2 Press ► to start recording.

If you want to bypass the B.E.S.T. system and begin recording immediately, set "B.E.S.T." to "OFF". (📖 pg. 54)

G-CODE® / SHOWVIEW™ System Setup

The G-CODE timer programming system eliminates the need to input channel, date, start and stop time data when setting the timer record function. Simply key in the G-CODE number for the TV programme you wish to record (found in most TV listings) and the unit's timer is automatically programmed. You have to set Guide Program numbers, which are assigned to each station for purposes of ShowView timer programming, for all the stations stored in your unit's memory to get proper results. Before G-CODE setup you must have performed Auto Set Up. (ⓘ pg. 14)

IMPORTANT

After setting the Guide Program Numbers, channel positions may be incorrect if you stored or skipped channels. In this case, re-perform Guide Program Number settings.

INFORMATION

G-CODE and SHOWVIEW are different trademarks used to represent the same easy recording feature, but only the term G-CODE system will be used in the instructions. If you use the SHOWVIEW system, follow the same instructions listed for the G-CODE system.

- Turn on the TV and select the video channel (or AV mode).
- Slide the TV/VCR/DVD switch on the remote control to the right.

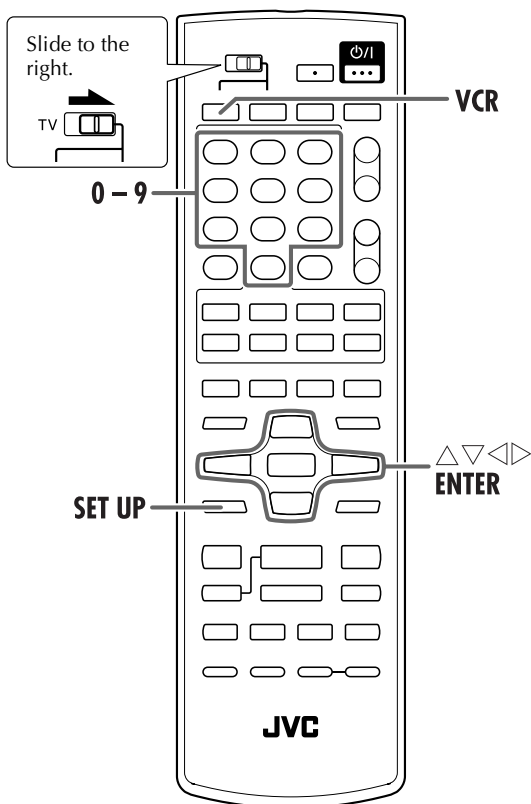

Guide Program Number Set

1 Select the VHS deck.

On the unit
Press **VCR/DVD** repeatedly so that the VCR indicator lights up.

On the remote control
Press **VCR** so that the VCR indicator lights up.

2 Access the Main Menu screen.

Press **SET UP**.

3 Access the Initial Set screen.

Press Δ / ∇ to move the highlight bar (pointer) to "INITIAL SETUP," then press **ENTER** or \triangleright .

4 Access the Guide Program Set screen.

Press Δ / ∇ to move the highlight bar (pointer) to "G-CODE/SHOWVIEW SETUP," then press **ENTER** or \triangleright .

5 Enter the Guide Program number.

Press Δ / ∇ or **number keys** to enter the Guide Program number for the desired station as shown in the TV listings. Then press **ENTER** or \triangleright .

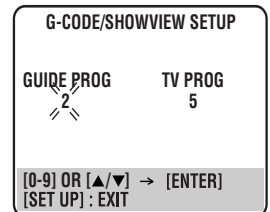

6 Enter the Receiving channel position number.

Then press Δ / ∇ or **number keys** to input the number of the unit's channel position on which the Guide Program number's broadcast is received by the unit. Then press **ENTER** or \triangleright .

- If the satellite broadcast is received on your unit's auxiliary channel "L-1," select "L-1" for the channel position.
- Repeat steps **5** and **6** as necessary.

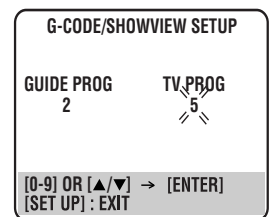

7 Return to the normal screen.

Press **SET UP**.

Guide Program Number

"Guide Program (GUIDE PROG) number" refers to the assigned TV station numbers, according to broadcast area, for G-CODE timer recording. The Guide Program numbers can be found in most TV listings.

G-CODE® / SHOWVIEW™ Timer Programming

With the G-CODE®/SHOWVIEW™ system, timer programming is greatly simplified because each TV programme has a corresponding code number which your unit is able to recognize.

INFORMATION

G-CODE and SHOWVIEW are different trademarks used to represent the same easy recording feature, but only the term G-CODE system will be used in the instructions. If you use the SHOWVIEW system, follow the same instructions listed for the G-CODE system.

Before performing the G-CODE®/SHOWVIEW™ Timer Programming:

- Be sure to read "G-CODE®/SHOWVIEW™ System Setup" (pg. 26)
- Make sure that the unit's built-in clock is set properly.
- Insert a cassette with the safety tab in place. The unit will come on automatically.
- Turn on the TV and select the video channel (or AV mode).
- Slide the TV/VCR/DVD switch on the remote control to the right.
- Select the appropriate color system with "PAL/MESECAM" and "NTSC." (☞ pg. 54)

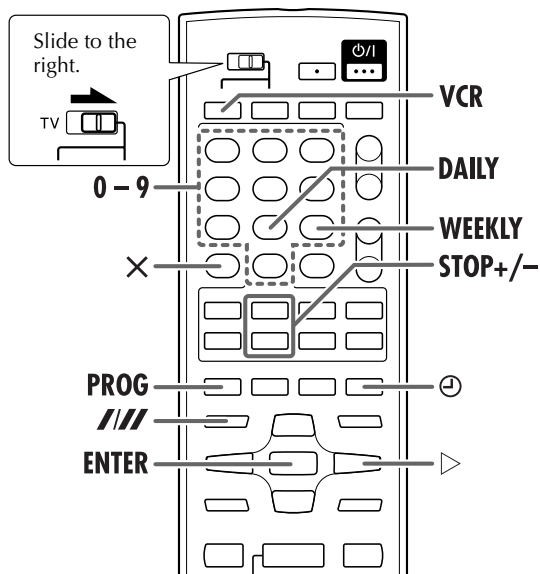

1 Select the VHS deck.

On the unit
Press **VCR/DVD** repeatedly so that the VCR indicator lights up.

On the remote control
Press **VCR** so that the VCR indicator lights up.

2 Access the G-CODE/SHOWVIEW screen.

Press **PROG**.

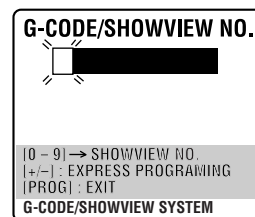

3 Enter the G-CODE number.

Press the **number keys** to enter the G-CODE number of a programme you wish to record.

- If you make a mistake, press **X** and input the correct number.

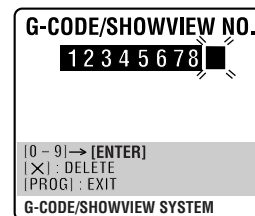

4 Access the G-CODE Program screen.

Press **ENTER**, then the G-CODE Program screen appears (if you're just starting out, "P1" appears).

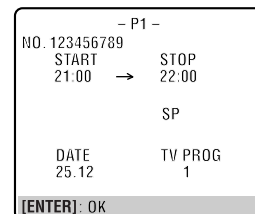

IMPORTANT

Make sure the channel position number you wish to record is displayed; if not, see "G-CODE®/SHOWVIEW™ System Setup" on page 26 and set the Guide Program number correctly.

- If the number you entered is invalid, "ERROR" appears on the TV screen. Press **X** and input a valid G-CODE number.
- If the "G-CODE/SHOWVIEW SETUP" screen appears, see "ATTENTION" on page 28.

5 Set the tape speed.

Press **///** (SP/LP or EP*).

* EP is for NTSC only.

6 Return to the normal screen.

Press **PROG** or **ENTER**. "PROGRAM COMPLETED" appears on the TV screen for about 5 seconds, then the normal screen appears. If "PROGRAM OVERLAPPED" appears on the TV screen, see page 28.

- Repeat steps 2 – 3 for each additional programme.

7 Engage the unit's timer mode.

Press **⊖**. The unit turns off automatically and "⊖" appears on the front display panel.

- To disengage the timer mode, press **⊖** again.

NOTES:

- To Change The Stop Time:
 - press **STOP +/-** after pressing **ENTER** in step 4. You can compensate for anticipated programme schedule delays.
- To Timer-Record Weekly Or Daily Serials:
 - after pressing **ENTER** in step 4, press **WEEKLY** (number key "9") for weekly serials or **DAILY** (number key "8") for daily serials (Monday — Friday). Either "WEEKLY" or "DAILY" appears on the TV screen. Pressing the button again makes the corresponding indication disappear.
- You can programme this unit to timer-record as many as 8 programmes. If you try to programme the unit to record a ninth, "PROGRAM FULL" appears on the TV screen and "FULL" appears on the front display panel. To record the extra programme, you must first cancel any unnecessary programmes. (ⓘ pg. 30)

ATTENTION

Guide Program Number Set

"G-CODE/SHOWVIEW SETUP" appears after performing step 4 if the Guide Program number for the G-CODE number you entered has not been set.

Press **△▽** or the **number keys** to input the channel position number on which your unit receives that station, then press **ENTER** or **▷** to set the Guide Program number. The G-CODE Program screen appears.

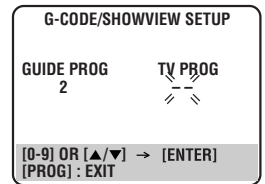

Express Timer Programming

If you do not know the G-CODE number for the programme you wish to record, use the following procedure to set your unit to timer-record the programme.

Before performing Express Timer Programming:

- Make sure that the unit's built-in clock is set properly.
- Insert a cassette with the safety tab in place. The unit will come on automatically.
- Turn on the TV and select the video channel (or AV mode).
- Slide the TV/VCR/DVD switch on the remote control to the right.
- Select the appropriate colour system with "PAL/MESECAM" and "NTSC" (see pg. 54).

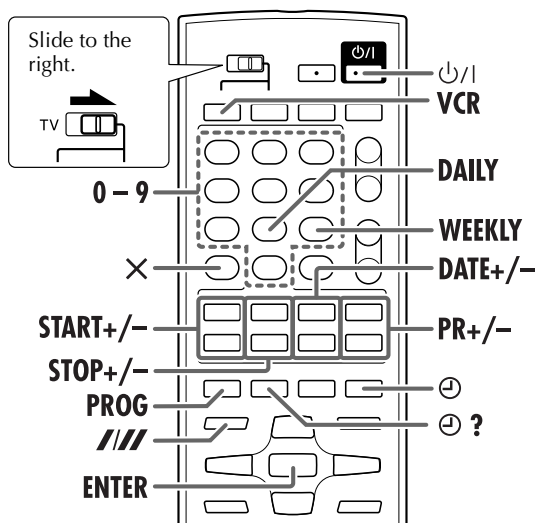

Example: To timer-record the programme from 21:00 to 22:00 on 25th December, on channel 1.

1 Select the VHS deck.

On the unit

Press **VCR/DVD** repeatedly so that the VCR indicator lights up.

On the remote control

Press **VCR** so that the VCR indicator lights up.

2 Access the G-CODE/SHOWVIEW screen.

Press **PROG**.

3 Access the Programme screen.

Press **START +/-**. (If you're just starting out, "P1" appears.)

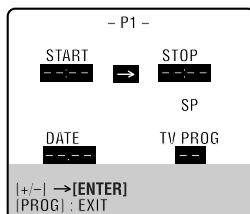

4 Enter the programme start time.

Press **START +/-** to enter the time you want recording to start.

- Press and hold **START +/-** to move in 30-minute increments, or press and release repeatedly to move 1 minute at a time.

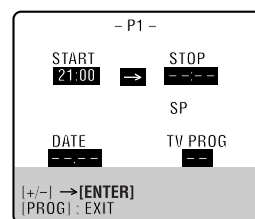

5 Enter the programme stop time.

Press **STOP +/-** to enter the time you want recording to stop.

- Press and hold **STOP +/-** to move in 30-minute increments, or press and release repeatedly to move 1 minute at a time.

6 Enter the programme date.

Press **DATE +/-**.

- The current date appears on the TV screen. The date you enter appears in its place.

7 Enter the channel position.

Press **PR +/-**.

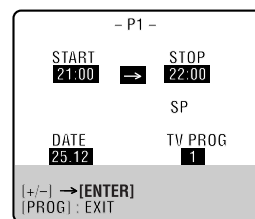

8 Set the tape speed.

Press **///** (SP/LP or EP*).

* EP is for NTSC only.

9 Return to the normal screen.

Press **PROG** or **ENTER**. "PROGRAM COMPLETED" appears on the TV screen for about 5 seconds, then the normal screen appears.

- If "PROGRAM OVERLAPPED" appears on the screen, see page 28.
- Repeat steps 2 - 9 for each additional programme.

10 Engage the unit's timer mode.

Press **⏻**. The unit turns off automatically and "⏻" appears on the front display panel.

- To disengage the timer mode, press **⏻** again.

To Timer-Record Weekly Or Daily Serials:

— anytime during steps **4** through **8**, press **WEEKLY** (number key "9") for weekly serials or **DAILY** (number key "8") for daily serials (Monday – Friday). Either "WEEKLY" or "DAILY" appears on the TV screen. Pressing the button again makes the corresponding indication disappear.

NOTES:

- You can programme this unit to timer-record as many as 8 programmes. If you try to programme the unit to record a ninth, "PROGRAM FULL" appears on the TV screen and "FULL" appears on the front display panel. To record the extra programme, you must first cancel any unnecessary programmes. (⏮ "To cancel or change a programme").

Check, cancel and change programmes**1 Disengage the timer mode.**

Press ⊖, then press ⏮/I.

2 Access the Programme Check screen.

Press ⊖ ?.

PR	START	STOP	CH	DATE
1	8:00	10:00	3	24.12
2	10:00	10:45	2	25.12
3	11:30	13:00	1	25.12
4				
5				
6				
7				
8				

⊖ ?] : NEXT

3 Access the Programme screen.

Press ⊖ ? again to check more information. Each time you press ⊖ ?, the next programme's information appears.

- P1 -	
START	STOP
8:00	10:00
→	
SP	
DATE	TV PROG
24.12	3

⊖ ?] : NEXT

To cancel or change a programme**4 Cancel or change a programme.**

Press X to cancel a programme. To change programme settings, press the appropriate button: **START** +/-, **STOP** +/-, **DATE** +/-, **PR** +/-, **DAILY** (number key "8"), **WEEKLY** (number key "9") and/or **///** (SP/LP or EP*)
* EP is for NTSC only.

5 Return to the normal screen.

Press ⊖ ? as many times as necessary. If there are still some programmes remaining, go on to step **6**.

6 Return to the timer mode.

Press ⊖.

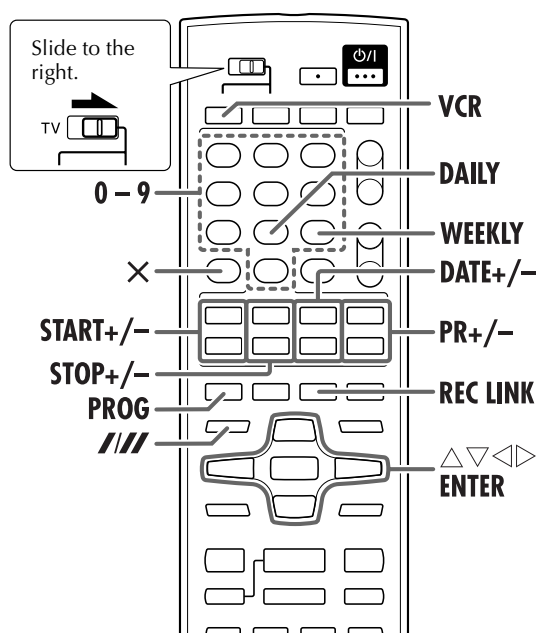

3 Cancel or change programme setting.

To cancel a programme, press **X** when the Programme screen you do not want is shown. "PROGRAM COMPLETED" appears on the TV screen for about 5 seconds, then the normal screen appears.

To change a programme, press the appropriate button: **START +/-**, **STOP +/-**, **DATE +/-**, **PR +/-**, **DAILY** (number key "8"), **WEEKLY** (number key "9") and/or **///** when the Programme screen on which you want to make changes is shown, then press **ENTER**. "PROGRAM COMPLETED" appears on the TV screen for about 5 seconds, then the normal screen appears.

NOTE:

If the overlap is not yet solved, or another overlap occurs with the timer programme setting after making the last correction on a programme, the conflicting programmes will be shown on the Programme Check screen again. Repeat the above steps again until the overlap is solved.

When programmes overlap each other

If "PROGRAM OVERLAPPED" appears, you have another programme overlapping the programme you have just made. The Programme Check screen appears and conflicting programmes will start blinking.

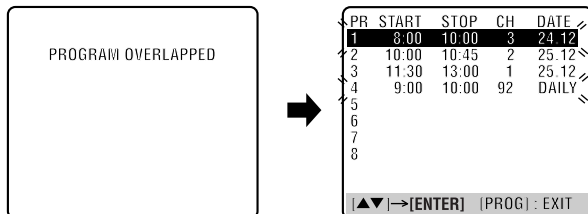

Example: Programme 1 (you have just made) and Programme 4 overlap each other.

1 Confirm the overlapping programmes.

Overlapping programmes blink on the TV screen.

2 Select the programme to modify.

Press $\Delta \nabla$, then press **ENTER** or \triangleright .

- You can only select one of the overlapping programmes.

NOTE:

If you do not mind this overlap, press **PROG** to finish the timer programme setting. The programme with the lower programme number will be recorded and the other one will not be recorded correctly. If no changes are made for approximately 1 minute, the unit will return to the normal screen.

Automatic Satellite Programme Recording

This function allows you to automatically record a satellite programme which is timer-programmed on your external satellite receiver. Connect a satellite receiver to the unit's L-1 Input Connector (INPUT (L-1)) and programme the timer on the satellite receiver. The unit starts or stops recording by the signals input from the satellite receiver. After recording, the unit's power shuts off automatically.

ATTENTION

- Be sure not to turn on the satellite receiver before the programme is executed; otherwise, the unit will start recording when the satellite receiver's power is turned on.
- If you have connected another appliance other than a satellite receiver to the L-1 Input Connector (INPUT (L-1)), be sure not to engage the Automatic Satellite Programme Recording mode; otherwise, the unit will start recording when the connected appliance's power is turned on.
- Automatic Satellite Programme Recording and timer-recording cannot be done at the same time.

Before performing the following steps:

- Make sure the satellite receiver is connected to the unit's L-1 Input Connector (INPUT (L-1)) connector.
- Programme the timer on the satellite receiver.
- Insert a cassette with the safety tab in place.
- Slide the TV/VCR/DVD switch on the remote control to the right.

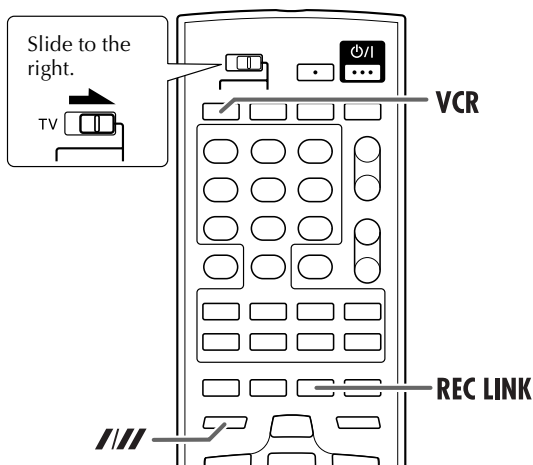

2 Set the tape speed.

Press **///**.

3 Engage the Automatic Satellite Programme Recording mode.

Press and hold **REC LINK** for about 2 seconds.

- The "⏰" and "⊕" indicators light up and the unit turns off automatically.



NOTES:

- Operation on the DVD deck is not possible when the Automatic Satellite Programme Recording mode is engaged, or Timer Recording is in progress.
- To disengage the Automatic Satellite Programme Recording mode, press **REC LINK**. The "⏰" indicator goes off.
- If the unit's power is off, it is not possible to engage the Automatic Satellite Programme Recording mode.
- In step **3**, if the "⏰" indicator does not light but instead blinks quickly even though your satellite receiver's power is off, Automatic Satellite Programme Recording will not work properly with that satellite receiver*.
 - * Some satellite receivers output signals even if the power is off. Automatic Satellite Programme Recording is not possible with those satellite receivers.
- The "⏰" indicator blinks while Automatic Satellite Programme Recording is in progress.
- For timer programming of the satellite receiver, refer to the instruction manual of the satellite receiver.
- Automatic Satellite Programme Recording is not possible if your satellite receiver does not have a timer.
- Pressing the unit's ⊕/1 button while Automatic Satellite Programme Recording is in progress turns off the unit's power and disengages the Automatic Satellite Programme Recording mode.
- If there are more than one satellite programmes you wish to record with Automatic Satellite Programme Recording, it is not possible to set different tape speeds for each programme.
- Depending on the type of satellite receiver, the unit may not record a slight portion of the beginning of the programme or may record slightly longer than the actual length of the programme.
- If you engage the Automatic Satellite Programme Recording mode when the satellite receiver's power is on, the unit will not start Automatic Satellite Programme Recording even though the "⏰" and "⊕" indicators blink. When the satellite receiver shuts off once and is turned back on again, the unit starts recording.
- You can also record a programme from your cable system in the same way if the system has a timer.
- The B.E.S.T. system (Ⓜ pg. 25) does not work while Automatic Satellite Programme Recording is in progress.

1 Select the VHS deck.

On the unit

Press **VCR/DVD** repeatedly so that the VCR indicator lights up.

On the remote control

Press **VCR** so that the VCR indicator lights up.

Basic Playback



- Turn on the TV and select the VCR channel (or AV mode).
- Slide the **TV/VCR/DVD** switch on the remote control to the right.

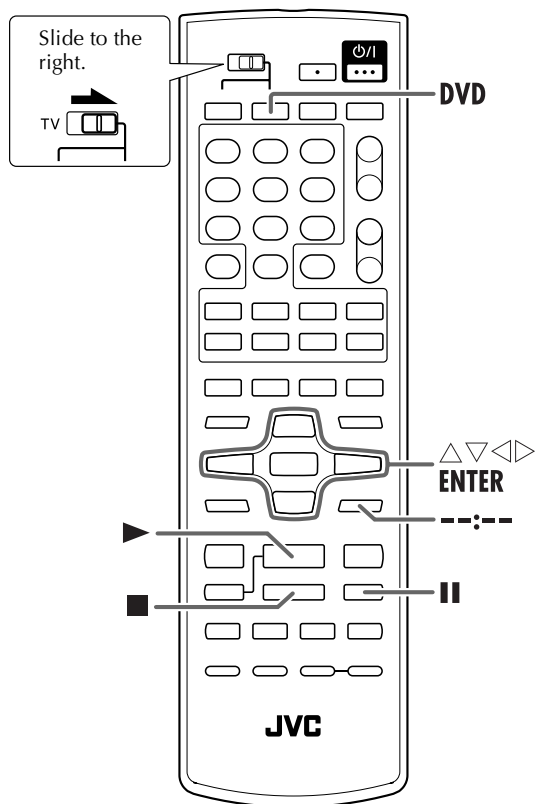
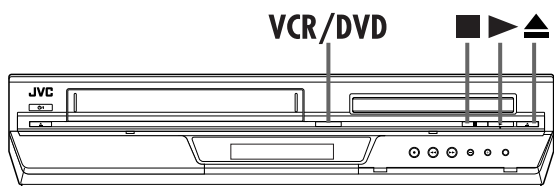

ATTENTION

- You can not use the DVD deck when the VCR deck is in the Automatic Satellite Recording standby and recording mode.
- You can use the DVD deck when the VCR deck is in the timer standby mode.
- If the unit does not accept an operation, appears on the TV screen. (Operations are occasionally unacceptable even if is not displayed.)

1 Load the disc.

- For details, refer to “Placing a Disc” (pg. 5).

2 Select the DVD deck.

On the unit

Press **VCR/DVD** repeatedly so that the DVD indicator lights up.

On the remote control

Press **DVD** so that the DVD indicator lights up.

3 Start playback.

Press .

Example: DVD VIDEO

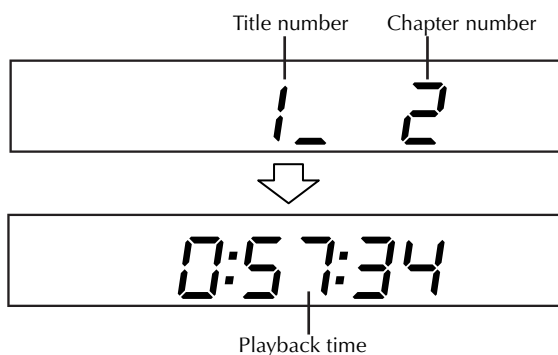

- You can switch the display on the front display panel between the title/chapter/track number and the playback time by pressing .
- It may take a few seconds to start playback.
- When inserting a DVD or Video CD disc, a menu display may appear on the TV screen. To play back from the menu, refer to “Locating a Desired Scene Using the Menu of the Video CD with Playback Control (PBC) Function” (pg. 34) or “Locating a Desired Scene Using the DVD Menu” (pg. 34).

4 Pause playback.

Press .

- To resume normal playback, press .

5 Stop playback.

Press .

- When “RESUME” (pg. 58) is “ON,” the unit memorizes the position on the disc where you have interrupted playback.
 - To resume playback, press .
 - To stop playback completely, press again.
- Press on the DVD deck to open the disc tray, then remove the disc.

Playback Features

- Turn on the TV and select the VCR channel (or AV mode).
- Slide the **TV/VCR/DVD** switch on the remote control to the right.

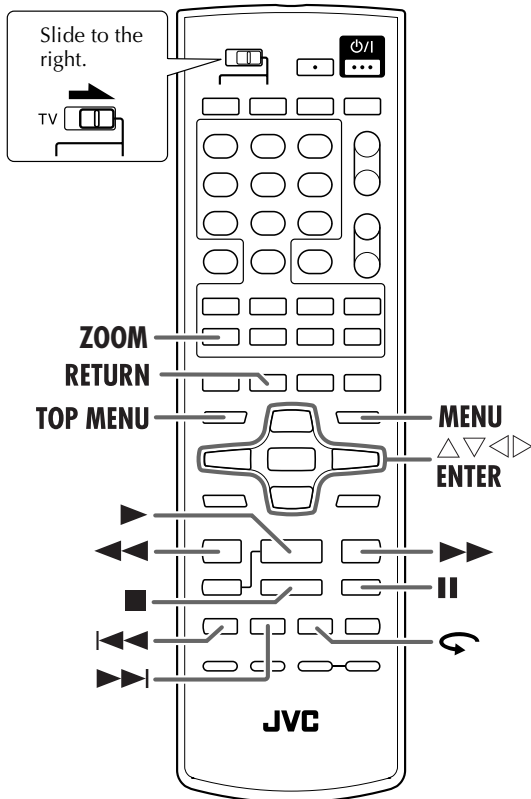

Locating a Desired Scene Using the DVD Menu



DVD VIDEO discs generally have their own menus which show the disc contents. These menus contain various items such as titles of movies, names of songs, or artist information, and display them on the TV screen. You can locate a desired scene using the DVD menu.

- 1 Access the DVD menu.**
Press **TOP MENU** or **MENU**.

- 2 Start playback.**

Press $\Delta \nabla \triangleleft \triangleright$ to select a desired item, then press **ENTER**.

- It may be possible to select the desired item using the **number keys** depending on the disc.

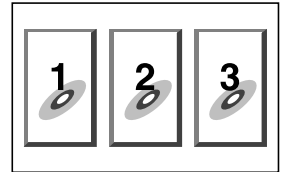

Example:

Locating a Desired Scene Using the Menu of the Video CD with Playback Control (PBC) Function



Some Video CD discs supports the PBC function. PBC is an abbreviation of "PlayBack Control." A Video CD disc recorded with PBC has its own menus, such as a list of the songs of the disc. You can locate a specific scene by using the menu.

- 1 Access the PBC menu.**

In stop mode

Press \blacktriangleright .

- Depending on a disc, PBC menu may automatically appear on the TV screen by simply loading a disc on the unit. "Pbc" appears on the front display panel.

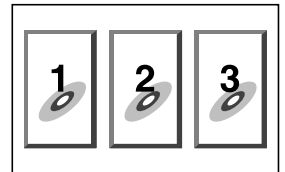

Example:

During playback

Press **RETURN**.

- 2 Start playback.**

Press the appropriate **number keys**.

- The unit starts playback of the selected item.
- When "NEXT" or "PREVIOUS" appears on the TV screen:
Pressing $\blacktriangleright \blacktriangleright$ advances to the next page.
Pressing $\blacktriangleleft \blacktriangleleft$ returns to the previous page.
- The method of the operation is different depending on the disc.

To cancel PBC

Start playback by using the **number keys** instead of \blacktriangleright .

To reactivate PBC

- Press **TOP MENU** or **MENU**.
- Press \blacksquare to stop playback, then press \blacktriangleright .

Locating the Start Point of the Item or Skip the Item



Press **I◀◀** or **▶▶I** during playback.

Example:

To locate the beginning of item B from the current position, press **I◀◀** twice.

To locate the beginning of item D from the current position, press **▶▶I** once.

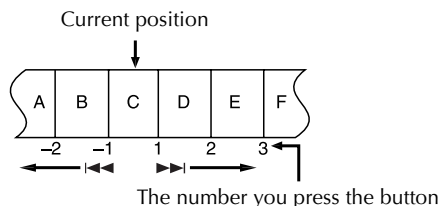

- When the specified item is located, playback begins automatically.

NOTE:

When you press **I◀◀** or **▶▶I**, the counter display may appear instead of title number/chapter number depending on the discs.

Variable Speed Search



During playback, press **▶▶▶** for forward variable speed search, or **◀◀◀** for reverse variable speed search.

- The more times you press, the faster the playback picture moves.
- To resume normal playback, press **▶**.

OR

During playback, press and hold **▶▶▶I** for forward search, or press and hold **I◀◀◀** for reverse search.

- While you press and hold the button, the image is played back at 5x speed.
- To resume normal playback, release **I◀◀◀** or **▶▶▶I**.

NOTES:

- Actual speed may be different from that displayed on the TV screen depending on the discs.
- Playback sound is not heard in any variable speed search mode.

One Touch Replay



Press **↶** while playing back a DVD VIDEO disc.

The playback position moves back about 10 seconds before the current position (only within the same title).

Still Picture/Frame-By-Frame Playback



1 Pause during playback.

Press **II**.

2 Activate frame-by-frame playback.

Press **II** to advance a still picture.

- To resume normal playback, press **▶**.

Slow Motion



During playback, press **II**, then press **▶▶▶** for forward slow motion playback, or **◀◀◀** for reverse slow motion playback.

- Each press of **▶▶▶** changes the playback speed as follows:
1/32 → 1/16 → 1/8 → 1/4 → 1/2
- Each press of **◀◀◀** changes the playback speed as follows (only for DVD VIDEO discs):
-1/32 → -1/16 → -1/8 → -1/4 → -1/2
- To resume normal playback, press **▶**.

NOTES:

- Reverse slow motion playback is possible only with the DVD VIDEO discs.
- This function may not work for some Video CD or SVCD.

Zooming



Press **ZOOM** during playback or while paused.

- Each press of **ZOOM** changes the magnification in the following steps:
ZOOM OFF → ZOOM 1 → ZOOM 2 → ZOOM 3 → ZOOM 4 → ZOOM 5 → ZOOM 6 → (Back to the beginning)
- While zoomed, the picture may look coarse or distorted.

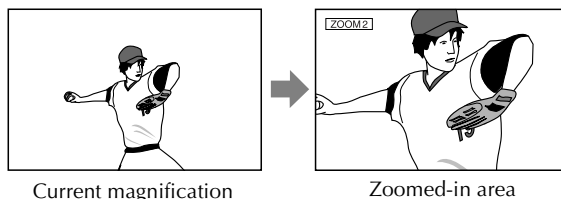

Press **△▽◀▶** to move the zoomed-in scene.

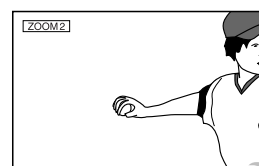

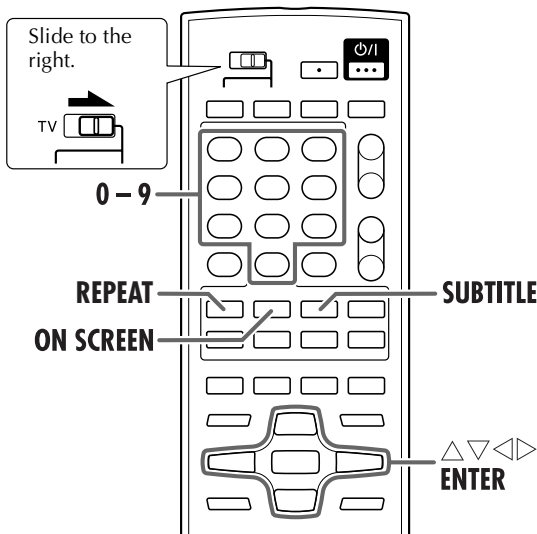

Repeat Playback



You can repeat playback as you like according to the type of disc.
 DVD VIDEO: during playback
 Audio CD: during playback or in stop mode
 Video CD/SVCD: in stop mode or during playback with PBC deactivated

1 Access the repeat mode.

Press **REPEAT**.
 • Repeat mode is displayed on the TV.

2 Select the repeat mode.

Press **REPEAT** repeatedly to select the desired repeat mode.

DVD VIDEO

OFF→CHAPTER→TITLE→A-B→(Back to the beginning)

CHAPTER:	The current chapter is played back repeatedly.
TITLE:	The current title is played back repeatedly.
A-B:	The desired part is played back repeatedly. (☞ right column)
OFF:	Each title and chapter is played back once.

Video CD/SVCD/CD

OFF→TRACK→ALL→A-B→(Back to the beginning)

TRACK:	The current track is played back repeatedly.
ALL:	All tracks are played back repeatedly.
A-B:	The desired part is played back repeatedly. (☞ right column)
OFF:	Each title and chapter is played back once.

- "A-B" cannot be selected while stopped or paused.
- The pop-up window disappears if no operation is done for about 5 seconds.

To cancel Repeat Playback

Press **REPEAT** repeatedly until "OFF" appears on the TV screen.

NOTES:

- Repeat Playback is not possible with a Video CD and SVCD with PBC function.
- Repeat Playback may not work properly depending on the type of disc being used.
- You cannot select A-B Repeat Playback by pressing **REPEAT**.

A-B Repeat Playback



You can repeat the desired part.

1 Access the on-screen bar.

Press **ON SCREEN** twice. The on-screen bar appears on the TV screen.

2 Select menu item.

Press ◀▶ to highlight , then press **ENTER**.
 • The following pop-up window appears under the selected item.



3 Select the repeat mode.

Press ▲▼ repeatedly to select "A-B."

4 Select the start point.

Press **ENTER** at the beginning of the part you want to repeat (point A).
 • The following display appears in the on-screen bar.



5 Select the end point

Press **ENTER** at the end of the part you want to repeat (point B).

- A-B Repeat Playback starts. The selected part of the disc (between point A and B) is played repeatedly.

To cancel A-B Repeat Playback

Repeat from step **1**, select "OFF" in step **3**, then press **ENTER**.

To clear the on-screen bar

Press **ON SCREEN**.

NOTE:

The points A and B must be set in the same title or track.

Time Search



You can play back a disc from the desired point by specifying the elapsed time from the beginning of the current title (for DVD VIDEO) or the disc (for Audio CD/Video CD) using the Time Search.

1 Access the on-screen bar.

Press **ON SCREEN** twice. The on-screen bar appears on the TV screen.

2 Select menu item.

Press ◀▶ to highlight ⏪⏩, then press **ENTER**.

- The following pop-up window appears under the selected item.



3 Select the time.

Press the **number keys** (0-9) to enter the time, then press **ENTER**.

Example:

To play back from a point 2 (hours): 34 (minutes): 08 (seconds) elapsed

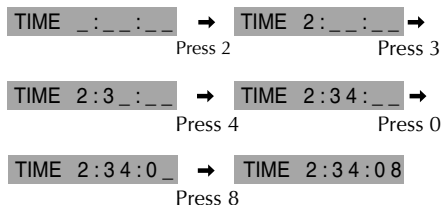

If you have specified a wrong selection,

Press ◀ repeatedly until the wrong number is erased, then press **number keys** to enter the correct numbers.

- The unit starts playback from the specified time.

To clear the on-screen bar

Press **ON SCREEN**.

NOTE:

Some DVD VIDEO discs do not contain time information, and it is not possible to use the Time Search function.

Subtitle Selection



You can select subtitle language.

- During playback

1 Access the menu.

Press **SUBTITLE**.

- The following pop-up window appears on the TV screen.

Example (DVD): "ENGLISH" is selected out of 3 subtitle languages recorded.

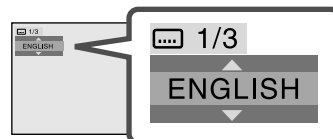

2 Select the subtitle language.

Press ▲▼ repeatedly to select the desired subtitle language. To turn off the subtitle, press **SUBTITLE** repeatedly until "OFF" is selected.

- Each time you press the button, the subtitle language changes.
- The pop-up window disappears if no operation is done for about 5 seconds.

NOTES:

- **For DVD VIDEO**

Some subtitle languages are abbreviated in the pop-up window. See "Language Code List" (pg. 18).

- **For SVCD**

An SVCD can contain up to four subtitles. Pressing **SUBTITLE** changes the subtitles regardless of whether the subtitles are recorded or not.

Audio Language and Sound Selection



The audio selection setting allows you to change the audio language of a movie, or to listen to karaoke with or without the vocal.

- During playback

1 Access the menu.

Press **A.MONITOR**.

- The following pop-up window appears on the TV screen.

Example: "ENGLISH" is selected out of 3 audio languages recorded during DVD VIDEO playback.

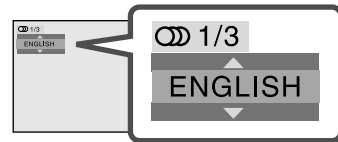

2 Select the audio setting.

Press $\Delta \nabla$ or **A.MONITOR** repeatedly to select the desired audio language.

- Each time you press the button, the audio selection changes.
- The pop-up window disappears if no operation is done for about 5 seconds.

DVD VIDEO (example)

1/3 ENGLISH → 2/3 FRENCH → 3/3 SPANISH → (Back to the beginning)

Video CD

ST → L → R → (Back to the beginning)

ST:	To listen to normal stereo playback.
L:	To listen to L (left) audio channel only.
R:	To listen to R (right) audio channel only.

SVCD

ST 1 → ST 2 → L 1 → R 1 → L 2 → R 2 → (Back to the beginning)

ST 1/ST 2:	To listen to normal stereo playback of ST 1 or ST 2 channel.
L 1/L 2:	To listen to the L (left) 1 or 2 audio channel.
R 1/R 2:	To listen to the R (right) 1 or 2 audio channel.

NOTE:

For DVD VIDEO discs, some audio languages are abbreviated in the pop-up window. See "Language Code List" (pg. 18).

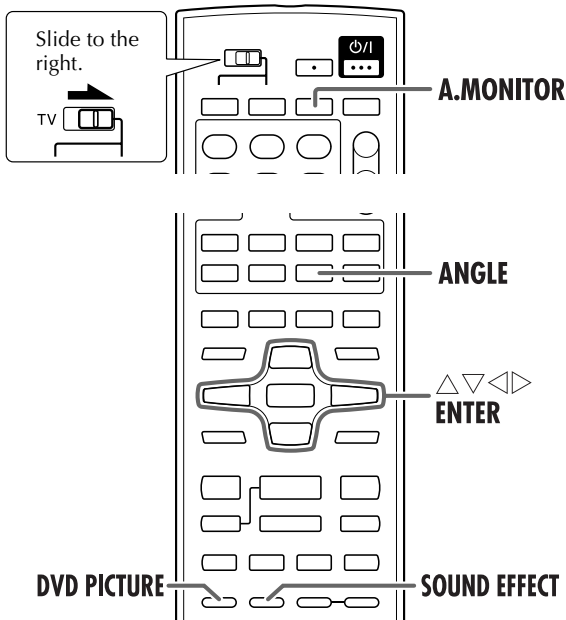

Angle Selection



You can enjoy a variety of scene angles if the DVD VIDEO disc contains "multi-angle" parts, where multiple cameras were used to shoot the same scene from different angles.

- During playback

1 Access the menu.

Press **ANGLE**.

- The following pop-up window appears on the TV screen.

Example: The first view angle is selected out of 3 view angles recorded.

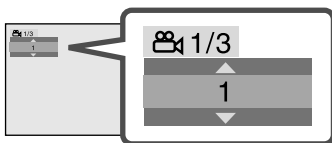

2 Select the view angle.

Press $\Delta \nabla$ or **ANGLE** repeatedly to select the desired view angle.

- Each time you press the button, the angle of the scene changes.
- The pop-up window disappears if no operation is done for about 5 seconds.

Example:

1/3 → 2/3 → 3/3 → (Back to the beginning)

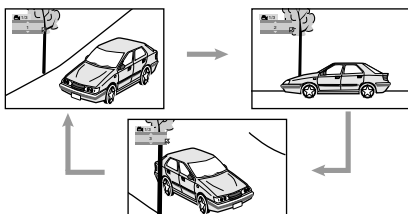

Sound Effect (3D PHONIC)



Using the Sound Effect function (3D PHONIC), you can change the sound field.

- This function works only for analog audio output.

1 Access the selection menu.

Press **SOUND EFFECT** during playback.

- The current setting appears on the TV screen.

2 Select the Sound Effect (3D PHONIC) mode.

Press **SOUND EFFECT** repeatedly to select the desired mode.

- Each time you press **SOUND EFFECT**, the Sound Effect (3D PHONIC) mode changes as follows:
OFF→ACTION→DRAMA→THEATER→(Back to the beginning)

OFF:	No effect
ACTION:	Suitable for action movies and sports programmes in which sounds dynamically move.
DRAMA:	Provides natural and warm sound. You can enjoy movies in a relaxed mood.
THEATER:	You can enjoy sound effects like in a major theater.

- The selection menu disappears if no operation is done for about several seconds.

NOTES:

- The Sound Effect (3D PHONIC) function works correctly only when playing back a DVD VIDEO disc recorded in the Dolby Digital format. With other sources, you cannot get any effect if you activate this function.
- When playing back a DVD VIDEO disc recorded with Dolby Digital that does not contain the rear signal, you cannot get a correct effect even if you activate the Sound Effect (3D PHONIC) function.

VFP function — Adjusting the picture quality



The VFP (Video Fine Processor) function enables you to adjust the picture character according to the type of programing, picture tone or personal preference.

1 Access the VFP setting menu.

Press **DVD PICTURE** during playback.

- The current setting appears on the TV screen.

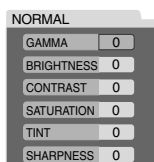

2 Select the VFP mode.

Press $\triangleleft \triangleright$ repeatedly.

- Each time you press $\triangleleft \triangleright$, the VFP mode changes as follows:
NORMAL→CINEMA→USER 1→USER 2→(Back to the beginning)

NORMAL:	Select this normally.
CINEMA:	Suitable for movie.
USER 1/ USER 2:	You can adjust parameters that affect picture appearance and store settings. Go to step 3.

To adjust picture appearance manually

3 Access USER menu.

Press $\triangleleft \triangleright$ repeatedly to select "USER 1" or "USER 2."

4 Select the parameter.

Press $\triangle \nabla$ repeatedly to select a parameter you want to adjust, then press **ENTER**.

- Adjust gradually and confirm picture appearance results are as preferred.

GAMMA (-3 to +3):	Adjust this if the neutral color is bright or dark. The brightness of dark and bright portions is maintained.
BRIGHTNESS (-8 to +8):	Adjust this if the picture is bright or dark on the whole.
CONTRAST (-7 to +7):	Adjust this if the objects in far and near positions look unnatural.
SATURATION (-7 to +7):	Adjust this if the picture is whitish or blackish.
TINT (-7 to +7):	Adjust this if the appearance of flesh tone is unnatural.
SHARPNESS (-8 to +8):	Adjust this if the picture is indistinct.

- VFP menu disappears and the following pop-up window appears on the TV screen.

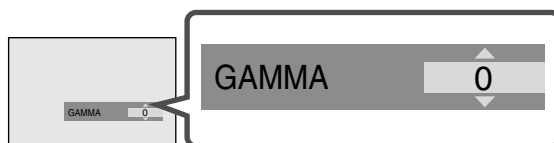

5 Adjust the parameter.

Press $\triangle \nabla$ repeatedly to change the setting, then press **ENTER**.

- The current VFP settings appear again.
Repeat steps 4 and 5 to adjust other parameters.

To return to the normal screen

Press **DVD PICTURE**.

NOTE:

The VFP setting screen disappears if no operation is done for more than about 10 seconds.

Using the on-screen bar



You can check disc information while the disc is loaded and you can use some functions using the on-screen bar. The on-screen bar allows you the various playback operations.

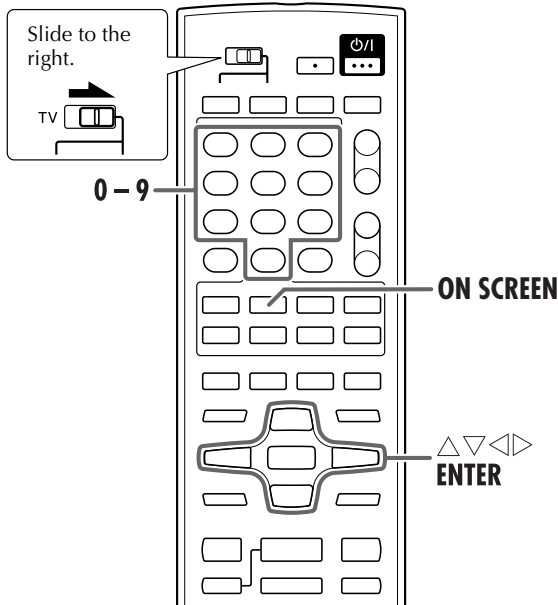

Basic operation on the on-screen bar

During playback

1 Access the on-screen bar.

Press **ON SCREEN** twice. The on-screen bar appears on the TV screen.

- The currently selected item is highlighted.



2 Select menu item.

Press \triangle ∇ to highlight the item you want to work with, then press **ENTER**. The pop-up window appears under the selected item.

After pressing ENTER

- When a pull-down menu appears, press \triangle ∇ to select the setting you want, then press **ENTER**.
- When a number-entry box appears, use the **number key** to enter the number you want, then press **ENTER**.
- When changing the indication of playback time, press **ENTER** repeatedly to select the setting you want.

For details about each function, see page 41.

How to Access the On-Screen Bar

1 Access the status bar.

Press **ON SCREEN** when a disc is loaded. The status bar appears on the TV screen.

Example: During DVD VIDEO playback

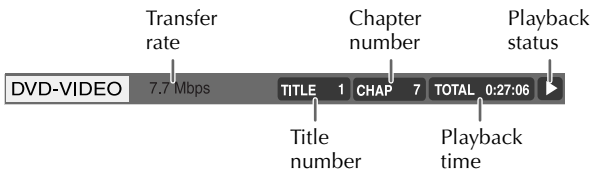

2 Access the menu bar.

Press **ON SCREEN** again. The menu bar appears under the status bar.



To clear the on-screen bar

Press **ON SCREEN**.

Menu Bar Functions for DVD VIDEO

■ Time mode selection

During playback, selects the time mode shown in the status bar and on the front display.

- **TOTAL:** Current title elapsed time
- **T.REM:** Current title remaining time
- **TIME:** Current chapter elapsed time
- **REM:** Current chapter remaining time

■ Repeat mode (See also page 36)

Selects the repeat mode during playback.

- **CHAPTER:** Current chapter repeat
- **TITLE:** Current title repeat
- **A-B:** A-B repeat
- **OFF:** Repeat mode deactivated

■ Time search (See also page 37)

Specifies a time from the beginning of the current title as the point from which to begin playback.

■ Chapter search

During playback, specifies a desired chapter to be played back from.

■ Audio selection (See also page 38)

During playback, selects the audio language or sound track.

■ Subtitle selection* (See also page 37)

During playback, selects the subtitle language.

** It is impossible to select "OFF" when using the on-screen bar. To select "OFF", press ON SCREEN to clear the on-screen bar, then press SUBTITLE repeatedly until "OFF" is selected.*

■ Angle selection (See also page 38)

During playback, selects a desired scene angle in a multi-angle part.

Menu Bar Functions for SVCD/Video CD/Audio CD

■ Time mode selection

Selects the time mode shown in the status bar and on the front display.

- **TIME:** Current track elapsed time
- **REM:** Current track remaining time (while in stop mode, current track total time)
- **TOTAL:** Disc elapsed time
- **T.REM:** Disc remaining time (while in stop mode, disc total time)

■ Repeat mode (See also page 36)

Selects the repeat mode.

- **TRACK:** Current track repeat
- **ALL:** All track repeat
- **A-B:** A-B repeat
- **OFF:** Repeat mode deactivated

■ Time search (See also page 37)

Specifies a time from the beginning of the disc as the point from which to begin playback.

■ Audio selection (See also page 38)

During Video CD/SVCD playback, selects the audio channel(s).

■ Subtitle selection (See also page 37)

During SVCD playback, selects the subtitle.

MP3/JPEG files Playback

Outline

This unit can play back MP3 and JPEG files on a personally recorded on CD-R/RW and commercially available CD disc.

- This unit may be unable to play back the disc due to the characteristics or recording conditions.

Precautions

About files and folders (groups) on the disc

- This unit can recognize up to 99 groups and up to 150 files per group.

If a disc includes more than the files above limit, the unit stops detecting files when the number of detected files reaches the limit and ignores the subsequent files. The unit also ignores any non-MP3/JPEG file in the disc.

- Add the appropriate extension, such as “mp3” or “jpeg” to the file name.

For making your own disc:

- Use “ISO 9660” as the disc format for CD-R/RW.
- The unit does not support “packet writing” (UDF format) for CD-R/RW.
- The unit supports discs recorded with up to five multiple sessions.
- Finalize the disc.

For MP3 files:

MP3i and MP3 Pro are not available.

For JPEG files:

- This unit supports the JPEG files whose resolution is 32 to 8192 pixel in width and 32 to 7680 pixel in height.
- We recommend to record a file at 640 x 480 resolution. (If a file has been recorded at a resolution of more than 640 x 480, it will take a longer time to be displayed.)

NOTES:

- Because of the disc characteristics or recording condition, some discs may not be played back or it takes time to start playback.
- The unit does not support “packet writing” discs.
- If there are any files which are stored on a disc directly and do not belong to any group, the unit recognized them as belonging to an independent group.
- The unit plays back groups/files on a disc in the alphabetical order. Therefore, playback order may be different from the order recorded on a disc.
- Be sure to set “FILE TYPE” correctly when playing back a disc which contains both MP3 and JPEG files. (☞ pg. 57)

Control display

The control display appears on the TV screen and playback starts when an MP3 or a JPEG disc is loaded.

Example: When an MP3 disc is loaded

Total group number on disc Current file number Total file number in current group

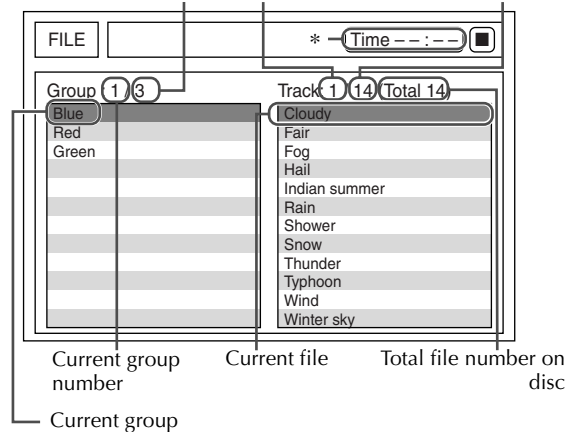

* For MP3 only

Elapsed playing time of current track

Elapsed playing time is only shown during playback.

Basic Playback

When you insert a disc with groups and files, the control display that shows the contents of the disc automatically appears on the TV screen. (☞ pg. 42)

You can specify and play back the desired group/file from the control display using the following procedure.

- Turn on the TV and select the VCR channel (or AV mode).
- Slide the **TV/VCR/DVD** switch on the remote control to the right.

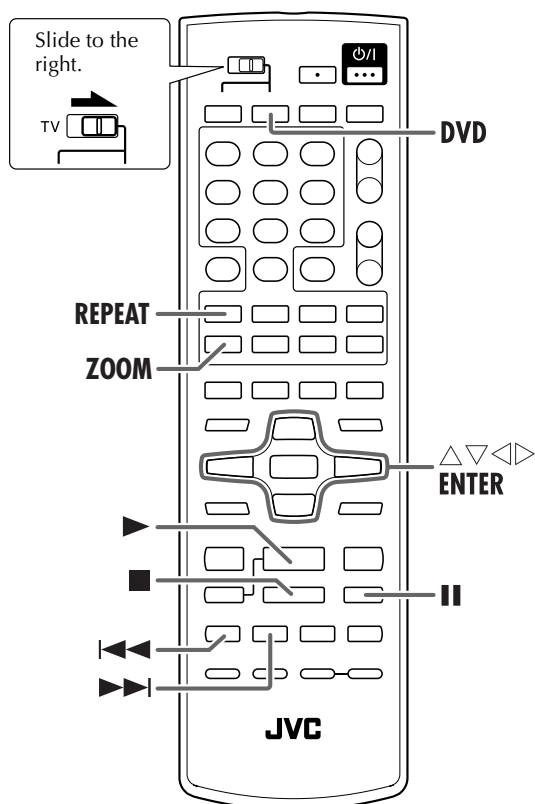
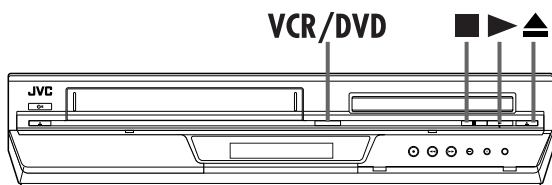

NOTES:

- ▶, ■, II, ◀◀ and ▶▶ buttons function the same as with Audio CD discs, however, ▶▶ and ◀◀ buttons do not function for MP3/JPEG files playback.
- Resume playback also does not function for MP3/JPEG files playback.

1 Load the disc.

- For details, refer to "Placing a Disc" (☞ pg. 5).

The control display appears on the TV screen. (☞ pg. 42)

2 Select the DVD deck.

On the unit

Press **VCR/DVD** repeatedly so that the DVD indicator lights up.

On the remote control

Press **DVD** so that the DVD indicator lights up.

3 Select the group.

Press Δ / ∇ to select the desired group, then press \triangleright .

4 Start playback.

Press Δ / ∇ to select the desired file, then press **ENTER** or \blacktriangleright .

- You can skip a file across a group. Press \blacktriangleright to skip to the first file of the next group when the last file of the current group is selected.

When playing back a JPEG disc, the slide-show playback starts from the selected file.

- After selecting a file, press \blacktriangleright to start slide-show playback from the selected file, or press **ENTER** to show the selected file.
- The playback interval time of slide-show depends on the file size.

5 Pause playback.

Press **II**.

- To resume normal playback, press \blacktriangleright .

6 Stop playback.

Press **■**.

- Press \blacktriangle on the DVD deck to open the disc tray, then remove the disc.

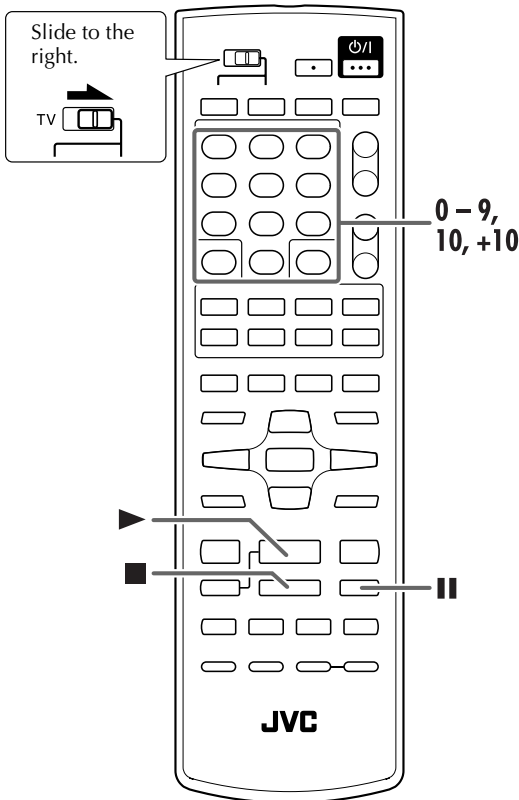

Group/File Selection

To start playback by specifying the group/file number

- 1 Press the **number keys** (0-10, +10) to enter the group number.
- 2 Press the **number keys** (0-10, +10) to enter the file number.

Example:

- To select 3: Press 3.
 To select 14: Press +10, then 4.
 To select 20: Press +10, then 10.
 Or press +10 twice, then 0.
 To select 24: Press +10, +10, then 4.
 To select 110: Press +10 ten times, then 10.
 To select 150: Press +10 fourteen times, then press 10 once.

For MP3 files playback

Playback starts from the file you have specified.

For JPEG files playback

- The slide-show playback starts from the file you have specified.
- To display only the selected file, then press **ENTER**. To start slide-show playback from that file, press **ENTER** again.

NOTE:

You cannot select 150 even if you press +10 fifteen times, then press 0 once.

Repeat Playback

You can repeat playback of the current group, file (only for MP3 files), or all groups.

- While the control display is on the TV screen:

1 Select the mode.

Press **REPEAT** to select the desired repeat mode.

- Each time you press **REPEAT**, the mode changes as follows:

For MP3 files playback

TRACK → GROUP → ALL → OFF (No indication) → (Back to the beginning)

TRACK:	The current file (track) is played back repeatedly.
GROUP:	All files of the current group are played back repeatedly.
ALL:	All files are played back repeatedly.
OFF (no indication):	Each file is played back once.

For JPEG files playback

GROUP → ALL → OFF (No indication) → (Back to the beginning)

GROUP:	All files of the current group are played back repeatedly.
ALL:	All files are played back repeatedly.
OFF (No indication):	Each file is played back once.

2 Start playback.

Press ▶.

To cancel Repeat Playback

Press **REPEAT** repeatedly until the repeat mode display disappears from the TV screen.

To return to the control display

Press ■.

Zooming a still picture

Press **ZOOM** while playing back a JPEG file.

- When you want to zoom the picture during slide-show playback, first press **II**, then press **ZOOM**.
- Each press of **ZOOM** changes the magnification in the following steps:
 ZOOM OFF → ZOOM 1 → ZOOM 2 → (Back to the beginning)
- To resume normal playback, press **ENTER**.

Edit From A Camcorder

You can use a camcorder as the source player and your unit as the recording deck.

Slide the **TV/VCR/DVD** switch on the remote control to the right.

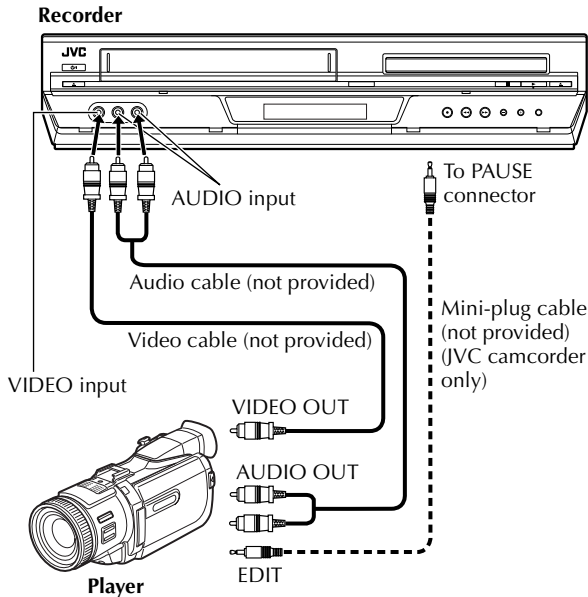

1 Make connections.

Connect the camcorder's AUDIO OUT and VIDEO OUT connectors to the unit's front panel AUDIO and VIDEO input connectors.

- When using a monaural camcorder, connect its AUDIO OUT connector to the AUDIO L input connector on your unit.
- When a Master Edit Control-equipped JVC camcorder is used, the camcorder is capable of controlling the unit. Refer to the camcorder's instruction manual for operating procedure.

2 Select the VHS deck.

On the unit

Press **VCR/DVD** repeatedly so that the VCR indicator lights up.

On the remote control

Press **VCR** so that the VCR indicator lights up.

3 Set the unit's input mode.

Press **AUX** (number key "0") and/or **PR** to select "F-1."

4 Set the edit mode.

See "PICTURE CONTROL" on page 54.

5 Engage the Record Pause mode.

Use **▶**, **◀◀**, or **▶▶** to locate the point where you start recording, then press and hold **||** and press **●** to engage the Record Pause mode.

6 Start the camcorder.

Engage the Play mode of the camcorder.

7 Start the unit.

Press **▶** to engage the Record mode of the unit.

NOTES:

- All necessary cables can be obtained from your dealer.
- When you select "EDIT" to dub tapes in step 4, be sure to select "AUTO" (or "NORM" when "B.E.S.T." is set to "OFF") after you finish dubbing the tapes.

Edit To Or From Another Video Recorder

You can use your unit as the source player or as the recording deck.

1 When using your unit as the source player:

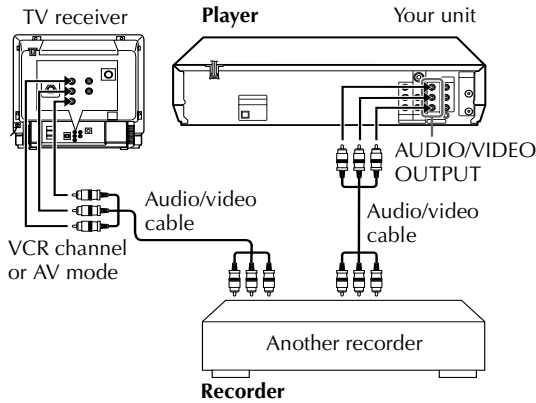

2 When using your unit as the recording deck:

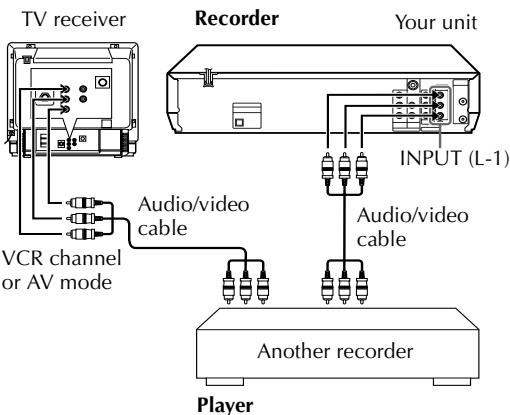
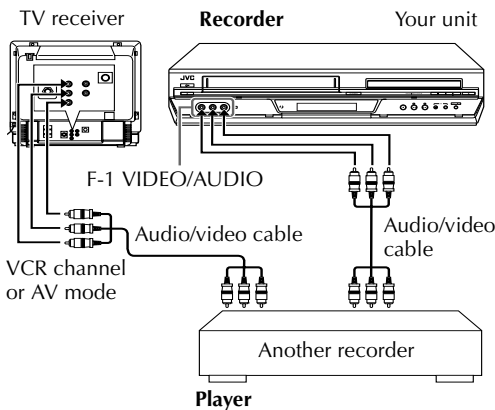

Slide the **TV/VCR/DVD** switch on the remote control to the right.

1 Make connections.

- 1 When using your unit as the source player:
 - connect its AUDIO/VIDEO OUTPUT connectors to the recording deck.
- 2 When using your unit as the recording deck:
 - connect its L-1 INPUT connector to the source player.

2 Select the VHS deck.

On the unit

Press **VCR/DVD** repeatedly so that the VCR indicator lights up.

On the remote control

Press **VCR** so that the VCR indicator lights up.

3 Set the input mode of recording deck.

With this unit, press **AUX** (number key "0") and/or **PR** to select correct external input on the recording deck.

On this unit (when using this unit as the recording deck); Select "L-1"— when connecting the other recorder to the AV input connectors on the rear panel.

Select "F-1"— when connecting the other recorder to the AV input connectors on the front panel.

- When using another recorder as the recording deck, refer to its instruction manual.

4 Set the edit mode.

See "PICTURE CONTROL" on page 54.

5 Engage the Record Pause mode of the recording deck.

Locate the point where you start recording, then engage the Record Pause mode.

6 Start the source player.

Engage the Play mode of the source player.

7 Start the recording deck.

Engage the Record mode of the recording deck.

NOTES:

- All necessary cables can be obtained from your dealer.
- When you select "EDIT" to dub tapes in step 4, be sure to select "AUTO" (or "NORM" when "B.E.S.T." is set to "OFF") after you finish dubbing the tapes.
- When you use this unit as the source player for editing, be sure to set "O.S.D." to "OFF" before starting. (ⓘ pg. 54)

Dubbing

(from DVD to VHS)

You can dub selected scenes from the DVD disc to a cassette, starting and stopping wherever you wish.

However, it is not possible to dub copy-protected discs. In such case, "Err" appears on the front display panel.

- Turn on the TV and select the video channel (or AV mode).
- Slide the TV/VCR/DVD switch on the remote control to the right.

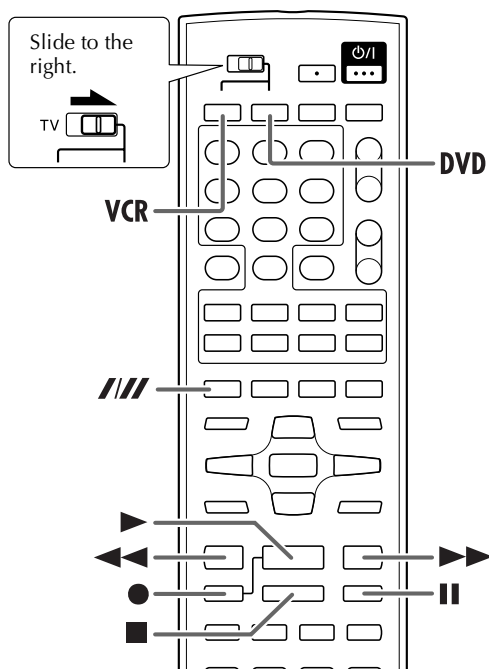

1 Load a cassette and place a disc.

For the VHS deck

Insert a cassette with the record safety tab intact.

For the DVD deck

For details, refer to "Placing a Disc" (pg. 5).

2 Prepare the VHS deck for dubbing.

- 1 Press **VCR**.
- 2 Press **///** to select recording speed.
- 3 Search for the point where you want to start dubbing by pressing **▶**, **▶▶** or **◀◀** then press **■**.

3 Prepare the DVD deck for dubbing.

- 1 Press **DVD**.
- 2 Start playback and search for the point where you want to start dubbing by pressing **▶**, **▶▶** or **◀◀**.

4 Start dubbing.

A little before the dubbing start point, press and hold **●**, then press **▶** on the remote control.

- "dub" lights on the front display panel.



5 End dubbing.

Press **■**.

- Be sure to press **■** while the VCR indicator lights up on the unit.
- If you press **■** or **▲** with the DVD deck selected, the dubbing stopped, but the opening screen is also recorded.
- When you have finished dubbing, press **DVD** to select the DVD deck and press **■** to stop playback.

NOTES:

- Set "ON SCREEN GUIDE" to "OFF" (pg. 58) if you do not want to record the on-screen display for DVD discs during dubbing.
- There may be a discrepancy of several seconds between where you intend editing to start, and where it actually starts.
- The superimposed indication during the operation or dubbing is not recorded.
- Set "PICTURE CONTROL" to "EDIT". (pg. 54)
- When you select a setting as "MONITOR TYPE" other than "MULTI" options (pg. 15), it may not be possible to dub a DVD disc in a cassette correctly.

Digital Audio Dubbing

- Turn on the TV and select the video channel (or AV mode).
- Slide the **TV/VCR/DVD** switch on the remote control to the right.

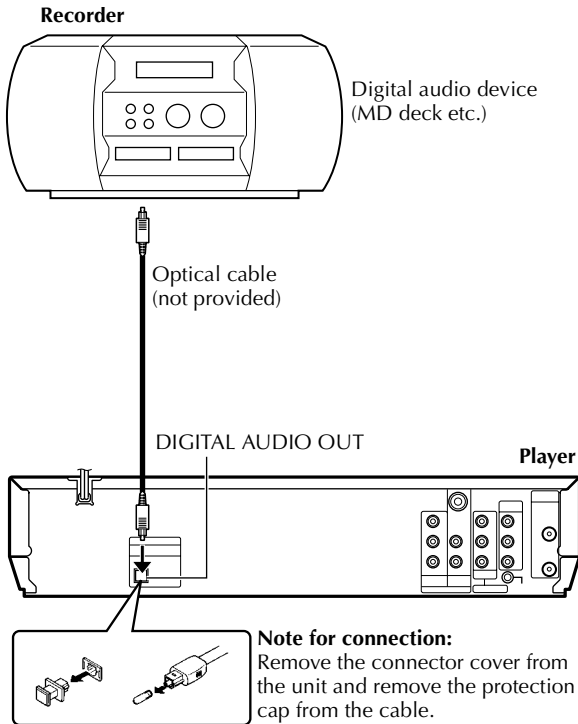

You can dub selected audio from the DVD or Audio CD disc to an MD etc.

However, it is not possible to dub copy-protected discs.

Example: Dubbing to an MD

1 Make connections.

Connect the optical cable between the unit and the digital audio device.

2 Place a disc and load an MD.

For the DVD deck

- 1 Press **▲** on the DVD deck to open the disc tray.
- 2 Place the disc in the disc tray.
- 3 Press **▲** on the DVD deck to close the disc tray.

For the digital audio device

Insert an MD.

3 Prepare the DVD deck for dubbing.

- 1 Press **DVD** and select the audio to be dubbed.
- 2 Search for the point where you want to start dubbing by pressing **▶**, **▶▶** or **◀◀** then press **■**.
- 3 Press **◀◀** a little, then press **▶** to start playback.
- 4 Press **||** to pause playback a little before the start point.

4 Prepare the audio device for dubbing.

Select the input mode.

5 Start dubbing.

- 1 Press **▶** (or press **●** on the unit) to start playback on the DVD deck.
- 2 Start recording on the audio device.

6 End dubbing.

Stop recording on the audio device. Then press **■** to stop playback on the DVD deck.

NOTES:

- There may be a discrepancy of several seconds between where you intend editing to start, and where it actually starts.
- You can also dub audio from a Video CD or SVCD. Set "DIGITAL AUDIO OUTPUT" to "PCM ONLY". (pg. 57)

Remote Control Functions

Remote A/B/C/D Code Switching

The remote control is capable of controlling four JVC video units independently. Each of the units can respond to one of four codes (A, B, C or D). The remote control is preset to send A code signals because your unit is initially set to respond to A code signals. You can easily modify your unit to respond to B, C or D code signals.

Before performing the following steps:

Slide the TV/VCR/DVD switch on the remote control to the right.

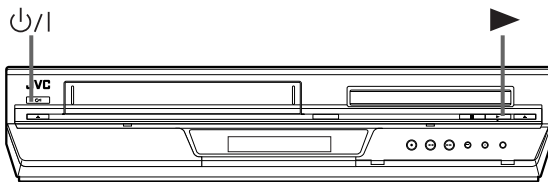
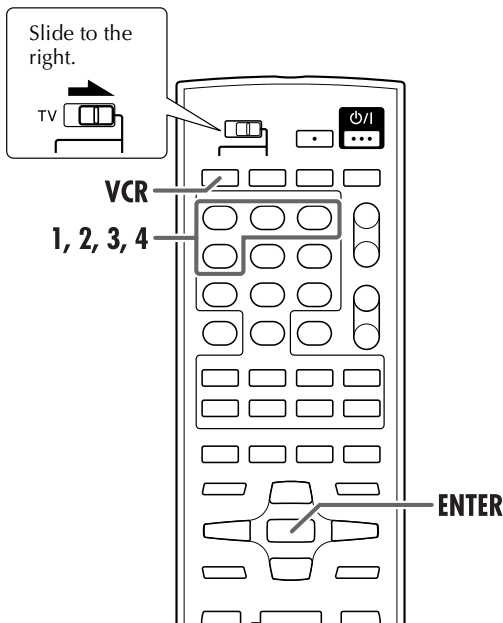

On the remote control

Keep pressing **VCR** down during steps **1** – **2**.

1 Change the remote control code.

Press the number key “1” for A, “2” for B, “3” for C or “4” for D.

2 Set the remote control code.

Press **ENTER** to set the code.

On the unit

3 Turn off the unit.

Press **⏻/I**.

4 Display the code.

Press **▶** on the unit for over 5 seconds while the unit is turned off. The code currently set appears on the front display panel.

- If the code displayed on the front display panel is different from the code set on the remote control, go to step **5**.

5 Change the unit’s code.

Press **■** on the remote control. The code currently set on the remote control will be applied to the unit.

Operating a JVC TV

Your remote control can operate the basic functions of your JVC TV set.

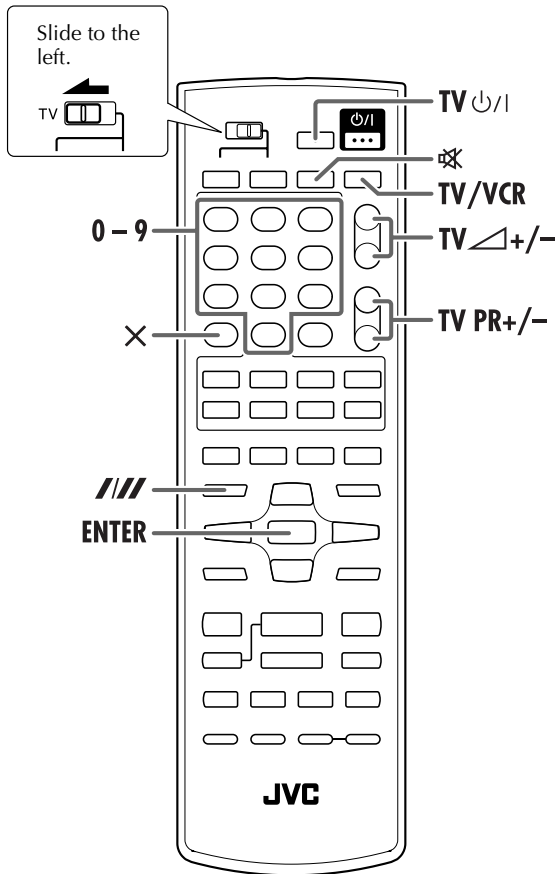

IMPORTANT

Although the provided remote control unit is compatible with JVC televisions, it may not work with your JVC TV, or in some instances, may have limited function capability.

1 Slide the TV/VCR/DVD switch on the remote control to the left.

2 Operate the TV.

Press the corresponding button: **TV ϕ /I**, **TV/VCR**, **TV \triangle +/-** (Volume), **TV PR +/-**, **\times** (TV Muting), **number keys**.

- For some JVC TVs, you must press **ENTER** after having pressed the **number keys**.

Control Your JVC TV Using Additional Buttons

Use the **number keys**, and the **///** button or **\times** button to select the TV's channel.

- The **///** button corresponds to the 1-digit/2-digit entry switching button (often labelled -/-) of your TV's remote control.
- With some JVC TVs, the **\times** button corresponds to the 10 + button of your TV's remote control.

NOTE:

The way these buttons are used is determined by your TV. Use these buttons as instructed for your TV's remote control.

Connecting To A Satellite Receiver

Connect the satellite receiver to the AUDIO/VIDEO IN connectors, then connect the AUDIO/VIDEO OUT or S VIDEO OUT connectors to the TV's connectors.

NOTES:

- You cannot use Automatic Satellite Programme Recording function if you connect the satellite receiver with S-video cable. (☞ pg. 12)
- To record a programme via the satellite receiver, select L-1 or S-1 mode by pressing **AUX (number key "0")** and/or **PR** so that "L-1" or "S-1" appears on the front display panel.
- For details, refer to the instruction manual of the satellite receiver.

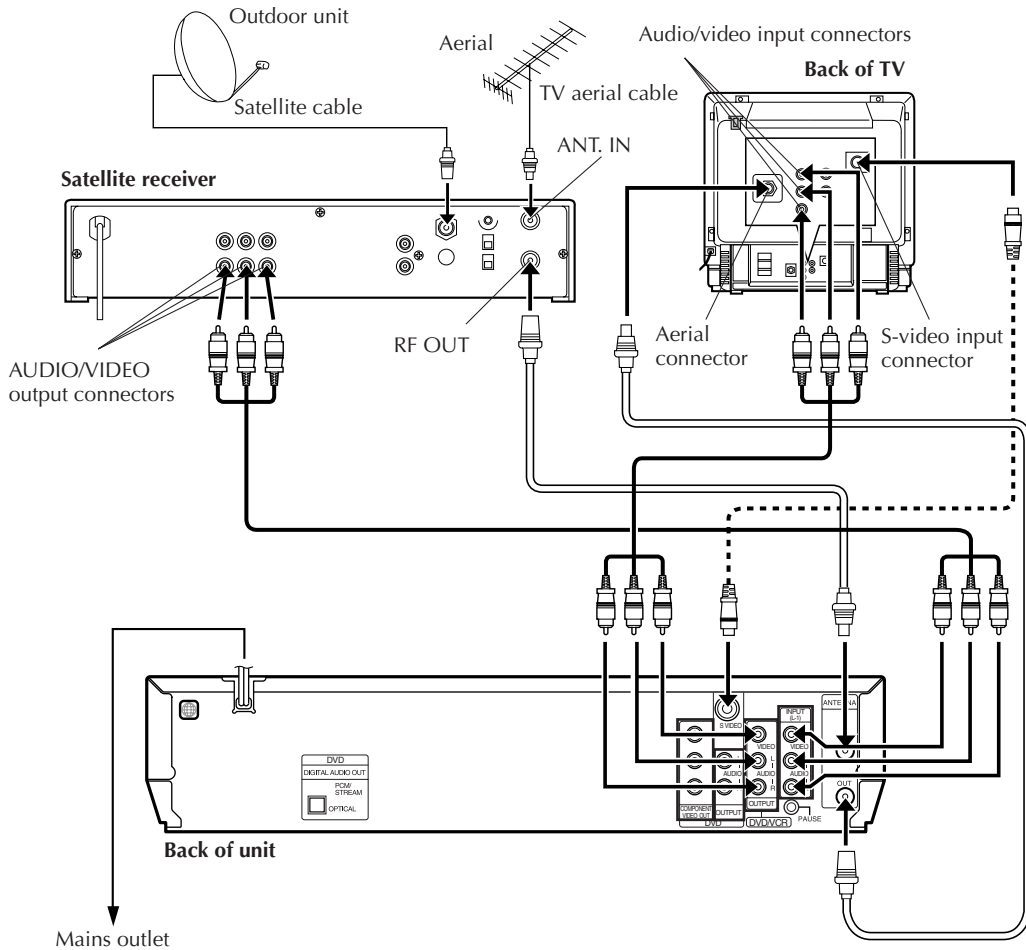

Connecting To A Dolby Digital Decoder or An Amplifier With A Built-in DTS (DVD deck)

These instructions enable you to connect your unit to a Dolby Digital Decoder or an amplifier with built-in DTS.

Make connections.

Connect the optical cable between the unit and the Dolby Digital Decoder or amplifier with a built-in DTS.

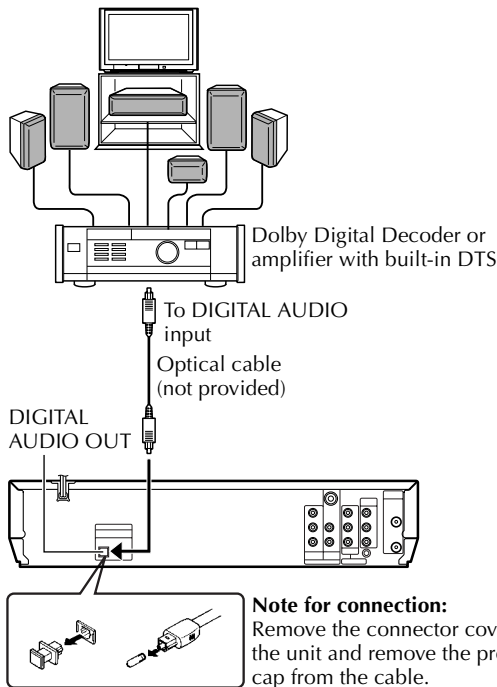

NOTES:

- For Dolby Digital sound, set "DIGITAL AUDIO OUTPUT" to "DOLBY DIGITAL/PCM". (☞ pg. 57)
- For DTS sound, set "DIGITAL AUDIO OUTPUT" to "STREAM/PCM". (☞ pg. 57)

CAUTIONS:

- This unit has a dynamic range of more than 80 dB with regards to its Hi-Fi audio capability. It is recommended that you check the maximum level if you are going to listen to the Hi-Fi audio signals through a stereo amplifier. A sudden surge in the input level to the speakers may damage them.
- Some speakers and televisions are specially shielded to prevent television interference. If both are of the non-shielded type, do not place the speakers adjacent to the TV set as this can adversely affect the video playback picture.

Function Set (VHS deck)

You can change various mode settings on the Function Set screen by following the procedure described below.

- For each mode setting, see pages 54 to 55.

- Turn on the TV and select the video channel (or AV mode).
- Slide the TV/VCR/DVD switch on the remote control to the right.

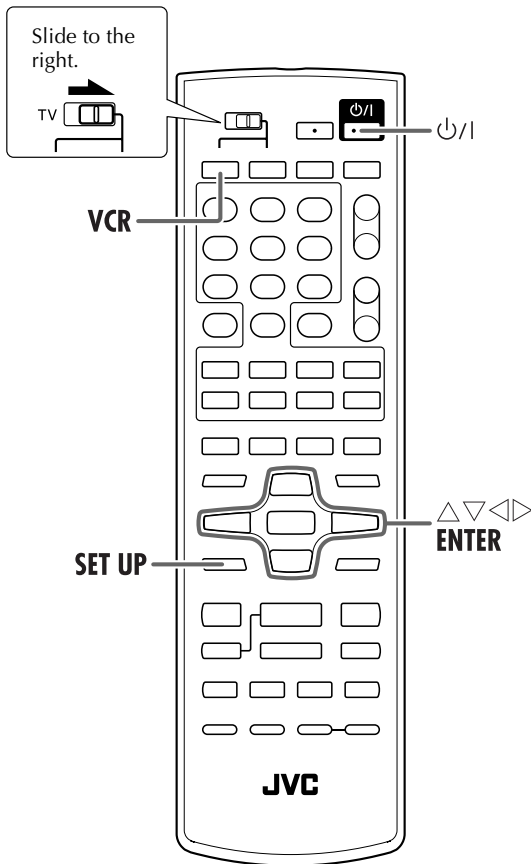

1 Turn on the unit.

Press $\odot/1$.

2 Select the VHS deck.

On the unit

Press **VCR/DVD** repeatedly so that the VCR indicator lights up.

On the remote control

Press **VCR** so that the VCR indicator lights up.

3 Access the Main Menu screen.

Press **SET UP**.

4 Access the Mode Set screen.

Press \triangle/∇ to move the highlight bar (pointer) to "FUNCTION SET," then press **ENTER** or \triangleright .

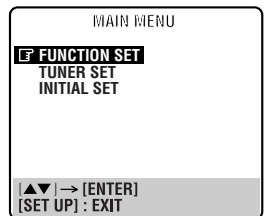

5 Select the mode.

Press \triangle/∇ to move the highlight bar (pointer) to the item you want to change.

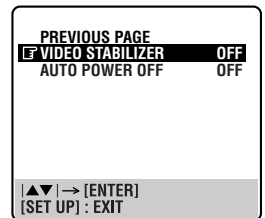
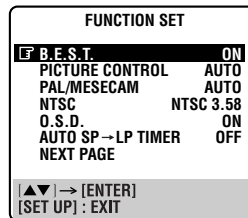

6 Select the mode setting.

Press **ENTER** or \triangleright .

7 Return to the normal screen.

Press **SET UP**.

* The default setting is **bold** in the table below.

■ B.E.S.T. — ON / OFF

You can set the B.E.S.T. (Biconditional Equalised Signal Tracking) system to "ON" or "OFF." (☞ pg. 25)

NOTES:

- When watching a tape recorded with "B.E.S.T." set to "ON," it is recommended that you leave B.E.S.T. on during playback as well.
- When watching a rental tape or one recorded on another video recorder, or when using this unit as the player for editing, set B.E.S.T. to your preference.
- The B.E.S.T. system works for both SP and LP modes only after a tape has been inserted and the Record mode is first initiated. It does not work during recording.
- The B.E.S.T. system does not work while Automatic Satellite Programme Recording is in progress. (☞ pg. 32)
- In the case of timer recordings, the B.E.S.T. system works before recording is initiated.
- Once the cassette is ejected, the B.E.S.T. data is cancelled. The next time the cassette is used for recording, B.E.S.T. is re-performed.
- Pressing the unit's ● button while "bEst" is displayed does not start Instant Timer Recording. (☞ pg. 24)

■ PICTURE CONTROL— AUTO (NORM) / EDIT / SOFT

This feature helps you to adjust the playback picture quality according to your preference. Normally select "AUTO."

AUTO (NORM): Normally select this. Picture quality is adjusted automatically. When "B.E.S.T." is "OFF," "NORM" will appear instead of "AUTO."

EDIT: Minimizes picture degradation during editing (recording and playback).

SOFT: Reduces image coarseness when viewing overplayed tapes containing a lot of noise.

NOTES:

- When you select "EDIT" or "SOFT," the selected mode will not change until you select another mode.
- When you select "EDIT" to dub tapes, be sure to select "AUTO" after you finish dubbing the tapes.
- When "B.E.S.T." is "OFF," "PICTURE CONTROL" switches automatically from "AUTO" to "NORM."

■ PAL/MESECAM — AUTO / PAL / MESECAM

Select the appropriate colour system for recording or playback.

AUTO: Usually set to this mode. The appropriate colour system (PAL or MESECAM) will be selected depending on the playback or recording signals.

If the "AUTO" mode does not work properly, select either of the following manual modes.

PAL: To record PAL signals, or playback a PAL tape.

MESECAM: To record SECAM signals, or playback a SECAM or MESECAM tape.

NOTES:

- *SECAM signals will always be recorded as MESECAM. Select "AUTO" or "MESECAM" when recording SECAM signals.*
- *When playing back a SECAM tape, select "AUTO" or "MESECAM." The playback picture will always be monochrome.*

■ NTSC — NTSC3.58 / NTSC4.43 / NTSC→PAL

To record NTSC signals or playback a NTSC tape, it will be necessary to select the appropriate mode.

NTSC3.58: To record NTSC signals or playback a NTSC tape.

NTSC4.43: To record NTSC4.43 signals or playback a NTSC4.43 tape.

NTSC→PAL: To playback a NTSC tape on PAL TV.

NOTES:

- *The "NTSC→PAL" mode does not work during recording. In this mode, NTSC signals will be recorded as NTSC3.58.*
- *The Menu screen is distorted during playing back a NTSC tape on PAL TV. Stop playback and access the Menu screen again.*
- *In the "NTSC4.43" mode, with some TVs, on-screen displays (Program screen, etc.) may roll up or down and there may be a loss of colour. When this happens, select the "NTSC3.58" mode.*

■ O.S.D. — ON / OFF

When this function is set to "ON," various operational indicators appear on the TV screen. Messages appear in the selected language. (☞ pg. 14, 16)

NOTES:

- When you use this unit as the source player for editing, be sure to set "O.S.D." to "OFF" before starting.
- During playback, the operation mode indicators may be disturbed depending on the type of tape being used.

■ AUTO SP→LP TIMER — ON / OFF

When this function is set to "ON," the unit automatically switches to LP mode to allow complete recording if there is not enough tape to record the entire programme while timer-recording in SP mode.

For Example:

Recording a programme of 210 minutes in length onto a 180-minute tape

Approximately 150 minutes	Approximately 60 minutes
SP mode	LP mode
Total 210 minutes	

Make sure you set this function to "ON," before the timer-recording starts.

NOTES:

- If you have programmed the unit to timer-record 2 or more programmes, the second programme and those thereafter may not fit on the tape if you set "AUTO SP→LP TIMER" to "ON." In this case, make sure the mode is not engaged, then set the tape speed manually during timer programming.
- In order to ensure that the recording fits on the tape, this feature may leave a slight non-recorded section at the end of the tape.
- There may be some noise and sound disturbance at the point on the tape where the unit switches from SP to LP mode.
- The Auto SP→LP Timer feature is not available during ITR (Instant Timer Recording), and the feature will not work properly with any tapes longer than E-180, or with some tapes of shorter lengths.

■ VIDEO STABILIZER — ON / OFF

When this function is set to "ON," you can automatically correct vertical vibration in the picture when playing back unstable recordings made on another recorder.

NOTES:

- When you finish viewing a tape, be sure to set this function to "OFF."
- Regardless of the setting, this function has no effect during recording and during special effects playback.
- The on-screen display may jitter vertically when this function is set to "ON."
- To watch recordings with close-caption, set this function to "OFF."

■ AUTO POWER OFF — 3H / OFF

When this function is set to "3H," the unit is turned off automatically if no operation is done within 3 hours. "AUTO POWER OFF IN 3 MIN" appears on the screen 3 minutes before the unit is turned off.

Mode Set (DVD deck)

You can change various mode settings on the Mode Set screen by following the procedure described below.

- For each mode setting, see corresponding pages.

LANGUAGE	MENU LANGUAGE (pg. 17) AUDIO LANGUAGE (pg. 17) SUBTITLE (pg. 17) ON SCREEN LANGUAGE (pg. 17)
PICTURE	MONITOR TYPE (pg. 15) PICTURE SOURCE (pg. 57) SCREEN SAVER (pg. 57) FILE TYPE (pg. 57)
AUDIO	DIGITAL AUDIO OUTPUT (pg. 57) DOWN MIX (pg. 57) D. RANGE COMPRESSION (pg. 57)
OTHERS	RESUME (pg. 58) ON SCREEN GUIDE (pg. 58) PARENTAL LOCK (pg. 58)

- Turn on the TV and select the video channel (or AV mode).
- Slide the **TV/VCR/DVD** switch on the remote control to the right.

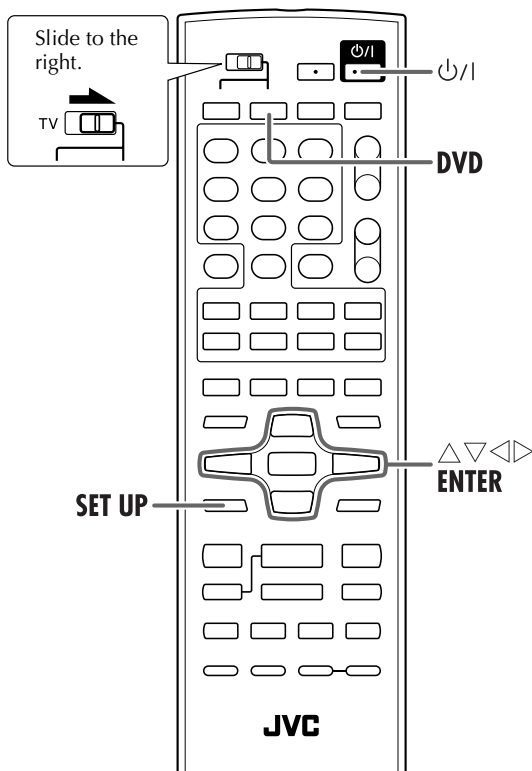

- The procedure shows how to set "RESUME" to "ON" on the DVD Set Up menu screen as an example.

1 Turn on the unit.

Press ϕ/I .

2 Select the DVD deck.

On the unit

Press **VCR/DVD** repeatedly so that the DVD indicator lights up.

On the remote control

Press **DVD** so that the DVD indicator lights up.

3 Access the DVD Set Up menu screen.

- 1 Press **SET UP**.
- 2 Press $\triangleleft \triangleright$ to select "OTHERS."

- Each time you press the button, the setup menu change as follows;

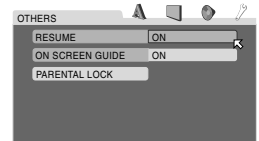

LANGUAGE → **PICTURE** → **AUDIO** → **OTHERS**
→ (Back to the beginning)

4 Select the mode.

Press $\triangle \nabla$ to move \boxtimes to "RESUME," then press **ENTER**.

5 Select the mode setting.

Press $\triangle \nabla$ to select "ON," then press **ENTER**.

6 Return to the normal screen.

Press **SET UP**.

* The default setting is **bold** in the table below.

Picture Settings

■ MONITOR TYPE —

16:9 / **4:3 LB** / 4:3 PS / 16:9 MULTI /
4:3 MULTI LB / 4:3 MULTI PS

You can select the monitor type depending on the TV used when you play back DVD VIDEO discs recorded for wide-screen TVs. For more details, refer to "Monitor Set (DVD deck)" (pg. 15).

■ PICTURE SOURCE —

AUTO / FILM / VIDEO

You can obtain optimal picture quality by selecting whether the content on the disc is processed by field (video source) or by frame (film source).

Normally set to "AUTO."

AUTO: Used to play back a disc containing both video and film source materials. This unit recognizes the picture type (film or video source) of the current disc according to the disc information.

FILM: Suitable for playing back a film or progressive source disc.

VIDEO: Suitable for playing back a video source disc with relatively a few movements.

- If the playback picture is unclear or noisy, or the oblique lines of the picture are rough, try to change to other modes.

■ SCREEN SAVER — ON / OFF

The TV screen may be burned out if a static picture is displayed for a long time. When this function is set to "ON," the unit automatically activates the screen saver function if a static picture, such as an on-screen display or menu is displayed for over 5 minutes.

NOTE:

This function is not available for Audio CDs and MP3 discs.

■ FILE TYPE — AUDIO / STILL PICTURE

You can select files to play back, when both MP3 files and JPEG files are recorded on a disc.

AUDIO: Select this to play back MP3 files.

STILL PICTURE: Select this to play back JPEG files.

NOTE:

You cannot access the DVD Set Up screen and "⊙" appears on the TV screen if a disc is already placed.

Audio Settings

■ DIGITAL AUDIO OUTPUT —

PCM ONLY / DOLBY DIGITAL/PCM / **STREAM/PCM**

Set to the appropriate mode according to the type of the device connected to DIGITAL AUDIO OUT connector on the rear of unit.

Set this item correctly according to the logo on the device.

It is not necessary to set this mode when you connect no device to the DIGITAL AUDIO OUT connector.

PCM ONLY: Select this when connecting to a device bearing neither Dolby Digital nor DTS logo, or a digital recorder.

DOLBY DIGITAL/PCM: Select this when connecting an amplifier or a decoder bearing Dolby Digital (without DTS) logo.

STREAM/PCM: Select this when connecting an amplifier or a decoder bearing both Dolby Digital and DTS logos.

■ DOWN MIX — DOLBY SURROUND / STEREO

Set to the appropriate mode according to your audio system when you play back a DVD VIDEO disc recorded with surround multichannel audio. This setting affects only the analogue audio output signal from the AUDIO OUT connectors when playing back a DVD VIDEO disc recorded with surround multichannel audio.

DOLBY SURROUND: Select this when you enjoy multichannel surround audio by connecting the unit's analogue AUDIO OUTPUT connectors (DVD) to a surround decoder or an internal amplifier.

STEREO: Select this when you enjoy conventional 2-channel stereo audio by connecting the unit's analogue AUDIO OUTPUT connectors (DVD) to a stereo amplifier/receiver or TV, or when you dub audio of a DVD VIDEO disc recorded with surround audio to your MD, cassette, etc.

■ D. RANGE COMPRESSION —

AUTO / ON

You can compress the dynamic range (the difference between the loudest and quietest audio signals) of the sound when listening to the sound at a low volume or at night.

This function is available with DVD VIDEO discs recorded with the Dolby Digital format. Set to the appropriate mode according to the number of channels recorded.

AUTO: Audio is played back with channels other than Dolby Digital channel 1 or 2 compressed.

ON: Audio is played back with all channel compressed.

Playback discs	Output		
	STREAM/PCM	DOLBY DIGITAL/PCM	PCM ONLY
DVD VIDEO with 48 kHz, 16/20/24 bit linear PCM	48 kHz, 16 bit linear PCM		
DVD VIDEO with DTS	DTS bitstream	44.1 kHz, 16 bit stereo linear PCM	
DVD VIDEO with Dolby Digital	Dolby Digital bitstream		48 kHz, 16 bit stereo linear PCM
Audio CD/Video CD	44.1 kHz, 16 bit stereo linear PCM		
Audio CD with DTS	DTS bitstream	44.1 kHz, 16 bit stereo linear PCM	
MP3 disc	Linear PCM		

NOTES:

- The unit is not equipped with the DTS decoding function.
- When you play back a DVD VIDEO or Audio CD disc with DTS, use a DTS decoder to get correct signals from your speakers. Never use the unit's analog output connectors, which output incorrect signals that may damage your speakers.
- If you connect the analog outputs and digital outputs simultaneously, be sure to select the source of the amplifier correctly, or set the level control of the amplifier connected to the analog outputs to minimum.

Others Settings**RESUME — ON / OFF**

When this function is set to "ON," you can use the resume function. (☞ pg. 33)

ON: The unit resumes playback from the position where playback has been stopped

OFF: You cannot use the resume function.

NOTE:

This function is not available for Audio CDs and MP3 discs.

ON SCREEN GUIDE — ON / OFF

When this function is set to "ON," the unit can display "on-screen guide" icons or characters which show the conditions of the unit or disc.

PARENTAL LOCK

Select this, then press **ENTER** to show the PARENTAL LOCK menu screen for limiting playback by children.

Parental Lock

This function restricts playback of DVD VIDEO discs which contains violent (and other) scenes according to the level set by the user. Scenes which are limited by this function are not played or replaced with other scenes.

COUNTRY CODE

Select the code of your country/area. (☞ pg. 59)

SET LEVEL

Select the level of restriction. ("1" is the strictest.)

PASSWORD

Enter your password by pressing the **number keys** (0-9).

EXIT

Select this, then press **ENTER** to go back to the OTHERS menu screen.

NOTES:

- Some DVD VIDEO discs cannot be played by this function. If you try to play such a disc, the PARENTAL LOCK menu screen appears on the TV screen and asks whether you want to release the lock or not.
To release the lock and play, select "TEMPORARY RELEASE," press **ENTER**, then enter your password. Otherwise, eject the disc.
- To change the setting of the limitation, you need to enter your password.
- If you forget your pass word, enter "8888."

Country/Area Code List for Parental Lock

AD	Andorra	ES	Spain	LC	Saint Lucia	SA	Saudi Arabia
AE	United Arab Emirates	ET	Ethiopia	LI	Liechtenstein	SB	Solomon Islands
AF	Afghanistan	FI	Finland	LK	Sri Lanka	SC	Seychelles
AG	Antigua and Barbuda	FJ	Fiji	LR	Liberia	SD	Sudan
AI	Anguilla	FK	Falkland Islands (Malvinas)	LS	Lesotho	SE	Sweden
AL	Albania	FM	Micronesia (Federated States of)	LT	Lithuania	SG	Singapore
AM	Armenia	FO	Faroe Islands	LU	Luxembourg	SH	Saint Helena
AN	Netherlands Antilles	FR	France	LV	Latvia	SI	Slovenia
AO	Angola	FX	France, Metropolitan	LY	Libyan Arab Jamahiriya	SJ	Svalbard and Jan Mayen
AQ	Antarctica	GA	Gabon	MA	Morocco	SK	Slovakia
AR	Argentina	GB	United Kingdom	MC	Monaco	SL	Sierra Leone
AS	American Samoa	GD	Grenada	MD	Moldova, Republic of	SM	San Marino
AT	Austria	GE	Georgia	MG	Madagascar	SN	Senegal
AU	Australia	GF	French Guiana	MH	Marshall Islands	SO	Somalia
AW	Aruba	GH	Ghana	ML	Mali	SR	Suriname
AZ	Azerbaijan	GI	Gibraltar	MM	Myanmar	ST	Sao Tome and Principe
BA	Bosnia and Herzegovina	GL	Greenland	MN	Mongolia	SV	El Salvador
BB	Barbados	GM	Gambia	MO	Macau	SY	Syrian Arab Republic
BD	Bangladesh	GN	Guinea	MP	Northern Mariana Islands	SZ	Swaziland
BE	Belgium	GP	Guadeloupe	MQ	Martinique	TC	Turks and Caicos Islands
BF	Burkina Faso	GQ	Equatorial Guinea	MR	Mauritania	TD	Chad
BG	Bulgaria	GR	Greece	MS	Montserrat	TF	French Southern Territories
BH	Bahrain	GS	South Georgia and the South Sandwich Islands	MT	Malta	TG	Togo
BI	Burundi	GT	Guatemala	MU	Mauritius	TH	Thailand
BJ	Benin	GU	Guam	MV	Maldives	TJ	Tajikistan
BM	Bermuda	GW	Guinea-Bissau	MW	Malawi	TK	Tokelau
BN	Brunei Darussalam	GY	Guyana	MX	Mexico	TM	Turkmenistan
BO	Bolivia	HK	Hong Kong	MY	Malaysia	TN	Tunisia
BR	Brazil	HM	Heard Island and McDonald Islands	MZ	Mozambique	TO	Tonga
BS	Bahamas	HN	Honduras	NA	Namibia	TP	East Timor
BT	Bhutan	HR	Croatia	NC	New Caledonia	TR	Turkey
BV	Bouvet Island	HT	Haiti	NE	Niger	TT	Trinidad and Tobago
BW	Botswana	HU	Hungary	NF	Norfolk Island	TV	Tuvalu
BY	Belarus	ID	Indonesia	NG	Nigeria	TW	Taiwan
BZ	Belize	IE	Ireland	NI	Nicaragua	TZ	Tanzania, United Republic of
CA	Canada	IL	Israel	NL	Netherlands	UA	Ukraine
CC	Cocos (Keeling) Islands	IN	India	NO	Norway	UG	Uganda
CC	Cocos (Keeling) Islands	IO	British Indian Ocean Territory	NP	Nepal	UM	United States Minor Outlying Islands
CF	Central African Republic	IQ	Iraq	NR	Nauru	US	United States
CG	Congo	IR	Iran (Islamic Republic of)	NU	Niue	UY	Uruguay
CH	Switzerland	IS	Iceland	NZ	New Zealand	UZ	Uzbekistan
CI	Côte d'Ivoire	IT	Italy	OM	Oman	VA	Vatican City State (Holy See)
CK	Cook Islands	JM	Jamaica	PA	Panama	VC	Saint Vincent and the Grenadines
CL	Chile	JO	Jordan	PE	Peru	VE	Venezuela
CM	Cameroon	JP	Japan	PF	French Polynesia	VG	Virgin Islands (British)
CN	China	KE	Kenya	PG	Papua New Guinea	VI	Virgin Islands (U.S.)
CO	Colombia	KG	Kyrgyzstan	PH	Philippines	VN	Viet Nam
CR	Costa Rica	KH	Cambodia	PK	Pakistan	VU	Vanuatu
CU	Cuba	KI	Kiribati	PL	Poland	WF	Wallis and Futuna Islands
CV	Cape Verde	KM	Comoros	PM	Saint Pierre and Miquelon	WS	Samoa
CX	Christmas Island	KN	Saint Kitts and Nevis	PN	Pitcairn	YE	Yemen
CY	Cyprus	KP	Korea, Democratic People's Republic of	PR	Puerto Rico	YT	Mayotte
CZ	Czech Republic	KR	Korea, Republic of	PT	Portugal	YU	Yugoslavia
DE	Germany	KW	Kuwait	PW	Palau	ZA	South Africa
DJ	Djibouti	KY	Cayman Islands	PY	Paraguay	ZM	Zambia
DK	Denmark	KZ	Kazakhstan	QA	Qatar	ZR	Zaire
DM	Dominica	LA	Lao People's Democratic Republic	RE	Réunion	ZW	Zimbabwe
DO	Dominican Republic	LB	Lebanon	RO	Romania		
DZ	Algeria			RU	Russian Federation		
EC	Ecuador			RW	Rwanda		
EE	Estonia						
EG	Egypt						
EH	Western Sahara						
ER	Eritrea						

Tuner Set

IMPORTANT

Perform the following steps only if —
 — Auto Channel Set has not been set correctly by Auto Set Up (pg. 14)
 — you have moved to a different area or if a new station starts broadcasting in your area.

Your unit needs to memorize all necessary stations in channel positions in order to record TV programmes. Auto Channel Set automatically assigns all receivable stations in your area to call them up by using the **PR** buttons without going through any vacant channels.

- Turn on the TV and select the video channel (or AV mode).
- Slide the **TV/VCR/DVD** switch on the remote control to the right.

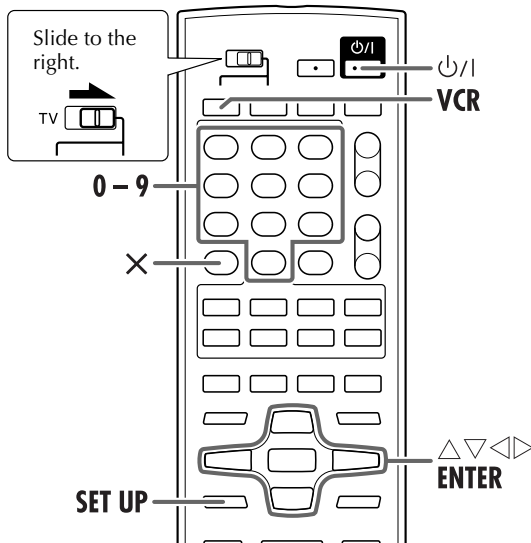

Auto Channel Set

1 Turn on the unit.

Press **⏻/I**.

2 Select the VCR deck.

On the unit

Press **VCR/DVD** repeatedly so that the VCR indicator lights up.

On the remote control

Press **VCR** so that the VCR indicator lights up.

3 Access the Main Menu screen.

Press **SET UP**.

4 Access the Auto Channel Set screen.

- 1 Press **△▽** to move the highlight bar (pointer) to "TUNER SET," then press **ENTER** or **▷**.
- 2 Press **△▽** to move the highlight bar (pointer) to "AUTO CH SET," then press **ENTER** or **▷**.

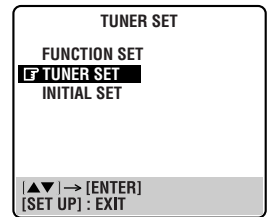

5 Select the TV system.

- 3 Press **△▽** to move the highlight bar (pointer) to the appropriate TV system (refer to the table below), then press **ENTER** or **▷**.

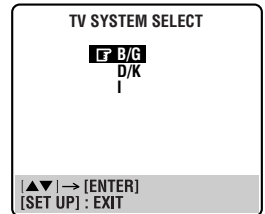

Major Countries/Areas	TV System
Australia, New Zealand, Kuwait, U.A.E., Indonesia, Singapore, Thailand, Malaysia, Iran, Saudi Arabia, Egypt, Morocco, Lebanon, Iraq	B/G
China, Mongolia, Russia	D/K
Hong Kong	I

- Auto Channel Set will start.

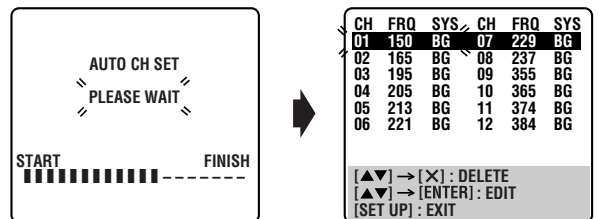

6 Return to the normal screen.

Press **SET UP**.

- Using the Confirmation screen, you can delete channels, swap channel positions and fine-tune channels already stored. Refer to page 62 for the procedures.

IMPORTANT

- If no sound accompanies the picture or the audio sounds unnatural on some channels that have been stored by Auto Channel Set, the TV system setting for those channels maybe incorrect. Select the appropriate TV system for those channels. Refer to "TV System Selection – When you see the picture but the audio can't be heard or sounds unnatural" (pg. 63).
- Since your recorder memorises all detected stations even if the reception condition is poor, some of those stored stations may produce a noisy picture. To delete those stations, refer to "Delete A Channel" (pg. 62).

Manual Channel Set

Store channels that were not stored during Auto Set Up (ⓘ pg. 14) or Auto Channel Set (ⓘ pg. 60).

1 Access the Main Menu screen.

Press **SET UP**.

2 Access the Tuner Set screen.

Press $\triangle\triangledown$ to move the highlight bar (pointer) to "TUNER SET," then press **ENTER** or \triangleright .

3 Access the channel list.

Press $\triangle\triangledown$ to move the highlight bar (pointer) to "CH EDIT," then press **ENTER** or \triangleright .

4 Select the channel position.

Press $\triangle\triangledown$ to move the highlight bar (pointer) to an open channel position, then press **ENTER** or \triangleright .

5 Select the band.

Press $\triangle\triangledown$ to move the highlight bar (pointer) to the desired band, then press **ENTER** to initiate Manual Channel Set.

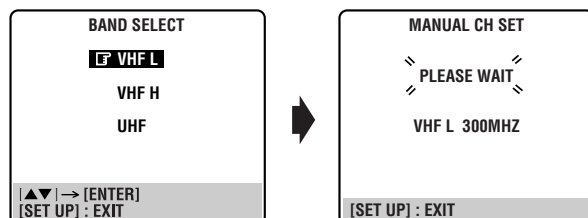

6 Set the station.

The screen to the right appears when the station is detected.

If you do not want to store the detected station...

Press $\triangle\triangledown$ to move the highlight bar (pointer) to "CONTINUE" then press **ENTER** or \triangleright . Channel search will resume.



If you want to store the detected station...

Press $\triangle\triangledown$ to move the highlight bar (pointer) to "STORE," then press **ENTER** or \triangleright . The Channel List appears again.

- The blueback screen and the TV picture currently being broadcast appear alternately for 8 seconds each.
- If you want to store another channel, repeat steps **4** – **6**.
- When channel search completes for that band, the Band Select screen appears again. To set channels for other bands, select another band and start Manual Channel Set again (ⓘ steps **5** and **6**).

7 Return to the normal screen.

Press **SET UP**.

- To change positions, see "Swap Channel Position" (ⓘ pg. 62).

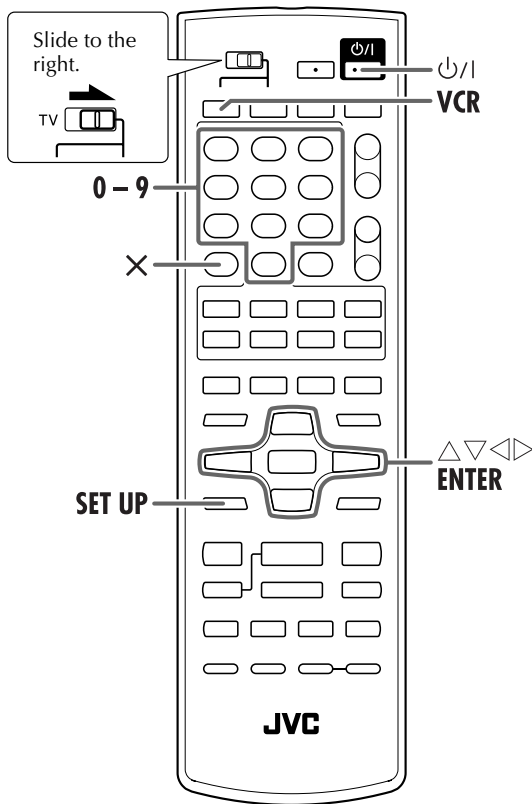

Swap Channel Position

Perform steps **1** to **3** of "Manual Channel Set" on page 61 to access the Channel List screen before continuing.

1 Select the position (e.g. 03).

Press \triangle / ∇ until the section of CH "03" begins blinking, then press **ENTER** or \blacktriangleright .

- Only "03" will blink.

2 Select the position (e.g. 09).

Press **number keys** to input "0" and "9."

- The two selected channels will be swapped.
- To cancel the channel swapping, press \blacktriangleleft .

CH	FRQ	SYS	CH	FRQ	SYS
01	150	BG	07	229	BG
02	165	BG	08	237	BG
03	195	BG	09	355	BG
04	205	BG	10	365	BG
05	213	BG	11	374	BG
06	221	BG	12	384	BG

[0-9]: INPUT CH
[ENTER]: FINE TUNING
[SET UP]: EXIT

CH	FRQ	SYS	CH	FRQ	SYS
01	150	BG	07	229	BG
02	165	BG	08	237	BG
03	355	BG	09	195	BG
04	205	BG	10	365	BG
05	213	BG	11	374	BG
06	221	BG	12	384	BG

[◀]: CANCEL
[ENTER]: OK
[SET UP]: EXIT

- Repeat steps **1** and **2** as necessary.

3 Store the new position.

Press **ENTER** or \blacktriangleright .

4 Return to the normal screen.

Press **SET UP**.

Delete A Channel

Perform steps **1** and **2** of "Manual Channel Set" on page 61 to access the channel list screen before continuing.

1 Select the channel.

Press \triangle / ∇ until the channel you want to delete begins blinking.

2 Delete a channel.

Press **X**.

- To re-store it, simply press \blacktriangleleft .
- The item directly beneath the cancelled one moves up one line.
- Repeat steps **1** and **2** as necessary.

3 Return to the normal screen.

Press **SET UP**.

Fine Tuning Channels Already Stored

Perform steps **1** to **3** of "Manual Channel Set" on page 61 to access the channel list screen before continuing.

1 Select the channel to fine-tune.

Press Δ / ∇ until the channel you want to tune begins blinking, then press **ENTER** twice.

- The "FRQ" number for the channel starts blinking.

2 Perform tuning.

Press Δ / ∇ until the picture is its clearest. Then press **ENTER** or \triangleright .

- Repeat steps **1** and **2** as necessary.

3 Return to the normal screen.

Press **SET UP**.

TV System Selection — When you see the picture but the audio can't be heard or sounds unnatural

Perform steps **1** and **3** of "Manual Channel Set" on page 61 to access the Channel List screen before continuing.

1 Select the channel.

Press Δ / ∇ until the channel you want to change its TV system begins blinking, then press **ENTER** three times.

- The "SYS" display for that channel starts blinking.

CH	FRQ	SYS	CH	FRQ	SYS
01	150	BG	07	229	BG
02	165	BG	08	237	BG
03	195	BG	09	355	BG
04	205	BG	10	365	BG
05	213	BG	11	374	BG
06	221	BG	12	384	BG

\blacktriangle / \blacktriangledown : SELECT SYSTEM
 [ENTER] : OK
 [SET UP] : EXIT

2 Select the TV system.

Press Δ / ∇ to select the appropriate TV system (B/G \rightarrow D/K \rightarrow I). Then press **ENTER** or \triangleright .

- Repeat steps **1** and **2** as necessary.

3 Return to the normal screen.

Press **SET UP**.

Child Lock

- Turn on the TV and select the video channel (or AV mode).
- Slide the TV/VCR/DVD switch on the remote control to the right.

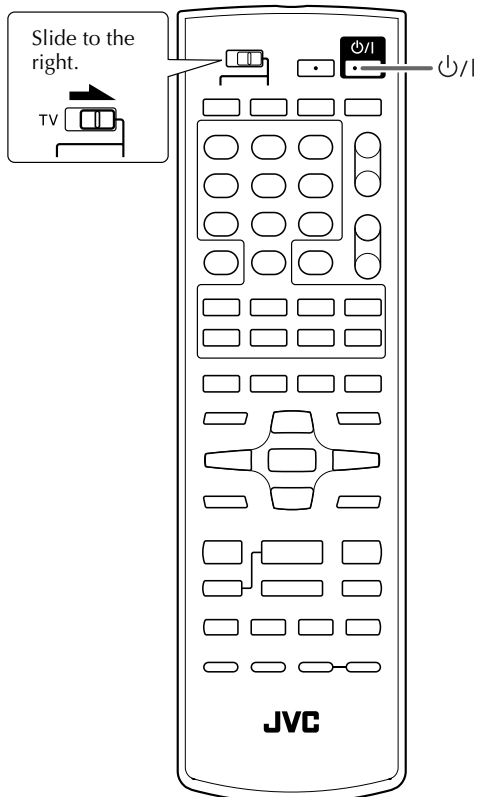

You can disable the unit's operation.

1 Set the Child Lock.

Press and hold P/1 on the remote control for more than 10 seconds while the unit is turned on. The unit turns off, and "CL" appears on the front display panel.



- To release the child lock, press and hold P/1 on the remote control until the unit turns on.

NOTES:

- When the child lock function is in use, keep the remote control out of the children's reach.
- Timer recording programmes will be performed even if the child lock function is activated.

Information on Multi-System Compatibility (VHS deck)

Off-Air Recording

The built-in multi-system tuner is capable of receiving PAL B/G, I and D/K, and SECAM B/G and D/K broadcasts.

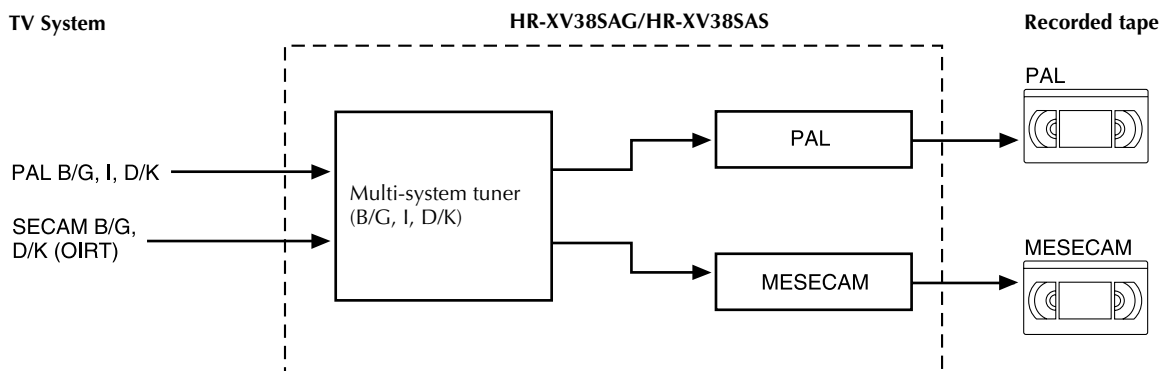

NOTE:

This model does not operate in BRAZIL (PAL-M) or ARGENTINA (PAL-N).

Playback

This unit can play all 3 types of recorded tape.

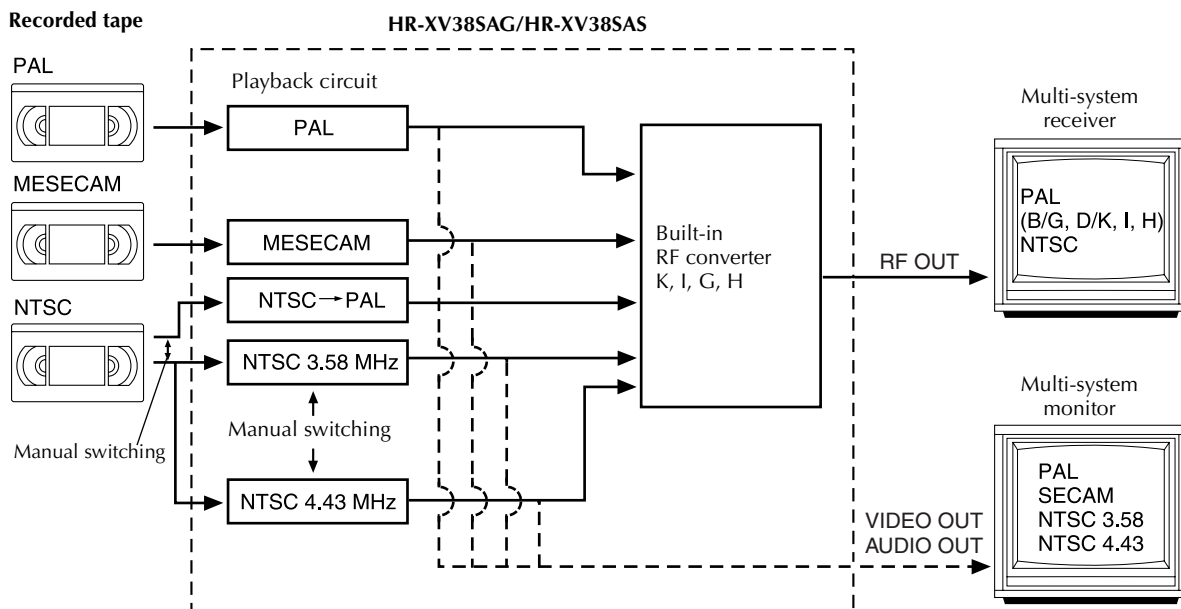

NOTES:

When viewing NTSC tapes on a PAL TV set:

- The picture may shrink vertically with black bars appearing at the top and bottom of the screen. This is not a malfunction on the part of the nor the TV.
- The picture may roll up or down. This can be corrected using the V-HOLD control found on some TVs. (This cannot be corrected if the TV does not have a V-HOLD control.)
- During search, still, or frame-by-frame playback, the picture will be distorted, and there may be a loss of colour.

ATTENTION

When this unit is connected to a multi-system TV, the audio signal may not be heard or maybe noisy if the colour system select switch of the TV is adjusted to the AUTO position. In such a case, set the TV's colour system select switch to the appropriate position which corresponds to the TV system you have selected at the TV System Select screen.

Tape-To-Tape Editing

There are 3 different types of recorded tape, depending on the signal recorded.

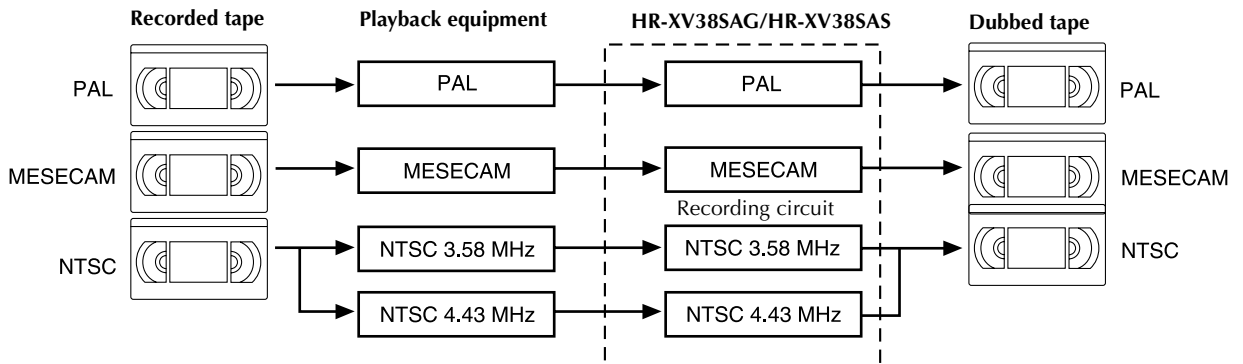

Before requesting service for a problem, use this chart and see if you can repair the trouble yourself. Small problems are often easily corrected, and this can save you the trouble of sending your unit off for repair.

Power

No power is supplied to the unit.

- The mains power cord is disconnected.
- Connect the mains power cord.

The remote control won't function.

- The batteries are discharged.
- Replace the dead batteries with new ones.

Tape Transport (VHS deck)

During recording, the tape does not run. "●" lights up on the front display panel.

- The unit is in the Record Pause mode.
- Press **▶** to resume recording.

The tape will not rewind or fast-forward.

- The tape is already fully rewound or fast-forwarded.
- Check the cassette.

Playback (VHS deck)

The VHS deck can not be operated.

- The VHS deck is not selected.

On the unit

- Press **VCR/DVD** repeatedly so that the VCR indicator lights up.

On the remote control

- Press **VCR** so that the VCR indicator lights up.

The playback picture does not appear while the tape is running.

- If you are using the RF connection,
 - the TV receiver's channel selector is not set to the video channel.
 - the unit's video channel has not been correctly set.
- If you are using the RF connection,
 - set the TV receiver to the video channel.
 - perform "Video Channel Set" (☞ pg. 13).
- If you are using the AV connection, the TV receiver is not set to the AV mode.
- If you are using the AV connection, set the TV to its AV mode.

Noise appears during visual search.

- This is normal.

Noise appears during normal playback.

- The automatic tracking mode is engaged.
- Try manual tracking. (☞ pg. 22)

The playback picture is blurred or interrupted while TV broadcasts are clear or "USE CLEANING CASSETTE" message appears on the screen.

- The video heads may be dirty.
- Use a dry cleaning cassette ECL-3F, or consult your JVC dealer.

Breaks are noticeable in Hi-Fi soundtrack.

- The automatic tracking mode is engaged.
- Try manual tracking. (☞ pg. 22)

Playback (DVD deck)

The button does not work.

- The operation is prohibited on the placed disc.

The DVD deck cannot be operated.

- The DVD deck is not selected.

On the unit

- Press **VCR/DVD** repeatedly so that the DVD indicator lights up.

On the remote control

- Press **DVD** so that the DVD indicator lights up.

"⊘" appears on the TV screen.

- The operation is prohibited on the placed disc.

"REGION CODE ERROR!" appears on the TV screen.

- The disc's region number does not match that of the unit.
- Use the discs whose region number matches with your unit. (☞ pg. 4)

The disc cannot be played back.

- The disc's region number does not match that of the unit.
- Use the discs whose region number matches with your unit. (☞ pg. 4)
- This type of disc cannot be played back.
- See "Unplayable Discs" (☞ pg. 4).
- The disc is not placed properly.
- Remove the disc, then place the disc properly in the disc tray. (☞ pg. 5, "Placing a Disc")
- The Parental Lock is engaged, and the placed disc is rated higher than the set level.
- Release the Parental Lock temporarily, or change the set level. (☞ pg. 58)

The language is not played back as you set.

- The disc does not contain the language you set.

The playback picture does not appear while the DVD disc is played.

- Scan mode is set to PROGRESSIVE.
- Change the Scan mode to the Interlace. (☞ pg. 11)

Changing audio/subtitle language is not possible.

- The disc does not contain audio/subtitles in multiple languages.
- With some discs, the language should be set on the top menu. (☞ pg. 34)

The subtitles do not appear on the TV screen.

- The disc does not contain subtitles.
- The subtitle display is set to off.
- Set the subtitles display to on. (☞ pg. 37)
- A-B Repeat Playback is in progress. (☞ pg. 44)
- The subtitles recorded around point A-B may not appear.

Angle cannot be changed.

- The scene is not recorded from multiple angles.

MP3/JPEG Files Playback (DVD deck)**A disc cannot be played.**

- No MP3 files or JPEG files are recorded to the disc.
- Replace the disc with MP3 files or JPEG files are recorded.
- Files do not have the correct file extension in their file names.
- Add correct file extension to their file names.
- Files are not recorded in a format compliant with ISO 9660 Level 1 or 2.
- Replace the disc. (Record files using a compliant application.)
- The types of files other than MP3 or JPEG are recorded to the disc.
- The disc which contains the types of files other than MP3 or JPEG may not be played because of its disc characteristics or recording conditions.

When playing back a disc which contains both MP3 files and JPEG files, either MP3 files or JPEG files are played.

- When playing back a disc which contains both MP3 files and JPEG files, the selected files in the "FILE TYPE" setting are played back.
- Set "FILE TYPE" to either "AUDIO" (for MP3 files) or "STILL PICTURE" (for JPEG files) which you want to play back beforehand. (☞ pg. 57)

The control display appears on the TV screen, but no operation can be performed.

- No MP3 files or JPEG files are recorded to the disc, or the disc is an unplayable disc (such as CD-ROM).
- Replace the disc.

Recording (VHS deck)**Recording cannot be started.**

- There is no cassette loaded, or the cassette loaded has had its record safety tab removed.
- Insert a cassette, or using adhesive tape, cover the hole where the tab was removed.

TV broadcasts cannot be recorded.

- "L-1" or "F-1" has been selected as the input mode.
- Set to the desired channel.

Tape-to-tape editing is not possible.

- The source (another video recorder, camcorder) has not been properly connected.
- Confirm that the source is properly connected.
- All necessary power switches have not been turned on.
- Confirm that all units' power switches are turned on.
- The input mode is not correct.
- Set the input mode to "L-1" or "F-1."

Camcorder recording is not possible.

- The camcorder has not been properly connected.
- Confirm that the camcorder is properly connected.
- The input mode is not correct.
- Set the input mode to "L-1" or "F-1."

"●" and "▶" on the front display panel won't stop blinking.

- The end of the tape was reached during recording.
- The programme may not have been recorded in its entirety. Next time make sure you have enough time on the tape to record the entire programme.

The channel cannot be changed.

- Recording is in progress.
- Press **II** to pause the recording, change channels, then press **▶** to resume recording.

TIMER RECORDING (VHS deck)

Timer recording won't work.

- The clock and/or the timer have been set incorrectly.
→ Re-perform the clock and/or timer settings.
- The timer is not engaged.
→ Press  and confirm that "Ⓣ" is displayed on the front display panel.

Timer programming is not possible.

- Timer recording is in progress.
→ Timer programming can't be performed while a timer recording is in progress. Wait until it finishes.



"Ⓣ" on the front display panel won't stop blinking.

- The timer is engaged but there's no cassette loaded.
→ Load a cassette with the record safety tab intact.

"Ⓣ", "●" and "▶" on the front display panel won't stop blinking.

- The loaded cassette has had its record safety tab removed.
→ Remove the cassette and cover the hole with adhesive tape, or insert a cassette with the record safety tab intact.
- The end of the tape was reached during timer recording.
→ The programme may not have been recorded in its entirety. Next time make sure you have enough time on the tape to record the entire programme.
→ Turn off the timer mode by pressing timer button or next operations cannot be carried on.

"Ⓣ" blinks for 10 seconds and the Timer mode is disengaged.

-  has been pressed when there are no programs in memory, or the timer record information has been programmed incorrectly.
→ Check the programmed data and re-program as necessary, then press  again.

The SHOWVIEW system does not timer-record properly.

- The unit's channel positions have been set incorrectly.
→ Refer to "G-CODE/SHOWVIEW™ Timer Programming" ( pg. 27) and re-perform the procedure.

"●" and "▶" on the front display panel won't stop blinking.

- The end of the tape was reached during Instant Timer Recording.
→ The programme may not have been recorded in its entirety. Next time make sure you have enough time on the tape to record the entire programme.

"Ⓣ", "●" and "▶" on the front display panel won't stop blinking.

- The loaded cassette has had its record safety tab removed.
→ Remove the cassette and cover the hole with adhesive tape, or insert a cassette with the record safety tab intact.
- The end of the tape was reached during Automatic Satellite Programme Recording.
→ The programme may not have been recorded in its entirety. Next time make sure you have enough time on the tape to record the entire programme.
→ Turn off the timer mode by pressing REC LINK button or next operations cannot be carried on.

OTHER PROBLEMS

Whistling or howling is heard from the TV during camcorder recording.

- The camcorder's microphone is too close to the TV.
→ Position the camcorder so its microphone is away from the TV.
- The TV's volume is too high.
→ Turn the TV's volume down.

When scanning channels, some of them are skipped over.

- Those channels have been designated to be skipped.
→ If you need the skipped channels, restore them. ( pg. 61)

Channel settings that were made manually seem to have changed or disappeared.

- After the manual settings were made, Auto Channel Set was performed.
→ Perform the manual settings again.

No channels are stored in the unit's memory.

- The TV aerial cable was not connected to the unit when Auto Set Up was performed.
→ Turn off the unit once and connect the TV aerial cable to the unit properly, then turn on the unit again. Then perform Auto Set Up again. ( pg. 14)

ATTENTION

This unit contains microcomputers. External electronic noise or interference could cause malfunctioning. In such cases, switch the unit off and unplug the mains power cord. Then plug it in again and turn the unit on. Take out the cassette. After checking the cassette, operate the unit as usual.

GENERAL

Power requirement	: AC 110 V – 240 V~, 50 Hz/60 Hz
Power consumption	
Power on	: 23 W
Power off	: 4.5 W
Temperature	
Operating	: 5°C to 40°C
Storage	: -20°C to 60°C
Operating position	: Horizontal only
Dimensions (WxHxD)	
	: 435 mm x 93 mm x 272 mm
Weight	: 4.2 kg
Format	: VHS PAL/NTSC standard
Maximum recording time	
(SP)	: 240 min. with E-240 video cassette (PAL/MESECAM)
	: 160 min. with T-160 video cassette (NTSC)
(LP)	: 480 min. with E-240 video cassette (PAL/MESECAM)
(EP)	: 480 min. with T-160 video cassette (NTSC)

VIDEO/AUDIO (VHS deck)

Signal system	: PAL-type colour signal and CCIR monochrome signal, 625 lines 50 fields NTSC colour and EIA monochrome signal, 525 lines/60 fields.
Recording system	: DA4 (Double Azimuth) head helical scan system
Signal-to-noise ratio	: 45 dB
Horizontal resolution	
	: 250 lines (PAL/MESECAM)
	: 220 lines (NTSC)
Frequency range	: 70 Hz to 10,000 Hz (Normal audio) 20 Hz to 20,000 Hz (Hi-Fi audio)
Input/Output	: RCA connectors: IN x 2, OUT x 1

VIDEO/AUDIO (DVD deck)

Signal system	: NTSC 3.58
Applicable disc	: DVD (12 cm, 8 cm) CD (12 cm, 8 cm)
Audio characteristics	
DVD	: 4 Hz – 22 KHz
Frequency response	
CD	: 4 Hz – 20 KHz
S/N Ratio	: 90 dB
Wow and flutter	: Below Measurable Level
Dynamic range	: 90 dB
Output	
Component-Y	: (RCA) 1.0 V _{p-p} /75 ohm
Component- PB /PR	: (RCA) 0.7 V _{p-p} /75 ohm
Audio	: (RCA) 2 Vrms, 1 Kohm
Digital Audio	: -21 dBm to -15 dBm (peak)

TUNER/TIMER (VHS deck)

TV channel storage capacity	: 99 positions (+AUX position)
Tuning system	: Frequency synthesized tuner
Channel coverage	
VHF	: (low) 42 MHz – 175 MHz (high) 175 MHz – 470 MHz
UHF	: 470 MHz – 870 MHz
Aerial output	: UHF channels (Adjustable E28-E60)
Program capacity	: 1-year programmable timer / 8 programs
Memory backup time	: Approx. 10 min.

ACCESSORIES

Provided accessories	
	: RF cable, Infrared remote control unit, "R6" battery x 2

Specifications shown are for SP mode unless otherwise specified.

E.& O.E. Design and specifications subject to change without notice.

A	
A-B Repeat Playback	36
About Discs	4
Angle Selection	38
Audio Language and Sound Selection	38
Auto Channel Set	60
Auto Set Up	14
Automatic Satellite Programme Recording	32
C	
Check, cancel and change programmes	30
Connecting To A Dolby Digital Decoder or An Amplifier With A Built-in DTS	52
Country/Area Code List for Parental Lock	59
D	
Digital Audio Dubbing	48
Dubbing (from DVD to VHS)	47
E	
Edit From A Camcorder	45
Edit To Or From Another Video Recorder	46
Elapsed Recording Time Indication	24
Express Timer Programming	29
F	
Fine Tuning Channels Already Stored	63
G	
G-CODE [®] /SHOWVIEW [™] System Setup	26
G-CODE [®] /SHOWVIEW [™] Timer Programming	27
Group/File Selection	44
I	
INDEX	6
Index Search	21
Instant ReView	22
Instant Timer Recording (ITR)	24
L	
Language	
Menu/Audio/Subtitle Language Set	17
On-screen Language Set (VHS deck)	16
Letter Box	15
Locating the Start Point of the Item or Skip the Item ...	35
M	
Manual Channel Set	61
Manual Tracking	22
Mode Set (DVD deck)	
DOWN MIX	57
D. RANGE COMPRESSION	57
DIGITAL AUDIO OUTPUT	57
FILE TYPE	57
MONITOR TYPE	57
ON SCREEN GUIDE	58
PARENTAL LOCK	58
PICTURE SOURCE	57
RESUME	58
SCREEN SAVER	57
Mode Set (VHS deck)	
AUTO POWER OFF	55
AUTO SP→LP TIMER	55
B.E.S.T.	25, 54
O.S.D.	54
PICTURE CONTROL	54
VIDEO STABILIZER	55
Monitor Set (DVD deck)	
MONITOR TYPE	15
N	
Next Function Memory	21
O	
One Touch Replay	21, 35
OPERATIONS ON DVD DECK	33 – 44
OPERATIONS ON VHS DECK	20 – 32
P	
Pan&Scan	15
Playback (DVD deck)	33 – 44
Playback (MP3/JPEG file)	42 – 44
Playback (VHS deck)	20 – 22
Playback Control (PBC) Function	34
R	
Record One Programme While Watching Another	24
Recording	23 – 25
Recording Resume Function	23
Region Number	4
Remote Control Functions	49
Repeat Playback	22, 36, 44
S	
Scan Mode Set (DVD deck)	11
Skip Search	21
Slow Motion	21, 35
Sound Effect (3D PHONIC)	39
Soundtrack Selection	22
Still Picture/Frame-By-Frame Playback	21, 35
Subtitle Selection	37
Swap Channel Position	62
T	
Tape Position Indicator	7
Tape Remaining Time	24
Time Search	37
Timer Recording	27 – 32
Tuner Set	60
V	
Variable Speed Search	21, 35
VFP function	39
W	
When programmes overlap each other	31
Z	
Zooming	35, 44



EN

HR-XV38SAG/HR-XV38SAS

JVC