

JVC

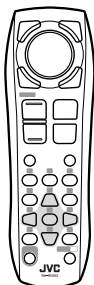

DVD/CD RECEIVER

KD-DV7404

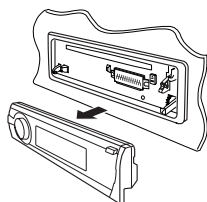

WMA MP3 WAV

DOLBY
DIGITAL

DVD
VIDEO

DIVX

DIVX
ULTRA

COMPACT
disc
DIGITAL VIDEO

dts
Digital Out

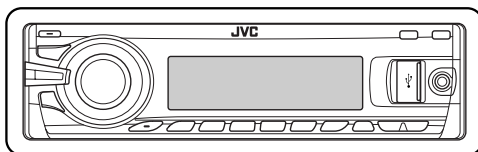

For canceling the display demonstration, see page 7.

For installation and connections, refer to the separate manual.

INSTRUCTIONS

GET0533-001A
[U]

Thank you for purchasing a JVC product.

Please read all instructions carefully before operation, to ensure your complete understanding and to obtain the best possible performance from the unit.

IMPORTANT FOR LASER PRODUCTS

1. CLASS 1 LASER PRODUCT
2. **CAUTION:** Do not open the top cover. There are no user serviceable parts inside the unit; leave all servicing to qualified service personnel.
3. **CAUTION:** Visible and/or invisible class 1M laser radiation when open. Do not view directly with optical instruments.
4. REPRODUCTION OF LABEL: CAUTION LABEL, PLACED OUTSIDE THE UNIT.

CAUTION	ATTENTION	AVISO	WARNING	注意	CAUTION
VISIBLE AND/OR INVISIBLE CLASS 1M LASER RADIATION WHEN OPEN. DO NOT VIEW DIRECTLY WITH OPTICAL INSTRUMENTS. (ENGLISH) IEC60825-1:2001	RAYONNEMENT LASER VISIBLE ET/OU INVISIBLE DE CLASSE 1M UNE FOIS OUVERT. NE PAS REGARDER DIRECTEMENT AVEC DES INSTRUMENTS OPTIQUES. (FRAN) OPPTICS.	RADIACION LASER DE CLASE 1M VISIBLE Y/O INVISIBLE CUANDO ESTA ABIERTO. NO MIRAR DIRECTAMENTE CON INSTRUMENTAL OPTICO. (ESPA) OPTICS.	SYNLIG OCH/ELLER OBYNLIG LASERSTRÅLNING. KLASS 1M, NÅR DENNA DEL ÄR ÖPPNAD. BETRAKTA EJ STRÅLEN MED OPTISKA INSTRUMENT. (SWED) INSTRUMENT.	ここを覗くと有害な 光が/または有害な のクラス 1M レーザー放射が 出ます。 光学機器で直接 見ないでください。 (JPN) LPRN	VISIBLE AND/OR INVISIBLE CLASS II LASER RADIATION WHEN OPEN. DO NOT STARE INTO BEAM. FDA 21 CFR (ENGLISH)



Caution:

If the temperature inside the car is below 0°C, the movement of animation and text scroll will be halted on the display to prevent the display from being blurred. **L.TEMP** appears on the display.

When the temperature increases, and the operating temperature is resumed, these functions will start working again.

For safety...

- Do not raise the volume level too much, as this will block outside sounds, making driving dangerous.
- Stop the car before performing any complicated operations.

Temperature inside the car...

If you have parked the car for a long time in hot or cold weather, wait until the temperature in the car becomes normal before operating the unit.

■ How to reset your unit

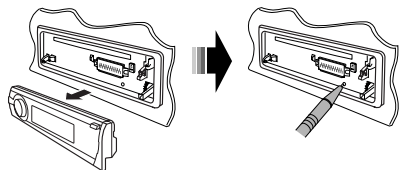

- Your preset adjustments will also be erased (except the registered Bluetooth device, see pages 26 and 27).

■ How to forcibly eject a disc

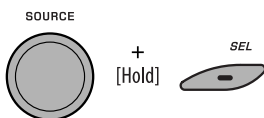

"Please Eject" appears on the display.

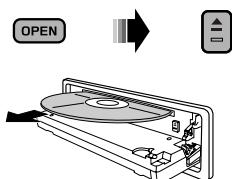

- Be careful not to drop the disc when it ejects.
- If this does not work, reset your unit.

Caution on volume setting:

Digital devices (CD/USB) produce very little noise compared with other sources. Lower the volume before playing these digital sources to avoid damaging the speakers by sudden increase of the output level.

Caution for DualDisc playback

The Non-DVD side of a "DualDisc" does not comply with the "Compact Disc Digital Audio" standard. Therefore, the use of Non-DVD side of a DualDisc on this product may not be recommended.

WARNINGS:

(To prevent accidents and damage)

- **DO NOT** install any unit or wire any cable in a location where;
 - it may obstruct the steering wheel and gearshift lever operations.
 - it may obstruct the operation of safety devices such as air bags.
 - it may obstruct visibility.
- **DO NOT** operate the unit while driving.
- If you need to operate the unit while driving, be sure to look around carefully.
- The driver must not watch the monitor while driving.
If the parking brake is not engaged, "DRIVER MUST NOT WATCH THE MONITOR WHILE DRIVING." appears on the monitor, and no playback picture will be shown.
 - This warning appears only when the parking brake lead is connected to the parking brake system built in the car (refer to the Installation/Connection Manual).

■ How to use the M MODE and SEL buttons

If you use M MODE or SEL (select), the display and some controls (such as the number buttons, ◀◀ ▶▶ ▶▶ ▶▶ ▲ ▲ buttons, ▲/▼ buttons, and the control dial) enter the corresponding control mode.

Ex.: When you press number button 1 after pressing M MODE, to operate the FM tuner.

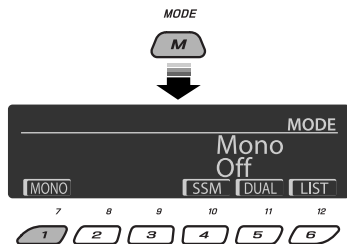

To use these controls for original functions, press M MODE again.

- However, pressing SEL makes the unit enters a different mode.
- Waiting for about 15 seconds (or 30 seconds for Bluetooth sources) without pressing any of these buttons will automatically cancels the control.

Indication language:

In this manual, English indications are used for purposes of explanation. You can select the indication language on the monitor on the "LANGUAGE" setting (see page 45).

■ Detaching the control panel

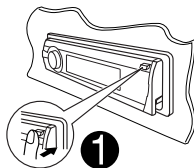

Avoid touching the connectors.

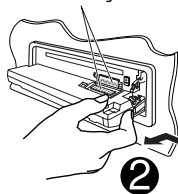

■ Attaching the control panel

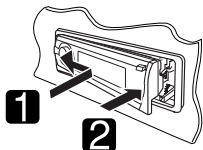

■ Opening and closing the control panel

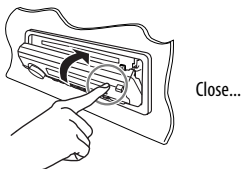
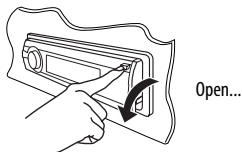

CONTENTS

INTRODUCTIONS

Playable disc type	6
Preparation	7

OPERATIONS

Basic operations	8
• Using the control panel	8
• Using the remote controller (RM-RK252)	9
Listening to the radio	12
Disc operations	14
• Operations using the control panel	15
• Operations using the remote controller (RM-RK252)	18
Listening to the USB device	24
Dual Zone operations	25

EXTERNAL DEVICES

Listening to the Bluetooth® devices	26
• Using the Bluetooth cellular phone	28
• Using the Bluetooth audio player	30
Listening to the CD changer	31
Listening to the iPod	32
Listening to the other external components	36

SETTINGS

Selecting a preset sound mode	38
General settings — PSM	40
Disc setup menu	45
Bluetooth settings	47
Title assignment	48

REFERENCES

Maintenance	49
More about this unit	50
Troubleshooting	58
Specifications	62

Playable disc type

Disc type	Recording format, file type, etc	Playable
DVD	DVD Video (Region Code: 5) *1 	✓OK
	DVD Audio	✗NO
	DVD-ROM	
DVD Recordable/Rewritable (DVD-R/-RW *2, +R/+RW *3) <ul style="list-style-type: none"> DVD Video: UDF bridge DVD-VR DivX/MPEG-1/MPEG-2/MP3/WMA/WAV: ISO 9660 level 1, level 2, Romeo, Joliet 	DVD Video	✓OK
	DVD-VR	
	DivX/MPEG1/MPEG2	
	MP3/WMA/WAV	✗NO
	AAC	
	JPEG/MPEG4	
	DVD+VR	
	DVD-RAM	
Dual Disc	DVD side	✓OK
	Non-DVD side	✗NO
CD/VCD	Audio CD/CD Text (CD-DA)/DTS-CD *4	✓OK
	VCD (Video CD)	
	SVCD (Super Video CD)	✗NO
	CD-ROM	
	CD-I (CD-I Ready)	
CD Recordable/Rewritable (CD-R/-RW) <ul style="list-style-type: none"> ISO 9660 level 1, level 2, Romeo, Joliet 	CD-DA	✓OK
	DivX/MPEG1/MPEG2	
	MP3/WMA/WAV	
	AAC	✗NO
JPEG/MPEG4		

*1 If you insert a DVD Video disc of an incorrect Region Code, "REGION CODE ERROR" appears on the monitor.

*2 DVD-R recorded in multi-border format is also playable (except for dual layer discs). DVD-RW dual layer discs are not playable.





*3 It is possible to play back finalized +R/+RW (Video format only) discs. +RW double layer discs are not playable.

*4 To reproduce DTS sound, use the DIGITAL OUT terminal (see also pages 46 and 56).

Preparation

Cancel the display demonstration and set the clock

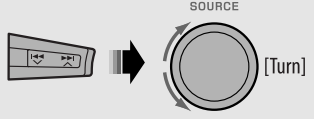
- See also pages 40 and 41.

1	 ϕ /I/ATT	Turn on the power.
2	 SEL [Hold]	Enter the PSM settings.
3	 SOURCE [Turn]	Cancel the display demonstrations Select "Demo," then "Off." Set the clock Select "Clock Hr" (hour), then adjust the hour. Select "Clock Min" (minute), then adjust the minute. Select "24H/12H," then "24Hours" or "12Hours."
4	 SEL	Finish the procedure.

Changing the display information and pattern

When the power is turned off: Check the current clock time



Ex.: When tuner is selected as the source

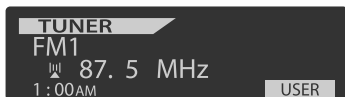

Source operation display

- If a station has been assigned a title, station title appears after about 5 seconds.
- To assign a title to a station, see page 48.

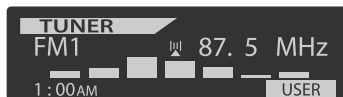

Audio level meter display
(see "LevelMeter" on page 40)

Basic operations

Using the control panel

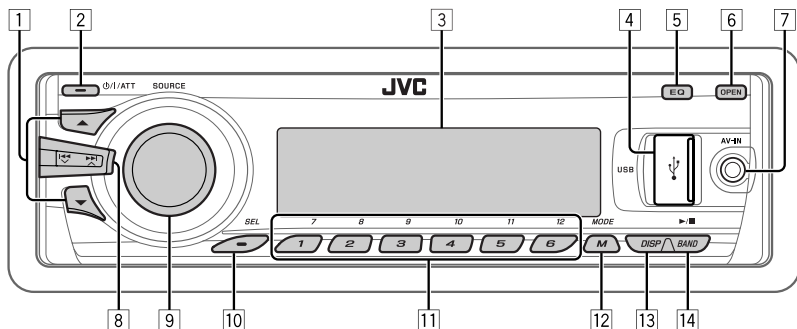

- 1 • **TUNER:** Select preset station.
- **DISC/USB/CD-CH:** Select title/program/playlist/folder.
- **USB-iPod:** Enter the main menu [Hold].
- **iPod:** Enter the main menu/Pause playback/Confirm selection.
- **BT-PHONE/BT-AUDIO:** Select a registered device.
- 2 • Turn on the power.
- Turn off the power [Hold].
- Attenuate the sound (if the power is on).
- 3 Display window
- 4 USB (Universal Serial Bus) input jack
- 5 Select the sound mode
- 6 Flip down the control panel.
 - To eject the disc, flip down the control panel then press ▲ on the unit.
- 7 AV-IN (video) input jack
- 8 • **TUNER:** Search for station.
- **DISC/USB/USB-iPod/CD-CH/iPod:** Select chapter/track.
- **BT-AUDIO:** Reverse skip/forward skip.
- 9 • Volume control [Turn].
- Select the source [Press]*1.
TUNER → **DISC***2 → **USB***2 (or **USB-iPod**)*2 → **CD-CH***2/**iPod***2 (or **EXT IN**) → **BT-PHONE***2 → **BT-AUDIO***2 → **LINE IN** → **AV IN** → (back to the beginning)
- 10 • Select/adjust the sound mode.
- Enter the PSM settings [Hold].
- 11 • **TUNER:** Select preset station.
- **DISC/USB/CD-CH:** Select chapter/title/program/folder/track/disc (for CD changer).
- **BT-PHONE:** Dial preset phone number*3.
- 12 • Enter functions mode.
- **BT-PHONE:** Activate Voice Dialing [Hold].
- 13 Change the display information and pattern.
- 14 • **TUNER:** Select the bands.
- **DISC/USB/USB-iPod:** Start/pause playback.
- **BT-AUDIO:** Start/pause playback.

*1 Holding SOURCE will enter the Bluetooth menu if a Bluetooth phone is connected.

*2 You cannot select these sources if they are not ready or not connected.

*3 For storing preset phone number, see page 30.

Using the remote controller (RM-RK252)

Installing the battery

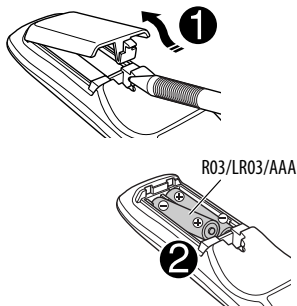

Insert the batteries into the remote controller by matching the polarity (+ and -) correctly.

Caution:

Battery shall not be exposed to excessive heat such as sunshine, fire, or the like.

If the effectiveness of the remote controller decreases, replace both batteries.

Before using the remote controller:

- Aim the remote controller directly at the remote sensor on the unit.
- DO NOT expose the remote sensor to bright light (direct sunlight or artificial lighting).

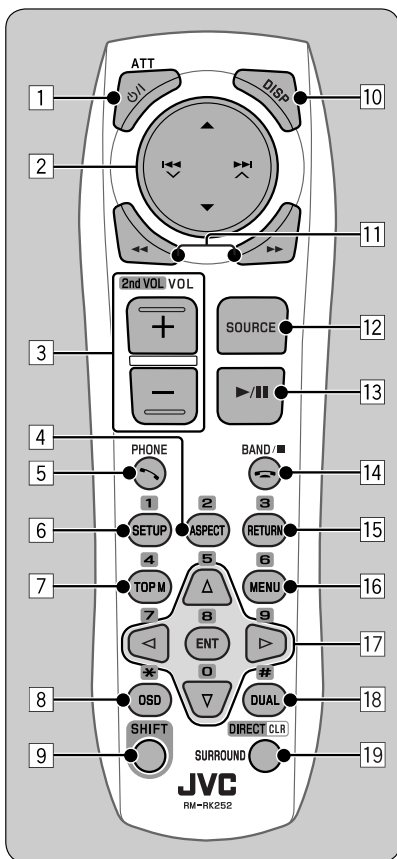
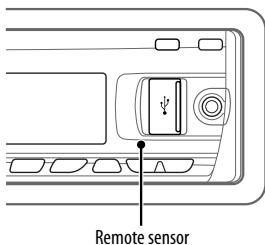

IMPORTANT:

If Dual Zone is activated (see page 25), the remote controller only functions for operating the DVD/CD player.

1 *1 ATT button

- Turns the power on if pressed briefly or attenuates the sound when the power is on.
- Turns the power off if pressed and held.

Continued on the next page

2 ▲/▼ buttons

- **TUNER:** Selects the preset stations.
- **DISC:**
 - DVD-Video: Selects the title.
 - DVD-VR: Selects the program/playlist.
 - DivX/MPEG Video/MP3/WMA/WAV: Selects the folders if included.
- **USB:**
 - DivX/MPEG Video/MP3/WMA/WAV: Selects the folders if included.
- **CD-CH:** Selects the folders if included.
- **IPOD:**
 - ▲: Enters the main menu (then ▲/▼/◀◀▼/▶▶▶▲ work as menu selecting buttons.)
 - ▲: Returns to the previous menu.
 - ▼: Confirms the selection.
 - ▼: Pauses or resumes playback.

◀◀▼/▶▶▶▲ buttons

- **TUNER:**
 - Searches for stations automatically if pressed briefly.
 - Searches for stations manually if pressed and held.
 - **DISC/USB/USB-iPod/CD-CH:**
 - Reverse skip/forward skip if pressed briefly.
 - Reverse search/forward search if pressed and held.
 - **BT-AUDIO:** Reverse skip/forward skip if pressed briefly.
 - **IPOD:**
 - Reverse skip/forward skip if pressed briefly.
 - Reverse search/forward search if pressed and held.
- In menu selecting mode:
- Selects an item if pressed briefly. (Then, press ▼ to confirm the selection.)
 - Skips 10 items at a time if pressed and held.

3 VOL (volume) + / - buttons

- Adjusts the volume level.

2nd VOL (volume) buttons

- Adjust the volume level through the 2nd AUDIO OUT plug when pressed with SHIFT button (see page 25).

4*2 ASPECT button

- Not applicable for this unit.

5*1 ☞ PHONE button

- Answer incoming calls.
- Enters “Redial” menu when a Bluetooth phone is connected [Hold].

6*2 SETUP button

- Enters disc setup menu (during stop).

7*2 TOP M (menu) button

- DVD-Video/DivX: Shows the disc menu.
- DVD-VR: Shows the Original Program screen.
- VCD: Resumes PBC playback.
- **USB-iPod:** Enters the search mode menu (see page 34).

8*2 OSD (on-screen display) button

- Shows the on-screen bar.

9 SHIFT button

- Functions with other buttons.

10 DISP (display) button

- Changes the display information.

11 ◀◀/▶▶ buttons

- DVD-Video: Slow motion playback (during pause).
- DVD-VR/VCD: Forward slow motion playback (during pause).
- **DISC/USB/USB-iPod:** Reverse search/forward search.

12*1 SOURCE button

- Selects the source.

- 13 ▶ (play) / || (pause) **button**
- **DISC/USB/USB-iPod/BT-AUDIO:** Starts/pauses playback.

- 14 ☎ (end call) **button**
- Ends the call.

BAND/■ (stop) buttons

- **TUNER:** Selects the bands.
- **DISC/USB/USB-iPod/BT-AUDIO:** Stops playback.

15*2 **RETURN button**

- **VCD:** Returns to the PBC menu.
- **USB-iPod:** Returns to Control Screen.

16*2 **MENU button**

- **DVD-Video/DivX:** Shows the disc menu.
- **DVD-VR:** Shows the Playlist screen.
- **VCD:** Resumes PBC playback.
- **USB-iPod:** Enters the search mode menu (see page 34).

17*2 ▲/▼ **buttons**

- **DVD-Video:** Makes selection/settings.
- **CD-CH:** Changes discs in the magazine.

◀/▶ **buttons**

- **DVD-Video:** Makes selection/settings.
- **DivX/MPEG Video:** Skips back or forward by about five minutes.

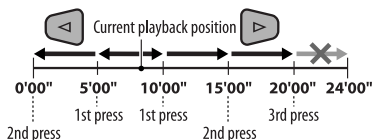

ENT (enter) button

- Confirms selection.

18*2 **DUAL button**

- Activates or deactivates Dual Zone.

19 **SURROUND button**

- Not applicable for this unit.

DIRECT button

- **DISC/USB:** Enters direct search mode for chapter/title/program/playlist/folder/track when pressed with SHIFT button (see page 18 for details).

CLR (clear) button

- **DISC/USB:** Erases the misentry when pressed with SHIFT button.





*1 When Dual Zone is activated, these buttons cannot be used.

2 Functions as number buttons/ (asterisk)/# (hash) when pressed with SHIFT button.

- **TUNER:** Selects the preset stations (1 – 6).

- **DISC:** Enters chapter/title/program/playlist/folder/track number after entering search mode by pressing SHIFT and DIRECT (see page 18 for details).

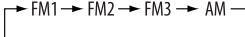
Listening to the radio

1		Select "TUNER."
2		Select the bands. 
3		Search for a station to listen—Auto Search. Manual Search: Hold either one of the buttons until "M" lights up on the display, then press it repeatedly. <ul style="list-style-type: none"> When receiving an FM stereo broadcast with sufficient signal strength, ST lights up on the display.

■ When an FM stereo broadcast is hard to receive

1 

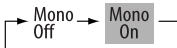
2  

Reception improves, but stereo effect will be lost.

- **MO** lights up on the display.

3 Exit from the setting.



■ FM station automatic presetting —SSM (Strong-station Sequential Memory)

You can preset up to six stations for each band.

1 While listening to a station...



2 



3 

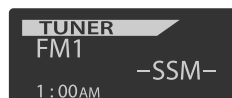

Local FM stations with the strongest signals are searched and stored automatically in the selected FM band.

Manual presetting

Ex.: Storing FM station of 92.5 MHz into preset number 4 of the FM1 band.



Using the number buttons



Using the Preset Station list

• When **BACK** is shown on the display, you can move back to the previous screen by pressing number button 3.

1 Follow steps 1 and 2 of “Using the number buttons” above.

• By holding  / , the Preset Station List will also appear (go to step 4).



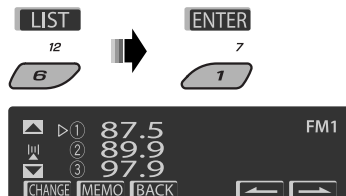

3 Display the Preset Station List.



4 Select the preset number you want to store into.



• You can move to the lists of the other FM bands by pressing number button 5 () or 6 () repeatedly.

5 Store the station.



Listening to the preset station on the Preset Station List

1 Display the Preset Station List, then select the preset station you want to listen to.

2 Change to the selected station.



Disc operations

Before performing any operations...



Turn on the monitor to watch the playback picture. If you turn on the monitor, you can also control playback of other discs by referring to the monitor screen. (See pages 20 – 23.)

The disc type is automatically detected, and playback starts automatically (for DVD: automatic start depends on its internal program).

If the current disc does not have any disc menu, all tracks will be played repeatedly until you change the source or eject the disc.

If “” appears on the monitor when pressing a button, the unit cannot accept the operation you have tried to do.

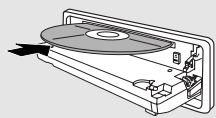
- In some cases, without showing “,” operations will not be accepted.

1		Open the control panel. Make sure to detach the USB device before opening the control panel, as it might block the opening mechanism. <ul style="list-style-type: none">• To detach the USB device, see page 24.
2		Insert the disc. Playback starts automatically.
3	 	Start playback if necessary.

To stop play and eject the disc



- Press SOURCE to listen to another playback source.



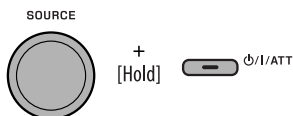





Prohibiting disc ejection



To cancel the prohibition, repeat the same procedure.

Operations using the control panel

Pressing (or holding) the following buttons allows you to...

Disc type			 (Number buttons)* ³
 DVD Video	[Press] Select chapter [Hold] Reverse/fast-forward chapter* ¹	Select title	During stop: Locate title During play/pause: Locate chapter
 DVD VR	[Press] Select chapter [Hold] Reverse/fast-forward chapter* ¹	Select program number/ playlist number	During stop: Locate program During play/pause: Locate chapter
 DivX/MPEG	[Press] Select track [Hold] Reverse/fast-forward track* ²	Select folder	Locate particular folder directly
 VCD	[Press] Select track [Hold] Reverse/fast-forward track* ¹	—	Locate particular track directly (PBC not in use)
 MP3/WMA/WAV	[Press] Select track [Hold] Reverse/fast-forward track* ¹	Select folder	Locate particular folder directly
 CD	[Press] Select track [Hold] Reverse/fast-forward track* ¹	—	Locate particular track directly









*¹ Search speed: $\times 2 \Rightarrow \times 10$

*² Search speed:  1 \Rightarrow  2

*³ Press to select number 1 to 6; hold to select number 7 to 12.

Continued on the next page

After pressing M MODE, press the following buttons to...

Disc type			
	Skip 10 chapters (during play or pause)	Repeat Chapter: Repeat current chapter Repeat Title: Repeat current title	—
	Skip 10 chapters (during play or pause)	Repeat Chapter: Repeat current chapter Repeat Program: Repeat current program (not available for Playlist Playback)	—
	Skip 10 tracks (within the same folder)	Repeat Track: Repeat current track Repeat Folder: Repeat current folder	Random Folder: Randomly play all tracks of current folder, then tracks of next folders Random All: Randomly play all tracks
	Skip 10 tracks (PBC not in use)	Repeat Track: Repeat current track (PBC not in use)	Random All: Randomly play all tracks (PBC not in use)
	Skip 10 tracks (within the same folder)	Repeat Track: Repeat current track Repeat Folder: Repeat current folder	Random Folder: Randomly play all tracks of current folder, then tracks of next folders Random All: Randomly play all tracks
	Skip 10 tracks	Repeat Track: Repeat current track	Random All: Randomly play all tracks

- You can also cancel the playback mode by selecting "Off" or press number button 4 ().

■ Selecting a folder/track on the list (only for MP3/WMA/WAV file)

- When **BACK** is shown on the display, you can move back to the previous screen by pressing number button 3.

1 MODE



2 Select "LIST."



3 Select the list type.

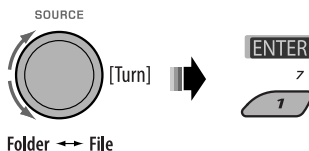

4 Select an item.



Ex.: When "File" is selected in step 3

- You can move to the other lists by pressing number button 5 () or 6 () repeatedly.

5 Change to the selected item.

Ⓐ If File List is selected



The list disappears and playback starts.

7



Ⓑ If Folder List is selected











7



- If the current folder is selected, File List appears, then repeat steps 4 and 5 Ⓐ to start playback.
- If another folder is selected, playback starts from the 1st file of the selected folder.

Operations using the remote controller (RM-RK252)



Disc	DVD Video / DVD VR	DivX/MPEG
Button		
	Stop play	Stop play
	Start play/Pause (if pressed during play)	Start play/Pause (if pressed during play)
	<ul style="list-style-type: none"> Reverse/forward chapter search*¹ (No sound can be heard.) Slow motion*² during pause (No sound can be heard.) <p>* DVD-VR: Reverse slow motion does not work.</p>	Reverse/forward track search* ⁴ (No sound can be heard.)
	<p>[Press] Select chapter (during play or pause)</p> <p>[Hold] Reverse/fast-forward chapter search*³</p>	<p>[Press] Select track (during play or pause)</p> <p>[Hold] Reverse/fast-forward track search*⁵ (No sound can be heard.)</p>
	<ul style="list-style-type: none"> DVD-Video: Select title (during play or pause) DVD-VR: Select program/playlist (during play or pause) 	Select folder
	—	<ul style="list-style-type: none"> Skip back or forward the scenes by about five minutes Select chapter

To search for chapter/title/program/playlist/folder/track directly (DVD/DivX/MPEG Video/VCD/MP3/WMA/WAV/CD)

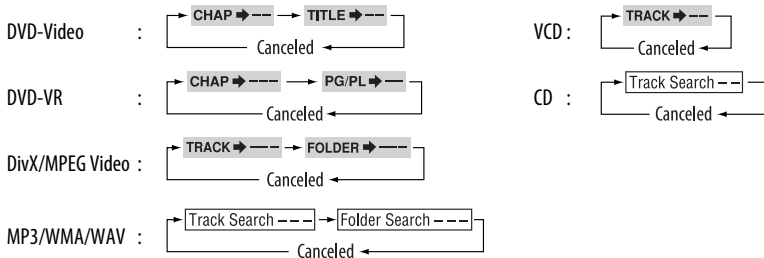
- ① While holding SHIFT, press DIRECT repeatedly to select the desired search mode.







- ② While holding SHIFT, press the number buttons (0 – 9) to enter the desired number.
 ③ Press ENT (enter) to confirm.

		
Stop play	Stop play	Stop play
Start play/Pause (if pressed during play)	Start play/Pause (if pressed during play)	Start play/Pause (if pressed during play)
Reverse/forward track search* ¹ • Forward slow motion* ² during pause. (No sound can be heard.) * Reverse slow motion does not work.	Reverse/forward track search* ¹	Reverse/forward track search* ¹
[Press] Select track (during play or pause) [Hold] Reverse/fast-forward track search* ³ (No sound can be heard.)	[Press] Select track (during play or pause) [Hold] Reverse/fast-forward track search* ³	[Press] Select track (during play or pause) [Hold] Reverse/fast-forward track search* ³
—	Select folder	—
—	—	—

- For DivX/MPEG Video/MP3/WMA/WAV, track is searched within the same folder.
- To erase a misentry, press CLR (clear) while holding SHIFT.
- To return to the previous screen, press RETURN.

*¹ Search speed: ×2 ⇒ ×5 ⇒ ×10 ⇒ ×20 ⇒ ×60

*² Slow motion speed:  ⇒  ⇒  ⇒  ⇒ 

*³ Search speed: ×2 ⇒ ×10

*⁴ Search speed:  ⇒  ⇒ 

*⁵ Search speed:  ⇒ 

Continued on the next page

Using menu driven features... (DVD-Video/ DVD-VR)

- 1 Press TOP M/MENU to enter the menu screen.
- 2 Press $\Delta/\nabla/\leftarrow/\rightarrow^*/\rightarrow^*$ to select an item you want to start play.
- 3 Press ENT (enter) to confirm.

* Not applicable for DVD-VR.

Canceling the PBC playback... (VCD)

- 1 During stop, press DIRECT while holding SHIFT.
 - 2 Hold SHIFT, then press the number buttons (0 – 9) to enter the desired number.
 - 3 Press ENT (enter) to confirm.
- To resume PBC, press TOP M/MENU.

Operations using the on-screen bar

(DVD/DVD-VR/DivX/MPEG Video/VCD)

These operations are possible on the monitor using the remote controller.

1 Show the on-screen bar (see page 21).

 (twice)

2 Select an item.



3 Make a selection.

If pop-up menu appears...

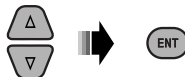

- To cancel pop-up menu, press RETURN.
- For entering time/numbers, see the following.

Entering time/numbers

Press Δ/∇ to change the number, then press \leftarrow/\rightarrow to move to the next entry.

- Each time you press Δ/∇ , the number increases/ decreases by one value.
- After entering the numbers, press ENT (enter).
- It is not required to enter the zero and trailing zeros (the last two digits in the example below).

Ex.: Time search

DVD: $_:_:_:$ (Ex.: 1:02:00)

Press Δ once, then \rightarrow twice to go to the third entry, Δ twice, then press ENT (enter).

To remove the on-screen bar



On-screen bar

Ex.: DVD-Video

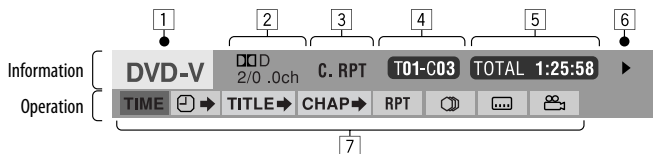

1 Disc type

- 2 • DVD-Video/DTS-CD: Audio signal format type and channel
• VCD:PBC

3 Playback mode*¹

DVD-Video:	T. RPT: Title repeat
	C. RPT: Chapter repeat
DVD-VR:	C. RPT: Chapter repeat
	PG. RPT: Program repeat
DivX/MPEG Video:	T. RPT: Track repeat
	F. RPT: Folder repeat
	F. RND: Folder random
	A. RND: All random
VCD* ² :	T. RPT: Track repeat
	A. RND: All random

4 Playback information

T01-C03	Current title/chapter
PG001 C002	Current program/chapter
PL001 C002	Current playlist/chapter
TRACK 01	Current track
F001-T001	Current folder/track

5 Time indication

TOTAL	Elapsed playing time of the disc (For DVD-Video/DVD-VR, elapsed playing time of the current title/program/playlist.)
T. REM	DVD-Video/DVD-VR: Remaining title/program/playlist time VCD: Remaining disc time
TIME	Elapsed playing time of the current chapter/track* ³
REM	Remaining time of the current chapter/track* ³

6 Playback status

- ▶ Play
- ▶▶ / ◀◀ Forward/reverse search
- ▶ / ◀ Forward/reverse slow-motion
- ⏸ Pause
- Stop

7 Operation icons

- TIME** Change time indication (see 5)
- Time Search (Enter the elapsed playing time of the current title/program/playlist or of the disc.)
- TITLE**▶ Title Search (by its number)
- CHAP**▶ Chapter Search (by its number)
- TRACK**▶ Track Search (by its number)
- Change the audio language or audio channel
- Change or turn off the subtitle language
- Change the view angle
- RPT** Repeat play*¹
- RND** Random play*¹

*¹ For repeat play/random play, see also page 16.

*² While PBC is not in use.

*³ Not applicable for DVD-VR.

Operations using the control screen

(DivX/MPEG Video/MP3/WMA/WAV/CD)

These operations are possible on the monitor using the remote controller.

1 Show the control screen.

DivX/MPEG Video: Press **■** during play.

MP3/WMA/WAV/CD: Automatically appear during play.

2 Select "Folder" column or "Track" column (except for CD).



3 Select a folder or track.



4 Start playback.

DivX/MPEG Video: Press ENT (enter) or **▶/⏸**.

MP3/WMA/WAV/CD: Playback starts automatically.

Control screen

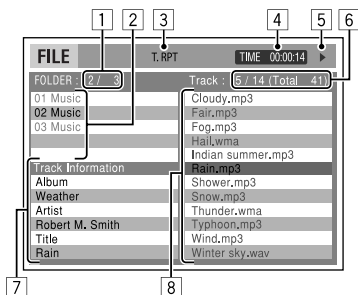

Ex.: MP3/WMA/WAV disc

- 1 Current folder number/total folder number
- 2 Folder list with the current folder selected
- 3 Selected playback mode
- 4 Elapsed playing time of the current track
- 5 Operation mode icon (▶, ■, ⏸, ▶▶, ◀◀)
- 6 Current track number/total number of tracks in the current folder (total number of tracks on the disc)

- 7 Track information
- 8 Track list with the current track selected

To select a playback mode

- 1 While control screen is displayed...



Playback mode selection screen appears on the folder list section of the control screen.

- 2 Select a playback mode.



- 3 Select an item.



RANDOM:

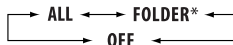

Mode	Playback functions
F. RPT (folder repeat):	Repeat current folder
T. RPT (track repeat):	Repeat current track
A. RND (all random):	Randomly play all tracks
F. RND (folder random):	Randomly play all tracks of current folder, then tracks of next folders

- 4 Confirm the selection.



* Not selectable for CD.

Operations using the list screen

(DVD-VR/DivX/MPEG Video/MP3/WMA/WAV)

These operations are possible on the monitor using the remote controller.

List screen (DivX/MPEG Video/MP3/WMA/WAV)

Before playing, you can display the folder list/track list to confirm the contents and start playing a track.

1 Display the folder list while stop.



2 Select an item from the folder list.

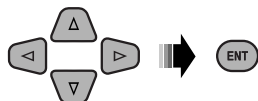

- Track list of the selected folder appears.
- To go back to the folder list, press RETURN.

3 Select a track to start playing.

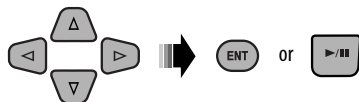

- MP3/WMA/WAV: Control screen appears (see page 22).

Folder: 153/240	Track: 154/198	Page: 4/ 6
fol130	fol140	fol150
fol131	fol141	fol151
fol132	fol142	fol152
fol133	fol143	fol153
fol134	fol144	fol154
fol135	fol145	fol155
fol136	fol146	fol156
fol137	fol147	fol157
fol138	fol148	fol158
fol139	fol149	fol159
		fol160
		fol161
		fol162
		fol163
		fol164
		fol165
		fol166
		fol167
		fol168
		fol169

Ex.: Folder list

- 1 Current folder number/total folder number
- 2 Current track number/total number of tracks in the current folder

- 3 Current page/total number of the pages included in the list
- 4 Current folder/track (highlighted bar)

List screen (DVD-VR)

You can use ORIGINAL PROGRAM or PLAY LIST screen anytime while playing DVD-VR with its data recorded.

- 1 Select a list screen.

TOP M

No	Date	Ch	Time	Title
1	25/04/07	4ch	18:00	JVC DVD World 2004
2	17/05/07	8ch	10:30	
3	22/05/07	8ch	17:00	Musical Festival children 001
4	26/05/07	L-1	13:19	children 001
5	20/05/07	4ch	22:00	
6	25/06/07	L-1	8:23	children 002

MENU

No	Date	Chap	Length	Title
1	25/05/07	001	1:03:16	My JVC World
2	17/06/07	005	1:35:25	
3	20/06/07	003	0:10:23	Favorite music
4	25/06/07	001	0:07:19	children001-002

- 1 Program/playlist number
- 2 Recording date
- 3 Recording source (TV station, the input terminal of the recording equipment, etc.)
- 4 Start time of recording
- 5 Title of the program/playlist*
- 6 Current selection (highlighted bar)
- 7 Creating date of playlist
- 8 Number of chapters
- 9 Playback time

* The title of the original program or playlist may not be displayed depending on the recording equipment.

- 2 Select an item from the list.

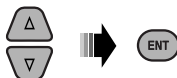

Listening to the USB device

You can connect a USB mass storage class device such as a USB memory, portable HDD, etc. to the unit.

- You can also connect an Apple iPod to the USB input jack. For details of the operations, see pages 32 – 36.

This unit can play DivX/MPEG Video/MP3/WMA/WAV tracks stored in a USB device.

All tracks will be played repeatedly until you change the source or detach the USB device.

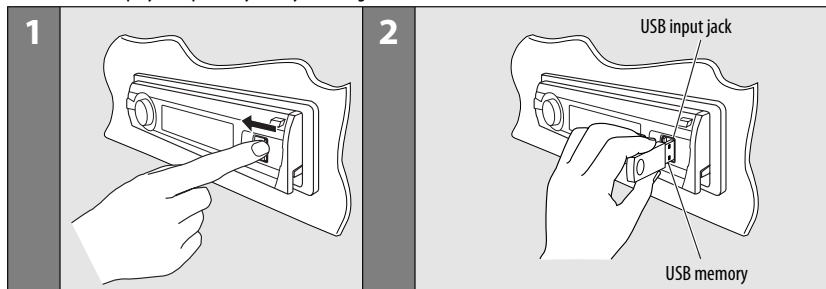

Turn on the monitor to watch the playback picture if you play back a DivX/MPEG file. You can also control playback by referring to the monitor screen. (See also pages 20 – 23.)

- See pages 18 – 23 for operation using the remote controller.
- See pages 45 and 46 for more settings.

If “” appears on the monitor when pressing a button, the unit cannot accept the operation you have tried to do.

- In some cases, without showing “,” operations will not be accepted.

If a USB device has been attached...

SOURCE



Playback starts from where it has been stopped previously.

- If a different USB device is currently attached, playback starts from the beginning.

To stop play and detach the USB device

Straightly pull it out from the unit.

- Press SOURCE to listen to another playback source.

You can operate the USB device in the same way you operate the files on a disc. (See pages 15 – 23.)

- You cannot select “USB” when Dual Zone is in use (see page 25).

Cautions:



- Avoid using the USB device if it might hinder your safety driving.
- Do not pull out and attach the USB device repeatedly while “Reading” is shown on the display.
- Do not start the car engine if a USB device is connected.
- This unit may not be able to play the files depending on the type of USB device.
- Operation and power supply may not work as intended for some USB devices.
- You cannot connect a computer to the USB input terminal of the unit.
- Make sure all important data has been backed up to avoid losing the data.
- Do not leave a USB device in the car, expose to direct sunlight, or high temperature to avoid deformation or cause damages to the device.
- Some USB devices may not work immediately after you turn on the power.
- For more details about USB operations, see pages 51 and 52.

Dual Zone operations

You can enjoy disc playback on the external monitor connected to the VIDEO output terminal and 2nd AUDIO OUT plugs while listening to any source (other than "AM" and "USB") through the speakers.

- You cannot select "AM" or "USB" as the source when Dual Zone is activated.
- When Dual Zone is in use, you can only operate the DVD/CD player using the remote controller. For operations, see pages 18 – 23.

These operations are possible on the monitor using the remote controller.

1		Activate Dual Zone. <ul style="list-style-type: none">• DUAL indicator lights up on the display. <p>The main source automatically changes to "DISC." To select a different source (main source) to listen through the speakers, press SOURCE on the <u>control panel</u>.</p> <ul style="list-style-type: none">• By using the buttons on the control panel, you can operate the newly selected source without affecting Dual Zone operations.
2		Adjust the volume through the 2nd AUDIO OUT plug.
3	—	Operate the DVD/CD player using the remote controller by referring to the monitor screen.

To cancel Dual Zone operations



- DUAL indicator goes off.

On the control panel:



- 2 Enter Dual Zone settings.
Activate or deactivate Dual Zone.



The source automatically changes to "DISC" when Dual Zone is activated.

Listening to the Bluetooth® devices

For Bluetooth operations, it is required to connect the **Bluetooth Adapter** (KS-BTA200) to the CD changer jack on the rear of this unit.

- Refer also to the instructions supplied with the Bluetooth adapter and the Bluetooth device.
- Refer to the list (included in the box) to check the countries where you may use the Bluetooth® function.

To use a Bluetooth device through the unit ("BT-PHONE" and "BT-AUDIO") for the first time, you need to establish Bluetooth wireless connection between the unit and the device.

- Once the connection is established, it is registered in the unit even if you reset your unit. Up to five devices can be registered in total.
- Only one device can be connected at a time for each source ("BT-PHONE" and "BT-AUDIO").

■ Registering a Bluetooth device

Registration (Pairing) methods

Use either of the following items in the Bluetooth menu to register and establish the connection with a device.

- Select "BT-PHONE" or "BT-AUDIO" as the source to operate the Bluetooth menu.

Open	Make the unit ready to establish a new Bluetooth connection. Connection is established by operating the Bluetooth device.
Search	Make the unit ready to establish a new Bluetooth connection. Connection is established by operating the unit.

- When **BACK** is shown on the display, you can move back to the previous screen by pressing number button 3.

Registering using "Open"

Preparation: Operate the device to turn on its Bluetooth function.

1 Select "BT-PHONE" or "BT-AUDIO."

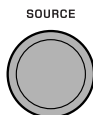

2 Select "New."



3 Enter setting menu.



4 Select "Open."

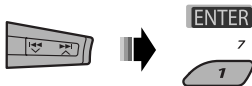

5 Enter a PIN (Personal Identification Number) code to the unit.

- You can enter any number you like (1-digit to 16-digit number). [Initial: 0000]
- To enter a PIN code less than 4-digit, firstly delete the initial PIN code (0000) by pressing number button 5 (**CLEAR**).

* Some devices have their own PIN code. Enter the specified PIN code to the unit.

- 1 Move to the next (or previous) number position.



- 2 Select a number or blank space.

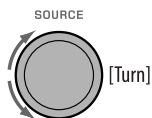

- 3 Repeat steps 1 and 2 until you finish entering a PIN code.

- 4 Confirm the entry.

ENTER "Open..." flashes on the display.



6 Use the Bluetooth device to search and connect.

On the device to be connected, enter the same PIN code you have just entered for this unit.

"Connected (and device name)" appears on the display.

Now connection is established and you can use the device through the unit.

The device remains registered even after you disconnect the device. Use **"Connect"** (or activate **"Auto Connect"**) to connect the same device from next time on. (See the following and page 47.)

Connecting a device

Perform steps 1 – 3 on page 26, then...

- 1 • **Select "Search" to search for available devices.**

The unit searches and displays the list of the available devices.

If no available device is detected, "Device not found" appears.

- **Select "Special" to connect a special device.**

The unit displays the list of the preset devices.

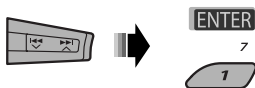

- 2 Select a device you want to connect.



- 3 • **For available devices...**

- 1 Enter the specific PIN code of the device to the unit.

Refer to the instructions supplied with the device to check the PIN code.

- 2 Use the Bluetooth device to connect.

Now connection is established and you can use the device through the unit.

- **For special device...**

Use **"Open"** or **"Search"** to connect.

Connecting/disconnecting/deleting a registered device

- 1 Select **"BT-PHONE"** or **"BT-AUDIO."**

SOURCE



- 2 Select a registered device you want to connect/disconnect/delete.



- 3 Enter setting menu.

MODE



- 4 • **Select "Connect" or "Disconnect" to connect/disconnect the selected device.**

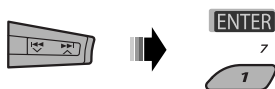

Continued on the next page



- Select “Delete,” then confirm the selection.



Press number button 3 to select “No” or return to the previous screen.

You can set the unit to connect the Bluetooth device automatically when the unit is turned on. (See “Auto Connect” on page 47.)

Using the Bluetooth cellular phone

1	SOURCE 	Select “BT-PHONE.”
2	MODE 	Enter Bluetooth menu.
3	—	Establish the connection with a device, then make a call (or settings using the Bluetooth menu). (See pages 29 and 47.)

When a call comes in...

The source is automatically changed to “BT-PHONE.”

When “Auto Answer” is activated...

The unit answers the incoming calls automatically, see page 47.

- When “Auto Answer” is deactivated, press any button (except ψ/ATT /control dial) to answer the incoming call.

To end the call

Hold any button (except ψ/ATT /control dial).

- You can adjust the microphone volume level (see page 47).

When a text message comes in...

If the cellular phone is compatible with Text Message (notified through JVC Bluetooth adapter) and “Message Info” is set to “Auto” (see page 47), the unit rings and “Received Message” appears on the display to inform you of the message arrival.

Making a call

You can make a call using one of the Dial Menu items.

- When **BACK** is shown on the display, you can move back to the previous screen by pressing number button 3.

1 Select "BT-PHONE."

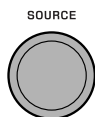

2 Enter setting menu.



3 Select "Dial Menu."



4 Select the method to make a call.

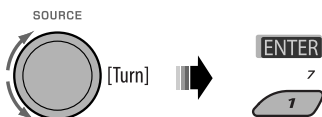

- Redial***: Shows the list of the phone numbers you have dialed. Go to the following step.
- Received***: Shows the list of the received calls. Go to the following step.
- Phonebook***: Shows the phone book of the connected cellular phone. Go to the following step.
- Missed***: Shows the list of the missed calls. Go to the following step.
- Number**: Shows the phone number entry screen. See "How to enter phone number" on the right column.
- Voice Dial** (Only accessible when the connected cellular phone has the voice recognition system): Speak the name (registered words) you want to call.

* **Displayed only when your cellular phone is equipped with these functions.**

- If not displayed, try to transfer the phone book memory of the cellular phone to this unit. (Refer to the instruction manual supplied with your cellular phone.)
- With some cellular phones, the phone book memory is transferred automatically.

5 Select the name/phone number you want to call.



How to enter phone number

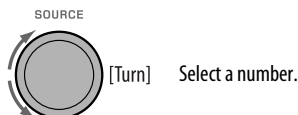

Select a number.



Move the entry position.



Confirm the entry.

Continued on the next page

Using voice command

- 1 **MODE** "Say..." appears on the display.



- 2 **Speak the name (registered words) you want to call.**

- You can also use voice command from the Dial Menu. Select "Voice Dial" from the Dial Menu.
- If your cellular phone does not support the voice recognition system, "Error" appears on the display.

■ Presetting the phone number

You can preset up to six phone numbers.

- When **BACK** is shown on the display, you can move back to the previous screen by pressing number button 3.

- 1 **Display the phone number you want to preset by using one of the "Dial Menu" items.**

- 2 **Select a phone number.**



You can also enter a new phone number (see also "How to enter phone number" on page 29) to store.

- 3 **Select a preset number to store.**

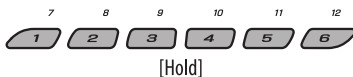

To call a preset number

While in Bluetooth phone....



Using the Bluetooth audio player

- Operations and display indications differ depending on their availability on the connected audio player.

	Select "BT-AUDIO." If playback does not start automatically, operate the Bluetooth audio player to start playback. <ul style="list-style-type: none">• If playback does not pause when you change the source, operate the Bluetooth audio player to pause playback.
--	---

	Reverse skip/forward skip
	Start/pause playback
	Enter setting menu (Device list)

- Refer also to pages 27 and 28 for connecting/disconnecting/deleting a registered device.

Bluetooth Information:



If you wish to receive more information about Bluetooth, visit the following JVC web site: <<http://www.jvc-victor.co.jp/english/car/>>.



Listening to the CD changer

It is recommended to use a JVC MP3-compatible CD changer with your unit. You can connect a CD changer to the CD changer jack on the rear of the unit.

- You can only play conventional CDs (including CD Text) and MP3 discs.

Preparation: Make sure "Changer" is selected for the external input setting, see page 42.

1	SOURCE 	Select "CD-CH."
2		Select a disc to start playing. [Press] For selecting disc number 1 – 6. [Hold] For selecting disc number 7 – 12.

	[Press] Select track [Hold] Reverse/fast-forward track
	MP3: Select folders



* By holding either one of the buttons, you can display the Disc List (see page 17).

To select a disc/folder/track on the list

See "Selecting a folder/track on the list (only for MP3/WMA/WAV file)" on page 17.

Select "Disc" in step 3 to display the Disc List of the CD changer.

After pressing M MODE, press the following buttons to...

	Skip 10 tracks MP3: Within the same folder
	Repeat Track: Repeat current track Repeat Folder: MP3: Repeat all tracks of current folder Repeat Disc: Repeat all tracks of the current disc
	Random Folder: MP3: Randomly play all tracks of the current folder, then tracks of the next folder Random Disc: Randomly play all tracks of current disc Random All: Randomly play all tracks of the discs in the magazine

- You can also cancel the playback mode by selecting "Off" or press number button 4 ().

Listening to the iPod

You can connect an Apple iPod using the following cable or adapter:

To:	Cable or adapter:	Connect to:
Listen to the music	USB 2.0 cable (supplied for the iPod)	USB input jack on the control panel
	Interface adapter for iPod, KS-PD100 (not supplied)	CD changer jack on the rear of the unit Preparation: Make sure "Changer" is selected for the external input setting, see page 42.
Watch the video	USB Audio and Video cable for iPod, KS-U19 (not supplied)	USB input jack and AV-IN input jack on the control panel • Turn on the monitor to watch the video.

- You can control playback from the unit.
- Disconnecting the iPod will stop playback. Press SOURCE to listen to another playback source.
- For details, refer also to the manual supplied for your iPod.
- See also page 53.

Caution:

- Avoid using the iPod if it might hinder your safety while driving.
- Make sure all important data has been backed up to avoid losing the data.

When connecting with the USB cable

Connect using USB 2.0 cable (supplied for iPod):

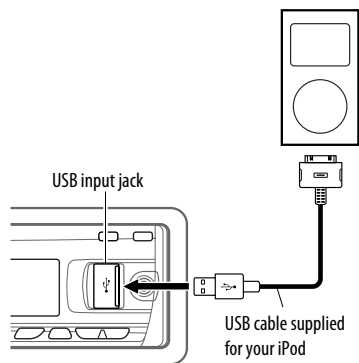

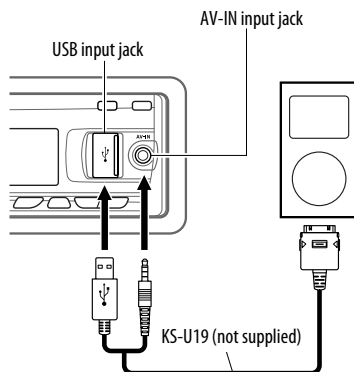

Connect using USB Audio and Video cable for iPod, KS-U19 (not supplied):



Playback starts automatically from where it had been paused previously.*

* Not applicable for video files.

	[Press] Go to the next or previous track [Hold] Fast-forward or reverse the track during playback
	[Hold] Enter main menu
	[Press] Pause/resume playback.

Selecting a track from the menu

1 Enter the main menu.



2 Select the desired menu.



3 Confirm the selection.



- By holding ►►|▲, you can start playback of the selected item directly.
- By holding |◀◀▼, you can exit from the menu.
- By holding ▲/▼, you can fast skip in every layer of the main menu.

Menu items:

For Music:

"Playlists," "Artists," "Albums," "Songs," "Podcasts," "Genres," "Composers," or "Audiobooks"

For Videos:

"Video Playlists," "Movies," "Music Videos," "TV Shows," or "Video Podcasts"

- If a track is selected, playback starts automatically.
- If the selected item has another layer, you will enter the layer. Repeat steps 2 and 3 until the desired track is played.

Operations using the control screen

- These operations are possible on the monitor using the remote controller.
- Connect your iPod to the USB input jack on the control panel using the USB cable supplied for your iPod, or KS-U19 for watching video file.

1 Turn on the monitor.

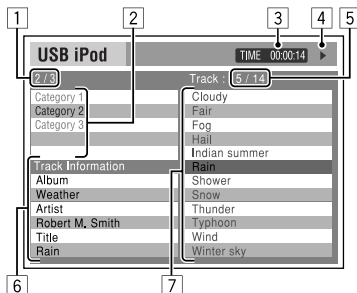

Control screen appears on the monitor.

- 1 Current category number/total category number
- 2 Category list with the current category selected
- 3 Elapsed playing time of the current track
- 4 Operation mode icon (▶, ■, II, ►►, ◀◀)
- 5 Current track number/total number of tracks in the current category
- 6 Track information
- 7 Track list with the current track selected

Continued on the next page

2 Select the desired item.



If the selected item has another layer, you will enter the layer. Repeat this step until the desired track is played.

To select a track from Search Mode

- 1 Enter Search Mode menu.

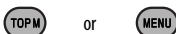

- 2 Select an menu item.



- Selecting Shuffle Songs starts playback.

- 3 Select a search mode category, then the desired track/video.



Search modes category:

For Music:

"Playlists," "Artists," "Albums," "Songs," "Podcasts," "Genres," "Composers," or "Audiobooks"

For Videos:

"Video Playlists," "Movies," "Music Videos," "TV Shows," or "Video Podcasts"

- Available Search Modes depend on the type of your iPod.

- To return to the previous search mode screen, press MENU.
- To return to the control screen, press RETURN.

To select a playback mode/change the speed of the Audiobooks

- 1 While control screen is displayed...



Playback mode selection screen appears on the category list section of the control screen.

- 2 Select an item.



- 3 Select a playback mode/speed.

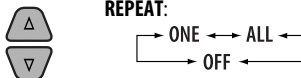

REPEAT:

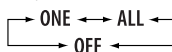

RANDOM:

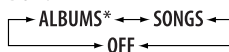

AUDIO BOOK:



REPEAT ONE	Same as "Repeat One."
REPEAT ALL	Same as "Repeat All."
RANDOM ALBUMS*	Same as "Shuffle Albums."
RANDOM SONGS	Same as "Shuffle Songs."
NORMAL	Plays at normal speed.
FASTER	Plays faster.
SLOWER	Plays slower.

* Functions only if you select "All Albums" or "All" in "Albums" of the main "MENU."

- 4 Confirm the selection.



- You can also change the settings from the PSM (Preferred Setting Mode) items. See “AudioBooks” on page 42.

When connecting with the interface adapter

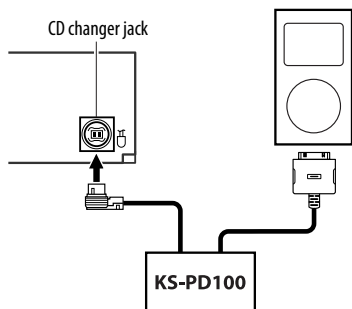

Playback starts automatically from where it had been paused previously.

- If an iPod has been connected, press SOURCE to select “iPod” to listen to music.

	<p>[Press] Go to the next or previous track</p> <p>[Hold] Fast-forward or reverse the track during playback</p>
	<p>[Press] Enter main menu when you press ▲. Pause/resume playback when ▼ is pressed.</p>

Selecting a track from the menu

- 1 Enter the main menu.



- 2 Select the desired menu.



Playlists ↔ Artists ↔ Albums ↔ Songs ↔
Genres ↔ Composers

- 3 Confirm the selection.



- By holding |◀◀▼/▶▶|▲, you can fast skip during song search in the main menu.
- If a track is selected, playback starts automatically.
- If the selected item has another layer, you will enter the layer. Repeat steps 2 and 3 until the desired track is played.

Selecting the playback modes

After pressing M MODE, press the following buttons to...

<p>RPT</p> <p>B</p> <p>2</p>	<p>Repeat One: Same as “Repeat One.”</p> <p>Repeat All: Same as “Repeat All.”</p> <p>Repeat Off: Cancels.</p>
<p>*1</p> <p>RND</p> <p>9</p> <p>3</p>	<p>Random Album*2: Same as “Shuffle Albums.”</p> <p>Random Song: Same as “Shuffle Songs.”</p> <p>Random Off: Cancels.</p>

*1 Not applicable for video files.

*2 Functions only if you select “All Albums” or “All” in “Albums” of the main “MENU.”

Continued on the next page

The menu selecting mode will be canceled:

- If no operations are performed for about:
 - 5 seconds for iPod connected through KS-PD100.
 - 15 seconds for iPod connected to the USB input jack.
- When you confirm the selection of a track.

Listening to the other external components

You can connect an external component to:

- CD changer jack on the rear of this unit using the following adapters:
 - **Line Input Adapter**, KS-U57
 - **AUX Input Adapter**, KS-U58

Preparation: Make sure "Ext In" is selected for the external input setting, see page 42.

- AV-IN (video) input jack on the control panel.

Preparation: Make sure to connect and turn on the monitor to watch the playback picture. If the parking brake is not engaged, "Parking Brake" appears on the display and no playback video on the monitor. For connection, see Installation/Connection Manual (separate volume).

- LINE IN terminals on the rear of this unit.

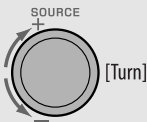
1		Select "EXT IN," "LINE IN," or "AV IN."
2	—	Turn on the connected component and start playing the source.
3		Adjust the volume.
4	—	Adjust the sound as you want (see pages 38 and 39).

Connecting an external component to the AV-IN input jack

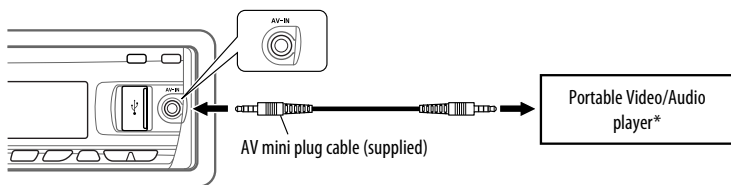

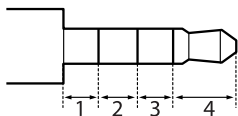

* Portable Video/Audio player of this pin-allocation can be connected:



1	2	3	4	
Audio (R)	GND	Video	Audio (L)	Camcorder
Video	GND	Audio (R)	Audio (L)	iPod, etc.
GND		Audio (R)	Audio (L)	AUX

Selecting a preset sound mode

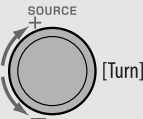
You can select a preset sound mode suitable to the music genre (iEQ: intelligent equalizer).

1		Select "EQ."
2		Select "On." • If "Bypass" is selected, you can listen to the original sound mode recorded. PURE lights up on the display.
3		Select a preset sound mode.

Preset value setting for each sound mode

Sound mode	Preset value				
	Band 1 (100 Hz)	Band 2 (320 Hz)	Band 3 (1 kHz)	Band 4 (3.2 kHz)	Band 5 (10 kHz)
USER	0	0	0	0	0
ROCK	+3	+2	0	+1	+1
CLASSIC	+2	+2	0	+1	0
POPS	0	+1	0	+1	+2
HIP HOP	+4	+1	-2	0	+1
JAZZ	+3	+2	+1	+2	+2

Adjusting the sound

You can adjust the sound characteristics to your preference.

- When **BACK** is shown on the display, you can move back to the previous screen by pressing number button 3 or 6.

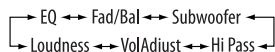

- For "EQ" setting, see above.

3 Adjust the selected setting item.

(A) Fad/Bal (Fader/Balance)

- Press number button 1 (**SELECT**) to move to the "Fad/Bal" adjustment display.
- Adjust the speaker output balance by pressing:
▲ / ▼: between the front and rear speakers. [F6 to R6]
◀◀ / ▶▶: between the left and right speakers. [L6 to R6]

(B) Subwoofer

- Press number button 1 (**SELECT**) to move to the "Subwoofer" adjustment display.
- Use ◀◀ / ▶▶ to select a cutoff frequency to the subwoofer.
 - Off*: All signals are sent to the subwoofer.

- 55Hz: Frequencies higher than 55 Hz are cut off.
- 85Hz: Frequencies higher than 85 Hz are cut off.
- 120Hz: Frequencies higher than 120 Hz are cut off.

3 Turn the control dial to adjust the subwoofer output level. [0 to 8]

4 Press number button 1 (**MORE**) to move to another setting level.

◀◀▶▶|▶▶|◀◀: select the quality of LPF. [-12dB/oct or -24dB/oct]

Control dial: Turn the control dial to select the subwoofer phase. [0deg (normal) or 180deg (reverse)]

* If "Off" is selected in step 2, you can only adjust the subwoofer phase.

C Hi Pass (Hi Pass Filter)

Turn the control dial to select the cutoff frequency to the front/rear speakers. Set this to match the LPF setting.

- Off: All signals are sent to the front/rear speakers.
- 62Hz: Frequencies lower than 62 Hz are cut off.
- 95Hz: Frequencies lower than 95 Hz are cut off.
- 135Hz: Frequencies lower than 135 Hz are cut off.

D VolAdjust, [-5 to +5]

Turn the control dial to adjust the input level of each source (except FM).

Adjust to match the input level of the FM sound level.

- Before making an adjustment, select the source you want to adjust.

E Loudness, [Off or On]

Turn the control dial to select "Off" or "On." When "On" is selected, low and high frequencies sound are boosted to produce a well-balanced sound at low volume level.

4 Exit from the setting.



Storing your own sound modes

You can adjust the sound modes and store your own adjustments in memory.

- When **BACK** is shown on the display, you can move back to the previous screen by pressing number button 6.

1 **EQ**

2 Select a sound mode.



3 Select a frequency range to adjust.

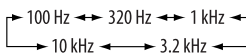

4 Adjust the sound elements of the selected frequency range.

1 Press ◀◀▶▶|▶▶|◀◀ to select the frequency band, then press ▲ / ▼ to enhanced level for the selected frequency band. [-6 to +6]

2 Press number button 5 (**FREQ**), then turn the control dial to select the frequency.

3 Press number button 5 (**Q**), then turn the control dial to select the quality slope (Q).

5 Repeat steps 3 and 4 to adjust the other frequency bands.

6 Store the adjustments.



General settings—PSM

You can change PSM (Preferred Setting Mode) items listed in the table below and on pages 41 and 42.

1 Enter the PSM settings.



2 Select a PSM category.



To display the rest



3 Select a PSM item.



By pressing either one of the buttons repeatedly, you can also move to the item of the other categories.

4 Adjust the selected PSM item.

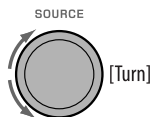

5 Repeat steps 2 – 4 to adjust other PSM items if necessary.

6 Finish the procedure.



Category	Indication	Item (__ : Initial)	Setting, [reference page]
MOV (movie)	Demo Display demonstration	<ul style="list-style-type: none"> • On • Off 	<ul style="list-style-type: none"> : Display demonstration will be activated automatically if no operation is done for about 20 seconds, [7]. : Cancels.
	LevelMeter Audio level meter	<ul style="list-style-type: none"> • Meter 1 • Meter 2 	<ul style="list-style-type: none"> : Select the different level meter patterns. • Press DISP to show the selected level meter.
CLOCK	Clock Disp *1 Clock display	<ul style="list-style-type: none"> • On • Off 	<ul style="list-style-type: none"> : Clock time is shown on the display when the power is turned off. : Cancels; pressing DISP will show the clock time for about 5 seconds when the power is turned off, [7].

*1 If the power supply is not interrupted by turning off the ignition key of your car, it is recommended to select "Off" to save the car's battery.

Category	Indication	Item (__ : Initial)	Setting, [reference page]
CLOCK	Clock Hr Hour adjustment	1 – 12AM/ 1 – 12PM (0 – 23)	: Initial: 1 (1:00AM), [7].
	Clock Min Minute adjustment	00 – 59	: Initial: 00 (1:00AM), [7].
	24H/12H Time display mode	<ul style="list-style-type: none"> • 12Hours • 24Hours 	: See also page 7 for setting.
DISP (display)	Scroll * ² Scroll	<ul style="list-style-type: none"> • Once • Auto • Off 	<ul style="list-style-type: none"> : Scrolls the track information once. : Repeats scrolling (at 5-second intervals). : Cancels. (Holding DISP can scroll the display regardless of the setting.)
	Dimmer Dimmer	<ul style="list-style-type: none"> • Auto • Off • On • Time Set 	<ul style="list-style-type: none"> : Dims the display when you turn on the headlights. : Cancels. : Dims the display and button illumination. : Set the timer for dimmer, [43].
	From – To * ³ —	—	: Initial: 6PM – 7AM.
	Contrast Contrast	1 – 8 Initial: 5	: Adjust the display contrast to make the display indications clear and legible.
	LCD Type Display type	<ul style="list-style-type: none"> • Auto • Positive • Negative 	<ul style="list-style-type: none"> : Positive pattern will be selected during the day time*⁴; while negative pattern will be used during the night time*⁴. : Positive pattern of the display. : Negative pattern of the display.
	Tag Tag display	<ul style="list-style-type: none"> • On • Off 	<ul style="list-style-type: none"> : Shows the tag while playing MP3/WMA/WAV tracks. : Cancels.
NTSC/PAL * ⁵ Video format	<ul style="list-style-type: none"> • PAL • NTSC 	<ul style="list-style-type: none"> : Select this if your monitor is of the PAL color system. : Select this if your monitor is of the NTSC color system. 	

*² Some characters or symbols will not be shown correctly (or will be blanked) on the display.

*³ Adjustable only when "Dimmer" is set to "Time Set."

*⁴ Depends on the "Dimmer" setting.

*⁵ The newly selected video format takes effect only after you turn on the power again or change the source.

Continued on the next page

Category	Indication	Item (__ : Initial)	Setting, [reference page]
TUNER	IF Band Intermediate frequency band	• Auto	: Increases the tuner selectivity to reduce interference noises between adjacent stations. (Stereo effect may be lost.)
		• Wide	: Subject to interference noises from adjacent stations, but sound quality will not be degraded and the stereo effect will remain.
AUDIO	Ext Input* ⁶ External input	• Changer • Ext In	: To use a JVC CD changer, [31], or an Apple iPod, [32]. : To use any other external component, [36].
	AudioBooks* ⁷ Speed control of "Audiobook"	• Normal • Faster • Slower	: You can select the playback speed of the "Audiobook" sound file in your iPod. • Initial selected item depends on your iPod setting.
	Amp Gain Amplifier gain control	• High PWR • Low PWR	: Volume 00 – Volume 50 : Volume 00 – Volume 30 (Select if the maximum power of each speaker is less than 50 W to prevent damaging the speaker.)
	Rear Spk* ⁸ Rear speaker output	• On • Off	: Select this to turn on the rear speaker output. : Cancels.
COLOR	Color Sel Color selection	Initial: All Source; Color: Pale	: Select your favorite display color for each source (or for all sources), [43, 44].
	Color Set Color setting	—	: Create your own colors, and select them for the display color, [44].
	Red	Day Color NightColor 00 — 11	: User color during the day time* ⁹ . : User color during the night time* ⁹ . : Initial: Day Color: 07, NightColor: 05
	Green	00 — 11	: Initial: Day Color: 07, NightColor: 05
Blue	00 — 11	: Initial: Day Color: 07, NightColor: 05	
	Key Illum Illumination switch	• Red • Green	: You can select some of the buttons illumination according to your preference.

*⁶ Displayed only when one of the following sources is selected—TUNER, DISC, USB, USB-iPod, LINE IN, AV IN, or Bluetooth.

*⁷ Displayed only when an iPod is connected to the USB input jack and playback is controlled from the unit.

*⁸ Displayed only when Dual Zone is activated (see page 25).

*⁹ Depends on the "Dimmer" setting.

Setting the time for dimmer

- When **BACK** is shown on the display, you can move back to the previous screen by pressing number button 3.

1 Follow steps 1 to 3 on page 40.

- In step 2, select "DISP."
- In step 3, select "Dimmer."

2 Select "Time Set."

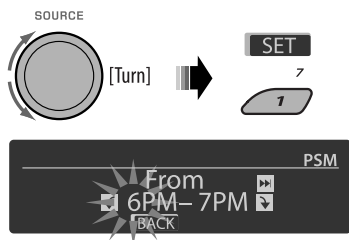

3 Adjust the dimmer start time.

- Turn the control dial to set the dimmer start time.
- Press **▶▶** **▲** to select "To." Then, turn the control dial to set the dimmer end time.

4 Exit from the setting.



Changing the display color

You can select your favorite display color for each source (or all sources).

- When **BACK** is shown on the display, you can move back to the previous screen by pressing number button 3 or 6.

Setting the display color

1 Follow steps 1 to 3 on page 40.

- In step 2, select "COLOR."
- In step 3, select "Color Sel."

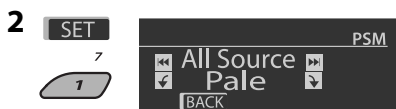

3 Select a source.



All Source*1 ↔ **DISC** ↔ **Changer***3 (or **Ext In***2) ↔ **Line In** ↔ **USB***3 ↔ **FM**
↔ **AM** ↔ **iPod***3 ↔ **BT Phone***3 ↔ **BT Audio***3 ↔ **AV In** ↔ (back to the beginning)

*1 When you select "All Source," you can use the same color for all the sources.

*2 Depends on the "Ext Input" setting, see page 42.

*3 Displayed only when the target component is connected.

4 Select a color.

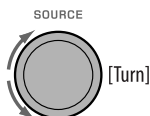

Pale ↔ Aqua ↔ Sky ↔ Sea ↔ Leaves
↔ Grass ↔ Apple ↔ Rose ↔ Amber ↔
Honey ↔ Violet ↔ Grape ↔ Every*⁴ ↔
User*⁵ ↔ (back to the beginning)

*⁴ The color changes every 2 seconds.

*⁵ The user-edited colors—"Day Color" and "NightColor" will be applied (see the right column for details).

5 Repeat steps 3 and 4 to select the color for each source (except when selecting "All Source" in step 3).

6 Exit from the setting.



Creating your own color—User Color

You can create your own colors—"Day Color" or "NightColor."

1 Follow steps 1 to 3 on page 40.

- In step 2, select "COLOR."
- In step 3, select "Color Set."

2 Select "Day Color" or "NightColor."

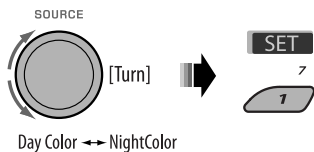

3 Select a primary color.



4 Adjust the level (00 to 11) of the selected primary color.



5 Repeat steps 3 and 4 to adjust other primary colors.

6 Exit from the setting.



Disc setup menu

These operations are possible on the monitor using the remote controller.

1 Enter the disc setup menu while stop.

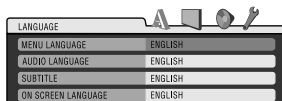

2 Select a menu.

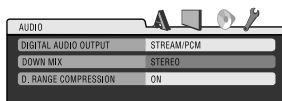
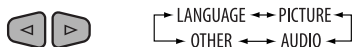

3 Select an item you want to set up.

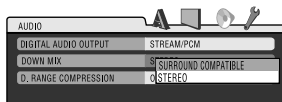



- To cancel pop-up menu, press RETURN.

4 Select an option.



To return to normal screen



Menu	Item	Setting
LANGUAGE	MENU LANGUAGE	Select the initial disc menu language. Refer also to "Language codes" on page 57.
	AUDIO LANGUAGE	Select the initial audio language. Refer also to "Language codes" on page 57.
	SUBTITLE	Select the initial subtitle language or remove the subtitle (OFF). Refer also to "Language codes" on page 57.
	ON SCREEN LANGUAGE	Select the language for the on screen display.
PICTURE	MONITOR TYPE	Select the monitor type to watch a wide screen picture on your monitor. <div style="display: flex; justify-content: space-around; margin-top: 10px;"> <div style="text-align: center;"> <p>16:9</p>  </div> <div style="text-align: center;"> <p>4:3 LETTERBOX</p>  </div> <div style="text-align: center;"> <p>4:3 PAN SCAN</p>  </div> </div>

Continued on the next page

Menu	Item	Setting
PICTURE	OSD POSITION	Select the on-screen bar position on the monitor. <ul style="list-style-type: none"> • 1 : Higher position • 2 : Lower position (Guidance below the disc setup menu will disappear.)
AUDIO	DIGITAL AUDIO OUTPUT	Select the signal format to be emitted through the DIGITAL OUT (Optical) terminal. <ul style="list-style-type: none"> • OFF : Cancels. • PCM ONLY : Select for an amplifier or a decoder incompatible with Dolby Digital, DTS, MPEG Audio, or when connecting to a recording device. • DOLBY DIGITAL/PCM : Select for an amplifier or a decoder compatible with Dolby Digital. • STREAM/PCM : Select for an amplifier or a decoder compatible with Dolby Digital, DTS, and MPEG Audio.
	DOWN MIX	When playing back a multi-channel disc, this setting affects the signals reproduced through the LINE OUT jacks (and through the DIGITAL OUT terminal when "PCM ONLY" is selected for "DIGITAL AUDIO OUTPUT"). <ul style="list-style-type: none"> • SURROUND COMPATIBLE : Select to enjoy multi-channel surround audio by connecting an amplifier compatible with Dolby Surround. • STEREO : Normally select this.
	D. RANGE COMPRESSION	You can enjoy a powerful sound at low or middle volume levels while playing a Dolby Digital software. <ul style="list-style-type: none"> • AUTO : Select to apply the effect to multi-channel encoded software (excluding 1-channel and 2-channel software). • ON : Select to always use this function.
OTHER	DivX REGISTRATION	This unit has its own Registration Code. Once you have played back a disc in which the Registration Code recorded, this unit's Registration Code is overwritten for copyright protection.
	FILE TYPE (DISC)	Select playback file type when a disc contains different types of files. <ul style="list-style-type: none"> • AUDIO : Play MP3/WMA/WAV files. • VIDEO : Play DivX/MPEG Video files. • AUDIO + VIDEO : Play MP3/WMA/WAV/DivX/MPEG Video files.
	FILE TYPE (USB)	Select playback file type when a USB contains different types of files. <ul style="list-style-type: none"> • AUDIO : Play MP3/WMA/WAV files. • VIDEO : Play DivX/MPEG Video files. • AUDIO + VIDEO : Play MP3/WMA/WAV/DivX/MPEG Video files.

Bluetooth settings

You can change the settings listed on the right column according to your preference.

- When **BACK** is shown on the display, you can move back to the previous screen by pressing number button 3.

1 Select "BT-PHONE" or "BT-AUDIO."

SOURCE



2 Enter the Bluetooth menu.

MODE



3 Select "Setting."



4 Select a setting item.

SOURCE



[Turn]

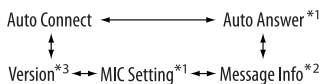

*1 Displayed only when a Bluetooth phone is connected.

*2 Appears only when a Bluetooth phone is connected and it is compatible with text message (notified through JVC Bluetooth adapter).

*3 Bluetooth Audio: Shows only "Version."

5 Change the setting accordingly.

SOURCE



[Turn]



Setting menu (_ : Initial)

Auto Connect

When the unit is turned on, the connection is established automatically with...

Off: No Bluetooth device.

Last: The last connected Bluetooth device.

Order: The available registered Bluetooth device found at first.

Auto Answer

Only for the device being connected for "BT-PHONE."

On: The unit answers the incoming calls automatically.

Off: The unit does not answer the calls automatically. Answer the calls manually.

Reject: The unit rejects all incoming calls.

Message Info

Only for the device being connected for "BT-PHONE."

Auto: The unit informs you of the arrival of a message by ringing and displaying "Received Message."

Manual: The unit does not inform you of the arrival of a message.

MIC setting (microphone setting)

Only for the device being connected for "BT-PHONE."
Adjust the built-in microphone volume, [LEVEL 01/02/03].

Version

The Bluetooth software and hardware versions are shown.

Title assignment

You can assign titles to 30 station frequencies (FM and AM) using 10 characters (maximum) for each title.

- When **BACK** is shown on the display, you can move back to the previous screen by pressing number button 3.

1 Select "TUNER."

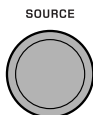

2 Show the title entry screen.

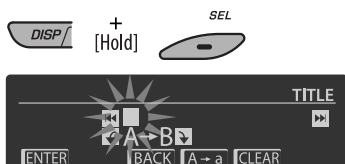

3 Assign a title.

- Press number button 4 (**A → a**) repeatedly to select a character set.

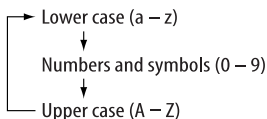

- Turn the control dial to select a character. (For available characters, see the right column.)
- Use **◀◀◀/▶▶▶** to move to the next (or previous) character position.
- Repeat steps **1**) to **3**) until you finish entering the title.

4 Store the title.



To erase the entire title

In step **3** on the left column...



Available characters

Upper case

A	B	C	D	E	F	G	H	I	J	K	L	M	N
O	P	Q	R	S	T	U	V	W	X	Y	Z	space	

Lower case

a	b	c	d	e	f	g	h	i	j	k	l	m	n
o	p	q	r	s	t	u	v	w	x	y	z	space	

Numbers and symbols

0	1	2	3	4	5	6	7	8	9	!	"	#	\$
%	&	'	(*	+	-	.	/	:	;	<		
=	>	?	@	_	`	space							

Maintenance

How to clean the connectors

Frequent detachment will deteriorate the connectors. To minimize this possibility, periodically wipe the connectors with a cotton swab or cloth moistened with alcohol, being careful not to damage the connectors.

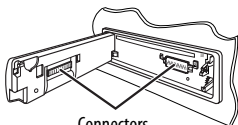

Connectors

Moisture condensation

Moisture may condense on the lens inside the unit in the following cases:

- After starting the heater in the car.
- If it becomes very humid inside the car.

Should this occur, the unit may malfunction. In this case, eject the disc and leave the unit turned on for a few hours until the moisture has evaporated.

How to handle discs

When removing a disc from its case, press down the center holder of the case and lift the disc out, holding it by the edges.

Center holder



- Always hold the disc by the edges. Do not touch its recording surface.

When storing a disc in its case, gently insert the disc around the center holder (with the printed surface facing up).

- Make sure to store discs in cases after use.

To keep discs clean

A dirty disc may not play correctly. If a disc does become dirty, wipe it with a soft cloth in a straight line from center to edge.



- Do not use any solvents (for example, conventional record cleaner, spray, thinner, benzene, etc.) to clean discs.

To play new discs

New discs may have some rough spots around the inner and outer edges. If such a disc is used, this unit may reject the disc.



To remove these rough spots, rub the edges with a pencil or ball-point pen, etc.

Do not use the following discs:

Single CD (8 cm disc)



Warped disc



Sticker and sticker residue



Stick-on label



Unusual shape



C-thru Disc (semi-transparent disc)



Transparent or semi-transparent parts on its recording area



More about this unit

■ Basic operations

Turning on the power

- By pressing SOURCE on the unit, you can also turn on the power. If the source is ready, playback also starts.

Turning off the power

- If you turn off the power while listening to a track, playback will start from where it had been stopped previously next time you turn on the power.

General

- If you change the source while listening to a disc, playback stops. Next time you select "DISC" as the playback source, playback will start from where it had been stopped previously.
- After ejecting a disc or removing a USB device, "No Disc" or "No USB" appears and you cannot operate some of the buttons. Insert another disc, reattach a USB device, or press SOURCE to select another playback source.

■ Tuner operations

Storing stations in memory

- During SSM search...
 - All previously stored stations are erased and the stations are stored anew.
 - Received stations are preset in No. 1 (lowest frequency) to No. 6 (highest frequency).
 - When SSM is over, the station stored in No. 1 will be automatically tuned in.
- When storing a station manually, the previously preset station is erased when a new station is stored in the same preset number.

■ Disc operations

General

- In this manual, words "track" and "file" are interchangeably used.
- This unit can only play back audio CD (CD-DA) files if different type of files are recorded in the same disc.

Inserting a disc

- When a disc is inserted upside down, "Please Eject" appears on the display. Press OPEN, then ▲ to eject the disc.

Ejecting a disc

- If the ejected disc is not removed within 15 seconds, the disc is automatically inserted again into the loading slot to protect it from dust. Playback starts automatically.
- After ejecting a disc, "NO DISC" appears and you cannot operate some of the buttons. Insert another disc or press SOURCE to select another playback source.

Playing Recordable/Rewritable discs

- This unit can recognize a total of 5 000 files and 250 folders (a maximum of 999 files per folder).
- This unit can recognize a total 25 characters for file/folder names.
- Use only "finalized" discs.
- This unit can play back multi-session discs; however, unclosed sessions will be skipped while playing.
- This unit may be unable to play back some discs or files due to their characteristics or recording conditions.
- Rewritable discs may require a longer readout time.

Playing DVD-VR files

- For details about DVD-VR format and playlist, refer to the instructions supplied with the recording equipment.

Playing MP3/WMA/WAV files

- The maximum number of characters for folder and file names is 25 characters; 128 characters for MP3/WAV and 64 characters for WMA tag information.
- This unit can play back files with the extension code <.mp3>, <.wma>, or <.wav> (regardless of the letter case—upper/lower).
- This unit can show the names of albums, artists (performer), and Tag (Version 1.0, 1.1, 2.2, 2.3, or 2.4) for the MP3/WMA/WAV files.
- This unit can display only one-byte characters. No other characters can be correctly displayed.
- This unit can play back files recorded in VBR (variable bit rate).
Files recorded in VBR have a discrepancy in elapsed time indication.
- This unit cannot play back the following files:
 - MP3 files encoded with MP3i and MP3 PRO format.
 - MP3 files encoded with Layer 1/2.
 - WMA files encoded with lossless, professional, and voice format.
 - WMA files which are not based upon Windows Media® Audio.
 - WMA files copy-protected with DRM.
 - Files which have the data such as ATRAC3, etc.
 - AAC files and OGG files.

Playing DivX files

- This unit can play back DivX files with the extension code <.divx>, <.div>, <.avi> (regardless of the letter case—upper/lower).
- This unit supports DivX Media Format files, <.divx> or <.avi>.
- This unit can display a unique registration code—DivX Video-on-Demand (VOD—a kind of Digital Rights Management). For activation and more details, visit <www.divx.com/vod>.

- Audio stream should conform to MP3 or Dolby Digital.
- This unit does not support GMC (Global Motion Compression).
- The file encoded in the interlaced scanning mode may not be played back correctly.
- This unit cannot play back the following files:
 - Files encoded in Codec (Compressor-decompressor) other than DivX Codec.
- The maximum bit rate for video signals (average) is 4 Mbps.
- If you want to know more about DivX, visit <<http://www.divx.com>>.

Playing MPEG Video files

- This unit can play back MPEG Video files with the extension code <.mpg>, <.mpeg>, or <.mod>*.
* <.mod> is an extension code used for the MPEG-2 files recorded by JVC Everio camcorders.
- Audio stream should conform to MPEG1 Audio Layer 2.
- This unit cannot playback the following files:
 - WMV (Windows Media Video) files
 - RM (Real Media) format files
- The maximum bit rate for video signals (average) is 4 Mbps.

Changing the source

- If you change the source, playback also stops (without ejecting the disc).
Next time you select “DISC” for the playback source, disc play starts from where it has been stopped previously.



■ USB operations

- Connecting a USB device automatically changes the source to “USB.”
- While playing from a USB device, the playback order may differ from the one from other players.
- This unit may be unable to play back some USB devices or some files due to their characteristics or recording conditions.

Continued on the next page







- Depending on the shape of the USB devices and connection ports, some USB devices may not be attached properly or the connection might be loose.
 - When connecting a USB mass storage class device, refer also to its instructions.
 - Connect one USB mass storage class device to the unit at a time. Do not use a USB hub.
 - This unit is compatible with the USB Full-Speed.
 - If the connected USB device does not have the correct files, "No File" appears.
 - This unit can play back MP3 files recorded in VBR (variable bit rate).
 - The maximum number of characters for folder and file names is 25 characters; 128 characters for MP3/WAV and 64 characters for WMA Tag information.
 - This unit can recognize a total of 5 000 files and 250 folders (999 files per folder).
 - The unit cannot recognize a USB mass storage class device whose rating is other than 5 V and exceeds 500 mA.
 - USB devices equipped with special functions such as data security functions cannot be used with the unit.
 - Do not use a USB device with 2 or more partitions.
 - This unit may not recognize a USB device connected through a USB card reader.
 - This unit may not play back files in a USB device properly when using a USB extension cord.
 - This unit cannot assure proper functions or supply power to all types of USB devices.
 - For MPEG1/2 files: The maximum bit rate for video signals (average) is 2 Mbps.
- Connecting condition may vary depending on the circumstances around you.
 - When the unit is turned off, the device is disconnected.

 appears when the connection is established.

	Appears when the Bluetooth phone is connected.
	Appears when the Bluetooth audio player is connected.
	Appears when the Bluetooth phone and Bluetooth audio player are connected.

Icons for phone types

These icons indicate the phone type set on the device:

	: Cellular phone		: General
	: Household phone		: Other than above
	: Office		: Unknown

Warning messages for Bluetooth operations

- Connection Error:**
The device is registered but the connection has failed. Use "Connect" to connect the device again. (See page 27.)
- Error**
Try the operation again. If "Error" appears again, check if the device supports the function you have tried.
- Device not found**
No available Bluetooth device is detected by "Search...".
- Loading...**
The unit is updating the phone book and/or text messages.

Bluetooth operations

General

- While driving, do not perform complicated operation such as dialing the numbers, using phone book, etc. Stop your car in a safe place before you perform these operations.
- Some Bluetooth devices may not be connected to this unit depending on the Bluetooth version of the device.
- This unit may not work for some Bluetooth devices.

- **Please Wait...**

The unit is preparing to use the Bluetooth function. If the message does not disappear, turn off and turn on the unit, then connect the device again (or reset the unit).

- **Reset 08**

Check the connection between the adapter and this unit.

iPod

- Controllable iPod (connected through...):

(A) KS-PD100:

- iPod with dock connector (3rd Generation)
- iPod with click wheel (4th Generation)
- iPod nano (1st & 2nd*¹ Generation)
- iPod mini (1st Generation)
- iPod video (5th Generation)*²
- iPod photo

(B) USB input jack:

- iPod nano (1st & 2nd Generation)
- iPod video (5th Generation)*³

*¹ *When you connect the iPod nano to the interface adapter, be sure to disconnect the headphones; otherwise, no sound is heard.*

*² *It is not possible to browse video files on the "Videos" menu while the iPod is connected to the interface adapter.*

*³ *To watch the video with its audio, connect the iPod using USB Audio and Video cable (not supplied).*

- Update your iPod to the latest software version before using it with this unit.
 - You can check the software version of your iPod under "About" in the "Setting" menu of the iPod.
 - For details about updating your iPod, visit <<http://www.apple.com>>.
- While the unit is being turned on, the iPod is charged through this unit.

- iPod shuffle and iPhone cannot be used with this unit.
- You can control the iPod from this unit when "JVC" or "✓" appears on the iPod display after connection.
- The song order displayed on the selection menu of this unit may differ from that of the iPod.
- If playback is stopped, select a track from the selection menu or press ►/|| (BAND) to play back the same track again.
- The text information may not be displayed correctly:
 - Some characters such as accented letters cannot be shown correctly on the display.
 - Depends on the condition of communication between the iPod and the unit.
- If the text information includes more than 16 characters, it scrolls on the display. This unit can display up to 128 characters.

Notice:

When operating an iPod, some operations may not be performed correctly or as intended. In this case, visit the following JVC web site:

- For the USB connection: <<http://www.jvc-victor.co.jp/english/car/>>
- For the interface adapter connection: <<http://www.jvc.co.jp/english/car/support/ks-pd100/index.html>>

Title assignment

- If you try to assign titles to more than 30 station frequencies, "Name Full" appears. Delete unwanted titles before assignment.

Continued on the next page

■ General settings—PSM

- “Auto” setting for “Dimmer” may not work correctly on some vehicles, particularly on those having a control dial for dimming.
In this case, change the “Dimmer” setting to any other than “Auto.”
- If “LCD Type” is set to “Auto,” the display pattern will change to the “Positive” or “Negative” pattern depending on the “Dimmer” setting.
- If you change the “Amp Gain” setting from “High PWR” to “Low PWR” while the volume level is set higher than “Volume 30,” the unit automatically changes the volume level to “Volume 30.”

■ Disc setup menu

- When the language you have selected is not recorded on a disc, the original language is automatically used as the initial language. In addition, for some discs, the initial languages settings will not work as you set due to their internal disc programming.
- When you select “16:9” for a picture whose aspect ratio is 4:3, the picture slightly changes due to the process for converting the picture width.
- Even if “4:3 PAN SCAN” is selected, the screen size may become “4:3 LETTERBOX” for some discs.

About sounds reproduced through the rear terminals







- **Through the analog terminals (Speaker out/ LINE OUT):**
2-channel signal is emitted. When playing a multi-channel encoded disc, multi-channel signals are downmixed. DTS sound cannot be reproduced. (AUDIO—DOWN MIX: see page 46.)
- **Through DIGITAL OUT (optical):**
Digital signals (Linear PCM, Dolby Digital, DTS, MPEG Audio) are emitted through this terminal. (For more details, see table on page 56.)
To reproduce multi-channel sounds such as Dolby Digital, DTS, and MPEG Audio, connect an amplifier or a decoder compatible with these multi-channel sources to this terminal, and set “DIGITAL AUDIO OUTPUT” correctly. (See page 46.)
- **About Dual Zone:**
Through the 2nd AUDIO OUT, 2-channel signal is emitted. When playing a multi-channel encoded disc, multi-channel signals are downmixed. (See page 25.)

Adjustable sound elements



Sound elements	Range/selectable items				
	Band 1 (100 Hz)	Band 2 (320 Hz)	Band 3 (1 kHz)	Band 4 (3.2 kHz)	Band 5 (10 kHz)
Frequency	68 Hz 100 Hz 150 Hz	210 Hz 320 kHz 460 kHz	680 Hz 1 kHz 1.5 kHz	2.1 kHz 3.2 kHz 4.6 kHz	6.8 kHz 10 kHz 15 kHz
Level	-6 to +6	-6 to +6	-6 to +6	-6 to +6	-6 to +6
Q (Q-slope)	Q0.7 Q1.0 Q1.4 Q2.0	Q0.7 Q1.0 Q1.4 Q2.0	Q0.7 Q1.0 Q1.4 Q2.0	Q0.7 Q1.0 Q1.4 Q2.0	Q0.7 Q1.0 Q1.4 Q2.0

On-screen guide icons

During playback, the following guide icons may appear for a while on the monitor.

-  : Playback
-  : Pause
-  : DVD-Video/VCD: Forward slow motion
-  : DVD-Video: Reverse slow motion
-  : Forward search
-  : Reverse search

DVD: The following icons appear at the beginning of a scene containing:

-  : Multi-subtitle languages
-  : Multi-audio languages
-  : Multi-angle views

- Manufactured under license from Dolby Laboratories. Dolby and the double-D symbol are trademarks of Dolby Laboratories.
- “DTS” and “DTS Digital Out” are registered trademarks of DTS, Inc.
- “DVD Logo” is a trademark of DVD Format/Logo Licensing Corporation registered in the US, Japan and other countries.
- DivX, DivX Ultra Certified, and associated logos are trademarks of DivX, Inc. and are used under license.
- Official DivX® Ultra Certified product
- Plays all versions of DivX® video (including DivX® 6) with enhanced playback of DivX® media files and the DivX® Media Format
- Microsoft and Windows Media are either registered trademarks or trademarks of Microsoft Corporation in the United States and/or other countries.
- The Bluetooth word mark and logos are owned by the Bluetooth SIG, Inc. and any use of such marks by Victor Company of Japan, Limited (JVC) is under license. Other trademarks and trade names are those of their respective owners.
- iPod is a trademark of Apple Inc., registered in the U.S. and other countries.
- This product incorporates copyright protection technology that is protected by U.S. patents and other intellectual property rights. Use of this copyright protection technology must be authorized by Macrovision, and is intended for home and other limited viewing uses only unless otherwise authorized by Macrovision. Reverse engineering or disassembly is prohibited.

Continued on the next page

Output signals through the DIGITAL OUT terminal

Output signals are different depending on the "DIGITAL AUDIO OUTPUT" setting on the setup menu (see page 46).

Playback Disc	Output Signal				
	STREAM/PCM	DOLBY DIGITAL/ PCM	PCM ONLY	OFF	
DVD-Video	48 kHz, 16/20/24 bits Linear PCM	48 kHz, 16 bits stereo Linear PCM *			
	96 kHz Linear PCM	48 kHz, 16 bits stereo Linear PCM			
	Dolby Digital	Dolby Digital bitstream		48 kHz, 16 bits stereo Linear PCM	
	DTS	DTS bitstream	48 kHz, 16 bits stereo Linear PCM		
	MPEG Audio	MPEG bitstream	48 kHz, 16 bits stereo Linear PCM		
Audio CD, Video CD	44.1 kHz, 16 bits stereo Linear PCM / 48 kHz, 16 bits stereo Linear PCM			OFF	
Audio CD with DTS	DTS bitstream	48 kHz, 16 bits stereo Linear PCM			
DivX/ MPEG	Dolby Digital	Dolby Digital bitstream			48 kHz, 16 bits stereo Linear PCM
	MPEG Audio	32/44.1/48 kHz, 16 bits Linear PCM			
MP3/WMA	32/44.1/48 kHz, 16 bits Linear PCM				
WAV	44.1 kHz, 16 bits stereo Linear PCM				

* Digital signals may be emitted at 20 or 24 bits (at their original bit rate) through the DIGITAL OUT terminal if the discs are not copy-protected.

Language codes

Code	Language	Code	Language	Code	Language	Code	Language	Code	Language
AA	Afar	FA	Persian	KK	Kazakh	NO	Norwegian	ST	Sesotho
AB	Abkhazian	FI	Finnish	KL	Greenlandic	OC	Occitan	SU	Sundanese
AF	Afrikaans	FJ	Fiji	KM	Cambodian	OM	(Afan) Oromo	SW	Swahili
AM	Ameharic	FO	Faroese	KN	Kannada	OR	Oriya	TA	Tamil
AR	Arabic	FY	Frisian	KO	Korean (KOR)	PA	Panjabi	TE	Telugu
AS	Assamese	GA	Irish	KS	Kashmiri	PL	Polish	TG	Tajik
AY	Aymara	GD	Scots Gaelic	KU	Kurdish	PS	Pashto, Pushto	TH	Thai
AZ	Azerbaijani	GL	Galician	KY	Kirghiz	QU	Quechua	TI	Tigrinya
BA	Bashkir	GN	Guarani	LA	Latin	RM	Rhaeto-Romance	TK	Turkmen
BE	Byelorussian	GU	Gujarati	LN	Lingala	RN	Kirundi	TL	Tagalog
BG	Bulgarian	HA	Hausa	LO	Laothian	RO	Rumanian	TN	Setswana
BH	Bihari	HI	Hindi	LT	Lithuanian	RW	Kinyarwanda	TO	Tonga
BI	Bislama	HR	Croatian	LV	Latvian, Lettish	SA	Sanskrit	TR	Turkish
BN	Bengali, Bangla	HU	Hungarian	MG	Malagasy	SD	Sindhi	TS	Tsonga
BO	Tibetan	HY	Armenian	MI	Maori	SG	Sangho	TT	Tatar
BR	Breton	IA	Interlingua	MK	Macedonian	SH	Serbo-Croatian	TW	Twi
CA	Catalan	IE	Interlingue	ML	Malayalam	SI	Singhalese	UK	Ukrainian
CO	Corsican	IK	Inupiak	MN	Mongolian	SK	Slovak	UR	Urdu
CS	Czech	IN	Indonesian	MO	Moldavian	SL	Slovenian	UZ	Uzbek
CY	Welsh	IS	Icelandic	MR	Marathi	SM	Samoan	VI	Vietnamese
DZ	Bhutani	IW	Hebrew	MS	Malay (MAY)	SN	Shona	VO	Volapuk
EL	Greek	JA	Japanese	MT	Maltese	SO	Somali	WO	Wolof
EO	Esperanto	JI	Yiddish	MY	Burmese	SQ	Albanian	XH	Xhosa
ET	Estonian	JW	Javanese	NA	Nauru	SR	Serbian	YO	Yoruba
EU	Basque	KA	Georgian	NE	Nepali	SS	Siswati	ZU	Zulu

Troubleshooting

What appears to be trouble is not always serious. Check the following points before calling a service center.

	Symptom	Remedy/Cause
General	• Sound cannot be heard from the speakers.	<ul style="list-style-type: none"> • Adjust the volume to the optimum level. • Check the cords and connections.
	• The unit does not work at all.	Reset the unit (see page 3).
	• “Connect Error” appears on the display.	Remove the control panel, wipe the connector, then attach it again (see page 4).
FM/AM	• SSM automatic presetting does not work.	Store stations manually.
	• Static noise while listening to the radio.	Connect the antenna firmly.
Discs in general	• Disc cannot be played back.	Insert the disc correctly.
	• Disc can be neither played back nor ejected.	<ul style="list-style-type: none"> • Unlock the disc (see page 14). • Eject the disc forcibly (see page 3).
	• Recordable/Rewritable discs cannot be played back.	<ul style="list-style-type: none"> • Insert a finalized disc. • Finalize the discs with the component which you have used for recording.
	• Tracks on the Recordable/Rewritable discs cannot be skipped.	
	• Disc cannot be recognized.	Eject the disc forcibly (see page 3).
	• Sound and pictures are sometimes interrupted or distorted.	<ul style="list-style-type: none"> • Stop playback while driving on rough roads. • Change the disc. • Check the cords and connections.
	• No playback picture (DVD-Video/DivX/MPEG/VCD) appears on the monitor.	Parking brake wire is not connected properly. (See Installation/Connection Manual.)
	• No picture appears on the monitor at all.	<ul style="list-style-type: none"> • Connect the video cord correctly. • Select a correct input on the monitor.
	• The monitor shows black and white wavy pictures (DVD-Video/DivX/MPEG/VCD).	Select an appropriate video format (PAL/NTSC) for your monitor (see page 41).
• The left and right edges of the picture are missing on the monitor.	Select “4:3 LETTERBOX” (see page 45).	

	Symptom	Remedy/Cause
DivX/MPEG Video/MP3/WMA/WAV	<ul style="list-style-type: none"> Disc cannot be played back. 	<ul style="list-style-type: none"> Change the disc. Record the tracks using a compliant application in the appropriate discs (see page 6). Add the extension code <.divx>, <.div>, <.avi>, <.mpg>, <.mpeg>, <.mp3>, <.wma>, or <.wav> to the file names.
	<ul style="list-style-type: none"> Noise is generated. 	Skip to another track or change the disc.
	<ul style="list-style-type: none"> Tracks cannot play back as you have intended them to play. 	Playback order is determined when files are recorded.
	<ul style="list-style-type: none"> Longer readout time is required (“Reading” keeps flashing on the display). 	Readout time varies due to the complexity of the folder/file configuration. Do not use too many hierarchies and folders.
	<ul style="list-style-type: none"> No sound can be heard when picture is displayed while playing a DivX/MPEG Video file. 	<ul style="list-style-type: none"> Record the audio track using MP3 or Dolby Digital as the audio stream of DivX files. Record the audio track using MPEG1 Audio Layer 2 as the audio stream for MPEG Video files.
	<ul style="list-style-type: none"> Elapsed playing time is not correct. 	This sometimes occurs during playback. This is caused by how the tracks are recorded.
	<ul style="list-style-type: none"> “Please Eject” appears on the display. 	Insert a disc that contains tracks of appropriate formats.
	<ul style="list-style-type: none"> Correct characters are not displayed (e.g. album name). 	This unit can only display letters (capital: A – Z, small: a – z), numbers, and a limited number of symbols (see page 48).
USB device	<ul style="list-style-type: none"> Noise is generated. 	<ul style="list-style-type: none"> The track played back is not a playable file format (MP3/WMA/WAV). Skip to another file. Do not add the extension code <.mp3>, <.wma>, or <.wav> to non-MP3/WMA/WAV tracks.
	<ul style="list-style-type: none"> Tracks cannot play back as you have intended them to play. 	Playback order may differs from the one played back using other players.
	<ul style="list-style-type: none"> “Reading” keeps flashing on the display. 	<ul style="list-style-type: none"> Readout time varies depending on the USB device. Do not use too many hierarchy, folders and empty folders.* Turn off the power then on again. Do not pull out or connect the USB device repeatedly while “Reading” is displayed on the display. <p>* Folder that is physically empty or folder that contains data but does not contain valid MP3/WMA/WAV track.</p>

Continued on the next page

	Symptom	Remedy/Cause
USB device	<ul style="list-style-type: none"> • “No File” flashes on the display. • “No USB” appears on the display. 	Connect a USB device that contains tracks encoded in an appropriate format.
	• “Not Support” appears on the display and track skips.	The track is unplayable.
	• “Read failed” appears on the display.	The connected USB device may be malfunctioning, or may not have been formatted correctly. The files included in the USB device are corrupted.
	• Correct characters are not displayed (e.g. album name).	For available characters, see page 48.
	• While playing a track, sound is sometimes interrupted.	The tracks have not been properly copied into the USB device. Copy tracks again into the USB device, and try again.
	• The sound is interrupted or skipped during playback of a USB device.	<ul style="list-style-type: none"> • Turn off, then turn on the unit. • Connect the device again, when the sound is not yet restored.
	Bluetooth®	• Bluetooth device does not detect the unit.
• The unit does not detect the Bluetooth device.		<ul style="list-style-type: none"> • Check the Bluetooth setting of the device. • Search from the Bluetooth device. After the device detects the unit, select “Open...” on the unit to connect the device. (See page 26.)
• The unit does not make pairing with the Bluetooth device.		<ul style="list-style-type: none"> • Enter the same PIN code for both the unit and target device. • Select the device name from “Special,” then try to connect again. (See page 27.)
• Phone sound quality is poor.		<ul style="list-style-type: none"> • Reduce the distance between the unit and the Bluetooth cellular phone. • Move the car to a place where you can get a better signal reception.

	Symptom	Remedy/Cause
Bluetooth®	<ul style="list-style-type: none"> The sound is interrupted or skipped during playback of a Bluetooth audio player. 	<ul style="list-style-type: none"> Reduce the distance between the unit and the Bluetooth audio player. Turn off, then turn on the unit. When the sound is not yet restored: Connect the player again.
	<ul style="list-style-type: none"> The connected audio player cannot be controlled. 	Check whether the connected audio player supports AVRCP (Audio Video Remote Control Profile). (Operations depend on the connected audio player.)
CD changer	<ul style="list-style-type: none"> "No Disc" appears on the display. 	Insert a disc into the magazine.
	<ul style="list-style-type: none"> "No Magazine" appears on the display. 	Insert the magazine.
	<ul style="list-style-type: none"> "Reset 08" appears on the display. 	Connect this unit and the CD changer correctly and press the reset button of the CD changer.
	<ul style="list-style-type: none"> "Reset 01" – "Reset 07" appears on the display. 	Press the reset button of the CD changer.
	<ul style="list-style-type: none"> The CD changer does not work at all. 	Reset the unit (see page 3).
iPod	<ul style="list-style-type: none"> The iPod does not turn on or does not work. 	<ul style="list-style-type: none"> Check the connecting cable and its connection. Update the firmware version. Charge the battery.
	<ul style="list-style-type: none"> The sound is distorted. 	Deactivate the equalizer either on this unit or the iPod.
	<ul style="list-style-type: none"> "Disconnect" appears on the display. 	<ul style="list-style-type: none"> Check the connecting cable and its connection. Charge the battery.
	<ul style="list-style-type: none"> Playback stops. 	The headphones are disconnected during playback. Restart the playback operation (see pages 32 and 33).
	<ul style="list-style-type: none"> No sound can be heard when connecting an iPod nano. 	<ul style="list-style-type: none"> Disconnect the headphones from the iPod nano. Update the firmware version of the iPod nano.
	<ul style="list-style-type: none"> "No File" appears on the display. 	No tracks are stored. Import tracks to the iPod.
	<ul style="list-style-type: none"> "Reset 01" – "Reset 07" appears on the display. 	Disconnect the adapter from both this unit and iPod. Then, connect it again.
	<ul style="list-style-type: none"> "Reset 08" appears on the display. 	Check the connection between the adapter and this unit.
	<ul style="list-style-type: none"> The iPod's controls do not work after disconnecting from this unit. 	Reset the iPod.

Specifications

AUDIO AMPLIFIER SECTION	Maximum Power Output:	Front/Rear:	50 W per channel
	Continuous Power Output (RMS):	Front/Rear:	19 W per channel into 4 Ω , 40 Hz to 20 000 Hz at no more than 0.8% total harmonic distortion
	Load Impedance:		4 Ω (4 Ω to 8 Ω allowance)
	Equalizer Control Range:	Frequency:	Band 1: 68 Hz, 100 Hz, 150 Hz Band 2: 210 Hz, 320 Hz, 460 Hz Band 3: 680 Hz, 1 kHz, 1.5 kHz Band 4: 2.1 kHz, 3.2 kHz, 4.6 kHz Band 5: 6.8 kHz, 10 kHz, 15 kHz
		Level:	± 10 dB
	Signal to Noise Ratio:		80 dB
	Audio Output Level:	Digital (DIGITAL OUT: Optical):	Signal wave length: 660 nm Output level: -21 dBm to -15 dBm
		Line-Out Level/Impedance:	2.5 V/20 k Ω load (full scale)
		Output Impedance:	1 k Ω
	Subwoofer-out Level/Impedance:		2.5 V/20 k Ω load (full scale)
	Color system:		PAL/NTSC
	Video Output (composite):		1 Vp-p/75 Ω
	Other Terminal:	CD changer, AV-IN (video) input jack, USB input jack, Antenna input, 2nd AUDIO OUT, LINE IN	
TUNER SECTION	Frequency Range:	FM:	87.5 MHz to 108.0 MHz
		AM:	531 kHz to 1 602 kHz
	FM Tuner:	Usable Sensitivity:	11.3 dBf (1.0 μ V/75 Ω)
		50 dB Quieting Sensitivity:	16.3 dBf (1.8 μ V/75 Ω)
		Alternate Channel Selectivity (400 kHz):	65 dB
		Frequency Response:	40 Hz to 15 000 Hz
		Stereo Separation:	30 dB
	AM Tuner:	Sensitivity:	20 μ V
Selectivity:		35 dB	

DVD/CD PLAYER SECTION	Signal Detection System:		Non-contact optical pickup (semiconductor laser)	
	Number of Channels:		2 channels (stereo)	
	Frequency Response:	DVD, fs=48 kHz/96 kHz:	16 Hz to 22 000 Hz	
		CD, fs=44.1 kHz:	16 Hz to 20 000 Hz	
	Dynamic Range/Signal-to-Noise Ratio:		96 dB/98 dB	
	Wow and Flutter:		Less than measurable limit	
	DivX/MPEG Video:	Video:	Max. Resolution:	720 × 480 pixels (30 fps) 720 × 576 pixels (25 fps)
			Audio:	Bit Rate:
		Sampling Frequency: DivX:		MPEG-1: 32 kHz, 44.1 kHz, 48 kHz MPEG-2: 16 kHz, 22.05 kHz, 24 kHz
		Sampling Frequency: MPEG Video:		32 kHz, 44.1 kHz, 48 kHz
	MP3:		Bit Rate:	32 kbps – 320 kbps
			Sampling Frequency:	MPEG-1: 32 kHz, 44.1 kHz, 48 kHz MPEG-2: 16 kHz, 22.05 kHz, 24 kHz
	WMA:		Bit Rate:	32 kbps – 320 kbps
Sampling Frequency:			22.05 kHz, 32 kHz, 44.1 kHz, 48 kHz	
WAV:		Quantization Bit Rate:	16 bit	
		Sampling Frequency:	44.1 kHz	

USB SECTION	USB Standards:		USB 1.1, USB 2.0
	Data Transfer Rate:	Full Speed:	Maximum 12 Mbps
		Low Speed:	Maximum 1.5 Mbps
	Compatible Device:		Mass storage class
	Compatible File System:		FAT 32/16/12
	Playable Audio Format:		DivX/MPEG1/MPEG2/MP3/WMA/WAV
Max. Current:		500 mA/5 V	

GENERAL	Power Requirement:	Operating Voltage:	DC 14.4 V (11 V to 16 V allowance)
	Grounding System:		Negative ground
	Allowable Operating Temperature:		0°C to +40°C
	Dimensions (W × H × D):	Installation Size (approx.):	182 mm × 52 mm × 159 mm
		Panel Size (approx.):	188 mm × 58 mm × 6 mm
Mass (approx.):		1.5 kg (excluding accessories)	

Design and specifications are subject to change without notice.

**Having TROUBLE with operation?
Please reset your unit**

Refer to page of How to reset your unit

JVC



EN