

This unit is designed to operate on **12 V DC, NEGATIVE ground electrical systems**. If your vehicle does not have this system, a voltage inverter is required, which can be purchased at JVC car audio dealers.

WARNINGS

- DO NOT install any unit or wire any cable in a location where;
 - it may obstruct the steering wheel and gearshift lever operations, as this may result in a traffic accident.
 - it may obstruct the operation of safety devices such as air bags, as this may result in a fatal accident.
 - it may obstruct visibility.
- DO NOT operate any unit while manipulating the steering wheel, as this may result in a traffic accident.
- The driver must not watch the monitor while driving. It may lead to carelessness and cause an accident.
- If you need to operate the unit while driving, be sure to look around carefully or you may be involved in a traffic accident.
- If the parking brake is not engaged, "Parking Brake" appears on the monitor, and no playback picture will be shown.

To prevent short circuits, disconnect the battery's negative terminal and make all electrical connections before installing the unit.

- **Be sure to ground this unit to the car's chassis again after installation.**
- Be sure any cable is not caught on the car's chassis or under seats.

Notes on electrical connections:

- Replace the fuse with one of the specified rating. If the fuse blows frequently, consult your JVC car audio dealer.
- It is recommended to connect speakers with maximum power of more than 50 W (both at the rear and at the front, with an impedance of **4 Ω to 8 Ω**).
- To prevent short circuits, cover the terminals of the UNUSED leads with insulating tape.
- At the time of installation, be sure to fix all wires (wires both from this unit and from the car itself) in a way that no wires can come into contact with heat sinks on the rear and side of the unit.

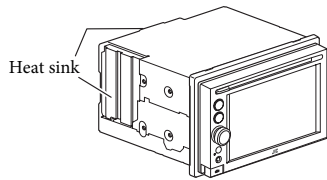

CAUTION: Install this unit in the console of your vehicle. Do not touch the metal parts of this unit during and shortly after the use of the unit. Metal parts such as the heat sink and enclosure become hot.

PRECAUTIONS on power supply and speaker connections:

- **DO NOT connect the speaker leads of the wiring harness to the car battery; otherwise, the unit will be seriously damaged.**
- BEFORE connecting the speaker leads of the wiring harness to the speakers, check the speaker wiring in your car.

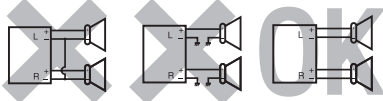

Parts list for installation and connection

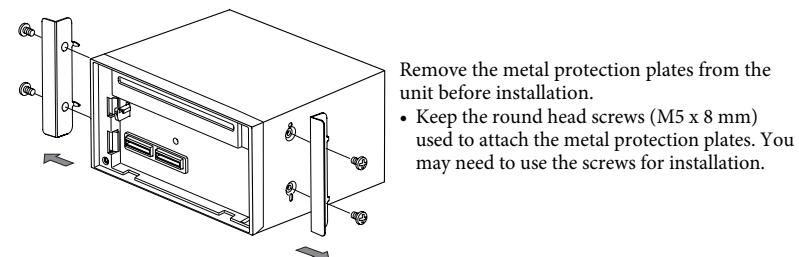
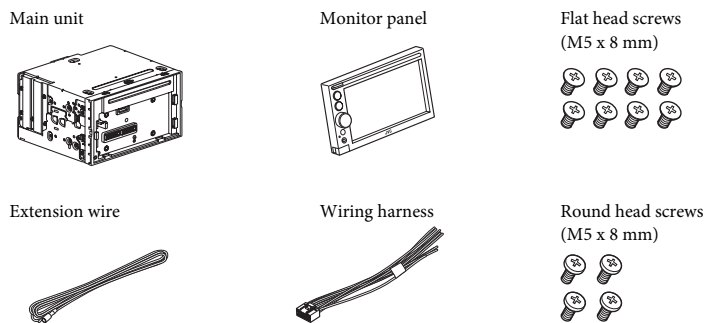

Only for KW-AV61BT

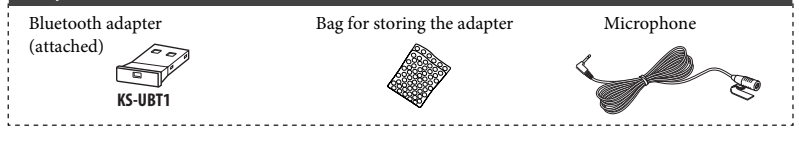

TROUBLESHOOTING

- | | |
|--|---|
| <ul style="list-style-type: none"> • The fuse blows. * Are the red and black leads connected correctly? • Power cannot be turned on. * Is the yellow lead connected? • No sound from the speakers. * Is the speaker output lead short-circuited? • Sound is distorted. * Is the speaker output lead grounded? * Are the "-" terminals of L and R speakers grounded in common? | <ul style="list-style-type: none"> • Noise interfere with sounds. * Is the rear ground terminal connected to the car's chassis using shorter and thicker cords? • This unit becomes hot. * Is the speaker output lead grounded? * Are the "-" terminals of L and R speakers grounded in common? • This unit does not work at all. * Have you reset your unit? |
|--|---|

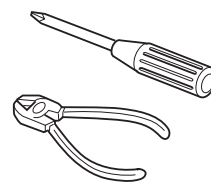

INSTALLATION (IN-DASH MOUNTING)

The following illustration shows a typical installation. However, you should make adjustments corresponding to your specific car. If you have any questions or require information regarding installation kits, consult your JVC car audio dealer or a company supplying kits.

- If you are not sure how to install this unit correctly, have it installed by a qualified technician.

Before installing the unit

- When mounting the unit, be sure to use the screws provided, as instructed. If other screws are used, parts could become loose or damaged.
- When tightening screws or bolts, be careful not to pinch any connection cord.
- Make sure not to block the fan on the rear to maintain proper ventilation when installing the unit.

- 1 Remove the audio system originally installed in the car, together with its mounting brackets.
 - Be sure to keep all the screws and parts removed from your car for future use.
- 2 Attach the mounting brackets (removed from the car) to this unit (see below).
 - Use flat head screws or round head screws, depending on installation location.
 - When you need to use round head screws, use the supplied screws and the screws used to attach the metal protection plates to the unit when shipped.
- 3 Do the required electrical connections.
 - See "ELECTRICAL CONNECTIONS" on pages 1 and 2.
- 4 Install this unit using the screws removed in step 1.
- 5 Attach the monitor panel (see below).

The following example is for installation in a Toyota car. For more details, consult your JVC car audio dealer.

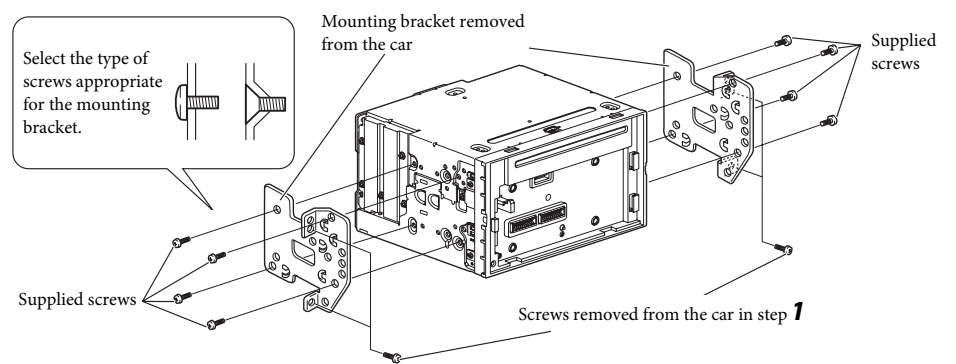

Step 5

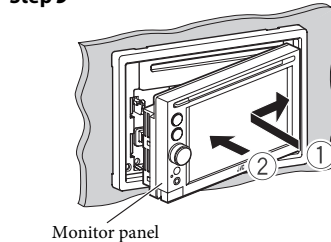

When installing the unit in a Nissan car

If your Nissan car needs a plate, purchase the plate separately.

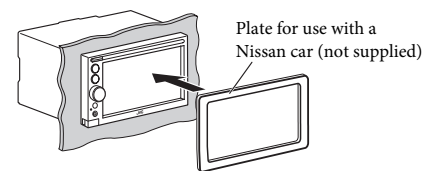

- When you use screws other than those supplied, use 8 mm-long screws. If longer screws are used, they could damage the unit.
- Tighten the screws firmly to prevent the unit from falling off.

If necessary, restore the protruding tabs.

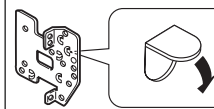

Install the unit at an angle of less than 30°.

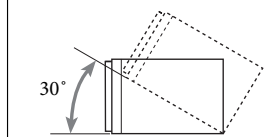

ELECTRICAL CONNECTIONS

Connecting the parking brake lead

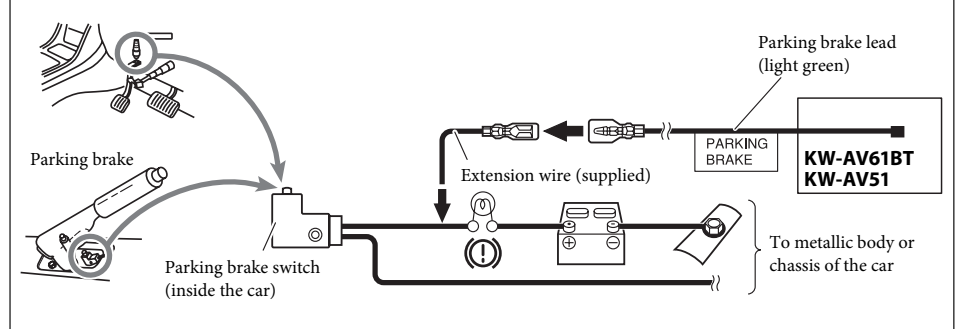

Connecting the reverse gear signal lead (for rear view camera)

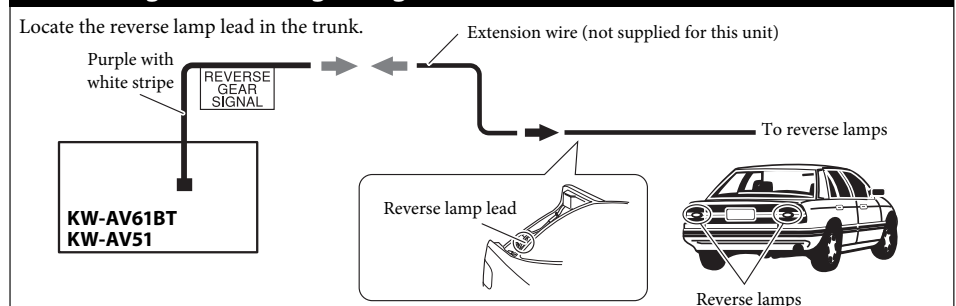

Before connecting: Check the wiring in the vehicle carefully. Incorrect connection may cause serious damage to this unit. The leads of the wiring harness and those of the connector from the car body may be different in color.

The terminals and cables of all models are shown in the illustration for the purpose of explanation.

- 1 Connect the colored leads of the wiring harness in the order specified in the illustration below.
- 2 Connect the antenna cord.
- 3 Finally connect the wiring harness to the unit.

A B C D E F See each diagram below.

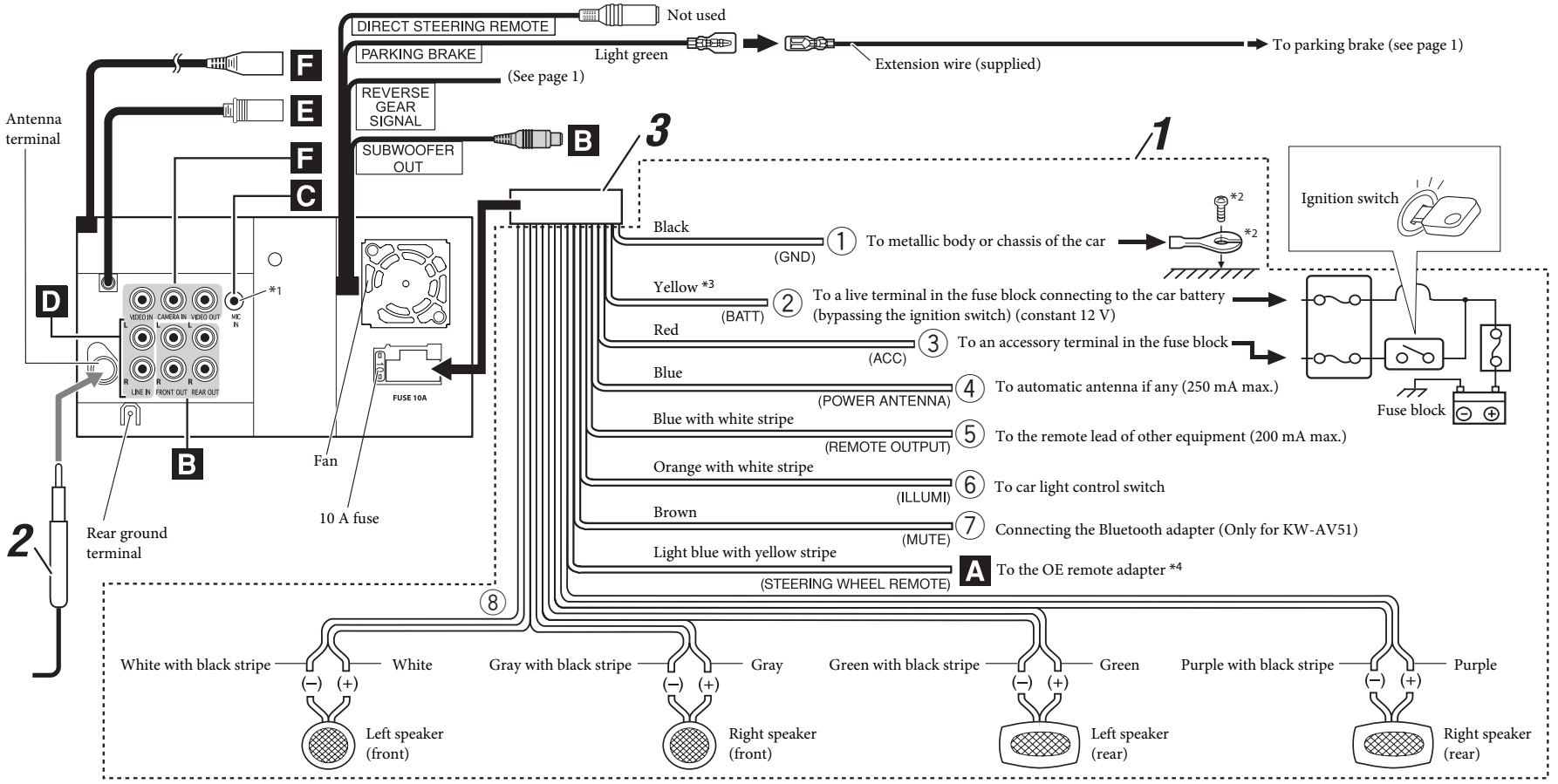

A Connecting to the steering wheel remote controller

If your car is equipped with the steering wheel remote controller, you can operate this unit using the controller. For connection, an exclusive remote adapter (not supplied) which matches your car is required. For details, consult the same car audio dealer as where the unit is purchased.

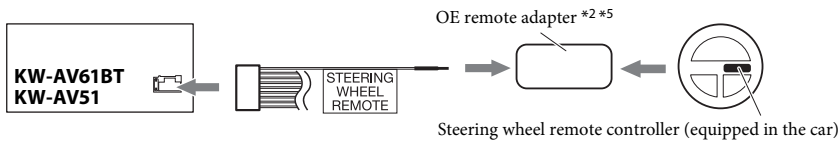

E Connecting an external navigation unit

Connect an external navigation unit to the RGB input terminal. The positional information detected on the touch panel and picture signals from the navigation unit are transferred through the terminal. Refer to the manual of the external navigation unit for details.

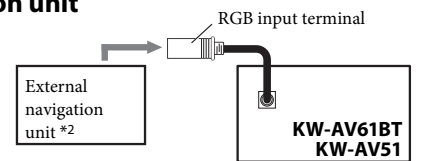

- Please contact your dealer to inquire about compatible navigation units.
- JVC cannot guarantee proper operation of the external devices connected to the RGB input terminal.

B Connecting the external amplifiers and subwoofer

You can connect an amplifier to upgrade your car stereo system.

- Connect the remote lead (blue with white stripe) to the remote lead of the other equipment so that it can be controlled through this unit.
- **Disconnect the speakers from this unit, and connect them to the amplifier. Leave the speaker leads of this unit unused.**
- You can switch off the built-in amplifier and send the audio signals only to the external amplifier(s) to get clear sounds and to prevent internal heat built-up inside the unit. See page 43 of the INSTRUCTION MANUAL.

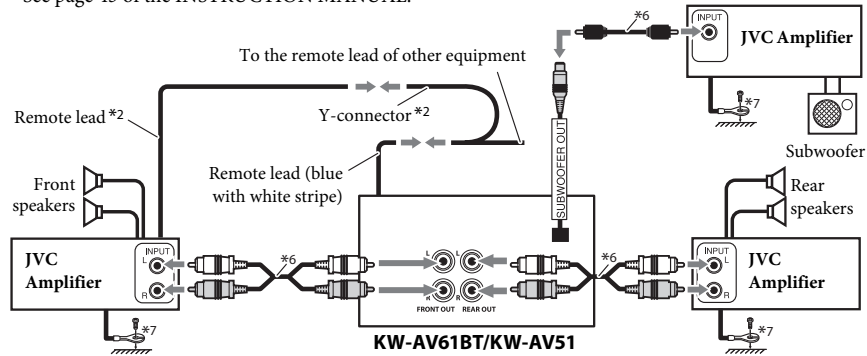

F Connecting the external components

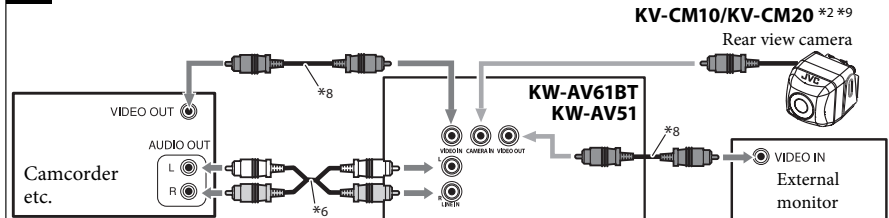

USB devices

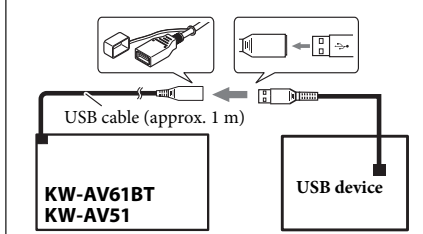

Connecting the iPod or the iPhone

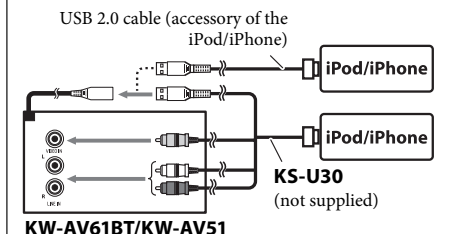

- **To watch video**, connect the iPod/iPhone using JVC KS-U30 *10 (separately purchased), otherwise, video is not displayed on the screen.
- **To listen to music**, connect the iPod/iPhone using a USB 2.0 cable (accessory of the iPod/iPhone).

C Connecting the microphone (Only for KW-AV61BT)

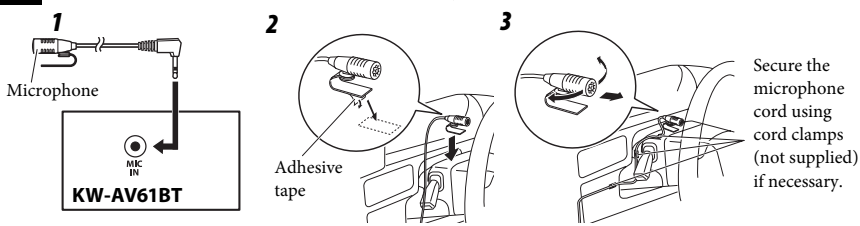

D Connecting the Bluetooth adapter (Only for KW-AV51)

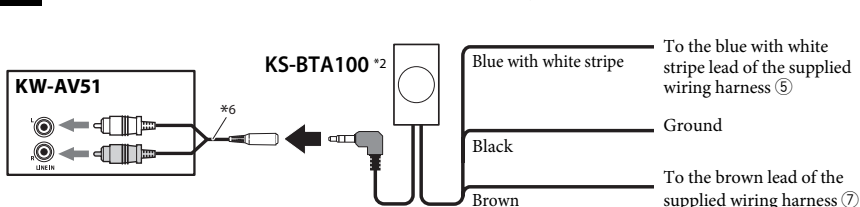

See page 58 of the INSTRUCTION MANUAL.

- *1 Only for KW-AV61BT.
- *2 Not supplied for this unit.
- *3 Before checking the operation of this unit prior to installation, this lead must be connected, otherwise power cannot be turned on. Do not connect the lead directly to the battery.
- *4 Do not connect the lead to any device other than the OE remote adapter. Doing so may cause malfunction.
- *5 Alter the wire of the OE remote adapter to connect to the steering wheel remote lead.
- *6 Audio cord (not supplied for this unit).
- *7 Firmly attach the ground wire to the metallic body or to the chassis of the car—to the place uncoated with paint (if coated with paint, remove the paint before attaching the wire). Failure to do so may cause damage to the unit.
- *8 Video cord (not supplied for this unit).
- *9 KV-CM10 / KV-CM20 is not sold in some areas. For details, consult your JVC car audio dealer.
- *10 When using the cable, you need to change the setting on the unit (see page 25 of the INSTRUCTION MANUAL).