



MONITOR WITH DVD RECEIVER

**KW-V940BW**

MONITOR WITH RECEIVER

**KW-M845BW**

---

## INSTRUCTION MANUAL

JVC KENWOOD Corporation

- Updated information (the latest Instruction Manual, system updates, new functions, etc.) is available from <http://www.jvc.net/cs/car/>.



# Contents

## **Before Use 4**

Precautions.....	4
How to read this manual .....	5

## **Basic Operations 6**

Functions of the Buttons on the Front Panel ...	6
Turning on the Unit .....	7
Initial Settings.....	7
Adjusting the volume .....	10
Touch screen operations .....	10
Popup menu .....	10
HOME screen descriptions.....	11
Source selection screen description.....	12
Source control screen descriptions .....	14
List screen .....	15

## **Information Window 16**

Photo Frame.....	16
------------------	----

## **Disc 17**

Playing a disc .....	17
DVD/ VCD Basic Operation.....	17
Music CD/ Disc media Basic Operation .....	19
File search Operation .....	20
DVD Disc Menu Operation.....	21
DVD Setup.....	22

## **APPS—Android Auto™/ Apple CarPlay 23**

Apple CarPlay Operation .....	23
Android Auto™ Operation .....	24
WebLink™/Waze Operation .....	26
Spotify Operation.....	27
Pandora® Operation .....	29

## **USB 31**

Connecting a USB device .....	31
USB Basic Operation.....	31
Search Operation.....	33

## **iPod/iPhone 34**

Preparation .....	34
iPod/iPhone Basic Operation .....	35
Search Operation.....	36

## **Tuner 37**

Tuner Basic Operation .....	37
Memory Operation .....	38
Selecting Operation .....	38
Traffic Information .....	39
Tuner Setup.....	39

**SiriusXM® 40**

SiriusXM® Basic Operation .....40  
Storing Channels in Preset Memory .....42  
Preset select .....42  
Direct search .....42  
Category/Channel search .....43  
Replay .....43  
TuneMix™ .....44  
SmartFavorites, TuneStart™ .....44  
TuneScan™ .....44  
Traffic & Weather Now™ .....45  
Content Alerts.....45  
SportsFlash™ .....46  
SiriusXM Setup .....46

**Other External Components 52**

View Camera .....52  
External audio/video players (AV-IN).....53  
OEM Features Operation .....54

**Bluetooth Control 55**

Information for using Bluetooth® devices.....55  
Register the Bluetooth device .....56  
Bluetooth Setup.....56  
Playing the Bluetooth Audio Device .....58  
Using the Hands-Free Unit.....60  
Hands-Free Setup .....65

**Setup 66**

Monitor Screen Setup .....66  
System Setup .....66  
User Interface Setup.....67  
Special Setup .....68  
Display Setup .....69  
AV Setup .....71

**Controlling Audio 72**

3 way speaker system setup .....72  
Speaker/ X'over setup .....73  
Controlling General Audio .....75  
Equalizer Control .....75  
Volume Offset .....76  
Zone Control .....77  
Sound Effect .....78  
Listening Position/ DTA .....79  
Audio Setup memory .....81

**Remote control 82**

Functions of the Remote control Buttons .....82

**Connection/Installation 84**

Before Installation .....84  
Installing the unit .....86

**Troubleshooting 91**

Problems and Solutions .....91  
Error Messages .....91

**Appendix 93**

Playable Media and Files.....93  
Region Codes in the World .....95  
DVD Language Codes.....96  
Specifications.....97  
About this Unit ..... 100

# Before Use

## Precautions

### ▲ WARNINGS

#### ■ To prevent injury or fire, take the following precautions:

- To prevent a short circuit, never put or leave any metallic objects (such as coins or metallic tools) inside the unit.
- Do not watch or fix your eyes on the unit's display when you are driving for any extended period.
- If you experience problems during installation, consult your JVC dealer.

#### ■ Precautions on using this unit

- When you purchase optional accessories, check with your JVC dealer to make sure that they work with your model and in your area.
- You can select a language to display menus, audio file tags, etc. See **User Interface Setup (P.67)**.
- The Radio Data System or Radio Broadcast Data System feature won't work in areas where the service is not supported by any broadcasting station.

#### ■ Protecting the monitor

- To protect the monitor from damage, do not operate the monitor using a ball point pen or similar tool with a sharp tip.

#### ■ Cleaning the unit

- If the faceplate of this unit is stained, wipe it with a dry soft cloth such as a silicon cloth. If the faceplate is stained badly, wipe it with a cloth moistened with neutral cleaner, then wipe it again with a clean soft dry cloth.

#### NOTE

- Applying spray cleaner directly to the unit may damage its mechanical parts. Wiping the faceplate with a hard cloth or using a volatile liquid such as thinner or alcohol may scratch the surface or erase the screened print.

#### ■ Lens fogging

When you turn on the car heater in cold weather, dew may form on the lens in the disc player of the unit due to condensation. This condensation on the lens (also called lens fogging) may not allow discs to play. In such a situation, remove the disc and wait for the dew to evaporate. If the unit still does not operate normally after a while, consult your JVC dealer.

#### ■ Precautions on handling discs

- Do not touch the recording surface of the disc.
- Do not stick tape etc. on the disc, or use a disc with tape stuck on it.
- Do not use disc type accessories.
- Clean the disc from the center toward the outside rim.
- When removing a disc from this unit, pull it out horizontally.
- If the disc center hole or outside rim has burrs, use the disc only after removing the burrs with a ballpoint pen etc.
- Discs that are not round cannot be used.

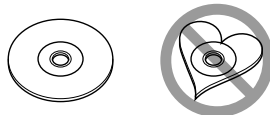

- 8-cm (3 inch) discs cannot be used.
- Discs with coloring on the recording surface or discs that are dirty cannot be used.

- This unit can only play the following types of CDs



- This unit may not correctly play discs which do not have the mark.
- You cannot play a disc that has not been finalized. (For the finalization process, see your writing software and your recorder's instruction manual.)

## Acquiring GPS signal

The first time you turn on this unit, you must wait while the system acquires satellite signals for the first time. This process could take up to several minutes. Make sure your vehicle is outdoors in an open area away from tall buildings and trees for fastest acquisition. After the system acquires satellites for the first time, it will acquire satellites quickly each time thereafter.

## How to read this manual

- The screens and panels shown in this manual are examples used to provide clear explanations of the operations. For this reason, they may be different from the actual screens or panels used, or some display patterns may be different.
- **Display language:** English is used for the purpose of explanation. You can select a display language from the **SETUP** menu. See **User Interface Setup (P.67)**.

# Basic Operations

## Functions of the Buttons on the Front Panel

### KW-V940BW

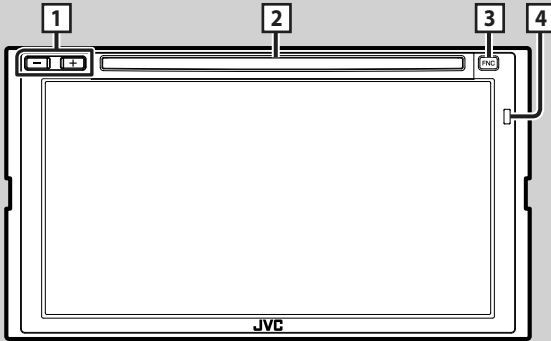

### KW-M845BW

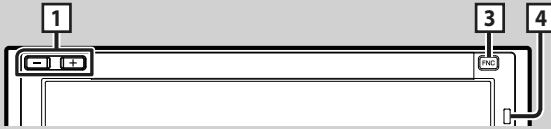

#### NOTE

- The panels shown in this guide are examples used to provide a clear explanation of operations. For this reason, they may be different from the actual panels.

Number	Name	Motion
1	-, + (Volume)	<ul style="list-style-type: none"><li>• Adjusts the volume.</li><li>• The volume will go up to 15 when you keep pressing +.</li></ul>
2	Disc insert slot	<ul style="list-style-type: none"><li>• A slot to insert a disc media.</li></ul>
3	FNC	<ul style="list-style-type: none"><li>• Displays the popup menu screen.</li><li>• Pressing for 1 second displays the Voice Recognition screen (P.62).</li><li>• When the power is off, turns the power on.</li></ul>
4	Remote Sensor	<ul style="list-style-type: none"><li>• Receives the remote control signal.</li></ul>

## Turning on the Unit

The method of turning on is different depending on the model.

- 1 Press the **FNC** button.

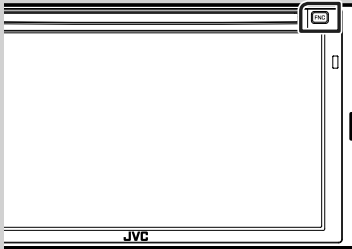

➤ The unit is turned on.

### NOTE

- If it is your first time to turn the unit on after installation, it will be necessary to perform Initial setup (P.7).

### ● To turn off the unit:

- 1 Press the **FNC** button.
  - Pop up menu appears.

- 2 Touch .

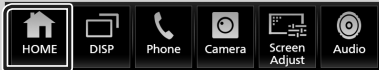

➤ HOME screen appears.

- 3 Touch .

- 4 Touch **Power Off**.



## Initial Settings

### Initial setup

Perform this setup when you use this unit first time.

- 1 Set each item as follows.

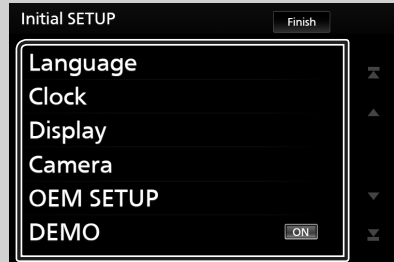

#### ■ Language

Select the language used for the control screen and setting items. Default is "American English (en)".

- ① Touch **Language**.
- ② Touch **Language Select**.
- ③ Select the desired language.
- ④ Touch .

For details of operation, see **User Interface Setup (P.67)**.

#### ■ Clock

Sets the synchronization of the clock and adjusts it.

For details of, see **Calendar/clock settings (P.9)**.

#### ■ Display

Set the button illumination color.

If it is hard to see the image on the screen even, adjust the viewing angle.

- ① Touch **Display**.
- ② Touch **Viewing Angle**.
- ③ Select an angle
- ④ Touch .

For details of, see **Display Setup (P.69)**.

## Basic Operations

### ■ Camera

Set the parameters for the camera.

- 1 Touch **Camera**.
- 2 Set each item and touch .

For detailed operation, see **Camera Setup (P.52)**.

### ■ OEM SETUP

This function requires a commercial adaptor. Consult your JVC dealer for details.

### ■ DEMO

Set the demonstration mode. Default is "ON".

- 1 Touch **DEMO** and select ON or OFF.

## 2 Touch Finish.

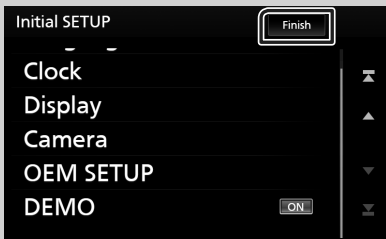

### NOTE

- These settings can be made from the SETUP menu. See **Setup (P.66)**.

## Security Code Setup

You can set up a security code to protect your receiver system against theft.

When the Security Code function is activated, the code cannot be changed and the function cannot be deactivated. Note that the Security Code can be set with a 4 to 8 digit number of your choice.

### 1 Press the **FNC** button.

- > Popup menu appears.

### 2 Touch .

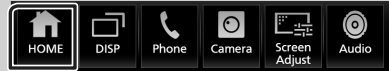

- > HOME screen appears.

### 3 Touch .



### 4 Touch **Security**.



- > Security screen appears.

### 5 Touch **Security Code Set** on the Security screen.

- > Security Code Set screen appears.

### 6 Enter a security code with 4 to 8 digits and touch **Enter**.





- 7** Enter the same code again and touch **Enter** .

Now, your security code is registered.

#### NOTE

- Touch **BS** to delete the last entry.
- If you enter a different security code, the procedure returns to step 6 (for first code entry).
- If you have disconnected the Receiver from the battery, enter the correct security code as that you have entered in step 6 and touch **Enter**. You can use your receiver.

### To change the security code:

- 1** Touch **Security Code Change** on the Security screen, then repeat step 6 and 7.

### To clear the security code:

- 1** Touch **Security Code Cancellation** on the Security screen, then repeat step 6.

## Calendar/clock settings

- 1** Press the **FNC** button.  
 ► Popup menu appears.

- 2** Touch .

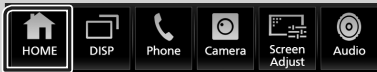

► HOME screen appears.

- 3** Touch .



- 4** Touch **User Interface** .



► User Interface screen appears.

- 5** Touch **Time Zone** .

- 6** Select the time zone.

- 7** Set each item as follows.

Scroll the page to show hidden items.

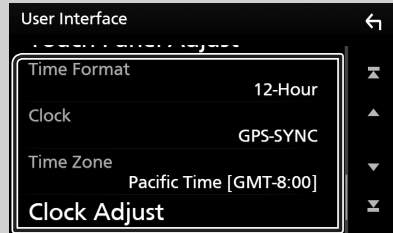

#### ■ Time Format

Select the time display format.

**12-Hour** (Default) / **24-Hour**

#### ■ Clock

**GPS-SYNC** (Default): Synchronizes the clock time with the GPS.

**Manual**: Set the clock manually.

#### ■ Time Zone

Select the time zone.

#### ■ Clock Adjust

If you select **Manual** for Clock, adjust the date and time manually. **(P.68)**

#### NOTE

- Please set the date and time. If they not set, some functions may not work.

## Adjusting the volume

To adjust the volume (0 to 40),  
Press **+** to increase, and press **-** to decrease.  
Holding **+** increases the volume continuously to level 15.

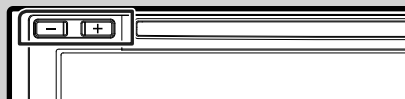

## Touch screen operations

To perform operations on the screen, you need to touch, touch and hold, flick or swipe to select an item, display a setting menu screen or change pages.

### ● Touch

Touch the screen gently to select an item on the screen.

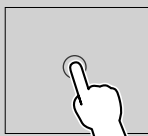

### ● Touch and hold

Touch the screen and keep your finger in place until the display changes or a message is displayed.

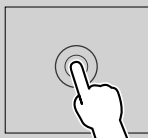

### ● Flick

Slide your finger quickly to the left or right on the screen to change the page.  
You can scroll a list screen by flicking up/ down on the screen.

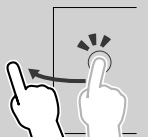

### ● Swipe

Slide your finger up or down on the screen to scroll the screen.

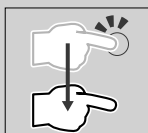

## Monitor Touch Control:

You can also control playback by moving your finger on the touch panel as follows (for some sources, the gesture control function is not available).

- Sliding the finger upward/downward:  
Equivalent to the operation of pressing **+** / **-** (Media). Tuner Preset broadcast stations are switched.
- Sliding the finger leftward/rightward:  
Equivalent to the operation of pressing **◀◀** / **▶▶**.
- Moving your finger clockwise or counter-clockwise: Increases/decreases the volume.

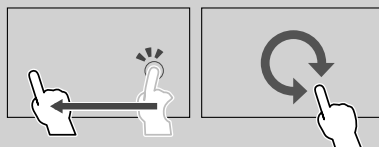

## Popup menu

- 1 Press the **FNC** button.



➤ Popup menu appears.

- 2 Touch to display the popup menu.







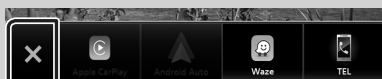

### KW-V940BW



### KW-M845BW



The contents of the menu are as follows.

	<ul style="list-style-type: none"> <li>Displays the HOME screen. <b>(P.11)</b></li> </ul>
	<ul style="list-style-type: none"> <li>Switches between screens. The screen to be switched to depends on the <b>DISP Key</b> setting on the <b>User Interface</b> screen. <b>(P.67)</b>.</li> <li>Touch and hold to turns the screen off.</li> </ul>
	<ul style="list-style-type: none"> <li>Displays the Hands Free screen. <b>(P.60)</b></li> <li>When connecting as Apple CarPlay or Android Auto, it works as a phone provided in Apple CarPlay or Android Auto.</li> </ul>
	<ul style="list-style-type: none"> <li>Displays the view camera screen. <b>(P.52)</b></li> </ul>
	<ul style="list-style-type: none"> <li>Displays the Screen Adjustment screen. <b>(P.66)</b></li> </ul>
	<ul style="list-style-type: none"> <li>Displays the Audio screen. <b>(P.72)</b></li> </ul>
	<ul style="list-style-type: none"> <li>Touch to eject the disc.</li> <li>Touch and hold to forcibly eject the disc.</li> <li>To forcibly eject the disc, touch it for 2 seconds and then touch <b>Yes</b> after the message is displayed. KW-V940BW only</li> </ul>
	<ul style="list-style-type: none"> <li>Close the popup menu. KW-M845BW only</li> </ul>
<b>1</b>	<ul style="list-style-type: none"> <li>Short-cut buttons: The source changes to the one you have set with a short-cut. For the short-cut setting, refer to <b>Customize Short-cut buttons on HOME screen (P.14)</b>.</li> </ul>

## Turn off the screen

- 1 Touch and hold **DISP** on the popup menu.

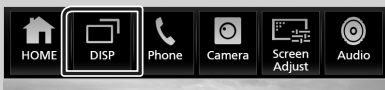

- To turn on the screen

- 1 Touch the display.

## HOME screen descriptions

Most functions can be performed from the HOME screen.



- |          |   |
|----------|---|
| <b>1</b> | <ul style="list-style-type: none"> <li>Short-cut playback source icons <b>(P.13)</b></li> </ul>   |
| <b>2</b> | <ul style="list-style-type: none"> <li>Current source information.</li> <li>Touch to display the control screen of the current source.</li> </ul>   |
| <b>3</b> | <ul style="list-style-type: none"> <li>Information Window <b>(P.16)</b> <ul style="list-style-type: none"> <li>You can change the information window by touching <b>◀/▶</b>.</li> <li>Touch the Information Window to display the detailed screen.</li> </ul> </li> </ul> |
| <b>4</b> | <ul style="list-style-type: none"> <li>Displays the SETUP Menu screen. <b>(P.66)</b></li> </ul>   |
| <b>5</b> | <ul style="list-style-type: none"> <li>Displays the source selection screen. <b>(P.12)</b></li> </ul>   |
| <b>6</b> | <ul style="list-style-type: none"> <li>Touch to eject the disc.</li> <li>Touch and hold to forcibly ejects the disc.<br/>KW-V940BW only</li> </ul>  |

## Display the HOME screen

- 1 Press the **FNC** button.



- Popup menu appears.

- 2 Touch .

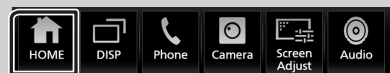

- HOME screen appears.

## Source selection screen description

You can display icons of all playback sources and options on the source selection screen.







- |          |  |
|----------|--|
| <b>1</b> | • Changes playback sources.<br>For playback sources, see <b>P.12</b> .                                     |
| <b>2</b> | • Page indication  |
| <b>3</b> | • Changes pages. (Touch <b>◀/▶</b> )<br>You can also change pages by flicking left or right on the screen. |
| <b>4</b> | • Returns to the previous screen.  |
| <b>5</b> | • Displays the SETUP Menu screen. <b>(P.66)</b>  |

## Select the playback source

- 1** Press the **FNC** button.  
➤ Popup menu appears.
- 2** Touch **🏠**.  
➤ HOME screen appears.

- 3** Touch **📱**.  
From the screen, you can select the following sources and functions.

	• Switches to the Apple CarPlay screen from the connected iPhone. <b>(P.23)</b>
	• Switches to the WebLink screen from the connected Android device. <b>(P.24)</b>
	• Switches to the Android Auto screen from the connected Android device. <b>(P.24)</b>
	• Displays the Hands Free screen. <b>(P.60)</b> When connecting as Apple CarPlay or Android Auto, it works as a phone provided in Apple CarPlay or Android Auto.
	• Switches to the Radio broadcast. <b>(P.37)</b>
	• Switches to the SiriusXM® satellite radio broadcast. <b>(P.40)</b>
	• Plays a Bluetooth audio player. <b>(P.55)</b>
	• Plays a disc. *1 <b>(P.17)</b>
	• Plays an iPod/iPhone. <b>(P.34)</b>
	• Plays files on a USB device. <b>(P.31)</b>
	• Switches to Pandora. <b>(P.29)</b>
	• Switches to Spotify. <b>(P.27)</b>
	• Switches to an external component connected to the AV-IN input terminal. <b>(P.53)</b>
	• Displays the WebLink screen. <b>(P.26)</b>

	• Displays the Waze screen. <b>(P.26)</b>
	• Displays the Audio screen. <b>(P.72)</b>
	• Turns off the AV source. <b>(P.13)</b>
	• Turns off the unit. <b>(P.7)</b>

• For sources and information displayed when an ADS adapter is connected, see **OEM Features Operation (P.54)**.

\*1 KW-V940BW only

### To select the playback source on the HOME screen



The 4 items displayed on the source selection screen with large icons are shown on the HOME screen.

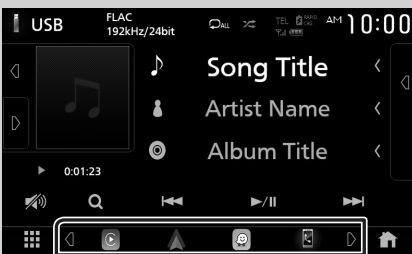

You can change the items displayed on this area by customizing the source selection screen. **(P.14)**

### To select the playback source on the source control screen



Display source selection buttons by touching  or flicking left or right on the source control screen, then select a playback source.



## To turn off the AV source

- 1 Press the **FNC** button.  
➤ Popup menu appears.
- 2 Touch .  
➤ HOME screen appears.
- 3 Touch .
- 4 Touch **AV Off**.



## Customize Short-cut buttons on HOME screen

You can arrange the positions of the source icons as you like.

- 1 Press the **FNC** button.  
▶ Popup menu appears.
- 2 Touch .  
▶ HOME screen appears.
- 3 Touch .
- 4 Touch and hold the icon which you want to move in the customizing mode.
- 5 Drag the icon to the desired position.

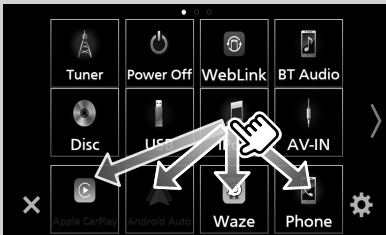

Changes the page



## Source control screen descriptions

There are some functions which can be performed from most screens.

Indicators

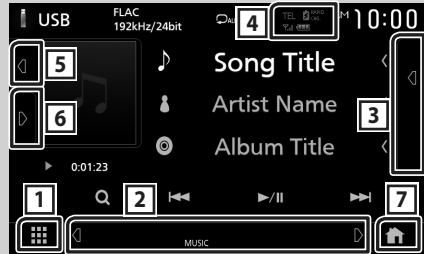



Short-cut buttons



### 1 All sources icon

Displays all sources.

### 2 Secondary screen

-  /  : The Secondary screen changes to another one every time you touch it. You can also change the Secondary screen by flicking left or right on the screen.
- Indicators: Displays the current source condition and so on.
  - **ATT**: The attenuator is active.
  - **DUAL**: The dual zone function is active.
  - **LOUD**: The loudness control function is active.

- Short-cut buttons: The source changes to the one you have set with a short-cut. For the short-cut setting, refer to **Customize Short-cut buttons on HOME screen (P.14)**.

### 3 Content list

Displays the track/file/station/channel list.



- Connected Bluetooth device information.
-  : Lights up during quick charging of the battery of the connected iPod/ iPhone/ Smartphone.

### 5 Artwork & information

You can select whether to display an artwork and song information or only song information in more detail.

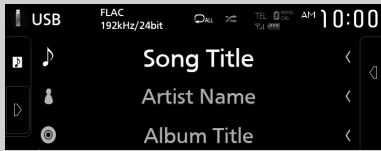
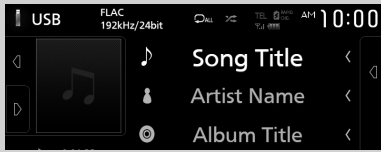

### 6 Function panel

Touch the left side of the screen to display the function panel. Touch again to close the panel.

### 7 HOME button

Displays the HOME screen. (P.11)

## List screen

There are some common function keys in the list screens of most sources.



Displays the list type selection window.



Displays a music/movie file list.



Scrolls the displayed text.



Keys with various functions are displayed here.

- ▶ **Play**: Plays all tracks in the folder containing the current track.
- 🔍 **A-Z**: Jumps to the letter you entered (alphabetical search).
- 📁 **Top** / 📁 **Up**: Moves to the upper hierarchy level.



You can change pages to display more items by pressing ▲ / ▼.

- 📁 / 📁: Displays the top or bottom page.



Returns to the previous screen.

### NOTE

- Buttons which cannot be activated from the list screen are not displayed.

# Information Window

## Photo Frame

You can display a slideshow of the image files stored in the USB memory on the Home screen.



### Acceptable Picture files

	Max. Picture size
JPEG (.jpg, .jpeg) *1	5,000 × 5,000
PNG (.png)	1,000 × 1,000
BMP (.bmp)	1,000 × 1,000

- This unit can only play back files which are less than 50 MB.
- The maximum number of files per device is 500.
- Picture files may not be played depending on their condition.

\*1 A progressive format is not supported.

### Photo Frame



- 1 Press the **FNC** button.
  - Popup menu appears.
- 2 Touch .
  - HOME screen appears.
- 3 Touch  /  in the Information Window area to select the photo frame.



### Photo Frame Setup

Make settings related to display of the photo frame.

- 1 Press the **FNC** button.
  - Popup menu appears.

- 2 Touch .
  - HOME screen appears.
- 3 Touch .
  - SETUP screen appears.
- 4 Touch **User Interface**.



➤ User Interface screen appears.

- 5 Touch **Information Window SETUP in the User Interface screen.**

- 6 Set each item as follows.

#### ■ Photo Frame

Determine whether to use the photo frame.  
"ON" (Default)/ "OFF"

#### ■ Photo Frame SETUP

Make settings related to photo play display.

- 7 Touch .

### To Photo Frame Setup

- 1 Touch **Photo Frame SETUP on the Information Window SETUP screen.**

- 2 Set each item as follows.

#### ■ Sort Order

Specify a file sorting criterion.

"By Name(Ascending)"/ "By Name(Descending)"/ "By Date(Newest First)" (Default)/ "By Date(Oldest First)"

#### ■ Slide Show Interval

Specify the slideshow interval.

"5" (Default) to "30" seconds

#### ■ Photo Frame is .....

Display help topics about the photo frame.

- 3 Touch .



# Disc (KW-V940BW)

## Playing a disc

### Insert a disc

#### 1 Insert the disc into the slot.

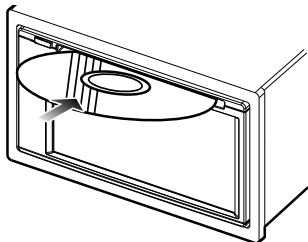

- The unit loads the disc and playback starts.

### Eject a disc

#### 1 Press the **FNC** button.

- Pop up menu appears.

#### 2 Touch ▲.

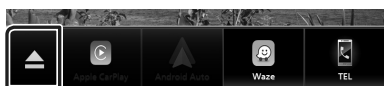

When removing a disc, pull it horizontally.

#### NOTE

- This is not displayed on the pop up menu screen of Apple CarPlay or Android Auto source. Change Apple CarPlay or Android Auto source to other one to display the pop up menu screen.

## DVD/VCD Basic Operation

Most functions can be controlled from the source control screen and playback screen.

#### NOTE

- The screen shot below is for DVD. It may be different from the one for VCD.

#### 1 When the operation buttons are not displayed on the screen, touch **7** area.

#### Control screen









#### Video screen



#### 1 Information display area





Displays the following information.

- **Title #, Chapter #:** DVD title and chapter number
- **Track #/Scene #:** VCD track or scene number. Scene # is displayed only when Playback control (PBC) is on.
- **Linear PCM, etc.:** Audio format











- **Hide** : Hides the control screen.
-  : Repeats the current content. Each time you touch the key, repeat modes are switched in the following sequence:  
**DVD**: Title repeat (  ), Chapter repeat (  ), Repeat off (  )
- **VCD** (PBC On): Does not repeat
- **VCD** (PBC Off): Track repeat (  ), Repeat off (  )

## 2 Function panel

Touch the left side of the screen to display the function panel. Touch again to close the panel.





-  : Stops playback. Touching twice will play the disc from the beginning when you play it next time.
-   : Fast-forwards or fast-backward the disc. Each time you touch the key, the speed changes. 2 times, 10 times.
-   (DVD only): Plays in slow motion forward or backward.
- **SETUP** (DVD only): Touch to display the DVD SETUP screen. See *DVD Setup (P.22)*.
- **MENU CTRL** (DVD only): Touch to display the DVD-VIDEO disc menu control screen. See *DVD Disc Menu Operation (P.21)*.
- **PBC** (VCD only): Touch to turn Playback control (PBC) on or off.
- **Audio** (VCD only): Touch to change audio output channels.

## 3 Play mode indicator/ Playing time

-  ,  ,  , etc.: Current play mode indicator  
Meanings of the icons are as follows:  (play),  (fast forward),  (fast backward),  (stop),  (resume stop),  (pause),  (slow playback),  (slow reverse playback).
- For confirmation of current playing position. You can drag the circle left or right to change the playing position.



## 4 Operation keys

-   : Searches for the previous/next content.  
Touch and hold to fast-forward or fast-backward the disc.
-  : Plays or pauses.
-  : Touch to attenuate/restore the sound.

## 5 Indicator Items

- **IN** : Disc insertion status.  
White: A Disc is inside the unit.  
Orange: Disc player failure.

## VCD

- **1chLL/2chLL** : Identifies the left audio output of channel 1 or 2.
- **1chLR/2chLR** : Identifies the monaural audio output of channel 1 or 2.
- **1chRR/2chRR** : Identifies the right audio output of channel 1 or 2.
- **1chST/2chST** : Identifies the stereo audio output of channel 1 or 2.
- **LL** : Identifies the left audio output.
- **LR** : Identifies the monaural audio output.
- **RR** : Identifies the right audio output.
- **ST** : Identifies the stereo audio output.
- **PBC** : The PBC function is on.
- **VER1** : The VCD version is 1.
- **VER2** : The VCD version is 2.

## 6 Searching area

Touch to search for the next/previous content.

## 7 Key display area

Touch to display the control screen.

## 8 MENU CTRL (DVD only)

Touch to display the DVD-VIDEO disc menu control screen. See *DVD Disc Menu Operation (P.21)*.

### NOTE

- The control screen disappears when no operation is done for 5 seconds.
- If you use a remote control, you can jump directly to the desired image by entering the chapter number, scene number, play time, etc. (*P.83*).

## Music CD/ Disc media Basic Operation

Most functions can be controlled from the source control screen and playback screen.

### NOTE

- In this manual, "Music CD" means a general CD which includes music tracks.  
"Disc media" means a CD/DVD disc which includes audio or video files.
- The screen shot below is for disc media. It may be different from the one for CD.

### Control screen

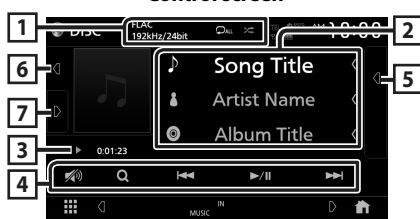

### Open the drawer



### Close the drawer

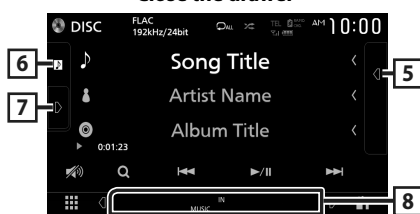

### 1 CODEC / [Repeat] / [Random]

- When a high-resolution source is played, its format information is displayed. (Disc media only)
- [Repeat]: Repeats the current track/folder. Each time you touch the key, repeat mode switches in the following sequence; Track/ File repeat ([Repeat]), Folder repeat ([Folder Repeat]) (Disc media only), Repeat all ([Repeat All])

- [Random]: Randomly plays all tracks in current folder/disc. Each time you touch the key, random mode switches in the following sequence; Track random ([Random All]) (Music CD only), Folder random ([Random Folder]) (Disc media only), Random off ([Random Off])

### 2 Track information

Displays the information of the current track/ file. Only a file name and a folder name are displayed if there is no tag information. (Disc media only)

### 3 Play mode indicator/ Playing time

- [Play], [Fast Forward], etc.: Current play mode indicator  
Meanings of the icons are as follows: [Play] (play), [Fast Forward] (fast forward), [Fast Backward] (fast backward), [Pause] (pause).
- For confirmation of current playing position. You can drag the circle left or right to change the playing position. (Video file only)



### 4 Operation keys

- [Search] (Disc media only): Searches files. For details on search operation, see **File search Operation (P.20)**.
- [Previous/Next]: Searches for the previous/next content.  
Touch and hold to fast-forward or fast-backward the disc.
- [Play/Pause]: Plays or pauses.
- [Volume]: Touch to attenuate/restore the sound.

### 5 Content list

- Touch the right side of the screen to display the Content list. Touch again to close the list.
- Displays the playing list. When you touch a track/file name on the list, playback will start.

### 6 Artwork/ Analog meter

- Displays/hides artwork area.
- The jacket of the currently playing file is displayed. (Disc media only)
- When touched, switches the artwork to the analog meter.

### 7 Function panel (Disc media only)

Touch the left side of the screen to display the function panel. Touch again to close the panel.

- [Previous/Next]: Searches for the previous/next folder.

**8 Indicator Items**

- **IN**: Disc insertion status.  
White: A Disc is inside the unit.  
Orange: Disc player failure.
- **VIDEO**: Identifies the video file.
- **MUSIC**: Identifies the music file.

Video screen



**9 File search area (Video file only)**

Touch to search for the next/previous file.

**10 Key display area (Video file only)**

Touch to display the control screen.

**File search Operation  
(Disc media only)**

You can search for a file according to hierarchy.

**NOTE**

- For operations in the list screen, see **List screen (P.15)**.

- 1 Touch **Q**.  
➤ Folder List screen appears.
- 2 Touch the desired folder.



- When you touch a folder its contents are displayed.

- 3 Touch the desired item in the content list.  
➤ Playback starts.

## DVD Disc Menu Operation

You can set up some functions using the DVD-VIDEO disc menu.

### 1 Touch the framed area during playback.



➤ Menu Control screen appears.

### 2 Perform your desired operation as follows.



#### ■ To display the top menu

Touch **TOP**.\*

#### ■ To display the menu

Touch **MENU**.\*

#### ■ To display the previous menu

Touch **Return**.\*

#### ■ To enter selected item

Touch **Enter**.

#### ■ To enable direct operation

Touch **Highlight** to enter the highlight control mode (P.21).

#### ■ To move the cursor

Touch ▲, ▼, ◀, ▶.

#### ■ To switch among subtitle languages

Touch **Subtitle**. Each time you touch this key, subtitle languages are switched.

#### ■ To switch among audio languages

Touch **Audio**. Each time you touch this key, audio languages are switched.

#### ■ To switch among picture angles

Touch **Angle**. Each time you touch this key, picture angles are switched.

\*These keys may not function depending on the disc.

## Highlight control

Highlight control lets you control the DVD menu by touching the menu key directly on the screen.

### 1 Touch **Highlight** on the Menu Control screen.

### 2 Touch your desired item on the screen.



#### NOTE

- The highlight control function is cancelled automatically if you do not operate for a predetermined period of time.

## DVD Setup

You can set up the DVD playback functions.

### 1 Touch the framed area during playback.



### 2 Touch on the left side of the screen. Touch **SETUP**.

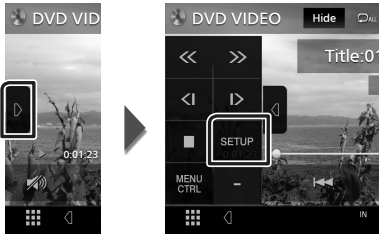

➤ DVD SETUP screen appears.

### 3 Set each function as follows.

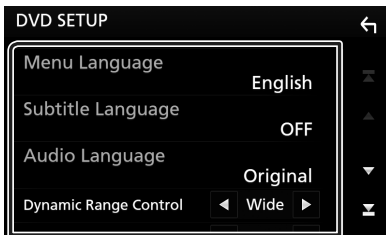

#### ■ **Menu Language / Subtitle Language / Audio Language**

See **Language setup (P.22)**.

#### ■ **Dynamic Range Control**

Sets the dynamic range.

**Wide**: The dynamic range is wide.

**Normal**: The dynamic range is normal.

**Dialog** (Default): Makes the total sound volume larger than the volumes in other modes. This is effective only when the Dolby Digital software is in use.

#### ■ **Screen Ratio**

Sets the screen display mode.

**16:9** (Default): Displays wide pictures.

**4:3 LB**: Displays wide pictures in the Letter Box format (having black stripes at the top and bottom of screen).

**4:3 PS**: Displays wide pictures in the Pan & Scan format (showing pictures cut at the right and left ends).

### **Language setup**

This setting is for the languages used for the menu, subtitle, and voice.

#### 1 Touch the desired item; **Menu Language, Subtitle Language, Audio Language.**

➤ Language Set screen appears.

#### 2 Select a language.

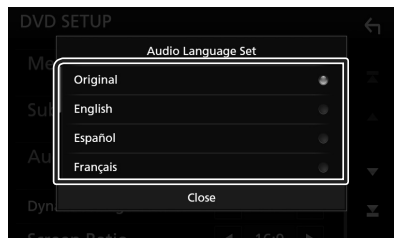

For language codes, refer to **DVD Language Codes (P.96)**.

Touch Close to set the entered language and return to the DVD SETUP screen.

#### **NOTE**

- To set the DVD's original language as the audio language, touch **Original**.

# APPS—Android Auto™/Apple CarPlay

## Apple CarPlay Operation

CarPlay is a smarter, safer way to use your iPhone in the car. CarPlay takes the things you want to do with iPhone while driving and displays them on the screen of the product. You can get directions, make calls, send and receive messages, and listen to the music from iPhone while driving. You can also use Siri voice control to make it easier to operate iPhone.

For details about CarPlay, visit <https://ssl.apple.com/ios/carplay/>.

### Compatible iPhone devices

You can use CarPlay with the following iPhone models.

- iPhone 7 Plus
- iPhone 6 Plus
- iPhone 7
- iPhone 6
- iPhone SE
- iPhone 5s
- iPhone 6s Plus
- iPhone 5c
- iPhone 6s
- iPhone 5

## Connecting an iPhone

### 1 Connect your iPhone using KS-U62 via the USB (Black) terminal. (P.89)

When an iPhone compatible with CarPlay is connected to the USB (Black) terminal, the Bluetooth Hands-Free phone currently connected is disconnected.

### 2 Unlock your iPhone.

### ● Switching the Current Source to the Apple CarPlay Source When Connecting Your iPhone

When the iPhone you used previously is connected again, a confirmation message appears to ask whether you are sure to start the CarPlay source.

### 1 Connect iPhone using KS-U62 via USB (Black) terminal.

### 2 Unlock your iPhone.

### 3 Touch the connection message at the bottom of the screen.

The current source is connected to the CarPlay source.



The connection message is displayed for about 5 seconds.

### NOTE

- If the message disappears, select the CarPlay source on the source selection screen. (P.12)

## Operation buttons and available Apps on the home screen of CarPlay

You can use the Apps of the connected iPhone. The items displayed and the language used on the screen differ among the connected devices.

To enter the CarPlay mode, touch **Apple CarPlay** icon on the source selection screen. (P.12)



- Displays the home screen of CarPlay.
- Touch and hold to activate Siri.

### 2 Application buttons

Starts the application.

### 3 HOME

Exits the CarPlay screen and displays the Home screen.

### To exit the CarPlay screen

### 1 Press the FNC button.

- Pop up menu appears.

### 2 Touch .

- HOME screen appears.

## Use Siri

You can activate Siri.

- 1 Press the **FNC** button for 1 second.



- 2 Talk to Siri.

### To deactivate

- 1 Press the **FNC** button.

## Switch to the Apple CarPlay screen while listening to another source

- 1 Press the **FNC** button.
  - Popup menu appears.

- 2 Touch **DISP**.

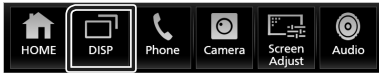

### NOTE

- This operation is available when **DISP Key** is set to **Mirroring** on the **User Interface** screen. (P.67)
- When listening to another source with the Apple CarPlay screen displayed, playing music in the Apple CarPlay mode will switch the current source to the Apple CarPlay source.

## Android Auto™ Operation

Android Auto enables you to use the functions of your Android device convenient for driving. You can easily access route guidance, make calls, listen to music, and access convenient functions on the Android device while driving. For details about Android Auto, visit <https://www.android.com/auto/> and <https://support.google.com/androidauto>.

### Compatible Android devices

You can use Android Auto with Android devices of Android version 5.0 (Lollipop) or later. For Wi-Fi connection, Android 8.0 (Oreo) or later.

### NOTE

- Android Auto may not be available on all devices and may not be available in all countries or regions.

## Connect Android device

### Wired connection

- 1 Connect an Android device via the USB terminal. (P.90)

To use the hands-free function, connect the Android device via Bluetooth.

When an Android device compatible with Android Auto is connected to the USB terminal, the device is connected via Bluetooth automatically, and the Bluetooth Hands-Free phone currently connected is disconnected.

- 2 Unlock your Android device.

- 3 Press the **FNC** button.
  - Popup menu appears.

- 4 Touch .

- 5 Touch .

- 6 Touch **Android Auto**. (P.12)

### Wireless connection

When the Android device is ready for wireless connection, connecting it via the USB registers Bluetooth and Wi-Fi automatically. Thus, the registered Android device will be able to be connected wirelessly to be used as an Android Auto source.



- 1 Press the **FNC** button.  
➤ Popup menu appears.

- 2 Touch .

- 3 Touch .

- 4 Touch **Android Auto**. (P.12)

**NOTE**

- Turn on the Bluetooth function and Wi-Fi function of Android device.
- If two or more Android devices have been registered, select the Android device to be used as the Android Auto source. (P.25)

 **Select an Android device**

If two or more Android devices have been registered, select the Android device to be used as the Android Auto source.

- 1 Press the **FNC** button.  
➤ Popup menu appears.

- 2 Touch .

- 3 Touch .

- 4 Touch **Android Auto**. (P.12)

- 5 Select an Android device.

The registered Android devices ready for wireless connection and the Android device connected via the USB are displayed.

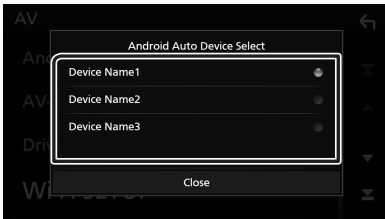

 **Operation buttons and available Apps on the Android Auto screen**

You can perform the operations of the Apps of the connected Android device.

The items displayed on the screen differ among the connected Android devices.

To enter the Android Auto mode, touch the **Android Auto** icon on the source selection screen. (P.12)

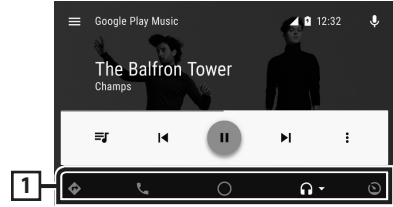

 **Application/information buttons**

Starts the application or displays information.

**To exit the Android Auto screen**

- 1 Press the **FNC** button.  
➤ Popup menu appears.

- 2 Touch .
- HOME screen appears.

 **Using voice control**

- 1 Press the **FNC** button for 1 second.



**To cancel**

- 1 Press the **FNC** button.

 **Switch to the Android Auto screen while listening to another source**

- 1 Press the **FNC** button.  
➤ Popup menu appears.

- 2 Touch **DISP**.

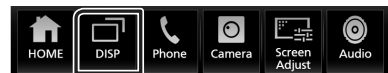

**NOTE**

- This operation is available when **DISP Key** is set to **Mirroring** on the **User Interface** screen. (P.67)
- When listening to another source with the Android Auto screen displayed, playing music in the Android Auto mode will switch the current source to the Android Auto source.

## WebLink™/Waze Operation

You can display and control the App on the unit while your smartphone is connected to the USB terminal.

### Preparation

- Install the latest version of the WebLink application "WebLink for JVC" on your iPhone or Android.  
**iPhone:** Search for "WebLink for JVC" in the Apple App Store to find and install the most current version.  
**Android:** Search for "WebLink for JVC" in Google play to find and install the most current version.

### Available Apps

You can use the following Apps on this unit. Install the Apps on your smartphone beforehand.

#### WebLink™

WebLink™ enables you to use the following Apps with the unit.

- Media player
- Waze
- Yelp
- YouTube
- Weather
- Next Radio

#### Waze

Waze is the world's largest community based traffic and navigation App. Join other drivers in your area who share real-time traffic and road info, saving everyone time and gas money on their daily commute.

- To use Waze on the unit, you need to install WebLink™ and Waze on your smartphone beforehand.

### Connect a smartphone

#### 1 Connecting a smartphone

- Connect an Android device via the USB terminal. **(P.90)**
- Connect your iPhone using KS-U62 via the USB (Black) terminal. **(P.89)**
- When your smartphone is connected to a unit, a confirmation message to communicate each other appears on the smartphone. Touch **Allow / OK** to establish connection, or **Ignore / Cancel** to cancel the connection.
- You can check the connection status on the WebLink™ screen on your smartphone.

#### 2 Press the **FNC** button.

- Popup menu appears.

#### 3 Touch .

#### 4 Touch .

#### 5 Touch **WebLink** or **Waze** . **(P.12)**

## Operation buttons and available Apps on the App screen

WebLink source screen

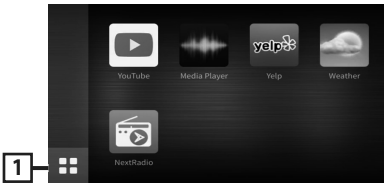

Displays the main menu of the “WebLink” source screen.



Returns to the previous screen.

### 1 Operate on your smartphone.

- When you are asked to communicate between your smartphone and the unit, touch **Allow** to proceed.

## Switching to the App screen while listening to another source

### 1 Press the FNC button.

- Popup menu appears.

### 2 Touch DISP.

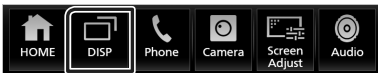

#### NOTE

- This operation is available when **DISP Key** is set to **Mirroring** in the **User Interface** screen. (P.67)
- When listening to another source with the WebLink screen displayed, playing music in the WebLink mode will switch the current source to the WebLink source.

## Spotify Operation

You can listen to Spotify on this unit by controlling the application installed in the iPhone or Android.

To select the Spotify source, touch **Spotify** icon on the source selection screen. (P.12)

### Preparation

- Install the latest version of the Spotify application “Spotify” on your iPhone or Android.  
**iPhone:** Search for “Spotify” in the Apple App Store to find and install the most current version.  
**Android:** Search for “Spotify” in Google play to find and install the most current version.
- iPhones are connected via either USB or Bluetooth.
- Android devices are connected via Bluetooth.
- To connect a smartphone via Bluetooth, register it as the Bluetooth device and do the App (SPP) profile setting for the connection beforehand. See **Register the Bluetooth device (P.56)** and **Connect the Bluetooth device (P.57)**.

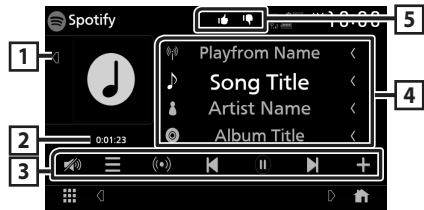

### Close the drawer

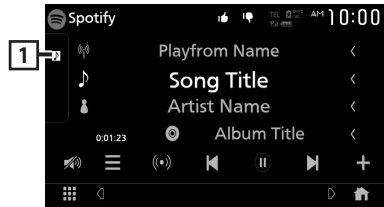









### 1 Artwork

- Displays/hides artwork area.
- Picture data is displayed if available from the current content.

### 2 Playing time

- For confirmation of play time.





### 3 Operation keys

-  : Displays the Menu screen
-  : New radio station that relates to the artist of the currently being played song is selected and playback starts.
-  ,  : Skips the current song.
-  ,  : Plays or pauses the content of the current station.
-  : Saves the currently being played song to My Music.
-  : Touch to attenuate/restore the sound.

### 4 Content information

Displays the information on the current content being played.

### 5 / / /

-  : Thumbs down to the current contents and skip to the next content.
-  : Registers the current content as a favorite content.
-  : Repeats the current song.
-  : Randomly plays all songs in the current playlist.

## ■ Selecting a track

### 1 Touch .

➤ Menu screen appears.

### 2 Select the list type, then select a desired item.

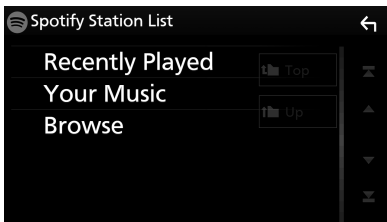

#### ■ To select the category and station

Touch the category and station name in the list.

#### ■ Top

Returns to the top of the list.

#### ■ Up

Returns to the previous list.

## About Spotify®

### Note

- Ensure you are logged in to your smartphone application. If you do not have an Spotify account, you can create one for free from your smartphone or at [www.spotify.com](http://www.spotify.com).
- Because Spotify is a third-party service, the specifications are subject to change without prior notice. Accordingly, compatibility may be impaired or some or all of the services may become unavailable.
- Some functions of Spotify cannot be operated from this unit.
- For issues on using the application, contact Spotify at [www.spotify.com](http://www.spotify.com).
- Establish an Internet connection.

## Pandora® Operation

You can listen to Pandora® on this unit by controlling the application installed in the iPhone or Bluetooth device.

To select the Pandora source, touch the **Pandora** icon on the source selection screen. (P.12)

### Preparation

- Install the latest version of the Pandora® application on your iPhone, Android or BlackBerry.
- iPhone:** Search for "Pandora" in the Apple App Store to find and install the most current version.
- Android:** Visit the Google play and search for Pandora to install.
- BlackBerry:** Visit www.pandora.com from the built in browser to download the Pandora application.
- iPhones are connected via either USB or Bluetooth.
- Android or BlackBerry devices are connected via Bluetooth.
- To connect a smartphone via Bluetooth, register it as the Bluetooth device and do the App (SPP) profile setting for the connection beforehand. See **Register the Bluetooth device (P.56)** and **Connect the Bluetooth device (P.57)**.

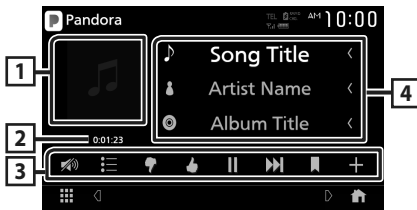

### 1 Artwork

Picture data is displayed if available from the current content.

### 2 Playing time

For confirmation of play time.

### 3 Operation keys

- : Searches for a station. For details on searching, see **Station list screen (P.29)**.
- (Thumbs down) : Thumbs down to the current contents and skips to the next contents.
- (Thumbs up) : Registers the current content as a favorite content.

- : Plays or pauses the content of the current station.
- : Skips the current song.  
(Note that this function is disabled when the Pandora skip limitation is exceeded.)
- (Bookmark Song) : Bookmarks a song in the current contents.
- : Creates a new station. See **Creates a new station (P.30)**.
- : Touch to attenuate/restore the sound.

### 4 Content information

Displays the information on the current content being played.

## Station list screen

You can perform the following functions from this screen.

### 1 Touch .

> Station List screen appears.

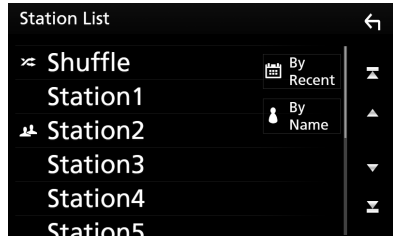

#### ■ To select the station

Touch the station name in the list.

#### ■ To sort the list by registered date

Touch **By Recent**. The list is sorted to begin with the last registered station.

#### ■ To sort the list in alphabetical order

Touch **By Name**. You can select the desired letter from the list which corresponds to the station name to help narrow the search range.

### NOTE

- You can operate Pandora by using the remote control function. However, you can perform only play, pause, and skip operations.

## ■ Creates a new station

1 Touch **+** .

2 Touch your desired item.

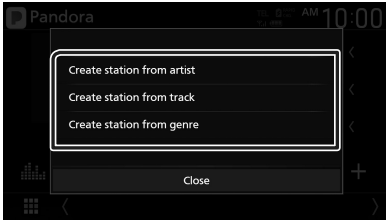

### ■ Create station from artist

Creates a new station based on the artist who is playing now.

### ■ Create station from track

Creates a new station based on the song being played.

### ■ Create station from genre

Displays the genre list screen.

## Genre list screen

1 Touch **Create station from genre** .

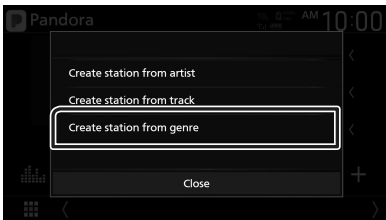

2 The selected genre is created as a new station.



## About Pandora®

### NOTE

- In the application on your device, log in and create an account with Pandora. (If you are not already a registered user, an account can also be created at [www.pandora.com](http://www.pandora.com).)
- Establish an Internet connection.
- Pandora is only available in certain countries. Please visit <http://www.pandora.com/legal> for more information.
- Because Pandora® is a third-party service, the specifications are subject to change without prior notice. Accordingly, compatibility may be impaired or some or all of the services may become unavailable.
- Some functions of Pandora® cannot be operated from this unit.
- For issues on using the application, please contact Pandora® at [pandora-support@pandora.com](mailto:pandora-support@pandora.com).

# USB

## Connecting a USB device

- 1 Connect the USB device with the USB cable. (P.89)

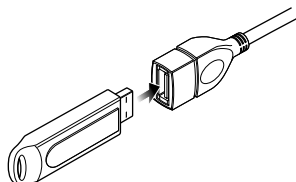

- 2 Press the **FNC** button.
  - ▶ Popup menu appears.
- 3 Touch .
  - ▶ HOME screen appears.
- 4 Touch .
- 5 Touch **USB**. (P.12)

### Disconnect the USB device

- 1 Press the **FNC** button.
  - ▶ Popup menu appears.
- 2 Touch .
- 3 Touch a source other than **USB**.
- 4 Detach the USB device.

### Usable USB device

You can use a mass-storage-class USB device with this unit.

The word "USB device" appearing in this manual indicates a flash memory device.

#### ● About the file system

The file system should be the one of the following.

- FAT16
- FAT32
- exFAT
- NTFS

#### NOTE

- Install the USB device in the place where it will not affect safe driving.

- You cannot connect a USB device via a USB hub and Multi Card Reader.
- Take backups of the audio files used with this unit. The files can be erased depending on the operating conditions of the USB device. We shall have no compensation for any damage arising from any erased data.

## USB Basic Operation

Most functions can be controlled from the source control screen and playback screen.

### Control screen

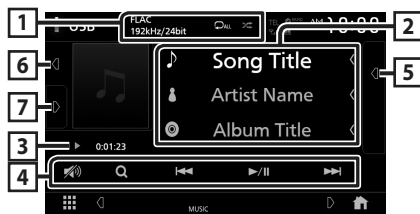

### Open the drawer



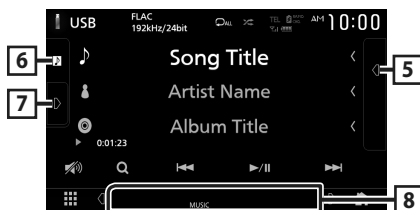

### Close the drawer



### 1 CODEC / /







- When a high-resolution source is played, its format information is displayed.
- : Repeats the current track/folder. Each time you touch the key, repeat modes are switched in the following sequence: File repeat () , Folder repeat () , Repeat all ()

-  : Randomly plays all tracks in the current folder. Each time you touch the key, random modes are switched in the following sequence: File random (  ), Random off (  )

**2 Track information**





Displays the information on the current file. Only a file name and a folder name are displayed if there is no tag information.

**3 Play mode indicator/ Playing time**

- , , etc.: Current play mode indicator  
Meanings of individual icons are as follows:  
 (play),  (fast forward),  (fast backward),  (pause).
- For confirmation of current playing position. You can drag the circle left or right to change the playing position. (Video file only)



**4 Operation keys**

-  : Searches track/file. For details on search operation, see **Search Operation (P.33)**.
-   : Searches the previous/next track/file.  
Touch and hold to fast forward or fast backward.
-  : Plays or pauses.
-  : Touch to attenuate/restore the sound.

**5 Content list**



- Touch the right side of the screen to display the Content list. Touch again to close the list.
- Displays the playing list. When you touch a track/file name on the list, playback will start.

**6 Artwork/ Analog meter**

- Displays/hides artwork area.
- The jacket of the currently playing file is displayed.
- When touched, switches the artwork to the analog meter.

**7 Function panel**

Touch the left side of the screen to display the function panel. Touch again to close the panel.

-   : Searches for the previous/next folder.
- **USB DEVICE CHANGE**  
Switches to another USB device when two USB devices are connected.

**8 Indicator Items**

- **VIDEO**: Identifies the video file.
- **MUSIC**: Identifies the music file.

Video screen



**9 File search area (Video file only)**

Touch to search for the next/previous file.

**10 Key display area (Video file only)**

Touch to display the control screen.



## Search Operation

You can search music or video files by the following operations.

- 1 Touch **Q**.
- 2 Touch **▼**.



- 3 Select a list type.



### NOTE

- For operations on the list screen, see *List screen (P.15)*.

## Category search

You can search for a file by selecting a category.

- 1 Touch **Category List**.
- 2 Select whether you search audio files or video files .
- 3 Touch the desired category.



- The list corresponding to your selection appears.

- 4 Touch to select the desired item in the list. Repeat this step until you find the desired file.

## Link search

You can search for a file of the same artist/album/genre as that in the current track.

- 1 Touch **Link Search**.
- 2 Touch the desired tag type. You can select from artists, albums and genres.



- The list corresponding to your selection appears.

- 3 Touch the desired item in the content list.

## Folder search

You can search for a file according to hierarchy.

- 1 Touch **Folder List**.
- 2 Touch the desired folder.

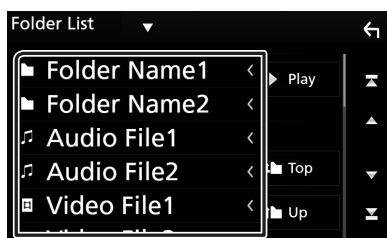

When you touch a folder its contents are displayed.

- 3 Touch to select your desired item in the list. Repeat this step until you find the desired file.

# iPod/iPhone

## Preparation

### Connectable iPod/iPhone

The following models can be connected to this unit.

Made for

- iPhone 7 Plus
- iPhone 7
- iPhone SE
- iPhone 6s Plus
- iPhone 6s
- iPhone 6 Plus
- iPhone 6
- iPhone 5s
- iPhone 5c
- iPhone 5
- iPod touch (6th generation)
- iPod touch (5th generation)

#### NOTE

- Latest compatible list of iPod/iPhone. For details, see [www.jvc.net/cs/car/ipod/](http://www.jvc.net/cs/car/ipod/).
- By connecting your iPod/iPhone to this unit with the iPod connection cable KS-U62 (optional accessory), you can supply power to your iPod/iPhone as well as charge it while playing music. Note that the power of this unit must be held on.
- If you restart playback after connecting the iPod, the music that has been played by the iPod is played first.

### Connect iPod/iPhone

#### Wired connection

##### Preparation

- Connect an iPod/iPhone with the KS-U62 (optional accessory) while CarPlay is not connected.
- With a CarPlay-capable iPhone, turn off CarPlay by operating the iPhone at functional setup before connecting iPhone. For details of the setup method, contact the manufacturer of the terminal.
- Plug the iPod/iPhone into the gray USB terminal with the KS-U62 (optional accessory).
- Only one iPod/iPhone can be connected.

#### 1 Connect the iPod/iPhone using the KS-U62. (P.89)

#### 2 Press the **FNC** button.

➤ Popup menu appears.

#### 3 Touch .

➤ HOME screen appears.

#### 4 Touch .

#### 5 Touch **iPod**. (P.12)

#### ● To disconnect the iPod/iPhone connected with the cable:

#### 1 Detach the iPod/iPhone.

#### Bluetooth connection

Pair the iPhone through Bluetooth.

##### Preparation

- To connect an iPhone via Bluetooth, register it as a Bluetooth device and do the profile setting for the connection beforehand. See **Register the Bluetooth device (P.56)** and **Connect the Bluetooth device (P.57)**.
- Connect an iPhone via Bluetooth while CarPlay and an iPod/iPhone are not connected via USB.

## iPod/iPhone Basic Operation

### Control screen



### Open the drawer



### Close the drawer



### 1 Track information

- Displays the information on the current file.
- Touch to display the category list screen. See **Category search (P.36)**.

### 2 Artwork/ Analog meter

- Displays/hides artwork area.
- The jacket of the currently being played file is displayed.
- When touched, switches the artwork to the analog meter.

### 3 Play mode indicator/ Playing time

- ▶, ▶▶, etc.: Current play mode indicator  
Meanings of individual icons are as follows:  
▶ (play), ▶▶ (fast forward), ◀◀ (fast backward), || (pause).

### 4 Operation keys

- 🔍 : Searches for a track/file. For details on search operation, see **Search Operation (P.36)**.
- ◀◀ ▶▶ : Searches for the previous/next track/file.  
Touch and hold to fast forward or fast backward.
- ▶▶ || : Plays or pauses.
- 🔊 : Touch to attenuate/restore the sound.

### 5 Content list

- Touch the right side of the screen to display the Content list. Touch again to close the list.
- Displays the playing list. When you touch a track/file name on the list, playback will start.

### 6 Repeat / Shuffle

- 🔁 : Repeats the current track/album. Each time you touch the key, repeat modes are switched in the following sequence:  
Song repeat ( 🔁 ), All songs repeat ( 🔁 ALL ), Repeat off ( 🔁 )
- 🎲 : Randomly plays all tracks in the current album. Each time you touch the key, random modes are switched in the following sequence:  
Song random ( 🎲 ), Random off ( 🎲 )

### 7 Indicator Items

- MUSIC: Identifies the music file.

## Search Operation

You can search music files by the following operations.

1 Touch **Q**.

2 Touch **▼**.



3 Select a list type.



### NOTE

- For operations on the list screen, see **List screen (P.15)**.

## Category search

You can search for a file by selecting a category.

1 Touch **Category List**.

2 Touch the desired category.

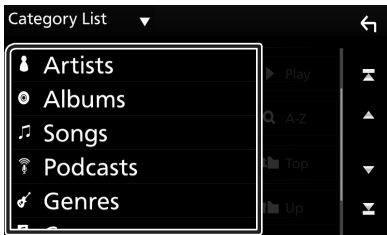

➤ The list corresponding to your selection appears.

3 Touch to select the desired item in the list. Repeat this step until you find the desired file.

## Link search

You can search for a file of the same artist/album/genre/composer as that in the current track.

1 Touch **Link Search**.

2 Touch the desired tag type. You can select from artists, albums, genres and composers.

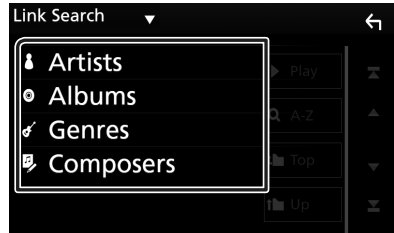

➤ The list corresponding to your selection appears.

3 Touch the desired item in the content list.

# Tuner

## Tuner Basic Operation

Most functions can be controlled from the source control screen.

To listen to the Tuner source, touch **Tuner** icon on the source selection screen. (P.12)

### Control screen



### Open the drawer

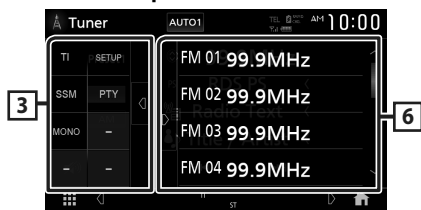

### Close the drawer

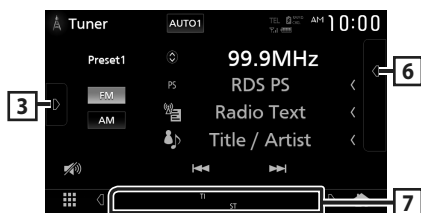

### 1 Information display

Displays the information on the current station:  
Frequency

Touching allows you to switch between Content A and Content B.

Content A: PS name, Radio Text, Title & Artist

Content B:PTY Genre, Radio Text plus

**Preset#**: Preset number

### 2 Seek mode

Touch to switch seek mode in the following sequence: **AUTO1**, **AUTO2**, **MANUAL**.

- **AUTO1** : Tunes in a station with good reception automatically.
- **AUTO2** : Tunes in the memorized stations one after another.
- **MANUAL** : Switches to the next frequency manually.

### 3 Function panel

Touch the left side of the screen to display the function panel. Touch again to close the panel.

- **TI** (FM only): Selects the traffic information mode. For details, see **Traffic Information (P.39)**.
- **SETUP** : Displays the TUNER SETUP screen. For details, see **Tuner Setup (P.39)**.
- **SSM** (FM only): Presets stations automatically. For details, see **Auto memory (P.38)**.
- **PTY** (FM only): Searches for a program by program type. For details, see **Search by program type (P.38)**.
- **MONO** (FM only): Selects the Monaural reception mode.

### 4 Band buttons

Switches bands (between FM and AM).

### 5 Operation keys

- : Tunes in a station. The method of switching frequencies can be changed (see **2** Seek mode).
- : Touch to attenuate/restore the sound.

### 6 Preset list

- Touching / allows you to change the display size.
- Recalls the memorized station.
- When touched for 2 seconds, stores the currently being received station in the memory.

### 7 Indicator Items

- **ST** : A stereo broadcast is being received.
- **MONO** : The forced monaural function is active.
- **TI** : Indicates the reception state of traffic information.  
White: TP is being received.  
Orange: TP is not being received.

## Memory Operation

### Auto memory (FM only)

You can store stations with good reception in the memory automatically.

**1** Touch **FM**.

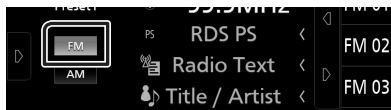

**2** Touch **SSM** on the left side of the screen. Touch **SSM**.

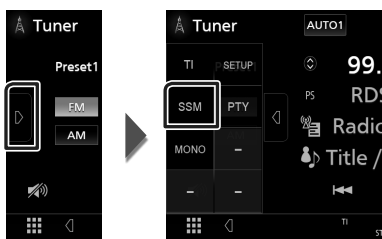

**3** Touch **Yes**.

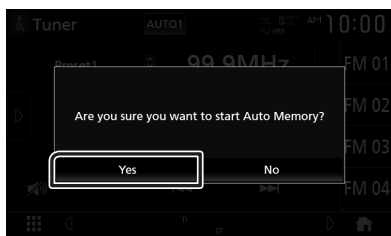

➤ Auto memory starts.

### Manual memory

You can store the currently being received station in the memory.

- 1** Select the station you wish to store in the memory.
- 2** Touch **FM#** (#:1-15) or **AM#** (#:1-5) in which you want to store the station for 2 seconds until a beep sounds.

## Selecting Operation

### Preset select

You can list and select memorized stations.

- 1** Touch **◀** on the right side of the screen. Select a station from the list.

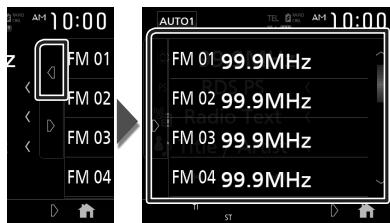

### Search by program type (FM only)

You can tune in the station broadcasting the specified type of program when listening to FM.

- 1** Touch **▶** on the left side of the screen. Touch **PTY**.

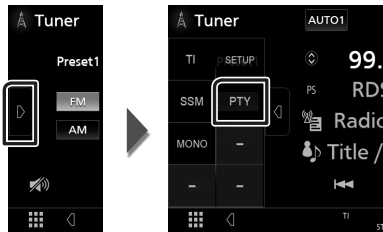

➤ PTY Search screen appears.

- 2** Select a program type from the list.

- 3** Touch **Search**.

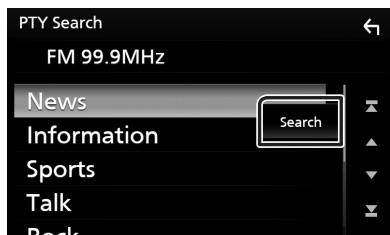

You can search for the station broadcasting the selected type of program.

## Traffic Information (FM only)

You can listen to and watch traffic information automatically when a traffic bulletin starts. However, this feature requires a Radio Broadcast Data System that includes TI information.

- 1 Touch **▶** on the left side of the screen. Touch **TI**.

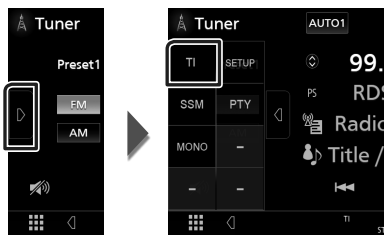

▶ Traffic information mode is set.

### When the traffic bulletin starts

The Traffic Information screen appears automatically.

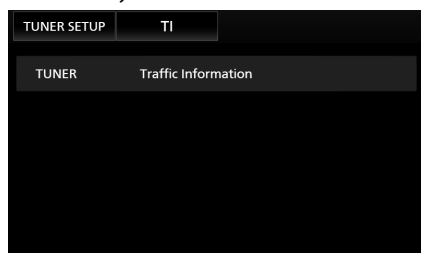

#### NOTE

- It is necessary to turn on the Traffic Information function in order to allow the Traffic Information screen to appear automatically.
- The volume setting made during reception of traffic information is automatically memorized. When the traffic information is received next time, this unit recalls the volume setting automatically.

## Tuner Setup

You can set tuner related parameters.

- 1 Touch **▶** on the left side of the screen. Touch **SETUP**.

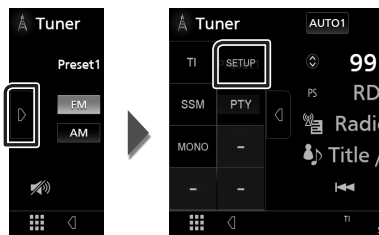

▶ TUNER SETUP screen appears.

- 2 Set each function as follows.

#### ■ Area Setting

The tuner channel interval changes depending on the area where you use this unit.

**US** (Default): Select this when using this unit in North/ Central/ South America. FM and AM intervals are set to 200 kHz and 10 kHz respectively.

**SA**: Select this when using this unit in South American countries where the FM interval is 50 kHz. The AM interval is set to 10 kHz.

**Europe**: Select this when using this unit in any other areas. FM and AM intervals are set to 50 kHz and 9 kHz respectively.

# SiriusXM®

## SiriusXM® Basic Operation

Only SiriusXM® brings you more of what you love to listen to, all in one place. Get over 140 channels, including commercial-free music plus the best sports, news, talk, comedy and entertainment. Welcome to the world of satellite radio. A SiriusXM Vehicle Tuner and Subscription are required. For more information, visit [www.siriusxm.com](http://www.siriusxm.com).

To listen to the SiriusXM source, touch the **SiriusXM** icon on the source selection screen. (P.12)

### Activating subscription

- Check your Radio ID.  
The SiriusXM Satellite Radio ID is required for activation and can be found by tuning in Channel 0 as well as on the label found on the SiriusXM Connect tuner and its package. The Radio ID does not include the letters I, O, S or F.
- Activate the SiriusXM Connect Vehicle Tuner using either one of the two methods below:
  - For users in U.S.A.  
Online: Visit [www.siriusxm.com/activatenow](http://www.siriusxm.com/activatenow)  
Phone: Call SiriusXM Listener Care at 1-866-635-2349
  - For users in Canada:  
Online: Visit <http://www.siriusxm.ca/help/activation-help/>  
Phone: Call XM customer Care at 1-877-438-9677

### NOTE

- To use SiriusXM® Satellite Radio, the optional accessory is necessary.

### Control screen



### Open the drawer

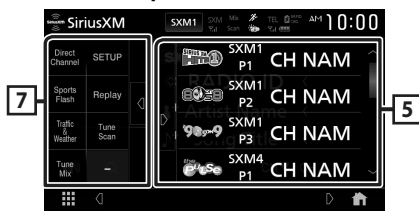

### Close the drawer

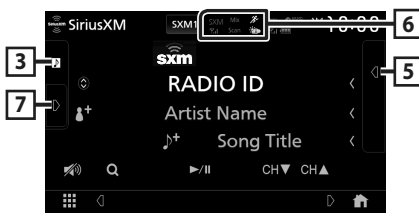

### 1 Information display

Displays the information on the current channel: Channel Name

**P#**: Preset number

**#CH**: Channel number

**Logo**: Channel logo

Touching  allows you to switch between Content A, Content B and Content C.

Content A: Artist Name, Song Title

Content B: Content Info, Category Name

Content C: Channel Description, Similar Channels

 : Touch for 2 seconds to register the artist of the current song as a Content Alert.

 : Touch for 2 seconds to register the current song as a Content Alert.

For details, see **Content Alerts (P.45)**.



## 2 Band button

Switches among bands. (SXM1/ SXM2/ SXM3/ SXM4)



## 3 Artwork

- Displays/hides artwork area.
- Displays the album artwork for most SiriusXM music channels



## 4 Operation keys

- **Q** : Display the Category search screen. For details on search operation, see **Category/ Channel search (P.43)**.
- **▶ II** : Plays or pauses. See **Replay (P.43)**.
- **CH▼ CH▲** : Selects a channel.
-  : Touch to attenuate/restore the sound.

## 5 Preset list

- Touching  /  allows you to change the display size.
- Recalls the memorized channel.
- When touched for 2 seconds, stores the currently being received channel in the memory.

## 6 Indicator display





Displays the "Mix" (TuneMix™), "Scan" (TuneScan™),  (Traffic&Weather), or  (SportsFlash™) indicator and the received signal strength of the SiriusXM tuner.

## 7 Function panel

Touch the left side of the screen to display the function panel. Touch again to close the panel.



- **Direct Channel**: Touch and enter the desired number. For details, see **Direct search (P.42)**.
- **SETUP**: Touch to display the SiriusXM SETUP screen. For details, see **SiriusXM Setup (P.46)**.
- **Replay/ Live**: Touch to turn on or off the replay mode. See **Replay (P.43)**.
- **Traffic & Weather**  
For SXV300 \*1

Traffic & Weather Now™ allows you to access the latest report whenever you want to hear it. Select your city from the set up menu **Select a City for Traffic & Weather (P.51)** and press the **Traffic & Weather** button to check the latest report. It will start from the beginning.

-  (White) : Played already.
-  (Green) : New information has arrived.
-  (Purple) : Playing.
-  (Gray) : No information.

### For SXV200 or SXV100 \*2

Turns the Traffic & Weather Jump function on or off.

-  (White) : Function on.
-  (Purple) : Playing.
-  (Gray) : Function off.
- **TuneScan** \*3 : Allows you to hear a few seconds of songs from each of the SmartFavorite music channels on the current preset band. See **TuneScan™ (P.44)**.
- **TuneMix** \*4 : When turned ON, shuffles the preset channels on P1-P6 to play a blend of songs from your favorite channels. See **TuneMix™ (P.44)**.
- **SportsFlash** \*4 : Displays during SportsFlash™. Touch to cancel the SportsFlash™ function and return to the previous channel. See **SportsFlash™ (P.46)** and **SportsFlash™ setup (P.50)**.

\*1 Compatible with SXV300 or later tuner models. It may take a few minutes after power on to get the first full report on your city. Traffic channels are not available in Canada.

\*2 When SXV200 or SXV100 is connected with this unit.

\*3 Compatible with SXV200 or later tuner models.

\*4 Compatible with SXV300 or later tuner models.

## Storing Channels in Preset Memory

You can store the current channel in memory.

- 1 Tune in the channel you wish to store in the memory.
- 2 Touch  on the right side of the screen.

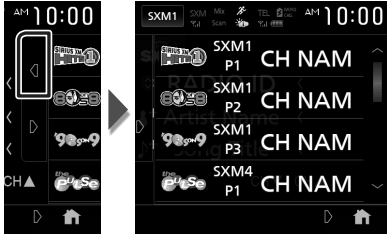

- 3 Touch **SXM(1-4) P(1-6)** in which you want to store the channel for 2 seconds until a beep sounds.

## Preset select

You can list and select memorized channels.

### To select from the preset list

- 1 Touch  on the right side of the screen. Select a channel from the list.

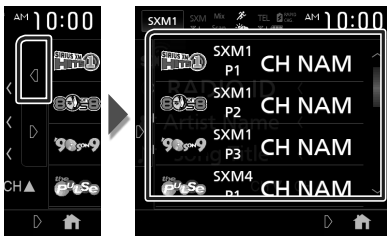

## Direct search

You can tune in a channel directly.

- 1 Touch  on the left side of the screen. Touch **Direct Channel**.

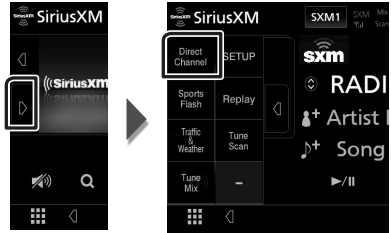

- 2 Enter the channel number and touch **Enter**.



### NOTE

- To clear the number you entered, touch **BS**.

## Category/Channel search

You can specify the desired category and select a channel.

### 1 Touch **Q**.



### 2 Select a category.



► Channel list appears.

### 3 Select the desired content from the list.



#### NOTE

- All channels in the selected category appear.
- Touching **All-Channels** displays all channels.
- Touch **Info Change** in the channel list. Select a desired item.  
Content info, channel name, artist name, song title, category name
- Categories which have the prefix "Featured -" are Featured Favorites.
- Featured Favorites are groups of channels that are created by the SiriusXM Programming department allowing you to discover new channels. Featured Favorite channels are dynamic and can change often, allowing you to discover new channels.
  - You can set whether to be notified when the featured seasonal theme is updated. **(P.51)**

## Replay

You can replay the last 60 minutes of the program from the current channel.

### 1 Touch **▶||** or **Replay** on the function panel.



Press to skip to the previous/next track.  
Press and hold to rewind or fast forward.



Plays or pauses.

#### ■ **Replay time bar/ Play mode indicator**

Displays the recorded data capacity and playback position.

▶, ▶▶, etc.: Current play mode indicator



Displays a list of recorded data on a program basis.

### 2 Touch **Q** to display an Instant Replay List screen.

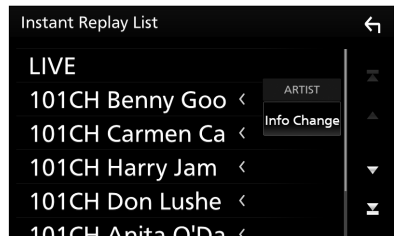

#### ■ **Instant Replay List**

Touching this plays back the displayed program.

**LIVE:** Touch to return to the live music/content.

#### ■ **Info Change**

Touch **Info Change**. Select a desired item.  
Content info, channel name, artist name, song title, category name

### To return to live music/content

- 1 Touch the left side of the screen.
- 2 Touch **Live**.

## TuneMix™

TuneMix™ plays a unique blend of songs from your Preset music channels of the current SiriusXM Preset Band, allowing you to build a custom channel from as few as two to as many as 6 music channels. You can even skip songs you don't want to hear.

- 1 Touch  on the left side of the screen. Touch **TuneMix** to set ON or OFF.

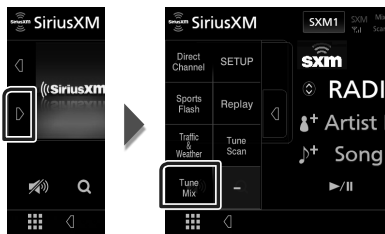

#### NOTE

- Compatible with SXV300 or later tuner models.

## SmartFavorites, TuneStart™

Preset channels 1 through 6 of the current band are SmartFavorites channels. The SiriusXM Vehicle Tuner automatically buffers the broadcast audio content of the SmartFavorites channels in the background.

You can rewind and replay up to 30 minutes of any of the missed news, talk, sports or music content on SmartFavorites channels. (see **Replay (P.43)**)

When tuning in a SmartFavorites channel, songs will be played from the beginning of each track (TuneStart™). You can enable/disable TuneStart. (see **TuneStart™ (P.51)**)

#### NOTE

- Compatible with SXV200 or later tuner models.

## TuneScan™

TuneScan™ is a feature that plays samples from the starts of multiple buffered songs from each of the SmartFavorites channels that predominantly play music selections. You have easy access to a large sampling of music content and can enjoy hearing a full song by stopping the scan on a song of interest.

- 1 Touch  on the left side of the screen.

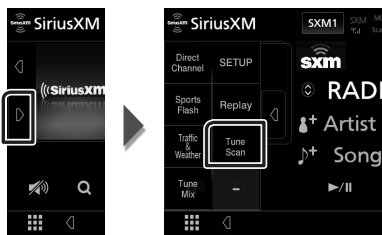

- 2 Touch **TuneScan** to begin scanning your SmartFavorites channels.

You will hear a few seconds of the songs from each of the SmartFavorite channels.

- 3 While your favorite song is being played, touch **TuneScan** again to start listening to that song.



- Scan finishes and the song is played continuously.

#### NOTE

- To cancel TuneScan™, touch the left side of the screen. Touch **TuneScan**.
- Touch and hold **TuneScan** to cancel TuneScan, and the music/content which was present on the channel before starting TuneScan will be played.
- Compatible with SXV200 or later tuner models.

## Traffic & Weather Now™

Traffic & Weather Now™ allows you to access the latest report whenever you want to hear it. Select your city in the set up menu **Select a City for Traffic & Weather (P.51)**.



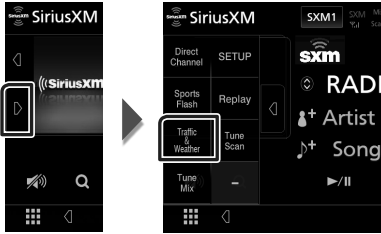

- 1 Touch  on the left side of the screen.



- 2 Touch **Traffic & Weather**.

The report starts from the beginning. To stop and return to the previous channel, touch it again.

### Indicator display

-  (White) : Played already.
-  (Green) : New information arrived.
-  (Purple) : Playing.
-  (Gray) : No information.

### NOTE

- Compatible with SXV300 or later tuner models.

## Content Alerts

When a broadcast program related to the registered artist, song or team starts, an Alert Content List screen appears to allow you to switch the current channel to the relevant channel.

- 1 When the broadcast of the registered content starts, an Alert Content List screen appears.

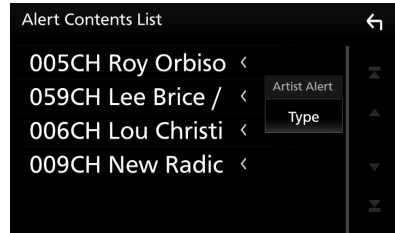

- 2 Select a content from the list.

### NOTE

- Touch **Info Change**. Select a desired item. Artist Alert, Song Alert, GameAlert™
- To learn how to register artists and songs for the Content Alert function, see  Information display in **SiriusXM® Basic Operation (P.40)**.
- To learn how to set up the Content Alerts function and select Teams for alerts, see **Content Alerts setup (P.48)**.

## SportsFlash™

SportsFlash™ will notify you when a big play happens during a game with one of your favorite sports teams. Choose to tune in and hear the play unfold like it was live. Continue listening to the game or return to your previous channel.

- 1 When a big play happens during one of the games, an Alert screen appears.



### ■ Jump

Touch to tune in that channel and play back the big play.

### ■ Ignore

Touch to cancel this specific SportsFlash alert. Touching **Ignore** will ignore this specific alert but will allow future alerts for this game.

### ■ Cancel

Touch to cancel SportsFlash alert. No alerts for this game will be displayed afterward.

## NOTE

- Compatible with SXV300 or later tuner models.
- To learn how to set up the SportsFlash alert function, see **SportsFlash™ setup (P.50)**.

## SiriusXM Setup

- 1 Touch **D** on the left side of the screen. Touch **SETUP**.

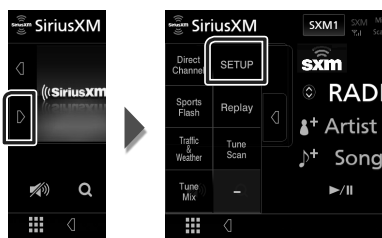

- SiriusXM SETUP screen appears.

See the following sections for each setting.

- Set up the parental code (**P.47**)
- Set up the Parental Control (**P.47**)
- Set up the skip channel select (**P.48**)
- Set up the Content Alerts (**P.48**)
- Set up the teams for SportsFlash™ (**P.50**)
- Select the city for Traffic & Weather Jump or Traffic & Weather Now™ (**P.51**)
- Select the Featured Bands Update Messages (**P.51**)
- Set up the TuneStart™ (**P.51**)
- Reset to the default settings (**P.51**)

## Parental code

You can set a SiriusXM parental code for Parental Control.

### 1 Touch **Parental Code** on the SiriusXM SETUP screen.

- Parental Pass Check screen appears.

#### NOTE

- The code number is set to "0000" as default.

### 2 Enter the current code number and touch **Enter**.

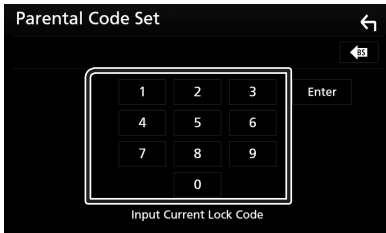

- Parental Pass 1st screen appears.

### 3 Enter the new code number and touch **Enter**.

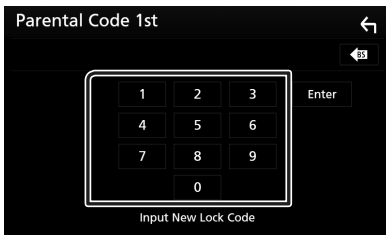

- Parental Pass 2nd screen appears.

### 4 Enter the same code number as that you entered in step 3 and touch **Enter**.

- The code number is confirmed and the SiriusXM parental code is now set.

## Parental Control

Parental Control is a feature that provides the user with the ability to prevent unauthorized access to mature content and user selected channels.

### 1 Touch **Parental Control** on the SiriusXM SETUP screen.

### 2 Touch **Mature, User or OFF**.

#### ■ OFF

Deactivates the parental mature and user locks.

#### ■ Mature

Locks channels classified as "mature" only.

#### ■ User

Locks only the selected channels.

### 3 Enter the parental code you originally input in as stated in *Parental code (P.47)* and touch **Enter**.

#### When selecting User

This allows you to limit access to any SiriusXM channel (Parental Lock Channel).

### 1 Touch **Parental Lock Channel Selection** on the SiriusXM SETUP screen.

- Parental Pass Check screen appears.

#### NOTE

- You need to set up a parental code beforehand as stated in *Parental code (P.47)*.

### 2 Enter the parental code you originally input as stated in *Parental code (P.47)* and touch **Enter**.

- Parental Lock Category Select screen appears.

### 3 Touch the desired category in the list.



- Displays all channels in the selected category.

**NOTE**

- Touch **All-Channels** to display all channels.
- To delete the parental lock channel setting, touch **Disable All** and then touch **YES** on the confirmation screen.

**4 Touch each channel on the list and set to ON or OFF.**

**ON:** Locks the channel.

**OFF:** Unlocks the channel.



**NOTE**

- Touch **Info Change**. Select a desired item, Content information, Channel name, Artist name, Song title, Category name.

**Skip channel select**

You can set the undesired channels to skip.

- 1 Touch Skip Channel Select.**
  - Skip Category Select screen appears.
- 2 Touch the desired category from the list.**



- Displays all channels in the selected category.

**3 Touch each channel in the list and set to ON or OFF.**

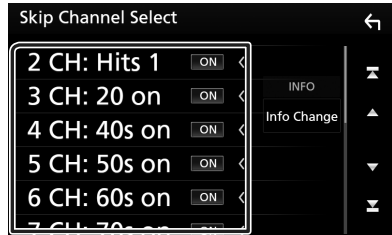

**NOTE**

- To delete the skip channel setting, touch **Disable All** and then touch **YES** on the confirmation screen.
- Touch **Info Change**. Select a desired item, Content information, Channel name, Artist name, Song title, Category name.
- Direct Channel and Preset Memory functions allow you to select channels.

**Content Alerts setup**

**Activating content alert**

- 1 Touch Content Alerts on the SiriusXM SETUP screen.**
  - Content Alerts is turned on or off. Default is "ON".

**Selecting the content for Content Alerts**

- 1 Touch Content Alerts Contents Set on the SiriusXM SETUP screen.**
- 2 Select the content you want to set up.**



**NOTE**

- To cancel all alert contents, touch **Clear** and then touch **YES** on the confirmation screen.
- Select **OFF** for the content you want to deactivate the content alert for.



- 3** Touch each content list item you want to check or uncheck.



**NOTE**

• You can select (☑) up to 60 artists or songs.

**● To delete the Artist and Song**

- 1** Touch **Delete**.

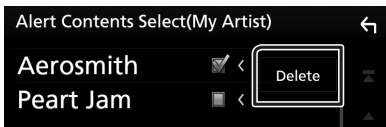

- 2** Touch the content(s) in the list you want to select.



■  **All**  
Selects all contents.

■  **All**  
Clears all check marks.

- 3** Touch **Delete** and then touch **YES** on the confirmation screen.

**To select a Team**

Get alerted when your favorite sports team is playing on another SiriusXM channel with GameAlert™

- 1** Touch **My Games**.



- 2** Touch the desired league in the list.

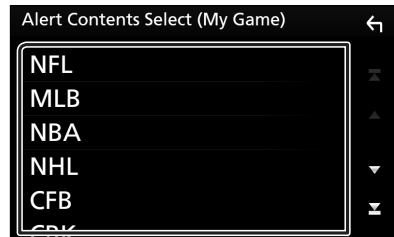

- 3** Touch the team(s) in the list you want to select.

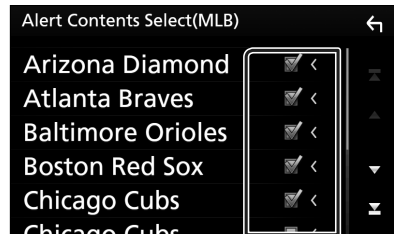

**NOTE**

• You can select (☑) up to 30 teams.

## SportsFlash™ setup

### Activating SportsFlash

- 1 Touch **SportsFlash** on the SiriusXM SETUP screen.

- SportsFlash is turned on or off. Default is "ON".

### Selecting SportsFlash Beep

- 1 Touch **SportsFlash Beep** on the SiriusXM SETUP screen.

- SportsFlash Beep is turned on or off. Default is "ON".

### Selecting the teams for SportsFlash

- 1 Touch **SportsFlash Team Set** on the SiriusXM SETUP screen.

- Team Set screen appears.

- 2 Touch **Edit**.

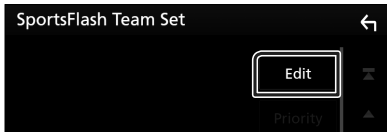

- 3 Touch the desired league in the list.

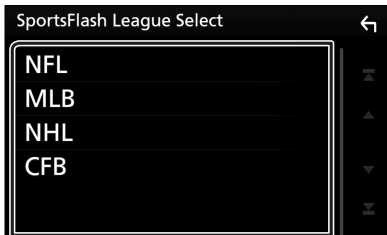

- 4 Touch each team(s) in the list you want to select.



- 5 Touch  twice.

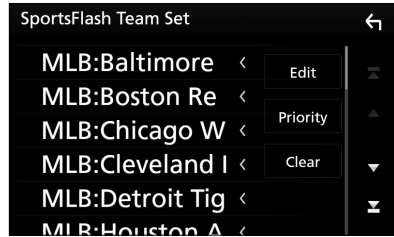

#### ■ Edit

Sets and removes teams.

#### ■ Priority

Sets the priority of a team.

#### ■ Clear

Removes all teams that have been set.

Touch **Clear**. When the confirmation screen appears, touch **YES**.

#### NOTE

- SportsFlash™ is available on SXV300 or later tuner models.
- Up to 50 teams can be added.

### Set the SportsFlash™ Team Priority

- 1 Touch **Priority**.



- 2 Set the priority of a team.

Each time you touch a Team, the priority is set or reset.

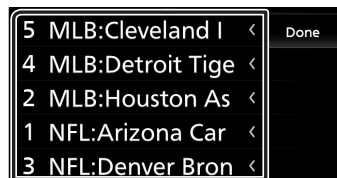

### 3 Touch **Done**.

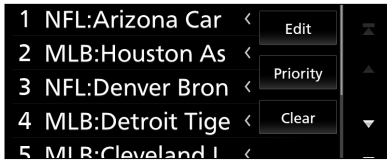

#### NOTE

- Priority can be set on up to 5 teams.
- When priority has already been set for 5 teams, it cannot be set for any other team. Delete an unnecessary team.

### ■ Select a City for Traffic & Weather

You can select a city for which you wish to receive SiriusXM Traffic & Weather broadcasts and hear them from the beginning.

- 1 Touch **Traffic & Weather City Select** on the SiriusXM SETUP screen.
- 2 Touch ◀ and ▶ to select a city.

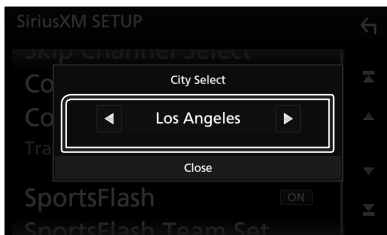

### ■ Selecting Featured Bands Update Messages

You can set whether to be notified when the featured seasonal theme is updated.

- 1 Touch **Featured Bands Update Messages** on the SiriusXM SETUP screen. Featured Bands Update Messages is turned on or off.

### ■ TuneStart™

- 1 Touch **Tune Start** on the SiriusXM SETUP screen. The TuneStart is turned on or off. Default is "ON".

### ■ Reset

- 1 Touch **SiriusXM Reset** on the SiriusXM SETUP screen.
  - ▶ Confirmation screen appears.
- 2 Touch **YES**.
  - ▶ All SiriusXM settings are reset to defaults.

# Other External Components

## View Camera

### NOTE

- To connect a camera, see **P.88**.
- To use a rear view camera, a REVERSE lead connection is required. **(P.87)**
- If **Rear Camera Interruption** is active the camera screen is displayed when you shift the gear to the reverse (R) position.

### Display the camera screen

- 1 Press the **FNC** button.  
➤ Popup menu appears.
- 2 Touch **Camera**.



➤ View camera screen appears.

- 3 Adjust each item as follows.

To erase the caution message, touch the screen.



- 1 **Camera off**

Touch to exit the camera screen.

### Camera Setup

- 1 Press the **FNC** button.  
➤ Popup menu appears.
- 2 Touch .  
➤ HOME screen appears.
- 3 Touch .  
➤ SETUP Menu screen appears.
- 4 Touch **Camera**.



➤ Camera screen appears.

- 5 Set each item as follows.

#### ■ Rear Camera Interruption

**ON**: Displays the picture from the rear view camera when you shift the gear to the reverse (R) position.

**OFF** (Default): Select this when no camera is connected.

#### ■ Parking Guidelines

You can display parking guidelines to enable easier parking when you shift the gear to the reverse (R) position.

Default is "ON".

#### ■ Guidelines SETUP

If you select **ON** for **Parking Guidelines**, you can adjust the parking guidelines. See **To adjust the parking guidelines (P.53)**.

## To adjust the parking guidelines

### NOTE

- Install the rear view camera in the appropriate position according to the instruction manual supplied with the rear view camera.
- When adjusting the parking guidelines, make sure to apply the parking brake to prevent the car from moving.

- 1 Touch **ON of Parking Guidelines** in the Camera screen. (P.52)
- 2 Touch **Guidelines SETUP** on the Camera screen.
- 3 Adjust the parking guidelines by selecting the  mark.

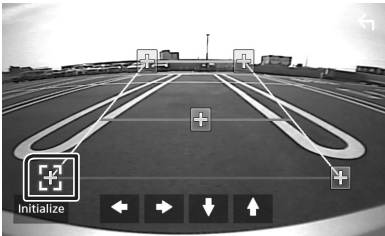

- 4 Adjusting the position of the selected mark.

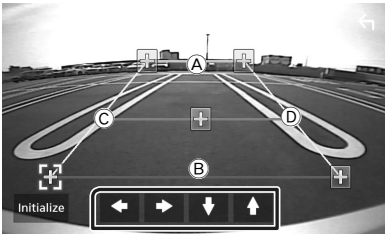

Make sure that lines **(A)** and **(B)** are horizontally parallel, and that lines **(C)** and **(D)** are of the same length.

### NOTE

- Touch **Initialize** and then touch **Yes** to set all the  marks to their initial default position.

## External audio/video players (AV-IN)

- 1 Connect an external component to the AV-IN input terminal. (P.88)
- 2 Select **AV-IN** as the source. (P.12)
- 3 Turn on the connected component and start playing the source.

## OEM Features Operation

By connecting this unit to the bus system of the vehicle using an iDataLink (commercially available), this unit can access the satellite radio source provided for the vehicle and can display vehicle information on this unit.

**1 Press the FNC button.**

➤ Popup menu appears.

**2 Touch .**







➤ HOME screen appears.

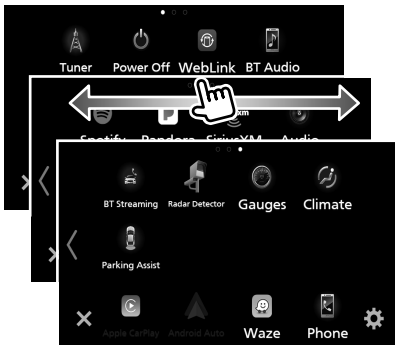

**3 Touch .**



**4 Touch icon.**



	• Displays the control screen of the satellite radio source provided for the vehicle.
	• Displays the control screen of the media player source provided for the vehicle.
	• Displays the control screen of the Bluetooth Hands Free function provided for the vehicle.
	• Displays the control screen of the Bluetooth streaming source provided for the vehicle.
	• Displays information about the instruments such as a speedometer.
	• Displays information about the air conditioner of the vehicle. *
	• Displays information about the Parking Distance Sensor of the vehicle.

	• Displays information about the tire pressures of the vehicle. *
	• Displays information about the Radar Detector. *

\*These ADS adapter features are displayed as the Information Window on the Home screen. **(P.11)**  
You can display the relevant screens by touching the Information Window.

**NOTE**

- Displayable screens, button names, and screen names vary depending on the type of the connected iDataLink and the model of the vehicle. For more details, access the following URL:  
[www.idatalink.com/](http://www.idatalink.com/)

# Bluetooth Control

Using the Bluetooth function allows you to use various functions such as listening to the audio file and making/receiving a call.

## Information for using Bluetooth® devices



Bluetooth is a short-range wireless radio communication technology for mobile devices such as mobile phones, portable PCs, and other devices.

Bluetooth devices can be connected without cables and communication with each other.

### NOTE

- While driving, do not perform complicated operations such as dialing numbers, using the phone book, etc. When you perform these operations, stop your car in a safe place.
- Some Bluetooth devices may not be connected to this unit depending on the Bluetooth version of the device.
- This unit may not work for some Bluetooth devices.
- Connecting conditions may vary depending on your environment.
- Some Bluetooth devices are disconnected when this unit is turned off.

## About the cell-phone and Bluetooth audio player

This unit conforms to the following Bluetooth specifications:

### Version

Bluetooth Ver. 4.1

### Profiles

#### Cell-phone:

HFP (V1.7) (Hands Free Profile)

SPP (Serial Port Profile)

PBAP (Phonebook Access Profile)

#### Audio player:

A2DP (Advanced Audio Distribution Profile)

AVRCP (V1.6) (Audio/Video Remote Control Profile)

### Sound codec

SBC, AAC

### NOTE

- The units supporting the Bluetooth function have been certified for conformity with the Bluetooth Standard according to the procedure prescribed by Bluetooth SIG.
- However, it may be impossible for such units to communicate with your cell-phone depending on its type.

## Register the Bluetooth device

It is necessary to register the Bluetooth audio player or cell-phone in this unit before using the Bluetooth function.

You can register up to 10 Bluetooth devices.

### NOTE

- Up to 10 Bluetooth devices can be registered. If an attempt is made to register the 11th Bluetooth device, the Bluetooth device connected on the earliest date will be deleted to register the 11th one.
- This unit is compatible with the Apple Easy Pairing function. When an iPod touch or iPhone is connected to this unit, an authentication dialog appears. Performing operation for authentication on this unit or iOS smartphone registers the smartphone as a Bluetooth device.

**1 Search for the unit ("KW-V\*\*\*\*"/ "KW-M\*\*\*\*") from your smartphone/cell-phone.**

Complete steps 1 to 4 within 30 seconds.

**2 Operate your smartphone/cell-phone according to the displayed messages.**

- **Confirm the request both on the smartphone/cell-phone.**

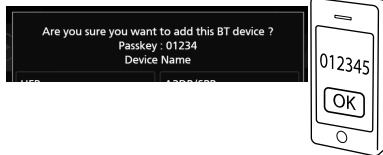

- **Input the PIN Code in your smartphone/cell-phone.**

PIN Code is set to "0000" as the default.

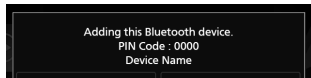

**3 Select the function you want to use.**

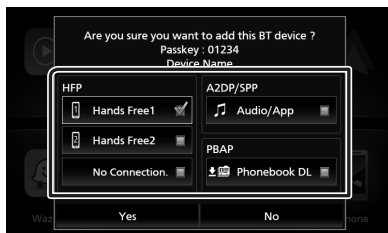

- **HFP Hands Free1 / Hands Free2 / No Connection.**

Select the hands-free number to connect.

- **A2DP/SPP Audio/App**

Select if you want to use the audio player app in your smartphone over A2DP, and the other apps in your smartphone over SPP.

- **PBAP Phonebook DL**

Select if you want to transfer your phonebook data.

**4 Touch Yes.**

When data transmission and connection have completed, the Bluetooth connection icon appears on the screen.

## Bluetooth Setup

**1 Press the FNC button.**

➤ Popup menu appears.

**2 Touch .**

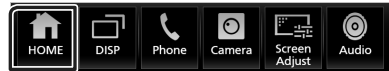

➤ HOME screen appears.

**3 Touch .**



➤ SETUP Menu screen appears.

**4 Touch Bluetooth.**



➤ Bluetooth SETUP screen appears.

See the following section for each setting.

- Connect the Bluetooth device (**P.57**)
- Change the PIN Code (**P.58**)
- Change the device name (**P.58**)



## ■ Connect the Bluetooth device

- 1 Touch **Select Device** on the Bluetooth SETUP screen.

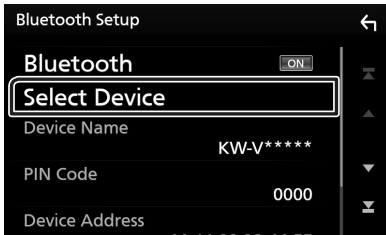

- 2 Touch the name of the device you want to connect.



➤ Profile select screen appears.

### NOTE

- If the icon is lighted, it means that the unit will use that device.

- 3 Set each profile as follows.

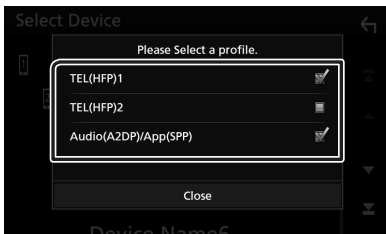

#### ■ TEL (HFP) 1, TEL (HFP) 2

Select when the device is connected with the unit as hands-free phone 1 or 2.

#### ■ Audio (A2DP)/App (SPP)

Select to interwork with an application installed in a smartphone or to use as an audio player.

- 4 Touch **Close**.

## To delete the registered Bluetooth device

- 1 Touch **Delete**.

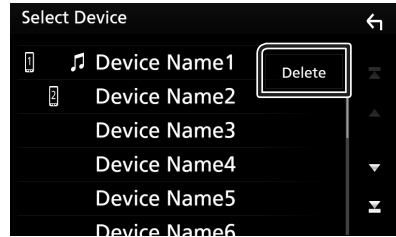

- 2 Touch the device name to check.



#### ■ All

Selects all Bluetooth devices.

#### ■ All

Clears all check marks.

- 3 Touch **Delete**.

➤ Confirmation message appears.

- 4 Touch **Yes**.

### Change the PIN Code

- 1 Touch **PIN Code** on the Bluetooth SETUP screen.
  - Change PIN Code screen appears.
- 2 Touch and hold .
- 3 Input the PIN Code.

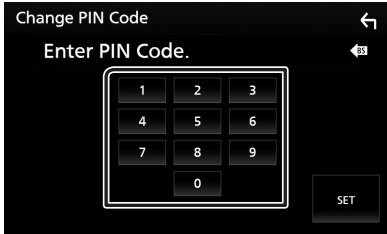

- 4 Touch **SET**.

### Change the device name

- 1 Touch **Device Name** on the Bluetooth SETUP screen.
  - Change Device Name screen appears.
- 2 Touch and hold .
- 3 Input the device name.



- 4 Touch **Enter**.

## Playing the Bluetooth Audio Device

Most functions can be controlled from the source control screen.







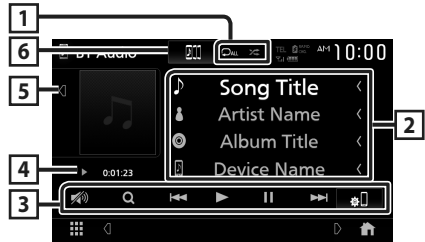

To select Bluetooth source, touch **BT Audio** icon on the source selection screen. (P.12)

### Bluetooth basic operation

#### Control screen









#### 1 / \*

-  : Repeats the current track/folder. Each time you touch the key, repeat modes are switched in the following sequence: File repeat (  ), Folder repeat (  ), All songs repeat (  ), Repeat off (  )
-  : Randomly plays all tracks in the current folder. Each time you touch the key, random modes are switched in the following sequence: Folder random (  ), All random (  ), Random off (  )

#### 2 Information display \*

- Displays the name of track information.
- Connected device name.

#### 3 Operation keys \*

-  : Searches for a file. See **File search** (P.60).
-   : Searches for the previous/next content.  
Touch and hold to fast forward or fast backward.
-  : Plays.
-  : Pauses.
-  : Displays the Bluetooth SETUP screen.
-  : Touch to attenuate/restore the sound.

#### 4 Play mode indicator/ Playing time

▶, II: Current play mode indicator

Meanings of individual icons are as follows:

▶ (play), ▶▶ (fast forward), ◀◀ (fast backward), II (pause), ■ (stop).

#### 5 Artwork/ Analog meter

- Displays/hides artwork area.
- When touched, switches the artwork to the analog meter.

#### 6 JVC Streaming DJ

Bluetooth audio devices can be switched easily to play music. See **JVC Streaming DJ (P.59)**.

\* These items appear only when the audio player which supports AVRCP profile is connected.

##### NOTE

- The operation buttons, indications and information displayed on the screen differ depending on the connected device.
- If the operation keys do not appear, operate from the player.
- Depending on your cell-phone or audio player, sound may be heard and controlled but text information may not appear.
- If the volume is too low, raise it on your cell-phone or audio player.



#### JVC Streaming DJ

Up to five Bluetooth audio device can be connected and switched easily to play music.



1 Touch .

▶ A list of registered devices is displayed.

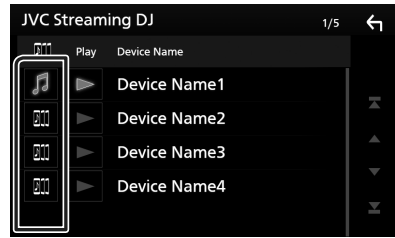

2 Touch  of device name you want to connect.

- Touching  displays the Bluetooth device connection setup screen. **(P.57)**
- Touching  on the left of the connected device () disconnects this device.





- : Device used normally.
- : Device used for JVC Streaming DJ.

3 Touch  (white) on the left of the name of the device to be played.

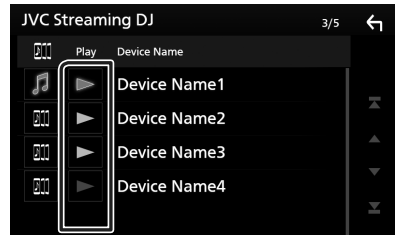
 (white) changes to  (Blue) and starts playback.



-  (Gray): Not connected.
-  (White): Connected.
-  (Blue): During playback.

4 Touch .

##### NOTE

- If a connected Bluetooth audio device is operated to play music, connections are switched.
- When a Bluetooth source is switched to another one, its settings are deleted and the connection is restored to the connection before source switching.

## File search

- 1 Touch **Q**.
- 2 Touch the desired file or folder.

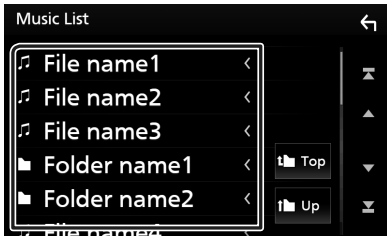

When you touch a folder its contents are displayed.

- 3 Touch the desired item in the content list.
  - ▶ Playback starts.

### NOTE

- For operations in the list screen, see **List screen (P.15)**.

## Using the Hands-Free Unit

You can use the telephone function by connecting the Bluetooth telephone to this unit.

### NOTE

- While Apple CarPlay or Android Auto is connected, the Bluetooth Hands-Free function and two Bluetooth devices connections cannot be used. Only the Apple CarPlay or Android Auto Hands-Free function can be used.

## Make a call

- 1 Press the **FNC** button.
  - ▶ Popup menu appears.
- 2 Touch **Phone**.

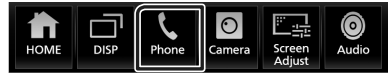

- ▶ Hands Free screen appears.

### NOTE

- If your mobile phone supports PBAP, you can display the phone book and call lists onto the touch panel screen when the mobile phone is connected.
  - Phone book: up to 1000 entries
  - Up to 50 entries including dialed calls, received calls, and missed calls

- 3 Select a dialing method.



- : Call using call records
- : Call using the phonebook
- : Call using the preset number
- : Call by entering a phone number

### ● Select the cell-phone to use

When you connect two cell-phones

- 1) Touch   to select the phone you want to use.

### ● Bluetooth SETUP

- 1) Touch .  
Bluetooth SETUP screen appears.

### ● Voice Recognition

- 1) Touch . (P.62)

#### NOTE

- Status icons such as battery and antenna icons may differ from those displayed on the cell-phone.
- Setting the cell-phone in the private mode can disable the hands-free function.

### Call using call records

- 1 Touch .
- 2 Select the phone number from the list.



### Call by entering a phone number

- 1 Touch .
- 2 Enter a phone number with number keys.



- 3 Touch .

### Call using the preset number

- 1 Touch .
- 2 Touch the name or phone number.



### Call using the phonebook

- 1 Touch .
- 2 Touch **Q A-Z**.
- 3 Select the initial.

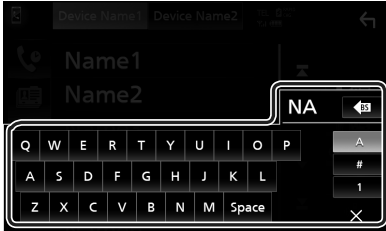

- Characters with no corresponding name will not appear.
- A first character with an accent character such as “ü” can be searched for with a non-accent character “u”. A character with an accent character in a sentence cannot be searched for.

- 4 Select the person you want to call from the list.

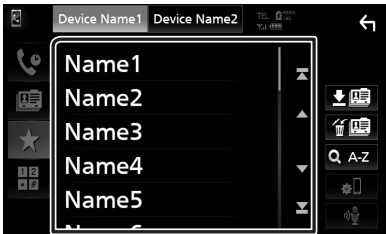

- 5 Select the phone number from the list.

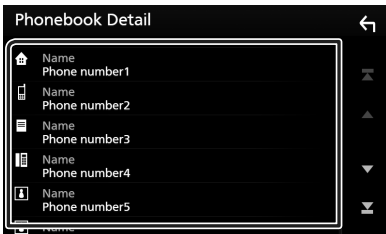

#### NOTE

- You can sort the phone numbers in the list by last name or first name. For details, see **Hands-Free Setup (P.65)**.

### Voice Recognition

You can access the voice recognition function of the cell-phone connected to this unit. You can search the cell-phone phonebook by voice. (The functionality depends on the cell-phone.)

- 1 Press the **FNC** button for 1 second.





- Voice Recognition screen appears.

- 2 Start speaking.

#### NOTE

- You can use the voice recognition function by touching  on the Hands Free screen.

## Receive a call

- 1 Touch  to answer a phone call or  to reject an incoming call.



### NOTE

- While monitoring the picture from the view camera, this screen does not appear even if a call comes in.

## To end call

- 1 While talking, touch .

## Operations during a call



### ● Adjust the volume of your voice

- 1) Touch **Speech Quality**.
- 2) Touch ◀ or ▶ for **Microphone Level**.



### ● Adjust the receiver volume

Press the - or + button.

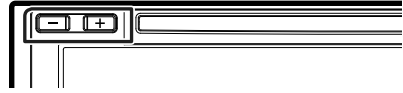



### ● Mute your voice

Touch  to mute or not to mute your voice.

### ● Output the dial tone

Touch **DTMF** to display the tone input screen. You can send tones by touching desired keys on the screen.

### ● Switching between speaking voice output destinations

Touching  /  each time switches speaking voice output destinations between the cell-phone and the speaker.

### ● Call-waiting

When you receive a new call while talking on the phone, you can answer the newly received call by touching . The current call is put on hold.

Each time you touch , the caller will change to the other one.

When you touch , the current call will end to be switched to the call waiting on hold.

### ● To close the Hands-Free popup screen

Touching × to close the Hands-Free popup screen. To display it again, touch  after pressing the **FNC** button.

## Bluetooth Control

### Phone number preset

You can register frequently used phone numbers in this unit.

1 Touch .

2 Touch **Edit**.



3 Select where to preset.

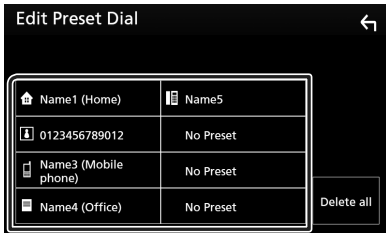

#### Delete all

To delete all preset numbers, touch **Delete all** and then touch **OK** on the confirmation screen.

4 Select how to preset.

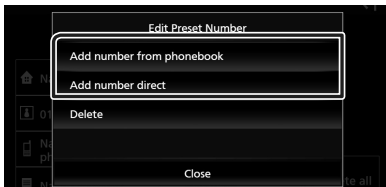

#### Add number from phonebook

Select the number to preset from the phonebook. See **Call using the phonebook (P.62)**.

#### Add number direct

Enter the telephone number directly and touch **SET**. See **Call by entering a phone number (P.61)**.

#### Delete

To delete a preset number, touch **Delete** and then touch **OK** on the confirmation screen.

### Phonebook transfer

You can transfer phonebook data from your Bluetooth smartphone using PBAP.

1 Touch .

2 Touch .



> Phonebook data transfer starts.

#### NOTE

- If the Phonebook contains more than 1000 entries, Phonebook data cannot be transferred.
- If no Phonebook has been downloaded, touching **Download Phonebook Now** will start downloading the Phonebook.

### Phonebook deletion

1 Touch .

2 Touch the name to check.

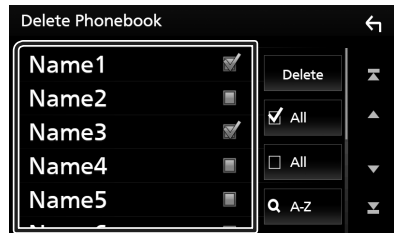

#### All

Checks all boxes.

#### All

Clears all check marks.

3 Touch **Delete**.

> Confirmation message appears.

4 Touch **OK**.



## Hands-Free Setup

You can make various settings for the Hands-Free function.

### 1 Press the **FNC** button.

➤ Popup menu appears.

### 2 Touch .

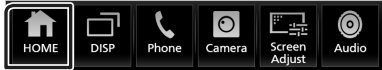

➤ HOME screen appears.

### 3 Touch .



➤ SETUP Menu screen appears.

### 4 Touch **Bluetooth**.



➤ Bluetooth SETUP screen appears.

### 5 Touch **TEL SETUP**.

➤ TEL SETUP screen appears.

### 6 Set each function as follows.

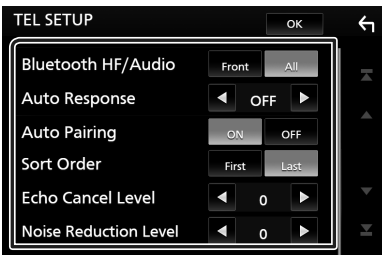

#### ■ **Bluetooth HF/Audio**

Select the speakers to output the sound from the cell-phone (such as phone call voice and ringing tone) and Bluetooth audio player.

**Front**: Outputs sound from the front speakers.

**All** (Default): Outputs sound from all speakers.

#### ■ **Auto Response**\*

Set the automatic response time to pick-up an incoming call.

**OFF** (Default): Turns off the Automatic response function.

**1 / 5 / 10 / 15 / 20 / 25 / 30**: Sets the ringing time (second).

#### ■ **Auto Pairing**

When set to "ON", the Apple Auto Pairing function is turned on to automatically register the iPod touch or iPhone connected to this unit.

**ON** (Default): Turns on the Apple Auto Pairing function.

**OFF**: Turns off the Apple Auto Pairing function.

#### ■ **Sort Order**

Set how to sort the data in the cell-phone phonebook.

**First**: Sorts data by the first name.

**Last** (Default): Sorts data by the last name.

#### ■ **Echo Cancel Level**

Adjust the level of echo cancellation.

Default is "0".

#### ■ **Noise Reduction Level**

Reduce the noise generated in the surrounding environment without changing the microphone volume. Use this function when the voice of caller is not clear. Default is "0".

\* Either the auto response time set on this unit or the time set on the cell-phone, whichever is shorter takes effect.

### 7 Touch **OK**.

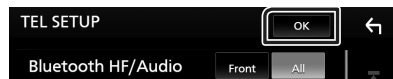

# Setup

## Monitor Screen Setup

You can adjust the image quality of video, menu screen, etc.

- 1 Press the **FNC** button.  
▶ Popup menu appears.
- 2 Touch **Screen Adjust**.

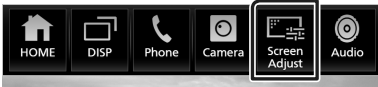

▶ Screen Control screen appears.

- 3 Adjust each setting as follows.

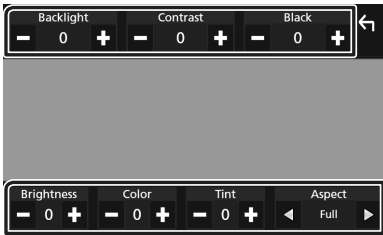

### ■ Backlight / Contrast / Black / Brightness / Color / Tint

Adjust each setting.

### ■ Aspect

Select a screen mode.

**Full**: Changes the aspect ratio of video and displays video fully on the screen.

**Normal**: Displays video at the ratio of 4:3.

**Auto**:

DVD, VCD and disc media: 16:9 video is displayed in the Full mode and 4:3 video is displayed in the Regular mode.

USB device: Displays video fully (vertically or horizontally) with no ratio change.

### NOTE

- Settings to adjust vary depending on the current source.

## System Setup

- 1 Press the **FNC** button.  
▶ Popup menu appears.
- 2 Touch .

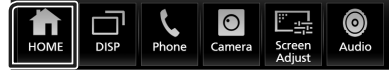

▶ HOME screen appears.

- 3 Touch .

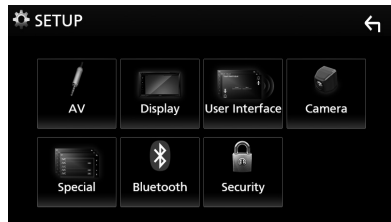



See the following section for each setting.

- Set up AV ([P.71](#))
- Set up display ([P.69](#))
- Set up the user interface ([P.67](#))
- Set up camera ([P.52](#))
- Set up special ([P.68](#))
- Set up Bluetooth ([P.56](#))

## User Interface Setup

You can setup user interface parameters.

- 1 Press the **FNC** button.
  - Popup menu appears.
- 2 Touch .
  - HOME screen appears.
- 3 Touch .
  - SETUP screen appears.
- 4 Touch **User Interface**.



- User Interface screen appears.

### 5 Set each parameter as follows.

#### ■ Beep

Turn the key touch tone on or off.  
Default is "ON".

#### ■ Information Window SETUP

Set up the Information window displayed on the Home screen. (P.16)

#### ■ Monitor Touch Control Effect

Determine whether to show the trace of finger under monitor touch control. (P.10)  
"ON" (Default)/"OFF"

#### ■ Parking Assist Display

When an ADS adapter is connected, you can display information about obstacles around the car.

**ON**: Always displays information.

**Dyn.** (Default): Displays information when the sensor detects obstacles.

**OFF**: Cancels this function.

This can be set when the iDataLink (commercially available) is connected.

#### ■ Parking Assist Position

Select where to display information about obstacles on the screen (left or right).

"Left"/"Right" (Default)

This can be set when the iDataLink (commercially available) is connected.

#### ■ Language Select

Select a language.

#### ■ Touch Panel Adjust

Adjust the sensing position of the touch panel. (P.68)

#### ■ Time Format

Select the time display format.  
"12-Hour" (Default)/"24-Hour"

#### ■ Clock

**GPS-SYNC** (Default): Synchronizes the clock time with the GPS.

**Manual**: Set the clock manually.

#### ■ Time Zone

Select the time zone.

#### ■ Clock Adjust

If you select **Manual** for Clock, adjust the date and time manually. (P.68)

#### ■ DISP Key

Select the source screen displayed when  in the popup menu screen is pressed.

**OFF**: Displays the control screen of the current source.

**Mirroring** (Default): Switches to the App screen from the connected iPhone/Android device or to the Apple CarPlay screen from the connected iPhone when the button is pressed. (P.23)

## Setup

### Adjust the date and time manually.

- 1 Touch **Clock** on the User Interface screen.
- 2 Select **Manual**.
- 3 Touch **Time Zone** on the User Interface screen.
- 4 Select the time zone.
- 5 Touch **Clock Adjust** on the User Interface screen.
- 6 Adjust the date, then adjust the time.

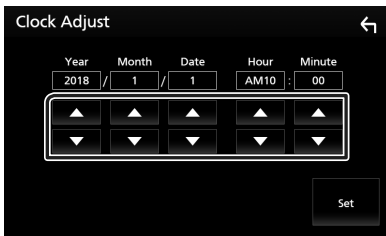

- 7 Touch **Set**.

### Touch panel adjustment

- 1 Touch **Touch Panel Adjust** on the User Interface screen.
  - Touch Panel Adjust screen appears.
- 2 Follow the instruction on the screen and long touch the center of each .





#### NOTE

- To cancel the touch panel adjustment, touch **Cancel**.
- To reset it to the default, touch **Reset**.

## Special Setup

You can setup special parameters.

- 1 Press the **FNC** button.
  - Popup menu appears.
- 2 Touch .
- HOME screen appears.
- 3 Touch .
- SETUP screen appears.
- 4 Touch **Special**.

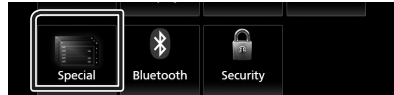

- Special screen appears.

- 5 Set each parameter as follows.

#### DEMO

Select the demonstration mode. Default is "ON".

#### Software Information

Confirm the software version of this unit.  
(P.68)

#### Open Source Licenses

Display the open source licenses.

#### Initialize

Touch **Initialize** and then touch **Yes** to set all the settings to the initial default settings.

- Audio SETUP Memory is not initialized.

### Software Information

You can confirm the software version of this unit.

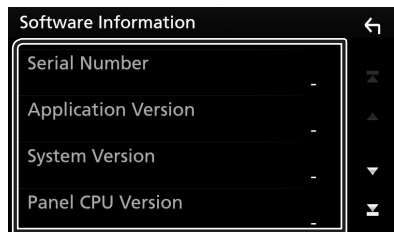

- 1 Touch **Software Information** in the Special screen.
- 2 Confirm the software version.



**NOTE**

- For how to update the software, see the relevant update procedure manual which comes with the software.

**Display Setup**

- 1 Press the **FNC** button.
  - ▶ Popup menu appears.
- 2 Touch .
  - ▶ HOME screen appears.
- 3 Touch .
  - ▶ SETUP screen appears.
- 4 Touch **Display**.



- ▶ Display screen appears.

**5 Set each parameter as follows.****■ Dimmer**

Select the dimmer mode.

**OFF**: Does not dim the display and buttons.

**ON**: Dims the display and buttons.

**SYNC** (Default): Turns the dimmer function on or off when the vehicle light control switch is turned on or off.

**■ OSD Clock**

Select if you want to display the clock while watching DVD video, etc.

"ON" (Default)/ "OFF"

**■ Wallpaper Customize**

You can change the wallpaper image or color. (P.69)

**■ Viewing Angle**

If it is hard to see the image on the screen evenly, adjust the viewing angle. The smaller the (negative) value, the more whitish the image on the screen looks.

"0" (Default)/ "-1"/ "-2"/ "-3"

**Change the wallpaper image**

- 1 Touch **Wallpaper Customize** on the Display screen.
- 2 Select an image.

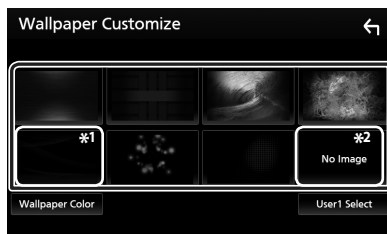

\*1 Select a wallpaper color in advance.

\*2 Select an original image in advance.

**To select wallpaper color**

- 1 Touch **Wallpaper Color** on the Background screen.
- 2 Select a wallpaper color.



- 3 Touch .

## Setup

### To register an original color

You can register your original color.

- 1 Touch **User** on the Wallpaper Color screen.
- 2 Touch **Adjust**.
- 3 Use **—** and **+** to adjust each color value.

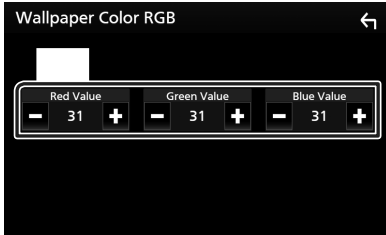

- 4 Touch  .

### To register an original image

You can load an image from the connected USB device and set it as the wallpaper image. Before starting this procedure, it is necessary to connect the device which has the image to load.

- 1 Touch **User1 Select** on the Wallpaper Customize screen.
- 2 Select the image to load.



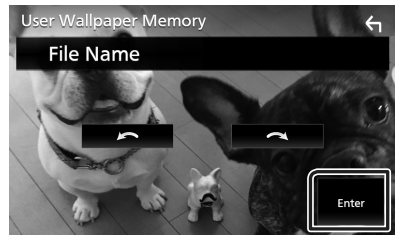

- 3 Touch **Enter**.





- ▶ The selected image is loaded and the display returns to the Wallpaper Customize screen.

#### NOTE

- Touching  rotates the image counter-clockwise.
- Touching  rotates the image clockwise.
- Picture files: JPEG (.jpg, .jpeg), PNG (.png), BMP (.bmp)

## AV Setup

You can set AV parameters.

- 1 Press the **FNC** button.
  - Popup menu appears.
- 2 Touch .
  - HOME screen appears.
- 3 Touch .
  - SETUP screen appears.
- 4 Touch **AV**.



- AV screen appears.

### 5 Set each parameter as follows.

#### ■ Android Auto Device Select

Select the device to be used in the Android Auto mode. (P.25)

#### ■ AV-OUT

You can select an AV source to be output from the AV OUTPUT port.

OFF, AV-IN, DISC, USB, or iPod

- You cannot select iPod if it is connected via Bluetooth.
- If you select USB, iPod, Disc, Spotify, Pandora or Bluetooth audio as the main source, you cannot select USB or iPod as the AV output source.
- If you select Mirroring (WebLink/ Waze), Apple CarPlay or Android Auto as the main source, you cannot select DISC (Music CD/ Disc media), USB or iPod as the AV output source.

#### ■ Driving Position

Select the driving position (left or right).

“Left” (Default)/ “Right”

#### ■ OEM SETUP

Confirm the information about or change the settings for using the ADS adapter.

# Controlling Audio

You can adjust various settings such as audio balance or subwoofer level.

- 1 Press the **FNC** button.
  - Popup menu appears.
- 2 Touch **Audio**.

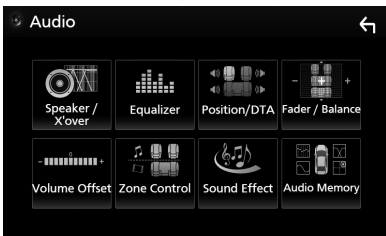
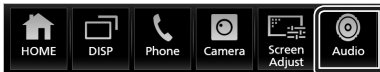

See the following section for each setting.

- Set up speaker/ X'over (**P.73**)
- Controlling equalizer (**P.75**)
- Set listening position/ DTA (**P.79**)
- Controlling general audio (Fader / Balance) (**P.75**)
- Set volume offset (**P.76**)
- Performing zone control (**P.77**)
- Set sound effect (**P.78**)
- Memory/recall the audio settings (**P.81**)

## 3 way speaker system setup

Select the appropriate crossover network mode for the speaker system used (2-way or 3-way speaker system).

- 1 Press the **FNC** button.
  - Popup menu appears.
- 2 Touch .
  - HOME screen appears.
- 3 Touch .
  - Source selection screen appears.
- 4 Touch **AV Off**.
- 5 Press the **FNC** (①) button and the **-** (②) button for 1 second at the same time.



➤ Speaker system select screen appears.

- 6 Select the crossover network mode.

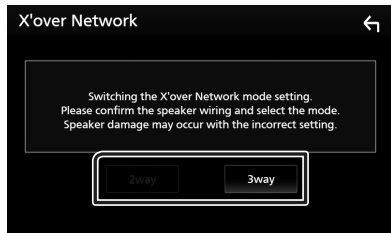

➤ A confirmation screen appears.

- 7 Touch **Yes**.

### NOTE

- When the 3-way speaker system is selected, the following functions are disabled.
  - Zone Control
  - Fader for Controlling General Audio
  - Front focus of Listening Position/ DTA
  - Selection of the speakers to output sound from the cell-phone of Bluetooth HF/Audio
  - Beep for User Interface Setup
- Connecting 3-way speakers with the 2-way mode selected can break the speakers.



## Speaker/ X'over setup

- 1 Press the **FNC** button.
  - ▶ Pop-up menu appears.
- 2 Touch **Audio**.
  - ▶ Audio screen appears.
- 3 Touch **Speaker/X'over**.

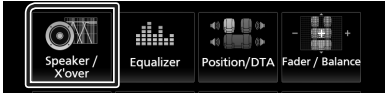

- 4 Select a car type.

You can select the car type and speaker network, etc.

When you select your car type, the Delay Time Alignment is activated automatically (for timing adjustment of sound output for each channel) to have the highest surround effects.



- 5 Touch the speaker (①) you wish to adjust and set each parameter (②) as follows.

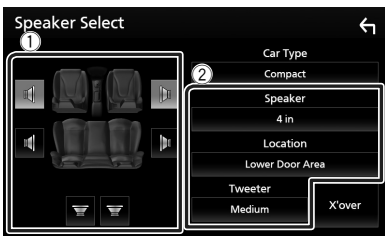

### ■ Speaker

You can select a speaker type and its size to get the best sound effects.

When the speaker type and size are selected, the speaker crossover network is set automatically.

### ■ Location (Only for Front, Rear)

Select the speaker position you have installed.

### ■ Tweeter (Only for Front)

You can set up the tweeter when you are selecting front speakers.

None, Small, Medium, Large

### ■ X'over

Display the speaker crossover setup screen.

You can adjust the crossover frequency that was set automatically when you selected the speaker type.

For details, see **Crossover network setup (P.74)**

### When Speaker network is set to 3 way:

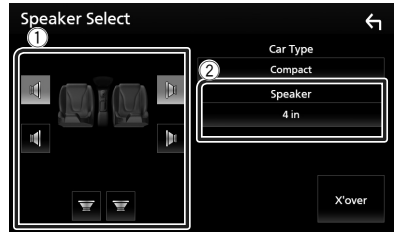

### NOTE

- For how to switch to the 3-way speaker system, see **3 way speaker system setup (P.72)**. Connecting 3-way speakers with the 2-way mode selected can break the speakers.
- Select "None" if you have no speakers.

## Controlling Audio

### Crossover network setup

You can set the crossover frequency of speakers.

#### 1 Touch **X'over**.



#### 2 Touch the speaker to set up.



#### 3 Set each parameter as follows.

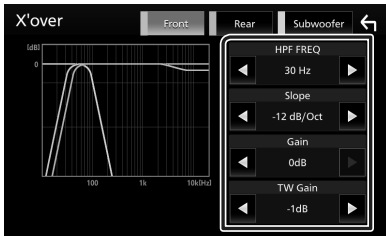

##### ■ **HPF FREQ**

High Pass Filter adjustment. (When Front or Rear is selected on the Speaker Select screen)

##### ■ **LPF FREQ**

Low Pass Filter adjustment. (When Subwoofer is selected on the Speaker Select screen)

##### ■ **Slope** \*1

Set a crossover slope.

##### ■ **Gain**

Adjust the gain of the front speaker, rear speaker, or subwoofer.

##### ■ **TW Gain** \*2

Adjust the tweeter level. (When Front is selected on the Speaker Select screen)

##### ■ **Phase Inversion** \*3

Set the phase of subwoofer output. Check **Phase Inversion** to shift the phase 180 degrees. (When Subwoofer is selected on the Speaker Select screen)

\*1 Only when "LPF FREQ"/"HPF FREQ" is set to a mode other than "Through" in **X'over**.

\*2 Only when "Tweeter" is set to "Small", "Medium", "Large" in **Speaker Setup**.

\*3 Only when "Subwoofer" is set to a mode other than "None" in **Speaker Setup**.

### When Speaker network is set to 3 way:

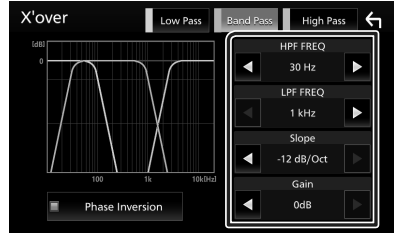

##### ■ **FREQ (High Pass)**

High Pass Filter adjustment.

##### ■ **HPF FREQ, LPF FREQ (Band Pass)**

Band Pass Filter adjustment. (When Mid Range Speaker is selected on the Speaker Select screen)

##### ■ **FREQ (Low Pass)**

Low Pass Filter adjustment. (When Woofer is selected on the Speaker Select screen)

##### ■ **Slope** \*1 \*2

Set a crossover slope.

##### ■ **Gain**

Set the gain of each speaker.

##### ■ **Phase Inversion**

Set the phase of tweeter, mid range, and woofer output.

Check **Phase Inversion** to shift the phase 180 degrees.

\*1 Only when "LPF FREQ"/"HPF FREQ" (Band Pass) is set to a mode other than "Through" in **X'over**.

\*2 Only when "FREQ" (Low Pass) is set to a mode other than "Through" in **X'over**.

#### NOTE

- For how to switch to the 3-way speaker system, see **3 way speaker system setup (P.72)**. Connecting 3-way speakers with the 2-way mode selected can break the speakers.

## Controlling General Audio

- 1 Press the **FNC** button.  
➤ Popup menu appears.
- 2 Touch **Audio**.  
➤ Audio screen appears.
- 3 Touch **Fader / Balance**.



- 4 Set each parameter as follows.

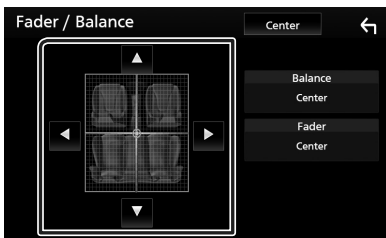

### ■ Fader / Balance

Adjust the volume balance around the touched area.

◀ and ▶ adjust the right and left volume balance.

▲ and ▼ adjust the front and rear volume balance.

### ■ Center

Clear the adjustment.

## Equalizer Control

You can adjust equalizer by selecting the optimized setting for each category.

- 1 Press the **FNC** button.  
➤ Popup menu appears.
- 2 Touch **Audio**.  
➤ Audio screen appears.
- 3 Touch **Equalizer**.



- 4 Touch the screen and set the **Graphic Equalizer** as desired.

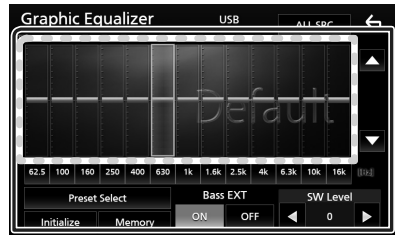

### ■ Gain level (area in dotted frame)

Adjust the gain level by touching each frequency bar.

You can select a frequency bar and adjust its level by ▲, ▼.

### ■ Preset Select

Display the screen for selecting the preset equalizer curve. (P.76)

### ■ Memory

Saves the adjusted equalizer curve as "User1" to "User4". (P.76)

### ■ Initialize

Initialize (flatten) the current EQ curve.

### ■ ALL SRC

Apply the adjusted equalizer curve to all sources. Touch **ALL SRC** and then touch **OK** on the confirmation screen.

### ■ Bass EXT (Bass Extend Settings)

When turned on, the frequencies lower than 62.5 Hz is set to the same gain level (62.5 Hz).

## Controlling Audio

### ■ SW Level

Adjust the subwoofer volume. This setting is not available when Subwoofer is set to "None". See **Speaker/ X'over setup (P.73)**.

### 📄 Recall the EQ curve

- 1 Touch **Preset Select**.
- 2 Select an EQ curve.



#### NOTE

- **iPod** is available only for the iPod source.

### 📄 Save the EQ curve

- 1 Adjust the EQ curve.
- 2 Touch **Memory**.
- 3 Select where to save.



## Volume Offset

Finely adjust the volume of the current source to minimize the difference in volume between different sources.

- 1 Press the **FNC** button.
  - Popup menu appears.
- 2 Touch **Audio**.
  - Audio screen appears.
- 3 Touch **Volume Offset**.



- 4 Touch **+** or **-** to adjust the level.

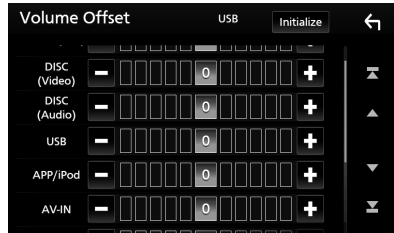

### ■ Initialize

Returns to the initial settings.

#### NOTE

- If you have increased the volume first, then reduce the volume using "Volume Offset". Switching the current source to another source suddenly may output extremely loud sound.

## Zone Control

You can select different sources for front and rear positions in the vehicle.

### 1 Press the **FNC** button.

- Popup menu appears.

### 2 Touch **Audio**.

- Audio screen appears.

### 3 Touch **Zone Control**.



- Zone Control screen appears.

### 4 Touch **Zone Select**.

### 5 Touch **Dual Zone**.

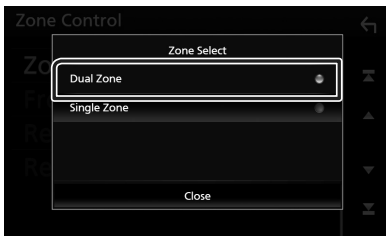

### 6 Set each source as follows.

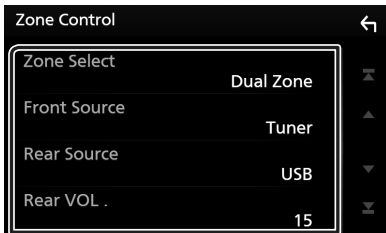

#### ■ **Zone Select**

Touch **Single Zone** to turn off the dual zone function.

#### ■ **Front Source Rear Source**

Select an audio source for each.

#### ■ **Rear VOL.**

Adjust the rear source volume.

## NOTE

- When the rear speaker sound is switched, the audio source that is output at the AV OUTPUT terminal is also switched to the same source.
- When the dual zone function is set to on, the following functions are not available.
  - Output from the subwoofer
  - Subwoofer Level/ Bass Boost (**P.78**)
  - Equalizer Control/ Sound Effect/ Listening Position (**P.75, 78, 79**)
  - Speaker Setup (**P.73**)
  - High-resolution Sound Source File Playback
- You cannot select iPod if it is connected via Bluetooth.
- If you select USB, iPod, Disc, Spotify, Pandora or Bluetooth audio as the Front Source, you cannot select USB or iPod as the Rear Source.
- If you select Mirroring (WebLink/ Waze), Apple CarPlay or Android Auto as the Front Source, you cannot select DISC (Music CD/ Disc media), USB or iPod as the Rear Source.

### Sound Effect

You can set sound effects.

- 1 Press the **FNC** button.
  - Popup menu appears.
- 2 Touch **Audio**.
  - Audio screen appears.
- 3 Touch **Sound Effect**.



- 4 Set each parameter as follows.

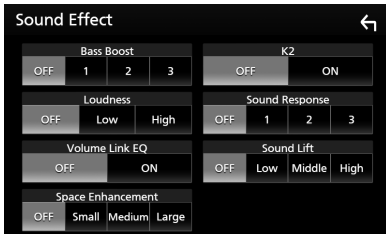

#### ■ Bass Boost

Set the amount of bass boost "OFF"/"1"/"2"/"3".

#### ■ Loudness

Set the amount of boost of low and high tones.

"OFF", "Low", "High"

#### ■ Volume Link EQ

Reduce the driving noise by boosting specific frequencies in the audio signal.

"OFF", "ON"

#### ■ Space Enhancement

Select the feeling of sound space enhancement.

"OFF"/"Small"/"Medium"/"Large".

This setting is not available for the Tuner source.

#### ■ K2

Turn ON/OFF the K2 function.

Technology to extrapolate and supplement with proprietary algorithm, the high-frequency range that is cut off when encoding.

#### ■ Sound Response

Virtually make the sound more realistic using the Digital Signal Processor (DSP) system.

Select the level from "OFF"/"1"/"2"/"3".

#### ■ Sound Lift

You can adjust the height of speakers virtually to suit your listening position.

"OFF"/"Low"/"Middle"/"High".

## Listening Position/ DTA

Listening Position/DTA allows you to improve the sound field depending on the position of the seat you sit.

Listening Position/DTA allows you to set "Listening Position" and "Front Focus". You cannot set both at the same time.

- 1 Press the **FNC** button.
  - Pop up menu appears.
- 2 Touch **Audio**.
  - Audio screen appears.
- 3 Touch **Position/DTA**.

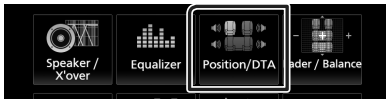

- Set up Listening Position (**P.79**)
- Set up Front Focus (**P.80**)

### Listening Position

Adjust the sound delay time so that the sounds from different speakers arrive at the listener sitting on the selected seat at the same time.

- 1 Touch **Listening Position** on the Position/DTA screen.
- 2 Select a listening position from **Front R** (Right front), **Front L** (Left front), **Front All** (All front), and **All**.



### Position DTA control

You can fine-adjust your listening position.

- 1 Touch **Adjust**.
- 2 Touch **Delay**.
- 3 Touch **◀** or **▶** to adjust the delay time of the selected speaker.

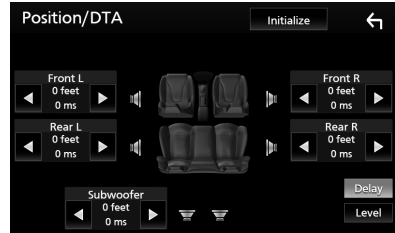

- 4 Touch **Level**.
- 5 Touch **◀** or **▶** to adjust the sound level of the selected speaker.

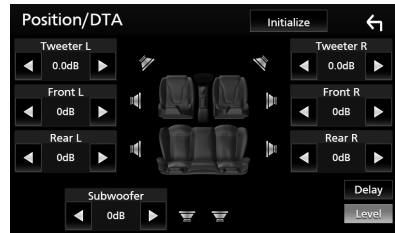

### NOTE

- To initialize the Delay and Level settings, touch **Initialize** and **YES** on the confirmation screen.

## Controlling Audio

### Front Focus

You can focus the imaginary sound image on the front of the selected seat.

1 Touch **Front Focus** in the Position/DTA screen.

2 Select a front focus position.

For **Front All** and **All**, select Priority L or R depending on which side you want to put the imaginary sound image.

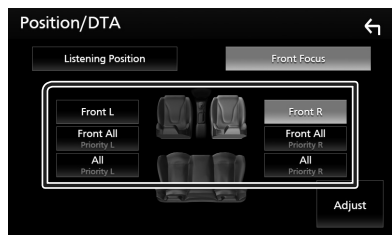

### Front Focus fine adjustment

1 Touch **Adjust**.

2 Touch **Delay**.

3 Set each parameter as follows.

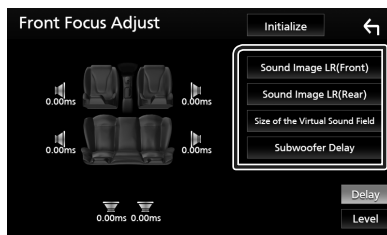

#### ■ Sound Image LR (Front)

Focus the sound image on the front of front seats.

#### ■ Sound Image LR (Rear)

Focus the sound image on the front of rear seats.

#### ■ Size of the Virtual Sound Field

Adjust the size of sound image to meet your taste. If the sound image is shifted from the front, move it back by **Sound Image LR (Front)** or **Sound Image LR (Rear)**.

#### ■ Subwoofer Delay

Adjust the delay time of subwoofer sound.

4 Touch **Level**.

5 Touch ◀ or ▶ to adjust the sound level of the selected speaker.

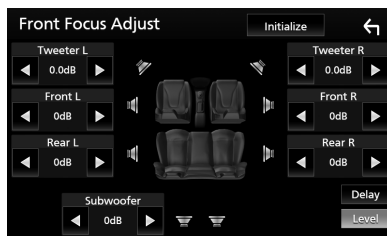

### NOTE

- To initialize the Delay and Level settings, touch **Initialize** and **YES** on the confirmation screen.



## Audio Setup memory

Audio Control settings can be memorized. The memorized settings can be recalled at any time.

- 1 Press the FNC button.**
  - Popup menu appears.
- 2 Touch **Audio**.**
  - Audio screen appears.
- 3 Touch **Audio Memory**.**



### ■ **SETUP Memory**

Lock or unlock the Audio SETUP Memory/ Recall/Clear.

### ■ **Audio SETUP Memory**

Memorize the current audio settings.

- Fader/ Balance, Speaker / X'over, Equalizer (User Preset, SW Level), Position/DTA, Sound Effect (**P.72**)

### ■ **Audio SETUP Recall**

Recall the memorized audio setting.

### ■ **Audio SETUP Clear**

Clear the AUDIO SETUP Memory and the currently memorized audio settings.

# Remote control

This unit can be operated using the remote control.

## ▲ WARNING

- Do not ingest the battery, Chemical Burn Hazard  
The remote control supplied with this product contains a coin / button cell battery. If the coin/button cell battery is swallowed, it can cause severe internal burns in just 2 hours and can lead to death.  
Keep new and used batteries away from children. If the battery compartment does not close securely, stop using the product and keep it away from children.  
If you think batteries might have been swallowed or placed inside any part of the body, seek immediate medical attention.

## ▲ CAUTION

- Put the remote control in a place where it will not move during braking or other operations. A dangerous situation could result, if the remote control falls down and gets wedged under the pedals while driving.
- Do not leave the battery near fire or under direct sunlight. A fire, explosion or excessive heat generation may result.
- Do not recharge, short, break up or heat the battery or place it in an open fire. Such actions may cause the battery to leak fluid. If spilled fluid comes in contact with your eyes or on clothing, immediately rinse with water and consult a physician.
- Danger of explosion if Lithium battery is incorrectly replaced. Replace only with the same or equivalent type.

## ■ Removing the battery sheet

Pull the battery sheet out from the remote controller to activate the battery.

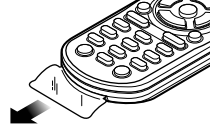

## ■ Changing the battery of the remote controller

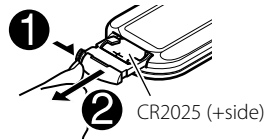

- Use a commercially available button battery (CR2025).
- Insert the battery with the + and – poles aligned properly.
  - If the effectiveness of the remote controller decreases, replace the battery.

## Functions of the Remote control Buttons

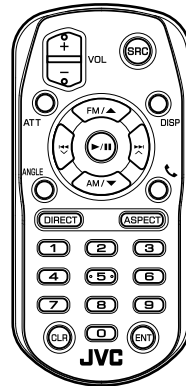

Key Name	Function
SRC	Switches to the source to be played. In hands-free mode, hangs up the phone.
VOL + -	Adjusts the volume.
ATT	Lowers the volume when pressed once. Restores the previous volume when pressed twice.
DISP	Switches the screen between the current source and the App screen from the connected iPhone/Android.
FM/▲ AM/▼	Selects the folder to be played. For the tuner source, selects FM/ AM band to be received. For the SiriusXM source, selects the band to be received. For the DVD/VCD source, selects the title to be played.
⏮️ ⏪️ ⏩️ ⏭️	Selects the track or file to be played. For the tuner and SiriusXM sources, switches to broadcast stations received by the unit. For the DVD/VCD source, selects the chapter/scene/track to be played.
ANGLE	Not used.
☎️	When a call comes in, answers the call.
DIRECT	Switches to the direct search mode. For details on the direct search mode, see <b>Direct search mode (P.83)</b> .
ASPECT	Changes the aspect ratio. • To confirm the current aspect ratio setting, operate on the touch panel. <b>(P.66)</b>
Numeric Keypad	Allows you to enter the number to search in the direct search mode. For details on the direct search mode, see <b>Direct search mode (P.83)</b> .
CLR	During DVD/VCD source, deletes a character while in direct search mode.
ENT	Performs the selected function.

## Direct search mode

Using the remote control, you can jump directly to the desired file, track chapter, etc. by entering the number corresponding to the content.

### NOTE

- This operation cannot be performed for the USB device and iPod.

### 1 Press the **SRC** button several times until the desired content appears.

The available contents are different depending on the source type.

#### ■ DVD \*1

Title number/Chapter number

#### ■ VCD 1.X and 2.X (PBC OFF) \*1

Track number

#### ■ VCD 2.X (PBC ON) \*1

Scene number/Track number

#### ■ Music CD \*1

Track number

#### ■ Tuner

Frequency value

#### ■ SiriusXM

Channel number

### 2 Press the **DIRECT** button.

### 3 Enter the number of the content you want to play using the numeric keypad.

### 4 For DVD or VCD, music CD, press the **ENTER** button. \*1

For Tuner, press the **⏮️** or **⏭️** button.

- The content corresponding to the number you entered is played.

\*1 KW-V940BW only

# Connection/Installation

## Before Installation

Before installation of this unit, please note the following precautions.

### ▲ WARNINGS

- If you connect the ignition wire (red) and the battery wire (yellow) to the car chassis (ground), you may cause a short circuit, that in turn may start a fire. Always connect those wires to the power source running through the fuse box.
- Do not cut out the fuse from the ignition wire (red) and the battery wire (yellow). The power supply must be connected to the wires via the fuse.

### ▲ CAUTION

- Install this unit in the console of your vehicle. Do not touch the metal part of this unit during and shortly after the use of the unit. Metal part such as the heat sink and enclosure become hot.

### NOTE

- Mounting and wiring this product requires skills and experience. For best safety, leave the mounting and wiring work to professionals.
- Make sure to ground the unit to a negative 12V DC power supply.
- Do not install the unit in a spot exposed to direct sunlight or excessive heat or humidity. Also avoid places with too much dust or the possibility of water splashing.
- Do not use your own screws. Use only the screws provided. If you use the wrong screws, you could damage the unit.
- If the power is not turned ON ("There is an error in the speaker wiring. Please check the connections." is displayed), the speaker wire may have a short-circuit or touched the chassis of the vehicle and the protection function may have been activated. Therefore, the speaker wire should be checked.
- If your car's ignition does not have an ACC position, connect the ignition wires to a power source that can be turned on and off with the

ignition key. If you connect the ignition wire to a power source with a constant voltage supply, such as with battery wires, the battery may be drained.

- If the console has a lid, make sure to install the unit so that the front panel will not hit the lid when closing and opening.
- If the fuse blows, first make sure the wires aren't touching to cause a short circuit, then replace the old fuse with one with the same rating.
- Insulate unconnected wires with vinyl tape or other similar material. To prevent a short circuit, do not remove the caps on the ends of the unconnected wires or the terminals.
- Connect the speaker wires correctly to the terminals to which they correspond. The unit may be damaged or fail to work if you share the ⊖ wires or ground them to any metal part in the car.
- When only two speakers are being connected to the system, connect the connectors either to both the front output terminals or to both the rear output terminals (do not mix front and rear). For example, if you connect the ⊕ connector of the left speaker to a front output terminal, do not connect the ⊖ connector to a rear output terminal.
- After the unit is installed, check whether the brake lamps, blinkers, wipers, etc. on the car are working properly.
- Mount the unit so that the mounting angle is 30° or less.
- This unit has the cooling fan to decrease the internal temperature. Do not mount the unit in a place where the cooling fan of the unit is blocked. Blocking these openings will inhibit the cooling of the internal temperature and result in malfunction.

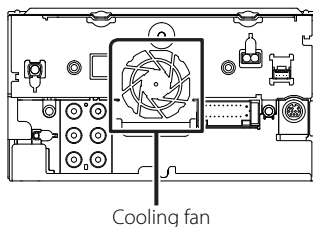



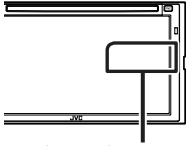



- Do not press hard on the panel surface when installing the unit to the vehicle. Otherwise scars, damage, or failure may result.
- Reception may drop if there are metal objects near the Bluetooth antenna.

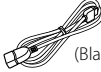

Bluetooth antenna unit

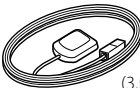
### ■ Supplied accessories for installation

①		x1
②	 (Black 1 m)	x1
③	 (Gray 1 m)	x1
④	 (3 m)	x1
⑤	 (M5 x 8 mm)	x6
⑥	 (M5 x 8 mm)	x6
⑦	 (3.5 m)	x1
⑧		x1

### ■ Installation procedure

- 1) To prevent a short circuit, remove the key from the ignition and disconnect the ⊖ terminal of the battery.
- 2) Make the proper input and output wire connections for each unit.
- 3) Connect the speaker wires of the wiring harness.
- 4) Connect the wiring harness wires in the following order; ground, battery, ignition.
- 5) Connect the wiring harness connector to the unit.
- 6) Install the unit in your car.
- 7) Reconnect the ⊖ terminal of the battery.
- 8) Perform the Initial Setup.  
See **Initial setup (P.7)**.

## Installing the unit

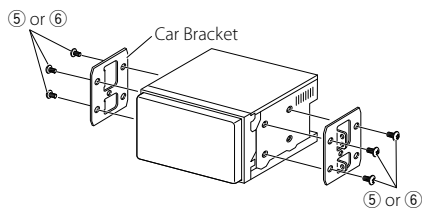

### NOTE

- Make sure that the unit is installed securely in place. If the unit is unstable, it may malfunction (eg, the sound may skip).

## GPS antenna

GPS antenna is installed inside of the car. It should be installed as horizontally as possible to allow easy reception of the GPS satellite signals.

To mount the GPS antenna inside your vehicle:

- 1) Clean your dashboard or other surface.
- 2) Remove the separator of the metal plate (accessory ⑧).
- 3) Press the metal plate (accessory ⑧) down firmly on your dashboard or other mounting surface. You can bend the metal plate (accessory ⑧) to conform to a curved surface, if necessary.
- 4) Remove the separator of the GPS antenna (accessory ⑦), and stick the antenna to the metal plate (accessory ⑧).

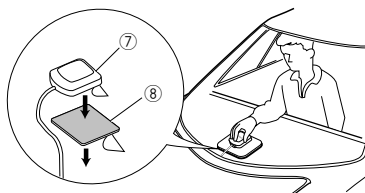

### NOTE

- Depending on the type of car, reception of the GPS satellite signals might not be possible with an inside installation.
- Please install this GPS antenna in an area away from any antennas that are used with CB radios or satellite televisions.
- The GPS antenna should be installed at a position that is spaced at least 12 inch (30 cm) from cellular phone or other transmitting antennas. Signals from the GPS satellite may be interfered with by these types of communication.
- Painting the GPS antenna with (metallic) paint may cause a drop in performance.

## Microphone unit

- 1) Check the installation position of the microphone (accessory ④).
- 2) Clean the installation surface.
- 3) Remove the separator of the microphone (accessory ④), and stick the microphone to the place shown below.
- 4) Wire the microphone cable up to the unit with it secured at several positions using tape or other desired method.
- 5) Adjust the direction of the microphone (accessory ④) to the driver.

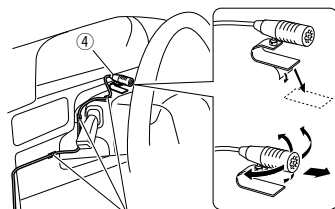

Fix a cable with a commercial item of tape.

## Connecting wires to terminals

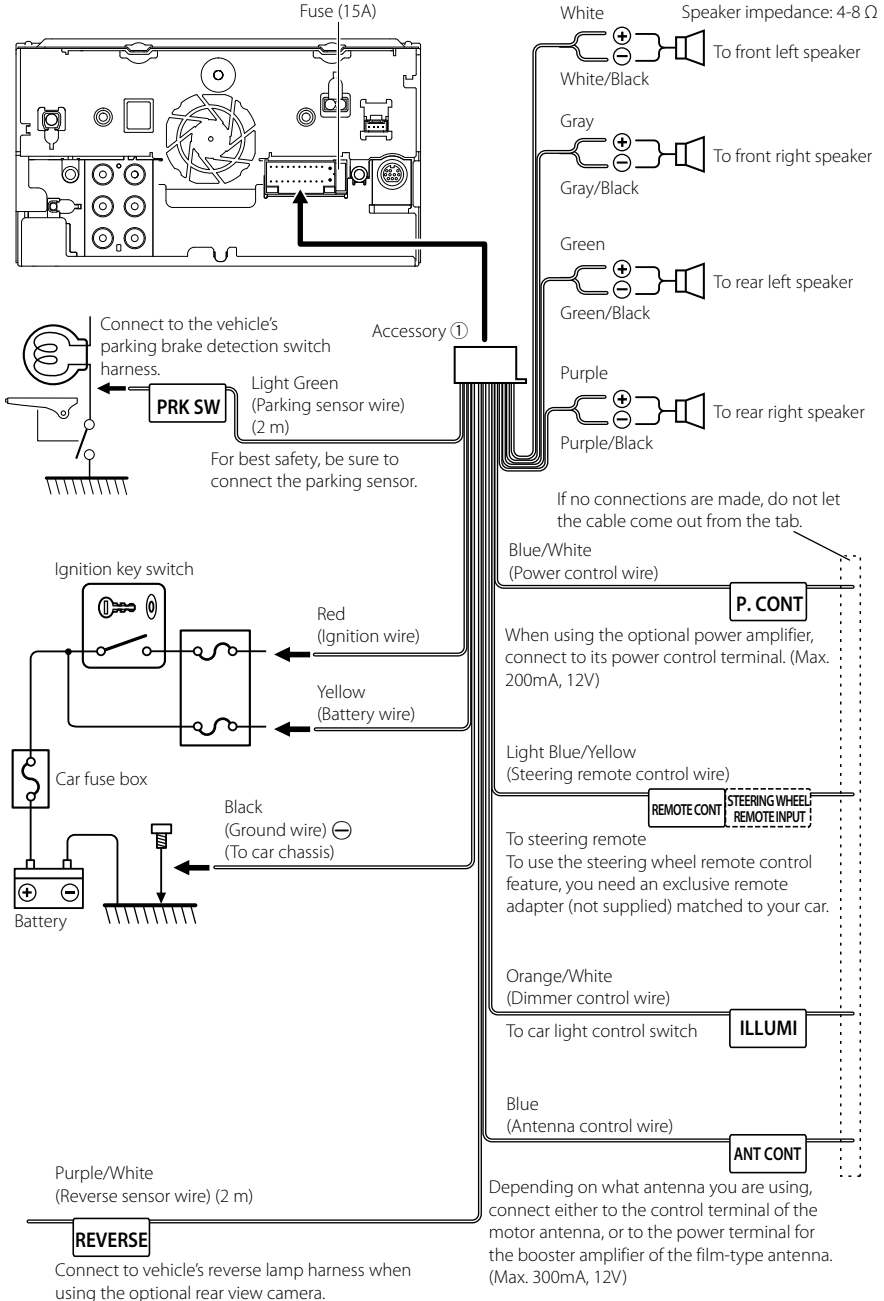

### 3 way speaker system setup

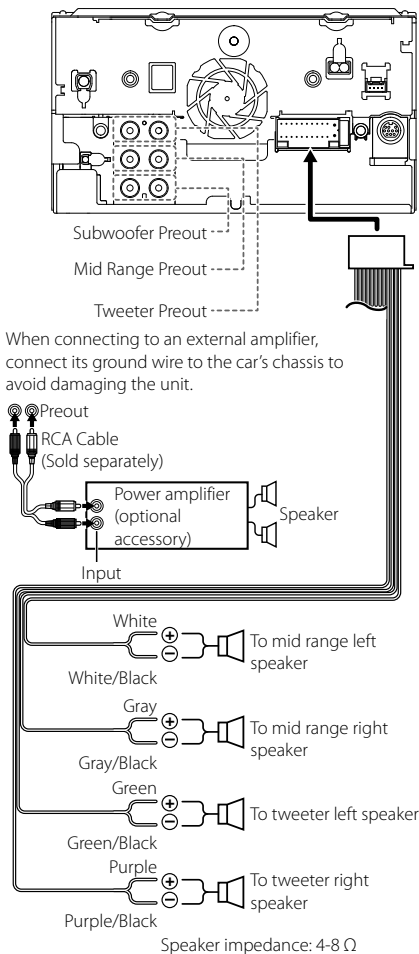



#### NOTE

- For speaker system setup, see **3 way speaker system setup (P.72)**.
- For speaker setup and crossover setup, see **Speaker/ X'over setup (P.73)**.
- For how to connect speaker wires to terminals other than speaker terminals and Preout terminals, see **Connecting the system and external components (P.88)** and **Connecting wires to terminals (P.87)**.

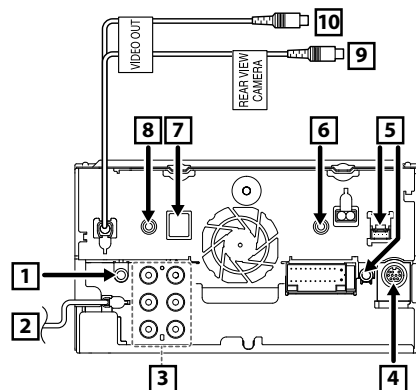
### Connecting the system and external components

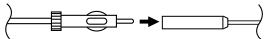
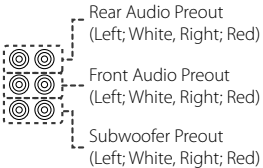

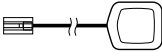
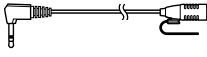
1	AV Audio output (ø3.5 mini jack)
2	FM/AM antenna input 
3	When connecting to an external amplifier, connect its ground wire to the car's chassis to avoid damaging the unit. 
4	SiriusXM Connect Vehicle Tuner connector For more information on how to install the SiriusXM Connect Vehicle tuner, consult the installation guide included with the tuner.
5	iDataLink connector
6	AV-IN input (1; Left audio, 2; Right audio, 3; Ground, 4; Visual) 
7	Accessory ⑦: GPS Antenna 
8	Accessory ④: Bluetooth Microphone 
9	Rear view camera input (Yellow)
10	Visual Output (Yellow)



## Connecting a USB device

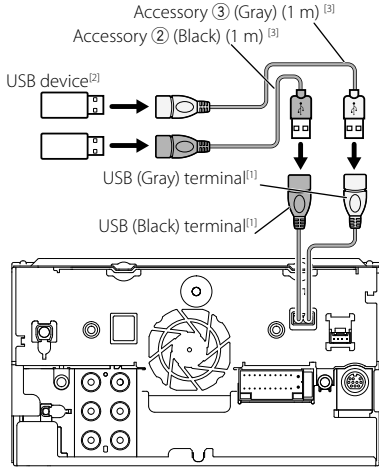

<sup>[1]</sup> USB maximum power supply current :  
DC 5 V  $\overline{\text{---}}$  1.5 A

<sup>[2]</sup> Sold separately

<sup>[3]</sup> See **Securing the USB extension cable (P.89)**.

## Securing the USB extension cable

Secure the USB extension cable with insulating tape or the like so that its connectors are not disconnected.

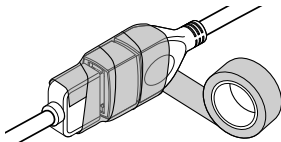

## Connecting an iPod/iPhone

### ● Lightning connector

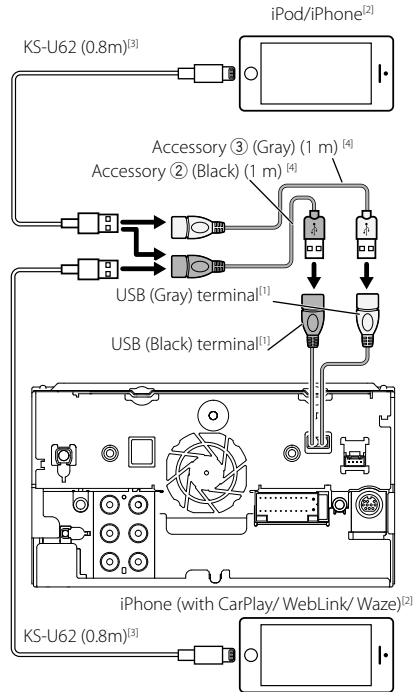

<sup>[1]</sup> USB maximum power supply current :  
DC 5 V  $\overline{\text{---}}$  1.5 A

<sup>[2]</sup> Sold separately

<sup>[3]</sup> Optional accessory

<sup>[4]</sup> See **Securing the USB extension cable (P.89)**.

## Connecting an Android smartphone

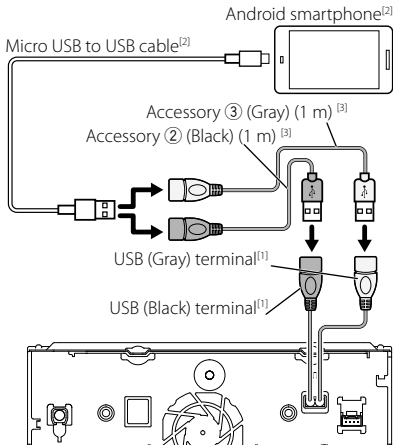

<sup>[1]</sup> USB maximum power supply current :  
DC 5 V  $\overline{\overline{=}}$  1.5 A

<sup>[2]</sup> Sold separately

<sup>[3]</sup> See **Securing the USB extension cable (P.89)**.

# Troubleshooting

## Problems and Solutions

If any trouble occurs, first check the following table for possible problems.

### NOTE

- Some functions of this unit may be disabled by some settings made on this unit.
- What might seem to be a malfunction in your unit may just be the result of slight misoperation or miswiring.

### About settings

- **Cannot set up the subwoofer.**
- **Cannot set up subwoofer phase.**
- **No output from the subwoofer.**
- **Cannot set up the low pass filter.**
- **Cannot set up the high pass filter.**

Subwoofer is not set to on.

- Set the subwoofer to on. See *Speaker/X'over setup (P.73)*.

The dual zone function is enabled.

- Set the dual zone function to off. See *Zone Control (P.77)*.

- **Cannot select the output destination of the subsource in the dual zone.**
- **Cannot adjust the volume of the rear speakers.**

The dual zone function is disabled.

- Set the dual zone function to on. See *Zone Control (P.77)*.

- **Cannot set up the equalizer.**
- **Cannot set up the crossover network.**

The dual zone function is enabled.

- Set the dual zone function to off. See *Zone Control (P.77)*.

### About audio operations

#### Radio reception is poor.

The car antenna is not extended.

- Pull out the antenna all the way.

The antenna control wire is not connected.

- Connect the wire correctly. See *Connecting the system and external components (P.88)*.

#### Cannot select a folder.

The random play function is enabled.

- Turn off the random function.

#### Cannot perform repeat play during VCD playback.

The PBC function is enabled.

- Turn off the PBC function.

#### The specified disc does not play, but another one plays instead.

The disc is quite dirty.

- Clean the disc. See *Precautions on handling discs (P.4)*.

The disc is severely scratched.

- Try another disc instead.

#### The sound skips when an audio file is being played.

The disc is scratched or dirty.

- Clean the disc. See *Precautions on handling discs (P.4)*.

The recording condition is bad.

- Record the file again or use another disc.

### Others

#### The Touch Sensor Tone doesn't sound.

The preout jack is being used.

- The Touch Sensor Tone cannot be output from the preout jack.

## Error Messages

When you fail to operate the unit correctly, the cause of the failure appears as the message on the screen.

#### There is an error in the speaker wiring. Please check the connections.

Protective circuit has been activated because a speaker cord has shorted or it has come in contact with the car chassis.

- Wire or insulate the speaker cord as appropriate and turn the power off and on again.

#### Hot Error

When the internal temperature of this unit rises to 60°C or more, the protection circuit is activated and you may not be able to operate the unit.

- Use the unit again after reducing the temperature of the unit.

#### Mecha Error

The disc player is malfunctioning.

- Eject the disc and try inserting it again. Contact the JVC dealer if this indicator continues blinking or the disc cannot be ejected.

#### Disc Error

An unplayable disc is inserted.

- Change the disc. See *Playable Media and Files (P.93)*.

## Troubleshooting

---

### Read Error

The disc is quite dirty.

- Clean the disc. See **Precautions on handling discs (P.4)**.

Disc is upside down.

- Load the disc with the labeled side up.
- 

### Region Code Error

The disc you wanted to play has a region code that cannot be played with this unit.

- See **Region Codes in the World (P.95)** or try another disc.
- 

### Error 07–67

The unit is not operating correctly due to some reason or other.

- Turn the power off and on again. If the “Error 07–67” message does not disappear, contact your nearest JVC dealer.
- 

### No Device (USB device)

The USB device is selected as a source although no USB device is connected.

- Change the source to any source other than USB/iPod. Connect a USB device, and change the source to USB again.
- 

### Disconnected (iPod, Bluetooth audio player)

The iPod/Bluetooth audio player is selected as a source although no iPod/Bluetooth audio player is connected.

- Change the source to any source other than iPod/Bluetooth. Connect an iPod/Bluetooth audio player, and change the source to iPod/Bluetooth again.
- 

### No Media file

The connected USB device contains no playable audio file. Media was played that doesn't have data recorded that the unit can play.

- See **Playable Media and Files (P.93)** and try another USB device.
- 

### USB device over current status detected.

The connected USB device is rated a current capacity higher than the allowable limit.

- Check the USB device. Some trouble may have occurred to the connected USB device.
  - Change the source to any source other than USB. Remove the USB device.
- 

## SiriusXM

---

### Check Tuner

A SiriusXM tuner is not connected to this unit.

- Verify that the SiriusXM Connect Vehicle Tuner cable is securely connected to the radio.
- 

### Subscription Updated - Press Return To Continue

The SiriusXM subscription has been renewed.

- Pressing the Control knob will clear the message.
- 

### SXM Chan Unavailable

The currently selected channel is unavailable.

- Visit [www.siriusxm.com](http://www.siriusxm.com) for more information about the SiriusXM channel lineup.
- 

### SXM Ch Unsubscribed

The currently selected channel is not subscribed to.

- In the U.S.A., visit [www.siriusxm.com](http://www.siriusxm.com) or call 1-866-635-2349 if you have questions about your subscription package or would like to subscribe to this channel.
  - In Canada, visit [www.siriusxm.ca](http://www.siriusxm.ca) or call 1-877-438-9677.
- 

### SXM Check Antenna

No antenna is connected to the SiriusXM tuner.

- Check that an antenna is connected to the SiriusXM tuner. Check antenna for damages.
- 

### SXM No Signal

No SiriusXM radio signal is received.

- Verify that your vehicle is outdoors with a clear view of the sky.
- 

### Channel Locked

The selected channel has been locked by the parental controls.

- Enter the unlock code when you are asked. See **Parental Control (P.47)**.
- 

### Incorrect Pass Code entered

The selected channel is a mature or parental lock channel, and locked by the parental lock or user lock code.

- Enter the correct lock code.
-

# Appendix

## Playable Media and Files

You can play various kinds of media and files on this unit.

### List of playable discs (KW-V940BW)

Disc types / Standard		Support	Remark	
DVD	DVD Video	○		
	DVD Audio	×		
	DVD-VR	×		
	DVD-R*1	○	<ul style="list-style-type: none"> <li>• MP3/ WMA/ AAC/ WAV/ FLAC/ Vorbis/ MPEG1/ MPEG2/ MPEG4/ H.264/ WMV/ MKV playback</li> <li>• Multi-border/Multisession playback (Playback depends on authoring conditions)</li> </ul>	
	DVD-RW	○		
	DVD+R	○		
	DVD+RW	○		
	DVD-R DL (Dual layer)	○	Only video format	
DVD+R DL (Double layer)	○			
	DVD-RAM	×		
CD	Music CD*1	○		
	CD-ROM	○	<ul style="list-style-type: none"> <li>• MP3/ WMA/ AAC/ WAV/ FLAC/ Vorbis playback</li> <li>• Multisession is supported.</li> <li>• Packet write is not supported.</li> </ul>	
	CD-R	○		
	CD-RW	○		
		DTS-CD	×	
		Video CD (VCD)	○	
		Super video CD	×	
		Photo CD	×	
		CD-EXTRA	△	Only music CD session can be played.
		HDCD	△	Normal music CD sound quality
		CCCD	×	
Others	Dualdisc	×		
	Super audio CD	△	Only CD layer can be played.	

○ : Playback is possible.

△ : Playback is partly possible.

×

\*1 Incompatible with 8 cm (3 inch) discs.

### Use of DualDisc

When playing a "DualDisc" on this unit, the surface of the disc that is not played may be scratched while the disc is inserted or ejected. Since the music CD surface does not conform to the CD standard, playback may be impossible.

(A "DualDisc" is a disc with one surface containing DVD standard signals and the other surface containing music CD signals.)

### About disc format

The disc format should be the one of the following.

- ISO 9660 Level 1/2
- Joliet
- Romeo
- Long file name

## About files

The following audio and video files are supported.

### Playable Audio files

	Format	Bit rate	Sampling frequency	Bit count
AAC-LC (.m4a)	MPEG2/4 AAC LC HE-AAC(V1,V2)	8 – 320kbps, VBR	16 – 48 kHz	16 bit
MP3 (.mp3)	MPEG 1/2 Audio Layer 3	8 – 320kbps, VBR	16 – 48 kHz	16 bit
WMA (.wma)	Windows Media Audio Standard L3 profile (Version 7,8,9)	8 – 320kbps	16 – 48 kHz	16 bit
Linear PCM (WAVE) (.wav)	RIFF waveform Audio Format	–	16 – 48 kHz (Disc), 16 – 192 kHz (USB)	16/ 24 bit
FLAC (.flac)	flac	–	16 – 48 kHz (Disc), 16 – 192 kHz (USB)	16/ 24 bit
Vorbis (.ogg)	vorbis	VBR	16 – 48 kHz	16 bit
DSD (.dsf, .dff)	DSF, DSDIFF	–	2.8 MHz, 5.6 MHz, 11.2 MHz	1 bit

- If music of normal CD and other playback systems are recorded in the same disc, only the playback system recorded at the first setout is played.
- WMA and AAC files with DRM cannot be played.
- DSD sound is converted to PCM sound before playback.
- The EmChinks tag of DSDIFF is not supported.
- Although the audio files complies with the standards listed above, they may not be played depending on the types or conditions of media or device.
- This unit supports playback of High-Resolution Audio files.  
It is recommended that a car audio system should be configured with all High-Resolution Audio compatible products from player to speaker to enjoy its high quality sound.

### Acceptable Video files

	Profile	Max. Picture size	Max. bit rate	Audio format
MPEG-1 (.mpg, .mpeg)	–	352 × 240, 352 × 288	1.5 Mbps	MPEG Audio Layer 2
MPEG-2 (.mpg, .mpeg)	MP@ML	720 × 480, 720 × 576	8 Mbps	MPEG Audio Layer 2
H.264/MPEG-4 AVC (.mp4, .m4v, .avi, .flv, .f4v)	Baseline Profile, Main Profile	1920 × 1080 (30 fps)	8 Mbps	MP3, AAC
MPEG-4 (.mp4, .avi)	Advanced Simple Profile	1920 × 1080 (30 fps)	8 Mbps	MP3, AAC
WMV (.wmv)	Main Profile	1920 × 1080 (30 fps)	8 Mbps	WMA
MKV (.mkv)	Video format follows H.264/MPEG-4 AVC, MPEG-4, WMV			MP3, AAC, WMA, Vorbis, FLAC

- This unit can only play back files which are smaller than 4 GB.

### Limitation on structure of file and folder

	Disc media	USB device
Maximum number of folder layers	8	8
Maximum number of files (per folder)	999	999
Maximum number of folders (per folder)	5000	9999
Maximum number of folders (per device)	5000	Unlimited

- You can enter a folder name and file name with 255 or fewer single-byte characters.
- Files in the folder whose folder name begins with a dot (.) cannot be played.

## Region Codes in the World

The DVD players are given a region code according to the country or area it is marketed, as shown in the following map.

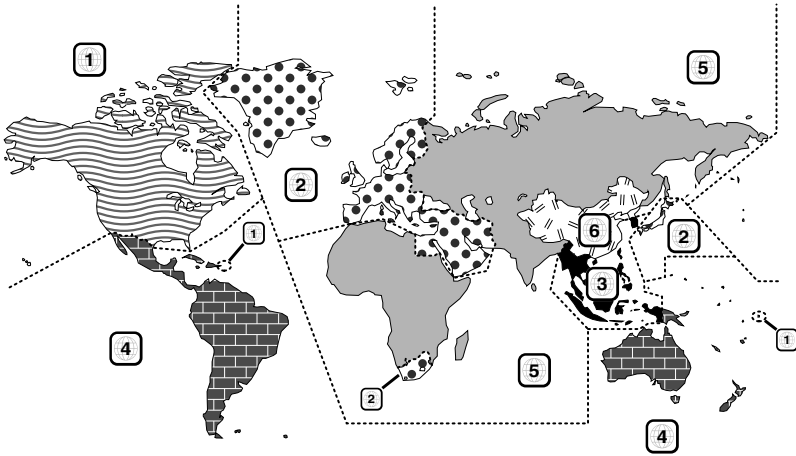

### ■ DVD disc marks



Indicates a region number. The discs with this mark can be played with any DVD player.



Indicates the number of audio languages recorded. Up to 8 languages can be recorded in a movie. You can select a favorite language.



Indicates the number of subtitled languages recorded. Up to 32 languages can be recorded.



If a DVD disc has scenes shot from multiple angles, you can select a favorite angle.



Indicates the type of screen for the image. The left mark indicates that a wide image picture (16:9) is displayed on a standard TV set screen (4:3) with a black band at both the top and bottom of the screen (letter box).

### ■ Operation regulatory marks

With this DVD, some functions of this unit such as the play function may be restricted depending on the location where the DVD is playing. In this case, the following marks will appear on the screen. For more information, refer to the disc manual.



### ■ Discs with limited period of use

Do not leave discs with a limited period of use in this unit. If you load an already expired disc, you may not be able to remove it from this unit.

## DVD Language Codes

Code	Language
aa	Afar
ab	Abkhazian
af	Afrikaans
am	Amharic
ar	Arabic
as	Assamese
ay	Aymara
az	Azerbaijani
ba	Bashkir
be	Byelorussian
bg	Bulgarian
bh	Bihari
bi	Bislama
bn	Bengali, Bangla
bo	Tibetan
br	Breton
ca	Catalan
co	Corsican
cs	Czech
cy	Welsh
da	Danish
de	German
dz	Bhutani
el	Greek
en	English
eo	Esperanto
es	Spanish
et	Estonian
eu	Basque
fa	Persian
fi	Finnish
fj	Fiji
fo	Faroese
fr	French
fy	Frisian
ga	Irish
gd	Scots Gaelic
gl	Galician
gn	Guarani
gu	Gujarati
ha	Hausa
he	Hebrew
hi	Hindi
hr	Croatian
hu	Hungarian
hy	Armenian

Code	Language
ia	Interlingua
ie	Interlingue
ik	Inupiak
id	Indonesian
is	Icelandic
it	Italian
ja	Japanese
jv	Javanese
ka	Georgian
kk	Kazakh
kl	Greenlandic
km	Cambodian
kn	Kannada
ko	Korean
ks	Kashmiri
ku	Kurdish
ky	Kirghiz
la	Latin
lb	Luxembourgish
ln	Lingala
lo	Laotian
lt	Lithuanian
lv	Latvian, Lettish
mg	Malagasy
mi	Maori
mk	Macedonian
ml	Malayalam
mn	Mongolian
mo	Moldavian
mr	Marathi
ms	Malay
mt	Maltese
my	Burmese
na	Nauru
ne	Nepali
nl	Dutch
no	Norwegian
oc	Occitan
om	(Afan) Oromo
or	Oriya
pa	Punjabi
pl	Polish
ps	Pashto, Pushto
pt	Portuguese
qu	Quechua
rm	Rhaeto-Romance

Code	Language
rn	Kirundi
ro	Romanian
ru	Russian
rw	Kinyarwanda
sa	Sanskrit
sd	Sindhi
sg	Sangho
sh	Serbo-Croatian
si	Singhalese
sk	Slovak
sl	Slovenian
sm	Samoan
sn	Shona
so	Somali
sq	Albanian
sr	Serbian
ss	Siswati
st	Sesotho
su	Sundanese
sv	Swedish
sw	Swahili
ta	Tamil
te	Telugu
tg	Tajik
th	Thai
ti	Tigrinya
tk	Turkmen
tl	Tagalog
tn	Setswana
to	Tongan
tr	Turkish
ts	Tsonga
tt	Tatar
tw	Twi
uk	Ukrainian
ur	Urdu
uz	Uzbek
vi	Vietnamese
vo	Volapuk
wo	Wolof
xh	Xhosa
yo	Yoruba
zh	Chinese
zu	Zulu



## Specifications

### ■ Monitor section

#### Picture Size

- : 6.75 inches (diagonal) wide
- : 151.8 mm (W) × 79.68 mm (H)
- 5-31/32 × 3-1/8 inch

#### Display System

- : TN LCD panel

#### Drive System

- : TFT active matrix system

#### Number of Pixels

- : 1,152,000 (800H x 480V x RGB)

#### Effective Pixels

- : 99.99 %

#### Pixel Arrangement

- : RGB striped arrangement

#### Back Lighting

- : LED

### ■ DVD player section (KW-V940BW)

#### D/A Converter

- : 24/ 32 bit

#### Audio Decoder

- : Linear PCM/ Dolby Audio/ MP3/ WMA/ AAC/ WAV/ FLAC/ Vorbis

#### Video Decoder

- : MPEG1/ MPEG2/ MPEG4/ WMV/ H.264/ MKV

#### Wow & Flutter

- : Below Measurable Limit

#### Frequency Response

- 96 kHz : 20 – 44,000 Hz
- 48 kHz : 20 – 22,000 Hz
- 44.1 kHz : 20 – 20,000 Hz

#### Total Harmonic Distortion

- : 0.010 % (1 kHz)

#### S/N Ratio (dB)

- : 90.5 dB

#### Dynamic Range

- : 89 dB

#### Disc Format

- : DVD-Video/ VIDEO-CD/ CD-DA/ DVD-R/DVD-RW/ DVD+R/+RW

#### Quantifying Bit Number

- : 16/ 20/ 24 bit

### ■ USB interface section

#### USB Standard

- : USB 2.0 High Speed

#### File System

- : FAT 16/ 32, exFAT, NTFS

#### Maximum Power Supply Current

- : DC 5 V  1.5 A × 2

#### D/A Converter

- : 24/ 32 bit

#### Audio Decoder

- : MP3/ WMA/ AAC/ WAV/ FLAC/ Vorbis/ DSD

#### Video Decoder

- : MPEG1/ MPEG2/ MPEG4/ WMV/ H.264/ MKV

#### Frequency Response (KW-M845BW)

- 192 kHz : 20 – 88,000 Hz
- 96 kHz : 20 – 44,000 Hz
- 48 kHz : 20 – 22,000 Hz
- 44.1 kHz : 20 – 20,000 Hz

#### Total Harmonic Distortion (KW-M845BW)

- : 0.0001 % (1 kHz)

#### S/N Ratio (dB) (KW-M845BW)

- : 98.5 dB

#### Dynamic Range (KW-M845BW)

- : 89 dB

### ■ Wi-Fi section

#### IEEE Standard

- : 802.11 a/b/g/n

#### Frequency Range

- : Dual Band ( 2.4GHz / 5GHz )

#### Channels

- : Auto(1-11ch) / Auto(149,153,157,161ch)

#### Transfer rates (MAX)

- : 11a:54 Mbps / 11b: 11 Mbps / 11g: 54 Mbps / 11n:150 Mbps

## Appendix

### ■ Bluetooth section

#### Technology

: Bluetooth Ver.4.1

#### Frequency

: 2.402 – 2.480 GHz

#### Output Power

: Power Class2

#### Maximum Communication range

: Line of sight approx. 10m (32.8 ft)

#### Audio Codec

: SBC/ AAC

#### Profile (Multi Profile support)

- HFP (V1.7) (Hands Free Profile)
- SPP (Serial Port Profile)
- A2DP (Advanced Audio Distribution Profile)
- AVRCP (V1.6) (Audio/Video Remote Control Profile)
- PBAP (Phonebook Access Profile)

### ■ FM tuner section

#### Frequency Range (step)

: 87.9 MHz – 107.9 MHz (200 kHz)

#### Usable Sensitivity (S/N : 30 dB)

: 9.3 dBf (0.8  $\mu$ V/ 75  $\Omega$ )

#### Quieting Sensitivity (S/N : 46 dB)

: 15.2 dBf (1.6  $\mu$ V/ 75  $\Omega$ )

#### Frequency Response

: 30 Hz – 15 kHz

#### S/N Ratio (dB)

: 75 dB (MONO)

#### Selectivity ( $\pm$ 400 kHz)

: Over 80 dB

#### Stereo Separation

: 45 dB (1 kHz)

### ■ AM tuner section

#### Frequency Range (step)

: 530 kHz – 1700 kHz (10 kHz)

#### Usable Sensitivity

: 28 dB $\mu$  (25  $\mu$ V)

### ■ Video section

#### Color System of External Video Input

: NTSC

#### External Video Input Level (RCA jacks)

: 1 Vp-p/ 75  $\Omega$

#### External Video Input Level (mini jack)

: 1 Vp-p/ 75  $\Omega$

#### External Audio Max Input Level (mini jack)

: 2 V/ 25 k $\Omega$

#### Video Output Level (RCA jacks)

: 1 Vp-p/ 75  $\Omega$

#### Audio Output Level (mini jack)

: 1.2 V/ 10 k $\Omega$

### ■ Audio section

#### Maximum Power (Front & Rear)

: 50 W  $\times$  4

#### Typical Power Output (Front & Rear)

Full Bandwidth Power (at less than 1% THD)

: 22 W  $\times$  4

#### Output frequency band

: 20 – 88,000 Hz

#### Preout Level (V)

: 4 V/ 10 k $\Omega$

#### Preout Impedance

:  $\leq$  600  $\Omega$

#### Speaker Impedance

: 4 – 8  $\Omega$

#### Graphics equalizer

Band: 13 Band

Frequency (BAND1 – 13)

: 62.5/ 100/ 160/ 250/ 400/ 630/ 1k/ 1.6k/ 2.5k/ 4k/  
6.3k/ 10k/ 16k Hz

#### Gain

: -9/-8/-7/-6/-5/-4/-3/-2/-1/0/1/2/3/4/5/6/7/8/9 dB

#### 2Way X'Over

##### High pass filter

Frequency: Through, 30/ 40/ 50/ 60/ 70/ 80/ 90/ 100/  
120/ 150/ 180/ 220/ 250 Hz

Slope: -6/-12/-18/-24 dB/Oct.

Gain: -8/-7/-6/-5/-4/-3/-2/-1/0 dB

##### Low pass filter

Frequency: 30/ 40/ 50/ 60/ 70/ 80/ 90/ 100/ 120/  
150/ 180/ 220/ 250 Hz, Through

Slope: -6/-12/-18/-24 dB/Oct.

Gain: -8/-7/-6/-5/-4/-3/-2/-1/0 dB

**3Way X'Over****High pass filter**

Frequency: 250/ 300/ 1k/ 1.6k/ 2.5k/ 4k/ 5k/ 6.3k/ 8k/  
10k/ 12.5k Hz

Slope: -12/-18/-24 dB/Oct.

Gain: -8/ -7/ -6/ -5/ -4/ -3/ -2/ -1/ 0 dB

**Band pass filter**

Frequency: Through, 50/ 60/ 70/ 80/ 90/ 100/ 120/  
150/ 180/ 220/ 250/ 300 Hz  
250/ 300/ 1k/ 1.6k/ 2.5k/ 4k/ 5k/ 6.3k/  
8k Hz, Through

Slope: -12/-18/-24 dB/Oct.

Gain: -8/ -7/ -6/ -5/ -4/ -3/ -2/ -1/ 0 dB

**Low pass filter**

Frequency: 30/ 40/ 50/ 60/ 70/ 80/ 90/ 100/ 120/  
150 Hz, Through

Slope: -12/-18/-24 dB/Oct.

Gain: -8/ -7/ -6/ -5/ -4/ -3/ -2/ -1/ 0 dB

**■ General****Operating Voltage**

: 14.4 V (10.5 – 16 V allowable)

**Maximum Current Consumption**

: 15 A

**Installation Dimensions (W × H × D)**

: 178 × 100 × 155 mm

7 × 3-15/16 × 6-1/8 inch

**Operational Temperature Range**

: -10 °C – +60 °C

**Weight**

KW-V940BW

: 2.1 kg (4.63 lbs)

KW-M845BW

: 1.7 kg (3.75 lbs)

**NOTE**

- Although the effective pixels for the liquid crystal panel is given as 99.99% or more, 0.01% of pixels may not light or may light incorrectly.

**Specifications subject to change without notice.**

## About this Unit

### ■ Copyrights

- The Bluetooth® word mark and logos are registered trademarks owned by Bluetooth SIG, Inc. and any use of such marks by JVC KENWOOD Corporation is under license. Other trademarks and trade names are those of their respective owners.
- Manufactured under license from Dolby Laboratories. Dolby, Dolby Audio and the double-D symbol are trademarks of Dolby Laboratories.



-  is a trademark of DVD Format/Logo Licensing Corporation registered in the U.S., Japan and other countries.
- This item incorporates copy protection technology that is protected by U.S. patents and other intellectual property rights of Rovi Corporation. Reverse engineering and disassembly are prohibited.
- Microsoft and Windows Media are either registered trademarks or trademarks of Microsoft Corporation in the United States and/or other countries.
- This software is based in part on the work of the independent JPEG Group.
- The "AAC" logo is a trademark of Dolby Laboratories.
- "Made for iPod" and "Made for iPhone" mean that an electronic accessory has been designed to connect specifically to iPod, or iPhone, respectively, and has been certified by the developer to meet Apple performance standards. Apple is not responsible for the operation of this device or its compliance with safety and regulatory standards. Please note that the use of this accessory with iPod, or iPhone may affect wireless performance.
- iPhone, iPod, and iPod touch are trademarks of Apple Inc., registered in the U.S. and other countries.
- Use of the Apple CarPlay logo means that a vehicle user interface meets Apple performance standards. Apple is not responsible for the operation of this vehicle or its compliance with safety and regulatory standards. Please note that the use of this product with iPhone, or iPod may affect wireless performance. Apple CarPlay and Apple CarPlay logo are trademarks of Apple Inc.
- Apple, Siri is a trademark of Apple Inc., registered in the U.S. and other countries. Lightning is a trademark of Apple Inc.
- Sirius, XM and all related marks and logos are trademarks of Sirius XM Radio Inc. All rights reserved.
- Pandora, the Pandora logo, and the Pandora trade dress are trademarks or registered trademarks of Pandora Media, Inc., used with permission.
- SPOTIFY and the Spotify logo are among the registered trademarks of Spotify AB.
- Android, Android Auto, Google Play and other marks are trademarks of Google LLC.
- WebLink™ is a trademark of Abalta Technologies, Inc.
- Waze and Waze logo are registered trademarks of Google LLC.

- YouTube and the YouTube logo are registered trademarks of Google LLC.
- This License does not grant permission to use the trade names, trademarks, service marks, or product names of the Licensor (Abalta Technologies, Inc.), except as required for reasonable and customary use in describing the origin of the \*\*WEBLINK Product\*\*.
- Wi-Fi® is a registered trademark of Wi-Fi Alliance®.
- The Wi-Fi CERTIFIED™ Logo is a certification mark of Wi-Fi Alliance®.
- BlackBerry®, RIM®, Research In Motion® and related trademarks, names and logos are the property of Research In Motion Limited and are registered and/or used in the U.S. and countries around the world. Used under license from Research In Motion Limited.
- This product includes FontAvenue® fonts licenced by NEC Corporation. FontAvenue is a registered trademark of NEC Corporation.



- This product includes "Ubiquitous QuickBoot™" technology developed by Ubiquitous Corp. Ubiquitous QuickBoot™ is a trademark of Ubiquitous Corp. Copyright© 2017 Ubiquitous Corp. All rights reserved.
  - ■ ■ ■ ■
  - Ubiquitous
- THIS PRODUCT IS LICENSED UNDER THE AVC PATENT PORTFOLIO LICENSE FOR THE PERSONAL USE OF A CONSUMER OR OTHER USES IN WHICH IT DOES NOT RECEIVE REMUNERATION TO (i) ENCODE VIDEO IN COMPLIANCE WITH THE AVC STANDARD ("AVC VIDEO") AND/OR (ii) DECODE AVC VIDEO THAT WAS ENCODED BY A CONSUMER ENGAGED IN A PERSONAL ACTIVITY AND/OR WAS OBTAINED FROM A VIDEO PROVIDER LICENSED TO PROVIDE AVC VIDEO. NO LICENSE IS GRANTED OR SHALL BE IMPLIED FOR ANY OTHER USE. ADDITIONAL INFORMATION MAY BE OBTAINED FROM MPEG LA, L.L.C. SEE [HTTP://WWW.MPEGLA.COM](http://www.mpegla.com)
- THIS PRODUCT IS LICENSED UNDER THE MPEG-4 VISUAL PATENT PORTFOLIO LICENSE FOR THE PERSONAL AND NON-COMMERCIAL USE OF A CONSUMER FOR (i) ENCODING VIDEO IN COMPLIANCE WITH THE MPEG-4 VISUAL STANDARD ("MPEG-4 VIDEO") AND/OR (ii) DECODING MPEG-4 VIDEO THAT WAS ENCODED BY A CONSUMER ENGAGED IN A PERSONAL AND NON-COMMERCIAL ACTIVITY AND/OR WAS OBTAINED FROM A VIDEO PROVIDER LICENSED BY MPEG LA TO PROVIDE MPEG-4 VIDEO. NO LICENSE IS GRANTED OR SHALL BE IMPLIED FOR ANY OTHER USE. ADDITIONAL INFORMATION INCLUDING THAT RELATING TO PROMOTIONAL, INTERNAL AND COMMERCIAL USES AND LICENSING MAY BE OBTAINED FROM MPEG LA, LLC. SEE [HTTP://WWW.MPEGLA.COM](http://www.mpegla.com).
- THIS PRODUCT IS LICENSED UNDER THE VC-1 PATENT PORTFOLIO LICENSE FOR THE PERSONAL AND NON-COMMERCIAL USE OF A CONSUMER TO (i) ENCODE VIDEO IN COMPLIANCE WITH THE VC-1 STANDARD

("VC-1 VIDEO") AND/OR (ii) DECODE VC-1 VIDEO THAT WAS ENCODED BY A CONSUMER ENGAGED IN A PERSONAL AND NON-COMMERCIAL ACTIVITY AND/OR WAS OBTAINED FROM A VIDEO PROVIDER LICENSED TO PROVIDE VC-1 VIDEO. NO LICENSE IS GRANTED OR SHALL BE IMPLIED FOR ANY OTHER USE. ADDITIONAL INFORMATION MAY BE OBTAINED FROM MPEG LA, L.L.C. SEE [HTTP://WWW.MPEGLA.COM](http://www.mpegla.com)

- libFLAC

Copyright (C) 2000-2009 Josh Coalson  
Copyright (C) 2011-2013 Xiph.Org Foundation  
Redistribution and use in source and binary forms, with or without modification, are permitted provided that the following conditions are met:

- Redistributions of source code must retain the above copyright notice, this list of conditions and the following disclaimer.
- Redistributions in binary form must reproduce the above copyright notice, this list of conditions and the following disclaimer in the documentation and/or other materials provided with the distribution.
- Neither the name of the Xiph.org Foundation nor the names of its contributors may be used to endorse or promote products derived from this software without specific prior written permission.

THIS SOFTWARE IS PROVIDED BY THE COPYRIGHT HOLDERS AND CONTRIBUTORS "AS IS" AND ANY EXPRESS OR IMPLIED WARRANTIES, INCLUDING, BUT NOT LIMITED TO, THE IMPLIED WARRANTIES OF MERCHANTABILITY AND FITNESS FOR A PARTICULAR PURPOSE ARE DISCLAIMED. IN NO EVENT SHALL THE FOUNDATION OR CONTRIBUTORS BE LIABLE FOR ANY DIRECT, INDIRECT, INCIDENTAL, SPECIAL, EXEMPLARY, OR CONSEQUENTIAL DAMAGES (INCLUDING, BUT NOT LIMITED TO, PROCUREMENT OF SUBSTITUTE GOODS OR SERVICES; LOSS OF USE, DATA, OR PROFITS; OR BUSINESS INTERRUPTION) HOWEVER CAUSED AND ON ANY THEORY OF LIABILITY, WHETHER IN CONTRACT, STRICT LIABILITY, OR TORT (INCLUDING NEGLIGENCE OR OTHERWISE) ARISING IN ANY WAY OUT OF THE USE OF THIS SOFTWARE, EVEN IF ADVISED OF THE POSSIBILITY OF SUCH DAMAGE.

- libvorbis

Copyright (c) 2002-2008 Xiph.org Foundation  
Redistribution and use in source and binary forms, with or without modification, are permitted provided that the following conditions are met:

- Redistributions of source code must retain the above copyright notice, this list of conditions and the following disclaimer.
- Redistributions in binary form must reproduce the above copyright notice, this list of conditions and the following disclaimer in the documentation and/or other materials provided with the distribution.
- Neither the name of the Xiph.org Foundation nor the names of its contributors may be used to

endorse or promote products derived from this software without specific prior written permission.

THIS SOFTWARE IS PROVIDED BY THE COPYRIGHT HOLDERS AND CONTRIBUTORS "AS IS" AND ANY EXPRESS OR IMPLIED WARRANTIES, INCLUDING, BUT NOT LIMITED TO, THE IMPLIED WARRANTIES OF MERCHANTABILITY AND FITNESS FOR A PARTICULAR PURPOSE ARE DISCLAIMED. IN NO EVENT SHALL THE FOUNDATION OR CONTRIBUTORS BE LIABLE FOR ANY DIRECT, INDIRECT, INCIDENTAL, SPECIAL, EXEMPLARY, OR CONSEQUENTIAL DAMAGES (INCLUDING, BUT NOT LIMITED TO, PROCUREMENT OF SUBSTITUTE GOODS OR SERVICES; LOSS OF USE, DATA, OR PROFITS; OR BUSINESS INTERRUPTION) HOWEVER CAUSED AND ON ANY THEORY OF LIABILITY, WHETHER IN CONTRACT, STRICT LIABILITY, OR TORT (INCLUDING NEGLIGENCE OR OTHERWISE) ARISING IN ANY WAY OUT OF THE USE OF THIS SOFTWARE, EVEN IF ADVISED OF THE POSSIBILITY OF SUCH DAMAGE.

- libogg

Copyright (c) 2002, Xiph.org Foundation  
Redistribution and use in source and binary forms, with or without modification, are permitted provided that the following conditions are met:

- Redistributions of source code must retain the above copyright notice, this list of conditions and the following disclaimer.
- Redistributions in binary form must reproduce the above copyright notice, this list of conditions and the following disclaimer in the documentation and/or other materials provided with the distribution.
- Neither the name of the Xiph.org Foundation nor the names of its contributors may be used to endorse or promote products derived from this software without specific prior written permission.

THIS SOFTWARE IS PROVIDED BY THE COPYRIGHT HOLDERS AND CONTRIBUTORS "AS IS" AND ANY EXPRESS OR IMPLIED WARRANTIES, INCLUDING, BUT NOT LIMITED TO, THE IMPLIED WARRANTIES OF MERCHANTABILITY AND FITNESS FOR A PARTICULAR PURPOSE ARE DISCLAIMED. IN NO EVENT SHALL THE FOUNDATION OR CONTRIBUTORS BE LIABLE FOR ANY DIRECT, INDIRECT, INCIDENTAL, SPECIAL, EXEMPLARY, OR CONSEQUENTIAL DAMAGES (INCLUDING, BUT NOT LIMITED TO, PROCUREMENT OF SUBSTITUTE GOODS OR SERVICES; LOSS OF USE, DATA, OR PROFITS; OR BUSINESS INTERRUPTION) HOWEVER CAUSED AND ON ANY THEORY OF LIABILITY, WHETHER IN CONTRACT, STRICT LIABILITY, OR TORT (INCLUDING NEGLIGENCE OR OTHERWISE) ARISING IN ANY WAY OUT OF THE USE OF THIS SOFTWARE, EVEN IF ADVISED OF THE POSSIBILITY OF SUCH DAMAGE.

## Appendix

### ■ FCC WARNING

This equipment may generate or use radio frequency energy. Changes or modifications to this equipment may cause harmful interference unless the modifications are expressly approved in the instruction manual. The user could lose the authority to operate this equipment if an unauthorized change or modification is made.

#### NOTE

- This equipment has been tested and found to comply with the limits for a Class B digital device, pursuant to Part 15 of the FCC Rules. These limits are designed to provide reasonable protection against harmful interference in a residential installation.
- This equipment generates, used and can radiate radio frequency energy and, if not installed and used in accordance with the instructions may cause harmful interference to radio communications. However, there is no guarantee that interference will not occur in a particular installation. If this equipment does cause harmful interference to radio or television reception, which can be determined by turning the equipment off and on, the user is encouraged to try to correct the interference by one or more of the following measures:
  - Reorient or relocate the receiving antenna.
  - Increase the separation between the equipment and receiver.
  - Connect the equipment into an outlet on a circuit different from that to which the receiver is connected.
  - Consult the dealer or an experienced radio/TV technician for help.

### ▲ CAUTION

Use of controls or adjustments or performance of procedures other than those specified herein may result in hazardous radiation exposure.

In compliance with Federal Regulations, following are reproductions of labels on, or inside the product relating to laser product safety.

JVC KENWOOD Corporation  
2967-3, ISHIKAWA-MACHI,  
HACHIOJI-SHI, TOKYO, JAPAN

THIS PRODUCT COMPLIES WITH DHHS RULES  
21 CFR SUBCHAPTER J IN EFFECT AT DATE OF  
MANUFACTURE.

Location: Top plate

This transmitter must not be co-located or operated in conjunction with any other antenna or transmitter.

### ■ IC (Industry Canada) Notice

This device complies with Industry Canada's applicable licence-exempt RSSs.

Operation is subject to the following two conditions:

- (1) This device may not cause interference, and
- (2) this device must accept any interference, including interference that may cause undesired operation of the device.

### ▲ CAUTION

This equipment complies with FCC/IC radiation exposure limits set forth for an uncontrolled environment and meets the FCC radio frequency (RF) Exposure Guidelines and RSS-102 of the IC radio frequency (RF) Exposure rules. This equipment should be installed and operated keeping the radiator at least 20cm or more away from person's body.

### ■ CALIFORNIA, USA

This product contains a CR Coin Cell Lithium Battery which contains Perchlorate Material – special handling may apply.

See [www.dtsc.ca.gov/hazardouswaste/perchlorate](http://www.dtsc.ca.gov/hazardouswaste/perchlorate).

■ Información acerca de la eliminación de equipos eléctricos y electrónicos al final de la vida útil (aplicable a los países que hayan adoptado sistemas independientes de recogida de residuos)



Los productos con el símbolo de un contenedor con ruedas tachado no podrán ser desechados como residuos domésticos.

Los equipos eléctricos y electrónicos al final de la vida útil, deberán ser reciclados en instalaciones que puedan dar el tratamiento adecuado a estos productos y a sus subproductos residuales correspondientes. Póngase en contacto con su administración local para obtener información sobre el punto de recogida más cercano. Un tratamiento correcto del reciclaje y la eliminación de residuos ayuda a conservar los recursos y evita al mismo tiempo efectos perjudiciales en la salud y el medio ambiente.

■ Informação sobre a eliminação de pilhas

Este produto não deve ser eliminado como lixo doméstico geral. Devolva a pilha usada ao revendedor ou entidade autorizada para que a mesma seja devolvida ao fabricante ou importador.

A reciclagem e a eliminação de lixo de maneira apropriada ajudarão a conservar os recursos naturais ao mesmo tempo que prevenirão os efeitos prejudiciais à nossa saúde e ao meio ambiente.

■ Para cumplimiento de la IFT:

“La operación de este equipo esta sujeta a las siguientes dos condiciones:

(1) es posible que este equipo o dispositivo no cause interferencia perjudicial y

(2) este equipo o dispositivo debe aceptar cualquier interferencia,

incluyendo la que pueda causar su operación no deseada.”

**JVC**