

JVC®

LCD Flat Television Users Guide

***For Models:
LT-42X688
LT-37X688***



Illustration of LT-37X688 and RM-C1450

Important Note:

In the spaces below, enter the model and serial number of your television (located at the rear of the television cabinet). Staple your sales receipt or invoice to the inside cover of this guide. Keep this user's guide in a convenient place for future reference. Keep the carton and original packaging for future use.

Model Number: _____

Serial Number: _____

LCT2275-001A-A
0507TNH-II-IM

Important Safety Precautions

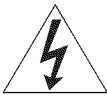

CAUTION
RISK OF ELECTRIC SHOCK
DO NOT OPEN

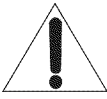

CAUTION: To reduce the risk of electric shock, Do not remove cover (or back). No user serviceable parts inside. Refer servicing to qualified service personnel.

The lightning flash with arrowhead symbol, within an equilateral triangle is intended to alert the user to the presence of uninsulated "dangerous voltage" within the product's enclosure that may be of sufficient magnitude to constitute a risk of electric shock to persons.

The exclamation point within an equilateral triangle is intended to alert the user to the presence of important operating and maintenance (servicing) instructions in the literature accompanying the appliance.

WARNING: TO PREVENT FIRE OR SHOCK HAZARDS, DO NOT EXPOSE THIS APPARATUS TO RAIN OR MOISTURE.

CAUTION: TO INSURE PERSONAL SAFETY, OBSERVE THE FOLLOWING RULES REGARDING THE USE OF THIS UNIT.

1. Operate only from the power source specified on the unit.
2. Avoid damaging the AC plug and power cord.
3. Avoid Improper installation and never position the unit where good ventilation is unattainable.
4. Do not allow objects or liquid into the cabinet openings.
5. In the event of trouble, unplug the unit and call a service technician. Do not attempt to repair it yourself or remove the rear cover.

Changes or modifications not approved by JVC could void the warranty.

- * When you don't use this TV set for a long period of time, be sure to disconnect both the power plug from the AC outlet and antenna for your safety.
- * To prevent electric shock do not use this polarized plug with an extension cord, receptacle or other outlet unless the blades can be fully inserted to prevent blade exposure.



- As an "ENERGY STAR®" partner, JVC has determined that this product or product model meets the "ENERGY STAR®" guidelines for energy efficiency.

IMPORTANT RECYCLING INFORMATION

This product has a fluorescent lamp that contains mercury. Disposal of these materials may be regulated in your community due to environmental considerations. For disposal or recycling information, please contact your local authorities or for USA, the Electronic Industries Alliance: <http://www.eiae.org>

IMPORTANT SAFETY INSTRUCTIONS

- 1) Read these instructions.
- 2) Keep these instructions.
- 3) Heed all warnings.
- 4) Follow all instructions.
- 5) Do not use this apparatus near water.
- 6) Clean only with dry cloth.
- 7) Do not block any ventilation openings. Install in accordance with the manufacturer's instructions.
- 8) Do not install near any heat sources such as radiators, heat registers, stoves, or other apparatus (including amplifiers) that produce heat.
- 9) Do not defeat the safety purpose of the polarized or grounding-type plug. A polarized plug has two blades with one wider than the other. A grounding type plug has two blades and a third grounding prong. The wide blade or the third prong are provided for your safety. If the provided plug does not fit into your outlet, consult an electrician for replacement of the obsolete outlet.
- 10) Protect the power cord from being walked on or pinched particularly at plugs, convenience receptacles, and the point where they exit from the apparatus.
- 11) Only use attachments/accessories specified by the manufacturer.
- 12) Use only with a cart, stand, tripod, bracket, or table specified by the manufacturer, or sold with the apparatus. When a cart is used, use caution when moving the cart/apparatus combination to avoid injury from tip-over.



- 13) Unplug this apparatus during lightning storms or when unused for long periods of time.
- 14) Refer all servicing to qualified service personnel. Servicing is required when the apparatus has been damaged in any way, such as power-supply cord or plug is damaged, liquid has been spilled or objects have fallen into the apparatus, the apparatus has been exposed to rain or moisture, does not operate normally, or has been dropped.
- 15) Apparatus shall not be exposed to dripping or splashing and no objects filled with liquids, such as vases, shall be placed on the apparatus.
- 16) Avoid improper installation and never position the unit where good ventilation is impossible. When installing this TV, distance recommendations must be maintained between the set and the wall, as well as inside a tightly enclosed area or piece of furniture. Keep to the minimum distance guidelines shown for safe operation.

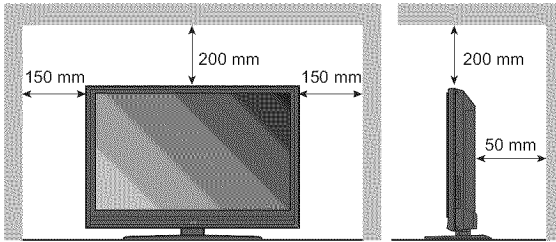

17) Cautions for installation

- Do not tilt the TV towards the left or right, or towards the back.
 - Install the TV in a corner on the floor so as to keep cords out of the way.
 - The TV will generate a slight amount of heat during operation. Ensure that sufficient space is available around the TV to allow satisfactory cooling.
- 18) Make enough room for inserting and removing the power plug. Place the TV as close to the outlet as possible. The main power supply for this TV is controlled by inserting or removing the power plug.
 - 19) Batteries shall not be exposed to excessive heat such as sunshine, fire or the like.
 - 20) When this TV is connected to the wall outlet, it is always on standby even when all the LED lamps are not lit. To shut down the TV, unplug the TV from the wall outlet.

Warnings

We have an important note for customers who subscribe to basic cable services (do not have a separate cable box) and plan to use their JVC TV remote control to select channels.

Once you run the Auto Tuner Setup (which detects and programs all the channels your TV is receiving through the RF input), every channel number available from your cable company will appear in your television's Channel Summary and they will all be marked as available for scanning. Even though every channel is detected and appears as available, you will only be able to view those that you specifically subscribe to from your cable company. This will likely mean there are blank channels between those channels you wish to scan or "surf".

We apologize for any inconvenience this may cause but it is important to note that this is not a malfunction of your television. If you want to sequentially scan those channels you subscribe to without blank ones in between, you can contact your cable company for their cable box and remote.

Avoiding Ghost Images

Displaying fixed images for extended periods of time can leave a subtle but temporary ghost image on your screen. To avoid this, mix your viewing pattern.

Examples include, but are not limited to the following:

- Stock-market report bars
- Shopping channel logos and pricing displays
- Video game patterns or scoreboards
- Bright station logos
- Internet web sites or other computer-style images
- DVD discs, video tapes, laser discs
- Broadcast, cable, satellite channels or digital television tuners/converters

For example...

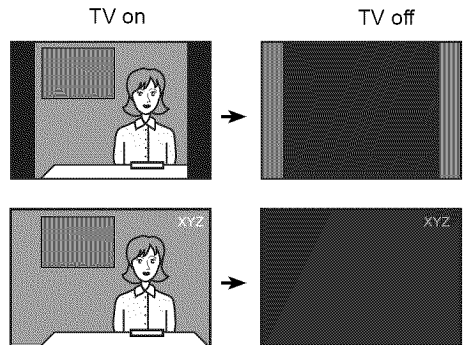

Warnings

Caring for the Cabinet

Normally, light dusting with a soft, non-scratching duster will keep your TV clean.

If you wish to wipe down the television, first unplug it. Then wipe gently with a soft cloth, slightly moistened with water. You can add a few drops of mild liquid detergent to the water to help remove spots of oily dirt.

- DO NOT allow liquid to enter the TV through the ventilation slots.
- DO NOT use strong or abrasive cleaners on the TV.
- DO NOT spray liquids or cleaners directly on the TV's surface.
- DO NOT rub or scrub the TV harshly. Wipe the set gently with a soft cloth.

Caring for the Screen

The screen is treated with an electrostatic-proof coating. When it gets dirty, wipe it gently with a soft cloth. If the screen is very dirty, wipe it down with a cloth dipped in a diluted kitchen cleaner and thoroughly wrung-out. Then wipe immediately after with a clean, dry cloth.

Do not apply alcohol, organic solvents (like acetone), acidic or alkaline cleansers to the screen. These will remove the coating layer and cause discolorations.

Do not push or hit the screen. This could cause scratches on the screen surface and image distortions.

Tidying the cables

A cable holder which keeps your connection cables tidy is attached to the back of the stand.

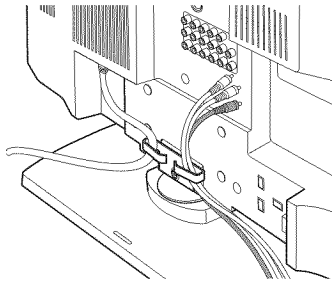

Warnings

Disconnecting the stand

If you disconnect the stand, attach the bottom cover and the screw (supplied) into the hole.

- 1) Place the TV face down on a soft cloth on a table.
- 2) Remove the four screws from the back of the TV.

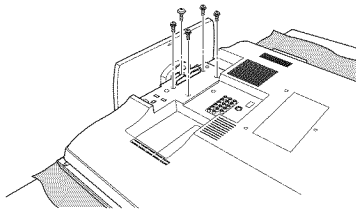

- 3) Pull out the stand from the TV.

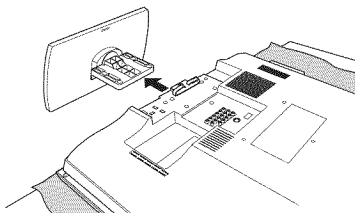

- 4) Cover the hole with a bottom cover and tighten the screw.

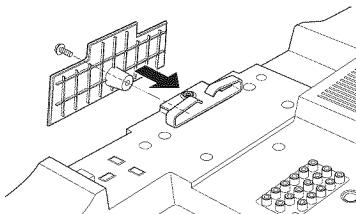

Note:

- To re-install the stand, reverse the procedure from 4) to 1).

Table of Contents

Important Safety Precautions . . .	2	Sound Adjust	50
Warnings	5	Sound Settings	50
Quick Setup	9	Turn On Volume	50
Unpacking your TV	9	Volume Limit	51
TV Models	10	Reset	51
TV Remote Control	11	Clock/Timers	52
Getting Started	12	Set Clock	52
The Remote Control	12	On/Off Timer	53
Connecting Your Devices	13	Photo Viewer	54
Interactive Plug-in Menu	21	Auto Demo	56
Onscreen Menus	24	Button Functions	57
Using the Guide	24	Power	57
Onscreen Menu System	25	Number Buttons	57
Initial Setup	28	Tune	57
Noise Muting	28	Input	57
Language	28	Channel +/-	57
Front Panel Lock	28	Volume +/-	57
V-Chip	29	Return+/TV	58
Set Lock Code	35	Sound	58
Closed Caption	36	Muting	58
Auto Shut Off	38	Video Status	59
Software Version	38	Sleep Timer	59
Power Indicator	38	Display	60
Optical Out	39	C.C.	60
Quick Start-up	39	Aspect	61
Tuner Setup	40	Menu	62
Auto Tuner Setup	40	OK	62
Channel Summary	41	Back	62
Find Channel	43	ML/MTS	63
Digital Antenna Level	43	Sub Channel	63
Tuner Diagnostic	43	Favorite	64
External Input	44	Guide	64
HDMI Size	44	Mode	65
Video-1 Audio	44	External device control buttons	65
Video Input Label	45	Remote Programming	66
Picture Adjust	46	OSD Information	72
Picture Settings	46	Weak Signal	72
Color Temperature	46	Audio/Data Only Channel	72
Color Management	47	Troubleshooting	73
Dynamic Gamma	47	Specifications	75
Smart Picture	47	Warranty	76
Digital VNR	48	Authorized Service Center	77
MPEG NR	48	Notes	78
Natural Cinema	48		
Position Adjustment	49		
Reset	49		

Unpacking your TV

Thank you for your purchase of a JVC LCD Flat Television. Before you begin setting up your new television, please check to make sure you have all of the following items. In addition to this guide, your television box should include:

Television x 1

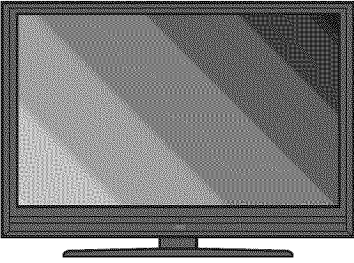

Remote Control x 1

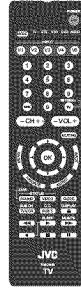

AA Batteries x 2



Note: Your television and/or remote control may differ from the examples illustrated here.

Cover x 1

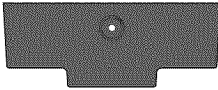

Screw x 1



We recommend that before you start using your new television, you read this entire User's Guide so you can learn about your new television's many great features. If you're anxious to start using your television right away, a quick setup guide follows on the next few pages.

Quick Setup

TV Models

Before you connect your television to another device, please refer to the proper diagrams for your specific TV and remote. These will help assist you in understanding how to connect your television to another device, as well as use the remote to set up your television.

Rear Panel Diagram

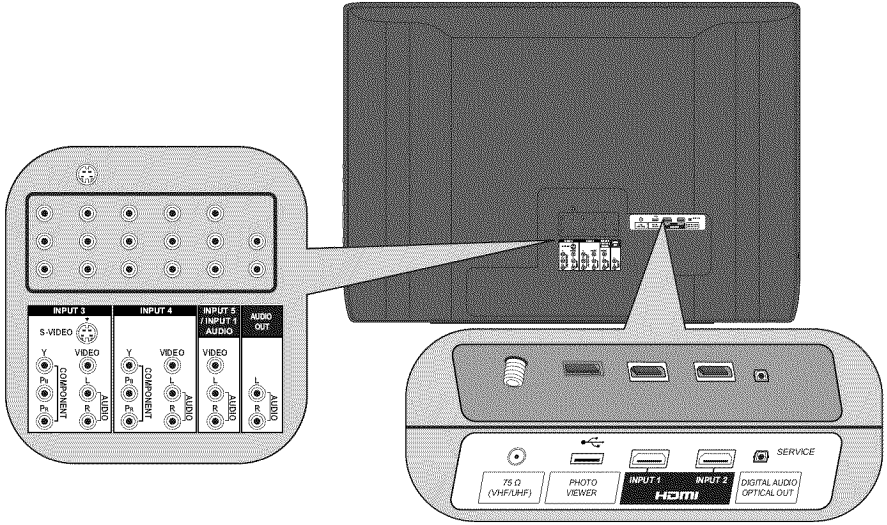

Side Panel Diagram

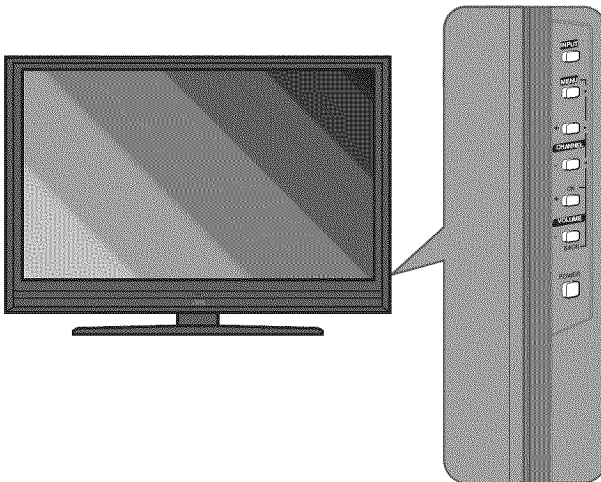

Remote Control

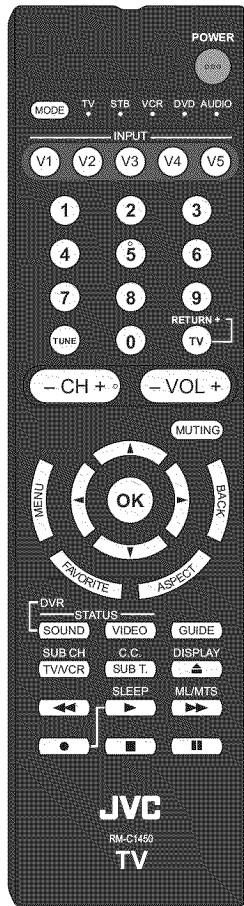

RM-C1450

Notes:

- For information on remote control buttons, see pages 57 - 64.
- SUB CHANNEL and GUIDE buttons are for digital channels. If your TV is connected to an ATSC antenna or Digital Cable, you can use these buttons.
- This remote control is capable of operating many external device brands. See page 66 - 71 for how to program the remote control.

Quick Setup

Getting Started

These quick setup pages will provide you, in three easy steps, with the basic information you need to begin using your new television right away. If you have questions, or for more detailed information on any of these steps, please consult other sections of this manual.

Step 1 – The Remote Control

Before you can operate your remote control, you first need to install the batteries (included).

Raise the latch on the remote's back cover to remove. Insert two batteries, carefully noting the "+" and "-" markings. Place the "-" end in the unit first. Snap the cover back into place.

When you change the batteries, try to complete the task within three minutes. If you take longer than three minutes, the remote control codes (ex. VCR, DVD) may have to be reset. See pages 66 - 71.

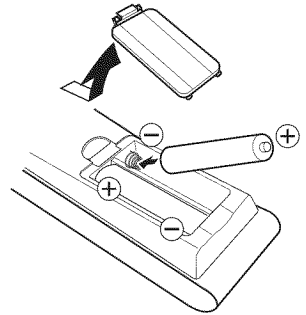

Basic Operation

Turn the television on and off by pressing the **POWER** button at the top right corner of the remote. If this is the first time you are turning on the TV, the interactive plug-in menu appears.

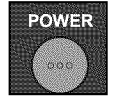

- At first, to watch your TV, select the TV mode by pressing the **MODE** button on the remote control before you turn the TV power on.
- See page 57 to 64 for details regarding the remote control buttons.

Using Menu Buttons

To use the menu functions, press the **MENU** button. Next, select a menu using the four arrow keys. The four arrow keys are used only for menu selections.

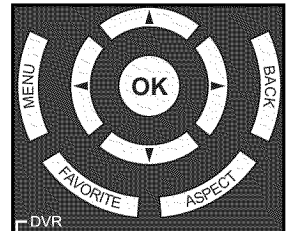

Step 2 - Connecting your devices

To make these connections, you will use plugs like the ones illustrated below.

Coaxial Cables



Used to connect an external antenna or cable TV system to your TV.

S-Video Cable



Used to make video connections with S-Video VCRs, Camcorders and DVD players.

Component Cables Composite Cables Audio Cables



Used to connect audio/video devices like VCRs, DVD players, stereo amplifiers, game consoles, etc.

Notes:

- The following connection diagrams are examples.
- After you are finished connecting your devices, plug the power cord into the nearest power outlet and turn on the TV.
- If you follow these diagrams and the television does not work properly, contact your local cable operator.
- To connect a DVD player, see VCR Connection.
- If you have a satellite television system, refer to the satellite TV manual.

No VCR Connection

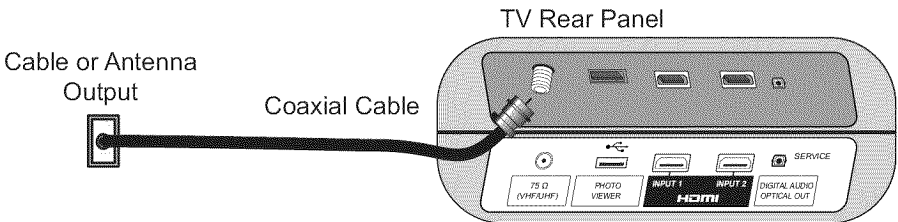

Quick Setup

VCR • DVD Connection

Notes:

- Green, blue and red are the most common colors for DVD cables. Some models may vary colors. Please consult the user's manual for your DVD player for more information.
- Be careful not to confuse the red DVD cable with the red audio cable. It is best to complete one set of connections (DVD or audio output) before starting the other to avoid accidentally switching the cables.
- You may also connect the DVD player to Input 1.

Diagram #1

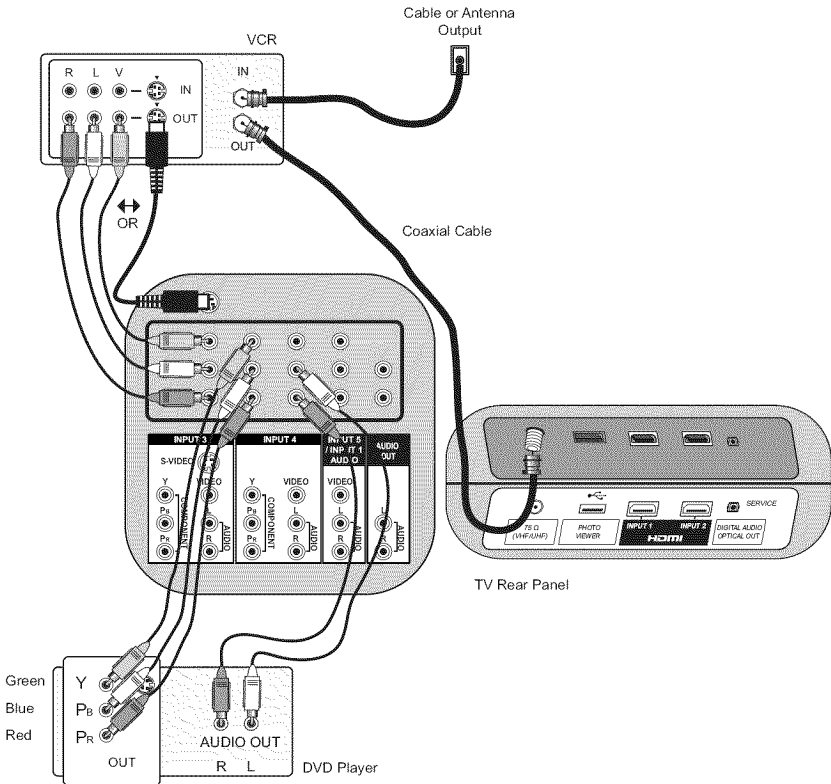

Note:

- If this connection setup does not work for you, try the connection setup on page 15.

Quick Setup

Diagram #2

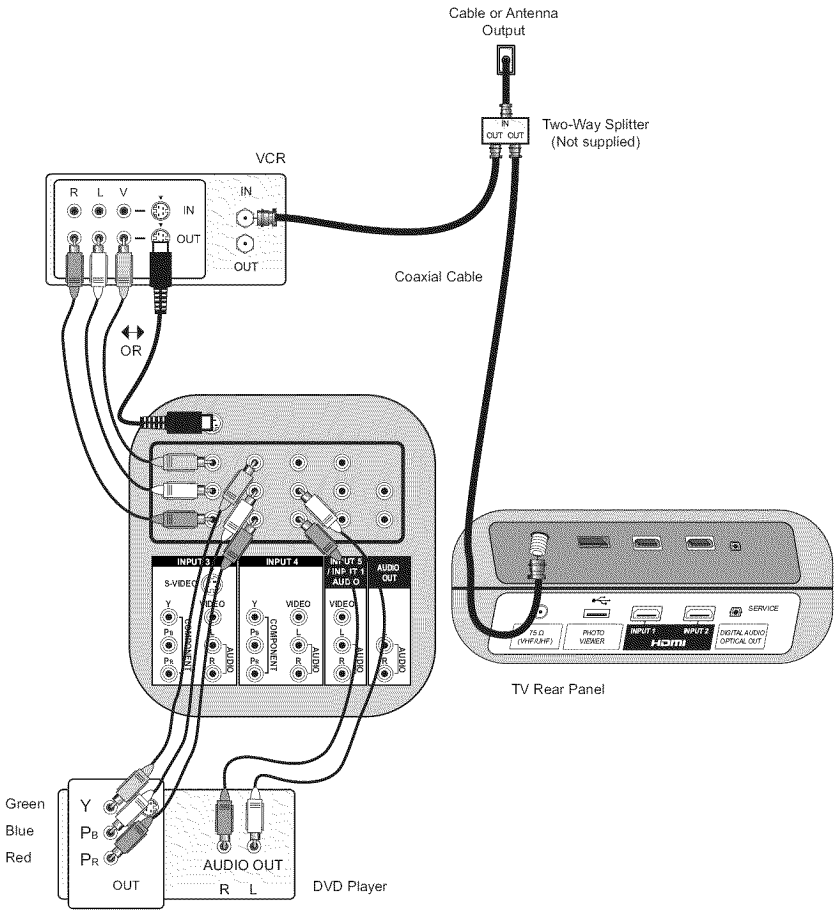

Quick Setup

Connecting to a Camcorder

You can connect a camcorder to your television by using the input jacks located on the back of the television.

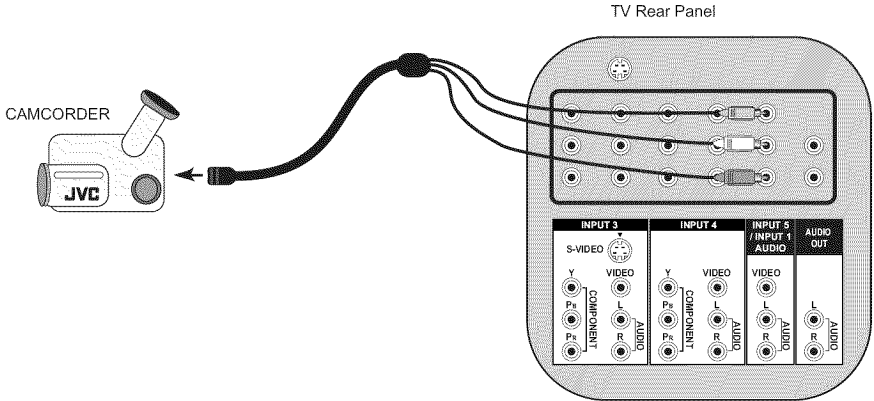

- 1) Connect a yellow composite cable from the camcorder VIDEO OUT to the VIDEO IN on the back of the TV.
- 2) Connect a white cable from the camcorder LEFT AUDIO OUT to the LEFT AUDIO IN on the back of the TV.
- 3) Connect a red cable from the camcorder RIGHT AUDIO OUT to the RIGHT AUDIO IN on the back of the TV.

Connecting to an External Amplifier

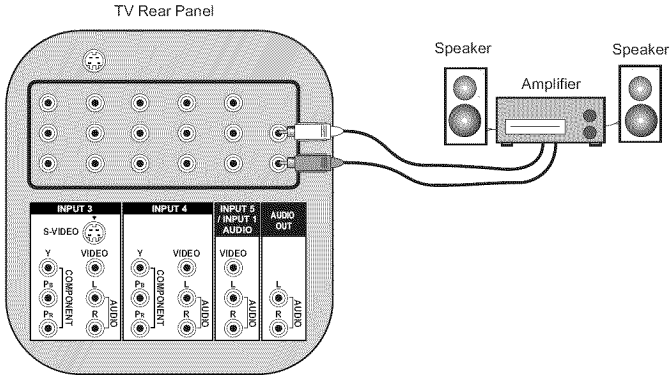

- 1) Connect a white cable from the LEFT AUDIO OUTPUT on the back of the TV to the LEFT AUDIO INPUT on the amplifier.
- 2) Connect a red cable from the RIGHT AUDIO OUTPUT on the back of the TV to the RIGHT AUDIO INPUT on the amplifier.

Notes:

- Refer to your amplifier's manual for more information.
- You can use AUDIO OUTPUT for your home theater system.
- If you have a device connected to INPUT-1 or INPUT-2, you will not be able to hear any audio from the AUDIO OUT on the back of the TV.

Quick Setup

Connecting to a Digital TV Receiver

By connecting a Digital TV Receiver, high definition pictures can be displayed on your TV in their digital form.

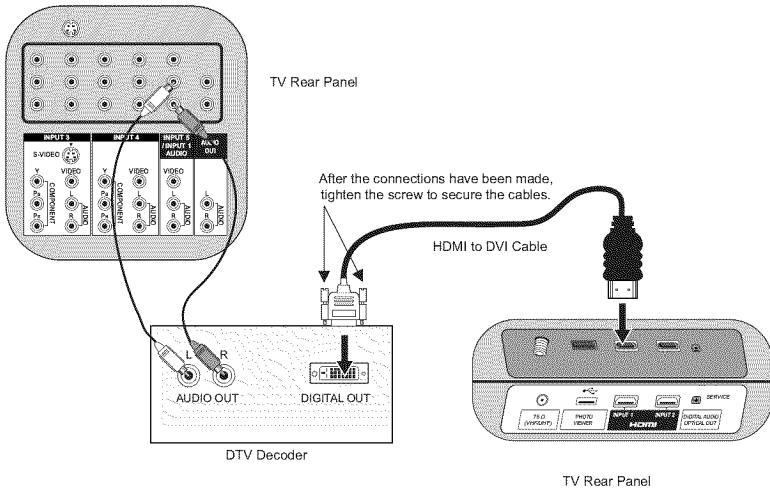

- 1) Connect the HDMI to DVI Cable from the DIGITAL OUT on the back of your DTV decoder to the HDMI INPUT-1 on the back of your television.
 - 2) Connect a red cable from the DTV decoder RIGHT AUDIO OUT to the RIGHT AUDIO INPUT HDMI AUDIO IN "R" on the back of your television.
 - 3) Connect a white cable from the DTV decoder LEFT AUDIO OUT to the LEFT AUDIO INPUT HDMI AUDIO IN "L" on the back of your television.
- Personal computer compatibility cannot be guaranteed.
 - Use an HDMI to DVI cable (commercially available) in order to digitally connect the television with a DTV decoder.

Notes:

- If 480p signals (640x480 or 720x480) are displayed on the screen, the horizontal balance may be slightly shifted. Access the "HDMI Size" in the External Input menu to adjust it. (Refer to page 44.)
- When you do the above connection, set "Video-1 Audio" in the External Input menu to "Analog". See "Video-1 Audio", page 44.
- The Analog Audio input can only be used with the HDMI INPUT-1.
- When setting the "Video-1 Audio - Analog/Digital" menu setting on the TV, please note that this setting only effects the HDMI INPUT-1 jack and that if you use a DVI to HDMI adapter this connection must be made to the HDMI INPUT-1 along with analog audio cables.

Connecting to an HDMI Compatible Device

By connecting an HDMI compatible device, high definition pictures can be displayed on your TV in their digital form. Some HDMI devices can include DVD players, D-VHS or any HDMI compatible device.

HDMI (High Definition Multimedia Interface) is the first industry supported, uncompressed, all digital audio/video interface. HDMI provides an interface between any audio/video source, such as a set-top box, DVD player, A/V receiver or an audio and/or video monitor, such as a digital television (DTV).

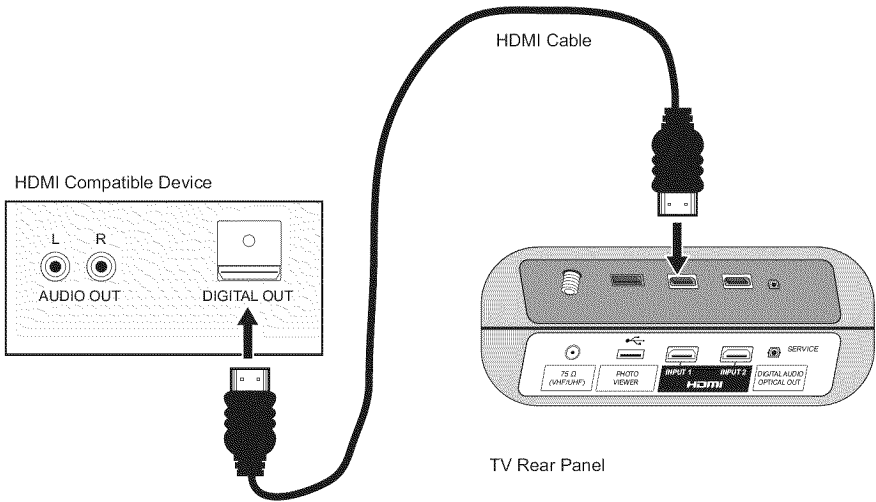

- 1) Connect the HDMI Cable from the DIGITAL OUT on the back of your DTV or HDMI device to the HDMI INPUT-1 on the back of your television.

Notes:

- When you do the above connection, set "Video-1 Audio" in the External Input menu to Digital. See "Video-1 Audio", page 44.
- Some decoders may not respond depending on the equipment that is connected to the HDMI.
- If the HDMI output device signal is changed (for example, 480i/60Hz is changed to 480p/60Hz), the screen may turn green and there may be some distortion for a short time until the signal becomes stable.
- This TV can accept 480i, 480p, 720p, 1080i and 1080p signals via HDMI.

Quick Setup

Connecting to an amplifier using your optical output

You can connect an amplifier that has an optical digital input terminal by using an optical digital cable from the optical output. The signal that is output can be PCM or DOLBY DIGITAL.

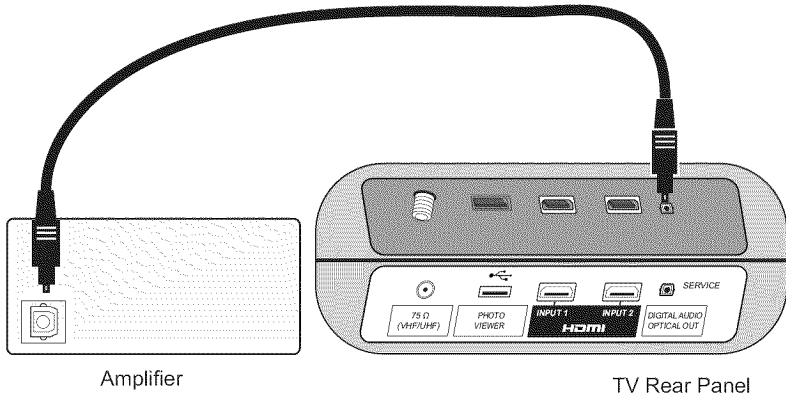

- 1) Connect the optical cable from underneath the television to the back of the amplifier.

Notes:

- This terminal can only output digital audio.
- In order to use the optical output connection, select PCM or DOLBY DIGITAL on Optical Out in the Initial Setup Menu. See page 39.
- Refer to your owners manual on using your amplifier.
- You cannot output sound from your Optical Output connection if the audio source is from your HDMI device.

Step 3 – The Interactive Plug-in Menu

When you turn your television on for the first time the interactive plug-in menu will appear. The plug-in menu helps you to get your TV ready to use by letting you set your preferences for:

- The language in which you want the onscreen menus to appear.
- Setting the TV's clock to the correct time so your timer functions will work properly. You can choose "Auto" or "Manual" for setting the clock.
- The auto tuner setup of which channels you wish to receive.

We recommend you complete the interactive plug-in items before you start using your television. After the first time you turn on your TV, you can access the Interactive Plug-In Menu from the main menu. See page 27.

Note:

- If you press the MENU button while setting up the interactive plug-in menu, it will skip over it.

Language

After the "JVC Interactive Plug-in Menu" has been displayed, the TV automatically switches to the "Language" settings. You can choose to view your onscreen menus in three languages: English, French or Spanish.

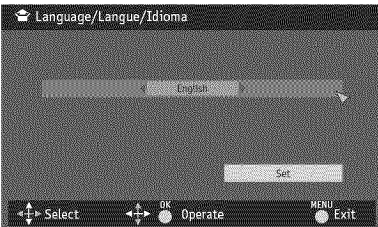

To choose a language:
(English, Français or Español.)



To "Set"



Press the Ok button

Once you press Ok, you will move to the "Set Clock" Plug-in Menu automatically.

(Continued...)

Quick Setup

Auto Clock Set

You may set your clock using the time data sent via broadcasting.

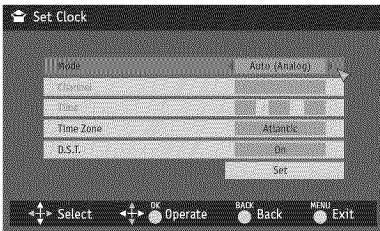

- ◀▶ To choose "Auto (Analog)" or "Auto (Digital)"
- ▼ To "Channel" when you selected "Auto (Digital)"
- ◀▶ To select a receiving digital channel
- ▼ To "Time Zone"
- ◀▶ To select your time zone: (Atlantic, Eastern, Central, Mountain, Pacific, Alaska or Hawaii)
- ▼ To move to "D.S.T." (Daylight Savings Time)
- ◀▶ To turn "On or Off"
- ▼ To "set"
- ▼ Press the OK button
- ☞ *Once you press OK, you will move to the "Auto Tuner Setup" Plug-in Menu automatically.*

Notes:

- "Channel" can be selected only when Mode is "Auto (Digital)". However, only when you are using "Auto (Digital)" for the first time, you cannot select "Channel".
- D.S.T. can be used when it is set to "On" in the "Set Clock" menu.
- Only when the Mode is set to "Auto", the Daylight Saving Time feature automatically adjusts your TV's clock for Daylight Saving.
- The real time and D.S.T. may not be set correctly depending on the broadcasting signal and receiving conditions. In this case, set your clock manually.
- You will have to reset the clock after a power interruption. You must set the clock before operating any timer functions.

Manual Clock Set

To set your clock manually, choose "Manual". If you choose "Auto", see auto clock set above.

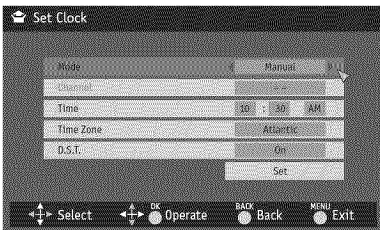

- ◀▶ To choose "Manual"
- ▼ To "Time"
- ◀▶ To set the hour
- ▼ To minute
- ◀▶ To set the minute
- ▼ To "Time Zone"
- ◀▶ To select your time zone: (Atlantic, Eastern, Central, Mountain, Pacific, Alaska or Hawaii)
- ▼ To move to "D.S.T." (Daylight Savings Time)
- ◀▶ To turn "On or Off"
- ▼ To "Set"
- ▼ Press the OK button
- ☞ *Once you press OK, you will move to the "Auto Tuner Setup" Plug-in Menu automatically.*

Note:

- You will have to reset the clock after a power interruption. You must set the clock before operating any timer functions.

(Continued...)

Auto Tuner Setup

In auto tuner setup, the TV automatically scans through all available channels, memorizing the active ones and skipping over blank ones or channels with weak signals. This means when you scan (using the CHANNEL +/- buttons) you will receive only clear, active channels.

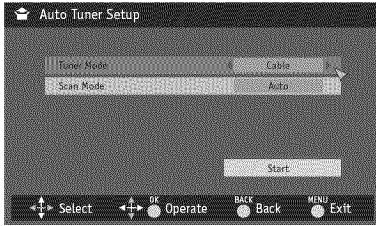

To choose "Cable" or "Air" (or "Skip" when you skip "Auto Tuner Setup")



To Scan Mode



To choose Auto, STD, HRC or IRC



To "Start"



Press the Ok button



When the setup is finished, "Thank you ! Setup is now complete." is displayed. Your quick setup is now complete. You can now begin watching your television, or you can continue on in this guide for more information on programming your remote control, or using the JVC onscreen menu system to customize your television viewing experience.

Notes:

- You can choose Scan Mode only when Tuner Mode is Cable.
- If you want to cancel the Auto Tuner Setup, press the MENU button.
- Noise muting will not work during Auto Tuner Setup.
- If you choose "Skip", it finished without doing the Auto Tuner Setup.

Cable Users: After your auto tuner setup is complete, you may, (depending on the type of hookup), have only 1 channel, usually 3 or 4 in the auto tuner memory. This is normal.

Onscreen Menus

Using the Guide

Certain symbols are used throughout this guide to help you learn about the features of your new television. The ones you will see most frequently are:

- ▲▼ Up and Down arrows mean:
 - Move vertically in a main menu screen
 - Move through a submenu screen
 - Move to the next letter, number, or other choice in a submenu
- ◀▶ Left and right arrows mean:
 - Select a highlighted menu item
 - Select an item in a submenu
 - Select numbers in certain menu options

 The "press button" icon means you should press the button named on your remote control. (Button names appear in SMALL CAPITAL LETTERS.)

 The "helping arrow" icon points to the highlighted or selected item in a menu.

To bring up the onscreen menu, press the MENU button on the remote control. The following (left) main menu will appear. The item that appears in orange is the one currently selected. If you use the MENU button on the TV's side panel instead of the remote, Front Menu screen showing "Video Status", "Aspect", "Auto Tuner Setup" and "Menu" will appear (following right screen).

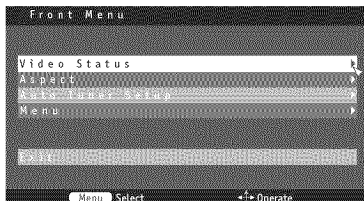

Note:

- Menus shown in this book are illustrations, not exact replications of the television's onscreen displays.

Onscreen Menus

The Onscreen Menu System

Your television comes with JVC's onscreen menu system. The onscreen menus let you make adjustments to your television's operation simply and quickly. All menus are navigated from the Main Menu at first. Detailed explanations on using each menu follow later in this guide. For information about the Interactive Plug-in Menu, see pages 21 - 23.

1. To open the onscreen menu system, press the MENU button on the remote control. The main menu will appear.

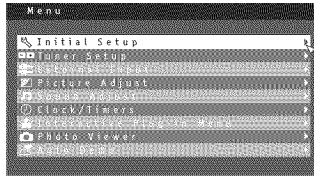

2. To select a menu from the main menu, use the ▲▼ arrows and enter by using the ◀▶ arrows or OK button.

The selected feature and option on a menu screen are highlighted in a different color. To move to a different feature, use the ▲▼ arrows to move up and down the list.

3. There are two methods to select an option in a menu, after selecting a menu using the ▲▼ arrows.

- 1) Use the ◀▶ arrows to select an option from the highlighted feature. (In this guide, we discuss this method).
- 2) Press the Ok button. The right onscreen will appear. Use the ▲▼ arrows to select an option from the box and press the Ok button.

- To go back to the previous screen, press the BACK button.

4. Pressing MENU on the remote control will close the onscreen menu system and return you to normal television viewing.

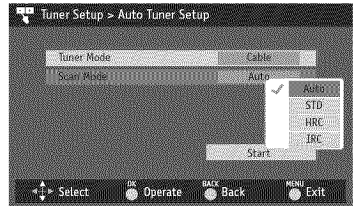

Each menu and its features will be discussed in the following pages of this guide.

Notes:

- If you do not press any buttons for a few seconds, the onscreen menu will automatically shut off.
- Button names in this guide are shown in SMALL CAPITAL LETTERS.
- Some menu items may not appear in menu screens when certain aspect ratios or inputs are selected.

Onscreen Menus

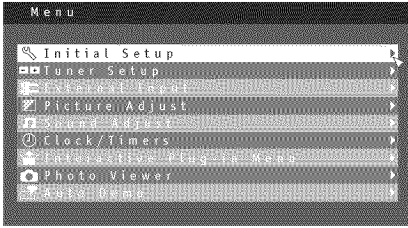

Press the MENU button

The left main menu will appear



To select a menu from the main menu
To enter

The following menu you selected will appear



Press the BACK button to return to the previous menu screen

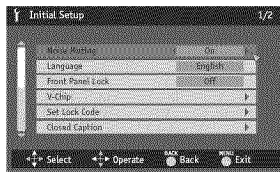
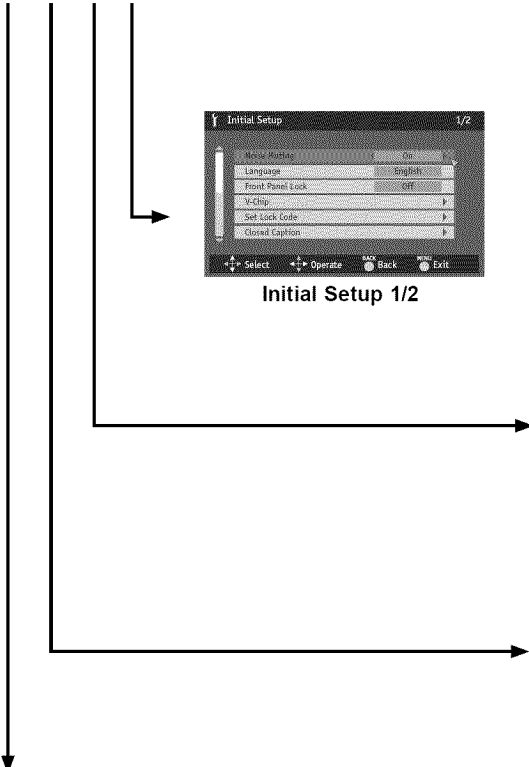

Initial Setup 1/2

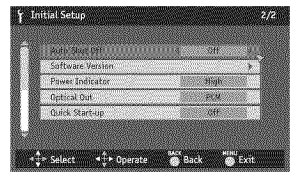

Initial Setup 2/2

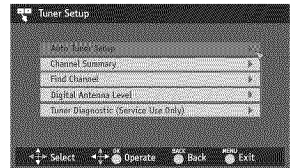

Tuner Setup

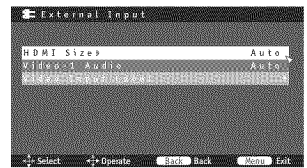

External Input

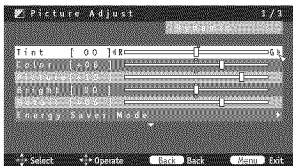

Picture Adjust 1/3



Picture Adjust 2/3



Picture Adjust 3/3

Note:

- The HDMI Size menu can only be displayed when a 480p picture signal is input to the HDMI terminal and the picture is being displayed on the screen.

Onscreen Menus

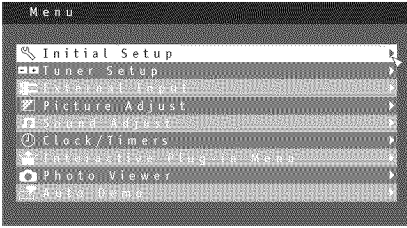

Press the MENU button

The left main menu will appear



To select a menu from the main menu
To enter

*The following menu you selected
will appear*



Press the BACK button to return to the
previous menu screen

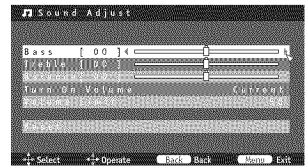
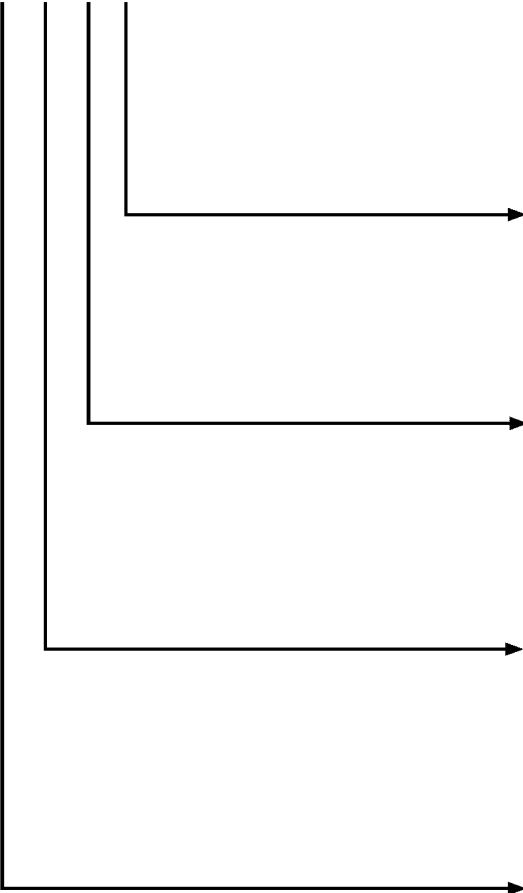

Sound Adjust

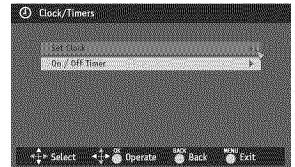

Clock/Timers

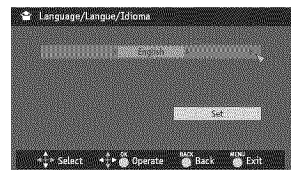

Interactive Plug-in Menu

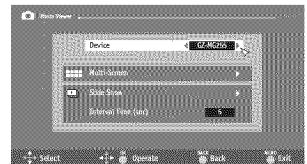

Photo Viewer

Note:

- For Auto Demo, see page 56.

Initial Setup

Noise Muting

This feature inserts a blank black screen over channels which are not broadcasting or are too weak to be received clearly.



Press the MENU button



To "Initial Setup"



To enter



To "Noise Muting"



To turn "On" or "Off"



Press the MENU button when finished

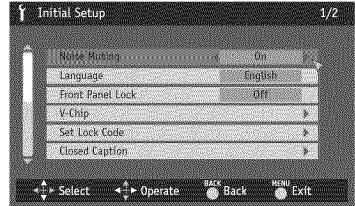

Note:

- Noise muting will not work when you operate channel summary.

Language

The language function is described on page 21 as the interactive plug-in menu. If you need to choose the language again, follow the steps below.



Press the MENU button



To "Initial Setup"



To enter



To "Language"



To choose a language: English, Français or Español



Press the MENU button when finished

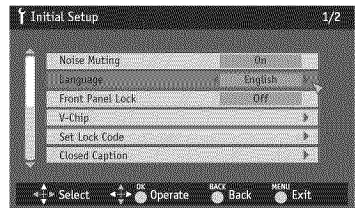

Front Panel Lock

This allows you to lock the keys on the side of the TV, so that a child may not accidentally change your viewing preferences.



Press the MENU button



To "Initial Setup"



To enter



To "Front Panel Lock"



To turn "On" or "Off"



Press the MENU button when finished

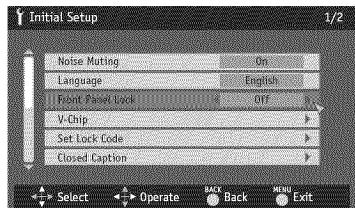

You can turn off this feature in the following ways:

- Unplug the power cord, and plug it back in. Do this if your batteries die, or you lose your remote control.
- Use the remote control.
- Press the MENU button on the side of the TV for more than 3 seconds. In this case, the OSD for "Front Panel Lock" will appear.

Note:

- To turn On/Off the TV, press the POWER button on the side of the TV for more than 3 seconds. This feature will remain On.

Initial Setup

V-Chip

Your TV is equipped with V-Chip technology which enables you to block channels or content that you feel to be inappropriate for children, based on US and Canada rating guidelines. V-Chip has no effect on video signals from a DVD discs, VCR tapes or Camcorder connection.

Note: Some programs, and movies are broadcast without a ratings signal. Even if you set up V-Chip ratings limits, these programs will not be blocked. See page 34 for information on how to block unrated programs.

Note (for Canadian viewers): The V-Chip function is based on specifications designed for the United States and therefore may not work properly in Canada.

You can customize the V-Chip settings of your television to match your personal tastes. The V-Chip menu below is the starting point for your V-Chip settings.

You can use US V-Chip settings (for programming broadcast from the United States), Canadian V-Chip settings (for programming broadcast from Canada), and movie ratings. You may use any or all of the settings (US V-Chip, Canada V-Chip, Movie ratings). Descriptions for setting each of the three V-Chip formats appear in the next six pages along with descriptions of the rating categories.

To access the rating categories:



Press the MENU button



To "Initial Setup"



To enter



To "V-Chip"



To operate (Password input screen will appear)



Enter the password by using the 10 keypad

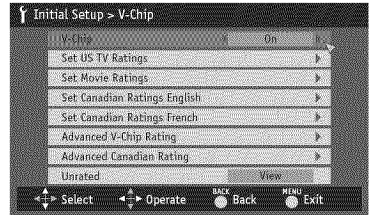

The V-Chip main screen will appear when the password is correct.



To turn V-Chip "On" or "Off" (V-Chip must be turned "On" for rating settings to operate)



To move to V-Chip menu (see following pages for descriptions of each item)

Notes:

- If you input the wrong password, go back to the Initial Setup Menu.
- To set the password, see "Set Lock Code", page 35.
- "Advanced V-Chip Rating" and "Advanced Canadian Rating" menus may be displayed sometimes between "Set Canadian Ratings French" and "Unrated". It depends on the broadcasting if they will be displayed or not.

Initial Setup

US V-Chip Ratings

U.S. PARENTAL RATING SYSTEMS

Programs with the following ratings are appropriate for children.

TV Y is Appropriate for All Children

Programs are created for very young viewers and should be suitable for all ages, including children ages 2 - 6.

TV Y7 is for Older Children

Most parents would find such programs suitable for children 7 and above. These programs may contain some mild fantasy violence or comedic violence, which children should be able to discern from reality.

Programs with the following ratings are designed for the entire audience.

TV G stands for General Audience

Most parents would find these programs suitable for all age groups. They contain little or no violence, no strong language, and little or no sexual dialog or situations.

TV PG Parental Guidance Suggested

May contain some, but not much, strong language, limited violence, and some suggestive sexual dialog or situations. It is recommended that parents watch these programs first, or with their children.

TV 14 Parents Strongly Cautioned

Programs contain some material that may be unsuitable for children under the age of 14 including possible intense violence, sexual situations, strong coarse language, or intensely suggestive dialog. Parents are cautioned against unattended viewing by children under 14.

TV MA Mature Audiences Only

These programs are specifically for adults and may be unsuitable for anyone under 17 years of age. TV MA programs may have extensive V, S, L, or D.

















Viewing Guidelines

In addition to the ratings categories explained above, information on specific kinds of content are also supplied with the V-Chip rating. These types of content may also be blocked. The content types are:

- **V/FV** is for VIOLENCE/FANTASY VIOLENCE
- **S** stands for SEXUAL CONTENT
- **L** stands for strong LANGUAGE
- **D** stands for suggestive DIALOG



Initial Setup

Setting US V-Chip Ratings

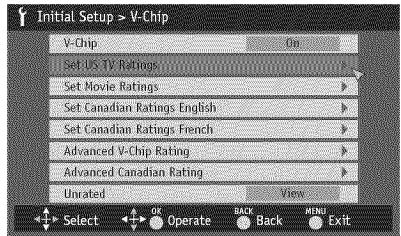



-  Press the MENU button
-   To "Initial Setup"
-   To enter
-   To "V-Chip"
-   To operate (Password input screen will appear)
-  Enter the password by using the 10 keypad
- The V-Chip main screen will appear*
-   To turn V-Chip "On" or "Off"
-   To move to "Set US TV Ratings"
-   To enter



Directions to set US V-Chip Ratings

Line up the cursor in the column (TV PG, TV G, etc.) with the content row (V/FV, S, etc.) and press the  or  to move the cursor to the correct location. Press Ok to turn the locking feature on or off. An item is locked if the  icon appears instead of a "—".

For example. To block viewing of all TV 14 shows, move the cursor to the top row of that column and add a lock icon. Once you've put a lock on the top row, everything in that column is automatically locked.

-    To the TV 14 Column
-  Press the Ok button to lock
-  Press the MENU button when finished

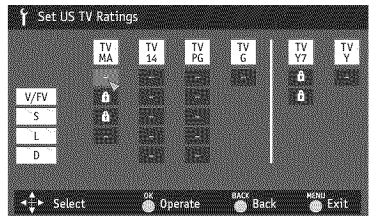

Initial Setup

Movies Ratings

❑ NR – Not Rated

This is a film which has no rating. In many cases these films were imported from countries which do not use the MPAA ratings system. Other NR films may be from amateur producers who didn't intend to have their film widely released.

NR (Not Rated) Programming may contain all types of programming including children's programming, foreign programs, or adult material.

❑ G – General Audience

In the opinion of the review board, these films contain nothing in the way of sexual content, violence, or language that would be unsuitable for audiences of any age.

❑ PG – Parental Guidance

Parental Guidance means the movie may contain some contents such as mild violence, some brief nudity, and strong language. The contents are not deemed intense.

❑ PG-13 – Parents Strongly Cautioned

Parents with children under 13 are cautioned that the content of movies with this rating may include more explicit sexual, language, and violence content than movies rated PG.

❑ R – Restricted

These films contain material that is explicit in nature and is not recommended for unsupervised children under the age of 17.

❑ NC-17 – No One Under 17

These movies contain content which most parents would feel is too adult for their children to view. Content can consist of strong language, nudity, violence, and suggestive or explicit subject matter.

❑ X – No One under 18

Inappropriate material for anyone under 18.

Directions to set Movie (MPAA) Ratings



Press the MENU button



To "Initial Setup"



To enter



To "V-Chip"



To operate (Password input screen will appear)



Enter the password by using the 10 keypad

The V-Chip main screen will appear



To turn V-Chip "On" or "Off"



To "Set Movie Ratings"



To enter movies menu

For example:

To block viewing of X and NC-17 rated from shows:



To the X Column



Press the Ok button to lock



To the NC-17 Column



Press the Ok button to lock



Press the MENU button to finish

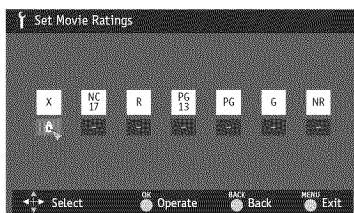

Canadian V-Chip Ratings

E – Exempt

Exempt programming includes: news, sports, documentaries and other information programming, talk shows, music videos, and variety programming.

C – Programming Intended for Children

Violence Guidelines: There will be no realistic scenes of violence. Depictions of aggressive behavior will be infrequent and limited to portrayals that are clearly imaginary, comedic or unrealistic in nature.

C8+ – Programming Intended for Children 8 and Over

Violence Guidelines: Any realistic depictions of violence will be infrequent, discreet, of low intensity and will show the consequences of the acts. There will be no offensive language, nudity or sexual content.

G – General Audience

Programming will contain little violence and will be sensitive to themes which could affect younger children.

PG – Parental Guidance

Programming intended for a general audience, but which may not be suitable for younger children. Parents may consider some content not appropriate for children aged 8-13.

14+ – 14 Years and Older

Parents are strongly cautioned to exercise discretion in permitting viewing by pre-teens and early teens. Programming may contain mature themes and scenes of intense violence.

18+ – Adult

Material intended for mature audiences only.

Directions to set Canadian V-Chip Ratings



Press the MENU button



To "Initial Setup"



To enter



To "V-Chip"



To operate (Password input screen will appear)



Enter the password by using the 10 keypad

The V-Chip main screen will appear



To turn V-Chip "On" or "Off"



To "Set Canadian Ratings English"



To enter ratings menu

For example:

To block viewing of programming rated 18+ and 14+:



To the 18+ Column



Press the Ok button to lock



To the 14+ Column



Press the Ok button to lock



Press the MENU button to finish

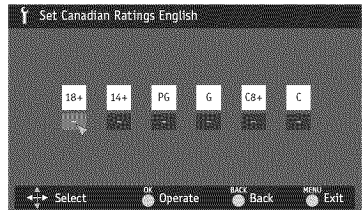

Note:

- For instructions on "Set Canadian Ratings French", please see page 33 in the French user's guide.

Initial Setup

Unrated Programs

Unrated programming refers to any programming which does not contain a rating signal. Programming on television stations which do not broadcast rating signals will be placed in the "Unrated Programming" category.

Examples of Unrated programs:

- Emergency Bulletins
- News
- Public Service Announcements
- Sports
- Some Commercials
- Locally Originated Programming
- Political Programs
- Religious Programs
- Weather

Note:

- TV programs or movies that do not have rating signals will be blocked if the unrated category is set to "Block".

Directions to Block Unrated Programs

You can block programs that are not rated.



Press the MENU button



To "Initial Setup"



To enter



To "V-Chip"



To operate (Password input screen will appear)



Enter the password by using the 10 keypad

The V-Chip main screen will appear



To turn V-Chip "On" or "Off"



To "Unrated"



To select "View" or "Block"



Press MENU when done



Initial Setup

Set Lock Code

Channel guard and V-Chip settings are protected by a four-digit lock code. Your TV comes pre-set with a lock code of "0000". You may change the code to any four-digit number you wish. To change the lock code, follow the steps below.



Press the MENU button



To "Initial Setup"



To enter



To "Set Lock Code"



To operate (Password input screen will appear)



Enter the password by using the 10 keypad

The Set Lock Code screen will appear



To set the password, use the 10 keypad



Press the Ok button to finish (your lock code is now set)

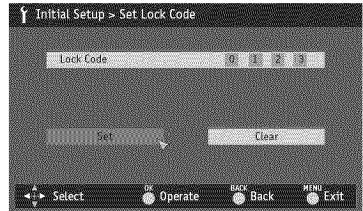

When a viewer attempts to watch a blocked channel, this message appears:

The channel will remain blocked until the correct lock code is entered (see above for information on setting your lock code).

This programming exceeds
your rating limits.
Please enter lock code
by 10 key pad to unlock it.
No. - - - -

Notes:

- After a power interruption you must reset the lock code.
- Write your lock code number down and keep it hidden from potential viewers.

Channel Guard Message

When a viewer attempts to watch a guarded channel, the following message appears:

To watch a channel that you have locked, enter the Lock Code using the 10 key pad.

If the wrong code is entered, the message "Invalid Lock Code !" will appear on the screen.

The channel cannot be accessed until the correct code is entered.

This channel is locked
by channel guard.
Please enter lock code
by 10 key pad to unlock it.
No. - - - -

Notes:

- Once a channel has been unlocked, it will remain unlocked until the television is turned off.
- See also "Set Lock Code".

Initial Setup

Closed Caption

Many broadcasts now include an onscreen display of dialog called closed captions. Some broadcasts may also include displays of additional information in text form. Your television can access and display this information using the closed caption feature. To activate the closed caption feature, follow the steps below.

Auto Setting



Press the MENU button



To "Initial Setup"



To enter



To "Closed Caption"



To enter



To "Type"



To select Auto, Advanced or Basic

Auto: Shows closed caption a priority for digital channels over analog channels. It is set automatically.

Advanced: Shows only the digital closed caption.

Basic: Shows only the analog closed caption.



To "Analog Service"



To select a caption (CC1 to CC4) or text channel (Text1 to Text4)



To "Digital Service"



To select 1, 2, 3, 4, 5 or 6



To "Appearance"



To enter



To select "Auto" ("Manual", see page 37)



Press the MENU button when finished

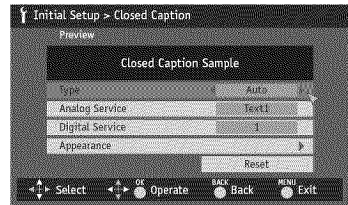

Notes:

- If you want to reset your settings to the default settings, select "Reset" and press the Ok button.
- If you select "Advanced" for Type, you cannot select "Analog Service".
- If you select "Basic" for Type, you cannot select "Digital Service" and "Appearance".
- "Type", "Digital Service" and "Appearance" are for digital broadcasting. It has no effect for analog broadcasting.

Initial Setup

Manual Setting

- ◀▶ To select "Manual" for Appearance Mode
- ▲▼ To "Font Size", "Font Style", "Text/Edge Opacity", "Background Opacity", "Text Color", "Edge Color" or "Background Color"
- ◀▶ To select the setting you like

Font Size: Auto, Standard, Large or Small

Font Style: Auto, SerifMono, Serif, SanSerifMono, SanSerif, Casual, Cursive or Small Capital

Text/Edge Opacity, Background Opacity: Auto, Transparent, Translucent, Solid or Flashing

Text Color, Edge Color, Background Color: Auto, White, Black, Red, Green, Blue, Yellow, Magenta, or Cyan



Press the MENU button when finished

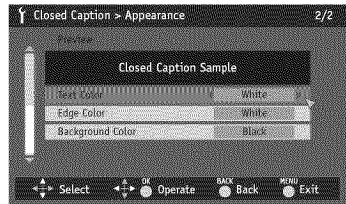
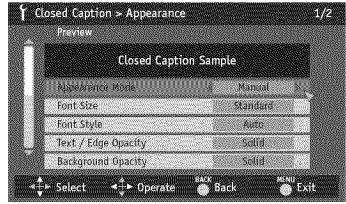

All fonts are licensed from Monotype Imaging Inc.

Notes:

- Closed caption subtitles are usually found on closed caption channel CC1. Some programs may include additional text information which is usually found on text channel Text1. The other channels are available for future use.
- Closed captioning may not work correctly if the signal being received is weak or if you are playing a video tape.
- Most broadcasts containing closed captioning will display a notice at the start of the program.
- To select the mode, press the C.C. button. See page 60.

Initial Setup

Auto Shut Off

This function automatically shuts off your TV when there is no signal from the channel and no operation if the TV is on for 10 minutes.



Press the MENU button



To "Initial Setup"



To enter



To "Auto Shut Off"



To turn "On" or "Off"



Press the MENU button when finished

- If the channel that you have on does not receive a signal for more than one minute, the blinking text "No Program or Weak Signal Auto shut off in 9 min." appears on the screen, and starts the countdown. If no signal is being received within 10 minutes, the TV shuts itself off.

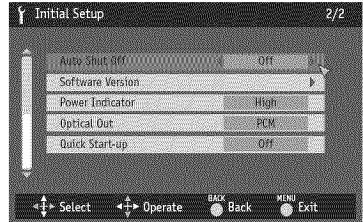

Software Version

You can confirm the Software Version.



Press the MENU button



To "Initial Setup"



To enter



To "Software Version"



To enter



Press the Ok button to close



Press the MENU button when finished

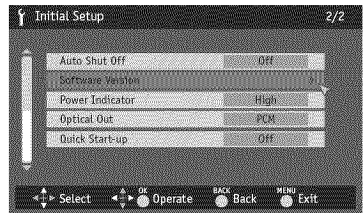

Power Indicator

Power indicator allows you to adjust the brightness of the power indicator.



Press the MENU button



To "Initial Setup"



To enter



To "Power Indicator"



To turn "High", "Low" or "Off"



Press the MENU button when finished

Notes :



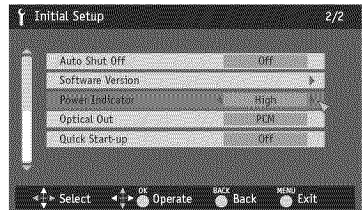



- When Off is selected :
 - The LED disappears if you have a TV signal.
 - The LED is lit as "Low" when there is no TV signal.
- When the On Timer turns On, the LED is lit as "Low" when you turn the power off.
- If you set a timer on the TV, the power indicator will light even if the TV is on stand by.



Initial Setup

Optical Out

You can select the optical digital sound output, either PCM or DOLBY DIGITAL when your TV is connected to an amplifier that has DOLBY DIGITAL decoder. If you select DOLBY DIGITAL, you can enjoy listening in 5.1ch sound when watching digital broadcasts. This only effects digital channels.

-  Press the MENU button
-  To "Initial Setup"
-  To enter
-  To "Optical Out"
-  To select "PCM" or "DOLBY DIGITAL"
-  Press the MENU button when finished

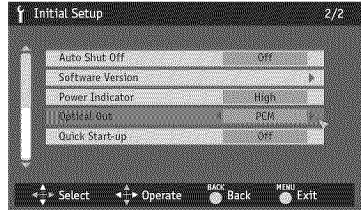

Notes:







- If your amplifier does not have DOLBY DIGITAL decoder, select PCM. If you don't select PCM, it cannot output the sound from the speakers.
- For connecting an amplifier using the optical output, see page 20.
- You cannot output sound from your Optical Output connection if the audio source is from your HDMI device.



Manufactured under license from Dolby Laboratories. "Dolby", and the double-D symbol are trademarks of Dolby Laboratories.

Quick Start-up

Quick Start-up allows you to lessen the time for the TV to turn on and ready for viewing.

-  Press the MENU button
-  To "Initial Setup"
-  To enter
-  To "Quick Start-up"
-  To turn "On" or "Off"
-  Press the MENU button when finished

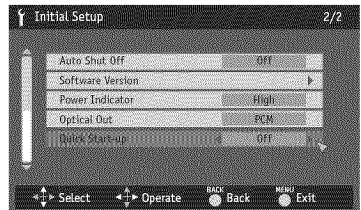

Note:

- Standby power consumption is higher when you have this feature turned on.

Tuner Setup

Auto Tuner Setup

The auto tuner setup function is described on page 23 as the interactive plug-in menu. If you need to run the auto tuner setup again, follow the steps below.



Press the MENU button



To "Tuner Setup"



To enter



To "Auto Tuner Setup"



To enter



To choose "Cable" or "Air"



To "Scan Mode"



To choose "Auto", "STD", "HRC" or "IRC"



To "Start"



Press the Ok button (Programming will take several minutes)

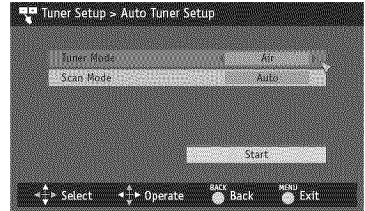

The auto tuner is finished when the message **"Programming Over !"** appears onscreen.

Notes:

- When the Tuner Mode is set to "Cable", it is possible to select "Scan Mode"
- If no channels were found using Auto Tuner Setup, check your antenna cable and the settings for Tuner Mode/Scan Mode.
- You can also access the "Front Menu" screen by using the MENU button on the side of the TV instead of the remote control. Choose "Auto Tuner Setup" by pressing MENU ▼ on the side panel and enter by using the CHANNEL +/- (◀▶) buttons.

Tuner Setup

Channel Summary

Channel summary allows you to customize the line-up of channels received by your TV. You can add or delete channels from the line-up or prevent any unauthorized viewers from watching any or all channels.



Press the MENU button



To "Tuner Setup"



To enter



To "Channel Summary"



To enter

A channel having the Scan mark "√" can be selected by using CH+/- (channel +/-) button. You can delete channels from the scan by removing the "√".



To the "Scan" column



Press the Ok button to include or delete from scan



Press the MENU button when finished

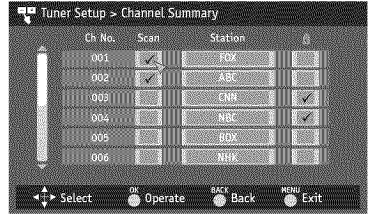

Note:

- The number of a digital channel may change, depending on the time of some broadcastings. If this channel existed and now has disappeared, the lock channel or scanned channel mark by the channel summary for that channel will be cancelled.

How to set the channel station.



Press the MENU button



To "Tuner Setup"



To enter



To "Channel Summary"



To enter



To "Station"



Press the Ok button to enter



To select the character you want



To move to the next space

...continue to follow these directions for all seven spaces



To "Set"



Press the Ok button

Your characters are now set



Press the MENU button when finished

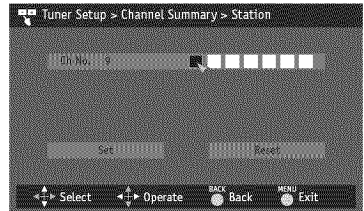

Tuner Setup

Channel Summary (Continued)

If you want to reset the characters you set:



Press the MENU button



To "Tuner Setup"



To enter



To "Channel Summary"



To enter



To "Station"



Press the Ok button to enter



To select "Reset"



Press the Ok button to finish

Your characters are now reset



Press the MENU button when finished

Notes:

- You can use characters for: Alphabet, numbers, marks and spaces.
- It is possible to set the maximum of 500 channel labels.
- If you try to set more than the 500 maximum, the message "Memory Overflow" will appear.

You can block access to a channel by activating the channel lock.



Press the MENU button



To "Tuner Setup"



To enter



To "Channel Summary"



To enter



To the Lock Column ()



Press the Ok button (Password input screen will appear)



Enter the password by using the 10 keypad



Press the Ok button to lock or unlock that channel



Press the MENU button when finished

Tuner Setup

Find Channel

Add a digital channel that does not exist in the channel map.



Press the MENU button



To "Tuner Setup"



To enter



To "Find Channel"



To enter



Add a channel using 0 to 9



Press the Ok button to finish

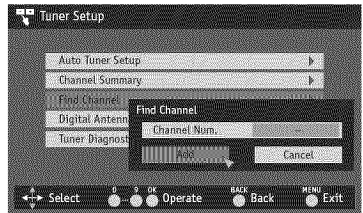

Digital Antenna Level

Confirms the present antenna level.



Press the MENU button



To "Tuner Setup"



To enter



To "Digital Antenna Level"



To enter

Note:

- If you are watching an analog channel, antenna level will not appear.

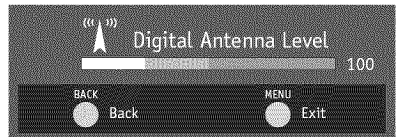

Tuner Diagnostic (Service Use Only)

Tuner Diagnostic menu is for service use only. It is used to diagnose your TV if there is a problem.



Press the MENU button



To "Tuner Setup"



To enter



To "Tuner Diagnostic (Service Use Only)"



To enter

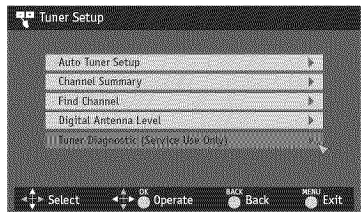

External Input

HDMI Size

The HDMI Size option can only be selected in the External Input menu when an HDMI 480p picture signal is being input to the HDMI terminal. This option adjusts the position when an HDMI or DVI 480p picture signal is being displayed on the screen. There are two types of HDMI 480p picture signals: 640x480 and 720x480. If the displayed picture is slightly shifted, the position can be adjusted by selecting Auto, Size 1 or Size 2.



Press the MENU button



To "External Input"



To enter



To "HDMI Size"



To enter



To select "Auto", "Size1" or "Size2"



Press the MENU button to finish

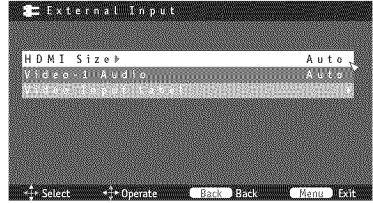

Notes:

- The HDMI Size menu can only be selected when an HDMI or DVI 480p picture signal is input to the HDMI terminal and the picture is being displayed on the screen.
- You can select "Auto" only when the signal is 480p for HDMI. When you select "Auto", the television will select "Size1" or "Size2" automatically.

Video-1 Audio

This feature is used if you have a DVI or HDMI compatible component connected to your TV.



Press the MENU button



To "External Input"



To enter



To "Video-1 Audio"



To select "Analog", "Digital" or "Auto"



Press the Menu button when finished

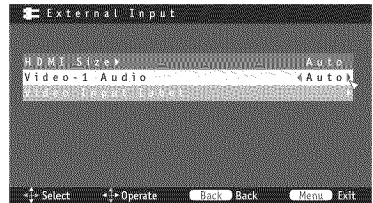

Notes:

- If your DVI or HDMI component is capable of digital audio and video, choose "Digital". If your DVI or HDMI component is capable of analog audio and digital video, choose "Analog".
- Refer to your DVI or HDMI component's instruction manual for more information.
- When you select "Auto", the television will select "Analog" or "Digital" automatically, depending on the audio input from the HDMI.

External Input

Video Input Label

This function is used to label video input connections for the onscreen displays.



Press the MENU button



To "External Input"



To enter



To "Video Input Label"



To enter



To select the desired video input



To select the desired preset input label (see chart below)



Press the MENU button when finished

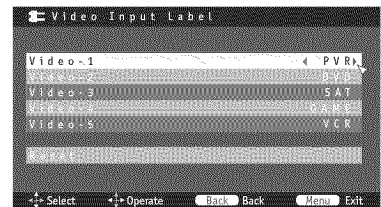
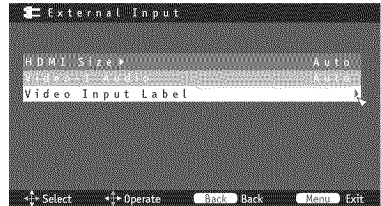

Preset Labels	Select when...
VCR	You have a VCR connected to the video input
DVD	You have a DVD connected to the video input
PVR	You have a Personal Video recorder connected to the video input
D-VHS	You have a Digital VCR connected to the video input
STB	You have a Set-top Box connected to the video input
SAT	You have a Satellite Receiver connected to the video input
AMP	You have an Amplifier connected to the video input
GAME	You have a Video Game connected to the video input
CAM	You have a Video Camera connected to the video input
DISC	You have a Video Disc player connected to the video input

Note:

- To reset to the default setting, ▲▼ to select "Reset", then press the Ok button.

Picture Adjust

Picture Settings

These settings allow you to change and adjust the way the picture appears on your television.

Tint

Tint allows you to adjust the levels of red and green in your TV picture.

Color

The color function lets you make all the colors in the TV picture appear either more vivid or subtle.

Picture

Picture allows you to adjust the levels of black and white on the TV screen, giving you a darker or brighter picture overall.

Bright

You can adjust the overall brightness of the TV picture with the Bright control.

Detail

The Detail feature adjusts the level of fine detail displayed in the picture.

Energy Saver Mode

The energy saver mode adjusts the level of back light brightness on the TV screen.

Adjust the Picture Settings



Press the MENU button



To "Picture Adjust"



To enter



To "Tint", "Color", "Picture", "Bright", "Detail" or "Energy Saver Mode"



To enter

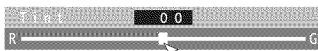

To adjust the setting



To move to the next setting



Press the MENU button when finished

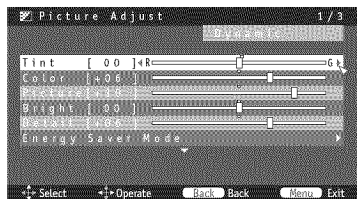

Color Temperature

You can decide how strong or dull the colors appear on the TV screen.



Press the MENU button



To "Picture Adjust"



To enter



To "Color Temperature"



To enter



To set "Low" or "High"



Press the MENU button when finished

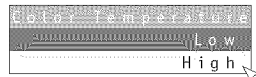

Note:

- If you are receiving a 1080i or 720p digital channel in its original format, you can adjust the Picture Settings and Color Temperature independently from all the other channels.

Picture Adjust

Color Management

This TV supports the Color Management function to ensure dull colors are compensated to produce natural hues.



Press the MENU button



To "Picture Adjust"



To enter



To "Color Management"



To enter



To set "On" or "Off"



Press the MENU button when finished

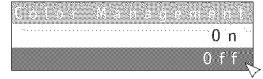

Dynamic Gamma

JVC's Dynamic Gamma Circuitry (DGC) makes it easier to see dark areas when a picture has many dark areas, and makes it easier to see the bright areas when a picture has many bright areas. DGC is turned on, DGC analyzes and adjusts the total level of picture brightness balance, especially in dark areas where the level of grayscale is often lost, turning completely to black DGC automatically enhances the detail in these dark areas providing a more dynamic image with finer detail, so the optimum picture settings are automatically set for each picture. Normally use with DGC on.



Press the MENU button



To "Picture Adjust"



To enter



To "Dynamic Gamma"



To enter



To set "On" or "Off"



Press the MENU button when finished



Smart Picture

Smart Picture detects the APL (Average Picture Level) and adjusts the contrast suitable for what you are watching.



Press the MENU button



To "Picture Adjust"



To enter



To "Smart Picture"



To enter



To set "On" or "Off"



Press the MENU button when finished



Note:

- When you have "Dynamic" selected in the "Video Status", Smart Picture is not selected.

Picture Adjust

Digital VNR

This function can be selected to change the effect of Digital VNR.



Press the MENU button



- To "Picture Adjust"
- To enter
- To "Digital VNR"
- To enter
- To select the effect you like.

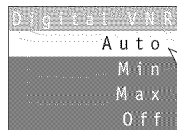

Auto: adjusts the effect of VNR automatically.

Min: adjusts the effect of VNR to minimum.

Max: adjusts the effect of VNR to maximum.

Off: turns the effect of VNR off.



Press the MENU button when finished

MPEG NR

This function blocks noise removal and mosquito NR simultaneously.



Press the MENU button



- To "Picture Adjust"
- To enter
- To "MPEG NR"
- To enter
- To select "On" or "Off"

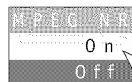

Press the MENU button when finished

Natural Cinema

Natural cinema corrects the problem of blurred edges which may occur when viewing a program originally shot on film (such as motion pictures) or animation. If you notice blurring at the edges of these programs, choose "Natural Cinema" and set it to "Auto". Natural Cinema helps correct conversion errors that occur when film, which is shot at 24 frames-per-second, is broadcast at the television rate of 30 frames-per-second.



Press the MENU button



- To "Picture Adjust"
- To enter
- To "Natural Cinema"
- To enter
- To select the mode "Auto" or "Off"



Press the MENU button when finished

Note:

- Natural Cinema is only applied for SD 480i and HD 1080i signals.

Picture Adjust

Position Adjustment

Position adjustment allows you to adjust the position of the picture.



Press the MENU button



To "Picture Adjust"



To enter



To "Position Adjustment"



To enter



To adjust the position



Press the MENU button to finish

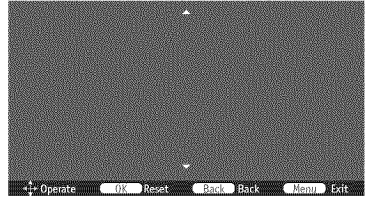

Notes:

- To reset the adjustment to the center, press the Ok button.
- When the arrow disappears, while you are adjusting the position, the position is at it's maximum limit.
- If you select Regular, Slim, Full or Full Native size with aspect, position adjustment option is not selectable.
- When you change the screen size, perform the position adjustment again.
- Position adjustment allows you to adjust the screen position horizontally when the aspect is set Panorama Zoom or Cinema Zoom for 1080i and 720p signals.
- When you are receiving a 1080p signal, Position Adjustment can not be selected.

Reset

Reset resets all picture adjustments at once to the default settings.



Press the MENU button



To "Picture Adjust"



To enter



To "Reset"



Press the Ok button

The onscreen menu disappears for a moment, and then the settings are reset to the default setting for all the picture adjustments except for Natural Cinema and Position Adjustment.



Press the MENU button when finished



Sound Adjust

Sound Settings

These settings allow you to change and adjust the sound on your television.

Bass – You can increase or decrease the level of low-frequency sound in the TV's audio with the bass adjustment.

Treble – Use treble to adjust the level of high-frequency sound in your TV's audio.

Balance – Adjust the level of sound between the TV's left and right speakers with the balance setting.

Adjust the Sound Settings



Press the MENU button



To "Sound Adjust"



To enter



To "Bass", "Treble" or "Balance"



To adjust the setting



To move to the next setting



Press the MENU button when finished

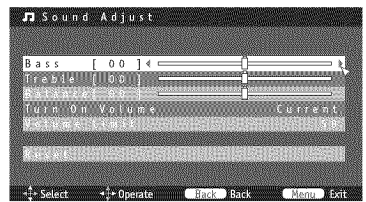

Note:

- You can reset all sound adjustments you set at once as the default setting when you select reset. See page 51.

Turn On Volume

Turn On Volume allows you to set the volume level when you turn the TV on.



Press the MENU button



To "Sound Adjust"



To enter



To "Turn On Volume"



To set the volume level

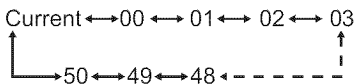

Press the MENU button to finish

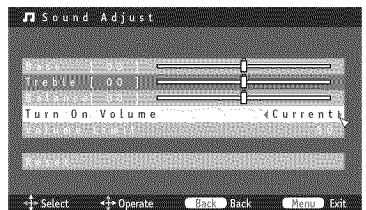

Sound Adjust

Volume Limit

Volume Limit allows you to set the maximum volume level.



Press the MENU button



To "Sound Adjust"



To enter



To "Volume Limit"



To set the maximum volume level

00 ↔ 01 ↔ 02 ← - - - - - → 48 ↔ 49 ↔ 50



Press the MENU button to finish

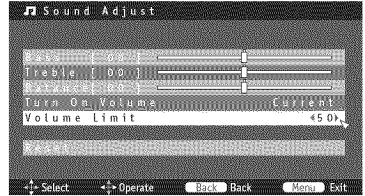

Reset

Reset resets all sound adjustments at once to the default settings.



Press the MENU button



To "Sound Adjust"



To enter



To "Reset"



Press the OK button

The onscreen menu disappears for a moment, and then the settings are reset to the default setting for all the sound adjustments.



Press the MENU button when finished

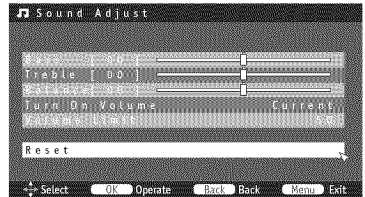

Clock/Timers

Set Clock

The set clock function is described on page 22 as the Interactive Plug-in Menu. You can choose to set the clock automatically, or manually. If you need to set the clock again, follow the steps below.



Press the MENU button



To "Clock/Timers"



To enter



To "Set Clock"



To enter

When you set the clock automatically, choose "Auto (Digital)" or "Auto (Analog)" by pressing the ◀ or ▶ arrows.



To "Channel" when you selected "Auto (Digital)"



To select a receiving digital channel



To "Time Zone"



To select your time zone



To "D.S.T." (daylight savings time)



To turn D.S.T. "On" or "Off"



To "Start Clock"



Press the OK button



Press the MENU button when finished

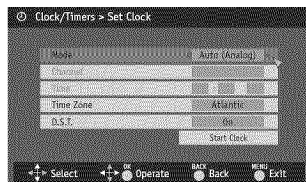

When you set the clock manually, choose "Manual" by pressing the ◀ or ▶ arrows.



To move to the hour



To set the hour



To move to minutes



To set the minutes



To "Time Zone"



To select your time zone:



To "D.S.T." (daylight savings time)



To turn D.S.T. "On" or "Off"



To "Start Clock"



Press the OK button

"Thank you !" will be displayed.



Press the MENU button when finished

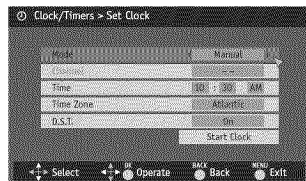

Notes:

- "Channel" can be selected only when Mode is "Auto (Digital)".
- D.S.T. can be used only for US and Canada when it is set to "On" in the "Set Clock" menu.
- Only when the Mode is set to Auto, the Daylight Saving Time feature automatically adjusts your TV's clock for Daylight Saving.
- The real time and D.S.T. may not be set correctly depending on the broadcasting signal and receiving conditions. In this case, set your clock manually.
- You will have to reset the clock after a power interruption. You must set the clock before operating any timer functions.

On/Off Timer

The on/off timer lets you program your television to turn itself on or off. You can use it as an alarm to wake up, to help you remember important programs, or as a decoy when you're not home.



Press the MENU button



To "Clock/Timers"



To enter



To "On/Off Timer"



To enter (begins with "Mode")



To choose "Once", "Everyday" or "No"



To "On Time"



To set the hour (AM/PM) you want the TV to turn on



To move to minutes



To set the minutes



To accept "On Time" and move to "Off Time" (the time the TV will turn off). Set the "Off Time" the same way as "On Time"



To accept "Off Time" and move to "Channel"



To select channel



To "On Volume"



To set the volume level



To "Set"



Press the Ok button



Press the MENU button to exit the menu



Notes:

- The on/off time cannot be set to locked channels in the channel summary menu.
- In order for the on/off timer to work, the clock must be set.
- After a power interruption, the timer settings must be reset.
- If your clock is not set, "Please set clock first !" will appear on the screen. Please see Manual Set Clock on page 52 to set the clock.

Photo Viewer

Photo Viewer allows you to enjoy your digital pictures stored on your USB Mass Storage Class devices. You are able to view them on this TV as high quality images.

How to start the Photo Viewer

- 1) Turn the power off on the device containing your photos.
- 2) Switch to "PHOTO" mode if your device has a mode switch (VIDEO/PHOTO).
- 3) Turn on your device containing your photos and switch to play mode to view the photos.
- 4) Connect your device to the Photo Viewer Terminal on this TV by using a USB cable.

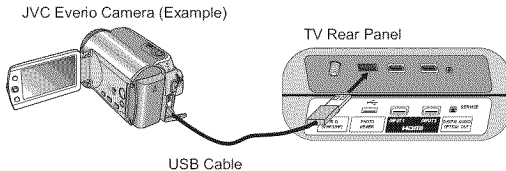

- 5) The TV screen will display a "hourglass" icon and then display the Photo Viewer Screen.
For "Multi Screen" and "Slide Show", see page 55 and 56.



- 6) Select a camcorder's device from "Device" by using the ◀▶ buttons.

How to finish the Photo Viewer



Press the MENU button when finished



Press the POWER button on remote control to turn the power off
Disconnect the USB cable

Notes:

- Use the supplied USB cable that came with your device. Do not use HUB or USB extension cable.
- Photo Viewer cannot be guaranteed to work with all USB Mass Storage Devices. In this case, the message, "There is no photo to be displayed" will appear when you start the "How to start the Photo Viewer". It may take some time to display or it may not display correctly.
- When your device that you are connecting to the TV is composed of two or more Mass Storage devices, you can select from two Mass Storage devices. Selected Mass Storage device depends on the model.
- Please refer to the Customer Support website at www.jvc.com/support for information and notes regarding your devices you wish to connect.
- Compatible file format is "Exif version 2.1, based on DCF version 1.0".
- Supported file formats are ".jpg" or ".JPG".
- Maximum number of files that can be displayed is 9999.
- Photos with less than 120 x 120 pixels and more than 16383 x 16383 pixels cannot be displayed.
- All your stored data should be backed up first as a precaution before connecting to the TV.
- Depending on your stored file size, it can take extra time to display "Photo Viewer" page.
- It may take extra time to display the photo full screen, depending on the file size.
- "Device" can only be selected when you have two or more devices connected to the TV.

Photo Viewer

Multi Screen

Multi Screen allows you to display JPEG images that are in your digital still camera or external USB Mass Storage Class memory as "thumbnails".

- ▲▼ To "Multi Screen"
- ◀▶ To enter

The thumbnail appears

- ◀▶▲▼ To select an image



Press Ok if you want to display a single image



Press the DISPLAY Button

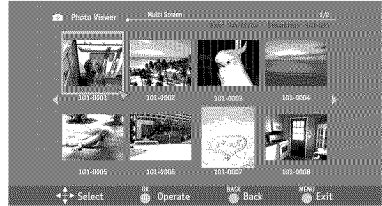

The following image appears. You can look at the pictures by using your remote control buttons.



- ▲ button: Zooms in the image

When the image is zoomed in, you can move the image in all directions using the 10-key pad on your remote. To reset the position, press the 5 button.

- ▼ button: Zooms out the image
- ◀ button: To previous image
- ▶ button: To next image

VOL+: Rotates the image 90° clockwise

VOL-: Rotates the image 90° counterclockwise

DISPLAY: Displays information. With each press of the DISPLAY button, you can display the picture's information.

BACK: Returns to the thumbnail screen

MENU: Exit

Notes:

- When Multi Screen has more than one screen, if you press the page number using the 10-key pad on your remote, you will skip to that specific page.
- Although the image has been rotated, this change is not saved to the USB memory.

Photo Viewer

Slide Show

Slide Show allows you to display the images in order.



To "Slide Show"



To enter

The Slide Show starts



Press the **BACK** button to stop the Slide Show

Notes:

- To pause the Slide Show, press the **OK** button. To unpause, press the **OK** button again.
- When you set the Interval Time (seconds), the image will change automatically to the next image. By default, it is 5 seconds.
- Slide Show may take extra time more than setting the Interval Time, depending on the file size.
- If the USB cable is disconnected or your USB device is turned off while the Photo Viewer is working, your device may not be recognized. In this case, turn Quick Start-up Off, turn the TV off and turn the TV back on.

Interval Time

You can set the time to change to the next image for the Slide Show. When you set the time using the **◀▶** button, the image change to the next image automatically. When you have set it to "Manual", you can change the image to the next image by using the **◀▶** buttons.

Note:

- It may take some extra time to move to the next image depending on the size of your JPEG images.

Auto Demo

Auto Demo

Auto Demo explains this TV's features to you. This Auto Demo mode is set to be On by default until you turn it Off.

Notes:

- Please complete the Interactive Plug-in Menu first. The Auto Demo mode will start automatically when the Interactive Plug-in Menu is completed.
- If you press any button on the television or remote, with the exception of **POWER** or **MENU**, the Auto Demo mode will stop for 30 seconds. After 30 seconds have passed with no operation, the Auto Demo mode will start again.

Button Functions

Power

Turns the TV on or off.



Press the **POWER** button

Number Buttons - 10Key Pad

Use the number buttons on the remote control to move directly to a specific channel. For example, to move to channel 12:



1 (ONE)



2 (TWO)

Tune

Lets you decide the input channel and select it. After you press the number buttons on the remote, press the **TUNE** button. For example, to move to channel 12:



1 (ONE)



2 (TWO)



Press the **TUNE** button

Input

Selects the signal input source for the television: VIDEO-1, 2, 3, 4 or 5 for video devices like VCRs, DVD players, or camcorders.



Press the **V1, V2, V3, V4 or V5** button

Notes:

- When you return to TV mode, press the **RETURN+/TV** button or direct 10 key pad or **CHANNEL +/-** button.
- You can also access by pressing the **INPUT** button on the side of the TV instead of the remote.

Channel +/-

Use these buttons to move up or down all the available channels your TV is able to receive. To move rapidly through the channels using JVC's **Hyperscan** feature, press and hold **CH+** or **CH-**.

Volume +/-

Use these buttons to raise or lower the TV's volume level. The maximum is the level you set in Volume Limit. See page 51.

Button Functions

Return +/TV

The Return+/TV button has three functions:

Return - Returns to the channel viewed just before the channel currently onscreen.

Return+ - Lets you program a specific channel to return to while scanning through the channels using the CH+ and CH- buttons.

TV - Returns to the TV mode.



Press the RETURN+/TV and hold for three seconds

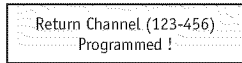

The channel currently active has been programmed as your return+ channel. Now scan through the channels using the CHANNEL+/- buttons.



Press the RETURN+/TV

You will return to your programmed channel.

- To cancel your return+ channel, press and hold the RETURN+/TV button for three seconds. The message "Return Channel Cancelled !" will appear.

Sound

By pressing the SOUND button, you can change the A.H.S. (Advanced Hyper Surround) and Smart Sound on or off.

A.H.S. - Adds a more spacious surround sound. Music gives basic effect and movie for more effect.

Smart Sound - Decreases high sound levels, giving a regulated sound level.



Press the SOUND button



To select "A.H.S." or "Smart Sound"



To choose the setting



Press the MENU when finished

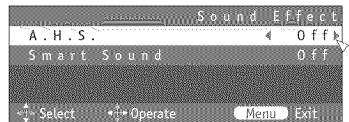

Note:

- Smart Sound may become an unnatural effect, depending on the signal source.

Muting

The MUTING button instantly turns the volume down completely when you press it. Press MUTING and the volume level will instantly go to zero. To restore the volume to its previous level, press MUTING again.

Button Functions

Video Status

The Video Status button gives you a choice of four TV picture display settings, including a display of your own preferences.

Standard - Resets the picture display to the factory settings.

Dynamic - Gives a vivid picture with better contrast when viewing in a brightly lit room.

Theater - Gives a rich, film-like look to video when viewing in a dimly lit room.

Game - Used for when you are playing video games connected to your TV.



Press the VIDEO STATUS button

By every press of the VIDEO STATUS button, you change the mode.

Notes:

- You can also change the mode by pressing the ▲▼ buttons.
- Each mode is memorized for each input connected to the TV.
- You can also access the "Front Menu" screen by using the MENU button on the side of the TV instead of the remote control. Choose "Video Status" by pressing MENU ▼ on the side panel and enter by using the CHANNEL +/- (◀▶) buttons. Next, select a mode by pressing the MENU ▼ button.

Sleep Timer

The Sleep Timer can turn the TV off for you after you fall asleep. Program it to work for a total time of up to 180 minutes. When you press the SLEEP button once, the rest of the time will be displayed.



Press the MODE button to select TV



Press the SLEEP button twice

By every press of the SLEEP button, you select the time for the timer to shut off

This message will appear 60 seconds before the automatic shutoff occurs:

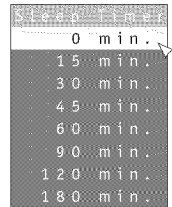
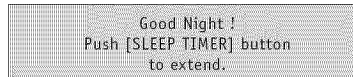

You then have 60 seconds to press the SLEEP button to delay the shut off.

Note:

- You can also select the timer by pressing the ▲▼ buttons.

Button Functions

Display

The display screen shows the current information as follows.



Press the **MODE** button to select TV



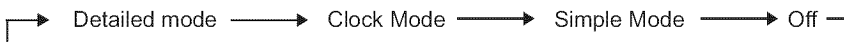

Press the **DISPLAY** button



- **Detailed Mode** - Shows the channel, channel name, signal, rating information, current time, digital antenna level and scramble information, as well as the current time below.



- **Clock Mode** - Shows the current time. 
- **Simple Mode** - Shows the current channel and channel name or AV input. 
- **Off** - Turns the display off.

Notes:

- You may also turn off the display at any step by pressing **MENU**.
- If the clock is not set, "Clock not set" will be displayed.
- A signal being shown in Detailed Mode, will only show the kind of input and video signal you are receiving. However, the actual signal type you see will be different.

C.C. (Closed Caption)

Use the C.C. (Closed Caption) button to select the mode of closed caption.



Press the **MODE** button to select TV



Press the **C.C.** button

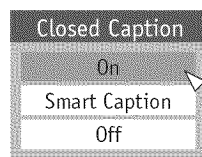

Notes:

- Smart Caption will appear when you press the Muting button only on channels where the broadcast contains closed captioning.
- When you select "On", it will be the mode selected in the Closed Caption Menu.
- See page 36 when you set the caption/text mode.
- You can also change the mode by pressing the **▲▼** buttons.

Button Functions

Aspect

This feature will help you adjust the picture you are watching to give you the best possible picture quality.

Aspect Ratios

Panorama - With this ratio a normal 4:3 aspect picture is stretched to fit the dimensions of the 16:9 aspect screen.

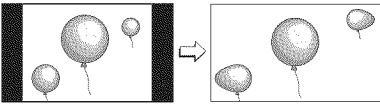

Cinema - This ratio "zooms in" on the center part of a 4:3 aspect picture, blowing it up to fill the 16:9 screen.

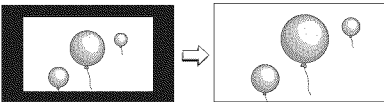

Full - This is the ratio to use when watching 16:9 High-Definition broadcasts.

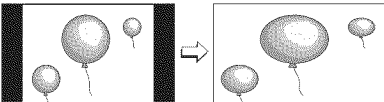

Panorama Zoom - This ratio stretches the High-Definition 16:9 aspect image to eliminate the black side bars.

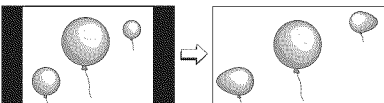

Cinema Zoom - This ratio stretches the High-Definition 16:9 aspect image to eliminate the black surrounding bars.

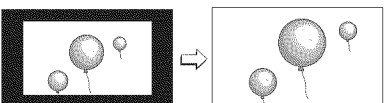

Regular - The regular ratio is used when you want to watch a 4:3 broadcast or recorded program without modifying the original picture to fit the dimensions of your 16:9 screen. The 4:3 picture will fill the screen from top to bottom, while black bars will appear to fill up the remaining space along the picture's sides. The 4:3 picture will be centered within the boundaries of the 16:9 screen.



Slim - This aspect mode shrinks the screen of 16:9 to 4:3. There are some programming that is already stretched by mistake at broadcasting companies, so this mode corrects it. Black side bars will appear.

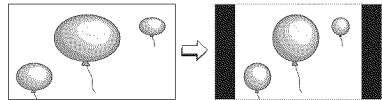

Full Native - This ratio displays 100% of the ratio. Normally, all aspects except for Full Native display about 95%.

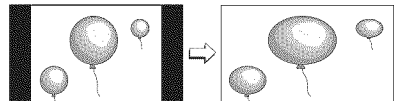

Button Functions

Aspect Ratios (Continued)



Press the ASPECT button

- By pressing the ASPECT button, you can change the size.

When you change the aspect ratios, it is different from their broadcast or recorded program.

ATSC (480i, 480p)
NTSC (480i, 480p)
SD (480i, 480p)

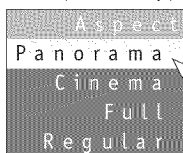

ATSC (720p)
HD (720p)

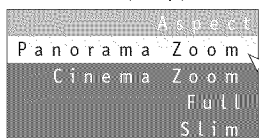

ATSC (1080i)
HD (1080i)

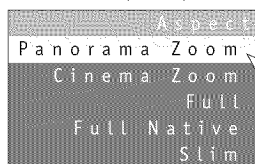

Notes:

- You can also choose the size by pressing the ▲▼ buttons.
- When you change the aspect ratio or signal, reset the picture position to center.
- You can also access the "Front Menu" screen by using the MENU button on the side of the TV instead of the remote control. Choose "Aspect" by pressing MENU ▼ on the side panel and enter by using the CHANNEL +/- (◀▶) buttons. Next, select an aspect ratio by pressing the MENU ▼ button.
- If the television receives a 16:9 signal from your HDMI device, the aspect mode will turn to "Full" automatically. If the television receives a 4:3 signal from your HDMI device when you are in "Full" aspect mode, it will return to "Regular" aspect mode. If you change the aspect mode after the television changed it to "Full" automatically, the television will change to the aspect mode you chose. It also turns to "Full" automatically when the TV receives an HD (1080i or 720p) signal.
- When you are receiving a 1080p signal in "Full Native" mode, you are unable to change the aspect mode.

Menu

The Menu button allows you to access JVC's onscreen menu system. Press MENU to activate the onscreen menu system. When a menu is displayed, press the MENU button to exit the menu system.

- See individual topics like "Sound Adjust" for specific information on using menus.

OK

This button confirms your selection when you are in one of the onscreen menus.

Back

This button allows you to go back in the menu to change a selection or correct a mistake.

Button Functions

ML/MTS

ML/MTS technology allows several audio signals to be broadcast in analog at once, giving you a choice in what you wish to hear with a TV program. In addition to mono or stereo sound, an MTS broadcast may also include a second audio program (SAP). When you are receiving a digital broadcast, it is possible to choose a language that you wish to receive.

When receiving analog broadcast



Press the **MODE** button to select TV



Press the **ML/MTS** button

By every press of the ML/MTS button, you change the mode

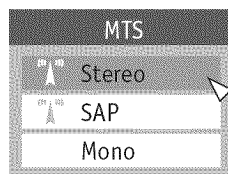

Notes:

- Keep the TV in stereo mode to get the best sound quality. The sound will work in stereo mode even if a certain broadcast is in mono sound only.
- Choose the mono setting to reduce excessive noise on a certain channel or broadcast.
- Selecting SAP will allow you to hear an alternative soundtrack, if one is available.
- MTS unavailable if your television's Input source is in Video-1, 2, 3, 4 or 5 mode, as described on page 57.
- You can also change the mode by pressing the **▲▼** buttons.

When receiving digital broadcast



Press the **MODE** button to select TV



Press the **ML/MTS** button

By every press of the ML/MTS button, you change the language



- ML/MTS will not work when you are using the HDMI.

Sub Channel

The main channel sometimes has minor channels (Sub Channels). By using the **SUB CH** button, you can select a sub channel easily.

To watch sub channels



Press the **MODE** button to select TV

For example, to move to sub channel 123-45:



Press 1, 2 and 3 in order



Press the **SUB CH** button



Press 4 and 5 in order



Press the **TUNE** button

Button Functions

Favorite

The Favorite button allows you to select your favorite channels easily. First, you must register the channels that you like. See how to register below.



Press the FAVORITE button
The favorite channel list will appear.



To select the channel you want to watch



Press the Ok button
It will change to the channel you have selected.

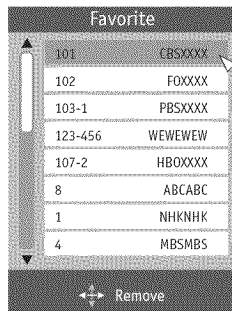

Register the favorite channel



Press the channel number you want to register
The channel program will change.



Press the FAVORITE button for three seconds
The channel will be registered in the favorite channel list.

Notes:

- The maximum number of channels you can register is 24.
- If you have registered the maximum number of channels, and try to register more channels, the oldest channel you registered will be deleted.

Delete the favorite channel



Press the FAVORITE button
The favorite channel list will appear.



To select the channel you want to delete



To enter
The screen to the right will appear.



To "Yes"



Press the Ok button
The channel was deleted.



Press the FAVORITE button when finished

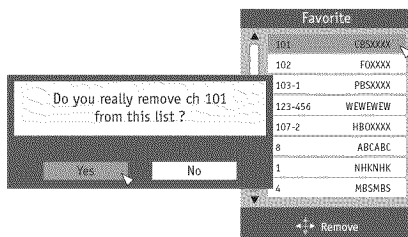

Guide

You can view the program information from the GUIDE.

Notes:

- The GUIDE function will work when you are receiving digital program only.
- The GUIDE will not show the correct time and date if you have not performed the set clock function on your television. See page 52.
- When the program information is not being broadcasted, it will not show the correct information.

Button Functions

Mode

Your remote control can be used to operate some basic functions of your external devices. To use your device, select the proper mode.

MODE	Device
TV	TV
STB	STB/DVR (Cable Satellite)
VCR	VCR/DVR
DVD	DVD Player (DVD Recorder)
AUDIO	Amplifier/Home Theater in Box



Press the MODE button

By every press of the Mode button, you can select the mode.

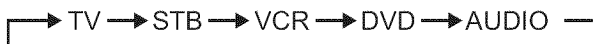

- The mode LED indicator on the remote control lights for 3 seconds each time the remote control is operated.

External device control buttons

You can use this remote control to operate the basic functions of your external devices. See page 66 on how to program the remote control to operate your other devices.

Note:

- The remote is preset to control JVC-brand devices.

Remote Programming

Remote programming

You can program your remote control to operate your external devices, using the instructions and codes on pages 67 - 71. The following external devices can be operated using your remote control.

Device	Mode	Applied for these functions	Page
Cable Set Top Box Cable/PVR Combination Satellite Set Top Box DBS/PVR Combination	STB	Power on/off, Channel up/down, Volume up/down, Number 0 - 9, Tune, Return+/TV, Muting, Favorite Channel, Menu on/off, Arrow buttons, OK/Enter, Back, DVR (JVC Only)*, Guide (EPG), Sub Channel, Closed Caption, Display (Recall), Rewind (◀), Playback (▶), Forward (▶▶), Record (●), Stop (■), Pause (⏸).	67
VCR, DBS/PVR Combination PVR, DVD/PVR Combination	VCR	Power on/off, Channel up/down, Menu on/off, Arrow buttons, OK/Enter, Back, Guide (EPG), TV/VCR, Closed Caption, Eject (▲), Rewind (◀), Playback (▶), Forward (▶▶), Record (●), Stop (■), Pause (⏸).	68, 69
DVD Player, DVD Recorder Home Theater in Box	DVD	Power on/off, Channel up/down, Menu on/off, Arrow buttons, OK/Enter, Back, Guide (EPG), TV/DVD (TV/VCR button), Sub Title (Sub T.), Open/Close (▲), Rewind (◀), Playback (▶), Forward (▶▶), Record (●), Stop (■), Still (■).	70
Amplifier, Home Theater in Box, Receiver	AUDIO	Power on/off, Audio Input Selection (V1 button), Volume up/down, Muting, DVD operation buttons: Menu on/off, Arrow buttons, OK/Enter, Back, Sub Title (Sub T.), Open/Close (▲), Rewind (◀), Playback (▶), Forward (▶▶), Stop (■), Still (■).	71

* DVR button only applies to JVC DVR (Dish Satellite STB).

Notes:

- To record to your VCR or DVD, hold the record (●) button on the remote control and press play (▶).
- If the code you programmed doesn't work, try the next one. If no codes work, refer to "Search Code Function" on page 66. If your remote does not work after using the "Search Code Function", use the remote that came with your device. Your TV remote can not be guaranteed to work with all models, brands or operations.
- When the television remote control does not operate, for a model that allows you to switch the remote control code on the device side, you can try switching the setting to default or something else on the device side.

How to set the codes

- 1) Find your device and device's brand from the code list. See page 67 - 71.
- 2) Select the mode of your device by pressing the MODE button. Then confirm the mode LED on the remote control.
- 3) Press and hold the TUNE button, then enter the first four digit code number listed using the number buttons. When the code is set, the mode LED goes out for a second, then it lights.
- 4) After confirming the proper mode LED, release the TUNE button, and confirm the operation of your device.
- 5) If your device does not respond, try and enter the next code.

Search Code Function

- 1) Select a mode of your device by pressing the MODE button.
- 2) Press the POWER and RETURN+/TV buttons. Hold for at least 3 seconds and release. Then confirm the mode LED blinks.
- 3) Press any button* on the remote, and see if the selected device responds. *Use the applied buttons except for ◀▶ cursors, Return+/TV and Rec (●) on the above chart.
- 4) If there was a response, press RETURN+/TV. The codes are now set. Then confirm the mode LED goes out.
- 5) If there was no response, try to select the previous code or the next code by using ◀ or ▶. If you repeat a total of 65 times for the STB (90 times for the VCR, 120 times for the DVD and 132 times for the AUDIO) without a response, use the remote control that came with your equipment. Press RETURN+/TV to exit. Then confirm the mode LED goes out.

Remote Programming

Programming Codes

STB mode

Cable Set Top Box		Satellite Set Top Box		Satellite Set Top Box	
ABC	0003, 0008	AlphaStar	0772	Samsung	1377, 1276, 1108, 1109, 1442, 1609
Americast	0899	Chaparral	0216	SKY	0856
Bell South	0899	Coolsat	1806	Sony	0639, 1639, 1640
Digeo	1187	Crossdigital	1109	Star Choice	0869
Director	0476	DirecTV	1377, 0392, 0566, 0639, 1639, 1142, 0247, 0749, 1749, 0724, 0819, 1856, 1076, 1108, 0099, 1109, 1414, 1442, 1609, 1392, 1640	Tivo	1142, 1442
General Instrument	0476, 0810, 0276, 0003			Toshiba	0749, 1749, 0790, 1285
GoldStar	0144			UltimateTV	1392, 1640
Hamiin	0009, 0273			Ultrasat	1806
Jerrold	0476, 0810, 0276, 0003			Uniden	0724, 0722
Memorex	0000	Dish Network System	1505, 1005, 0775, 1170, 1775	US Digital	1535
Motorola	1376, 0476, 0810, 0276, 1187	Dishpro	1505, 1005, 0775, 1775	USDTV	1535
Pace	1877, 0237, 0008	Echostar	1505, 1005, 0775, 1170, 1775	Voom	0869
Panasonic	0000, 0008, 0107	Expressvu	0775, 1775	Zenith	0856, 1856
Paragon	0000	GE	0566	DBS/PVR Combination	
Philips	1305, 0317, 0025	General Instrument	0869	DirecTV	1377, 0392, 0639, 1142, 1076, 0099, 1392, 1442, 1640
Pioneer	1877, 0877, 0144, 0533	GOI	0775, 1775	Dish Network System	1505, 0775
Pulsar	0000	Hisense	1535	Dishpro	1505, 0775
Quasar	0000	Hitachi	0819	Echostar	1505, 0775, 1170
Regal	0279, 0273	HTS	0775, 1775	Expressvu	0775
Runco	0000	Hughes Network Systems	1142, 0749, 1749, 1442	Hughes Network Systems	1142, 1442
Samsung	0000, 0144	Humax	1790	JVC	1170
Scientific Atlanta	1877, 0877, 0477, 0008	iLo	1535	Motorola	0869
Sony	1006	JVC	0775, 1170, 1775	Philips	1142, 0099, 1442
Starcom	0003	LG	1414	Proscan	0392
Supercable	0276	Magnavox	0724, 0722	RCA	1392
Torx	0003	Memorex	0724	Samsung	1442
Toshiba	0000	Mitsubishi	0749	Sony	0639, 1640
Zenith	0000, 0525, 0899	Motorola	0869	Star Choice	0869
Cable/PVR Combination		Next Level	0869		
Americast	0899	Panasonic	0247, 0701		
Digeo	1187	Pansat	1807		
General Instrument	0810	Paysat	0724		
Jerrold	0810	Philips	1142, 0749, 1749, 0724, 1076, 0722, 0099, 1442		
Motorola	1376, 0810, 1187	Proscan	0392, 0566		
Pace	1877, 0237	Proton	1535		
Pioneer	1877, 0877	RadioShack	0869		
Scientific Atlanta	1877, 0877	RCA	0566, 0855, 0143, 1392		
Sony	1006				
Supercable	0276				
Zenith	0899				

Remote Programming

VCR mode		
VCR	VCR	VCR
ABS 1972	Fisher 0047, 0104, 0046	Marta 0037
Admiral 0048, 0209	Fuji 0035, 0033	Matsushita 0035, 0162, 0227, 1162
Adventura 0000	Funai 0000, 0593, 1593	
Aiko 0278	Garrard 0000	Media Center PC 1972
Aiwa 0037, 0000, 0307, 0479	Gateway 1972	MEI 0035
Akai 0041, 0061, 0106	GE 0060, 0035, 0240, 0202, 0760, 0761, 0807, 1035, 1060	Memorex 0035, 0162, 0037, 0048, 0039, 0047, 0240, 0000, 0104, 0209, 0046, 0307, 0479, 1037, 1048, 1162, 1237, 1262
Alienware 1972		
America Action 0278	Go Video 0432, 0526	
American High 0035	GoldStar 0037, 0209, 0038, 0225, 1237	
Asha 0240		
Audiovox 0037, 0278	Gradiente 0000	MGA 0240, 0043, 0061
Beaumarck 0240	Harley Davidson 0000	MGN Technology 0240
Bell & Howell 0104	Harman/Kardon 0081, 0038	Microsoft 1972
Broksonic 0184, 0121, 0209, 0002, 0479, 1479	Harwood 0072	Mind 1972
	Headquarter 0046	Minolta 0042, 0105
Calix 0037	Hewlett Packard 1972	Mitsubishi 0081, 0067, 0043, 0041, 0061, 0173, 0807
Canon 0035	HI-Q 0047	
Capehart 0020	Hitachi 0037, 0240, 0000, 0042, 0041, 0105, 1037	Motorola 0035, 0048
Carver 0081		MTC 0240, 0000
CCE 0072, 0278		Multitech 0000, 0072
Citizen 0037, 0278, 1278	Howard Computers 1972	NEC 0035, 0037, 0048, 0104, 0067, 0041, 0038, 0008
Colt 0072	HP 1972	
Craig 0037, 0047, 0240, 0072, 0271	Hughes Network Systems 0042, 0739	
	Humax 0739	
Curtis Mathes 0060, 0035, 0162, 0041, 0760, 1035	Hush 1972	Nikko 0037
	IBUYPOWER 1972	Niveus Media 1972
Cyberbex 0240	Jensen 0041	Noblex 0240
CyberPower 1972	JVC 0045, 0067, 0041, 0008, 0366, 1707, 1945, 1774, 1775, 1776, 1777	Northgate 1972
Daewoo 0045, 0104, 0278, 0020, 0046, 0561, 1278	KEC 0037, 0278	Olympus 0035
Daytron 0020	Kenwood 0067, 0041, 0038	Optimus 1062, 0162, 0037, 0048, 0104, 0432, 0593, 1048, 1162, 1262
Dell 1972	KLH 0072	Orion 0184, 0121, 0209, 0002, 0208, 0479, 1479
Denon 0042	Kodak 0035, 0037	
DirecTV 0739	LG 0037, 0045, 0042, 0209, 0038, 1037	Panasonic 1062, 0035, 0162, 0225, 0227, 0616, 1035, 1162, 1262
Durabrand 0039, 0038		
Dynatech 0000	Linksys 1972	
Electrohome 0037	Lloyd's 0000, 0208	
Electroponic 0037	Logik 0240, 0072	Penney 0035, 0037, 0240, 0042, 0038, 1035, 1237
Emerex 0032	LXI 0037	
Emerson 0035, 0037, 0184, 0240, 0045, 0000, 0121, 0043, 0209, 0002, 0278, 1593, 1479, 1278, 0593, 0561, 0479, 0208, 0061	Magnasonic 0593, 1278	Pentax 0042, 0105
	Magnavox 0035, 0039, 0081, 0000, 0149, 0563, 0593, 1593, 1781	Philco 0035, 0000, 0038
	Magnin 0240	
	Marantz 0035, 0081	

Remote Programming

VCR mode					
VCR		VCR		PVR	
Philips	0035, 0081, 0000, 0563, 0593, 0618, 0739, 1081, 1181, 1266	Symphonic	0000, 0593, 1593	Howard Computers	1972
		Systemax	1972	HP	1972
		Tagar Systems	1972	Hughes Network Systems	0739
		Tatung	0081, 0045, 0000, 0067, 0041, 0008, 0366	Humax	0739
Pilot	0037		Hush	1972	
Pioneer	0081, 0042, 0067		IBUYPOWER	1972	
Polk Audio	0081	Teac	0000, 0041	JVC	1945
Portland	0020	Technics	0035, 0162	Linksys	1972
Presidian	1593	Teknika	0035, 0037, 0000	Media Center PC	1972
Proffrronic	0240	Thomas	0000	Microsoft	1972
Proscan	0060, 0202, 0760, 0761, 1060	Tivo	0618, 0636, 0739, 1996	Mind	1972
				Niveus Media	1972
Protec	0072	TMK	0240, 0208	Northgate	1972
Pulsar	0039	Toshiba	0081, 0045, 0042, 0067, 0043, 0041, 0008, 0057, 0366, 0845, 1008, 1145, 1972, 1996	Panasonic	0616, 1777
Quarter	0046		Philips	0618, 0739	
Quartz	0046		RCA	0880	
Quasar	0035, 0162, 1035, 1162			ReplayTV	0614, 0616
			Samsung	0739	
RadioShack	0000, 1037	Television	0037, 0240	Sonic Blue	0614, 0616
Radix	0037	Touch	1972	Sony	0636, 1972
Randex	0037	Unitech	0240	Stack 9	1972
RCA	0060, 0035, 0240, 0000, 0042, 0149, 0105, 0106, 0202, 0760, 0761, 0807, 0880, 1035, 1060	Vector	0045	Systemax	1972
		Vector Research	0038	Tagar Systems	1972
		Video Concepts	0045, 0061	Tivo	0618, 0636, 0739
		Videomagic	0037	Toshiba	1008, 1972, 1996
		Videosonic	0240	Touch	1972
Realistic	0035, 0037, 0048, 0047, 0000, 0104, 0046	Viewsonic	1972	Viewsonic	1972
		Villain	0000	Voodoo	1972
		Voodoo	1972	ZT Group	1972
ReplayTV	0614, 0616	Wards	0060, 0035, 0048, 0047, 0081, 0240, 0000, 0042, 0072, 0149, 0760		
Ricavision	1972	White Westinghouse	0209, 0072		
Runco	0039	XR-1000	0035, 0000, 0072		
Samsung	0240, 0045, 0432, 0739, 0760, 1014	Yamaha	0041, 0038		
		Zenith	0039, 0033, 0000, 0209, 0034, 0479, 1139, 1479		
Sanky	0048, 0039				
Sansui	0000, 0067, 0209, 0041, 0271, 0479, 1479	ZT Group	1972		
Sanyo	0047, 0240, 0104, 0046				
Scott	0184, 0045, 0121, 0043				
Sears	0035, 0037, 0047, 0000, 0042, 0104, 0046, 0057, 0105, 1237	DBS/PVR Combination			
		EchoStar	1945		
		Hughes Network Systems	0739		
		JVC	1945		
Sharp	0048, 0209, 0807, 0848, 1048	Philips	0739		
		Samsung	0739		
Shintom	0104, 0072				
Shogun	0240				
Singer	0045, 0072				
Sonic Blue	0614, 0616	ABS	1972		
Sony	0035, 0032, 0033, 0000, 0034, 0636, 0639, 0640, 1032, 1232, 1972	Alienware	1972		
		CyberPower	1972		
		Dell	1972		
		DirecTV	0739		
		Dish Network System	1945		
Stack 9	1972	EchoStar	1945		
STS	0042	Gateway	1972		
Sylvania	0035, 0081, 0000, 0043, 0593, 1593, 1781	Hewlett Packard	1972		

DVD/PVR Combination

Emerson 0000

Remote Programming

DVD mode

DVD		DVD		DVD Recorder	
Accurian	1416	Magnavox	0503, 0539, 0646,	Accurian	1416
Advent	1016		0675, 0821, 1268	Apex Digital	1056
Aiwa	0641	Marantz	0539	Aspire Digital	1168
Akai	0695, 0770, 0899	Memorex	0695, 0831, 1270	CyberHome	1129
Alco	0790	Microsoft	0522, 1708	Denon	0490
Allegro	0869	Mintek	0839, 0717	Funai	0675, 1334
Apex Digital	0672, 0717, 0755,	Mitsubishi	1521, 0521	Gateway	1158
	0830, 1056, 1061	NAD	0741	Go Video	0741, 1158, 1304,
Argo	1023	NEC	0785		1730
Aspire Digital	1168	Nesa	0717	iLo	1348
Audiovox	0790	NexxTech	1402	JVC	1164
Blaupunkt	0717	Norcent	1003, 1107	LG	0741
Blue Parade	0571	Onkyo	0503, 0627	LiteOn	1158, 1416, 1440
Broksonic	0695	Oritron	0651	Magnavox	0646, 0675
Cinea	0831	Panasonic	0490, 0703, 1362,	Panasonic	0490
Cine Vision	0876, 0833, 0869		1462, 1490, 1762	Philips	0646, 1158
Citizen	1277	Philips	0503, 0539, 0646,	Pioneer	0631
Coby	0778, 1107		0675, 0854, 1158,	RCA	0522
Craig	0831		1260, 1267, 1354	Samsung	0490, 1470
Curtis Mathes	1087	Pioneer	0525, 0571, 0631	Sensory Science	1158
CyberHome	0816, 0874, 1023,	Polaroid	1061	Sharp	0630, 0675
	1024, 1117, 1129	Polk Audio	0539	Sony	1033, 1431
Daewoo	0784, 0705, 0770,	Portland	0770	Sylvania	0675
	0833, 0869, 1169,	Presidian	0675	Zenith	0741
	1172	Prima	1016		
Denon	0490, 0634	Proscan	0522	Home Theater in Box	
Disney	0675, 1270	Pro Vision	0778	Aiwa	0641
Durabrand	1127	Qwestar	0651	Audiovox	0790
DVD2000	0521	RCA	0522, 0571, 0717,	JVC	1770, 1771, 1772,
Emerson	0591, 0675, 0821,		0790, 0822, 1022,		1773
	1268		1132	KLH	0790
Enterprise	0591	Rio	0869	Koss	0651
ESA	0821, 1268	Rotel	0623	Oritron	0651
Fisher	0670	Sampo	0752	Polk Audio	0539
Funai	0675, 1268, 1334	Samsung	0490, 0573, 0744,	RCA	0790
Gateway	1158		0820, 0899, 1044,	Rio	0869
GE	0522, 0815, 0717		1075, 1470	Sonic Blue	0869
Go Video	0744, 0715, 0741,	Sansui	0695	Teac	0790
	0783, 0833, 0869,	Sanyo	0670, 0695, 0873	Venturer	0790
	1044, 1075, 1099,	Sensory Science	1158		
	1158, 1304, 1730	Sharp	0630, 0675, 0752,		
GoldStar	0741		1256		
Greenhill	0717	Sharper Image	1117		
Harman/Kardon	0582, 0702	Sherwood	0770		
Hitachi	0573, 0664, 1247	Shinonic	0533, 0839		
Hiteker	0672	Sonic Blue	0869, 1099		
Humax	1500, 1588	Sony	0533, 1533, 0864,		
iLo	1348		1033, 1431, 1536		
Initial	0717	Superscan	0821		
Insignia	1268	Sylvania	0675, 0821, 1268		
Integra	0627	Symphonic	0675, 0821		
JBL	0702	Teac	0717, 0790		
Jensen	1016	Technics	0490, 0703		
JVC	0558, 0623, 0867,	Theta Digital	0571		
	1164, 1602, 1770,	Tivo	1503		
	1771, 1772, 1773	Toshiba	0503, 0695, 1045,		
Kawasaki	0790		1154, 1503, 1515,		
Kenwood	0490, 0534		1588		
KLH	0717, 0790, 1149	Urban Concepts	0503		
Koss	0651	US Logic	0839		
Lasonic	0798	Venturer	0790		
Lenoxx	1127	Xbox	0522, 1708		
LG	0591, 0741, 0869	Yamaha	0490, 0539, 0545		
LiteOn	1058, 1158, 1416,	Zenith	0503, 0591, 0741,		
	1440		0869		

OSD Information

Weak Signal

This OSD appears when the digital channel that you have selected is too weak to receive or no signal is being detected for that channel. It also appears when Noise Muting is On and no signal is being received from an external source.

No Program or Weak Signal

Audio / Data Only Channel

This OSD appears when the selected channel is not broadcasting any picture or sound, or is only broadcasting data information.

Audio / Data Only Channel

Troubleshooting

Refer to the table below to check the condition. If you think that there is a problem, contact the JVC Service Center where you purchased the television.

PROBLEMS	CHECK
There is no power	<ul style="list-style-type: none"> • See if the power cord became unplugged. • Check for a blown fuse or circuit breaker or a power outage.
There is no picture or sound	<ul style="list-style-type: none"> • The antenna could be disconnected. • The input mode could be set improperly. See page 57. • The tuner (Auto Tuner Setup) could be set improperly. See page 40. • The TV station may be having difficulties. Check to see if other stations are working. • Use the HDMI cable with HDMI logo HDMI. See page 19. • If you have a device connected to INPUT-1 or INPUT-2, you will not be able to hear any audio from the AUDIO OUT on the back of the TV. • You cannot output audio using the OPTICAL OUTPUT when you have digital sound from an HDMI device connected to the INPUT-1 or INPUT-2 connection on the back of your TV. (See page 18). • This TV can accept 480i (Composite / S / HDMI / Component), 480p, 720p and 1080i signals. Please check your settings.
Remote control is not operating properly or at all	<ul style="list-style-type: none"> • Check to see that the batteries are still working and properly installed. • Make sure the remote has a clear sight path to the TV. • You may be too far from the TV. You must be within 23 feet (7 meters).
You cannot select a certain channel	<ul style="list-style-type: none"> • Make sure the channels have been programmed. See "Channel Summary", page 41. • Check to see if the channel is locked. See "Channel Summary - Lock" page 42.
The power turns off by itself	<ul style="list-style-type: none"> • Make sure the set did not become unplugged. • Perhaps the On/Off Timer is set. See page 53. • Check to see if the Sleep Timer was set. See page 59.
It does not operate correctly	<ul style="list-style-type: none"> • This television is operated by a microprocessor. It is possible that external noise or interference is causing the problem. If the television does not function correctly, remove the electrical plug from the wall outlet and wait a while before inserting it into the wall outlet again and operating the television.
The clock is wrong	<ul style="list-style-type: none"> • The power was interrupted and the clock was not reset. See page 52.
The color quality is poor	<ul style="list-style-type: none"> • Tint and Color may be improperly adjusted. See page 46. • The Video Status mode may be turned to the wrong setting. See page 59.
There are lines across the picture	<ul style="list-style-type: none"> • There could be interference from another electrical appliance, such as a computer, another TV or VCR. Move any such appliances further away from the TV.
The picture is spotted	<ul style="list-style-type: none"> • There could be interference from a high-wattage appliance, like a hairdryer or vacuum, operating nearby. Move the antenna away from the appliance or change to a coaxial cable connection which is less prone to interference.
There are double pictures (ghosts)	<ul style="list-style-type: none"> • A building or passing airplane can reflect the original signal and produce a second, slightly delayed one. Adjust your antenna position.
Picture is snowy (image noise)	<ul style="list-style-type: none"> • Your antenna may be damaged, disconnected or turned. Check the antenna connection. If the antenna is damaged, replace it.
Screen is 80% black	<ul style="list-style-type: none"> • The Closed Caption Text mode is on. Turn it off in the Closed Caption Menu, page 36.
Stereo or bilingual programs can't be heard	<ul style="list-style-type: none"> • Make sure the MTS settings are correct. See page 63.

Troubleshooting

PROBLEMS	CHECK
Static electricity	• It is normal to feel static electricity if you brush or touch the screen.
You hear occasional crackling sounds	• It is normal for the TV to make crackling sounds when first turned on or off. Unless the sound or picture become abnormal, this is fine.
It does not operate correctly	• Press the CHANNEL- and VOLUME- buttons on the side panel of the TV simultaneously for a few seconds. The Digital Tuner will be reset. If this does not reset it correctly, unplug the power cord and plug it back in.

The following are not malfunctions.

- The television may make a creaking sound if the temperature of the room or the temperature of the inside of the television changes. If there is no problem with the screen or sound, then there is no need to worry.
- Although the picture may be temporarily disturbed and noise may be seen on the screen if the power is turned on immediately after it has been turned off, this is not a malfunction.

Specifications

Model	LT-37X688	LT-42X688
Type	LCD Flat Television	
Reception Format	NTSC, BTSC System (Multi-Channel Sound) ATSC Terrestrial, Digital Cable	
Reception Range	VHF 2 to 13, UHF 14 to 69 at ATSC, CATV 135 Sub, Mid, Super, Hyper and Ultra bands at Digital Cable	
	VHF 2 to 13, UHF 14 to 69 CATV 135 Sub, Mid, Super, Hyper and Ultra bands (191 channel frequency synthesizer system) at Analog • Reception of channel A-5 ("95" of the TV set's on-screen cable channel numbers) is not recommended for your TV set.	
Power Source	AC 120V, 60 Hz	
Power Consumption	210W	250W
Screen Size	37 inch / 94 cm measured diagonally, 16:9 ratio	42 inch / 106.7 cm measured diagonally, 16:9 ratio
Audio Output	10W + 10W	
Speakers	4 x 16cm Twin Oblique Cone x 2	
Antenna Terminal (VHF/UHF, ATSC/DIGITAL CABLE IN)	75 ohms (VHF/UHF)(F-type connector)	
Input 3, 4, 5 Terminal	480i S (Input 3) Y: 1 Vp-p positive, 75 ohms (negative sync provided) C: 0.286 Vp-p (burst signal), 75 ohms Video: 1 Vp-p, 75 ohms Audio: 500 mVrms (-4dBs) high impedance	
Input 3, 4 Terminal (Component Terminal)	1080i / 720p / 480p / 480i Y: 1 Vp-p positive, 75 ohms (negative sync provided) Pb/Pr: 0.7 Vp-p 75 ohms	
Input 1, 2 Terminal (HDMI Input Terminal)	Video: 1080p / 1080i / 720p / 480p / 480i Audio: 2ch PCM, 32 / 44.1 / 48 KHz 16 / 20 / 24 bit • Personal computer compatibility cannot be guaranteed.	
Audio Output Jacks (FIX)	FIX : 500mVrms (-4dBs), Low Impedance	
Optical Output Digital Audio	Digital Out (optical) x 1	
Dimensions (inch/cm) W X H X D	36 1/4 x 25 3/4 x 9 1/8 (with stand) 91.9 x 65.2 x 23 (with stand)	40 5/8 x 28 3/8 x 11 3/4 (with stand) 103 x 72 x 29.6 (with stand)
	36 1/4 x 23 7/8 x 4 3/8 (without stand) 91.9 x 60.4 x 10.8 (without stand)	40 5/8 x 26 1/2 x 4 3/8 (without stand) 103 x 67.2 x 10.8 (without stand)
Weight (lbs / kg)	42.9 / 19.5 (with stand)	57.2 / 26 (with stand)
	40.3 / 18.3 (without stand)	53 / 24.1 (without stand)
Accessories	Refer to "unpacking your TV", page 9	

Specifications subject to change without notice.

- The open source software is embedded in this product. For more information, please go to: http://software.jvc.com/opensource/lnx/DP/07_AtsqQam/download.html
- This product uses the software of the Independent JPEG Group.



LIMITED WARRANTY

COLOR TV 1-1

For Canadian model televisions, see separate sheets for Canadian Warranty information.

JVC COMPANY OF AMERICA (JVC) warrants this product and all parts thereof, except as set forth below ONLY TO THE ORIGINAL RETAIL PURCHASER to be FREE FROM DEFECTIVE MATERIALS AND WORKMANSHIP from the date of original purchase for the period shown below. ("The Warranty Period")
FOR DIRECT-VIEW COLOR TELEVISION, PICTURE TUBE is covered for Two(2)years.

Parts	1 YEAR	Labor	1 YEAR
-------	---------------	-------	---------------

THIS LIMITED WARRANTY IS VALID ONLY IN THE FIFTY (50) UNITED STATES, THE DISTRICT OF COLUMBIA AND IN THE COMMONWEALTH OF PUERTO RICO.

WHAT WE WILL DO:

If this product is found to be defective within the warranty period, JVC will repair or replace defective parts with new or rebuilt equivalents at no charge to the original owner. Such repair and replacement services shall be rendered by JVC during normal business hours at JVC authorized service centers. Parts used for replacement are warranted only for the remainder of the Warranty Period. All products may be brought to a JVC authorized service center on a carry-in basis. Color televisions with a screen size of 27" or greater qualify for in-home service. In such cases, a technician will come to your home and either repair the TV there or remove and return it if it cannot be repaired in your home.

WHAT YOU MUST DO FOR WARRANTY SERVICE:

Please do not return your product to the retailer
Instead, return your product to the JVC authorized service center nearest you. If shipping the product to the service center, please be sure to package it carefully, preferably in the original packaging, and include a brief description of the problem(s). Please call 1-800-252-5722 to locate the nearest JVC authorized service center. Service locations can also be obtained from our website <http://www.jvc.com>. If your product qualifies for in-home service, the service representative will require clear access to the product.

If you have any questions concerning your JVC Product, please contact our Customer Care Center at 800-252-5722

WHAT IS NOT COVERED:

- This limited warranty provided by JVC does not cover:
1. Products which have been subject to abuse, accident, alteration, modification, tampering, negligence, misuse, faulty installation, lack of reasonable care, or if repaired or serviced by anyone other than a service facility authorized by JVC to render such service, or if affixed to any attachment not provided with the products, or if the model or serial number has been altered, tampered with, defaced or removed;
 2. Initial installation, installation and removal from cabinets or mounting systems.
 3. Operational adjustments covered in the Owner's Manual, normal maintenance, video and audio head cleaning;
 4. Damage that occurs in shipment, due to act of God, and cosmetic damage;
 5. Signal reception problems and failures due to line power surge;
 6. Video Pick-up Tubes/CCD Image Sensors are covered for 90 days from the date of purchase;
 7. Accessories;
 8. Batteries (except that Rechargeable Batteries are covered for 90 days from the date of purchase);
 9. Products used for commercial purposes, including, but not limited to rental.

There are no express warranties except as listed above.

THE DURATION OF ANY IMPLIED WARRANTIES, INCLUDING THE IMPLIED WARRANTY OF MERCHANTABILITY, IS LIMITED TO THE DURATION OF THE EXPRESS WARRANTY HEREIN.

JVC SHALL NOT BE LIABLE FOR ANY LOSS OF USE OF THE PRODUCT, INCONVENIENCE, OR ANY OTHER DAMAGES, WHETHER DIRECT, INCIDENTAL OR CONSEQUENTIAL (INCLUDING, WITHOUT LIMITATION, DAMAGE TO TAPES, RECORDS OR DISCS) RESULTING FROM THE USE OF THIS PRODUCT, OR ARISING OUT OF ANY BREACH OF THIS WARRANTY. ALL EXPRESS AND IMPLIED WARRANTIES, INCLUDING THE WARRANTIES OF MERCHANTABILITY AND FITNESS FOR PARTICULAR PURPOSE, ARE LIMITED TO THE WARRANTY PERIOD SET FORTH ABOVE.

Some states do not allow the exclusion of incidental or consequential damages or limitations on how long an implied warranty lasts, so these limitations or exclusions may not apply to you. This warranty gives you specific legal rights and you may also have other rights which vary from state to state.

JVC COMPANY OF AMERICA
DIVISION OF JVC AMERICAS CORP. <http://www.jvc.com>

1700 Valley Road
Wayne, NJ 07470

REFURBISHED PRODUCTS CARRY A SEPARATE WARRANTY, THIS WARRANTY DOES NOT APPLY. FOR DETAIL OF REFURBISHED PRODUCT WARRANTY, PLEASE REFER TO THE REFURBISHED PRODUCT WARRANTY INFORMATION PACKAGED WITH EACH REFURBISHED PRODUCT.

For customer use:

Enter below the Model No. and Serial No. which is located either on the rear, bottom or side of the cabinet. Retain this information for future reference.

Model No. :	Serial No. :
Purchase date :	Name of dealer :

TO OUR VALUED CUSTOMER ———

THANK YOU FOR PURCHASING THIS JVC PRODUCT.
WE WANT TO HELP YOU ACHIEVE A PERFECT EXPERIENCE.

**NEED HELP ON HOW TO HOOK UP?
NEED ASSISTANCE ON HOW TO OPERATE?
NEED TO LOCATE A JVC SERVICE CENTER?
LIKE TO PURCHASE ACCESSORIES?**

JVC[®] IS HERE TO HELP!
TOLL FREE: 1(800)252-5722
<http://www.jvc.com>

Remember to retain your Bill of Sale for Warranty Service.

————— **Do not attempt to service the product yourself** —————

Caution

To prevent electrical shock, do not open the cabinet.
There are no user serviceable parts inside.
Please refer to qualified service personnel for repairs.

JVC COMPANY OF AMERICA
Division of JVC Americas Corp.
1700 Valley Road
Wayne, New Jersey, 07470



JVC CANADA, INC.
21 Finchdene Square
Scarborough, Ontario
Canada, M1X 1A7