

# JVC



LED TV/DVD Combo

## LT-22HD32J LT-22HD3WJ LT-24HD32J

INSTRUCTIONS

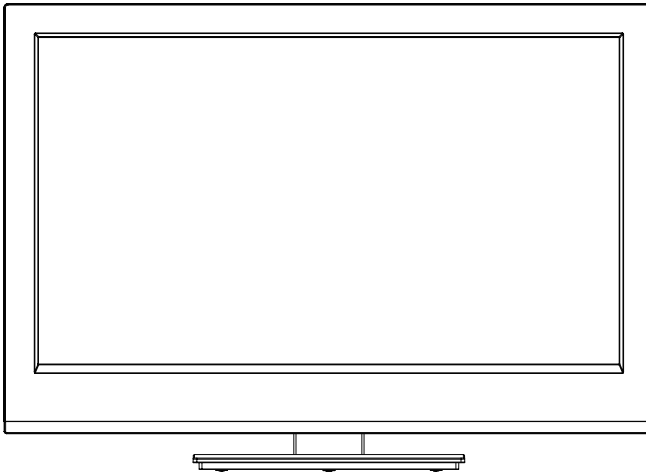

**HD**  
ready  
1080p

**DVB**  
Digital Video  
Broadcasting

**HDMI**<sup>®</sup>  
HIGH-DEFINITION MULTIMEDIA INTERFACE

**DVD**  
VIDEO

**COMPACT**  
**disc**  
DIGITAL AUDIO

**MP3**

**DOLBY**  
DIGITAL

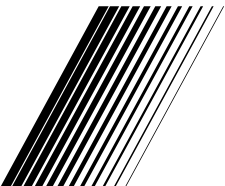

## Precautions

### Important Warning

**CAUTION:**

A UNIT IS A CLASS 1 LASER PRODUCT. HOWEVER THIS UNIT USES A VISIBLE LASER BEAM WHICH COULD CAUSE HAZARDOUS RADIATION EXPOSURE IF DIRECTED. BE SURE TO OPERATE THE PLAYER CORRECTLY AS INSTRUCTED.

**THE FOLLOWING CAUTION LABEL IS LOCATED ON THE REAR PANEL OF THE UNIT.**

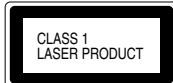

WHEN THIS UNIT IS PLUGGED INTO THE WALL OUTLET, DO NOT PLACE YOUR EYES CLOSE TO THE OPENINGS TO LOOK INTO THE INSIDE OF THIS UNIT.

USE OF CONTROLS OR ADJUSTMENTS OR PERFORMANCE OF PROCEDURES OTHER THAN THOSE SPECIFIED HEREIN MAY RESULT IN HAZARDOUS RADIATION EXPOSURE.

DO NOT OPEN COVERS AND DO NOT REPAIR YOURSELF. REFER SERVICING TO QUALIFIED PERSONNEL.

**WARNING:**

TO REDUCE THE RISK OF FIRE OR ELECTRIC SHOCK, DO NOT EXPOSE THIS EQUIPMENT TO RAIN OR MOISTURE.

TO REDUCE THE RISK OF FIRE OR ELECTRIC SHOCK, AND ANNOYING INTERFERENCE, USE THE RECOMMENDED ACCESSORIES ONLY.

**Battery notice (valid in EU only)**

Look after our environment - contact your local authorities for advice on how to safely dispose of exhausted batteries. The crossed out wheelee bin symbol indicates that used batteries should not be disposed of with your normal household waste! A separate collection system for used batteries is in place to allow the correct treatment and recycling in accordance with current legislation. Please contact your local authority for details on collection and recycling schemes in your area.

**DVB-C notice**

- The DVB-C reception possibly requires an additional contract with your cable supplier. A Smartcard for the receipt of encrypted programmes comes with the contract. Programmes that do not come with the contract will remain encrypted and not be viewed.
- You receive DVB-C programmes with a CA module (CAM) of your cable network operator. You insert the CAM into the CI-Slot (refer to page 10) of this TV set. You insert the Smartcard into the CAM.
- You can possibly receive a few unencrypted DVB-C programmes at your home location even without an additional contract and without a CAM. However, these programmes frequently reveal a poorer image quality than the DVB-C-HD programmes that are subject to a charge. The image quality that is frequently poor is a feature of the respective programmes.

**Information for the DVB-T function**

- Any function relative to the digital television (with the DVB logo) is available only within the country or area where such signals are transmitted. Verify with the salesman if it is possible to receive a DVB-T signal in the zone where you live.
- Remove the CAM for DVB-T reception, if it has been inserted.
- A DVB-T antenna must be connected for DVB-T reception.
- Even if the television conforms to the DVB-T specifications, the compatibility to future digital DVB-T transmissions is not guaranteed.
- Some digital television functions may not be available in some countries.
- The DVB-T system present in this device is FTA (Free to air).

Dear Customer,

**[European Union]**

This apparatus is in conformance with the valid European directives and standards regarding electromagnetic compatibility and electrical safety.

European representative of JVC KENWOOD Corporation is:

JVC Technical Services Europe GmbH Postfach 10 05 04

61145 Friedberg

Germany

## Features

### TV

- 16:9 LCD screen
- LED-Backlight-Technology
- On-Screen Language Display in 18 languages
- DVB-C-HDTV-Tuner
- DVB-T-Tuner
- Cable-analogue-Tuner
- Electronic Progr. Guide (EPG) for DVB

- USB-Media player for JPEG and WMA
- CI-Slot for CA- module
- Auto Power Off after 4 hours with no operation

### DVD Player

- Digital output for Dolby Digital and DTS
- Playback of DVD, MP3/WMA/JPEG and Audio-CD

### Information for Users on Disposal of Old Equipment and Batteries

#### [European Union]

These symbols indicate that the electrical and electronic equipment and the battery with this symbol should not be disposed of as general household waste at its end-of-life. Instead, the products should be handed over to the applicable collection points for the recycling of electrical and electronic equipment as well as batteries for proper treatment, recovery and recycling in accordance with your national legislation and the Directive 2002/96/EC and 2006/66/EC.

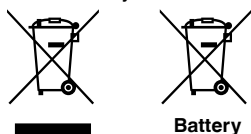

**Products**

**Battery**

**Notice :**  
The sign Pb below the symbol for batteries indicates that this battery contains lead.

By disposing of these products correctly, you will help to conserve natural resources and will help to prevent potential negative effects on the environment and human health which could otherwise be caused by inappropriate waste handling of these products.

For more information about collection points and recycling of these products, please contact your local municipal office, your household waste disposal service or the shop where you purchased the product.

Penalties may be applicable for incorrect disposal of this waste, in accordance with national legislation.

#### [Business users]

If you wish to dispose of this product, please confirm attached "KESA ELECTRICALS SAFETY INSTRUCTIONS" to obtain information about the take-back of the product.

#### [Other countries outside the European Union]

These symbols are only valid in the European Union.

If you wish to dispose of these items, please do so in accordance with applicable national legislation or other rules in your country for the treatment of old electrical and electronic equipment and batteries.

## Contents

Precautions.....	2
Features.....	3
Contents.....	3
Important safety information.....	4
Important Instruction.....	5
Location of controls.....	7
Remote Control.....	8
Antenna connection.....	10
Auto setup.....	11
Selecting the input source.....	11
On-screen Language Selection.....	12
Changing the order of stored channels.....	12
Station search.....	12
Update Scan.....	12
Manual Station search.....	13
Basic Operation.....	13
Teletext.....	14
Stereo reception in analogue cable TV channel mode.....	14
Remarks on DVB-T system.....	15
Password Setup (Parental lock).....	16
EPG (Electronic Program Guide).....	16
Picture size and resolution.....	17
Picture format.....	18
Other convenience functions.....	19
Media Operation.....	22
Media Browser.....	22
Playback files.....	23
Playable File Types.....	24
Disc.....	25
Playing a disc.....	27
Zooming (DVD).....	28
Locating desired scene (DVD/Audio CD).....	28
Changing Soundtrack Language (DVD).....	28
Subtitles (DVD).....	28
Changing angles (DVD).....	29
Title selection (DVD).....	29
DVD menu (DVD).....	29
Disc status.....	29
Using HOME MENU.....	29
Play mode.....	30
Audio Settings menu.....	31
Video Adjust menu.....	31
Customizing The Function Settings.....	31
Parental Control.....	33
Language Code List.....	34
Country/Area code list.....	34
PC connection.....	35
Connecting an HDMI or a DVI device to the HDMI input.....	35
Connection to other equipment.....	35
Troubleshooting table.....	37
License information.....	38
Specifications.....	39

## Important safety information

This unit has been produced according to all current safety regulations. The following safety tips should safeguard users against careless use and the dangers connected with such use.

- Although this appliance has been carefully manufactured and rigorously checked prior to leaving the factory, as with all electrical appliances it is possible for problems to develop. If you notice smoke, an excessive build-up of heat or any other unexpected phenomena, you should disconnect the plug from the mains power socket immediately.
- Ensure that the unit is sufficiently ventilated! Never place next to or underneath curtains!
- This set should be only be connected to an AC 220~240V / 50Hz mains power supply - do not attempt to connect it to any other type of supply.
- The socket-outlet must be installed near the equipment and easily accessible.
- Any repairs must be carried out by qualified service personnel only.
- Do not open this unit. A non-expert attempting to repair the unit could be dangerous and potentially cause a fire hazard.
- Keep away from rodents. Rodents (and also cockatiels) enjoy biting into electric flexes.
- The animal can cause a short cut (fire hazard!) and receive a fatal electric shock.
- Always hold plug when pulling out plug from power mains supply system. Do not pull on flex. The flex can become overloaded and cause a short cut.
- Never wet clean. Only use a damp cloth, the same as when cleaning furniture.
- Do not submerge in or under water!
- Set up unit so that no one is able to trip over the flex.
- This unit is recommended to be installed on shock-free benches in order to avoid any danger from falling.
- Take note that toddlers can pull the unit down from the table or cupboard by means of its flex. Children can hurt themselves when doing this.
- Do not use the unit near heat sources. The casing and flex could be damaged by the impact of heat.
- Watch out for kiddies copying what adults do! Do not stick any objects through the vents!
- The vents must remain open! No newspapers or covers should be put on the unit!
- The remote control is not a toy! Toddlers could swallow the batteries. If a battery has been swallowed, please seek out a doctor immediately.
- The screen is made of glass and can break if damage is done to it. Be careful when collecting sharp-edged glass splitters.
- You could be hurt or the unit could be damaged.
- If the unit is mounted on the wall, contact the shop where you purchased the unit for advice, and leave the installation work to experts. Incomplete installation work can cause you injuries.
- Taking fall-prevention measures
  - If these measures are not taken, the unit can fall and you could be injured.
  - Contact the shop where you purchased the unit to obtain full details of the measures.
- When a TV stand is used,
  - Ensure the unit is fully on the stand and placed in the centre.
  - Do not leave the stand doors open.
  - You could be hurt as a result of the unit falling or breaking, or your fingers being caught or jammed. Take extra precautions if you have children.
- Avoid placing the unit on any surfaces that may be subject to vibrations or shocks.
- To protect the unit during a thunder storm unplug the AC power cord and disconnect the antenna. Caution: Do not touch the antenna connector.
- When you leave your home for a long period of time, unplug the AC power cord for safety reasons.
- The unit becomes warm when in operation. Do not place any covers or blankets on the unit in order to prevent overheating. The ventilation holes are not to be blocked. Do not set up near radiators. Do not place in direct sunshine. When placing on a shelf leave 10 cm free space around the whole unit. Make some space around TV (Correct shelf assembly).
- The apparatus shall not be exposed to dripping or splashing and that no objects filled with liquids, such as vases, shall be placed on the apparatus.  
Liquids spilled into the unit can cause serious damage. Switch the set OFF and disconnect the mains power supply, then consult a qualified service person before attempting to use the unit again.

### **Please pay attention to the following instructions in order to avoid receiving a life-threatening electric shock:**

- Protect against moisture. Never use in the bath or sauna.
- Never use near a bath, shower or swimming pool.
- Never use the unit if it has got wet. This can also mean condensation moisture, which occurs in the winter when the cold unit is brought into a heated flat. Wait before operating the unit especially after it has been transported in the winter, until the cold unit has adjusted to the room temperature.
- Do not place any heavy objects on the flex. Electrical isolation could be damaged.
- Never wrap insulating tape around damaged flexes or on damaged plugs. These should be repaired or replaced by qualified service personnel.
- Never use this unit if the cabinet is defective. Do not make provisional repairs if the cabinet is damaged - this should be replaced by a new cabinet if necessary.
- Unplug the unit from the mains power supply prior to the cleaning of the unit.

## Important safety information

### How to attach the stand

#### NOTE:

- Unplug the AC cord from the AC INPUT terminal.
- Before performing work spread cushioning over the base area to lay the TV on.
- Do not support the TV by the screen as sharp objects and too much pressure may cause damage.
- Be sure to follow the instructions. Incorrect installation of the stand may result in the TV falling over.

- 1) Place the TV on its front onto a table.
- 2) Align the stand's base-plate (supplied) as seen here.  
It will fit in only one direction. Make sure the locating pegs project through the locating holes.
- 3) Carefully hold the base plate in position and secure it with screws (included).

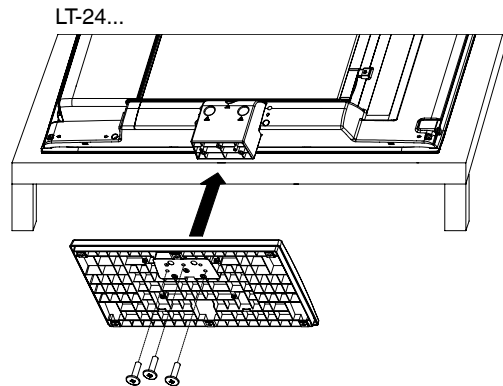
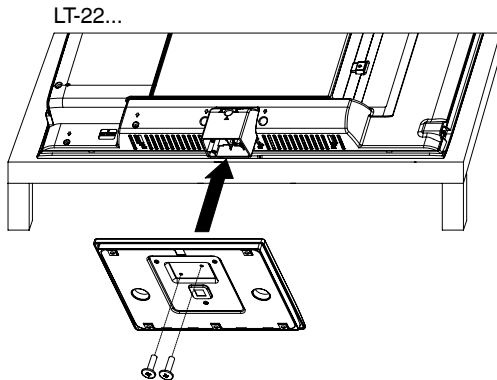

#### NOTE:

- To detach the base plate, perform these steps in reverse order.

### Dismantling the base

For wall mounting, the base plate must be dismantled. To do this, remove screws (M, see page 10) from the back. Take off the base plate entirely. Fit a VESA 100mm wall mounting kit.

## Important Instruction

For your own safety read following instruction carefully before attempting to connect this unit to the mains supply.

### MAINS (AC) OPERATION

The wires in the mains lead are coloured in accordance with the following code :

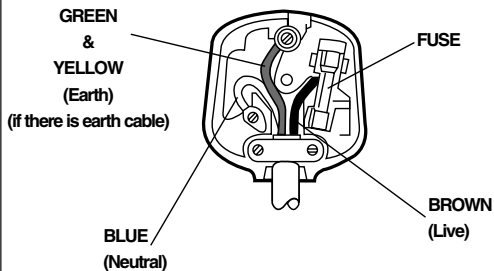

#### IMPORTANT

As the colours of the wires in the mains lead of this appliance may not correspond with the coloured markings identifying the terminals in your plug, proceed as follows:

The wire which is coloured green and yellow must be connected to the terminal which is marked with the letter E, or by the earth symbol, or coloured green or green and yellow.

The wire which is coloured blue or black must be connected to the terminal which is marked with the letter N or coloured Black.

The wire which is coloured brown or red must be connected to the terminal which is marked with the letter L or coloured Red.

For continued protection against risk of fire, replace only with same type and rating of fuse (ASTA approved 5A 250VAC fuse).

## Important safety information

**WARNING** To prevent fire, never place any type of candle or open flame on the top or near the TV set.



### Headphone Warning

Loud music can damage your hearing irreversibly, therefore do not set the volume to a high level when listening through headphones, particularly for extended listening periods.

### Moving the unit or carrying by hand

**When the unit is moved a long way, unplug the power cord and disconnect the antenna, connecting cables and any fall-prevention apparatus.**

- Moving without doing so could result in damage to the power cord, a fire, electric shocks or injuries from dropping the unit.

**Ensure that unpacking and transfer of the unit is carried out by two or more people and that the unit stays upright when doing this.**

**When the TV stand has casters, remove caster cups from the stand and push it while supporting the unit.**

- Ensure that you support the unit when the stand is pushed, as this can cause the unit to fall and you could be injured.
- The appliance could leave indentations in wooden tables with extremely soft wooden surfaces due to its heavy weight.
- Furniture polish could corrode and dissolve rubber feet. Black imprints could be visible on the table. You should therefore only use TV benches, which have been constructed for this specific purpose.

### Secure the casters when the unit is installed on a TV stand with casters.

- The stand can move and you could be hurt if the casters are not secured.  
Remove casters when the stand is placed on a soft surface such as a mat and carpet.

### The distance between eyes and the screen should be about 3 ~ 4 times as long as height of the screen.

- Viewing from too close a distance can cause strain for your eyes.

### When installing the Monitor on a table, be careful not to place the edge of its stand.

- This may cause the Monitor to fall, causing serious injury to a child or adult, and serious damage to the Monitor.

**Possible Adverse Effects on LCD Screen:** If a fixed (non-moving) pattern remains on the LCD screen for long periods of time, the image can become permanently engrained in the LCD TV panel and cause subtle but permanent ghost images. This type of damage is NOT COVERED BY YOUR WARRANTY. Never leave your TV on for long periods of time while it is displaying the following formats or images:

- Fixed Images, such as stock tickers, video game patterns, TV station logos, and websites.
- Special Formats that do not use the entire screen. For example, viewing letterbox style (16:9) media on a normal (4:3) display (Black bars at top and bottom of screen); or viewing normal style (4:3) media on a widescreen (16:9) display (Black bars on left and right sides of screen).

### Attention!

Cleaning instructions for your LCD TV.

### Safety note:

Before you start to clean, switch the set's power off completely and disconnect the plug from the mains power supply.

Be careful not to scratch the plastic coated front panel - it is highly vulnerable to accidental scratching (e.g. by fingernails or other sharp items). (While cleaning, do not wear jewelry) that could cause surface scratching (such as rings, wrist-watch, etc.). Use a lint-free cloth and pure water to clean with, but make sure the cloth is thoroughly wrung out so that it is just damp and not soaking wet - also make sure that the cloth is free from any dirt that could cause scratching to the surface.

Wipe the set clean using minimal pressure.

Do not use standard window cleaning fluid. Its alcohol / ammonia will dissolve the front window's coating.

Never use solvent or thinner. Never use special cleaners which are designed for cleaning PC Monitors or CRT TVs. Finally carefully rub dry with a clean dry lint-free cloth.

Do not use paper towels or tissues to clean the set - paper can disintegrate when wet or may leave a trail of dust behind. Some paper can also be abrasive and scratch your screen.

### Saving electricity

The high energy consumption during operation is reached only with maximal brightness of the display light. Maximal brightness is only necessary in a daylight environment in order to get a luminous and full of contrast picture. With less light in the environment, e.g. in the evening, the picture already can be too bright and might dazzle. The brightness of the display light can be reduced to the desired value in the menu Backlight (see p. 19). If the Backlight is set to a smaller value you can save up to 30 % of energy.

### Note:

- Maximal contrast values are reached only with a maximal setting (100) of Backlight.
- The biggest energy saving effect is reached with minimal setting of Backlight.

## Location of controls

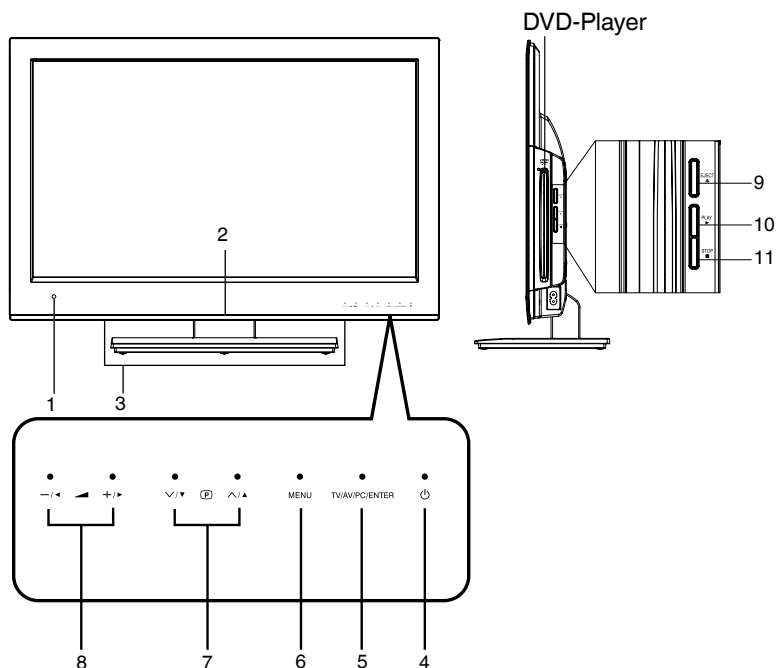

### Description of Indicators and Controls

- 1. Remote sensor**
- 2. Power indicator:** The power indicator lights up red in standby mode, and blue in power - ON mode.
- 3. Loudspeakers**
- 4. (Power)-button:** Preparation: Connect power-cable to AC220~240V/50Hz.  
Press power-button to enter standby mode or turn on the power.
- 5. TV/AV/PC/ENTER button:** Select input mode. In Menu : Using as **ENTER** button.
- 6. MENU button:** To display the menu screen.
- 7. (Channel) ^/∨/▲/▼ buttons:** Press ^ to change to a higher numbered channel set into memory.  
Press ∨ to change to a lower numbered channel set into memory. In Menu: Setting.
- 8. (Volume) +/-/◀/▶ buttons / In Menu: Setting.**
- 9. EJECT ▲ button:** Eject a disc.
- 10. PLAY ► button:** Playback of a disc.
- 11. STOP ■ button:** Stop of a disc.

For complete disconnection from the network, remove the supplied power cable from the socket.

## Remote Control

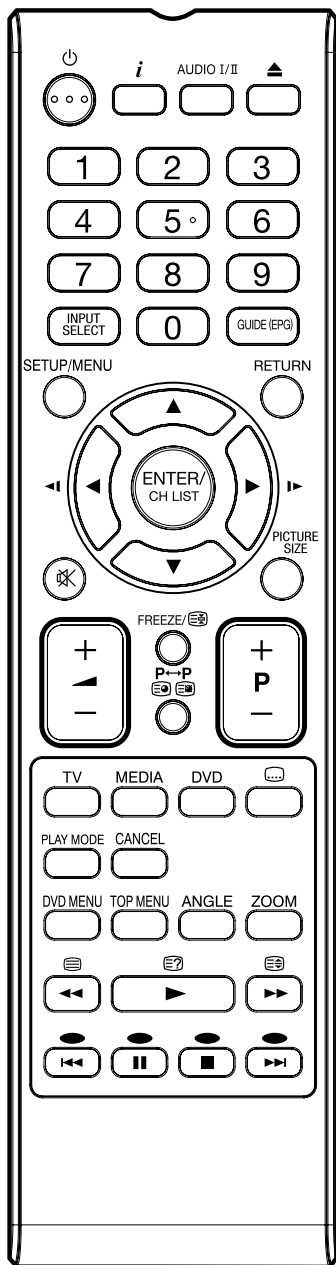

	Function	Page
	Enter standby mode or turn on the power	11
	Display program position number	13, 29
	Select between the available broadcast audio Change sound track language of DVD	14 28
	Eject a disc	27
	Select channel Select Teletext page Enter password Select title/chapter/track	13 14 16, 33 28, 29
	Select an input source	11
	Display the EPG (Electronic Progr. Guide)	16
	Activate the menu Call HOME MENU	11 29
	In menu, return 1 step / exit menu	29
	Cursor buttons	
	Memorize CH LIST	13
	Cursor buttons Reverse/Forward slow motion	28
	Turn the sound on/off	14
	Select picture format	18
	Volume	14
	Still picture Hold the text page	14 14
	Switches between the present channel and the last selected channel Sub page selection	14 14
	Change the TV channel or Teletext page up or down	13, 14
	Select to operate TV	
	To enter Media Browser	22
	Select to operate DVD	27
	Display the subtitle	13, 28
	Call Play Mode screen	30
	Cancel the Program Step	
	Select menu of a DVD disc	29
	Select title of a DVD disc	29
	Change playback angle of a DVD disc	29
	Zoom (for DVD/JPEG playback)	28
	Teletext ON / TV+Text / OFF	14
	Reveal quiz page answers	14
	Teletext enlargement	14
	Control buttons for USB/DVD - playback	23, 27
	Fasttext/TOPTtext buttons	14



## Remote Control

### Install the batteries

Use batteries type UM3 (AA-Size).

Do not use old or weak batteries. The remote control may not work properly with a weak voltage from such batteries. Replace exhausted batteries with new ones. Never try to recharge normal batteries - this could cause an explosion.

#### Note:

- Exhausted batteries can leak corrosive electrolyte, which may cause damage to the remote control - therefore remove exhausted batteries immediately.
- Batteries should not be exposed to excessive heat such as sunshine, fire or the like.

**1** Open the battery compartment.

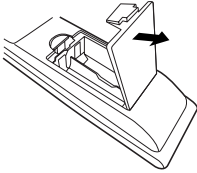

**2** Install the batteries as shown below, ensuring the correct polarity.

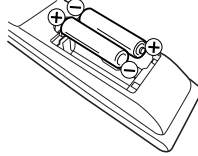

**3** Close the battery compartment.

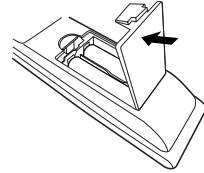

### Distance of Remote Control Operation

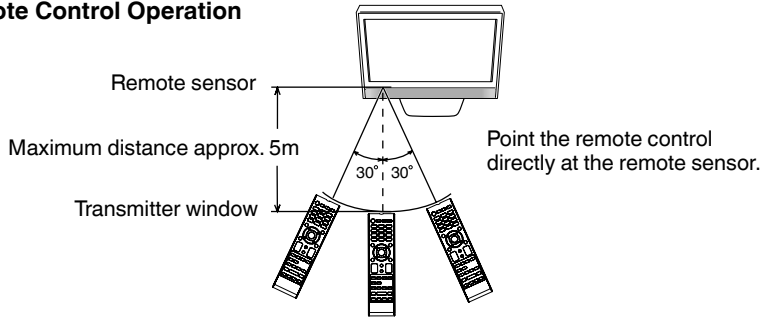

The remote control handset will not work properly in the following cases:

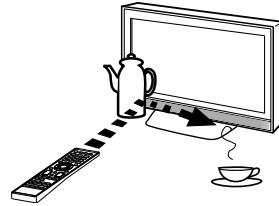
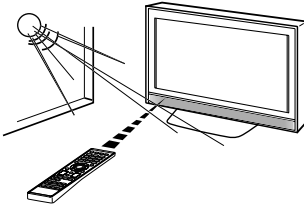

a) If bright sunlight directly beams onto the unit front. b) If an obstacle is placed between the unit and the handset.

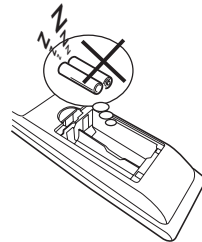
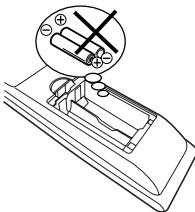

c) If the batteries have not been installed according to their polarities. d) If the batteries are weak.

## Antenna connection

**Note:** Before you connect other appliances:

- To avoid potentially damaging your set, make sure all items are switched off and disconnected from the mains power when you make the connections.
- Arrange the desired connection.
- When you have finished making the connections, reconnect the mains power to the unit and switch it back on.

Connect your antenna as shown below (A). Connections to other equipment is explained further on P.35~36. If you have problems with reception, consult a specialist of antenna.

### Back Side

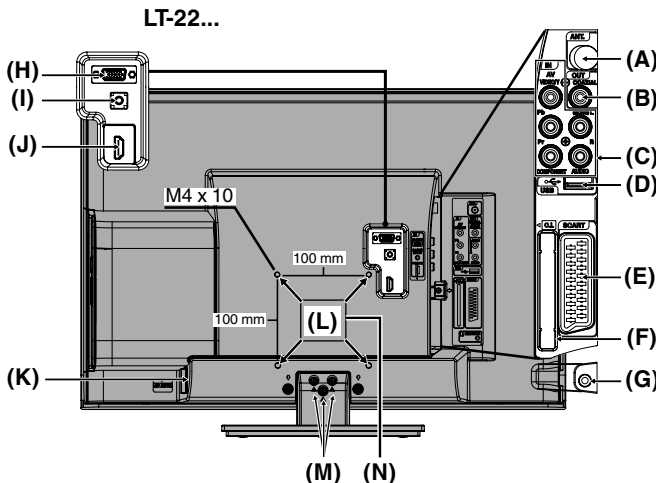

**(A) Antenna:** Connect an antenna. The built-in tuner receives all analogue cable programmes and DVB-T/-C channels.

**(B) DIGITAL AUDIO COAXIAL output:** digital audio output

**(C) AV/COMPONENT input:** Input for analogue AV-Signal/Component-Signal. See P.35, 36

**Note:** AV-AUDIO input is sharing with COMPONENT AUDIO input.

**(D) USB input:** See P.22-24.

**(E) Scart socket:** For the connection of scart cable. See P.36.

**(F) C.I. slot:** for CA- module (CAM) (if PayTV-provider supports this).

**Note:** To prevent malfunctions and damages, be sure to turn off the TV before inserting or removing the CAM card.

**(G) HEADPHONE jack:** Plug headphones with a mini plug (3.5 mm) into this jack.

**(H) PC-INPUT (PC):** See P.35.

**(I) PC/DVI AUDIO input:** See P.35.

**(J) HDMI/DVI input:** See P.35.

**(K) Power supply:** Connect the supplied power cable to an AC 220-240V/50Hz mains power supply only - do not attempt to connect it to any other type of supply. Never try to repair a damaged AC power cord with isolation-tape - this should be repaired by a specialist or replaced. Do not let your pet loose near the cable. Animals biting into the cable could receive a fatal electric shock, and could cause a hazard to others.

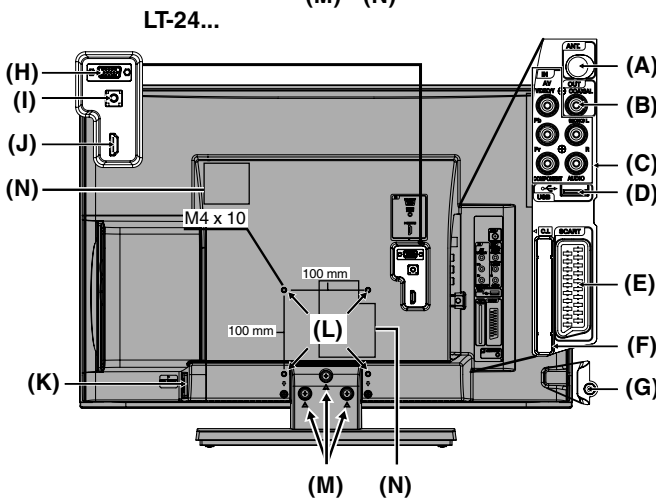

**(L) Bracket holes:** Fix a wall mounting bracket (not supplied) here.

**(M)** To hang the television on a wall, remove these screws and then remove the stand. Before performing work spread cushioning over an area to lay the TV on.

**(N) Service connector cover:** Please do not open this cover. There is a socket only for service purpose inside.

## Auto setup

The built-in tuner receives DVB-C, DVB-T and Cable-analogue. At the first time you operate after the purchase, "Auto Installation" menu will appear.

### Preparation:

Turn on TV-unit (see P.7) and connect antenna.

- 1 Auto Installation menu will appear. Press **▲** or **▼** to select desired language. Then press **ENTER**.

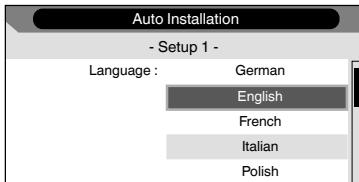

- 2 Press **▲** or **▼** to select your country. Then press **ENTER**.

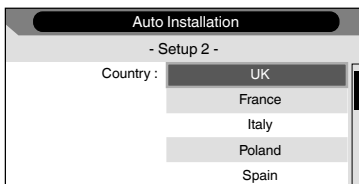

- 3 Press **▲** or **▼** to select Home. Then press **ENTER**.

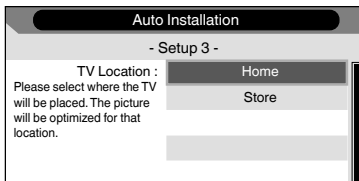

- 4 If you cancel Auto Power Off (see page 20), press **▲** or **▼** to select Off. Then press **ENTER**.

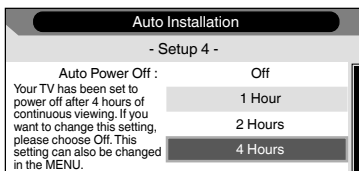

- 5 Press **▲** or **▼** to select Antenna or Cable, then press **ENTER**.

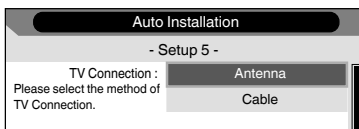

- 6 TV will search for Digital TV-channels at first. Connect your DVB-T antenna (or DVB-C antenna if you selected "Cable" at step 5) now. Continue with **ENTER** to start auto tuning. The tuning's progress will be displayed in percent for confirmation.

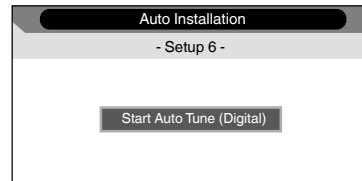

### Note:

- Please be patient - the Auto Tuning process can take several minutes to complete.

- 7 When the tuning for Digital TV-channels is completed, you will be asked if you want to proceed to autotuning for Analogue TV-channels. If you wish to start autotune Analogue TV-channels, connect your Analogue cable-TV antenna and press **ENTER**.

### Note:

- If you do not wish to carry out the autotuning for Analogue TV-channels, press **MENU** to exit the menu.

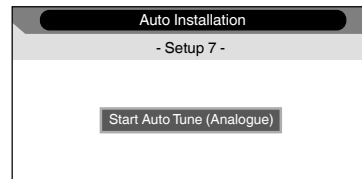

- 8 When the display reads 100%, normal TV-screen will appear.

### Note:

- To cancel the auto tuning, press **RETURN** during the process.

**THE AUTOMATIC TUNING PROCESS WILL ONLY START BY ITSELF THE FIRST TIME YOU SWITCH THE SET ON. HOWEVER YOU CAN RESTART THIS PROCESS VIA THE MENU SYSTEM (see page 12).**

- If you could not set up a correct pair of language and country in this auto setup process, you will be able to make your preferred language selection as illustrated in page 12 (On-screen Language Selection).

## Selecting the input source

Press **INPUT SELECT** to view a signal from another device connected to your TV, such as a VCR or DVD player. You can select each input source depending on which input jacks you used to connect your devices.

To select the video input source, press **INPUT SELECT** or **▲/▼**, then press **ENTER**.

### Note:

- Playback either source of DVB-T- or DVB-C-TV, and DVB-T-Radio or DVBC-Radio depends on the selection in step 2 of "Station search" on page 12.

## On-screen Language Selection

- 1 Select Feature (unless you have already selected when the set was first switched on) then press ►. Then press ▲ or ▼ to select Language, then press ►.

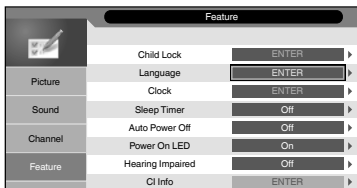

- 2 Press ▲ or ▼ to select OSD Language, then press ►. Press ▲ or ▼ to select the desired language.

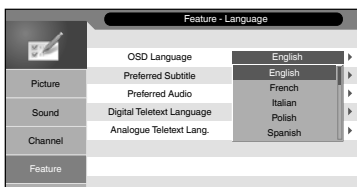

- 3 Press MENU to exit the menu.

## Changing the order of stored channels

The Automatic station presetting stores the stations in a specific order. However, this order can be changed if you wish.

- 1 Press MENU. Select Channel Management option in Channel menu, then press ►.
- 2 Press ▲/▼ to select the channel that you want to change, then select desired option from the below of the TV-screen. Then press the appropriate coloured button on the remote control.

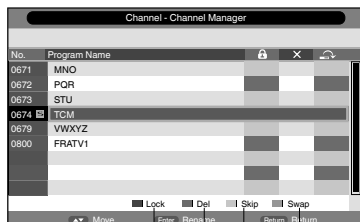

- 1 **Lock (red button):** Red ✓ mark will appear. (Lock is available only when Child Lock is On. See page16.)
- 2 **Del (green button):** Green ✓ mark will appear.
- 3 **Skip (yellow button):** Yellow ✓ mark will appear.
- 4 **Rename (ENTER button):** You can change the name of a channel on the cursor screen with ▲/▼ /◀▶, ENTER and Red/Green/Yellow buttons.
- 5 **Swap (blue button):** Press ▲ or ▼ to select the position that you want to swap the channel with, then press ENTER.

## Station search

**Warning! All previously saved channels are deleted in Step 5. A new channel search then starts automatically.**

- 1 Press MENU. Select Channel menu, then press ►.
- 2 For Digital channel search, press ▲ or ▼ to select TV Connection, then press ►. Press ▲ or ▼ to select Antenna (for DVB-T) or Cable (for DVB-C), then press ►.
  - You can select this option in DTV input mode only.
- 3 Press ▲ or ▼ to select Auto Search, then press ►. Press ► and then press ▲ or ▼ to select the desired country, then press ENTER.

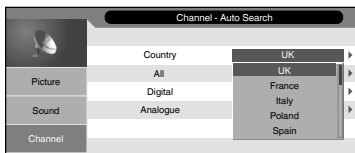

- 4 Press ▲ or ▼ to select the searching mode, then press ►. The confirmation screen will be displayed.



- All:** Search for the both of Digital, Analogue and Radio channel.  
**Digital:** Search for Digital and Radio channel.  
**Analogue:** Search for Analogue channel only.

- 5 Select OK and press ENTER to start Auto Search.

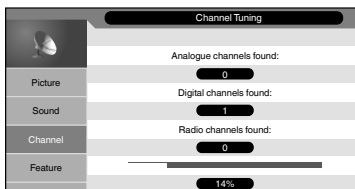

- Note:**
- Press RETURN if you return to step 3.

- 6 When the display reads 100%, press MENU to exit the menu.

## Update Scan

**If you wish to search and store only new channel, perform the Update Search. The current channel store is remained and only new channel will be stored to channel store.**

### Preparation:

- Select DTV in INPUT SELECT. Press MENU.
- Select TV Connection option in Channel menu, then press ►. Press ▲ or ▼ to select Antenna or Cable, then press ►.
  - Select Update Search option in Channel menu, then press ►.
- Perform the same steps as 4 - 6.

## Manual Station search

### Digital Manual Search

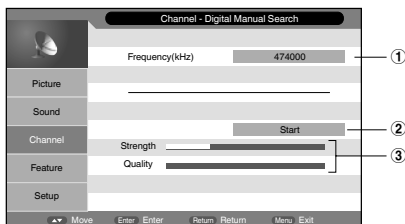

#### Preparation:

Select DTV in INPUT SELECT. Press **MENU**.

- Select TV Connection option in Channel menu, then press **▶**. Press **▲** or **▼** to select Antenna or Cable, then press **▶**.
- Select Digital Manual Search option in Channel menu, then press **▶**.

- ① Frequency of Digital channel to be searched.
- ② Select Start, then press **ENTER** to start searching.
- ③ You can verify the signal strength and quality of the selected service here. If necessary, adjust the direction of the DVB-T antenna to obtain the maximum signal strength.

### Analogue Manual Search

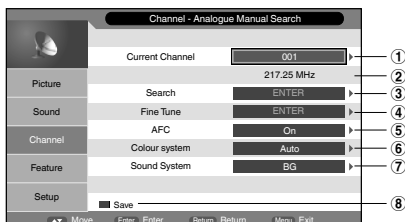

#### Preparation:

Select TV in INPUT SELECT. Press **MENU**. Select Analogue Manual Search option in Channel menu, then press **▶**.

- ① Press **▶**, then press **▲** or **▼** to select the current channel, then press **ENTER**.
- ② Frequency of current selected Analogue channel.
- ③ Press **▶**, then press **◀** or **▶** to perform intermittent search from current selected Analogue channel's frequency position.
- ④ Already correctly and optimally installed. Do not change anything here. Any changes can cause picture or sound disruption. The video can also be affected.
- ⑤ Press **▶**, then press **▲** or **▼** to select AFC On or Off, then press **ENTER**.
- ⑥ Colour system has already been preset to Auto. Do not change anything here. Any changes can cause picture or sound disruption.
- ⑦ The correct sound system is already installed. Any changes can cause sound disruption.
- ⑧ Finally, press red button to save the searched channel.

## Basic Operation

### Channel selection

With the **numbered buttons**.

Example:

- No. 2: Press **2**.
- No. 29: Press **2** and within 2 seconds, press **9**.
- No. 929: Press **9**, **2**, **9** same as above.

Press **P** + or - to change up or down a channel. This takes approx. 2 seconds. If the auto search only stored 5 stations, only these 5 will appear. Skipped channels will not appear (see P.12).

### Channel List

The channel List shows a list for each receivable programmes for TV/DTV and Radio.

Press **CH LIST** to display the Channel List.

Press **▲** or **▼** to select the desired channel.

Press **CH LIST** to display the selected channel.

### Information display

Press **i**. The program information will appear for approx. 4 seconds.

- If you press **i** twice, more information and signal strength and quality will appear. (DVB-T)

The following figure is an example of DVB-channel reception.

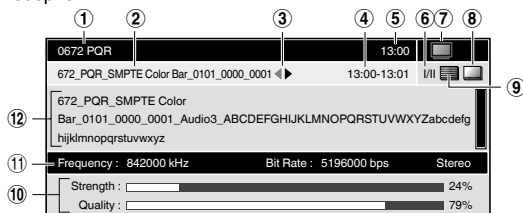

- ① Channel Name
- ② Program Title
- ③ Next program detail and current program detail alternate by **◀▶** buttons
- ④ Program Duration
- ⑤ Current time
- ⑥ There are two or more audio languages. (see below)
- ⑦ Radio icon will appear in case of Radio channel.
- ⑧ There is one or more subtitle languages. (see below)
- ⑨ DVB Teletext available
- ⑩ Signal strength and quality
- ⑪ Frequency and Bit Rate of channel
- ⑫ Program Detail

#### Note:

- There is no sound output from the main unit's speakers when a DVB-channel with Dolby Digital audio is selected. You can only hear Dolby Digital audio through the amplifier equipped with a Dolby Digital decoder. (see P.36)

### Audio/Subtitle language for DVB-channel

If the current watching DVB-channel has more than one audio language or subtitle language, you can change them with **AUDIO I/II** or **☐**.

- Press **AUDIO I/II**. Audio language menu will appear. Then press **▲** or **▼** to select the Audio language.
- You can also select the audio format (Stereo, Left or Right) by pressing of **◀** or **▶**.
- Press **☐**, then press **◀** or **▶** to select DTV Subtitle. Then press **▲** or **▼** to select the Subtitle language. Then press **ENTER**.

#### Note:

- Some DVB-broadcasts may not provide subtitle language service.
- To cancel the Audio/Subtitle language menu, press **RETURN**.



## QuickView

**P↔P** button allows you to go back to the last selected TV channel.

- This feature is not available in external input mode and also it can not step over the ATV-input mode and DTV-input mode.

## MUTING

Press . The sound will be cut off.

The muting can be released by pressing  again or  + or .

## Still picture

Press **FREEZE** to make a still picture. To cancel the still picture, press **FREEZE** again.

### Note:

- During still picture mode, PICTURE SIZE feature is not available. (If you press **PICTURE SIZE**, still picture mode will be canceled.)
- If you performed the still picture function in DTV-input mode, this function works with also the external output signal from SCART socket.

### Note:

- During TV or external input mode (except PC input mode), if there is no signal reception, the TV will change to standby after approx. 15 minutes (in PC input mode: 2 minutes).
- Some functions are activated and de-activated with the same button. Others require **RETURN** button for de-activating.

## Teletext

Teletext is sent page by page. This unit is able to automatically store up to 800 pages, but they can only be accessed once they have been stored. This can take a few moments.

The Teletext language menu allows the installation of the teletext language.

The languages displayed are only those supported by the channel.

## Fastext/TOPText

The Fastext/TOPText is teletext with a special directory. On the lower part of the screen there are four different coloured fields (red, green, yellow and blue). These fields lead directly to the pages shown within. The coloured buttons on the remote control correspond to the coloured fields. Press the appropriate coloured button in order to activate the desired colour field.

## Switch on / off Teletext

Teletext is not transmitted by all channels.

Select a channel that shows teletext.

Press . You will now see a teletext page.

(If "100" is shown without any text information, it may mean that the channel you have selected does not support teletext.)

Press  again. The TV-screen will be split into two and both Teletext information and actual broadcast will be displayed at the same time.

Press  again in order to switch off teletext.

Press  again in order to switch on teletext again. The last page which was stored is now shown.

### Note:



- You cannot select any other channels as long as teletext is switched on. Switch teletext off when you want to switch over to another channel.

## Select Page

Press **P +** or **-** until the page you desire appears. Or ... enter the requested page number by using the **10 Number Buttons**.





And if you mistype something, just enter the complete 3-digit wrong page number then enter the desired number again. Or ... press one of the coloured teletext buttons so that a page from Fastext/TOPText is shown.

## Hold Pages



Some pages are divided up into subpages by the channel. Subpages are automatically shown in turn, as they are transmitted. In order to hold the page, press . Press  again in order to display the next subpage.

## Directly Select Subpages

You can directly select the subpages if required. You may use one of two operations.

1. Press   in order to select subpage 2. 0 0 0 0 is shown. Enter **0 0 0 2**. It can take a minute before subpage 0002 appears. Press   again in order to switch off the subpage feature.

Or:

2. Wait a few seconds, and the right now available subpages will be shown in the bottom line. Select your page with  or .

## Enlargement

In order to enlarge the display, press .

Either the upper or lower half of the screen is enlarged.

Each time you press  you switch between the display of the upper or lower half of the screen or the full picture.

## Answering Quiz Questions

Some pages contain quiz questions with concealed answers.

Press  in order to show the answers.

## Stereo reception in analogue cable TV channel mode

You can see the each signal type of STEREO, Nicam Mono, and DUAL I/II, etc. on the TV-screen when you press .

**When 2-channel sound reception is available, you can select your preferred audio with the AUDIO I/II.**

Each time you press **AUDIO I/II**, the sound channel will switch to the alternative channel available.

### Note:

- In case of bad reception, the stereo sound also can be disturbed.
- The broadcast sound type may not be saved if Power off.

## Remarks on DVB-T system

DVB-T is at present still being developed. You can get information regarding the current stage of development from your specialist retailer.

As a digital service DVB-T basically works differently to previous analogue TV reception.

### Reception Possibilities:

In contrast to cable TV, DVB-T is received via room or roof antennas. A room antenna is sufficient for reception within the reception area of a DVB-T transmitter. A roof antenna may perhaps be necessary for reception in a fringe area. Existing roof antennas may have to be turned in a different direction.

Contact your specialist retailer to find out about the location of the reception areas or fringe areas. You cannot get DVB-T reception outside the fringe area. Ask a certified antenna specialist for advice on interference with reception. The tuner of this appliance cannot provide active room antennas with operating voltage. Active room antennas have to be equipped with a separate power supply.

### Reception Quality:

DVB-T reception principally either works really well or not at all. There is not a smooth transition with a constant reduction in reception quality. Digital interference occurs at maximum reception range:

the image freezes, the picture becomes blocky, the sound breaks up or reception cuts out altogether at times. If you notice interference with DVB-T reception then this is usually not due to a fault on the TV appliance. Please contact an antenna specialist if you have interference with reception. Inspection of the quality of DVB-T reception is not included in the free warranty to be provided by the manufacturer of the TV appliance.

### Image and Sound Quality:

An individual transmitter transmits up to 4 TV channels on one transmission frequency. This is possible through compression in accordance with the MPEG standard, which is similar to digital data storage on a DVD. The data rate of DVB-T is just a lot lower; at present the max. video bit rate is approx. 4Mbps and the max. audio bit rate is at 256kbps. Visible interference (e.g. blocky picture) can result at extremely low data rates despite there being excellent reception quality within vicinity of the transmitter. Blocky pictures are no fault of the receiver. They are the result of the low data rate transmitted. The digital DVB-T sound can be transmitted to the digital amplifier via the digital output of your TV set.

### Image Format

Images are transmitted in 4:3 format, 4:3 letterbox format (with black bars above and below the picture) and anamorphic 16:9 format (without black bars). The max. transmitted resolution at present is 704x576.

### Child Lock

Like DVDs, DVB-T offers can also provide age-restricted access. At the moment, no channels are equipped with this restriction. This appliance does, however, already offer the feature of setting up password protected age restrictions, which only work when the respective programmes are broadcast.

### DVB-T Update

The DVB-T norm earmarks the transfer of firmware updates. The transfer of firmware updates is called Over Air Download or OAD for short.

If this product happens to require a firmware update in future, this update could be received via DVB-T. If the available software for updating is detected, the confirmation message whether start the software to download is displayed. The rest please proceed to download-operation according to the directions of a TV screen.

### EPG (Electronic Program Guide)

EPG is part of the DVB-signal with 8-days-schedule. This TV can receive and display the EPG-information included into DVB. This TV's EPG-Decoder will not work with Satellite-TV.

## Password Setup (Parental lock)

Parental lock is a function of the channel provider. If it is not supported by the channel, parental lock is without function. Currently there are no channels supporting parental lock.

- 1 Press **MENU**. Select Child Lock option in Feature menu, then press **▶**.
- 2 'Password' will appear. Press **'0 0 0 0'** using the **Number buttons (0-9)**. (This is the default password.)
- 3 Select the desired option, then press **▶**.

**Child Lock:** To activate the Lock feature in Channel Management, select On with **▲/▼**, then press **ENTER**.

**Parental Lock:** Press **▲** or **▼** to select desired parental rating, then press **ENTER**.

### Change Pin Code:

- Old Password  
Enter the current password with Number buttons.
- New Password  
Enter your chosen new password (please call Service, if you have forgotten the new number).
- Confirm New Password  
After you have entered the new password, you need to enter the same password again for confirmation.

- 4 Press **RETURN** several times to return to the normal screen.

While toggling between channels, if a service which has a parental rating (higher than your setting) and you have set the Child Lock to On is selected, the channel will be locked. The password entering screen will appear. Then enter the password to view that channel.

## EPG (Electronic Program Guide)

The Guide menu shows the available programme listings for the next 8 days only, including today.

- 1 Press **GUIDE (EPG)** to display the Guide menu.

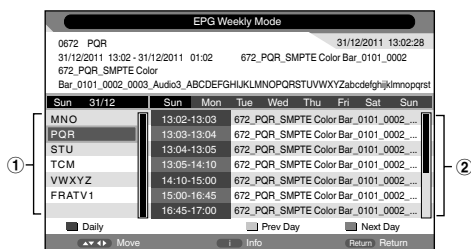

- ① Service list :  
Lists all the services that are currently available. As you scroll through the service list by pressing **▲** or **▼**, the Event list will be refreshed accordingly.

- ② Events list :  
List the events in a grid of rows. Press **▶** to enter the Events list. You can press **▲** or **▼** to navigate through the rest of the events. You can easily move to the Previous day or Next day in the Events List by pressing **Yellow** or **Blue** button (the date of the programme information you are currently viewing is shown in the top left hand corner).

### Note:

- You can change to Daily mode by pressing of **Red**.

- 2 From within the Events list, you can open the Event detail for the currently highlighted programme by pressing **i**.

The Event detail shows the extended event description of an event.

To return to the Events list, press **i**.  
To clear the menu screen, press **MENU** or **RETURN**.

## Using the Digital Service

Some services bring you programmes with the Digital Service, letting you experience DTV interactively.

When provided, the Digital Service will start when you press **⏏**.





## Picture size and resolution

### Resolution and picture quality

Broadcast wide screen films in different resolutions. The following table shows the resolution options for wide screen film broadcast media.

Resolution of the wide screen signal	Broadcast media						
	Analogue cable TV	Digital cable TV	DVB-T	Satellite (DVB-S)	DVD	HDTV Satellite (DVB-S2)	Blu-ray-Disc
432i x 768 (Letterbox)	Yes	Yes	Yes	Yes	Yes	Yes	No
576i x 768 (anamorphic)	No	Yes	Yes	Yes	Yes	Yes	No
720 x 1280 (HD)	No	Yes	No	No	No	Yes	Yes
1080i x 1920 (HD)	No	Yes	No	No	No	Yes	Yes
1080p x 1920 (HD)	No	No	No	No	No	No	Yes

Best picture quality is achieved when the input signal has a resolution of 1920 x 1080i. If a signal with a lower resolution is input (e.g. analogue cable TV), there is a visibly poorer picture quality.

This is understandable as, if the same picture quality were available at a lower resolution, the broadcasting companies would not need to take the trouble to send the signal at the higher resolution.

### Why are there different resolutions?

Analogue cable TV uses a standardised TV signal. Each analogue 4:3- tube TV, however old it is, can process this signal. That is the advantage of standardisation. The disadvantage is that the resolution has not changed since the end of the Second World War. The resolution has been max. 576 x 768 for over 60 years.

For comparison: today's TVs feature a FullHD-resolution of 1080 x 1920.

The analog cable-network offers the 16:9-format at a low resolution of only 432 x 768. This input covers only 16% of a FullHD-screen's area. 84% of the screen would stay black, if the TV would not make up the rest by some special mathematics. 84% of what you see had been made up artificially by magnifying the tiny input-signal to full-screen-size. That's the reason for the analog cable-network's low picture-quality seen on every FullHD-TV.

### Picture quality and black bars

Wide screen films come in different formats. The format is the relationship between the width and height of the picture. For example, with a 16:9 film the width to height ratio is 16:9 or 1.78:1. Only 16:9 films can fill a HD-ready screen without black bars. Therefore, black bars are always visible when a format other than 16:9 is received. E.g. 4:3, A 4:3 displays vertical black bars to the right and left.

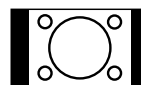

4:3 picture 1:1 on 16:9 screen

If a 4:3 picture is increased to 16:9 format then it either appears distorted (see illustration) or some parts of the picture are cropped off at the top and the bottom. This is completely normal and is not a fault in the wide screen TV.

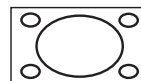

4:3 picture zoomed on 16:9 screen

Super Cinemascope films are wider than 16:9 films. They are in the format 2.4:1 or 22:9, for example. This is clearly wider than 16:9. Therefore, Super Cinemascope films display black bars at the top and bottom on any HDTV set.

### Picture format and resolution

There is no connection between the picture format and the resolution received. For example, the Super Cinemascope format can be received in all resolutions, even in the HD resolution 1080i x 1920. For HDTV reception too an HDTV set may display black bars at the top and bottom.

## Picture format

### Picture Size

The required picture format can be set by pressing the **PICTURE SIZE** button. Press **PICTURE SIZE** until the required format is displayed.

You move through the following formats when you press the button: Auto, 4:3, 16:9, 14:9, Cinema, Real (HDMI/DTV/PC mode only).

### Auto

The picture is automatically only then shown in a format-filling display when a WSS-TV signal is received.

### Note:

- Auto is not available in Component mode.

### Example:

If the analogue tuner receives a letterbox image with WSS signal then the resulting image looks like this:

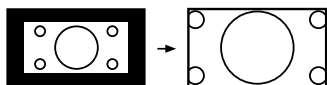

illustration 1:  
Letterbox image is increased

### WSS:

Public broadcasters include 16:9 identification, the WSS signal (WideScreenSignalling), during transmission in order to ensure automatic conversion to 16:9.

Some private broadcasters do not transmit a WSS signal. Automatic does not recognise anything without WSS signal and does not automatically alter the picture size. Use the **PICTURE SIZE** button to set the required picture size for private channels.

### Other formats

Press **PICTURE SIZE** until the desired size is reached.

### 4:3

The picture is displayed in 4:3 format with black bars to the right and left.

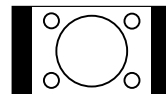

### 16:9

The width of the picture will be zoomed evenly. **16:9** is particularly suitable for DVD players, DVB-T, DVB-C and satellite receivers, which can transmit and show 16:9 feature films without black bars. In the set-up menu of the set, adjust it to show that a 16:9 TV set is connected.

### 14:9

The picture is increased somewhat but not up to the full screen width. Black bars remain on the right and left and also at the top and bottom.

### Cinema

Use Cinema to increase a small 4:3 letterbox signal. How do you recognise whether the broadcasting station / the set operating is using a 4:3 letterbox signal that is too low? Press the **PICTURE SIZE** button on the remote control until the 4:3 format appears. If the picture is surrounded by a black border as in the illustration, this is a 4:3 letterbox signal. Limited by the broadcasting station / the set operating, this signal is much too low for a 16:9 HD screen. Cinema increases this picture that is too small as far as possible. Natural visible poor focus emerges, rather as if a postcard were being increased to poster size. This unfocused appearance is conditioned by input signals that are too low and is in no way a production fault in this TV set.



4:3 Letterbox picture increased to Cinema format.

### Real (HDMI/DTV/PC mode only)

All images are displayed on the TV screen of 16:9 ratio without overscanning.

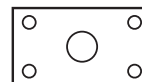



### Note:

- In PC mode, the picture size feature is available only for 16:9-, 4:3- or Real-format.
- External receivers can automatically adjust the picture size via a SCART cable. Please read the instructions for the external receiver.
- If you select Real, the image might become a horizontal expansion according to the signal format. In this case, select an appropriate aspect with **PICTURE SIZE**.

## Other convenience functions

Selected Items	Setup hint
Picture	
Picture Mode	
Standard	Standard picture quality (factory-set)
Vivid	Enhanced picture contrast and sharpness (factory-set)
Soft	Intended for bad-quality signals (factory-set)
User	Your personal preferences
Brightness / Contrast / Sharpness / Colour / Tint (available only when you selected "User" at Picture Mode)	You can adjust the picture to your preference. <ul style="list-style-type: none"> <li>Tint is available in NTSC-signal mode or Component/ HDMI-signal with 60Hz.</li> </ul>
Backlight (available only when you selected "User" at Picture Mode)	You can use the Backlight feature to adjust the screen brightness for improved picture clarity.
Colour Temperature	Neutral (Standard) / Reddish (Warm) / Bluish (Cool)
Noise Reduction	Sometimes it is not possible to input a high-quality HD signal. The actual signal input is too small and noisy, e.g. a video film in letterbox format, or a noisy analogue cable TV signal. This feature can slightly reduce interferences caused by the faulty input signal.
Off / Low / Middle / High	
Reset	Select "Reset" to reset Picture options to the factory preset values.
Sound	
Sound Mode	You can change the sound mode setting. If you select "User", you can change the setting of Bass and Treble and TV memorizes your setting.
Standard / Movie / Music / Speech / User	
Bass / Treble / Balance	You can adjust the sound quality to your preference.
Surround	The Surround feature processes the audio signal to expand the listening field wider and deeper to create a 'pseudo surround-sound' from the TV's speakers. The feature works with stereo signals from TV broadcast or AV input.
On / Off	
Stable Sound	This will automatically adjust volume so each channel and input has the same average volume level.
On / Off	
Reset	Select "Reset" to reset Sound Mode, Bass, Treble and Balance to the factory preset values.
Channel	See page 12-13.

## Other convenience functions

Selected Items	Setup hint
Child Lock	See page 16.
Language	
OSD Language	See page 12.
Preferred Subtitle	<p>Select preferred subtitle language, if the current watching DVB channel has more than one subtitle language.</p> <p>If the preferred subtitle language set here is not transmitted in the channel, the first displayed subtitle language in Subtitle language menu (P.13) is automatically selected.</p> <ul style="list-style-type: none"> <li>This option is not available for analogue channel.</li> </ul>
Preferred Audio	<p>Select preferred audio language, if the current watching DVB channel has more than one audio language.</p> <p>If the preferred audio language set here is not transmitted in the channel, the first displayed audio language in Audio language menu (P.13) is automatically selected.</p> <ul style="list-style-type: none"> <li>This option is not available for analogue channel.</li> </ul>
Digital Teletext Language	<p>If a DVB-channel name or information-display in the Channel banner (page 13) or EPG has a data of each language, the first preferred display language can be set here.</p> <ul style="list-style-type: none"> <li>This option works also for continental countries.</li> <li>In continental countries, if a DVB-channel has a Teletext data of each language, the first preferred Teletext language can be set here.</li> </ul>
Analogue Teletext Lang.	See page 14.
Clock	
Date	The date/time is displayed that is recognized on this unit.
Time	<ul style="list-style-type: none"> <li>You can not adjust the date/time manually.</li> </ul>
Time Zone	<p>If the time displayed on the Channel Information differs from the actual time, adjust the time offset until the correct time zone is shown.</p> <ul style="list-style-type: none"> <li>Normally, this would be done by selecting "Auto".</li> </ul>
DST	If DST is set to "On", time is displayed one hour earlier.
On / Off	<ul style="list-style-type: none"> <li>This option is not available if you set Time Zone to Auto.</li> </ul>
Sleep Timer	Sleep timer switches the TV to standby after a defined period of time.
Off/15/30/45/60 Min	To cancel the Sleep Timer, set to "Off".
Auto Power Off	When the Set and Remote button operation are not operated with specified period by this setting(1/2/4 Hours), the power status is changed to stand by mode automatically.
Off/1/2/4 Hour	
Power On LED	To cancel the lighting of  power indicator (P.7 (2)) during operation, set to "Off".
On / Off	
Hearing Impaired	The hearing impaired subtitle type is output preferentially.
On / Off	<ul style="list-style-type: none"> <li>Even if you set this option to On, the subtitle of Hearing Impaired is not displayed. Press  on the remote control to display the subtitle.</li> </ul>
CI Info	<p>You can access the Common Interface module information from this menu option.</p> <ul style="list-style-type: none"> <li>This unit supports the C.I. card of "Top Up TV" and "Boxer".</li> </ul>

## Other convenience functions

Selected Items	Setup hint
Setup	
OSD Timer 5/10/15/20/25/30 Seconds/Never	The OSD is cleared automatically as per this setting. But if you select "Never", the OSD is not cleared automatically. (Press <b>RETURN</b> to clear.)
SCART Input	
Auto	Factory setting, normally OK.
RGB	when RGB is input.
CVBS	when Composite is input.
S-Video	When S-Video is input.
SCART Output	
TV / Monitor	This determines whether the SCART outputs the signal from the internal tuner or whatever input is shown on the screen.
PC Setup	
Auto Adjust	H Position, V Position, Phase and Clock are adjusted automatically as per the input PC video signal. <ul style="list-style-type: none"> <li>When PC-input mode was selected and a PC-signal was input, Auto Adjust will be performed automatically.</li> </ul>
H Position	To adjust the horizontal placing of the image.
V Position	To adjust the vertical placing of the image.
Phase	Eliminates the horizontal (PHASE) interfering lines.
Clock	Eliminates the vertical (CLOCK) interfering lines.
HDMI Mode	
Auto	Auto (factory setting), can remain in this mode. Change not necessary.
PC	PC (for PC), if desired.
Video	Video (for Video), if desired.
Blue Screen	
On / Off	You can set the TV to automatically change to a blue screen and mute the sound if the signal is weak or absent. <ul style="list-style-type: none"> <li>This option is not available for DTV, PC and Radio mode.</li> </ul>
Reset TV Setting	
Press <b>▶</b> to enter the Reset TV Setting screen. Press <b>◀</b> to select "OK", then press <b>ENTER</b> . Reset the TV function will now begin, and this unit will automatically turn off.	
Software Upgrade	
This option is not available because of service purpose only.	
Version	
If you press <b>▶</b> , the $\mu$ -com's software version is displayed.	

## Media Operation

You can enjoy viewing pictures and playing music from your USB-Stick.

- 1 Connect the USB-Stick into the Media Input terminal.
- 2 Press **MEDIA**. Media Browser will appear.

### Warning:

- Do not disconnect a USB-Stick while it is being accessed. Doing so can damage the USB-Stick or the files stored on the USB-Stick. You can safely connect or disconnect the USB storage device when the TV is not in MEDIA mode.
- Back up all the data in the USB-Stick in case if data was lost due to unexpected accident. We do not assume any liability for the losses by misuse or malfunction.
- Do not use USB extension cable.

### Note:

- Not all USB storage devices are compatible with this TV.
- The character that exceeds the display area is not displayed.
- The displaying of images that fill the screen cannot be guaranteed. Black margins can remain around the images displayed.

## Media Browser

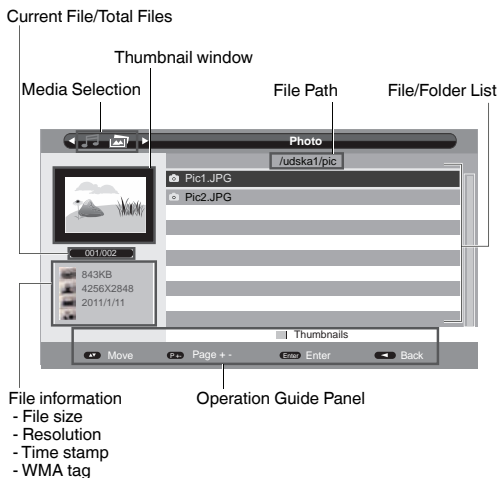



### Note:









- The content will change in accordance with each media setting screen.

You can use various playback operation with appropriate guide button in Operation guide panel.

## Playback files

- 1 Press  (Music) or  (Photo) at Media Selection and press **▼**.
- 2 Select folder or file with **▲** or **▼**, and then start the playback with **ENTER**.
  - Press **RETURN** to return to Media Selection.

You can playback the files with the following remote control buttons.

Button	Action
	Press to rotate the picture.
<b>ENTER</b>	Press to start the playback
<i>i</i>	Press to show / hide the picture information window.
 (PLAY)	Press to start the playback or slideshow.
	Press to pause the playback.
	Press to stop the playback.
	During the playback, press to select the next file.
	During the playback, press to select the previous file.
	During the music playback, press to search forward.
	During the music playback, press to search backward.
<b>PLAY MODE</b>	During the music playback, press to select repeat or random mode.
<b>YELLOW</b>	In Media Browser, press to display JPEG files in thumbnail view.

### Note:

- For large image sizes, the display time will be longer than the slideshow interval set.
- During the playback of a music file, you can not adjust the volume with VOL +/- on the set.

## Playable File Types

### Photo

Type	Extension Name	Compression	Spec / Limitation
JPEG	.jpg .jpeg	Baseline Progressive	Non-support JPEG 2000 compression Color type : YCbCr (Non-support CMYK) Support JPEG/JFIF and JPEG/Exif file format Picture size limitation: Baseline: Number of horizontal pixels: up to 165370 Progressive: Number of horizontal pixels: up to 61648 • No limitation on vertical pixels.

### Audio

Format	Extension Name	Audio Codec	Sampling Rate (kHz)	Bitrate (kbps)
WMA	.wma	WMA 7 / 8 / 9 STD	8, 11.025, 16, 22.05, 32, 44.1, 48	8 to 768

### File System

Standard	Media Type	Maximum Storage Size	File Number	File Size
FAT32	USB Mass Storage * HDD (Not Supported)	2TB	Not limited within maximum storage size range.	Maximum 4GB
NTFS				Maximum 2T - OVER HEAD(INCLUDE NTFS META DATA and RESERVE REGION)





## Disc

DVD discs must be Region 2 or Region ALL type to play on this unit. The loaded Disc (DVD and Audio-CD) will be recognized automatically. The suitable disc formats are: DVD-ROM, DVD-Video, DVD-R/-RW/-R DL, Audio CD, Fujicolor CD, KODAK Picture CD, CD-R/CD-RW, CD-ROM. Some CD-R/RW discs may be incompatible.



- This unit cannot play an 8cm disc. It cannot also be played even using a disc adapter.
- Please do not insert any disc of an irregular shape into the unit, as it may interfere with the function of the unit. You may not be able to remove it.
- If you tilt or move the unit while DVD or CD discs are placed inside, your discs may be damaged.
- Please do not use after market accessories, such as a ring protector, as this may cause trouble with the operation of the unit.
- Use only UDF (Universal Disc Format) discs for recording.
- When you play a movie that has been edited with a DVD recorder (partially deleted, etc), it may be paused for a moment where edited.
- When you play a movie that has been edited with a DVD recorder or such, it may not be played exactly as you edited it.

Disc type and logo mark	content
	Audio + Video (moving pictures)
	Audio
The following discs are also available. <ul style="list-style-type: none"> <li>• DVD-ROM, DVD-R/-RW/-R DL discs of DVD video format and MP3/WMA/JPEG.</li> <li>• CD-ROM, CD-R/CD-RW discs of MP3/WMA/JPEG.</li> </ul>	

Do not play DVD-Audio, CD-G, Photo CD, Video CD and SVCD to prevent accidental erasure of prerecorded material.

### Title

When two or more movies are recorded on a disc, the disc is divided into two or more sections. Each section is called a "TITLE".

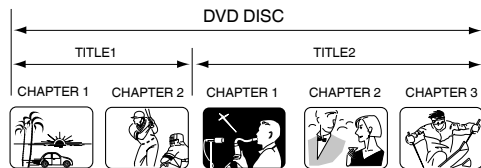

### Chapter

The titles can be subdivided into many sections. Each section is called a "CHAPTER".

### Track

An Audio CD can contain several items. These are assigned to tracks.



### Removing Disc from Case

Be sure to hold the edge of disc. Do not touch the surface of the disc.

Pick up the disc gently from the case.

- Do not scratch the disc.
- Do not get dirt on the surface of the disc.
- Do not stick a label or adhesive tape on the disc.
- Do not drop or bend the disc.

### Storing Disc

- Store the disc in the case to avoid risk of scratches, dirt or damage.
- Do not leave disc exposed to direct sunlight or in hot or humid places.

### Cleaning Disc

Wipe the disc with a clean, dry cloth from center to edge.

- Do not wipe in circular direction.
- Do not use liquid or aerosol cleaners.

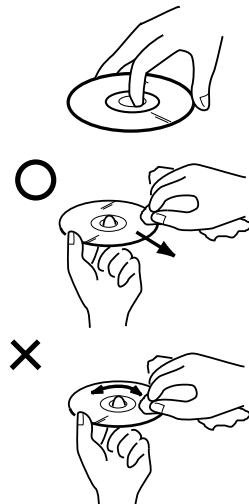

## Disc

### PC-created disc compatibility

- You may not be able to play discs recorded using a personal computer or recorder for disc compatibilities, scratches or marks on the disc, dirty lenses of the unit or condensation and so on.
- Discs recorded using a personal computer may not be playable in this unit due to the setting of the application software used to create the disc. In these particular instances, check with the software publisher for more detailed information.

### Playable files

- ISO 9660 Level 1 or 2 compliant.  
Romeo and Joliet file systems are both compatible with this player.
- DRM (Digital Rights Management) protected files will not play in this player.  
For detailed information, please see the instruction manuals or help files that came with your PC and/or software.
- File structure (may differ): Up to 299 folders on a disc; up to 648 files within each folder
- Folder and file names can be displayed as long as they are typed in alphabets and numbers. If folder and file names are other than alphabets and numbers, they may be replaced and displayed as “\_”. Garbled characters may also be displayed in this case.

### Playing image files

JPEG files recorded in DVD-R/-RW/-R DL and CD-R/-RW can be played.

### JPEG file compatibility

- Image files should be saved in JPEG format.
- Files recorded in Fuji Colour CD, Kodak Picture CD or CD-R/-RW can be played.
- Compatible formats: Baseline JPEG and EXIF 2.2\* still image files up to a resolution of 3072 x 2048.  
\*File format used by digital still cameras.
- Files with extensions .jpg or .JPG can be played.
- Progressive JPEG formatted files do not work.
- It may take some more time to start to play larger files than usual.
- JPEG files with different aspect ratio may be displayed with black bands (either vertical or horizontal).

### Playing Audio files

WMA and MP3 files recorded in DVD-R/-RW/-R DL, CD-R/-RW can be played.

### Windows Media Audio (WMA) compatibility

- WMA is an acronym for Windows Media Audio and refers to an audio compression technology developed by Microsoft Corporation.
- You can encode your files by using Windows Media Player Ver.7, 7.1, Windows Media Player for Windows XP or Windows Media Player 9 Series.
- When encoding your files, use only applications approved by Microsoft Corporation. If you use non-approved application, it may not work properly.
- This unit is compatible with audio files recorded with the following sampling frequency: 32 kHz, 44.1 kHz and 48 kHz.
- It is not compatible with loss-less encoding.
- Files with extensions .wma or .WMA can be played.

### Playing MP3 (MPEG-1 Audio Layer-3) files

- This unit is compatible with audio files recorded with the following sampling frequency: 32 kHz, 44.1 kHz and 48 kHz.
- Files with extensions .mp3 or .MP3 can be played.
- For the best quality of sound, 128 kbps or higher bit rate is recommended.

### Copy Control CD (CCCD)

This product is designed to conform to CD-DA (Compact Disc Digital Audio). Any other discs than CD-DA are not guaranteed with their operation and performance in this product.

## Playing a disc

This section shows you the basics on how to play a disc.

### Basic playback (DVD/Audio CD)

#### Preparation

Make sure that the  (**Power**) on the unit is pressed (ON).

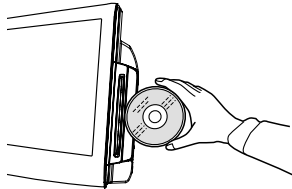

**1** Press **DVD** on the remote control to select the DVD mode.

**2** Place the disc in the disc slot with the label side facing forward. (If the disc has a label.)





- Do not place a disc which is unplayable in this unit.

**3** On the TV-screen, "" changes to "Loading" and then playback commences.

- A menu screen will appear on the TV screen if the disc has a menu feature.
- Press / to select title, then press **ENTER**. Title is selected and play commences.

**4** Press  to end playback.

- The unit can record where you stop a video, but it depends on a disc you are using. Press **PLAY** () to resume a playback point. The unit can store a memory of stopped point of last five discs that you have played. When one of these discs is next loaded, you can resume playback from where you stopped playing last time.
- If you press  again ("Resume off" appears on the screen.), the unit will clear the memory of its stopped point.
- It is only DVD videos that a stopped point can be stored in the unit with.
- You cannot save a stopped point for some discs.  
If a number of discs played and stored in the unit exceeds five, a new memory will overwrite the old stored memory.

#### To start playback in the stop mode

Press **PLAY** ()

#### Note:

- **If the unit does not operate properly:** Static electricity, etc., may affect the player's operation. Disconnect the AC power cord once, then connect it again.
- If a disc is inserted during some modes other than DVD mode, it may switch to DVD mode and then playback may be begun automatically.

#### To pause playback (still mode)

Press  during playback.

To resume normal playback, press **PLAY** ()

- The sound is muted during still mode.



#### To stop playback

Press .

#### To remove the disc

Press .



Remove the disc after the disc comes out.

- Using inferior discs may result that you cannot remove the disc. In this case, press **PLAY** () to play the disc and then press **EJECT** .

#### Note:



- If a non-compatible disc is loaded, "Can't play disc" or "Incompatible disc region number Can't play disc" will appear on the TV screen according to the type of loaded disc. In this case, check your disc again (see page 25).
- Some discs may take a minute or so to start playback.
- When you set a single-faced disc label backwards (i.e. the wrong way), "Loading" will appear on the display for a few minutes and then "Can't play disc" will continue to be displayed.
- Some playback operations of DVDs may be intentionally fixed by software producers. Since this unit plays DVDs according to the disc contents the software producers designed, some playback features may not be available. Also refer to the instructions supplied with the DVDs.
- Do not move the unit during playback. Doing so may damage the disc.
- In many instances, a menu screen will appear after playback of a movie is completed. Prolonged display of an on-screen menu may damage your television set, permanently etching that image onto its screen. To avoid this, be sure to press **Power** () on your remote control once the movie is completed.
- There may be a slight delay between the button is pressed and the function activates.

#### Playing in fast reverse or fast forward directions (DVD/Audio CD)

Press  or  during playback.

: Fast reverse playback

: Fast forward playback

Each time you press  or , the playback speed changes.

#### To resume normal playback



Press **PLAY** ()

#### Note:

- The unit mutes sound during reverse and forward scan of DVD discs.
- The playback speed may differ depending on the disc.

#### Playing frame by frame (DVD)

Press  during playback.

Each time you press  or , the picture advances one frame.

#### To resume normal playback

Press **PLAY** ()

#### Note:

- The sound is muted during frame by frame playback.

## Playing in slow-motion (DVD)

Press ◀ or ▶ during playback.  
Each time you press ◀ or ▶, the slow-motion speed changes.

## To resume normal playback

Press **PLAY** (▶).

### Note:

- The sound is muted during slow-motion playback.

## Locating a chapter or track (DVD/Audio CD)

Press ◀◀ or ▶▶ repeatedly to display the chapter or track number you want.

Press ▶▶ to playback starts from the selected chapter or track.

Press ◀◀ to locate succeeding chapters or tracks.

Playback starts from the beginning of the current chapter or track.

### Note:

- A prohibition message “Depending on the disc, this operation may be prohibited” or “This operation can’t be performed” may appear at the screen. This message means either the feature you tried is not available on the disc, or the unit cannot access the feature at this time. This does not indicate a problem with the unit.

## Zooming (DVD)

This unit will allow you to zoom in on the frame image. You can then make selections by switching the position of the frame.

**1** Press **ZOOM** during playback.

The centre part of the image will be zoomed in. Each press of **ZOOM** will change the ZOOM x2 and x4.

**2** Press ▲/▼/◀/▶ to view a different part of the frame.

You may move the frame from the centre position to UP, DOWN, LEFT or RIGHT direction.

**3** In the zoom mode, press **ZOOM** repeatedly to return to a 1:1 view.

### Note:

- You can select the Pause or Slow in the zoom mode.
- Some discs may not respond to zoom feature.

## Locating desired scene (DVD/Audio CD)

Use the title, chapter or track recorded on the disc to locate the desired point to playback.

To check the title and chapter/track, press **i**.

**1** Press **Number buttons (0–9)** to input the number during playback or stop mode.

- If you input a wrong number, press **CANCEL**.
- Refer to the package supplied with the disc to check the numbers.

**2** Press **ENTER**. Playback starts.

- When you change the title, playback starts from Chapter 1 of the selected title.
- Some discs may not work in the above operation.

## Changing Soundtrack Language (DVD)

You can select the language when you play a multilingual disc.

**1** Press **AUDIO I/II** during playback.  
The current soundtrack language will appear.

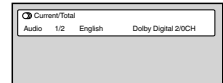

**2** Press **AUDIO I/II** repeatedly until the desired language is selected.



- The on screen display will disappear after a few seconds.

## Subtitles (DVD)

When playing back a disc recorded with subtitles, you can select the subtitle language or turn the subtitle off.

**1** Press **□** repeatedly during playback until the desired language is selected.

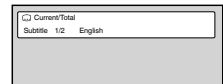

**2** To turn off the subtitle, press **□** until “Off” appears.



- The on screen display will disappear after a few seconds.

### Note:

- If the desired language is not heard after pressing the button several times, the language is not recorded on the disc.
- The selected soundtrack language is cancelled when you eject the disc. The initial default language or available language will be heard if the disc is played back again. It does not go back to the initial default language if the unit has a resuming memory.
- When you want to play DTS audio, connect this unit to a DTS-compatible amplifier or decoder using a digital audio cable.
- Depending on the DVD, you may not be able to change subtitles, or to turn subtitles on or off.
- While playing a DVD, the subtitle may change when you loaded or eject the disc.
- In some cases, a selected subtitle language may not be changed immediately.

## Changing angles (DVD)

When playing back a disc recorded with multi-angle facility, you can change the angle that you are viewing the scene from.

- 1 Press **ANGLE** during playback.  
The current angle will appear.

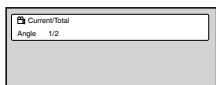

- 2 Press **ANGLE** repeatedly until the desired angle is selected.

### Note:

- Depending on the DVD, you may not be able to change the angles even if multi-angles are recorded on the DVD.

## Title selection (DVD)

Two or more titles are recorded on some discs. If the title menu is recorded on the disc, you can select the desired title.

- 1 Press **TOP MENU** during playback.  
Title menu appears on the screen.
- 2 Press **▲/▼/◀/▶** to select the desired title.
- 3 Press **ENTER**.  
The playback of the selected title will start.

### Note:

- Some DVDs allow you to select the disc contents using the menu.
- When you playback these DVDs, you can select the subtitle language and soundtrack language, etc. using the menu.

## DVD menu (DVD)

Two or more titles are recorded on some discs. If the title menu is recorded on the disc, you can select the desired title.

- 1 Press **DVD MENU** during playback.  
The DVD menu appears on the screen.
  - Press **DVD MENU** again to resume playback at the scene when you pressed **DVD MENU**.
- 2 Press **▲/▼/◀/▶** to select the desired item.
- 3 Press **ENTER**.  
The menu continues to another screen. Repeat steps 2 and 3 to set the item completely.

### Note:

- Depending on the DVD, you may not be able to resume playback from the scene point when you press **DVD MENU**.

## Disc status

With press of **i**, the status of the disc will appear on the screen. To cancel the display, press **i** repeatedly.

- Display messages may change at every time when you press **i** for some discs or files.

## Using HOME MENU

### Playing a disc

- 1 Press **SETUP** during stop mode.  
HOME MENU will appear.
- 2 Press **▲/▼/◀/▶** to select "Disc Navigator", then press **ENTER**.
- 3 Press **▲/▼** to select desired option, then press **ENTER**.
  - Some discs may not work Disc Navigator.
  - Depending on a disc, you can select Title, Chapter, or both.
- 4 Press **▲/▼/◀/▶** or **Number Buttons (0-9)** to select Title or Chapter then press **ENTER**.
  - Press **◀◀** or **▶▶** to move previous/next page.
  - Press **RETURN** to go to previous step.



### Playing a file

- 1 Press **SETUP** during stop mode.  
HOME MENU will appear.
- 2 Press **▲/▼/◀/▶** to select "Disc Navigator", then press **ENTER**.
- 3 Press **▲/▼** to select folder, then press **ENTER**.

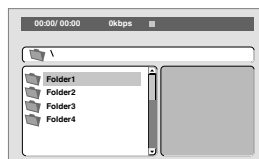

- 4 Press **▲/▼** to select file, then press **ENTER**.
  - If you select JPEG file, unit shows the pictures one after another automatically.
  - Press **RETURN** to return to previous step screen.
  - Press **SETUP** to exit the menu.

### Note:

- When music files and JPEG files are recorded in one disc, you can play simultaneously. Please select the music file then select the JPEG file.

## Play mode

### A-B repeat playback

A-B repeat playback allows you to repeat selection between two selected points.

- 1 Press **PLAY MODE** during playback. Play Mode screen will appear.

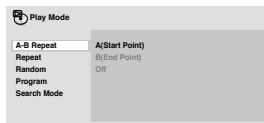

- 2 Press **▲/▼** to select "A-B Repeat", then press **▶** or **ENTER**.
- 3 Press **▲/▼** to select "A(Start Point)", then press **ENTER**. The start point is selected.
- 4 Press **▲/▼** to select "B(End Point)", then press **ENTER**. The end point is selected. Playback starts at the point that you selected. Playback stops at the end point and returns to Point A automatically, then starts again.

### To resume normal playback

Select "Off" in step 3.

#### Note:

- Some discs may not work Play mode function.
- A-B Repeat playback does not work with MP3/WMA CD.

### Repeat playback

- 1 Press **PLAY MODE** during playback. Play Mode screen will appear.
- 2 Press **▲/▼** to select "Repeat", then press **▶** or **ENTER**.
- 3 Press **▲/▼** to select desired repeat option, then press **ENTER**. The unit automatically starts repeat playback after finishing the current title or chapter.

### To resume normal playback

Select "Repeat Off" in step 3.

#### Note:

Some discs may not work with the repeat operation.

### Random playback

- 1 Press **PLAY MODE** during playback. Play Mode screen will appear.
- 2 Press **▲/▼** to select "Random", then press **▶** or **ENTER**.
- 3 Press **▲/▼** to select desired random playback option, then press **ENTER**. The unit automatically starts random playback.

### To resume normal playback

Select "Random Off" in step 3.

#### Note:

- During Random playback, it may repeat the same title, chapter or track.
- In stop mode, you can also enter Play Mode screen by selecting "Play Mode" in HOME MENU.

## Program playback

- 1 Press **PLAY MODE** during playback. Play Mode screen will appear.
- 2 Press **▲/▼** to select "Program", then press **▶** or **ENTER**.
- 3 Press **▲/▼** to select "Create/Edit", then press **ENTER**. "Create/Edit" display differs, depending on discs or files.
- 4 Press **▲/▼/◀▶** to select Title, Chapter, Track or File, then press **ENTER**.
  - When you add a program, find where you want to add it (Program Step) and select Title, Chapter or Track then press **ENTER**. (It will be added to the bottom if File is added.)
  - To go to previous step, press **RETURN**.
  - To delete a program, select Program Step that you want to delete and press **CANCEL**.

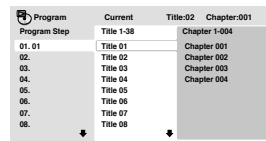

- 5 Press **PLAY (▶)**.
  - To play existing programmed contents, select "Playback Start" from Play Mode screen and press **ENTER**.
  - To delete all programmed contents, select "Program Delete" in Play Mode screen and press **ENTER**.

#### Note:

- You can repeat the programmed contents. Select "Program Repeat" from "Repeat" in the Play Mode screen during Program playback.
- In stop mode, you can also enter Play Mode screen by selecting "Play Mode" in HOME MENU.

## Locating desired scene

- 1 Press **PLAY MODE** during playback. Play Mode screen will appear.
- 2 Press **▲/▼** to select "Search Mode", then press **▶** or **ENTER**.
- 3 Press **▲/▼** to select desired search mode option, then press **▶** or **ENTER**.
  - Search Mode options differs, depending on discs or files.
- 4 Input Title, Chapter, Track or Folder number or time by using **Number buttons (0-9)** and press **ENTER**.
  - For instance, if you want to enter 1hr 4min (64:00), input 6, 4, 0, 0.

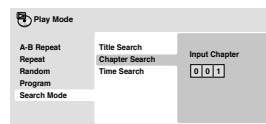

#### Note:

- You can locate desired scene in Menu screen for some DVD video.
- In stop mode, you can also enter Play Mode screen by selecting "Play Mode" in HOME MENU.

## Audio Settings menu

The Audio Settings menu offers features for adjusting the way discs sound.

1 Press **SETUP** during stop mode. HOME MENU will appear.

2 Press **▲/▼/◀/▶** to select "Audio Settings", then press **ENTER**.



3 Press **▲/▼/◀/▶** to setting the option, then press **ENTER**.

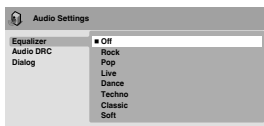

4 Press **SETUP** to save the setting.

### Equalizer

Select the most suitable setting to match a category of music that you are listening to.

### Audio DRC

- Loud sound level goes down and quiet sound level goes up while playing. This is useful, for instance, when you watch a film in the late night.
- It only works with Dolby Digital Sound.
- The effect depends on your AV amplifier and speakers volume. Adjust the sound as you wish and find the most effective setting.

### Dialog

Adjust setting when you cannot hear dialogs very well.

### Note

- It may not be very effective for some discs or files.

## Video Adjust menu

From the Video Adjust menu you can adjust various settings that affect how the picture is presented.

1 Press **SETUP** during stop mode. HOME MENU will appear.

2 Press **▲/▼/◀/▶** to select "Video Adjust", then press **ENTER**.



3 Press **▲/▼/◀/▶** to setting the option, then press **ENTER**.

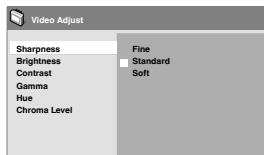

4 Press **SETUP** to save the setting.

### Sharpness

Adjust sharpness of images.

### Brightness

Adjust brightness of images.

### Contrast

Adjust a ratio of brightness between the brightest part and the darkest part.

### Gamma

Emphasize dark part of images.

### Hue

Adjust a balance between green and red.

### Chroma Level

Adjust color density. It is effective with animation or something with high color density.

### Note

- It may not be very effective for some discs or files.

## Customizing The Function Settings

You can change the default settings to customize performance to your preference.

### Setting procedure

1 Press **SETUP** in stop mode. HOME MENU will appear.

2 Press **▲/▼/◀/▶** to select "Initial Settings", then press **ENTER**.



3 Press **▲/▼/◀/▶** to select the desired option, then press **ENTER**.

4 Change the selection using **▲/▼/◀/▶** or **ENTER**, by referring to the corresponding page 32.

- Repeat steps 3 and 4 to change other option.

5 To clear HOME MENU screen, press **SETUP**.

## Customizing The Function Settings

Setting	Option	Setup hint
<b>Digital Audio Out settings</b>		
Digital Out	On	Digital audio is output when playing a disc.
	Off	Digital audio is not output when playing a disc.
Dolby Digital Out	Dolby Digital	Dolby Digital encoded digital audio is output when playing a Dolby Digital DVD disc.
	Dolby Digital > PCM	Dolby Digital audio is converted to PCM audio before being output.
DTS Out	DTS	DTS encoded digital audio is output when playing a DTS disc. (Noise will be output if your amplifier/receiver is not compatible with DTS audio.)
	Off	DTS encoded digital audio is not output when playing a DTS disc.
96kHz PCM Out	96kHz > 48kHz	96 kHz digital audio is converted to 48 kHz for digital output.
	96kHz	96 kHz digital audio is output as is at 96 kHz.
MPEG Out	MPEG	MPEG encoded digital audio is output as is.
	MPEG > PCM	MPEG encoded digital audio is converted to PCM audio for digital output.
<b>Video Output settings</b>		
TV Screen	4:3 (Letter Box)	Set Picture Size to Natural. Widescreen movies are shown with black bars top and bottom.
	4:3 (Pan & Scan)	Set Picture Size to Natural. Widescreen movies are shown with the sides cropped so that the image fills the screen.
	16:9 (Wide)	Set if you have a widescreen TV.
NTSC Out	NTSC	Display the picture of NTSC discs as NTSC-TV system.
	NTSC > PAL	Display the picture of NTSC discs converting to PAL-TV system.
<b>Language settings</b>		
Audio Language	English	If there is an English soundtrack on the disc then it will be played.
	Languages as displayed	If there is the language selected on the disc, then it will be played.
	Other Language	Select to choose a language other than the ones displayed. (see Language Code List on page 34)
Subtitle Language	English	If there is an English subtitle on the disc, then it will be displayed.
	Languages as displayed	If there is the subtitle language selected on the disc, then it will be displayed.
	Other Language	Select to choose a language other than the ones displayed. (see Language Code List on page 34)
DVD Menu Lang.	w/Subtitle Lang.	DVD disc menus will be displayed in the same language as your selected subtitle language, if possible.
	Languages as displayed	DVD disc menus will be displayed in the selected language, if possible.
	Other Language	Select to choose a language other than the ones displayed. (see Language Code List on page 34)
Subtitle Display	On	Subtitles are displayed according to your selected subtitle language (see above).
	Off	Subtitles are always off by default when you play a DVD disc (note that some discs override this setting).
<b>Display settings</b>		
OSD Language		On-screen displays are shown in the language selected.
Angle Indicator	On	A camera icon is displayed on-screen during multi-angle scenes on a DVD disc.
	Off	No multi-angle indication is shown.
<b>Options settings</b>		
Parental Lock		See page 33.



## Parental Control

Some discs are specified as not suitable for children. Such discs can be limited not to playback with the unit.

### How to into the Parental menu

- 1 Press **SETUP** in stop mode. HOME MENU will appear.
- 2 Press **▲/▼/◀/▶** to select "Initial Settings", then press **ENTER**.
- 3 Press **▲/▼** to select "Options", then press **▶**. Then press **▶** to enter the Parental Lock menu.



### Set Password

- 1 Press **▲** or **▼** to select "Password", then press **ENTER**.

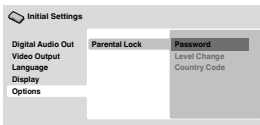

- 2 Press **Number buttons (0-9)** to input the password, then press **ENTER**.

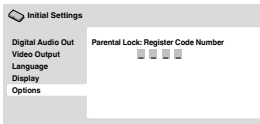

### Change Password

- 1 Press **▲** or **▼** to select "Password Change", then press **ENTER**.

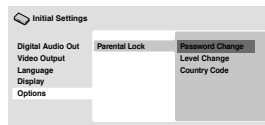

- 2 Press **Number buttons (0-9)** to input the current password, then press **ENTER**.

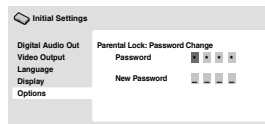

- 3 Press **Number buttons (0-9)** to input the new password. Press **ENTER**. Now your new password has been set. Be sure to remember this number!

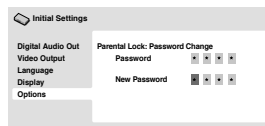

## Level Change

- 1 Press **▲** or **▼** to select "Level Change", then press **ENTER**.

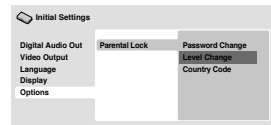

- 2 Press **Number buttons (0-9)** to input the current password, then press **ENTER**.

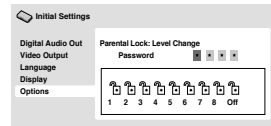

- 3 Press **◀** or **▶** to select from the level 1 to level 8. The limitation will be more severe as the level number is lower. Then press **ENTER**.

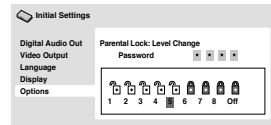

- Level 1:** DVD software for adults cannot be played back.
- Level 8:** Virtually all DVD software can be played back.
- Level Off:** The parental control setting does not function.

## Country Code

- 1 Press **▲** or **▼** to select "Country Code", then press **ENTER**.

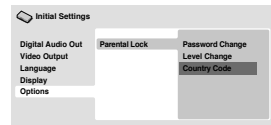

- 2 Press **Number buttons (0-9)** to input the current password, then press **ENTER**.

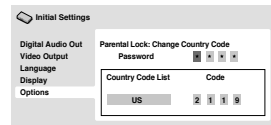

- 3 Press **▲** or **▼** to select the input mode from "Country Code List" or "Code".

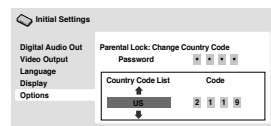

- When you selected "Country Code List": Press **▲** or **▼** to select Country Code, then press **ENTER**.
- When you selected "Code": Press **▶** then use the **Number buttons (0-9)** to enter the 4-digit Country Code. Press **ENTER**. (see Country/Area Code List on page 34)

### Note:

- Depending on the discs, the unit cannot limit playback.
- Some discs may not be encoded with specific rating level information though its disc jacket says "adult." For those discs, the age restriction will not work.
- If you input a wrong number, press **◀**, then input correct number.

## Language Code List

Language (Language code letter), **Language code**

Japanese (ja), <b>1001</b>	Bhutani (dz), <b>0426</b>	Kirghiz (ky), <b>1125</b>	Sinhalese (si), <b>1909</b>
English (en), <b>0514</b>	Esperanto (eo), <b>0515</b>	Latin (la), <b>1201</b>	Slovak (sk), <b>1911</b>
French (fr), <b>0618</b>	Estonian (et), <b>0520</b>	Lingala (ln), <b>1214</b>	Slovenian (sl), <b>1912</b>
German (de), <b>0405</b>	Basque (eu), <b>0521</b>	Laothian (lo), <b>1215</b>	Samoa (sm), <b>1913</b>
Italian (it), <b>0920</b>	Persian (fa), <b>0601</b>	Lithuanian (lt), <b>1220</b>	Shona (sn), <b>1914</b>
Spanish (es), <b>0519</b>	Finnish (fi), <b>0609</b>	Latvian (lv), <b>1222</b>	Somali (so), <b>1915</b>
Chinese (zh), <b>2608</b>	Fiji (fj), <b>0610</b>	Malagasy (mg), <b>1307</b>	Albanian (sq), <b>1917</b>
Dutch (nl), <b>1412</b>	Faroese (fo), <b>0615</b>	Maori (mi), <b>1309</b>	Serbian (sr), <b>1918</b>
Portuguese (pt), <b>1620</b>	Frisian (fy), <b>0625</b>	Macedonian (mk), <b>1311</b>	Siswati (ss), <b>1919</b>
Swedish (sv), <b>1922</b>	Irish (ga), <b>0701</b>	Malayalam (ml), <b>1312</b>	Sesotho (st), <b>1920</b>
Russian (ru), <b>1821</b>	Scots-Gaelic (gd), <b>0704</b>	Mongolian (mn), <b>1314</b>	Sundanese (su), <b>1921</b>
Korean (ko), <b>1115</b>	Galician (gl), <b>0712</b>	Moldavian (mo), <b>1315</b>	Swahili (sw), <b>1923</b>
Greek (el), <b>0512</b>	Guarani (gn), <b>0714</b>	Marathi (mr), <b>1318</b>	Tamil (ta), <b>2001</b>
Afar (aa), <b>0101</b>	Gujarati (gu), <b>0721</b>	Malay (ms), <b>1319</b>	Telugu (te), <b>2005</b>
Abkhazian (ab), <b>0102</b>	Hausa (ha), <b>0801</b>	Maltese (mt), <b>1320</b>	Tajik (tg), <b>2007</b>
Afrikaans (af), <b>0106</b>	Hindi (hi), <b>0809</b>	Burmese (my), <b>1325</b>	Thai (th), <b>2008</b>
Amharic (am), <b>0113</b>	Croatian (hr), <b>0818</b>	Nauru (na), <b>1401</b>	Tigrinya (ti), <b>2009</b>
Arabic (ar), <b>0118</b>	Hungarian (hu), <b>0821</b>	Nepali (ne), <b>1405</b>	Turkmen (tk), <b>2011</b>
Assamese (as), <b>0119</b>	Armenian (hy), <b>0825</b>	Norwegian (no), <b>1415</b>	Tagalog (tl), <b>2012</b>
Aymara (ay), <b>0125</b>	Interlingua (ia), <b>0901</b>	Occitan (oc), <b>1503</b>	Setswana (tn), <b>2014</b>
Azerbaijani (az), <b>0126</b>	Interlingue (ie), <b>0905</b>	Oromo (om), <b>1513</b>	Tonga (to), <b>2015</b>
Bashkir (ba), <b>0201</b>	Inupiak (ik), <b>0911</b>	Oriya (or), <b>1518</b>	Turkish (tr), <b>2018</b>
Byelorussian (be), <b>0205</b>	Indonesian (in), <b>0914</b>	Panjabi (pa), <b>1601</b>	Tsonga (ts), <b>2019</b>
Bulgarian (bg), <b>0207</b>	Icelandic (is), <b>0919</b>	Polish (pl), <b>1612</b>	Tatar (tt), <b>2020</b>
Bihari (bh), <b>0208</b>	Hebrew (iw), <b>0923</b>	Pashto, Pushto (ps), <b>1619</b>	Twi (tw), <b>2023</b>
Bislama (bi), <b>0209</b>	Yiddish (ji), <b>1009</b>	Quechua (qu), <b>1721</b>	Ukrainian (uk), <b>2111</b>
Bengali (bn), <b>0214</b>	Javanese (jw), <b>1023</b>	Rhaeto-Romance (rm), <b>1813</b>	Urdu (ur), <b>2118</b>
Tibetan (bo), <b>0215</b>	Georgian (ka), <b>1101</b>	Kirundi (rn), <b>1814</b>	Uzbek (uz), <b>2126</b>
Breton (br), <b>0218</b>	Kazakh (kk), <b>1111</b>	Romanian (ro), <b>1815</b>	Vietnamese (vi), <b>2209</b>
Catalan (ca), <b>0301</b>	Greenlandic (kl), <b>1112</b>	Kinyarwanda (rw), <b>1823</b>	Volapük (vo), <b>2215</b>
Corsican (co), <b>0315</b>	Cambodian (km), <b>1113</b>	Sanskrit (sa), <b>1901</b>	Wolof (wo), <b>2315</b>
Czech (cs), <b>0319</b>	Kannada (kn), <b>1114</b>	Sindhi (sd), <b>1904</b>	Xhosa (xh), <b>2408</b>
Welsh (cy), <b>0325</b>	Kashmiri (ks), <b>1119</b>	Sangho (sg), <b>1907</b>	Yoruba (yo), <b>2515</b>
Danish (da), <b>0401</b>	Kurdish (ku), <b>1121</b>	Serbo-Croatian (sh), <b>1908</b>	Zulu (zu), <b>2621</b>

## Country/Area Code List

Country/Area, **Country/Area code**, **Country/Area code letter**

Argentina, <b>0118, ar</b>	Finland, <b>0609, fi</b>	Malaysia, <b>1325, my</b>	Singapore, <b>1907, sg</b>
Australia, <b>0121, au</b>	France, <b>0618, fr</b>	Mexico, <b>1324, mx</b>	Spain, <b>0519, es</b>
Austria, <b>0120, at</b>	Germany, <b>0405, de</b>	Netherlands, <b>1412, nl</b>	Sweden, <b>1905, se</b>
Belgium, <b>0205, be</b>	Hong Kong, <b>0811, hk</b>	New Zealand, <b>1426, nz</b>	Switzerland, <b>0308, ch</b>
Brazil, <b>0218, br</b>	India, <b>0914, in</b>	Norway, <b>1415, no</b>	Taiwan, <b>2023, tw</b>
Canada, <b>0301, ca</b>	Indonesia, <b>0904, id</b>	Pakistan, <b>1611, pk</b>	Thailand, <b>2008, th</b>
Chile, <b>0312, cl</b>	Italy, <b>0920, it</b>	Philippines, <b>1608, ph</b>	United Kingdom, <b>0702, gb</b>
China, <b>0314, cn</b>	Japan, <b>1016, jp</b>	Portugal, <b>1620, pt</b>	USA, <b>2119, us</b>
Denmark, <b>0411, dk</b>	Republic of Korea, <b>1118, kr</b>	Russian Federation, <b>1821, ru</b>	

## PC connection

Follow these steps: On your PC monitor choose a resolution of 1920 × 1080 at 60Hz and save this configuration. Shut down your PC and connect the shut off LCD TV. Use a screensaver to avoid burning-in of static picture content.

### Select PC input

Switch on the LCD-TV.

Select the PC input mode (see page 11).

Supported PC resolutions	
resolution	fps (Hz)
640x480	60
800x600	60
1024x768	60
1280x720	60
1280x768	60
1360x768	60
1280x1024	60
1440x900	60
1920x1080	60

Use a PC-VGA cable (not supplied) to connect the LCD-Monitor to your PC. Make the connections carefully so as not to break or bend the contacts inside the plug.

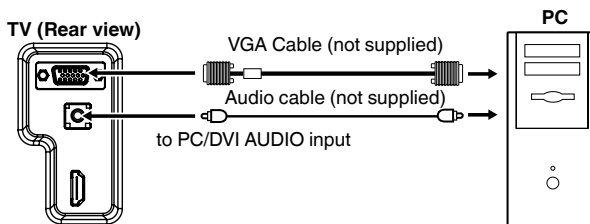

#### Note:

- If no signal or a signal with a non-supported resolution is connected, No Signal is displayed
- As this LCD-TV is not a PC monitor correct display cannot be guaranteed for every PC / graphics card.

## Connecting an HDMI or a DVI device to the HDMI input

The HDMI input receives digital audio and uncompressed video from a HDMI equipped device or uncompressed digital video from a DVI equipped device. When you connect to a DVI device with a HDMI-to-DVI adapter cable, it only transfers the video signal, so it is necessary to use separate analogue leads to transfer the audio signals. Select the HDMI input mode (see P.11).

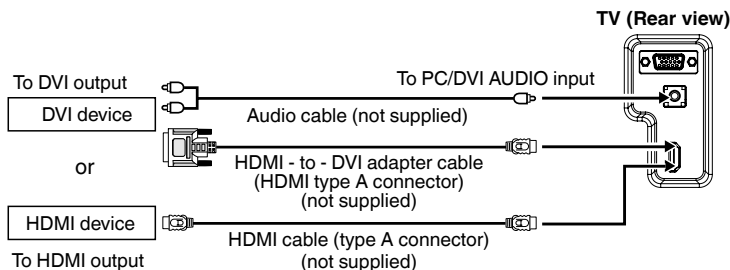

#### Note:

- Please notice the operating manual for the HDMI device to be set up.

## Connection to other equipment

### Attention: Preparation:

- Disconnect all equipment from the AC-supply, to prevent any possible damage.
- Make the necessary connections.
- Make sure all connections are safe & secure before reconnecting your equipment the AC-supply.

#### Note:

- Select an appropriate external input mode. (See page 11).

### 1. Connecting a Video camera or Games console to AV

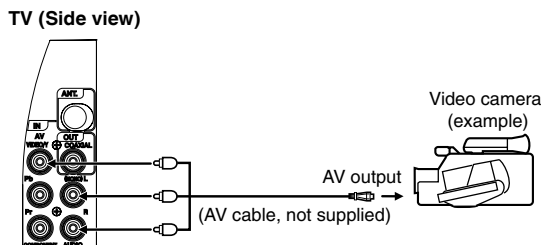

## Connection to other equipment

### 2. Connecting to other equipment

Please connect your satellite-receiver or DVD player via SCART. Make sure your SCART cable's cross-section is at least 1 cm or more. SCART cables with less thickness may cause visible noise.

Please make the following settings inside your receiver's / DVD-player's setup-menu:

Video signal: RGB

TV-Format: 16:9

If you miss to make these settings properly, picture quality will be inferior and parts of the picture might be missing. This is not a fault of this TV-set.

In case you need help to make this adjustment with your satellite-receiver / DVD-player, please consult the related instructions or contact the supplier or maker of those apparatus for support.

Please use the satellite's remote-control handset to select Teletext or desired TV-station. Generally it is not possible to store satellite TV-stations into a standard TV.

If the TV does not automatically switch to SCART, please select INPUT SCART manually, as seen on page 11.

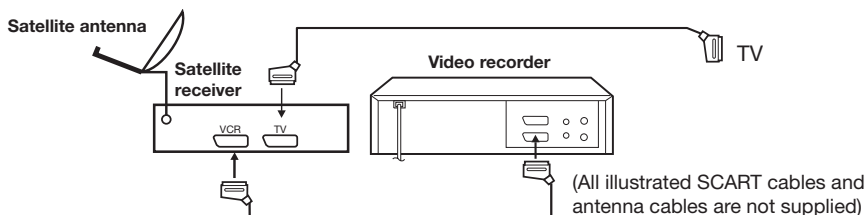

### 3. Connection of a digital amplifier or digital A/V receivers (with DTS or Dolby Digital Decoder)

DTS and Dolby Digital are two different systems. DTS-DVDs cannot be played with a Dolby Digital receiver. Please use in this case a decoder that matches your DVDs.

- After connecting a Dolby Digital decoder please select in the DVD menu the Dolby Digital sound track option.
- When a DTS sound track is played the integrated loudspeakers are mute. The DTS sound can only be played digitally using the digital outlet. For hearing a DTS decoder is necessary.
- Digital audio output is active only when receiving DVB-T, not when receiving analog cable TV broadcasting.

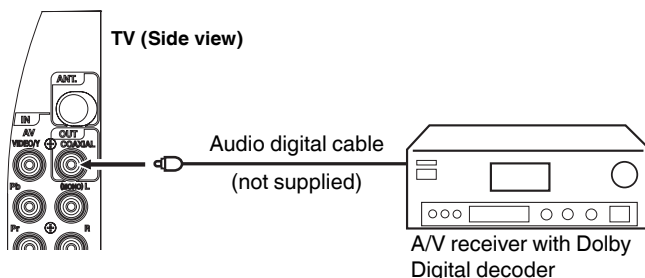

### 4. Connecting to a DVD player or other AV device with Component Video outputs

If your DVD player (or other device) has Component Video output jacks, use a suitable set of leads (RCA/Phono) to connect these to the Component Video inputs on this TV as shown - it can greatly enhance the picture quality and performance. Please remember that you will also need to connect separate leads (RCA/Phono) for the audio signals.

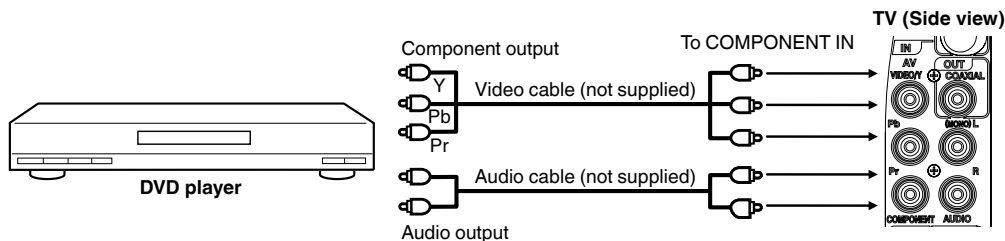

#### Note:

- The Component Video input of this unit are for use with equipment which outputs interlaced signals (PAL: 576i/1080i or NTSC: 480i/1080i) and progressive signals (PAL: 576p/720p or NTSC: 480p/720p).

## Troubleshooting table

Please check the following list before requesting service.

Symptom	Possible solution	Page
<b>TV</b>		
No picture, no sound	Switch on the set.	7
	Check that the mains power outlet is properly connected. Select appropriate input mode. Unplug unit for 1 minute, then plug it back in.	11
No reception	Have you tuned in the TV stations? Press <b>1</b> on the remote control.	10 11
	Connect the antenna. Make sure the set is ON and not in Standby mode	
The TV switches off with missing antenna input signal	This is normal. 15 minutes after the antenna signal has disappeared, the set will change to standby mode.	14
The Channel option cannot be selected.	The unit is set to AV mode. Press <b>1</b> on the remote control.	12
Wrong Colours	Colour and Brightness errors can occur when the viewing angle/ambient air temperature (see technical specifications) are exceeded.	
While viewing a DVB (digital) channel, there is sound but no picture.	Some channel offers audio content only. It is normal.	
Blocky image or image stops intermittently.	Check all antenna connections. Move the antenna away from areas of possible interference. Try using an antenna booster.	10
Some digital channels cannot be viewed.	Contact the service provider to subscribe.	
No colour or picture black.	SCART input set to Auto.	21
A cracking sound is sometimes heard from the unit.	If there is nothing wrong with the picture or sound, this is the sound of the cabinet undergoing very slight contractions in response to changes in the room temperature. There are no adverse effects on the performance or other aspects.	
<b>DVD</b>		
The playback picture has occasional distortion.	The disc is dirty. Eject the disc and clean it. Some times a small amount of picture distortion may appear. This is not a malfunction.	25
The unit does not start playback.	No disc is inserted. Insert a disc.	27
	An unplayable disc is inserted. Insert a playable disc (Check the disc type and colour system).	25
	Place the disc in the disc slot with the label side facing forward.	27
	The disc is dirty. Clean the disc.	25
	Cancel the parental lock function or change the parental lock level.	33

- The LCD panel is a very high technology product, giving you fine picture details. Occasionally, a few nonactive pixels may appear on the screen as a fixed point of blue, green or red. Please note that this does not affect the performance of your product.

## License information

- \* The “HD ready” Logo and “1080p” qualifier Logo are trademarks of DIGITALEUROPE.
- \* This item incorporates copy protection technology that is protected by U.S. patents and other intellectual property rights of Rovi Corporation. Reverse engineering and disassembly are prohibited.
- \* Manufactured under license from Dolby Laboratories. Dolby and the double-D symbol are trademarks of Dolby Laboratories.
- \* **DVD** is a trademark of DVD Format/Logo Licensing Corporation.
- \* This product is protected by certain intellectual property rights of Microsoft. Use or distribution of such technology outside of this product is prohibited without a license from Microsoft.
- \* DVB and the DVB logos are trademarks of the DVB Project.
- \* THIS PRODUCT IS LICENSED UNDER THE AVC PATENT PORTFOLIO LICENSE FOR THE PERSONAL USE OF A CONSUMER OR OTHER USES IN WHICH IT DOES NOT RECEIVE REMUNERATION TO (i) ENCODE VIDEO IN COMPLIANCE WITH THE AVC STANDARD (“AVC VIDEO”) AND/OR (ii) DECODE AVC VIDEO THAT WAS ENCODED BY A CONSUMER ENGAGED IN A PERSONAL ACTIVITY AND/OR WAS OBTAINED FROM A VIDEO PROVIDER LICENSED TO PROVIDE AVC VIDEO. NO LICENSE IS GRANTED OR SHALL BE IMPLIED FOR ANY OTHER USE. ADDITIONAL INFORMATION MAY BE OBTAINED FROM MPEG LA, L.L.C. SEE [HTTP://WWW.MPEGLA.COM](http://www.mpegla.com)
- \* HDMI, the HDMI Logo, and High-Definition Multimedia Interface are trademarks or registered trademarks of HDMI Licensing LLC in the United States and other countries.

Equipment connected to the protective earthing of the building installation through the mains connection or through other equipment with a connection to protective earthing – and to a cable distribution system using coaxial cable, may in some circumstances create a fire hazard. Connection to a cable distribution system has therefore to be provided through a device providing electrical isolation below a certain frequency range.

Utstyr som er koplet til beskyttelsesjord via nettplugg og/eller via annet jordtilkoplede utstyr – og er tilkoplede et kabel-TV nett, kan forårsake brannfare.

For å unngå dette skal det ved tilkopling av utstyret til kabel-TV nettet installeres en galvanisk isolator mellom utstyret og kabel-TV nettet.

Utrustning som är kopplad till skyddsjord via jordat vägguttag och/eller via annan utrustning och samtidigt är kopplad till kabel-TV nät kan i vissa fall medföra risk för brand.

För att undvika detta skall vid anslutning av utrustningen till kabel-TV nät galvanisk isolator finnas mellan utrustningen och kabel-TV nätet.

## Information on software license

The following open source software component is included in this product:

- \* Posix Compatibility Layer  
Portions of this software is  
CYGPKG\_POSIX Copyright © 1990, 1999 The Regents of the University of California.  
All rights reserved.
- \* MIPS HAL  
Portions of this software is  
CYGPKG\_HAL\_MIPS Copyright © 1992 The Regents of the University of California.  
All rights reserved.
- \* Standard C Library  
Portions of this software are  
CYGPKG\_LIBC\_STDIO Copyright © 1990 The Regents of the University of California.  
CYGPKG\_LIBC\_STDLIB Copyright © 1990, 1992, 1993 The Regents of the University of California.  
CYGPKG\_LIBC\_STRING Copyright © 1988 Regents of the University of California.  
CYGPKG\_LIBC\_TIME Copyright © 1999 Kungliga Tekniska Hogskolan (Royal Institute of  
Technology, Stockholm, Sweden).  
All rights reserved.

## Specifications

	LT-22HD32J/LT-22HD3WJ	LT-24HD32J
<b>TV</b>		
System:	Analogue: PAL (B/G, D/K, I), SECAM (B/G, D/K) Digital: DVB-T, DVB-T HD (H.264), DVB-C, DVB-C HD (H.264)	
Video Colour System:	PAL/SECAM/NTSC 3.58/NTSC 4.43/PAL 60	
Preset channels:	Digital 1200 Service, Analog 100 Carrier	
Frequency Range:	Analogue: 45.75~858MHz Digital: E2~E69	
LCD:	TFT low-glass Active Matrix Colour LCD	
HDMI input:	HDMI compliant (type A connector), HDCP compliant Suggested scan rates: 50Hz: 576i/576p/720p/1080i/1080p 60Hz: 480i/480p/720p/1080i/1080p 24Hz: 1080p HDMI Audio: 2-channel PCM, 32/44.1/48 kHz sampling frequency 16/20/24 bits per sample	
Audio Output Power:	2.0W (MAX) x 2	
<b>DVD</b>		
Signal system:	NTSC, PAL (Region 2)	
Applicable disc:	DVD (12cm), CD (12cm)	
Output:	Audio : (RCA) -12.0 dBm, 1 k Ω Digital Audio : 0.5Vp-p/75 Ω	
Pickup:	CD : Wavelength: 775 - 815 nm Maximum output power: 0.5 mW DVD : Wavelength: 650 - 666 nm Maximum output power: 2.0 mW	
<b>GENERAL</b>		
Power Source:	AC 220-240V, 50Hz	
Energy efficiency class:	B	
Visible screen size (diagonal):	55 cm/22 inch	60 cm/24 inch
Power Consumption (Rating):	39 W	43 W
Power Consumption in on mode:	29 W	35 W
Energy consumption per year <sup>1</sup> :	42 kWh	51 kWh
Power Consumption in standby mode:	0.49W	
Screen resolution:	1.920 point (horizontal) x 1.080 line (vertical)	
Weight:	3.9 kg	4.9 kg
Dimensions:	54(W)x39(H)x17(D)cm	59(W)x44(H)x18(D)cm
Surrounding temperature:	Operation: 5°C ~ 40°C/Storage: -20°C ~ 60°C	
Operating Humidity:	Less than 80%RH	
<b>ACCESSORIES</b>		
2 batteries (AA/R6/UM-3)/Remote control unit/AC cord/Base plate/2 (LT-24...: x 3) screws for stand		

<sup>1</sup> Energy consumption per year, based on the power consumption of the television operating 4 hours per day for 365 days. The actual energy consumption will depend on how the television is used.

Weight and Dimensions are approximate. Because we continuously strive to improve our products we may change specifications and designs without prior notice.

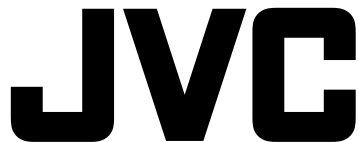

**JVC has assigned the service and in warranty responsibility to Kesa Electricals plc.**

FOR CUSTOMER SERVICE, ADDITIONAL SET-UP AND OPERATING ASSISTANCE, OR TO ORDER ACCESSORIES PLEASE CALL:

Country	Sales Company	Tel	URL Main	Service Contact
UK	COMET	0844 8009595	<a href="http://www.comet.co.uk">http://www.comet.co.uk</a>	-
France	DARTY	0978970970	<a href="http://www.darty.com/">http://www.darty.com/</a>	-
Spain	EMH	-	<a href="http://www.emh.es/">http://www.emh.es/</a>	<a href="mailto:pedidosweb@emh.es">pedidosweb@emh.es</a>
Belgium	NVB	02/334.00.00	<a href="http://www.vandenborre.be/">http://www.vandenborre.be/</a>	<a href="mailto:service@vandenborre.be">service@vandenborre.be</a>
Netherlands	BCC	0900-0555	<a href="http://www.bcc.nl/">http://www.bcc.nl/</a>	<a href="http://www.bcc.nl/info/contact">http://www.bcc.nl/info/contact</a>
Italy	DARTY IT	800928884	<a href="http://www.darty.it/">http://www.darty.it/</a>	<a href="mailto:scrivici@darty.it">scrivici@darty.it</a>
Czech	DATART	810 328 278	<a href="http://www.datart.cz/">http://www.datart.cz/</a>	<a href="mailto:infolinka@datart.cz">infolinka@datart.cz</a>

**WHEN CALLING CUSTOMER SERVICE - PLEASE HAVE YOUR MODEL NUMBER READY**

KESA Electricals © UK HU1 3AU



J57W0201A SH 11/09

0911STH-OR-OR