

JVC®

LCD Television INSTRUCTIONS DIRECTIVES de la télévision ACL

LT-32P510

32" class (31.5" Diagonal) / catégorie 32 po (31,5 po en diagonale)

LT-42P510 LT-42PM51

42" class (42" Diagonal) / catégorie 42 po (42 po en diagonale)

LT-46P510 LT-46PM51

46" class (45.9" Diagonal) / catégorie 46 po (45,9 po en diagonale)



As an "ENERGY STAR®" partner, JVC has determined that this product or product model meets the "ENERGY STAR®" guidelines for energy efficiency. Please read the important notice for energy efficiency on page 7.

Comme société « ENERGY STAR® », JVC a déterminé que ce produit ou modèle de produit est conforme aux directives « ENERGY STAR® » pour le rendement énergétique. Veuillez lire l'avis important d'efficacité énergétique à la page 7.

Important Note:

In the spaces below, enter the model and serial number of your television (located at the rear of the television cabinet). Staple your sales receipt or invoice to the inside cover of this guide. Keep this user's guide in a convenient place for future reference. Keep the carton and original packaging for future use.

Information importante pour l'utilisateur :

Veillez inscrire dans l'espace ci-dessous le numéro de série de votre téléviseur (situé à l'arrière du téléviseur). Agrafez votre reçu ou votre facture à la couverture, à l'intérieur de ce guide. Rangez ce manuel dans un lieu où vous pourrez le retrouver rapidement pour vous y référer. Gardez le carton et l'emballage d'origine pour une utilisation ultérieure.



Model Number:
Numéro de modèle:

Serial Number:
Numéro de série:

English

Français

Warnings

	CAUTION RISK OF ELECTRIC SHOCK DO NOT OPEN	
CAUTION: To reduce the risk of electric shock. Do not remove cover (or back). No user serviceable parts inside. Refer servicing to qualified service personnel.		



The lightning flash with arrowhead symbol, within an equilateral triangle is intended to alert the user to the presence of uninsulated "dangerous voltage" within the product's enclosure that may be of sufficient magnitude to constitute a risk of electric shock to persons.



The exclamation point within an equilateral triangle is intended to alert the user to the presence of important operating and maintenance (servicing) instructions in the literature accompanying the appliance.

WARNING: TO PREVENT FIRE OR SHOCK HAZARDS, DO NOT EXPOSE THIS APPARATUS TO RAIN OR MOISTURE.

CAUTION: TO INSURE PERSONAL SAFETY, OBSERVE THE FOLLOWING RULES REGARDING THE USE OF THIS UNIT.

1. Operate only from the power source specified on the unit.
2. Avoid damaging the AC plug and power cord.
3. Avoid improper installation and never position the unit where good ventilation is unattainable.
4. Do not allow objects or liquid into the cabinet openings.
5. In the event of trouble, unplug the unit and call a service technician. Do not attempt to repair it yourself or remove the rear cover.

Changes or modifications not approved by JVC could void the warranty.

- * When you don't use this TV set for a long period of time, be sure to disconnect both the power plug from the AC outlet and antenna for your safety.
- * To prevent electric shock do not use this polarized plug with an extension cord, receptacle or other outlet unless the blades can be fully inserted to prevent blade exposure.

IMPORTANT RECYCLING INFORMATION

This product has a fluorescent lamp that contains mercury. Disposal of these materials may be regulated in your community due to environmental considerations. For disposal or recycling information, please contact your local authorities or for USA, the Electronic Industries Alliance: <http://www.eiae.org>

Do not attempt to service the product yourself

Caution

To prevent electrical shock, do not open the cabinet.

There are no user serviceable parts inside.

Please refer to qualified service personnel for repairs.

Important Safety Instructions

- 1) Read these instructions.
- 2) Keep these instructions.
- 3) Heed all warnings.
- 4) Follow all instructions.
- 5) Do not use this apparatus near water.
- 6) Clean only with dry cloth.
- 7) Do not block any ventilation openings. Install in accordance with the manufacturer's instructions.
- 8) Do not install near any heat sources such as radiators, heat registers, stoves, or other apparatus (including amplifiers) that produce heat.
- 9) Do not defeat the safety purpose of the polarized or grounding-type plug. A polarized plug has two blades with one wider than the other. A grounding type plug has two blades and a third grounding prong. The wide blade or the third prong are provided for your safety. If the provided plug does not fit into your outlet, consult an electrician for replacement of the obsolete outlet.
- 10) Protect the power cord from being walked on or pinched particularly at plugs, convenience receptacles, and the point where they exit from the apparatus.
- 11) Only use attachments/accessories specified by the manufacturer.
- 12) Use only with a cart, stand, tripod, bracket, or table specified by the manufacturer, or sold with the apparatus. When a cart is used, use caution when moving the cart/apparatus combination to avoid injury from tip-over.
- 13) Unplug this apparatus during lightning storms or when unused for long periods of time.
- 14) Refer all servicing to qualified service personnel. Servicing is required when the apparatus has been damaged in any way, such as power-supply cord or plug is damaged, liquid has been spilled or objects have fallen into the apparatus, the apparatus has been exposed to rain or moisture, does not operate normally, or has been dropped.
- 15) Apparatus shall not be exposed to dripping or splashing and no objects filled with liquids, such as vases, shall be placed on the apparatus.
- 16) Place the television on a stable, flat surface. Failure to do so can result in the television falling, causing injury.
- 17) Do not allow young children to play around or on the television. Do not hang from the TV. Failure to do so can result in the television falling, causing injury.
- 18) Do not allow young children to play with the plastic bag that came with the television when you unpacked it. Failure to do so can result in suffocation, causing injury.
- 19) Avoid improper installation and never position the unit where good ventilation is impossible. When installing this TV, distance recommendations must be maintained between the set and the wall, as well as inside a tightly enclosed area or piece of furniture. Keep to the minimum distance guidelines shown for safe operation.

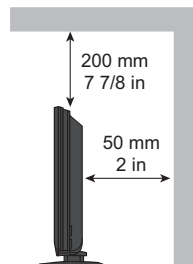
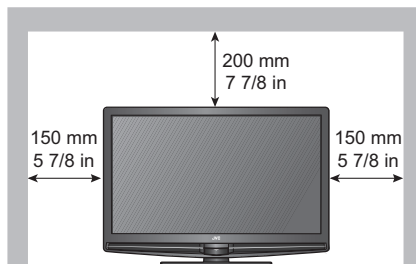

Important Safety Instructions

20) Cautions for installation

- Do not tilt the TV towards the left or right, or towards the back.
- Install the TV in a corner on the floor so as to keep cords out of the way.
- The TV will generate a slight amount of heat during operation. Ensure that sufficient space is available around the TV to allow satisfactory cooling.
- Have two people remove the TV from the box with the screen facing away from you. It's possible your clothing, (such as a belt buckle or button) may scratch the front of the TV. Do the same when moving the TV to another location.



21) When attaching to a wall, use the optional JVC wall mounting unit.

For LT-32P510: JVC-XUF-2637 LCD FLAT WALL MOUNT

For LT-42P510 / LT-42PM51: JVC-XUF-2637 LCD FLAT WALL MOUNT

For LT-46P510 / LT-46PM51: JVCPCM-MS2 TILT/FLAT WALL MOUNT

Caution

- Consult qualified installers.
 - See the included manual on mounting procedures.
 - JVC is not responsible for damages or injuries due to improper mounting.
 - Use with other wall mounting unit is capable of resulting in instability or causing possible injury.
- 22) Make enough room for inserting and removing the power plug. Place the TV as close to the outlet as possible. The main power supply for this TV is controlled by inserting or removing the power plug.
- 23) Batteries shall not be exposed to excessive heat such as sunshine, fire or the like.
- 24) When this TV is connected to the wall outlet, it is always on standby even when all the LED lamps are not lit. To shut down the TV, unplug the TV from the wall outlet.

FCC Notice:

Caution: Changes or modifications not expressly approved by party responsible for compliance could void the user's authority to operate the equipment.

Note: This equipment has been tested and found to comply with the limits for a Class B digital device, pursuant to Part 15 of the FCC Rules. These limits are designed to provide reasonable protection against harmful interference in a residential installation. This equipment generates, uses and can radiate radio frequency energy and, if not installed and used in accordance with the instructions, may cause harmful interference to radio communications. However, there is no guarantee that interference will not occur in a particular installation. If this equipment does cause harmful interference to radio or television reception, which can be determined by turning the equipment off and on, the user is encouraged to try to correct the interference by one or more of the following measures:

- Reorient or relocate the receiving antenna.
- Increase the separation between the equipment and receiver.
- Connect the equipment into an outlet on a circuit different from that to which the receiver is connected.
- Consult the dealer or an experienced radio/TV technician for help.

Table of Contents

Warnings	2
Important Safety Instructions. . .	3

Getting Started

Key Features	6
Logos & Licenses	7
Package Contents	8

Basic Operations

Basic TV Controls	13
Remote Control	18
Initial Setup	22

Advanced Operations

Customizing Your TV	24
Picture	26
Video Status	26
Color Temp	27
Color Management	27
Dynamic Gamma	27
Smart Picture	27
Digital VNR	27
MPEG NR	27
Natural Cinema	27
Video Reset	27

Display	28
Video Input Label	28
Media Player	28
Aspect	32

TV	33
Closed Caption	33
C.C. Type	33
C.C. Setting	33
Tuner Mode	34
Auto Scan	34
Add Channel	34
Edit Channel	35
V-Chip	35
Guide	39

PC	40
Auto Adjustment	40
Phase Adjustment	40
PC H-Position	40
PC V-Position	40
Reset	40

Sound	41
MTS	41
Digital Audio (ML)	41
Surround	41
Video-1 Audio	41
Sound Status	41
Audio Reset	41

Power	42
Power Indicator	42
Illumination	42

Setting	43
Plug in Menu	43
Time Zone	43
D.S.T.	43
Language	43
Noise Muting	43
Front Panel Lock	43
Transparency	43
Auto Shut Off	43
Control with HDMI	44
System Info	45
Auto Demo	45
Optical Out	45

Enjoy Movies/Music From Your iPod	46
---	----

Reference

Connecting Your Devices	53
Troubleshooting	59
Specifications	61

Key Features

Your JVC TV is equipped with many features. Here are some key features highlighted in detail.

- 1 Simple playback of video and music on a TV. You can charge your iPod. You can watch a program while listening to iPod. You can view photos from iPod while listening to iPod.



Dock Adapter
(supplied with iPod or separately purchased)

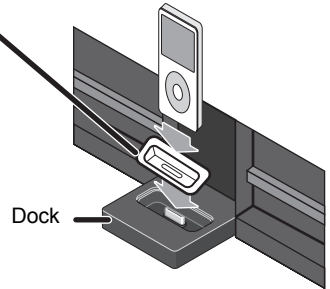

- 2 Stunning picture quality via the 1920x1080 Full HD panel. Dynamic Gamma and Color Management give further fine tuned picture reproduction. Smart Picture adjusts the best possible picture quality automatically scene by scene based on the incoming signal from any source!



- 3 JVC OmniSurround sound provides you with 4 different settings based on the program you are watching. The equalizer will fine tune your listening preferences.
- 4 Full connectivity with 3 HDMI, 1 Component, 1 S-video and others. The variety of connections are explained in pages 53 to 58.

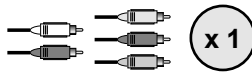

- 5 Aspect mode will show every pixel you are getting in High Definition. The Full Native mode will show 100% of 1080p. Full – with slight overscan. Panorama, Cinema will fill the screen with various aspect settings.



Full or Widescreen Mode

Logos & Licenses



As an "ENERGY STAR®" partner, JVC has determined that this product or product model meets the "ENERGY STAR®" guidelines for energy efficiency.

This JVC Television is factory set to "Home" mode, which is optimized for normal home viewing. This setting reduces power consumption to help the environment and to comply with ENERGY STAR® qualification.

Enabling certain features and functionality in this TV (e.g., Video Status) may increase its energy consumption, possibly beyond the limits required for ENERGY STAR® qualification.



- iPod is a trademark of Apple Inc., registered in the U.S. and other countries.
- "Made for iPod" means that an electronic accessory has been designed to connect specifically to iPod and has been certified by the developer to meet Apple performance standards.



- iPhone is a trademark of Apple Inc.
- "Works with iPhone" means that an electronic accessory has been designed to connect specifically to iPhone and has been certified by the developer to meet Apple performance standards.

Apple is not responsible for the operation of this device or its compliance with safety and regulatory standards.



Manufactured under license from Dolby Laboratories. "Dolby", and the double-D symbol are trademarks of Dolby Laboratories.



HDMI, the HDMI Logo and High-Definition Multimedia Interface are trademarks or registered trademarks of HDMI Licensing LLC.

Package Contents

Television x 1



Remote Control x 1



AAA Batteries x 2



Bottom Cover x 1

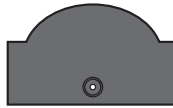

Screw x 1



Insert the batteries

Use two "AAA" batteries (included).

Place the "-" end in the unit first, making sure the "+" and "-" markings are correctly positioned.

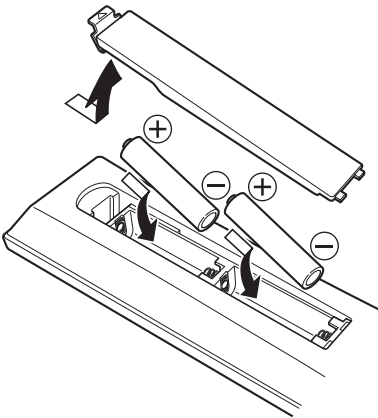

If this symbol is shown, it is only valid in the European union.

Caring for the frame and stand

Your TV has a glossy frame and stand which have protection sheets attached to them. Peel them off before use, but only after the TV has been properly placed. Take care when handling the glossy frame and stand because these surfaces are delicate.

Normally, light dusting with a soft, non-scratching duster will keep your TV clean. If you wish to wipe down the television, first unplug it. Then wipe gently with a soft cloth, slightly moistened with water. You can add a few drops of mild liquid detergent to the water to help remove spots of oily dirt.

- DO NOT allow liquid to enter the TV through the ventilation slots.
- DO NOT use strong or abrasive cleaners on the TV.
- DO NOT spray liquids or cleaners directly onto the TV's surface.
- DO NOT rub or scrub the TV harshly. Wipe the set gently with a soft cloth.

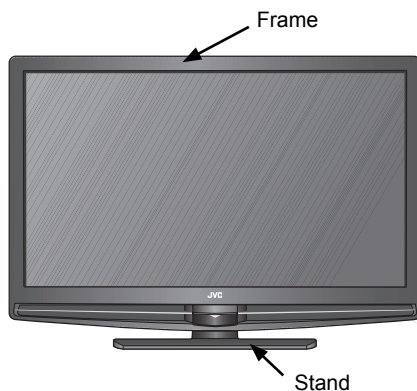

Caring for the Screen

The screen is treated with an electrostatic-proof coating. When it gets dirty, wipe it gently with a soft cloth. If the screen is very dirty, wipe it down with a cloth dipped in a diluted kitchen cleaner and thoroughly wrung-out. Then wipe immediately after with a clean, dry cloth.

- DO NOT apply alcohol, organic solvents (like acetone), acidic or alkaline cleansers to the screen. These will remove the coating layer and cause discoloration.
- DO NOT push or hit the screen. This could cause scratches on the screen surface and image distortion.

Package Contents

Avoiding Temporary Burn-in

Displaying fixed images for extended periods of time may leave a subtle but temporary burn-in image on your screen. To avoid this, mix your viewing pattern.

Examples include, but are not limited to the following:

- Stock-market report bars
- Shopping channel logos and pricing displays
- Video game patterns or scoreboards
- Bright station logos
- Internet web sites or other computer-style images
- DVD discs, video tapes, laser discs
- Broadcast, cable, satellite channels or digital television tuners/converters

For example...

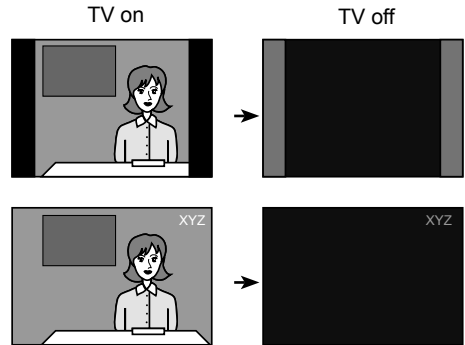

Disconnecting the rear panel screw

In case that the TV has one screw on the rear panel, please remove the screw when you are attaching a wall mounting unit and placing the TV onto a wall.

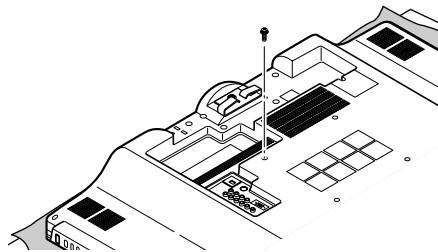

Install your TV

To prevent the TV from falling, thread the belt through the hole on the back of the stand and secure it to the TV rack.

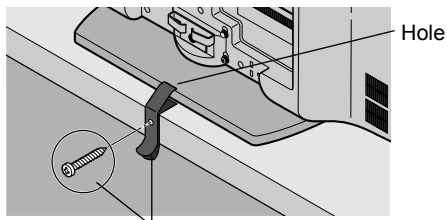

Belt and screw (not included)

Tidying the cables

A cable holder which keeps your connection cables tidy is attached to the back of the stand.

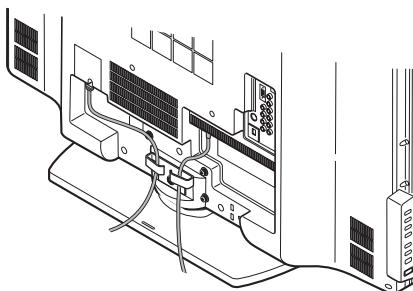

Connect the stand

The LT-32P510 TV stand is not attached to the TV when you purchase it. Please follow the steps below to connect the stand to the TV.

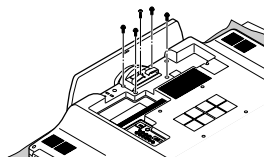
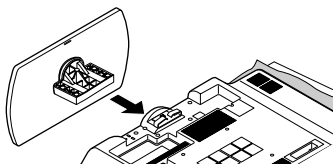

- 1) Place the TV face down on a soft cloth on a table. Insert the TV stand into the TV.
- 2) Insert the 5 screws into the back of the TV and tighten.

Package Contents

Disconnecting the stand

If you disconnect the stand, attach the bottom cover using the screw (supplied).

- 1) Place the TV face down on a soft cloth on a table.
- 2) Remove the screws from the back of the TV.

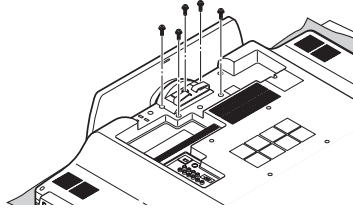

- 3) Pull out the stand from the TV.

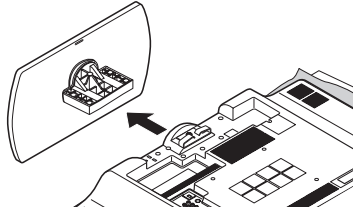

- 4) Cover the hole with the supplied bottom cover and tighten the screw.

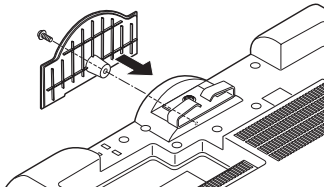

Notes:

- To re-install the stand, reverse the procedure from **4)** to **1)**.
- If you find it difficult to remove the screws from the inset screw wells, use a magnetized screwdriver.

Basic TV Controls

Front Panel

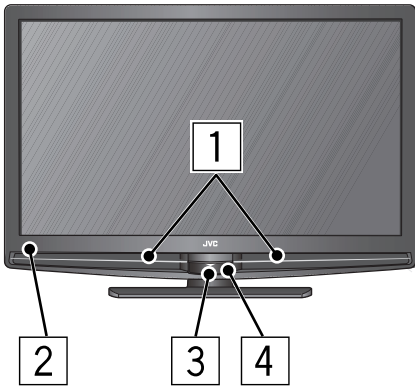



- 1 Diffuser Illumination
- 2 Remote Control Sensor
- 3 Power Lamp
- 4 Dock

Notes:

- Do not use unreasonable force to the Dock.
- When not using the Dock, close the cover.
- Do not touch the connector pins of the Dock or the iPod terminal pins.
- Do not connect different devices to the Dock. It may cause a connection failure.

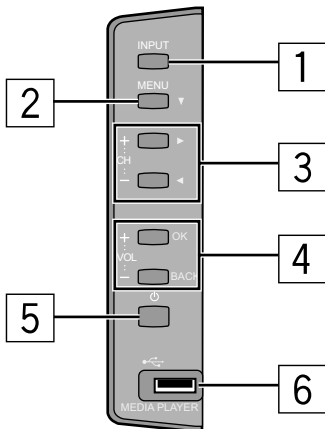
Side Panel



- 1 **INPUT**
Change the input
- 2 **MENU**
Used to access the TV's onscreen menus.
- 3 **+CHANNEL-**
Move sequentially through the channels.
- 4 **+VOLUME-**
Raises or lowers the volume.
- 5 
Turn the TV on or off.
- 6 **MEDIA PLAYER connector**
Used for **Photo Viewer** and **Music Play**

Note:

- Do not use the MEDIA PLAYER connector to connect iPod.

Basic TV Controls

Rear Panel

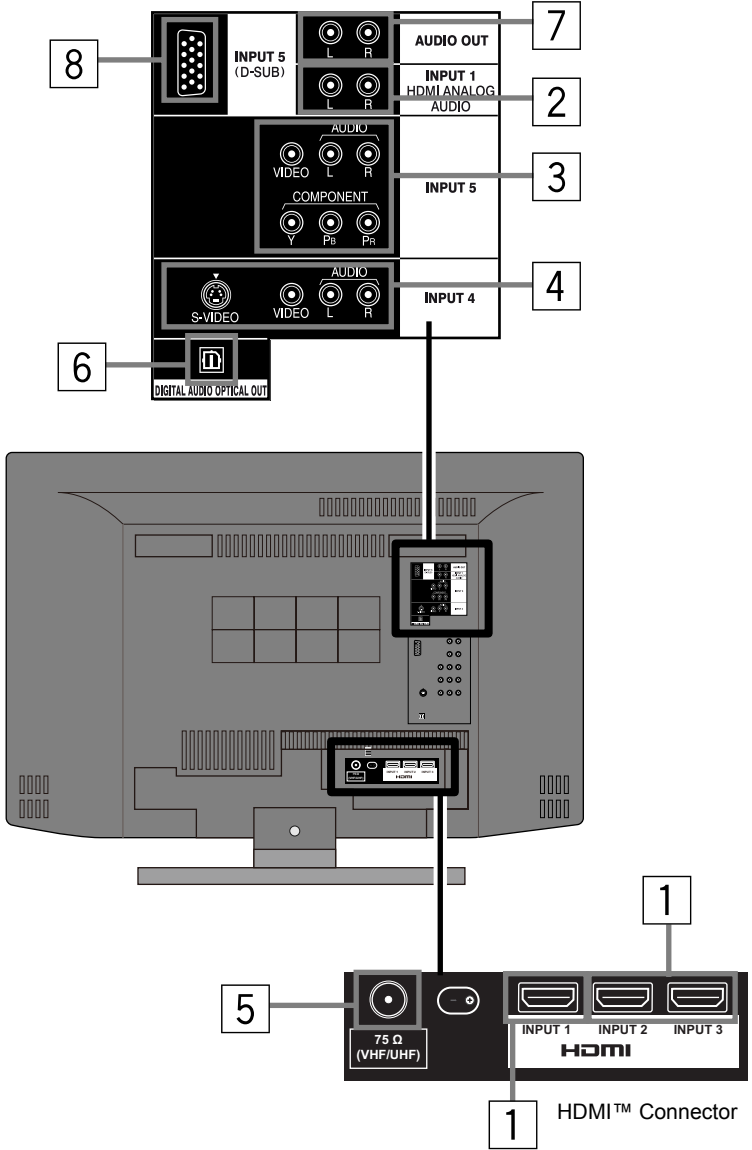

* This is used when you are using HDMI analog audio.

Before you connect your television to another device, please refer to the appropriate diagrams for your specific TV and remote. These will help assist you in understanding how to connect your television to another device, as well as use the remote to set up your television. Some of the connection terminals are color coded for easy connection with the appropriate cables.

To find the best possible connection that your device can use, see pages 16, 17.

For more detailed information about connecting external devices, see pages 53-58.

- 1** HDMI (INPUT 1, 2 or 3)
- 2** HDMI ANALOG AUDIO
- 3** Composite / Component (INPUT 5)
- 4** Composite / S-Video (INPUT 4)

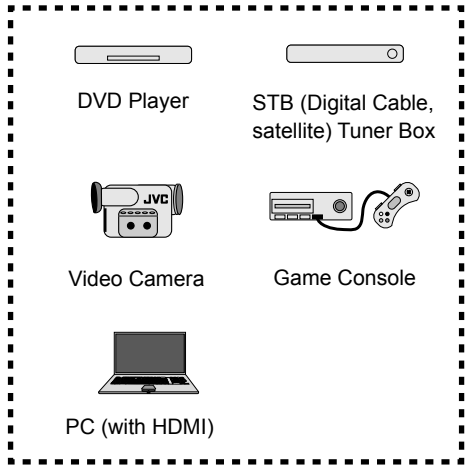

- 5** Antenna / Cable

- 6** DIGITAL AUDIO OPTICAL OUT
- 7** AUDIO OUT

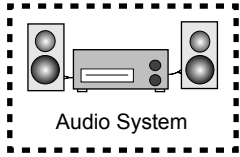

- 8** D-SUB (INPUT 5)

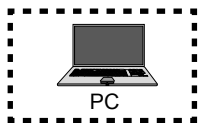











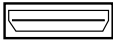

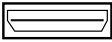

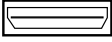

Basic TV Controls

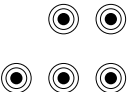
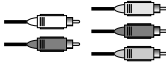
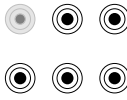
Video

Best



Good







Video Connection	Connection Cable	TV Connection	
 HDMI	 HDMI Cable	 INPUT 1, 2 or 3	
  DVI + Audio	  DVI – HDMI Cable, Audio Cable	  INPUT 1 + HDMI ANALOG AUDIO	
 Component Video + Audio	 Component Video + Audio	 INPUT 5	
 S-Video + Audio	  S-Video Cable, Audio Cable	  INPUT 4	
 Composite Video + Audio	 Composite Video + Audio	 INPUT 4 or 5	

Audio

Best



Good







Audio Connection	Connection Cable	TV Connection	
 OPTICAL INPUT	 OPTICAL AUDIO Cable	 DIGITAL AUDIO OPTICAL OUT	
 AUDIO INPUT (L / R)	 Audio Cable	 AUDIO OUT (L / R)	

Compatible Signal	Notes
Input <ul style="list-style-type: none"> • HDMI (Digital) <ul style="list-style-type: none"> SD: 480i, 480p HD: 720p, 1080i, 1080p/24Hz, 1080p/30Hz, 1080p/60Hz Audio L/R 	HDMI™ (v.1.3, HDMI™ CEC Support) Please use a High Speed HDMI™ Cable. High Speed HDMI™ Cable are tested to carry an HD signal of up to 1080p and higher. See pages 57, 58.
Input <ul style="list-style-type: none"> • DVI (Digital) <ul style="list-style-type: none"> SD: 480i, 480p HD: 720p, 1080i, 1080p/24Hz, 1080p/30Hz, 1080p/60Hz • Audio L/R (Analog) 	See pages 56, 58.
Input <ul style="list-style-type: none"> • Component (Analog) <ul style="list-style-type: none"> SD: 480i, 480p HD: 720p, 1080i • Audio L/R (Analog) 	See page 54.
Input <ul style="list-style-type: none"> • S-Video (Analog) • Audio L/R (Analog) 	See pages 54, 56.
Input <ul style="list-style-type: none"> • Composite (Analog) • Audio L/R (Analog) 	See page 54.

Compatible Signal	Notes
Output <ul style="list-style-type: none"> • Audio L/R (Digital) (PCM or Dolby Digital) 	See page 55.
Output <ul style="list-style-type: none"> • Audio L/R (Analog) (Fixed) 	See page 55.

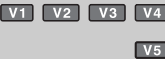
Remote Control

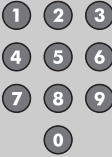
The following pages give you a brief description of each button's function.

	<p>Control your iPod connected to the TV. See page 48.</p>
	<p>Turns the TV on or off.</p>
	<p>Switch between devices connected to Video-1, 2, 3, 4 and 5. For V4 (Video-4) and V5 (Video-5) you must select the signal input type first (ie. composite, S-Video, or component). To do so, you need to press the V4 or V5 button until the correct type is highlighted.</p> <p>For V4: Select Composite 1 for composite video signal input, S-Video for S-video signal input.</p> <p>For V5: Select Composite 2 for composite video signal input, PC for PC signal input and Component for component video signal input.</p>
	<p>Allows you to choose different picture settings according to personal preferences. You can set this feature for each input (TV, V1, V2, V3, V4, V5).</p> <p>Standard / Dynamic / Theater / Game</p> <p>See page 26.</p>
	<p>You can choose from several sound modes.</p> <p>Speech / Jazz / Classic / Rock / User</p> <p>See page 41.</p>
	<p>Change channels.</p>
	<p>Lets you decide the input channel and select it. After entering a channel number using the 0 - 9 buttons, press the TUNE button.</p>

RETURN+



Has three functions.

Return – Returns to the channel viewed just before the channel currently onscreen.

Return+ – Lets you program a specific channel to return to while scanning through the channels using the **+ CH –** buttons.

TV – Returns to the TV mode when you are watching a video, DVD, etc.

Note:

- Press the **TUNE** and **RETURN+** buttons. This will memorize the current channel to return to while you scan through the other channels. To cancel, press the **TUNE** and **RETURN+** buttons again.

TIMER



Allows you to set the TV to turn on at a specific time to a channel of your choice and turn off automatically after a set amount of time.

On Timer / Input / Sleep Timer

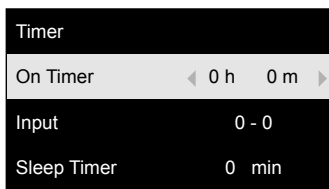





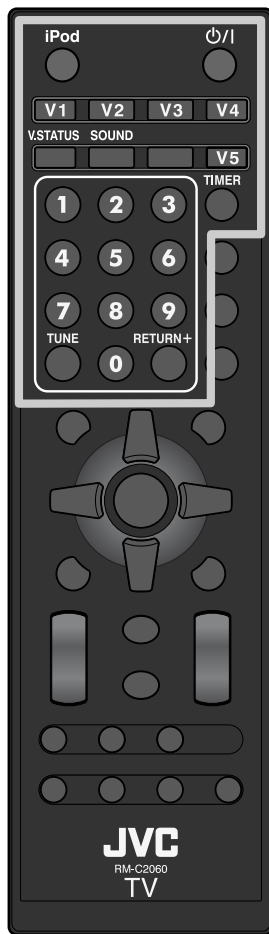



Notes:







- If you set the interval of **On Timer** using the **◀ ▶** buttons, select the channel at input and press the **OK** button.
- After you set **On Timer** and turn off the TV, the power lamp lights.
- You can check the remaining time of **On Timer** by displaying this menu again.
- You can set the interval of **Sleep Timer** using the **◀ ▶** buttons.
- 60 seconds before the TV turns off, a message will appear and it will count down the remaining time.
- See page 52, "On Timer using iPod".

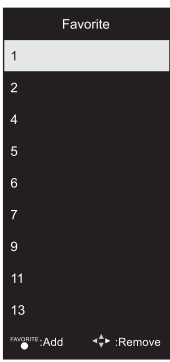

Remote Control

The following pages give you a brief description of each button's function.

	<p>Digital broadcasts sometimes offer sub channels. By using the SUB CH button, you can select a sub channel easily.</p> <p>For example, to move to sub channel 123-45:</p> <ol style="list-style-type: none"> 1) Press 1, 2 and 3 in order 2) Press the SUB CH button 3) Press 4 and 5 in order 4) Press the TUNE button
	<p>Allows you to listen to a program in Stereo, Mono or another language (Sap) if available. First you must set the MODE to TV on your remote.</p> <p>Notes:</p> <ul style="list-style-type: none"> • When you are receiving a digital broadcast, and there are other languages, you can change the language by pressing the ML/MTS button. • Keep the TV in stereo mode to get the best sound quality. The sound will work in stereo mode even if a certain broadcast is in mono only. • Choose the mono setting to reduce excessive noise on a certain channel or broadcast. • MTS is unavailable if your television's input source is V1, V2, V3, V4 or V5. • ML/MTS will not work when you are using HDMI.
	<p>Allows you to adjust the way the image appears on your TV based on the format that is being received.</p> <p>Full / Regular / Slim / Panorama / Cinema / Full Native</p> <p>See page 32.</p>
	<p>View current channel information.</p>
	<p>Used to select the closed caption mode.</p>
	<p>Used to navigate through the TV's onscreen menus.</p>
	<p>Used to access the TV's onscreen menus. See page 24.</p>
	<p>Go back to the previous onscreen menu or to correct a mistake.</p>
	<p>Move sequentially through the channels.</p>

	<p>Allows you to save channels you like so you can view them easily. First you must register the channels you like.</p> <p>Notes:</p> <ul style="list-style-type: none"> • Go to the channel you want to register and press the FAVORITE button. A list will appear. Press the FAVORITE button again to register the channel. • To view your favorite channels, press the FAVORITE button. Use ▲▼ to select your channel and press the OK button. • To erase your favorite channels, press the FAVORITE button. Use the ▲▼ buttons to select your channel and press the ◀▶ buttons. • Both analog and digital channels can be registered. • The channels you have registered will appear in numerical order at the top of the list. 
	<p>Sets the TV volume to 0. Press again to restore the volume.</p>
	<p>Raise or lower the volume.</p>
	<p>Playback controls for Media Player and iPod.</p>
	<p>Returns to the TV channel you were watching while playing iPod. See page 50.</p>
	<p>GUIDE – You can view program information for Digital Channels.</p> <p>PCON – Switches between Pod Control Mode (P.51) and TV Control Mode (P.49).</p> <p>Note:</p> <ul style="list-style-type: none"> • The GUIDE may not show the correct time and date depending on the Time Zone and D.S.T. settings. See page 43.



Initial Setup

When you turn on your TV for the first time, the Initial Setup menu appears automatically. This will help you setup your TV with basic information for **Language**, **Time** and **Tuner Setup**. You can also set these settings in the **Plug in Menu**. See page 43.

1) Turn on the TV



2) Set the language

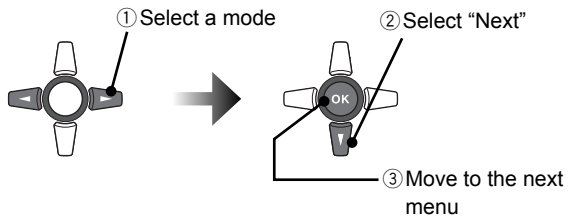
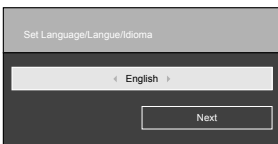

3) Set the mode

Select **Home** for use at home.
Retail is used in the TV store.

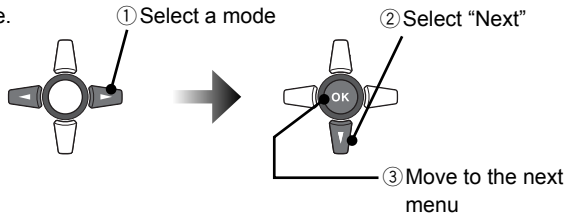
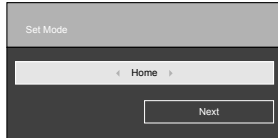

4) Set time attributes

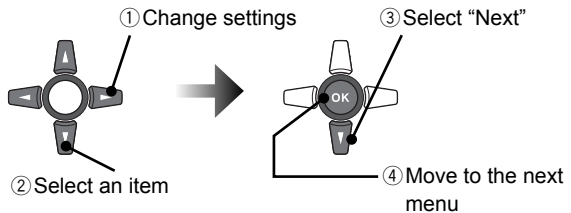
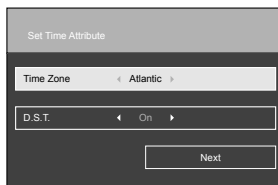

Time Zone	Choose the time zone you live in.
D.S.T.	Changes the clock automatically for daylight saving time. On / Off

5) Set TV attributes

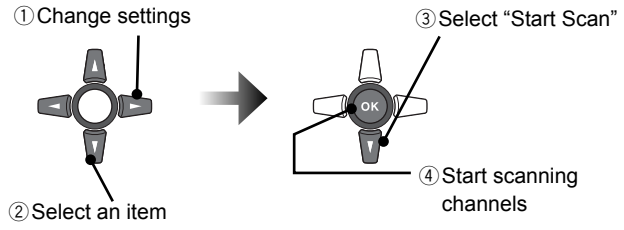
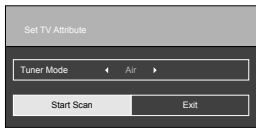

Tuner Mode	Choose Air (antenna) or Cable
------------	---

Notes:

- If you use a set top box (satellite or cable box), select **Exit** to skip this step.
- If you want to turn off the Auto Demo, press the **MENU** button.

“Thank you! Setup is now complete”

Cable Users: After the auto tuner setup is complete, you may (depending on the type of connection) have only 1 channel, usually 2, 3 or 4 in the auto tuner memory. This is normal.

We have an important note for customers who subscribe to basic cable services (do not have a separate cable box) and plan to use their JVC TV remote control to select channels.

Once you run the Auto Tuner Setup (which detects and programs all the channels your TV is receiving through the RF input), every channel number available from your cable company will appear in your television’s Channel Summary and they will all be marked as available for scanning. Even though every channel is detected and appears as available, you will only be able to view those that you specifically subscribe to from your cable company. This will likely mean there are blank channels between those channels you wish to scan or “surf”.

We apologize for any inconvenience this may cause but it is important to note that this is not a malfunction of your television. If you want to sequentially scan those channels you subscribe to without blank ones in between, you can contact your cable company for their cable box and remote, or manually deselect them using the edit/skip feature on page 35.

Customizing Your TV

You can customize your TV by operating the menus on the TV screen. The TV screen displays the Menu Bar and Menu Item, and available items are highlighted.



Explanation of function displays

Using the menus

1) Display the menu bar



2) Display the desired menu

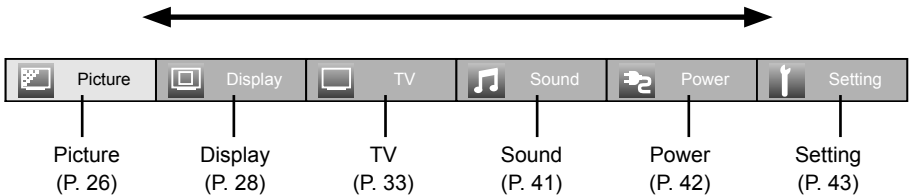

① Press the ◀▶ buttons to select a menu



② Press the ▼ button to select a menu item

3) Change or adjust the setting

Video Status	◀ Standard ▶
Tint	◀ 0 – 50 – 100 ▶
Color	◀ 0 – 25 – 100 ▶
Contrast	◀ 0 – 50 – 100 ▶
Bright	◀ 0 – 43 – 100 ▶
Detail	◀ 0 – 94 – 100 ▶
Backlight	◀ 0 – 50 – 100 ▶
Color Temp	◀ Cool ▶
Color Management	◀ Off ▶
Dynamic Gamma	◀ On ▶
Smart Picture	◀ On ▶
Digital VNR	◀ High ▶
MPEG NR	◀ On ▶
Natural Cinema	◀ On ▶
Video Reset	

① Press ▲▼ to select a menu item

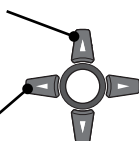

② Press ◀▶ to change the setting

■ To enter an item's sub menu

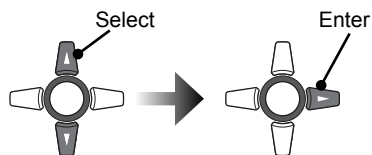

(Example: Media Player)

■ To return to the previous screen



4) Close the menu

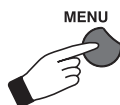

Note:

- Depending on the situation (analog channels, digital channels, video signal format, external inputs, etc.), some items will be displayed in gray and can not be selected.

Customizing Your TV

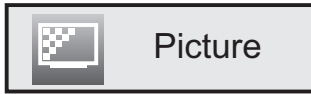

Video Status

Choose different display settings according to personal preferences. You can use this feature with TV, V1, V2, V3, V4 and V5.

Standard

Resets the picture display to the factory settings.

Dynamic

Gives a vivid picture with better contrast when viewing in a brightly lit room.

Theater

Gives a rich, film-like look to video when viewing in a dimly lit room.

Game

Used for when you are playing video games connected to your TV.

Notes:

- Each mode is memorized for each analog TV/composite/S-Video, digital TV, HDMI, component signal input.
- Each video status can be chosen along with your favorite picture settings (**Tint**, **Color**, **Contrast**, **Bright**, **Detail** and **Backlight**).

■ Allows you to change and adjust the way the picture appears on your television.

Tint

Allows you to adjust the levels of red and green on your TV.

Color

Allows you to make all the colors on your TV appear more vivid or subtle.

Contrast

Allows you to adjust the level of black and white on your TV giving you a darker or brighter picture overall.

Bright

Allows you to adjust the overall brightness of the TV.

Detail

Allows you to adjust the level of fine detail on your TV.

Backlight

Allows you to adjust the brightness of the internal lamp which effects the overall brightness of the TV.

Color Temp

Allows you to adjust colors to look as accurate as possible. **Cool / Natural / Warm**

Color Management

Allows you to compensate for dull colors to ensure dull colors are reproduced with natural hues.

On / Off

Dynamic Gamma

Allows you to see more detail in very dark or bright areas so these areas don't appear "muddied". Normally, this feature should be left **On** for optimum picture quality. **On / Off**

Smart Picture

Allows the TV to adjust the brightness level automatically to a level suitable for what you are watching. **On / Off**

Digital VNR

This function can be selected to change the effect of **Digital VNR** (Video Noise Reduction).

High – The effect is maximised

Low – The effect is minimised

Off – Function is turned off

MPEG NR

This function effects the block noise removal and mosquito NR (Noise Reduction) simultaneously.

Note:

- When you are receiving digital channels, block noise removal will have no effect.

Natural Cinema

Allows you to compensate for image blurring when the original video you are watching was shot at 24 frames/sec, and is broadcast at 30 frames/sec. This conversion process is known as "TELECINE". **On / Off**

Notes:

- When you are receiving a 480p, 720p or 1080p signal, **Natural Cinema** cannot be selected.
- **Natural Cinema** is only applied for NTSC, SD 480i and HD 1080i signals.

Video Reset

Resets all picture adjustments to the default settings, except for **Natural Cinema**.

Customizing Your TV

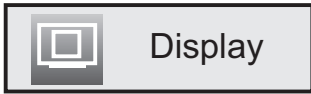

Video Input Label

Allows you to label all the devices you have connected to the TV that use the VIDEO-1, 2, 3, 4 and 5 inputs.

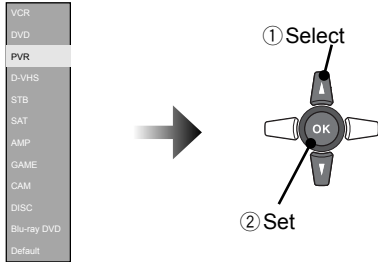

Media Player

Allows you to enjoy pictures and musics stored on your USB device you have connected to the MEDIA PLAYER terminal of the TV.

Side Panel

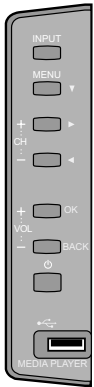

USB Device

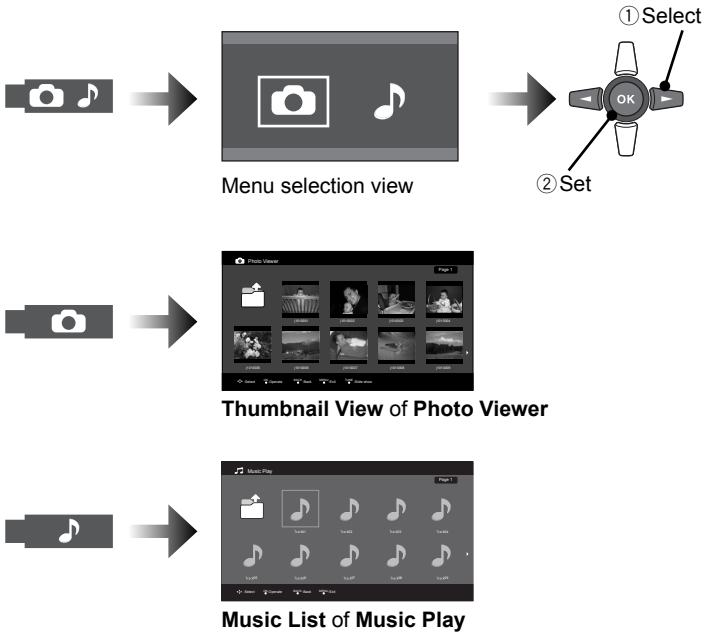

When both pictures and music are stored on your USB device, select **Photo Viewer** (📷) or **Music Play** (🎵) using the ◀▶ buttons and press the **OK** button.

When only pictures (JPEG or BMP) are stored, **Thumbnail View** will appear. When only music is stored, **Music List** will appear.

Notes:

- Gently pull out your USB device from the MEDIA PLAYER terminal after finishing the **Photo Viewer** or **Music Play** menu.
- Use the USB cable supplied with your device. Do not use a HUB or USB extension cable.
- **Media Player** cannot be guaranteed to work with all USB Mass Storage Devices. It may take some time to be displayed or it may not be displayed correctly.
- Please refer to the Customer Support website at www.jvc.com/support for information and notes regarding the devices you wish to connect.
- All your stored data should be backed up first as a precaution before connecting to the TV.
- Depending on the attributes of the MP3 music content or the digital picture file, it may not be played back properly.
- It is recommended that files to be played back are recorded under the following specifications:

<BMP/bmp>

Maximum file size: 8 MB

Maximum pixel size: 2.7 Mpixel

<MP3/mp3>

Sampling frequency: 32, 44.1, 48 kHz

Bit rate: 64, 96, 128, 160, 192, 256, 320 kbps

Photo Viewer

Allows you to view digital pictures (".jpg" or ".bmp"; upper/lower case) stored on your USB Mass Storage Class devices.

Thumbnail View

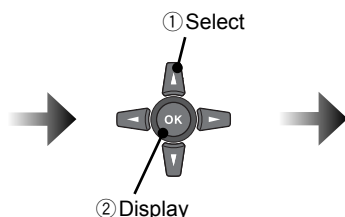
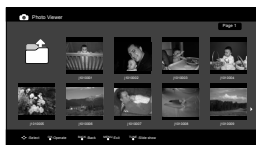

When you select **Thumbnail View** and press the **OK** button, a folder or file list will be displayed. Select a folder using the ◀▶ or ▲▼ buttons. Choose a picture and press the **OK** button. It will now be shown on the screen. To move to the next picture, press the ▶ button. To move to the previous picture, press the ◀ button.

* If there are more images than displayed, those images will be shown on the next page. To go to the next page, select the last image on the page and press the ▶ or ▼ button. To go back to the previous page, press the ◀ or ▲ button.

Slide Show

On the **Thumbnail View** screen, you can view a slide show by pressing the **TUNE** button. While viewing the slide show, you can also listen to music stored on the USB device.



Display Continued...

Customizing Your TV

Operations using the remote control

DISPLAY



Display the help screen

VOL



90° Rotation



Play/Pause
(during a slide show)



Move to the upper left



Move to the right



Move up



Move to the lower left



Move to the upper right



Move down



Move to the left



Move to the lower right



Reset



Display the next image



Display the previous image



Enlarge



Reduce

* The 0 - 9 buttons only work when pictures are zoomed in.

* The ◀ ▶ buttons only work during a slide show.

To listen to music during a slide show

Rewind Play Forward



Pause Stop



RETURN+



Move to **Music List** of **Music Play**

SOUND



Adjust the sound status

VOL



Volume

MUTING



Set the TV volume to 0

DISPLAY



Display the track information

Interval

Choose a slide show Interval of 5, 10 or 20 seconds using the ◀ ▶ buttons.

Notes:

- Depending on the stored file size, it may take extra time to display the **Photo Viewer** page.
- Depending on the stored file type, some data may not be able to be displayed on the thumbnail screen.
- You may only view photos stored on HDD when using an HDD equipped Everio Camera.

Music Play

Allows you to listen to your MP3 Music content (".mp3"; upper/lower case) stored on your USB Mass Storage Class devices.

Music List

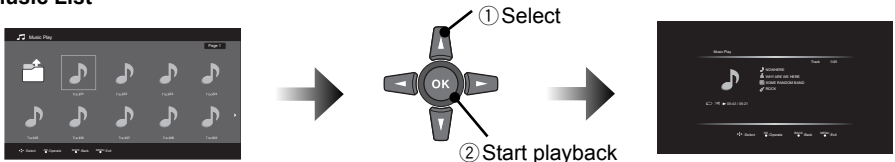

When you select **Music List** and press the **OK** button, a folder or file list will be displayed. Select a folder using the ◀▶ or ▲▼ buttons. Choose a track and press the **OK** button. It will now be played back. To move to the next track, press the ▶ button. To move to the previous track, press the ◀ button.

* If there are more music files than displayed, those music files will be shown on the next page.

To go to the next page, select the last track on the page and press the ▶ or ▼ button. To go back to the previous page, press the ◀ or ▲ button.

Operations using the remote control

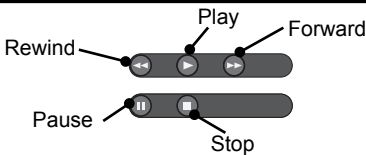

SOUND
Adjust the sound status

MUTING
Set the TV volume to 0



Skip to the next/previous track



Volume



Move to **Music List** of **Music Play**

Repeat

Function to play the songs in the current folder repeatedly can be selected using the ◀▶ buttons. **Off / One / All**

Shuffle

Function to select songs in the current folder at random can be selected using the ◀▶ buttons. **Off / On**

On Timer using USB device

You can set the timer to listen to the MP3 music content on your USB device. After setting **On Timer** and select **USB** at **Input** in the **Timer** menu, connect your USB device to the MEDIA PLAYER connector. See page 19.

Note:

- When the on time comes, the music content is played in alphabetical order.
- If music files are stored in a folder, those files can not be played back. To play music files using **On Timer**, store them in the root directory.



Display Continued...

Customizing Your TV

Aspect

Allows you to adjust the way the image appears on your TV based on the format that is being received.

Full – When watching a 4:3 aspect picture, it is stretched to fit the dimensions of the TV. When watching a 16:9 aspect picture, it displays 95% of the picture.

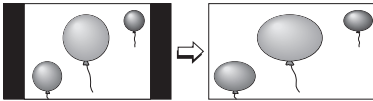

Panorama – When watching a 4:3 aspect picture it is stretched to fit the dimensions of the 16:9 aspect screen.

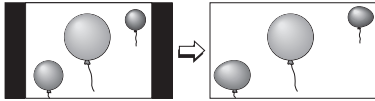

Full Native – This ratio displays 100% of the picture. Normally, all aspects except for **Full Native** display about 95%.

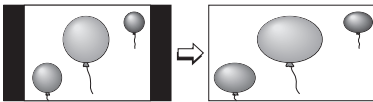

Regular – When watching a 4:3 aspect picture without modifying the original picture to fit the dimensions of your 16:9 screen. Black bars will appear at the picture's sides. The picture will be centered within the boundaries of the 16:9 screen.

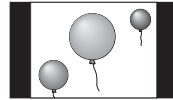

Cinema – This ratio zooms in on the center part of a 4:3 aspect picture, blowing it up proportionally to fill the 16:9 screen.

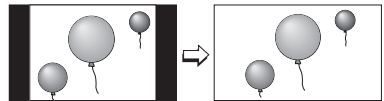

Slim – This aspect mode shrinks the screen of a 16:9 broadcast to 4:3. Some programming is stretched by mistake by broadcasting companies, so this mode corrects it. Black side bars will appear.

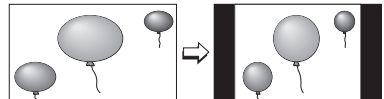

Notes:

- Depending on the signal format, some aspect modes are unavailable.
- In iPod mode, the options in the **Aspect** menu change to **Full / Regular / 16:9 Mini / 4:3 Mini**.



Closed Caption

Allows you to select the closed caption mode. First you must set the **MODE** to either **TV**, **STB** or **VCR** on your remote. **On / Smart / Off**

Note:

- **Smart** caption will appear when you press the **MUTING** button only on channels where the broadcast contains closed captioning.

C.C. Type

Allows you to select the type of closed caption. **Basic** is for an analog channel's caption, and **Advanced** is for a digital channel's caption. **Auto / Basic / Advanced**

C.C. Setting

You can choose between caption or text in mode to decide how closed captioning will appear.

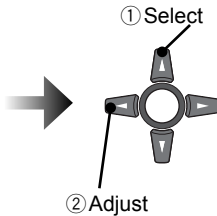
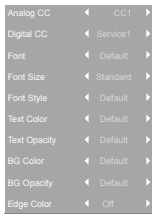

Analog CC

Choose the CC feature for analog closed captioning.

Digital CC

Choose the CC feature for digital closed captioning.

Font

Choose the font for closed captioning.

Font Size

Choose how big the text appears for closed captioning.

Font Style

Choose the style of the font for closed captioning.

Text Color

Choose the color of the text for closed captioning.

Text Opacity

Choose how translucent the text appears for closed captioning.



TV Continued...

Customizing Your TV

BG Color

Choose the background box color for closed captioning.

BG Opacity

Choose how translucent the background box is for closed captioning.

Edge Color

Choose the color of the border of the background box for closed captioning.

Note:

- The **Font**, **Font Size**, **Font Style**, **Text Color**, **Text Opacity**, **BG Color**, **BG Opacity** and **BG Color** settings will not apply to closed captioning for analog channels. In addition, some of these settings for closed captioning for digital channels may or may not be available, depending on the closed captioning data being broadcast.

Tuner Mode

If you skipped this step in the initial setup or your setup has changed, you can redo your setup in this menu. **Air / Cable**

Autoscan

Scans through all available channels your TV can receive, and memorizes them.

Note:

- The Autoscan has finished when the message "**Scanning has completed**" appears on the screen.

Add Channel

Allows you to add analog/ digital channels from those being broadcast.

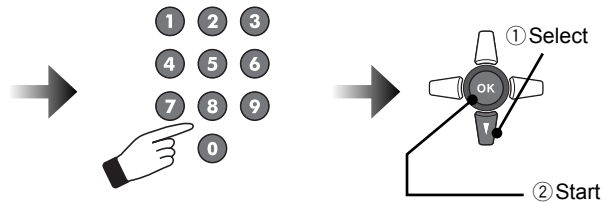
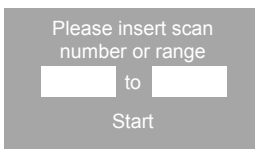

Enter the new channel number

Edit Channel

Allows you to skip channels when using the + CH – button. “√” means don’t skip, “ ” means skip. You can still access those skipped channels manually using the number buttons on the remote.

Main Channel List	
✓	3-2 CH-2
✓	3-3 CH-3
✓	5-0
✓	6-0
✓	6-0
✓	11-0
✓	14-0
✓	22-1 CH-1
✓	36-0
✓	63-0

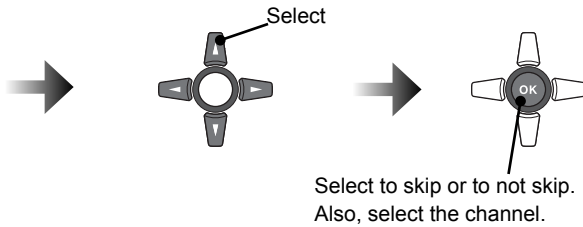

V-Chip

Allows you to block channels or content that you deem inappropriate for children.

Notes:

- **V-Chip** will not work with video signals from VCRs, DVD players, Blu-ray devices or camcorders connected to the TV.
- (For Canadian viewers only) V-Chip is designed specifically for the US and may not work properly in Canada.

When entering the password

When you try and access the **V-Chip** menu, “Please input password.” will appear. Enter “0000” to access the **V-Chip** menu for the first time.

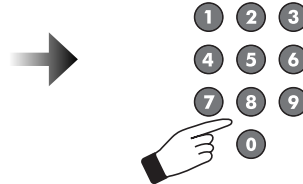
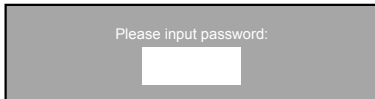

TV Continued...

Customizing Your TV

When you lock or unlock channels

You can lock or unlock ratings as shown below.

Password	NR	
MPAA	G	
Can. Eng	PG	
Can. Fre	PG13	
	R	
	NC-17	
TVPG	X	

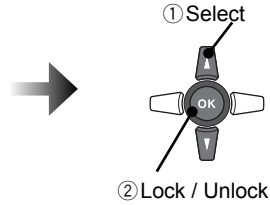

Note:

- If you lock a rating, any rating that is higher is automatically blocked.

Password

New Password	_____
Confirm Password	_____
OK	Clear

You can change the four digit password using the number buttons on your remote.

- * If you forget your password, unplug the TV from the wall and then plug it back in. The password will reset to "0000".

1) Set a new password

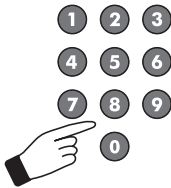

Enter a four digit number.



2) Confirm and set

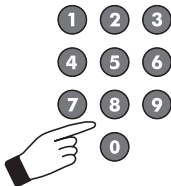

Enter the same four digit number.



MPAA

NR	
G	
PG	
PG13	
R	
NC-17	
X	

This setting is based on the US Motion Picture Association of America (MPAA) ratings system.

NR – Not Rated.

Any type of programming that does not contain a rating.

G – General Audience.

Suitable for all ages.

PG – Parental Guidance Suggested.

Suitable for all ages with parental guidance.

PG 13 – Parents Strongly Cautioned.

Intended for viewers 13 years or older.

R – Restricted.

Not recommended for viewers 17 years or younger without parental guidance.

NC-17 – No One Under 17.

Not intended for viewers under 17 years or younger.

X – No One Under 18.

Not intended for viewers 18 years or younger.



TV Continued...

Customizing Your TV

Can. Eng

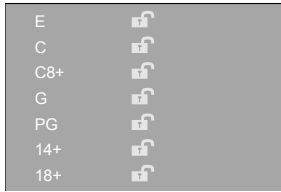

This setting is based on the Canada ratings system.

E – Exempt.

Any type of programming that does not contain a rating.

C – Intended for children.

Suitable for all ages.

C8+ – Intended for children over 8 years old.

Suitable for all ages over 8 years.

G – General Audience.

May contain material not suited for younger viewers.

PG – Parental Guidance.

May contain material not suited for younger viewers. Parents may consider some content not appropriate for children 8-13 years old.

14+ – 14 Years or Older.

Parents strongly urged to use their discretion in allowing viewing by persons under 14.

18+ – Adult.

Intended for viewers 18 years or older.

Can. Fre



For instructions on **Can. Fre**, please see page 38 in the French user's guide.

TVPG

	ALL	FV	V	S	L	D
TV-Y						
TV-Y7						
TV-G						
TV-PG						
TV-14						
TV-MA						

This setting is based on the US ratings system.

TV Y – Appropriate for all children.

Intended for all children 2-6 years old.

TV Y7 – Appropriate for older children.

Intended for children 7 years or older.

TV G – General Audience.

Suitable for all ages.

TV PG – Parental Guidance Suggested.

Suitable for all ages with parental guidance.

TV 14 – Parents Strongly Cautioned.

Intended for viewers 14 years or older.

TV MA – Mature Audiences Only.

Intended for viewers 18 years or older.

Viewing Guidelines:

In addition to the above ratings, you can also block or allow more specific content (Except for unrated programming).

A program may contain any or all of the following:

V/FV – VIOLENCE/FANTASY VIOLENCE

S – SEXUAL Content

L – Strong LANGUAGE

D – Suggestive DIALOG

Guide

You can view program information. (Digital channels only)

Note:

- If the programming information is not being broadcast, the guide function has no effect or may display incorrect information.



TV Continued...

Customizing Your TV



Notes:

- This menu will replace the **TV** menu when you connect a PC to the TV terminal. See page 58.
- There are some menus that PC mode cannot use (in the **Picture** and **Sound** menus).
- As for **Aspect** in the **Display** menu, only **Regular** and **Full** are available.

Auto Adjustment ---

Adjust the screen position automatically.

Note:

- Sometimes Auto Adjustment will not operate properly. Either adjust with the following functions or change the signal.

Phase Adjustment ---

Adjust it when noise shows up across the screen or when letters become blurry.

PC H-Position ---

Allows you to adjust the screen position horizontally.

PC V-Position ---

Allows you to adjust the screen position vertically.

Reset ---

Resets all PC mode adjustments to the default setting.

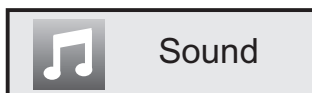

MTS

Allows you to listen to a program in stereo, mono or another language (SAP). (Depending on the program)

Notes:

- When you are receiving a digital broadcast, and there are other languages, you can change the language using the **ML/MTS** button.
- Keep the TV in stereo mode to get the best sound quality. The sound will work in stereo mode even if a certain broadcast is in mono only.
- Choose the mono setting to reduce excessive noise on a certain channel or broadcast.
- MTS is not available if your television's input (V1-V5) is selected for the source.
- ML/MTS will not work when you are using HDMI.

Digital Audio (ML)

You can change the language if there are other languages available. (Digital channels only)

Surround

You can select the surround mode you like. **Off / Movie / Music / News / Mono**

Video-1 Audio

You can select the input audio for Video-1. **Auto / Digital / Analog**

Note:

- The input audio for Video-2/Video-3 (HDMI2/HDMI3) is always digital.

Sound Status

You can choose from several sound modes. **User / Speech / Jazz / Classic / Rock**

Note:

- If you select **User**, you can customize the various sound frequencies.
100Hz / 330Hz / 1KHz / 3.3KHz / 10KHz

Audio Reset

Resets all sound adjustments to the default settings.

Customizing Your TV



Power Indicator _____

Allows you to adjust the brightness of the blue power indicator light.

High – Light is brightly lit

Low – Light is dimly lit

Off – Light is off

Illumination _____

Allows you to adjust the brightness of the Diffuser Illumination. See page 13.

High – Light is brightly lit

Low – Light is dimly lit

Off – Light is off

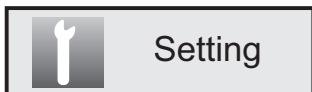

Plug in Menu

When you turn on your TV for the first time, the Initial Setup menu appears. If you skip it, or your setup has changed, you can set it up in this menu anytime.

Time Zone

Choose the time zone you live in and the clock is set automatically.

Atlantic / Eastern / Central / Mountain / Pacific / Alaska / Hawaii

D.S.T.

Adjust your TV's clock for Daylight Saving Time. **On / Off**

Language

Allows you to change the TV's onscreen menu language to English, French or Spanish.

Noise Muting

Displays a blank gray screen over channels that are too weak to be received clearly.

On / Off

Front Panel Lock

Allows you to lock the buttons on the side of the TV. **On / Off**

Transparency

Change the transparency of the menu screens. **1 / 2 / 3 / 4**

Auto Shut Off

This function automatically shuts off your TV when there is no signal from the channel for 10 minutes while the TV is on. **On / Off**



Customizing Your TV

Control with HDMI

If you use an HDMI CEC compatible device, set this setting to **On**.

HDMI CEC (Consumer Electronics Control) allows the TV to connect to and control multiple HDMI CEC enabled devices with a single remote. CEC (Consumer Electronics Control) is an optional protocol used in HDMI.

- HDMI CEC on this TV is compliant with “High-Definition Multimedia Interface Specification”.
- The TV does not support HDMI CEC functions that are not listed below.
- The TV does not guarantee use of all HDMI CEC enabled devices.
- Devices that are not HDMI CEC enabled cannot be controlled with this TV.

Control the TV using an HDMI CEC enabled device

- Turn the TV on and switch to the video source of the operating device.
- Switch to the video source of the operating device.
- Turn the TV off with the HDMI CEC enabled device you are viewing.
- For operating instructions of the device, refer to the device’s manual.

Control the HDMI CEC enabled device using the TV

- Turn off the operating device by turning off the TV.
- Some devices may not support this function. For more details refer to the device’s manual.

Send the status of the TV to an HDMI CEC enabled device

- When switching the TV’s external input or channel.
- When switching the TV’s menu language.
- For information regarding behavior of the device when the status is received, refer to the external device’s manual.

If HDMI CEC does not work correctly

- When an HDMI CEC enabled device is connected to INPUT 1, INPUT 2 or INPUT 3 with an HDMI cable, you may not be able to control the TV’s external input. To solve the problem set this setting to **Off**.

System Info

You can confirm the TV's software version.

Auto Demo

Auto Demo explains this TV's features to you.

Notes:

- The **Auto Demo** mode will start automatically when you set **Retail** in **Initial Setup**.
- If you press any button on the television or remote, with the exception of **POWER** or **MENU**, the **Auto Demo** mode will stop for 30 seconds. After 30 seconds have passed with no operation, the **Auto Demo** mode will start again.
- If you want to turn off the **Auto Demo** mode, press the **MENU** button.

Optical Out





You can select the optical digital sound output as **PCM** or **DOLBY DIGITAL** when your TV is connected to an amplifier that has a DOLBY DIGITAL decoder. If you select **DOLBY DIGITAL**, you can enjoy listening to 5.1ch sound when watching digital broadcasts. This only applies to digital channels.

Notes:

- Optical Out can be used for both digital and analog channels.
- If your amplifier does not have a DOLBY DIGITAL decoder, select **PCM**. If you do not select **PCM**, it cannot output the sound from the speakers.
- For connecting an amplifier using the optical output, see page 55.

Enjoy Movies/Music From Your iPod

Compatible iPod Types

iPhone	iPod				
iPhone iPhone 3G iPhone 3GS	4G	4G (photo/color)	5G	classic	
					
4GB 8GB 16GB 32GB	20GB 40GB	20GB 30GB 40GB 60GB	30GB 60GB 80GB	80GB 120GB 160GB	

TV Control Mode

Music Play	√	√	√	√	√	
Video Play	√			√	√	
Setting	√ (3)	√ (3)	√ (3)	√ (3)	√ (3)	

Pod Control Mode

Music Play	√ (1, 2)	√ (1)	√ (1)	√ (1)	√ (1)	
Video Play	√ (2)			√	√	
Photo Slide Show	√ (4)		√	√	√	
Setting	√ (2)	√	√	√	√	

* If your iPod is not listed in this chart, it is incompatible with this TV.

* Some setups will require selections to be made using iPod (especially those that require wheel control).









* Not available except for Music/Video play, Photo Slide Show (Pod Control Mode).

(1) The registration of "On-The-Go" can be done using iPod.

(2) Due to the nature of iPod touch and iPhone, lock/unlock, Main Menu and the selection of music/video has to be done using iPod touch and iPhone.

(3) **Shuffle, Repeat, Audiobook and Album Jacket** are available in TV Control Mode.

(4) Controlling **Photoviewer** can only be done using iPod touch and iPhone.

			iPod nano					iPod mini
	touch 1G	touch 1G (FW:2.0+) touch 2G	1G	2G	3G	4G	5G	
								
	8GB 16GB 32GB	8GB 16GB 32GB 64GB	1GB 2GB 4GB	2GB 4GB 8GB	4GB 8GB	8GB 16GB	8GB 16GB	4GB 6GB
	√	√	√	√	√	√	√	√
		√			√	√	√	
	√ (3)	√ (3)	√ (3)	√ (3)	√ (3)	√ (3)	√ (3)	√ (3)
	√ (1, 2)	√ (1, 2)	√ (1)	√ (1)	√ (1)	√ (1)	√ (1)	√ (1)
	√ (2)	√ (2)			√	√	√	
	√ (4)	√ (4)			√	√	√	
	√ (2)	√ (2)	√	√	√	√	√	√

Enjoy Movies/Music From Your iPod

By inserting your iPod into the Dock, you can display movies or music on your TV from your iPod. Also, while inserted you can recharge your iPod.

Ready to play

- 1) Insert your iPod into the Dock on the front of the TV.

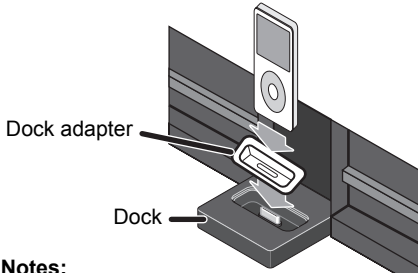

- * When you put insert iPod into the Dock, please use the Dock adapter (supplied with iPod or separately purchased).
- * To detach the dock adaptor from the Dock, push the slot then pull up to remove the dock adaptor. If you have difficulty detaching the Dock adaptor, gently use a flat head screwdriver to remove.

Notes:

- It is recommended that music, pictures and movies on iPod be saved on your PC or another hard drive for backup.
- Please be sure to connect/disconnect iPod properly from the Dock and use iPod without any accessory/case.
- Please do not jiggle iPod in the Dock to avoid connection failure or damage to the connector.

- 2) Press the **iPod** button on your remote. The JVC logo will appear on the screen of the iPod (except for iPod touch and iPhone).



Notes:

- You cannot operate iPod while the Apple logo appears on the screen of iPod.
- If your iPod does not work correctly, gently detach it and try again.

- 3) The TV screen will change to the iPod start screen.

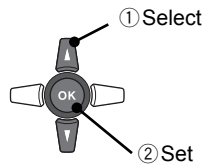
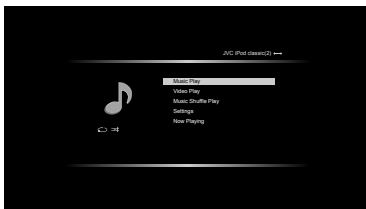

- 4) To exit the menu, press the **iPod** button. The TV will return to the program you were watching.
- 5) When you detach your iPod, while gently holding the base, pull the iPod gently straight upwards.

Notes:

- If iPod does not play correctly, please update your iPod software to the latest version. For details about updating your iPod, check on the Apple web site, <http://www.apple.com>.
- While iPhone is connected to the Dock, the ringtone will be output from the speakers. If you set iPhone to silent mode, the music will be interrupted when a call is received.
- Sound distortion may occur when playing back audio sources with a high recording level. When distortion occurs, it is recommended to turn off the equalizer of iPod. For information on operating iPod, see the iPod instruction manual.
- JVC is not responsible for any loss of or damage to iPod that might result from the use of this product.

TV Control Mode

You can operate iPod using the TV's remote control and onscreen menus.

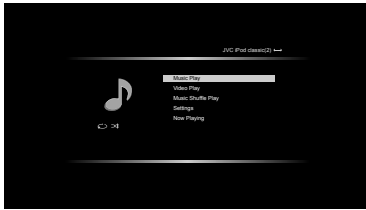

Music Play
Video Play
Music Shuffle Play
Settings
Now Playing (when playing music)

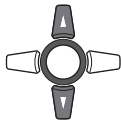

Select



Skip to the next/last page



Set



Back to the previous menu

Notes:

- When **Music Play** is selected, you can then search by the categories supported on your iPod, such as **Playlists**, **Albums**, **Songs**, **Podcasts** etc.
- When you search for tracks from **Artists**, **Albums**, etc., some tracks may not be displayed on the list. In this case, select a track from **Songs** or input tag information using iTunes.

Icons of Music Play screen

Album Jacket

Your iPod name

Blinks when communicating with iPod

Shuffle

Songs

Albums

Repeat

One

All

Music Play

JVC iPod classic(2)

1 / 334

MUSIC

Artist

Album

Genre

Nowhere

Why are we here

Some random band

Rock

00:00:43 / 00:06:21

Rewind

Forward

Pause/Stop

Play

* Language Support:
English, French and Spanish

Enjoy Movies/Music From Your iPod

Music Play / Video Play

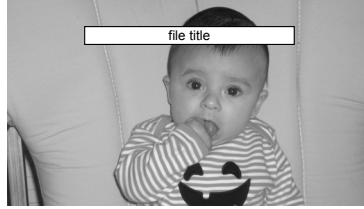
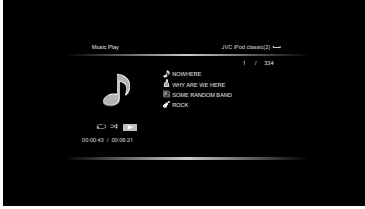

Skip to the next/last song



Back to the previous menu



TV's onscreen menu
("Picture" and "Sound")



Volume



Adjust the video status
(Video Play)



Change the aspect ratio
(Video Play)



Adjust the sound status



Choose Timer



Back to TV



Display title (Video Play)



You can view the last program you were watching while listening to your iPod (iTV Mode). Press the iTV button when playing music.



Set the TV volume to 0

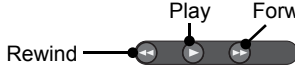

Back to the previous menu

iTV (in Music Play mode)

iTV allows you to watch TV and at the same time, listen to the music content on your iPod. When you are listening to music in **Music Play** mode, press the iTV button.



Adjust the video status



Adjust the aspect ratio

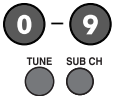

Select a channel.
(See pages 18, 20)



Adjust the sound status



Change the channel



Select the input



Change between iPod sound
and TV sound



Back to the Music Play
screen



Display information

Note:

- Basic operations are the same as the operations when playing in **Music Play** mode.

Music Shuffle Play

This function selects songs randomly.

Note:

- Basic operations are the same as the operations when playing in **Music Play** mode.

Settings

You can adjust the settings below using the ▲▼ and OK buttons.

Shuffle / Repeat / Audiobook / Album Jacket

Notes:

- When a music file does not contain album jacket data, no **Album Jacket** will be displayed.
- The **Album Jacket** of music files which have a playing time of less than 10 seconds will not be displayed.
- **Album Jacket** may not be displayed depending on the iPod and/or file type.

Pod Control Mode

You can operate the iPod using the TV's remote control and the onscreen menu of the iPod. Press the **PCON** button to switch between Pod Control Mode and TV Control Mode.

- 1) Press the **PCON** button on the remote control. The JVC logo will disappear (except for iPod touch and iPhone) and the normal screen of your iPod will appear.
- 2) Operate using the TV remote control.



* Operation varies depending on the iPod type and/or mode



Adjust the sound status



Back to the previous menu



Adjust the video status



TV's onscreen menu ("Picture" and "Sound")



Adjust the aspect ratio



Volume



Choose Timer



Set the TV volume to 0



Back to TV



Exit message



* Operation varies depending on the iPod type and/or mode

Note:

- The TV will display a blank black screen when operating iPod in Pod Control Mode.

Enjoy Movies/Music From Your iPod

Recharge iPod

While your iPod is connected to the Dock, you can charge your iPod. The time it takes depends on how low the batteries are.

Note:

- If you insert iPod into the Dock when the TV is off, a click sound may occur. This is normal.

On Timer using iPod

You can set the timer to listen to your iPod music content. After setting **On Timer** and select **iPod** at **Input** in the **Timer** menu, insert your iPod into the Dock. See page 19.

Notes:

- You cannot play Video content using the **On Timer** function.
- If you want to set the timer to listen to your favorite music content, play the music content operating your iPod and press pause. Then insert it into the TV Dock. On Timer will start to play the selected music.
- Depending on the iPod types, this function may not work properly.

Error messages

"iPod not found"	This appears when you press the iPod button without inserting iPod.
"Communication failed. Check Connection"	Insert your iPod again. This is a connection error.
"File not found"	This appears when your iPod has no files to play.

Connecting Your Devices

Notes:

- The following connection diagrams are examples on connecting some of the most common devices to your TV. Please refer to your device's instruction manual on other connection methods or for devices not shown here in this instruction book.
- When you have finished connecting your devices, turn on your TV and devices.

Connect an Antenna or Basic Cable



Notes:

- If you are able to receive an ATSC (Digital terrestrial) signal, High Definition (HD) broadcasting can be watched.
- Not all digital broadcasting is necessarily High Definition. Check by pressing the **DISPLAY** button.
- Digital broadcasting is not available in all areas.

Connect a Cable Box

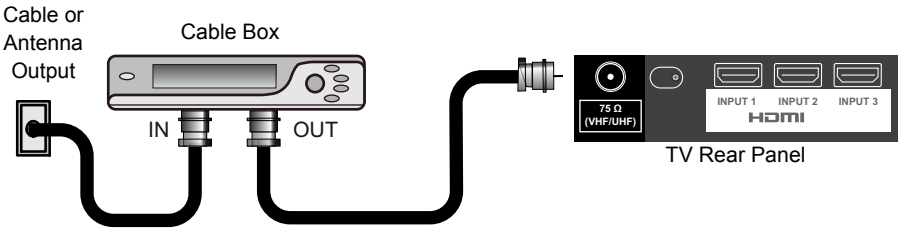

Note:

- To view channels on your cable box, make sure your TV's channel is set to 2, 3 or 4 (depending on the area you live in).

Connecting Your Devices

Connect a VCR / DVD Player using Component Video

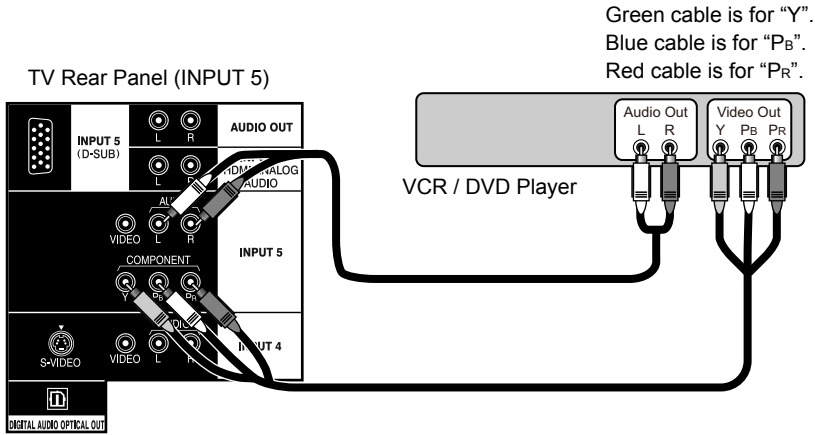

Notes:

- Green, blue and red are the most common colors for Component Cables. Some models may vary in color.
- To watch your VCR / DVD player, make sure your TV is displaying INPUT 5 by pressing the **V5** button on your remote control.

Connect a VCR / DVD Player using Composite Video

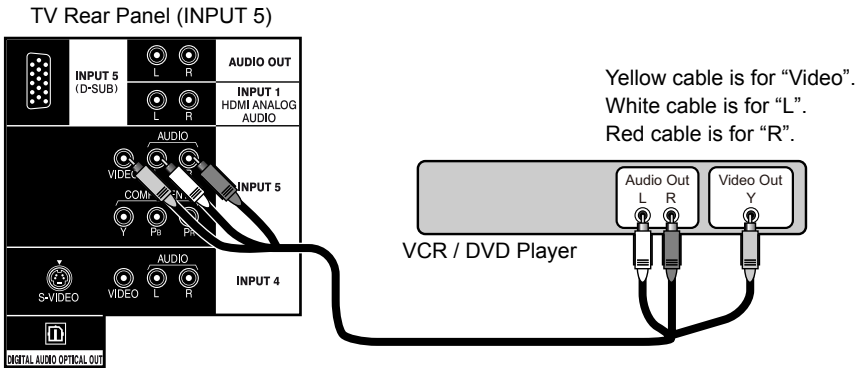

Notes:

- Yellow, white and red are the most common colors for Composite Cables. Some models may vary in color.
- To watch your VCR/DVD player, make sure your TV is displaying INPUT 4 or INPUT 5 by pressing the **V4** or **V5** button on your remote control.
- If your device has S-Video Output, you can use that instead of using Composite Cables. Connect INPUT 4 (S-VIDEO) and S-Video Output with an S-Video Cable.

Connect an Amplifier or Home Theater System

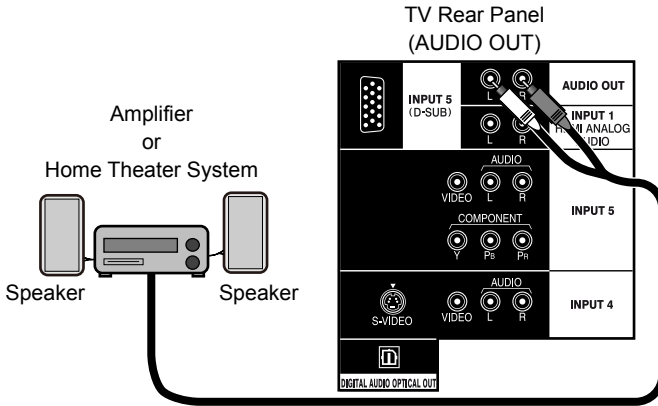

Notes:

- Refer to your amplifier's or Home Theater System's manual for more information.
- If you have a device connected to INPUT 1, INPUT 2 or INPUT 3, you will not be able to hear any audio from AUDIO OUT on the back of the TV.

Connect an Amplifier using DIGITAL AUDIO OPTICAL OUT

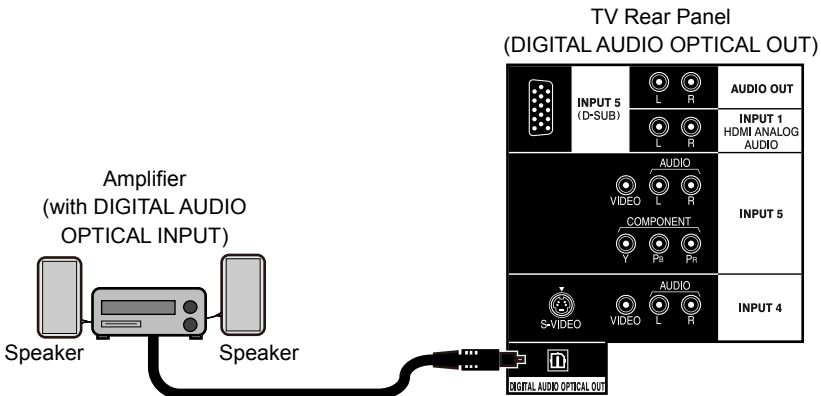

Notes:

- Refer to your amplifier's manual for more information.
- This terminal can only output digital audio (PCM or DOLBY DIGITAL).
- In order to use the optical output connection, select **PCM** or **DOLBY DIGITAL**. See page 45.
- You cannot output sound from the DIGITAL AUDIO OPTICAL OUT connection if the audio source is from your HDMI device.

Connecting Your Devices

Connect a Digital Source Device

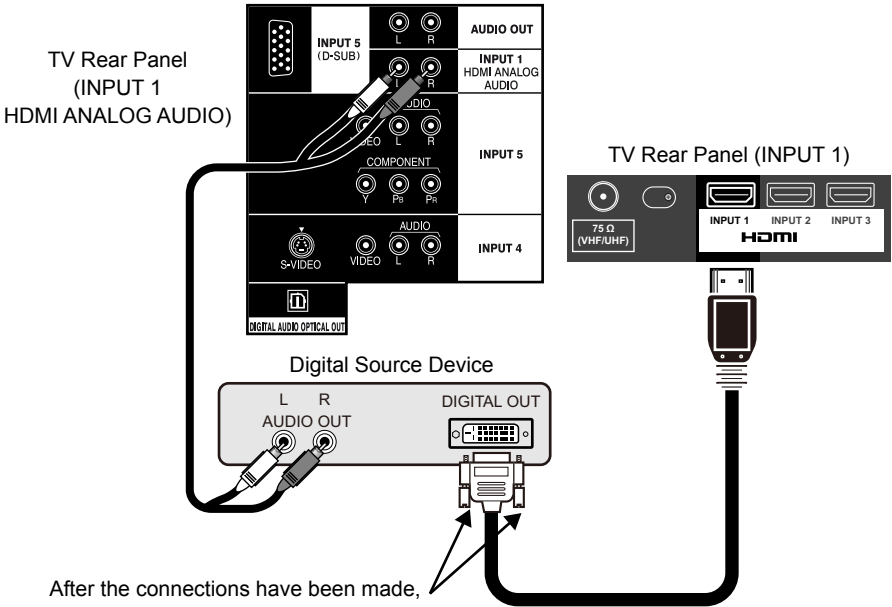

Notes:

- To watch video from your digital source device, make sure your TV is displaying INPUT 1 by pressing the **V1** button on your remote control.
- This TV can accept 480i/60Hz, 480p/60Hz, 720p/60Hz, 1080i/60Hz, 1080p/60Hz, 1080p/30Hz and 1080p/24Hz signals via HDMI.
- The INPUT 1 HDMI ANALOG AUDIO input can only be used with INPUT 1.

Connect a Camcorder

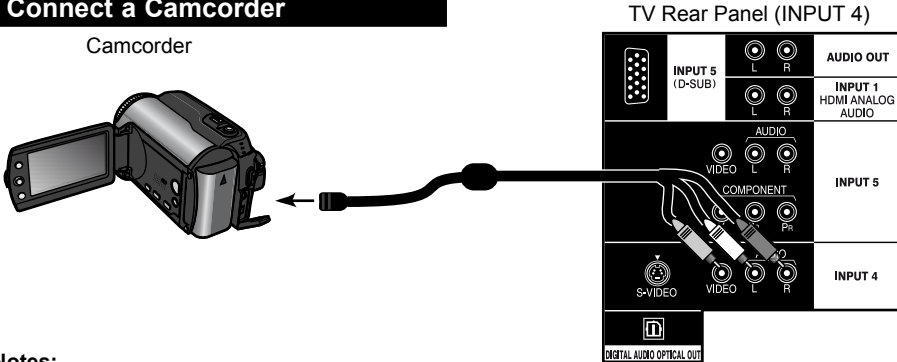

Notes:

- To watch video from your camcorder, make sure your TV is displaying INPUT 4 or INPUT 5 by pressing the **V4** or **V5** button on your remote control.
- If your device has S-Video Output, you can use that instead of using Composite Cables. Connect INPUT 4 (S-VIDEO) and S-Video Output with an S-Video Cable.

Connect a Blu-ray or HDMI Device

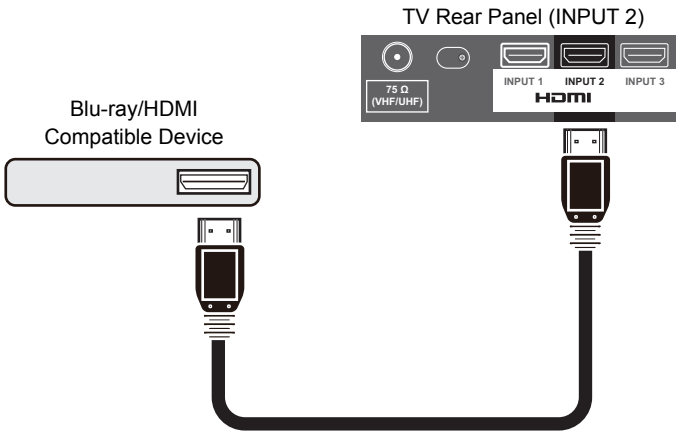

Notes:

- To watch video from your Blu-ray or HDMI device, make sure your TV is displaying INPUT 1, INPUT 2 or INPUT 3 by pressing the **V1**, **V2** or **V3** button on your remote control.
- Some decoders may not respond depending on the equipment that is connected to the HDMI.
- This TV can accept 480i/60Hz, 480p/60Hz, 720p/60Hz, 1080i/60Hz, 1080p/60Hz, 1080p/30Hz and 1080p/24Hz signals via HDMI.
- Some HDMI Output Devices may fail to detect this TV as a 1080p device. If this occurs, manually select 1080p on the HDMI Output Device.

Connecting Your Devices

Connect a Computer

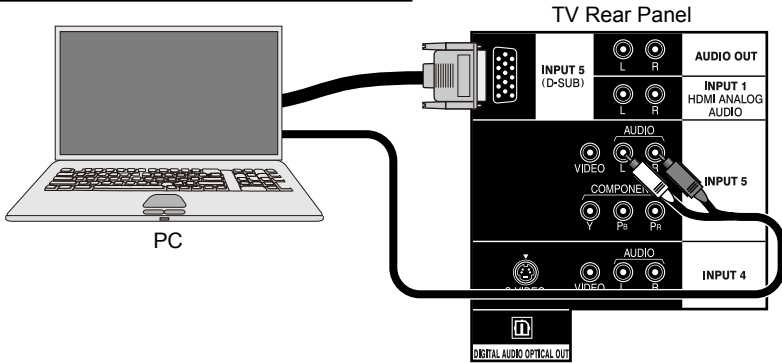

Or...

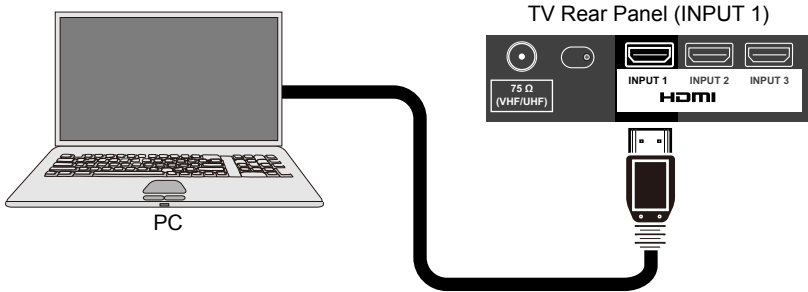

Notes:

- Make sure your TV is displaying INPUT 1, INPUT 2, INPUT 3 or INPUT 5 by pressing the **V1**, **V2**, **V3** or **V5** button on your remote control.
- When you connect a PC using an HDMI-DVI cable, connect an audio cable to INPUT 1 HDMI ANALOG AUDIO on the TV.
- Use a D-SUB cable which has ferrite cores and is no longer than 3 meters to avoid electromagnetic disturbances.
- Refer to your computer's manual for more information.

D-SUB

Format	Resolution	V. Frequency (Hz)	H. Frequency (kHz)
VGA	640 x 480	60	31.5
SVGA	800 x 600	60	37.9
XGA	1024 x 768	60	48.4
WXGA	1280 x 768	60	47.8
WXGA	1360 x 768	60	47.7

HDMI

Format	Resolution	V. Frequency (Hz)	H. Frequency (kHz)
VGA	640 x 480	60	31.5
SVGA	800 x 600	60	37.9
XGA	1024 x 768	60	48.4
WXGA	1280 x 768	60	47.8
WXGA	1360 x 768	60	47.7

Notes:

- Depending on signal quality, some pictures may not be displayed correctly.
- Computers that cannot set the refresh rate to 60 Hz cannot be used with this TV.
- If you are inputting a PC signal that is invalid, **"No signal or Signal can not be displayed."** will appear on the TV screen. It appears when the input is PC and it is a single screen.
- When you connect a PC using an HDMI cable, the TV image may not be displayed correctly.

Troubleshooting

Refer to the table below to check the condition. If you think that there is a problem, contact the JVC Service Center where you purchased the television.

There is no power

- Check that the power cord is plugged in properly.
- Check for a blown fuse or circuit breaker, or a power outage.

There is no picture or sound

- The antenna could be disconnected.
- The tuner could be set improperly. See page 53.
- The TV station may be having difficulties. Check to see if other stations are working.
- Use an HDMI cable with the HDMI logo.
- If you have a device connected to INPUT-1, INPUT-2 or INPUT-3, you will not be able to hear any audio from the AUDIO OUT on the back of the TV.
- You cannot output audio using the DIGITAL AUDIO OPTICAL OUT when you have digital sound from an HDMI device connected to the INPUT-1, INPUT-2 or INPUT-3 connection on the back of the TV.
- This TV can accept 480i (Composite / S / HDMI / Component), 480p, 720p, 1080i and 1080p signals. Please check your settings.

Remote control is not operating properly or at all

- Check to see that the batteries are still working and properly installed.
- Make sure the remote has a clear sight path to the TV.
- You may be too far from the TV. You must be within 23 feet (7 meters).

The power turns off by itself

- Check that the power cord is plugged in properly.
- Perhaps the **Auto Shut Off** is set. See page 43.
- Check to see if the **Sleep Timer** was set. See page 19.

It does not operate correctly

- This television is operated by a microprocessor. It is possible that external noise or interference is causing the problem. If the television does not function correctly, remove the electrical plug from the wall outlet and wait a while before inserting it into the wall outlet again and operating the television.

The color quality is poor

- **Tint** and **Color** may be improperly adjusted. See page 26.
- The **Video Status** mode may be set incorrectly. See page 26.

There are lines across the picture

- There could be interference from another electrical appliance, such as a computer, another TV or a VCR. Move any such appliances further away from the TV.

The picture is spotted

- There could be interference from a high-wattage appliance, like a hairdryer or vacuum, operating nearby. Move the antenna away from the appliance or change to a coaxial cable connection which is less prone to interference.

There are double pictures (ghosts)

- A building or passing airplane may reflect the original signal and produce a second, slightly delayed one. Adjust your antenna position.

Troubleshooting

The picture is snowy (image noise)

- Your antenna may be damaged, disconnected or incorrectly positioned. Check the antenna connection. If the antenna is damaged, replace it.

The screen is 80% black

- The closed caption mode is on. Turn it off in the **Closed Caption** menu. See page 33.

Stereo or bilingual programs cannot be heard

- Make sure the **MTS** settings are correct. See page 41.

Static electricity

- It is normal to feel static electricity if you brush or touch the screen.

You hear occasional crackling sounds

- It is normal for the TV to make crackling sounds when first turned on or off. Unless the sound or picture becomes abnormal, this is fine.

The picture is slightly cut off when you use 1080p format only

- Change the picture format setting on your external device to 1080i or another resolution.

The screen disappears except for the menu screen

- This occurs when you select a digital menu when your input source is from the HDMI connection. Press the **MENU** button.

My HDMI device doesn't work or doesn't work properly

- Please use a High Speed HDMI™ Cable. High Speed HDMI™ Cables are tested to carry an HD signal of up to 1080p and higher.

No signal or signal can not be displayed

- This OSD appears when the digital channel that you have selected is too weak to receive or no signal is being detected for that channel.
- It appears when that channel is not receiving a signal and you have the **Noise Muting** function **Off** and you have a single screen. It moves automatically every two seconds to prevent image burn-in.
- Even if "**No signal or signal can not be displayed**" appears on the screen, your timer functions and auto shut off functions you have set are still active.

The following are not malfunctions.

- The television may make a creaking sound if the temperature of the room or the temperature inside the television changes. If there is no problem with the screen or sound, then there is no need to worry.
- The picture may be temporarily disturbed and noise may be seen on the screen if the power is turned on immediately after it has been turned off. This is not a malfunction.

Specifications

Model	LT-32P510	LT-42P510 LT-42PM51	LT-46P510 LT-46PM51
Type	LCD Television		
Reception Format	NTSC, BTSC System (Multi-Channel Sound) ATSC Terrestrial, Digital Cable		
Reception Range	VHF 2 to 13, UHF 14 to 69 at ATSC, CATV 135 Sub, Mid, Super, Hyper and Ultra bands at Digital Cable		
	VHF 2 to 13, UHF 14 to 69 CATV 135 Sub, Mid, Super, Hyper and Ultra bands (191 channel frequency synthesizer system) at Analog • Reception of channel A-5 ("95" of the TV set's on-screen cable channel numbers) is not recommended for your TV set.		
Power Source	AC 120 V, 60 Hz		
Power Consumption	155 W	200 W	205 W
Screen Size	31.5 inch / 80.13 cm measured diagonally, 16:9 ratio	42 inch / 106.73 cm measured diagonally, 16:9 ratio	45.9 inch / 116.80 cm measured diagonally, 16:9 ratio
Audio Output	10 W + 10 W		
Speakers	4 x 16 cm x 2		
Antenna Terminal (VHF/UHF, ATSC/ DIGITAL CABLE IN)	75 ohms (VHF/UHF) (F-type connector)		
INPUT 4, 5 Terminal	480i S (INPUT 4) Y: 1 Vp-p positive, 75 ohms (negative sync provided) C: 0.286 Vp-p (burst signal), 75 ohms Video: 1 Vp-p, 75 ohms Audio: 500 mVrms (-4dBs) high impedance		
INPUT 5 Terminal (Component Terminal)	1080i / 720p / 480p / 480i Y: 1 Vp-p positive, 75 ohms (negative sync provided) P _B /P _R : 0.7 Vp-p 75 ohms		
INPUT 1, 2, 3 Terminal (HDMI Input Terminal)	Video: 1080p / 1080i / 720p / 480p / 480i Audio: 2ch PCM, 32 / 44.1 / 48 kHz 16 / 20 / 24 bit		
PC Input Jacks	Analog RGB D-SUB (15 pin) x 1		
Audio Output Jacks (FIX)	FIX : 500mVrms (-4dBs), Low Impedance		
Optical Output Digital Audio	Digital Out (optical) x 1		
Dimensions (inch/mm) W X H X D	31 1/4 x 23 1/2 x 9 1/8 (with stand) 792 x 595.7 x 230 (with stand)	40 x 29 x 11 3/4 (with stand) 1013.6 x 733.5 x 296 (with stand)	44 3/8 x 31 1/2 x 11 3/4 (with stand) 1127 x 799.7 x 296 (with stand)
	31 1/4 x 21 1/2 x 4 3/8 (without stand) 792 x 544.6 x 109.6 (without stand)	40 x 26 3/4 x 4 5/8 (without stand) 1013.6 x 677 x 114.8 (without stand)	44 3/8 x 29 3/8 x 4 5/8 (without stand) 1127 x 743.2 x 114.8 (without stand)
Weight (lbs/kg)	27.5 / 12.5 (with stand)	46.2 / 21.0 (with stand)	52.8 / 24.0 (with stand)
	25.8 / 11.7 (without stand)	42.5 / 19.3 (without stand)	49.1 / 22.3 (without stand)



LIMITED WARRANTY

1-1 USA ONLY

ONLY FOR PRODUCT PURCHASED IN U.S.A.

JVC Americas Corp. (JVC) warrants this product and all parts thereof, except as set forth below ONLY TO THE ORIGINAL RETAIL PURCHASER to be FREE FROM DEFECTIVE MATERIALS AND WORKMANSHIP from the date of original purchase for the period shown below. ("The Warranty Period")

PARTS	1 YR	LABOR	1 YR
-------	-------------	-------	-------------

THIS LIMITED WARRANTY IS VALID ONLY IN THE FIFTY (50) UNITED STATES, THE DISTRICT OF COLUMBIA AND IN THE COMMONWEALTH OF PUERTO RICO.

WHAT WE WILL DO:

If this product is found to be defective within the warranty period, JVC will repair or replace defective parts with new or rebuilt equivalents at no charge to the original owner. Such repair and replacement services shall be rendered by JVC during normal business hours at JVC authorized service centers. Parts used for replacement are warranted only for the remainder of the Warranty Period. All products may be brought to a JVC authorized service center on a carry-in basis. Color televisions with a screen size of 37" class or greater qualify for in-home service. In such cases, a technician will come to your home and either repair the TV there or remove and return it if it cannot be repaired in your home.

WHAT YOU MUST DO FOR WARRANTY SERVICE:

Please do not return your product to the retailer
Instead, return your product to the JVC authorized service center nearest you. If shipping the product to the service center, please be sure to package it carefully, preferably in the original packaging, and include a brief description of the problem(s). Please call 1-800-252-5722 to locate the nearest JVC authorized service center. Service locations can also be obtained from our website <http://www.jvc.com>. If your product qualifies for in-home service, the service representative will require clear access to the product.

If you have any questions concerning your JVC Product, please contact our Customer Care Center at 800-252-5722

WHAT IS NOT COVERED:

This limited warranty provided by JVC does not cover:

- Products which have been subject to abuse, accident, alteration, modification, tampering, negligence, misuse, faulty installation, lack of reasonable care, or if repaired or serviced by anyone other than a service facility authorized by JVC to render such service, or if affixed to any attachment not provided with the products, or if the model or serial number has been altered, tampered with, defaced or removed;
- Initial installation, installation and removal from cabinets or mounting systems.
- Operational adjustments covered in the Owner's Manual, normal maintenance, video and audio head cleaning;
- Damage that occurs in shipment, due to act of God, and cosmetic damage;
- Signal reception problems and failures due to line power surge;
- User Removal Memory Devices/Video Pick-up Tubes/CCD Image Sensors are covered for 90 days from the date of purchase;
- Accessories;
- Batteries (except that Rechargeable Batteries are covered for 90 days from the date of purchase);
- Products used for commercial purposes, including, but not limited to rental.
- Loss of data resultant from malfunction of hard drive or other data storage device;

There are no express warranties except as listed above.

THE DURATION OF ANY IMPLIED WARRANTIES, INCLUDING THE IMPLIED WARRANTY OF MERCHANTABILITY, IS LIMITED TO THE DURATION OF THE EXPRESS WARRANTY HEREIN.

JVC SHALL NOT BE LIABLE FOR ANY LOSS OF USE OF THE PRODUCT, INCONVENIENCE, OR ANY OTHER DAMAGES, WHETHER DIRECT, INCIDENTAL OR CONSEQUENTIAL (INCLUDING, WITHOUT LIMITATION, DAMAGE TO TAPES, RECORDS OR DISCS) RESULTING FROM THE USE OF THIS PRODUCT, OR ARISING OUT OF ANY BREACH OF THIS WARRANTY. ALL EXPRESS AND IMPLIED WARRANTIES, INCLUDING THE WARRANTIES OF MERCHANTABILITY AND FITNESS FOR PARTICULAR PURPOSE, ARE LIMITED TO THE WARRANTY PERIOD SET FORTH ABOVE.

Some states do not allow the exclusion of incidental or consequential damages or limitations on how long an implied warranty lasts, so these limitations or exclusions may not apply to you. This warranty gives you specific legal rights and you may also have other rights which vary from state to state.

JVC AMERICAS CORP.
1700 Valley Road, Wayne, New Jersey 07470
<http://www.jvc.com>

REFURBISHED PRODUCTS CARRY A SEPARATE WARRANTY, THIS WARRANTY DOES NOT APPLY. FOR DETAIL OF REFURBISHED PRODUCT WARRANTY, PLEASE REFER TO THE REFURBISHED PRODUCT WARRANTY INFORMATION PACKAGED WITH EACH REFURBISHED PRODUCT.

For customer use:

Enter below the Model No. and Serial No. which is located either on the rear, bottom or side of the cabinet. Retain this information for future reference.

Model No. :	Serial No. :
Purchase date :	Name of dealer :

JVC[®]

TO OUR VALUED CUSTOMER ———

THANK YOU FOR PURCHASING THIS JVC PRODUCT.
WE WANT TO HELP YOU ACHIEVE A PERFECT EXPERIENCE.

**NEED HELP ON HOW TO HOOK UP?
NEED ASSISTANCE ON HOW TO OPERATE?
NEED TO LOCATE A JVC SERVICE CENTER?
LIKE TO PURCHASE ACCESSORIES?**

JVC[®] IS HERE TO HELP!

U.S.A.

TOLL FREE: 1 (800) 252-5722

<http://www.jvc.com>

Canada

TOLL FREE: 1 (800) 964-2650

<http://www.jvc.ca>

Remember to retain your Bill of Sale for Warranty Service.

À NOTRE APPRÉCIÉ CLIENT ———

MERCI D'AVOIR ACHETÉ CE PRODUIT JVC.
NOUS VOULONS VOUS AIDER À OBTENIR UNE EXPÉRIENCE
PARFAITE.

**AVEZ-VOUS BESOIN D'AIDE CONCERNANT LES
RACCORDEMENTS NÉCESSAIRES ?
AVEZ-VOUS BESOIN D'ASSISTANCE SUR LA MANIÈRE
DE FAIRE FONCTIONNER VOTRE PRODUIT ?
DEVEZ-VOUS REPÉRER UN CENTRE DE SERVICE JVC ?
AIMERIEZ-VOUS ACHETER DES ACCESSOIRES ?**

JVC[®] EST À VOTRE DISPOSITION POUR VOUS AIDER !

É.U.

SANS FRAIS : 1 (800) 252-5722

<http://www.jvc.com>

Canada

SANS FRAIS : 1 (800) 964-2650

<http://www.jvc.ca>

N'oubliez pas de conserver votre facture aux fins du service de garantie.

JVC U.S.A.

Division of JVC Americas Corp.
1700 Valley Road
Wayne, New Jersey, 07470

JVC[®]

JVC CANADA, INC.

21 Finchdene Square
Scarborough, Ontario
Canada, M1X 1A7