

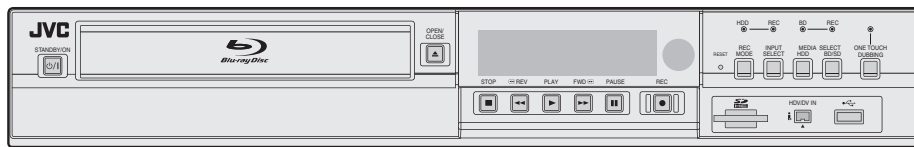

BLU-RAY DISC & HDD RECORDER

SR-HD1700US/SR-HD1350US/
SR-HD1700EU/SR-HD1350EU/
SR-HD1700ER/SR-HD1700AG

INSTRUCTIONS



For Customer Use:

Enter below the Model No. and Serial No. which is located on the body. Retain this information for future reference.

Model No. _____

Serial No. _____

Please read the following before getting started:

Thank you for purchasing this product. Before operating this unit, please read the instructions carefully to ensure the best possible performance.

Safety Precaution

Safety Precaution

Dear Customer,

Thank you for purchasing the JVC BLU-RAY DISC & HDD recorder. Before use, please read the safety information and precautions to ensure safe use of your new unit.

Cautions

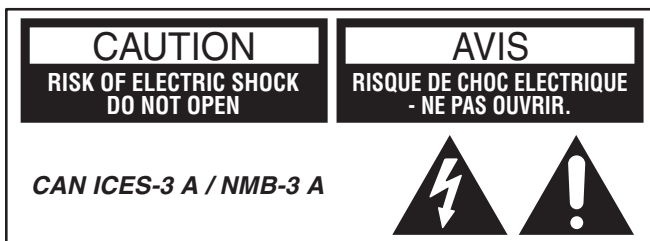

The lightning flash with arrowhead symbol, within an equilateral triangle, is intended to alert the user to the presence of uninsulated "dangerous voltage" within the product's enclosure that may be of sufficient magnitude to constitute a risk of electric shock to persons.



The exclamation point within an equilateral triangle is intended to alert the user to the presence of important operating and maintenance (servicing) instructions in the literature accompanying the appliance.

CAUTION:

A UNIT IS A CLASS 1 LASER PRODUCT. HOWEVER THIS UNIT USES A VISIBLE LASER BEAM WHICH COULD CAUSE HAZARDOUS RADIATION EXPOSURE IF DIRECTED. BE SURE TO OPERATE THE UNIT CORRECTLY AS INSTRUCTED.

WHEN THIS UNIT IS PLUGGED INTO THE WALL OUTLET, DO NOT PLACE YOUR EYES CLOSE TO THE OPENING OF THE DISC TRAY AND OTHER OPENINGS TO LOOK INTO THE INSIDE OF THIS UNIT.

USE OF CONTROLS OR ADJUSTMENTS OR PERFORMANCE OF PROCEDURES OTHER THAN THOSE SPECIFIED HEREIN MAY RESULT IN HAZARDOUS RADIATION EXPOSURE.

DO NOT OPEN COVERS AND DO NOT REPAIR YOURSELF. REFER SERVICING TO QUALIFIED PERSONNEL.

MISE EN GARDE:

CET APPAREIL EST UN PRODUIT LASER DE CLASSE 1. CEPENDANT, CET APPAREIL UTILISE UN FAISCEAU LASER VISIBLE QUI PEUT ENTRAÎNER UNE EXPOSITION DANGEREUSE AUX RAYONNEMENTS. S'ASSURER DE FAIRE FONCTIONNER L'APPAREIL CORRECTEMENT, EN RESPECTANT LES INSTRUCTIONS.

LORSQUE CET APPAREIL EST BRANCHÉ À UNE PRISE MURALE, NE PAS PLACER SES YEUX PRÈS DE L'OUVERTURE DU TIROIR POUR DISQUE OU D'AUTRES OUVERTURES DANS LE BUT D'OBSERVER L'INTÉRIEUR DE L'APPAREIL.

L'UTILISATION DES COMMANDES, RÉGLAGES OU PROCÉDURES DE PERFORMANCE AUTRE QUE CELLE SPÉCIFIÉE DANS CE DOCUMENT RISQUE D'ENTRAÎNER UNE EXPOSITION DANGEREUSE AUX RAYONNEMENTS.

L'UTILISATEUR NE DOIT PAS OUVRIR NI RÉPARER L'APPAREIL DE LUI-MÊME. FAIRE APPEL À UN PERSONNEL QUALIFIÉ POUR L'ENTRETIEN.

CLASS 1 LASER PRODUCT

REPRODUCTION OF LABELS

WARNING LABEL INSIDE OF THE UNIT



This unit apply to the standard "IEC60825-1:2007" for laser products.

WARNING:

TO PREVENT FIRE OR SHOCK HAZARD, DO NOT EXPOSE THIS UNIT TO RAIN OR MOISTURE.

CAUTION:

This unit should be used with AC 120V~, 60Hz only. To prevent electric shocks and fire hazards, DO NOT use any other power source.

CAUTION:

TO PREVENT ELECTRIC SHOCK, MATCH WIDE BLADE OF PLUG TO WIDE SLOT, FULLY INSERT.

ATTENTION:

POUR ÉVITER LES CHOCS ÉLECTRIQUES, INTRODUIRE LA LAME LA PLUS LARGE DE LA FICHE DANS LA BORNE CORRESPONDANTE DE LA PRISE ET POUSSER JUSQU'AU FOND.

Note to CATV system installer:

This reminder is provided to call the CATV system installer's attention to Article 820-40 of the NEC that provides guidelines for proper grounding and, in particular, specifies that the cable ground shall be connected to the grounding system of the building, as close to the point of cable entry as practical.

"WARNING" and the following or equivalent. "To reduce the risk of fire or electric shock, do not expose this apparatus to rain or moisture."

"ATTENTION" et suivant ou équivalent. "Pour limiter les risques d'incendie ou d'électrocution, n'exposez pas cet appareil à la pluie ou à l'humidité."

A warning that an apparatus with CLASS I construction shall be connected to a MAINS socket outlet with protective earthing connection.

Avertissement: un appareil de CLASSE I doit être branché à une prise SECTEUR comprenant une mise à la terre de protection.

WARNING

Batteries shall not be exposed to excessive heat such as sunshine, fire or the like.

When the main plug or appliance coupler shall remain readily operable.

IMPORTANT SAFETY INSTRUCTIONS

- 1) Read these instructions.
- 2) Keep these instructions.
- 3) Heed all warnings.
- 4) Follow all instructions.
- 5) Do not use this apparatus near water.
- 6) Clean only with dry cloth.
- 7) Do not block any ventilation openings. Install in accordance with the manufacturer's instructions.
- 8) Do not install near any heat sources such as radiators, heat registers, stoves, or other apparatus (including amplifiers) that produce heat.
- 9) Do not defeat the safety purpose of the polarized or grounding-type plug. A polarized plug has two blades with one wider than the other. A grounding type plug has two blades and a third grounding prong. The wide blade or the third prong are provided for your safety. If the provided plug does not fit into your outlet, consult an electrician for replacement of the obsolete outlet.
- 10) Protect the power cord from being walked on or pinched particularly at plugs, convenience receptacles, and the point where they exit from the apparatus.
- 11) Only use attachments/accessories specified by the manufacturer.
- 12) Use only with the cart, stand, tripod, bracket, or table specified by the manufacturer, or sold with the apparatus. When a cart is used, use caution when moving the cart/apparatus combination to avoid injury from tip-over.
- 13) Unplug this apparatus during lightning storms or when unused for long periods of time.
- 14) Refer all servicing to qualified service personnel. Servicing is required when the apparatus has been damaged in any way, such as power-supply cord or plug is damaged, liquid has been spilled or objects have fallen into the apparatus, the apparatus has been exposed to rain or moisture, does not operate normally, or has been dropped.



Failure to heed the following precautions may result in damage to the unit, remote control or disc/cassette.

1. **DO NOT place the unit —**
 - in an environment prone to extreme temperatures or humidity.
 - in direct sunlight.
 - in a dusty environment.
 - in an environment where strong magnetic fields are generated.
 - on a surface that is unstable or subject to vibration.
2. **DO NOT block the unit's ventilation openings or holes.** (If the ventilation openings or holes are blocked by a newspaper or cloth, etc., the heat may not be able to get out.)
3. **DO NOT place heavy objects on the unit or remote control.**
4. **DO NOT place anything which might spill on top of the unit or remote control.** (If water or liquid is allowed to enter this equipment, fire or electric shock may be caused.)
5. **DO NOT expose the apparatus to dripping or splashing.**
6. **DO NOT use this equipment in a bathroom or places with water.** Also **DO NOT** place any containers filled with water or liquids (such as cosmetics or medicines, flower vases, potted plants, cups, etc.) on top of this unit.
7. **DO NOT place any naked flame sources, such as lighted candles, on the apparatus.**
8. **AVOID violent shocks to the unit during transport.**

CAUTION:

Changes or modifications not approved by JVC could void user's authority to operate the equipment.

This device complies with Part 15 of FCC Rules.

Operation is subject to the following two conditions:

(1) This device may not cause harmful interference, and (2) this device must accept any interference received, including interference that may cause undesired operation.

"This equipment has been tested and found to comply with the limits for a Class A digital device, pursuant to Part 15 of the FCC Rules. These limits are designed to provide reasonable protection against harmful interference when the equipment is operated in a commercial environment.

This equipment generates, uses, and can radiate radio frequency energy and, if not installed and used in accordance with the instruction manual, may cause harmful interference to radio communications.

Operation of this equipment in a residential area is likely to cause harmful interference in which case the user will be required to correct the interference at his own expense."

When the equipment is installed in a cabinet or a shelf, make sure that it has sufficient space on all sides to allow for ventilation (10cm or more on both sides, on top and at the rear).

When discarding batteries, environmental problems must be considered and the local rules or laws governing the disposal of these batteries must be followed strictly.

Use the supplied power cord.

(If not, fire or electric shock may be caused.)

DON'T continue to operate the equipment if you are in any doubt about it working normally, or if it is damaged in any way—switch off, withdraw the mains plug and consult your dealer.

DO be careful with glass panels or doors on equipment.

DO consult you dealer if you are ever in doubt about the installation, operation or safety of your equipment.

NEVER let anyone especially children push anything into holes, slots or any other opening in the case—this could result in a fatal electrical shock.

MOISTURE CONDENSATION

Moisture in the air will condense on the unit when you move it from a cold place to a warm place, or under extremely humid conditions—just as water droplets form on the surface of a glass filled with cold liquid. In conditions where condensation may occur, disconnect the unit's power plug from the wall and keep it disconnected for a few hours to let the moisture dry, then turn on the unit.

Safety Precaution



- Manufactured under license from Dolby Laboratories. Dolby and the double-D symbol are trademarks of Dolby Laboratories.
- For DTS patents, see <http://patents.dts.com>. Manufactured under license from DTS Licensing Limited. DTS, DTS-HD, the Symbol, & DTS and the Symbol together are registered trademarks of DTS, Inc.
© DTS, Inc. All Rights Reserved.
- This product incorporates copyright protection technology that is protected by U.S. patents and other intellectual property rights. Use of this copyright protection technology must be authorized by Rovi Corporation, and is intended for home and other limited viewing uses only unless otherwise authorized by Rovi Corporation. Reverse engineering or disassembly is prohibited.
- DVD logo is a registered trademark of DVD Format/Logo Licensing Corporation.
- HDMI, the HDMI Logo and High-Definition Multimedia Interface are trademarks or registered trademarks of HDMI Licensing LLC in the United States and other countries.
- Blu-ray Disc and the Blu-ray Disc logo are trademarks of Blu-ray Disc Association.
- "x.v.Color" and the "x.v.Color" logo are trademarks of Sony Corporation Co., Ltd.
- Java and all Java-based trademarks and logos are trademarks or registered trademarks of Sun Microsystems, Inc. in the United States and other countries.
- The SDHC logo is a trademark of SD-3C, LLC.
- i.LINK and the i.LINK logo are trademarks.
- "AVCHD" and the "AVCHD" logo are trademarks of Panasonic Corporation and Sony Corporation.
- Windows and Internet Explorer are either registered trademarks or trademarks of Microsoft Corporation in the United States and/or other countries.
- Mac OS is trademark of Apple Inc., registered in the U.S. and other countries.
- This product is licensed under the AVC patent portfolio license and VC-1 patent portfolio license for the personal and non-commercial use of a consumer to (i) encode video in compliance with the AVC Standard and VC-1 Standard ("AVC/VC-1 Video") and/or (ii) decode AVC/VC-1 Video that was encoded by a consumer engaged in a personal and non-commercial activity and/or was obtained from a video provider licensed to provide AVC/VC-1 Video. No license is granted or shall be implied for any other use. Additional information may be obtained from MPEG LA, LLC. See <http://www.mpegla.com>.

Batteries—Incorrect use of batteries may cause the batteries to burst or ignite. A leaky battery may corrode the equipment, dirty your hands or spoil your clothing. In order to avoid these problems, make sure to observe the precautions below:

- Use the specified batteries only.
- Install the batteries with due attention to the plus (+) and minus (-) sides of the batteries according to the instructions in the compartment.
- Do not mix old and new batteries.
- Do not mix batteries of different types. Voltage specifications of batteries of the same shape may vary.
- Replace an exhausted battery with a new one promptly.
- If you will not use the remote control for a long time, remove the batteries.
- If leaked battery fluid gets on your skin or clothing, rinse immediately and thoroughly. If it gets into your eye, bathe your eye well rather than rubbing and seek medical treatment immediately. Leaked battery fluid that gets into your eye or your clothing may cause a skin irritation or damage your eye.
- Do not put the batteries in a place where young children can reach.

DISCLAIMER OF LIABILITY

JVC shall not be liable for any loss relating to the unit's failure to properly record, store or playback any content (video, audio or otherwise) for any reason whatsoever. Any applicable warranties shall only cover replacement or repair of the effected unit, and shall not apply to recovery or replacement of lost content.

ATTENTION:

- Using a mobile phone in the vicinity of the unit may cause picture vibration on the TV screen or change the screen to a black back display.
- Some TVs or other appliances generate strong magnetic fields. Do not place such appliances on top of the unit as it may cause picture disturbance.
- When moving the product, press \odot /I to turn off the power, and wait at least 30 seconds before unplugging the power cord. Then, wait at least 2 minutes before moving the product.
- If there is a power outage when using the unit, the recorded data may be erased.
- It is recommended to back up discs which contain important recordings periodically (every few years). As digital signals do not deteriorate, failure to play back or record might arise due to the effects of the disc aging through the years depending on the storage environment.
- Recorded programs and data cannot be restored once the disc or tape is damaged.

- This unit can play back and record only NTSC signals.
- The hard disk is a consumable item. Replacement is recommended after 10000 hours of use (if use in a 25°C environment). For information on maintenance planning and costs, consult your nearest JVC dealer.
- The fan motor is a consumable item. Replacement is recommended after 30000 hours of use (if use in a 25°C environment). For information on maintenance planning and costs, consult your nearest JVC dealer.

HOW TO USE THIS INSTRUCTION MANUAL

- All major sections and subsections are listed in the Table Of Contents on page 8. Use this when searching for information on a specific procedure or feature.
- The  mark signals a reference to another page for instructions or related information.
- Operation buttons necessary for the various procedures are clearly indicated through the use of illustrations at the beginning of each major section.

BEFORE YOU INSTALL YOUR NEW UNIT . . .

. . . please read the sections/literature listed below.

- "Cautions" on page 2
- "IMPORTANT SAFETY INSTRUCTIONS" on page 3 to 4

The rating plate and the safety caution are on the rear of the unit.

WARNING : DANGEROUS VOLTAGE INSIDE
WARNING : TO PREVENT FIRE OR SHOCK HAZARD, DO NOT EXPOSE THIS UNIT TO RAIN OR MOISTURE.

CAUTION:

A UNIT IS A CLASS 1 LASER PRODUCT. HOWEVER THIS UNIT USES A VISIBLE LASER BEAM WHICH COULD CAUSE HAZARDOUS RADIATION EXPOSURE IF DIRECTED. BE SURE TO OPERATE THE UNIT CORRECTLY AS INSTRUCTED.

WHEN THIS UNIT IS PLUGGED INTO THE WALL OUTLET, DO NOT PLACE YOUR EYES CLOSE TO THE OPENING OF THE DISC TRAY AND OTHER OPENINGS TO LOOK INTO THE INSIDE OF THIS UNIT.

USE OF CONTROLS OR ADJUSTMENTS OR PERFORMANCE OF PROCEDURES OTHER THAN THOSE SPECIFIED HEREIN MAY RESULT IN HAZARDOUS RADIATION EXPOSURE.

DO NOT OPEN COVERS AND DO NOT REPAIR YOURSELF. REFER SERVICING TO QUALIFIED PERSONNEL.

CLASS 1 LASER PRODUCT

REPRODUCTION OF LABELS

WARNING LABEL INSIDE OF THE UNIT

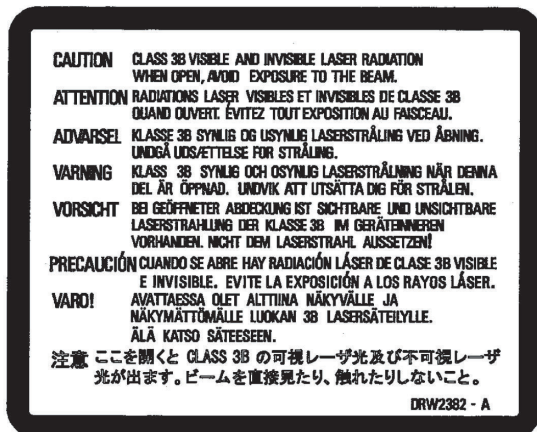

This unit apply to the standard “IEC60825-1:2007” for laser products.

Dear Customer, [European Union]

This apparatus is in conformance with the valid European directives and standards regarding electromagnetic compatibility and electrical safety.

European representative of JVC KENWOOD Corporation is:
 JVC Technical Services Europe GmbH
 Konrad-Adenauer-Allee 1-11
 61118 Bad Vilbel
 German

WARNING

This is a Class A product. In a domestic environment this product may cause radio interference in which case the user may be required to take adequate measures.

IMPORTANT:

- Please read the various precautions on page 5 to 7 before installing or operating the unit.
- It should be noted that it may be unlawful to re-record pre-recorded tapes, DVDs, or discs without the consent of the owner of copyright in the sound or video recording, broadcast or cable programme and in any literary, dramatic, musical, or artistic work embodied therein.

CAUTION:

- When you are not using the unit for a long period of time, it is recommended that you disconnect the power cord from the mains outlet.
- Dangerous voltage inside. Refer internal servicing to qualified service personnel. To prevent electric shock or fire hazard, remove the power cord from the mains outlet prior to connecting or disconnecting any signal lead or aerial.
- The mains plug shall remain readily operable.

The STANDBY/ON \odot /I button does not completely shut off mains power from the unit, but switches operating current on and off. “ \odot ” shows electrical power standby and “I” shows ON.

A warning that an apparatus with CLASS I construction shall be connected to a MAINS socket outlet with protective earthing connection.

WARNING

Batteries shall not be exposed to excessive heat such as sunshine, fire or the like.

Main Plug

The Main Plug is used as the disconnect device, the disconnect device shall remain readily operable

Even if the display window of the unit is unlit, the main power supply is not cut off unless the power cord is unplugged.

The main power supply for this unit is controlled by inserting or removing the power plug.

Failure to heed the following precautions may result in damage to the unit, remote control or disc.

1. **DO NOT** place the unit —
 - in an environment prone to extreme temperatures or humidity.
 - in direct sunlight.
 - in a dusty environment.
 - in an environment where strong magnetic fields are generated.
 - on a surface that is unstable or subject to vibration.
2. **DO NOT** block the unit's ventilation openings or holes. (If the ventilation openings or holes are blocked by a newspaper or cloth, etc., the heat may not be able to get out.)
3. **DO NOT** place heavy objects on the unit or remote control.
4. **DO NOT** place anything which might spill on top of the unit or remote control. (If water or liquid is allowed to enter this equipment, fire or electric shock may be caused.)
5. **DO NOT** expose the apparatus to dripping or splashing.
6. **DO NOT** use this equipment in a bathroom or places with water. Also **DO NOT** place any containers filled with water or liquids (such as cosmetics or medicines, flower vases, potted plants, cups, etc.) on top of this unit.
7. **DO NOT** place any naked flame sources, such as lighted candles, on the apparatus.
8. **AVOID** violent shocks to the unit during transport.

Safety Precaution

POWER CONNECTION

The power supply voltage rating of this product is AC 220 – 240 V (For European countries, Asian countries, and United Kingdom).

The power cord attached conforms to the following power supply voltage and countries. Use only the power cord designated to ensure safety and EMC regulations of each country.

For European and Asian countries: AC 220 – 240 V

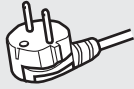

For United Kingdom: AC 220 – 240 V



This plug will fit only into a grounded power outlet. If you are unable to insert the plug into the outlet, contact your electrician to install the proper outlet. Do not defeat the safety purpose of the grounded plug.

- This product should be operated only with the type of power source indicated on the label. If you are not sure of the type of power supply of your home, consult your product dealer or local electric power company.

Warning:

- Do not use the same power cord for AC 120 V as for AC 220 – 240 V. Doing so may cause malfunction, electric shock or fire.

Note for United Kingdom power cord only

The plug of United Kingdom power cord has a built-in fuse. When replacing the fuse, be sure to use only a correctly rated approved type, re-fit the fuse cover. (Consult your dealer or qualified personnel.)

How to replace the fuse

Open the fuse compartment with the blade screwdriver, and replace the fuse.

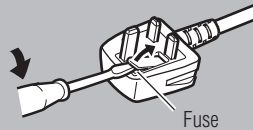

When the equipment is installed in a cabinet or a shelf, make sure that it has sufficient space on all sides to allow for ventilation (10 cm or more on both sides, on top and at the rear).

When discarding batteries, environmental problems must be considered and the local rules or laws governing the disposal of these batteries must be followed strictly.

Use the supplied power cord.

(If not, fire or electric shock may be caused.)

DON'T continue to operate the equipment if you are in any doubt about it working normally, or if it is damaged in any way -- switch off, with draw the mains plug and consult your dealer.

DO be careful with glass panels or doors on equipment.

DO consult you dealer if you are ever in doubt about the installation, operation or safety of your equipment.

NEVER let anyone especially children push anything into holes, slots or any other opening in the case -- this could result in a fatal electrical shock.

MOISTURE CONDENSATION

Moisture in the air will condense on the unit when you move it from a cold place to a warm place, or under extremely humid conditions—just as water droplets form on the surface of a glass filled with cold liquid. In conditions where condensation may occur, disconnect the unit's power plug from the wall and keep it disconnected for a few hours to let the moisture dry, then turn on the unit.

Batteries -- Incorrect use of batteries may cause the batteries to burst or ignite. A leaky battery may corrode the equipment, dirty your hands or spoil your clothing. In order to avoid these problems, make sure to observe the precautions below:

- Use the specified batteries only.
- Install the batteries with due attention to the plus (+) and minus (-) sides of the batteries according to the instructions in the compartment.
- Do not mix old and new batteries.
- Do not mix batteries of different types. Voltage specifications of batteries of the same shape may vary.
- Replace an exhausted battery with a new one promptly.
- If you will not use the remote control for a long time, remove the batteries.
- If leaked battery fluid gets on your skin or clothing, rinse immediately and thoroughly. If it gets into you eye, bathe your eye well rather than rubbing and seek medical treatment immediately. Leaked battery fluid that gets into your eye or your clothing may cause a skin irritation or damage your eye.
- Do not put the batteries in a place where young children can reach.

This equipment has been designed and manufactured to meet international safety standards but, like any electrical equipment, care must be taken if you are to obtain the best results and safety is to be assured.

- DO read the operating instructions before you attempt to use the equipment.
- DO ensure that all electrical connections (including the mains plug, extension leads and interconnections between pieces of equipment) are properly made and in accordance with the manufacturer's instructions. Switch off and withdraw the mains plug when making or changing connections.
- DO consult your dealer if you are ever in doubt about the installation, operation or safety of your equipment.
- DO be careful with glass panels or doors on equipment.
- DON'T continue to operate the equipment if you are in any doubt about it working normally, or if it is damaged in any way—switch off, withdraw the mains plug and consult your dealer.
- DON'T remove any fixed cover as this may expose dangerous voltages.
- DON'T leave equipment switched on when it is unattended unless it is specifically stated that it is designed for unattended operation or has a standby mode. Switch off using the switch on the equipment and make sure that your family knows how to do this. Special arrangements may need to be made for infirm or handicapped people.
- DON'T use equipment such as personal stereos or radios so that you are distracted from the requirements of road safety. It is illegal to watch television whilst driving.
- DON'T listen to headphones at high volume, as such use can permanently damage your hearing.
- DON'T obstruct the ventilation of the equipment, for example with curtains or soft furnishings. Overheating will cause damage and shorten the life of the equipment.
- DON'T use makeshift stands and NEVER fix legs with wood screws—to ensure complete safety always fit the manufacturer's approved stand or legs with the fixings provided according to the instructions.
- DON'T allow electrical equipment to be exposed to rain or moisture.

ABOVE ALL...

- NEVER let anyone especially children push anything into holes, slots or any other opening in the case—this could result in a fatal electrical shock;
- NEVER guess or take chances with electrical equipment of any kind—it is better to be safe than sorry!

DISCLAIMER OF LIABILITY

JVC shall not be liable for any loss relating to the unit's failure to properly record, store or playback any content (video, audio or otherwise) for any reason whatsoever. Any applicable warranties shall only cover replacement or repair of the effected unit, and shall not apply to recovery or replacement of lost content.

ATTENTION:

- Using a mobile phone in the vicinity of the unit may cause picture vibration on the TV screen or change the screen to a black back display.
- Some TVs or other appliances generate strong magnetic fields. Do not place such appliances on top of the unit as it may cause picture disturbance.
- When moving the product, press \odot /I to turn off the power, and wait at least 30 seconds before unplugging the power cord. Then, wait at least 2 minutes before moving the product.
- If there is a power outage when using the unit, the recorded data may be erased.
- It is recommended to back up discs which contain important recordings periodically (every few years). As digital signals do not deteriorate, failure to play back or record might arise due to the effects of the disc aging through the years depending on the storage environment.
- Recorded programmes and data cannot be restored once the disc or tape is damaged.



- Manufactured under licence from Dolby Laboratories. Dolby and the double-D symbol are trademarks of Dolby Laboratories.
- For DTS patents, see <http://patents.dts.com>. Manufactured under license from DTS Licensing Limited. DTS, DTS-HD, the Symbol, & DTS and the Symbol together are registered trademarks of DTS, Inc. © DTS, Inc. All Rights Reserved.
- This product incorporates copyright protection technology that is protected by U.S. patents and other intellectual property rights. Use of this copyright protection technology must be authorized by Rovi Corporation, and is intended for home and other limited viewing uses only unless otherwise authorized by Rovi Corporation. Reverse engineering or disassembly is prohibited.
- DVD logo is a registered trademark of DVD Format/Logo Licensing Corporation.
- HDMI, the HDMI Logo and High-Definition Multimedia Interface are trademarks or registered trademarks of HDMI Licensing LLC in the United States and other countries.
- Blu-ray Disc and the Blu-ray Disc logo are trademarks of Blu-ray Disc Association.
- "x.v.Colour" and the "x.v.Colour" logo are trademarks of Sony Corporation Co., Ltd.
- Java and all Java-based trademarks and logos are trademarks or registered trademarks of Sun Microsystems, Inc. in the United States and other countries.
- The SDHC logo is a trademark of SD-3C, LLC.
- i.LINK and the i.LINK logo are trademarks.
- "AVCHD" and the "AVCHD" logo are trademarks of Panasonic Corporation and Sony Corporation.
- Windows and Internet Explorer are either registered trademarks or trademarks of Microsoft Corporation in the United States and/or other countries.
- Mac OS is trademark of Apple Inc., registered in the U.S. and other countries.
- This product is licensed under the AVC patent portfolio license and VC-1 patent portfolio license for the personal and noncommercial use of a consumer to (i) encode video in compliance with the AVC Standard and VC-1 Standard ("AVC/VC-1 Video") and/or (ii) decode AVC/VC-1 Video that was encoded by a consumer engaged in a personal and non-commercial activity and/or was obtained from a video provider licensed to provide AVC/VC-1 Video. No license is granted or shall be implied for any other use. Additional information may be obtained from MPEG LA, LLC. See <http://www.mpegla.com>.
- This unit can play back and record only PAL signals. NTSC signals can also be played back on the BD/DVD deck.
- The hard disk is a consumable item. Replacement is recommended after 10000 hours of use (if use in a 25°C environment). For information on maintenance planning and costs, consult your nearest JVC dealer.
- The fan motor is a consumable item. Replacement is recommended after 30000 hours of use (if use in a 25°C environment). For information on maintenance planning and costs, consult your nearest JVC dealer.

BEFORE YOU INSTALL YOUR NEW UNIT . . .

. . . please read the sections/literature listed below.

- "Cautions" on page 5
- "IMPORTANT SAFETY INSTRUCTIONS" on page 6 to 7

Contents

Contents

Safety Precaution

| | |
|-------------------------|---|
| Safety Precaution | 2 |
|-------------------------|---|

Contents

Getting Started

| | |
|---------------------------------------|----|
| Key Features | 9 |
| How to Read this Manual | 9 |
| Other Precautionary Notes | 10 |
| Hard Disk Drive (HDD) | 11 |
| SD Cards | 11 |
| Discs | 12 |
| Precautions on the Use of Discs | 14 |
| On-screen Displays | 15 |
| Name and Function of Parts | 16 |
| Front panel | 16 |
| Display window | 17 |
| Rear panel | 17 |
| Remote control | 18 |

Preparation

| | |
|--|----|
| Connecting a Monitor | 20 |
| Connecting an Amplifier | 21 |
| Connecting a Video Deck or Other Equipment | 21 |
| Connecting External Devices | 22 |
| Connecting the Power Supply | 22 |
| Setting and Displaying Date/Time | 23 |

Dubbing/Importing

| | |
|---|----|
| Dubbing/Importing | 26 |
| Dubbing chart | 27 |
| Formatting | 28 |
| Recording Modes | 31 |
| Importing Data to the HDD Using the ONE TOUCH DUBBING Button | 33 |
| Importing Data from a BD/DVD to the HDD | 34 |
| Importing Data from a USB-compatible Device to the HDD | 37 |
| Importing Data from an SD Card to the HDD | 39 |
| Importing Data from an i.LINK-compatible Device to the HDD | 41 |
| Importing Data from a LAN-compatible Device to the HDD (only for SR-HD1700) | 43 |
| Dubbing a Title from the HDD to a BD/DVD | 44 |
| Dubbing Still Images from the HDD | 47 |
| Enabling Playback on Other Devices (Finalizing) | 49 |
| Copying the Entire Disc | 51 |

Recording

| | |
|---------------------------------------|----|
| Direct recording to discs | 53 |
| Recording Using External Inputs | 53 |

Playing Back

| | |
|---------------------------------|----|
| About Playing Back | 55 |
| Using Playback Navigation | 55 |

| | |
|-----------------------------------|----|
| Option menu list | 57 |
| Video Playback Operation | 58 |
| Playing Videos on a BD/DVD | 60 |
| Playing Videos on the HDD | 61 |
| Playing Videos on a SD Card | 61 |
| Playing Still Images (JPEG) | 62 |
| Changing Playback Settings | 63 |
| Playback Settings Menu | 63 |
| Audio/subtitle settings | 63 |
| Playback settings | 63 |
| Video settings | 64 |

Editing

| | |
|--|----|
| Editing | 65 |
| Entering Characters | 66 |
| Character List | 67 |
| Grouping | 68 |
| Changing the Title/Group Name | 70 |
| Deleting a Title/Group | 70 |
| Turning On Title/Group Protection | 71 |
| Turning Off Title/Group Protection | 72 |
| Creating a Playlist | 73 |
| Editing a Thumbnail | 74 |
| Editing a Chapter | 75 |
| Dividing | 77 |
| Delete Scenes | 78 |
| Changing the Disc Name | 80 |
| Changing the Shooting Date/Time | 80 |
| Mode conversion | 81 |

Settings Menu

| | |
|--|----|
| Changing Settings of this Unit | 82 |
| Setting Menu List | 82 |
| SETUP | 83 |
| PLAYBACK SETTING | 84 |
| RECORD | 85 |
| AUDIO | 86 |
| DISPLAY | 88 |
| CONNECTION | 88 |
| NETWORK SETTING (only for SR-HD1700) | 90 |

Others

| | |
|--|-----|
| Locking the Disc Tray | 91 |
| Turning on the Mode Lock | 91 |
| Last Function Memory | 91 |
| External Control (only for SR-HD1700) | 92 |
| RS-232C Specifications | 92 |
| LAN Connection | 92 |
| Command Table | 93 |
| Command | 94 |
| Language Code List | 104 |
| Country Code List | 106 |
| Using the HDMI Consumer Electronics Control (HDMI CEC) | 108 |
| Creating a Seamless BD | 108 |
| Troubleshooting | 109 |
| Frequently Asked Questions on Dubbing | 112 |
| Remarks | 113 |
| Specifications | 114 |
| Important Notice Concerning the Software | 115 |
| Index | 119 |

Key Features

Professional Blu-ray Disc recorder of the high-definition era

Copy videos to a Blu-ray Disc in high-definition from a high-definition camcorder, or down convert the videos and record them onto DVDs, all without the need for a PC. The internal hard disk drive enables for easy editing and dubbing multiple discs.

Supports direct recording to discs

You can record contents directly to an optical disc (BD-R/RE, DVD-R/RW).

Interface with JVC ProHD MEMORY CARD CAMERA RECORDER GY-HM series

Supports the import of "SP mode" (*1) and "HQ mode" (*2) files in the MOV format recorded using the JVC ProHD MEMORY CARD CAMERA RECORDER GY-HM series, or the MXF format recorded using the JVC ProHD MEMORY CARD CAMERA RECORDER GY-HM650. Import to the HDD and dubbing to discs are supported.

MOV format

- (*1) SP mode : 1280x720/60p, 30p, 24p, 1440x1080/60i (for NTSC)
1280x720/50p, 25p, 1440x1080/50i (for PAL)
- (*2) HQ mode : 1280x720/60p, 30p, 24p, 1440x1080/60i, 1920x1080/60i, 30p, 24p (for NTSC)
1280x720/50p, 25p, 1440x1080/50i, 1920x1080/50i, 25p (for PAL)

MXF format

- (*1) SP mode : 1440x1080/60i (for NTSC)
1440x1080/50i (for PAL)
- (*2) HQ mode : 1440x1080/60i, 1920x1080/60i, 30p, 24p (for NTSC)
1440x1080/50i, 1920x1080/50i, 25p (for PAL)

Compatibility with other consumer camcorders

In addition to AVCHD, HDV and DV, JVC Everio file formats are also compatible, and digital dubbing can be done.

Digital interface that allows for camcorder compatibility

This unit is equipped with USB, SD slots and i.Link input terminals for connecting the camcorder.

Create menu-supported Blu-ray discs

Blu-ray discs can be created using the BDMV (with menu) format. (*1) BDAV discs can also be created and dubbed according to the intended use. This unit also enable users to use an original image as the background.

- (*1) : Menu cannot be created when recording directly to a BDMV format disc.

Compatible with dual layer 50 GB Blu-ray discs, and records up to 24 hours of full high-definition images in a single disc

This unit is also compatible with high capacity dual layer 50 GB Blu-ray discs, and up to 24 hours (AE mode) of full high-definition images can be recorded in a single disc. Writing to inexpensive LTH discs is also supported.

Authoring menu enables discs to be created and used industrially such as for demonstrations

Disc authoring can be used to create discs for industrial use, such as discs that repeat playback automatically.

Equipped with external control RS-232C terminal (only for SR-HD1700)

This unit is equipped with an RS-232C terminal that allows for external control using a PC.

How to Read this Manual

About this manual

This manual mainly describes operation procedures using the remote control unit buttons.

- The buttons on the remote control unit are indicated as [Button Name].
- The menu items are indicated as "Menu Item".

■ Supplementary remarks in the main text

Memo : States restrictions on the functions or use of this unit.
Note : States precautions to be taken during operation.
☞ : Indicates the page numbers or items to refer to.

Memo:

The displays of operable media are highlighted.

HDD : Hard disk
DVD : DVD
BD : Blu-ray disc
SD : SD card
SDHC : SDHC Card
CD : Music compact disc
JPEG : JPEG (still picture) file disc

■ Contents of this manual

- All rights reserved by JVC KENWOOD Corporation. Unauthorized duplication or reprinting of this manual, in whole or in part, is strictly prohibited.
- Other product names included in this manual are trademarks and/or registered trademarks of their respective companies. Marks such as ™, ® and © have been omitted in this manual.
- Illustrated designs, specifications and other contents of this manual are subject to change for improvement without prior notice.

The illustrations of this unit and the settings menu screens used in this manual are from SR-HD1700.

How to Read this Manual (Continued)

Refer to the supplied CD-ROM for the Germany, Spanish, Italian and French GUIDEBOOK.

In order to view the GUIDEBOOK, Adobe® Acrobat® Reader™ or Adobe® Reader® must be installed.

Adobe® Reader® can be loaded from Adobe's web site:
<http://www.adobe.com/>

Menu operation

Pressing the remote control buttons below calls up the respective menu screens.

- [SET UP], [NAVIGATION], [EDIT], [INFORMATION CORRECT], [DUBBING], [MEDIA MANAGE]
- Press any of the [▲ / ▼ / ◀ / ▶] buttons to move to a specific menu item (yellow item indicated by a small arrow).
- Press the [OK] button to confirm the selection.
- Press the [RETURN] button to return to the previous screen.
- Simple instructions on the operation procedure may be displayed at the bottom of the screen.

Other Precautionary Notes

Copyright protection

This unit supports copyright protection technologies.

Copyrights

- According to the copyright law, video or music data that you store must not be used for purposes other than personal enjoyment without the authorization of the copyright holder.
- The copyright protection function prevents copyrighted video images from being saved to equipment such as a video recorder. This function may also cause deterioration in the playback picture quality when the data is output to a monitor through a video recorder. This is not a hardware malfunction. To play back copyrighted videos, connect this product directly to the monitor.
- Read and understand fully the terms and conditions of all copyright works before using this unit in the correct manner. Under no circumstances shall JVC KENWOOD take any responsibility for any infringements of copyright caused by the customer when using this unit. The customer shall be responsible for resolving all legal issues regarding to any copyright infringements.

Stored video content and compensation

- For discs containing important video content, backup on a periodic basis (once every few years) is recommended. Although digital signals do not deteriorate, playback or dubbing may fail due to aging of the disc resulting from the storage conditions.
- Recorded data may be lost if power outage occurs while this unit is being used. It is therefore recommended that videos stored on the HDD be dubbed to a BD or DVD as soon as possible in case the HDD breaks down.
- Videos or data stored on a BD/DVD, HDD, or SD card cannot be recovered if the media is damaged.

Disclaimer of compensation for loss or damage of stored video content

Please note that our company will not be liable for compensation of the content or any incidental damages in the event that dubbing or playback cannot be performed properly for some reasons. The same applies during repair of this unit.

Compatibility with Analog Sunset

- Video contents that are copyright-protected under the AACS will not be output from the analog output terminals of this unit.
- Video contents that are not copyright-protected under the AACS will be output from the analog output terminals of this unit.
- Analog output terminals refer to the [VIDEO OUT] terminal, [S-VIDEO OUT] terminal, and [COMPONENT VIDEO OUT] terminals.
- For details on the output resolution, refer to "List of Output Resolutions" (page 10).

List of Output Resolutions

| Media | Output Terminal | Content Protection | Output Resolution |
|-----------|---------------------------|--------------------|-------------------|
| DVD-Video | Analog Output (Component) | Free | 480p (for NTSC) |
| | | CSS | 576p (for PAL) |
| BDMV | Analog Output (Component) | Free | In HD (for NTSC) |
| | | AACS | No Output |
| BD-Video | Analog Output (Component) | Free | In HD |
| | | AACS | No Output |

- The output resolution if "COMPONENT OUTPUT" (page 90) is set to "1080i" when there is no HDMI connection.
- BD contents are assumed to be recorded in the 1080i format.
- CSS is the abbreviation for content scramble system.
- AACS is the abbreviation for advanced access content system.

Handling precautions

- **Do not use the plug or power point with dust or metallic objects attached to it**
 - Failure to do so may cause short circuit or heating, and result in fire or electric shock.
 - Remove the plug once every half a year, and clean it with a dry cloth.
- **Make use of a power point that allows the power plug to be inserted or removed easily**
 - Make sure that the plug can be removed immediately in case an abnormality is found in the unit.
- **Insert the plug firmly into the power point**
 - Failure to do so may cause short circuit or heating, and result in fire or electric shock.

- **Do not make use of a power voltage other than that specified**
 - Doing so may result in fire or electric shock.
- **Do not insert or remove the plug with wet hands**
 - Doing so may result in electric shock.
- **Do not touch the plug when there is thunder or lightning**
 - Doing so may cause electric shock.
- **Do not insert any foreign object into this unit**
 - Doing so may result in fire or electric shock.
- **Do not dismantle or remodel this unit**
 - This unit consists of high-voltage components. Dismantling or remodeling the unit may cause fire or electric shock.
- **Request the authorized dealer to inspect the interior part of the unit once a year**
 - Using this unit with dust accumulated inside may result in fire.
 - It is particularly effective to perform servicing before the humid rainy season.
- **Do not connect any video cameras that are not made by JVC to the USB terminal**
 - Doing so may result in malfunction.

Hard Disk Drive (HDD)

Hard disk drive (HDD)

The HDD rotates at a high speed whenever the power is turned “On”.

Pay particular attention to the following precautions when using this unit.

Warning

- Do not subject it to vibration or strong impact
Subjecting this unit to excessive impact may result in loss of recorded data and even damage of the HDD.
- Do not remove the power plug when this unit is running
Shutting down the power when the HDD is running may result in data loss and even damage of the HDD. Make sure that the power plug is removed only after turning off the power. (Wait for the “GOODBYE” message on the display window to disappear first)

Formatting the HDD

To format the HDD, perform the following steps.

- 1 **Press the [MEDIA MANAGE] button on the remote control unit**
- 2 **Select “FORMAT” from “HDD”**
 - A confirmation screen for formatting the HDD appears.
- 3 **Select “YES”**
 - The confirmation screen for formatting the HDD reappears.
- 4 **Select “FORMAT”**
 - HDD formatting starts.

SD Cards

Precautions for handling SD and SDHC cards

Note:

- The disc operation display icon appears blinking and “READING” is displayed on the display window when the SD card is being accessed (such as during dubbing, playback, or formatting). When access to the SD card is in progress, do not remove the card or the power plug. Doing so may cause the SD card to become unusable.
If the SD card is not usable, reformat the card. If the problem persists even after reformatting, use a new SD card.
 - Do not use or store the card at a place that is subject to static or electrical noise.
 - Inserting the SD card incorrectly may cause this unit or the card to malfunction.
 - Our company will not be liable for any damage or loss of the stored data due to accidents. (Be sure to back up the data.)
 - Use the card according to the prescribed conditions. Do not use it at the following locations.
 - Places that are exposed to direct sunlight
 - Places near heat-generating equipment
 - Inside a car that is under the sun with the windows tightly shut
 - Places that are subject to high humidity and corrosion
 - Do not bend or drop the card, or subject it to strong impact or vibration.
 - Do not expose the card to water.
 - Do not place near devices that emit strong magnetic or radio waves.
 - Do not touch the metal part of the card.
 - The SD SLOT does not support SDXC cards.
 - To use an SDXC card, connect a SDXC-compatible USB card reader (sold separately) via USB connection.
 - Do not format the SDXC card to the standard format of the computer OS.
 - This unit may not recognize the SD card if a USB card reader with three or more card slots is used.
 - Use a card reader with no more than two card slots.
- #### Memo:
- To dispose a card after erasing all data inside, it is recommended that this be done using a commercially available data deletion software, or by destroying the card physically, such as with a hammer. Formatting or deletion of data using this unit only changes the file administration information, and does not erase the data completely.

SD Cards (Continued)

BD video data

You can erase BD Video data from the SD card as follows.

1 Insert the SD card which has BD video data stored on it, into the [SD SLOT]

Memo:

- The BD video data cannot be erased if the SD card is write-protected. In this case, turn off the write-protect lock before inserting the SD card.

2 Press the [MEDIA MANAGE] button on the remote control unit

3 Select “BD-VIDEO DATA ERASE” from “SD CARD”

- The confirmation screen for erasing the BD video data is displayed.

4 Select “ERASE”, and press the [OK] button

- The BD video data will be erased.

Discs

BD recording formats

■ **BDAV mode**

- Videos can be edited (chapter edit etc) and new videos can be added to the disc. This format is suitable for recording videos.
- MPEG2 with HD quality will be recorded as it is onto the disc. This format has low playback compatibility, but performs well when used for backups.

■ **BDMV mode**

- Compatible and playable on other BD players. Menu functions similar to those of DVD video mode are also included. (*1)

This format performs well for distribution purposes.

- (*1) : Menu cannot be created when recording directly to a BDMV format disc.

DVD recording formats

■ **VR MODE**

- Format the disc using “VR MODE” if you want to add new videos to the disc.
- Deleting currently saved videos increases the remaining space on the disc. (except for the case of DVD-R discs.)

■ **VIDEO MODE**

- Format the disc in this mode if you want to play the disc on a different DVD player.

Formatting of discs

Formatting is required for some disc types. Perform formatting if this is necessary.

■ **When using BD-RE or BD-R discs**

Formatting is required. Format the disc using this unit.

- Format it to the BDAV or BDMV mode.

■ **When using DVD-R or DVD-RW discs**

Formatting is required. Format the disc using this unit.

- Format using “VR MODE” or “VIDEO MODE”.

Note:

- BD-R and DVD-R discs cannot be reformatted. Check the disc mode before formatting the disc.
-

Discs that enable both dubbing and playback

| Disc Type | Recording Format | Format | Finalize | Repeated Use (Reformat) |
|-----------|------------------|--------|----------|-------------------------|
| BD-RE | BDAV mode | ✓ | - | ✓ |
| | BDMV mode | ✓ | - | ✓ |
| BD-R | BDAV mode | ✓ | ✓ | - |
| | BDMV mode | ✓ | - | - |
| DVD-RW | Video mode | ✓ | ✓ | ✓ |
| | VR mode | ✓ | ✓ | ✓ |
| DVD-R | Video mode | ✓ | ✓ | - |
| | VR mode | ✓ | ✓ | - |

Memo:

- This unit does not support the BDXL format.

Discs that enable playback only

| Disc Type | Description |
|------------------|---|
| DVD-RAM (4.7 GB) | Supports specific forms of playback, but no recording can be done. |
| BD-ROM | Commercially available Blu-ray discs (movies, music, etc.) The region code that can be played back on this unit is “*1”. |
| DVD video | Commercially available DVD-Video discs (movies, music, etc.) The region code that can be played back on this unit is “*2”. The video format used is PAL or NTSC. |
| Music CD | CD-DA DTS music CDs are also playable. |

*1: SR-HD1700US/SR-HD1350US/SR-HD1700AG: A, SR-HD1700EU/SR-HD1350EU: B, SR-HD1700ER: C

*2: SR-HD1700US/SR-HD1350US: 1, SR-HD1700EU/SR-HD1350EU: 2, SR-HD1700AG: 3, SR-HD1700ER: 5

Memo:

- If 8 cm discs are used, only playback can be performed. The disc cannot be used for recording or editing.
- 8 cm discs can be used without adapters.
- DVD-RAM cartridges and BD-RE are not supported. Take the DVD-RAM out of the cartridge before using it.

Discs that are not supported

- DVD-RAM (2.6 GB/5.2 GB)
- DVD-R (for authoring)
- CD-ROM/R/RW (PhotoCD, CD-G, VCD etc.)
- DDVD (1.3 GB, Double Density CD)
- HDVD (High Density CD)

Memo:

- To playback a BD or DVD that was created using this unit on another player, finalize the disc.
- There is no need for finalizing if the BD-RE disc is recorded using BDAV mode.
- If a DVD that was recorded using VR mode has been finalized, the disc can only be played back on VR mode compatible devices.
- To perform high-speed dubbing, make use of a disc that supports high-speed recording.
- This unit can play back and record only PAL signals. NTSC signals can also be played back on the BD/DVD deck. (for PAL)
- This unit can play back and record only NTSC signals. (for NTSC)

Note:

- Do not use disc if the sticker or label is peeled off from the disc surface, if the disc is not round in shape, or if it is significantly warped or cracked.

Precautions on the Use of Discs

Maintenance of discs

- Dirt attached to the disc, such as fingerprints and dust, may cause distortion in the video image or sound. Keep the disc clean at all times such as by using a soft cloth.
- Wipe the disc lightly from the center outward using the cloth.
- If dirt is stubborn, wipe it off using a slightly wet cloth, followed by a dry cloth.
- Do not use thinner, benzene, alcohol, conventional record cleaners, or antistatic sprays. Doing so may damage the disc surface.

Handling discs

■ Removing a disc

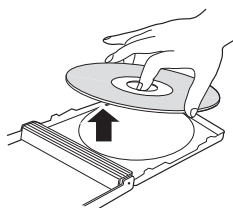

■ Keeping a disc

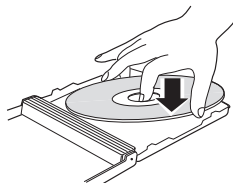

■ Correct way to hold a disc



Do not touch the recording/playback side of the disc with your fingers.
Fingerprints attached to the surface may affect the recorded video/audio, and prevent this unit from operating properly.

Disc storage

- Avoid storing the disc at the following locations.
 - Places that are subject to high humidity, dust, or mold growth
 - Places that are exposed to direct sunlight or near a heater
 - Inside a car during summer
- Do not drop the disc or subject it to strong impact.
- Place the disc in a case and store it vertically.
- Stacking the discs without using a case, placing the discs against one another or dropping them may result in deformation or cracking.

When the recording/playback lens is dirty

Dust or dirt may be attached to the recording/playback lens after using this unit for a prolonged period of time, and recording or playback may not be properly performed as a result.

In such case, consult the dealer or Service Center.

Precautions when playing a dual disc

The side of the dual disc that is not used for DVD recording does not comply with the standard specifications of music CDs.

It is recommended that playback on this unit be limited to the DVD recording side of the dual disc.

Disc usage

The best performance may not be obtained for some discs.

Power Cable

Do not unplug the cable during recording or playback. Doing so may cause the disc to become unusable. If the disc becomes unusable, refer to the following.

BD-R or : Use a new disc.
DVD-R

BD-RE or : Reformat the disc after erasing the data. If the DVD-RW disc is still not usable, use a new disc.

Do not turn off the [⏻/⏪] button or unplug the power cable immediately after closing the disc tray.

On-screen Displays

Status display

Displays the current settings and operating status (such as playback, pause) of this unit.

Pressing the [ON SCREEN] button on the remote control displays the status. To cancel the display, press the [ON SCREEN] button again.

You can select whether to display the statuses by changing the settings in the settings menu.

For details, refer to “ON SCREEN GUIDE” (☞ page 88) .

Memo:

- To display the statuses, set the “ON SCREEN GUIDE” item on the “DISPLAY” menu screen to “AUTO”.
 - Setting the “ON SCREEN GUIDE” item on the “DISPLAY” menu screen to “OFF” hides display of all status information.
 - You can display the status by pressing the [OPTION] button on the remote control unit when playback, dubbing or editing is not in progress.
 - ① **Press the [OPTION] button on the remote control unit**
 - ② **Select “ON-SCREEN DISPLAY”, and press the [OK] button on the remote control unit**
-

Event display

An on-screen event display appears on the display window as well as the monitor when there is a misoperation.

- The event display appears for an interval of about three seconds.

Memo:

- The same event display may appear several times.
-

Alarm display

When an operation is not accepted by this unit, an on-screen alarm display appears on the display of the main unit as well as the monitor.

Name and Function of Parts

Front panel

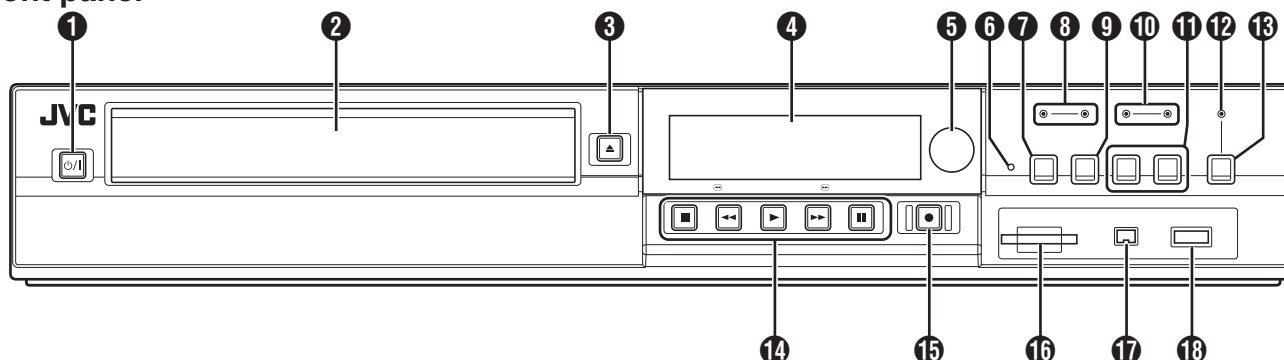

1 [/ I] button

Switches operation on or off.

2 Disc tray

3 [] button

Opens/closes the disc tray.

4 Display window

5 Remote control sensor

6 [RESET] switch

Reset the unit.

7 [REC MODE] button

Switches the recording mode.

8 [HDD] lamp

Lights up when in HDD mode.

The [REC] lamp lights up while recording/importing.

9 [INPUT SELECT] button

Switches the external input signals (HDV/DV, L-1).

10 [BD] lamp

Lights up when in BD/DVD mode.

The [REC] lamp lights up while recording/dubbing.

11 [MEDIA SELECT] button

Switches between HDD and BD/SD.

12 [SD] lamp

Lights up when in the SD mode.

13 [ONE TOUCH DUBBING] button

Starts one touch dubbing.

14 Playback control buttons

- [] button

Plays back the data.

- [] button

Stops playback/recording.

- [] button

Fast reverses playback.

- [] button

Fast forwards playback.

- [] button

Pauses playback.

15 [] button

Starts recording of a title.

16 [SD SLOT]

Used for inserting SD cards.

17 [i.LINK(HDV/DV IN)] terminal

Connect a video camera using i.LINK (HDV/DV. IN).

18 [USB] terminal

Connect a video camera using USB.

Display window

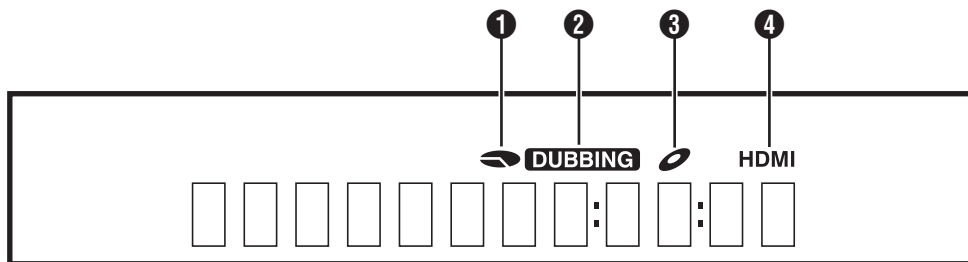

- ❶ HDD/DISC remaining level display
- ❷ Dubbing display
- ❸ Disc status display
- ❹ HDMI output display

Memo:

- The brightness of the display window can be adjusted.

For details, refer to “DIMMER (POWER ON)” (page 83).

English messages appear for a number of operations.
(Examples)

HELLO : When the power plug is inserted

READING : When reading the disc

ONSCREEN : Upon moving to the playback navigation screen

Rear panel

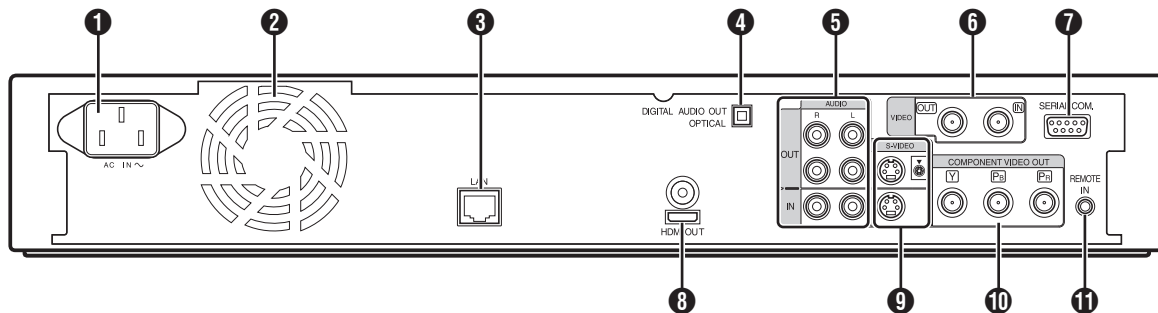

❶ AC inlet

For connecting the power supply.

❷ Cooling fan

❸ [LAN] terminal

For connecting a LAN cable.

Memo:

- For SR-HD1350, this terminal functions as a [FOR SERVICE] terminal. LAN connection is therefore not supported.

❹ [DIGITAL AUDIO OUT (OPTICAL)] terminal

For connecting to the amplifier using an optical audio cable.

❺ [AUDIO OUT/IN] terminals

For connecting using an audio cable.

❻ [VIDEO OUT/IN] terminals

For connecting using a video cable.

❼ [SERIAL COM.(RS-232C)] terminal (only for SR-HD1700)

For connecting to a computer using a serial cable.

❽ [HDMI] terminal

For connecting using an HDMI cable.

❾ [S-VIDEO OUT/IN] terminals

For connecting using an S-video cable.

❿ [COMPONENT VIDEO OUT] terminals

For connecting using a component video cable.

⓫ [REMOTE IN] terminal

For connecting a wired remote control.

Name and Function of Parts (Continued)

Remote control

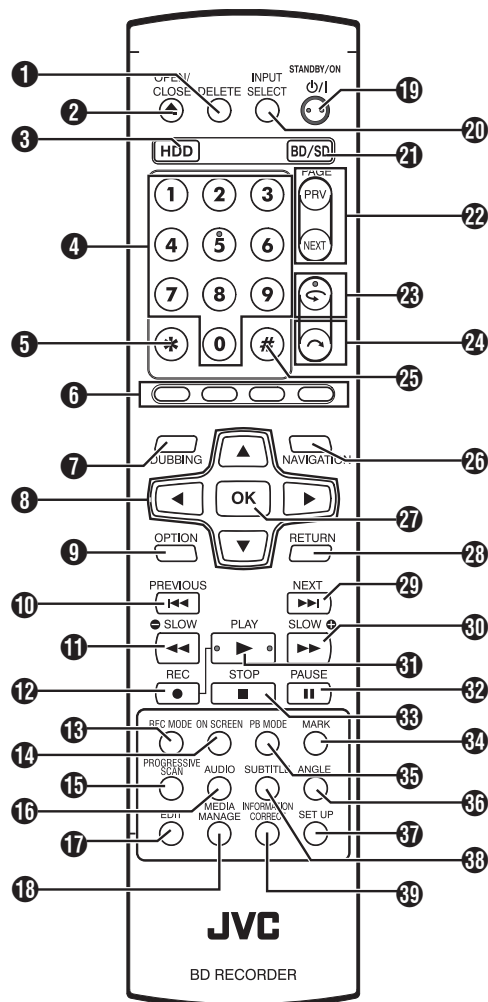

1 [DELETE]

Deletes a title or characters.

2 [▲]

Opens/closes the disc tray.

3 [HDD]

For operating the HDD.

4 [1]-[9]

For entering characters.

5 [*]

For entering characters.

6 [RED], [GREEN], [BLUE], [YELLOW]

Enabled when the color button is displayed.

Memo:

- The sequence of the button color is different depending on the model.

7 [DUBBING]

Displays the dubbing menu screen.

8 [▲/▼/◀/▶]

The cursor can be moved to select an item.

9 [OPTION]

Displays the option screen.

10 [◀◀]

Move to the chapter just before the current chapter.

11 [◀◀]

Fast reverses the video and starts slow playback.

12 [●]

Press the [●] and [▶] buttons together to start recording.

13 [REC MODE]

For checking the recording mode settings and amount of time remaining.

14 [ON SCREEN]

Displays information on the screen.

15 [PROGRESSIVE SCAN]

Switches the resolution of the image output.

16 [AUDIO]

Switches the playback audio.

17 [EDIT]

Displays the editing menu screen.

18 [MEDIA MANAGE]

Displays the media management menu screen.

19 [⏻/⏻]

Switches operation on or off.

20 [INPUT SELECT]

Switches the external input signals (HDV/DV, L-1).

21 [BD/SD]

For operating BD/DVD or SD.

22 [PAGE PRV] [PAGE NEXT]

Returns to the previous page. Or advances to the next page.

23 [↶]

Move the playback position slightly backwards.

24 [↷]

Advance the playback position slightly.

25 [#]

For entering characters.

26 [NAVIGATION]

Displays the playback navigation screen.

27 [OK]

Confirms a selection or entry.

28 [RETURN]

Returns to the previous screen without applying the selection or entry.

29 [▶▶]

Move to the next chapter.

30 [▶▶]

Fast forwards the video and starts slow playback.

31 [▶]

Plays the video.

32 [⏸]

Pauses the video that is currently playing.

33 [■]

Stops playback/recording.

34 [MARK]

Adds a chapter mark during playback or recording. Select multiple titles from the playback navigation screen or other screens.

35 [PB MODE]

Display the playback settings screen.

36 [ANGLE]

Switches the camera angle for playback.

37 [SET UP]

Displays the settings menu screen.

38 [SUB TITLE]

Switches the playback subtitle.

39 [INFORMATION CORRECT]

Displays the information editing screen.

Change batteries for the remote control

- If the operable distance of the remote control unit becomes shorter, this means that the batteries are running out. When this occurs, replace the batteries with new ones.

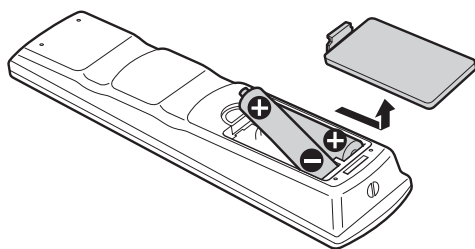

Batteries

- Insert the batteries correctly according to the + and – signs. Insert the – side of the battery first.
- If an error occurs while using the remote control unit, remove the batteries, wait for about five minutes, and operate the remote control unit again after re-inserting the batteries.

Battery life : Approximately 6 months
(depending on the frequency of use)

Remote control codes

By setting a remote control code for the unit and remote control, you can prevent two recorders from operating simultaneously using the remote control for this unit. (the setting for the unit and remote control at time of purchase is “REMOTE CONTROL 3”.)

Memo:

- Changing the remote control code for the remote control before the unit’s remote control code is changed will cause the unit to be inoperable. Change the unit’s remote control code first when changing remote control codes.

■ Changing the remote control code for the unit

- 1 Press the [SET UP] button on the remote control to display the “SETUP” menu
- 2 Change the “REMOTE CONTROL CODE” option in the “SETUP” menu

Memo:

- For details, refer to “REMOTE CONTROL CODE” (page 83).

■ Changing the remote control code for the remote control

- 1 Press and hold the [OPTION] button on the remote control
- 2 Press either of the [1], [2], [3] or [4] buttons
 - Press the number button that is equivalent to the remote control code you desire.
- 3 Press the [OK] button
 - Press the [OK] button to change the remote control code.
- 4 Release the [OPTION] button on the remote control

Memo:

- If the remote control code is different from the unit, the remote control code for the unit will be displayed on the display window.

Examples: REMOTE CONTROL 3

Preparation

Connecting a Monitor

To display video images from this unit, connect it to a monitor.

- This unit supports connections using “HDMI cable”, “component video cable”, “S-video cable”, or “video cable”.

Memo:

- Switch to the appropriate monitor input according to the type of connection cable used.
For details, refer to the instruction manual of the monitor.

Connecting using an HDMI cable

Connecting using an HDMI cable (sold separately) enables signals to be maintained in the digital format, and thus playback of clear video images.

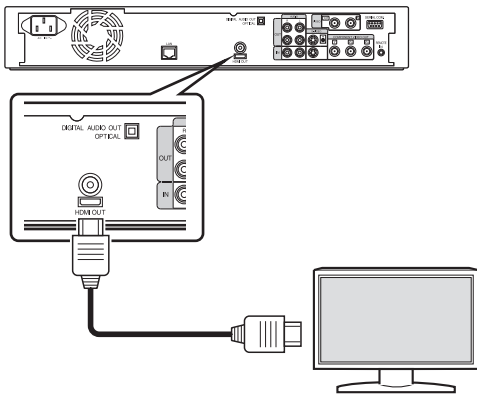

Memo:

- To connect to a monitor that does not support the copyright protection system (HDCP), set “HDCP”.
For details, refer to “HDCP” (page 90).
- Use a High Speed HDMI Cable.
- After connecting using an HDMI cable, change the unit setting to “HDMI CONNECTION”.

For details, refer to “VIDEO PRIORITY MODE” (page 88).

Connecting using a component video cable

Connecting using a component video cable (sold separately) delivers playback images that are clearer than those by an S-video cable.

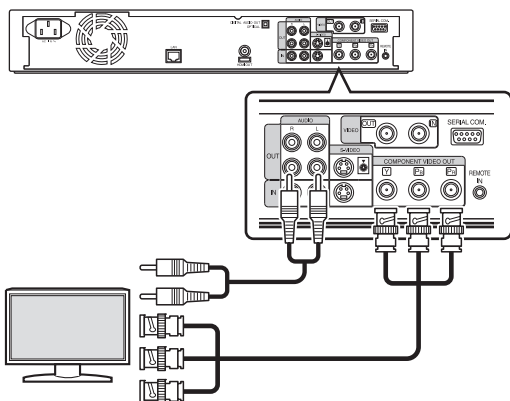

Memo:

- After connecting a component video cable, change the unit setting to “COMPONENT OUTPUT”.

For details, refer to “COMPONENT OUTPUT” (page 90).

Connecting using an S-video cable

For connecting an S-video cable (sold separately).

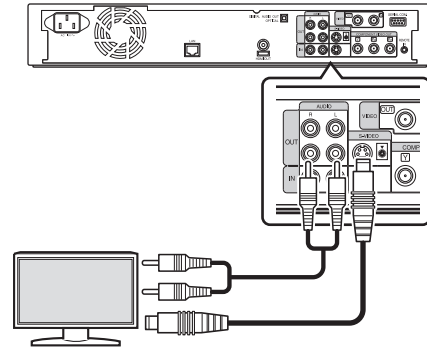

Connecting using a video cable

Connect the output terminal of this unit to the input terminal of a TV using a video/audio cable (sold separately).
(Use a BNC adapter that is sold separately)

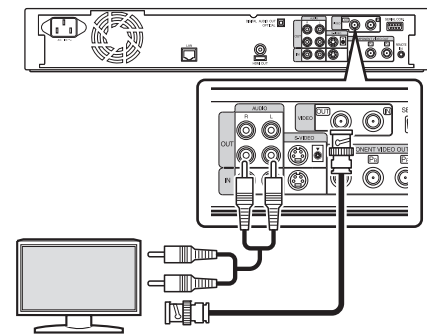

Note:

- Connect the S-video/video output of this unit directly to the TV (or monitor). Connecting this unit to the TV or monitor via a video deck triggers the copy protection function, and may cause distortion in the video images during playback.
- Videos that are AACIS copyright-protected are not output from the S-video/video output terminals.

Connecting an Amplifier

Connecting an audio amplifier

■ Connecting using an optical digital cable

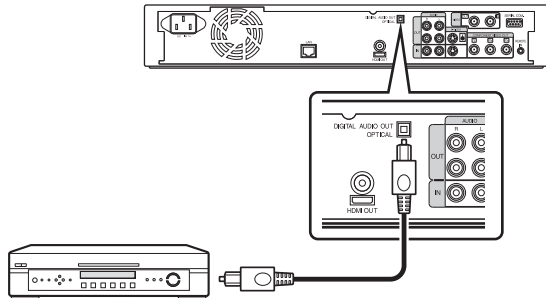

Memo:

- Remove the protection cap of the cable before connecting. Store the protection cap properly to prevent it from being misplaced.

■ Connecting using an audio cable

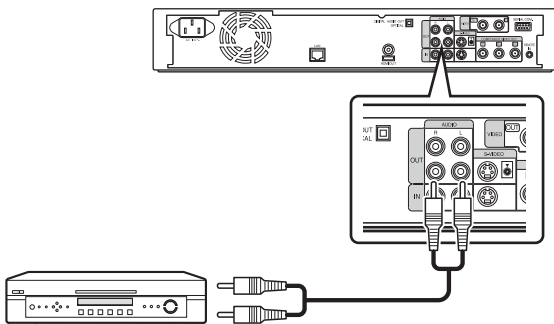

Connecting a Video Deck or Other Equipment

Connecting a video camera

■ Connecting via the i.LINK terminal

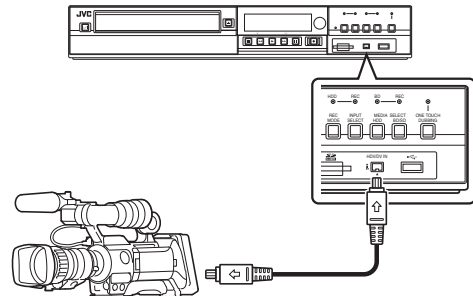

■ Connecting via the USB terminal

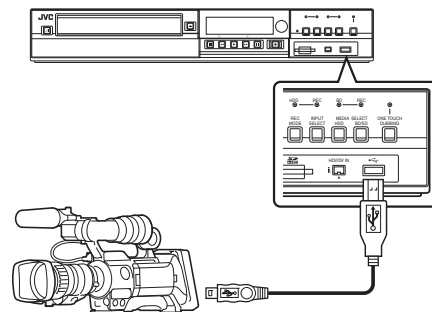

Memo:

- Some video camera models may require an AC adapter instead of batteries to run. For details, refer to the video camera's instruction manual.

Connecting a video deck or other equipment (recording using this unit)

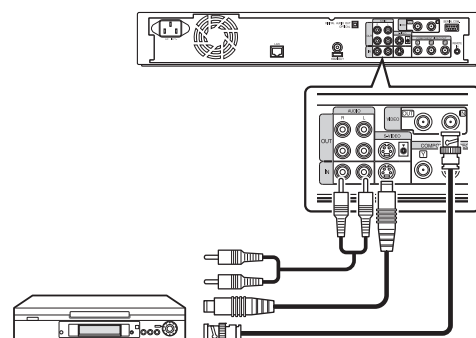

Memo:

- When connecting using an S-video cable, change the setting of "VIDEO INPUT SETTING" to "S-VIDEO". For details, refer to "VIDEO INPUT SETTING" (page 90).
- To record video images played back on this unit to an external device (video deck, etc.), connect the output terminal of this unit to the input terminal of the external device.

Connecting External Devices

Connecting a wired remote control

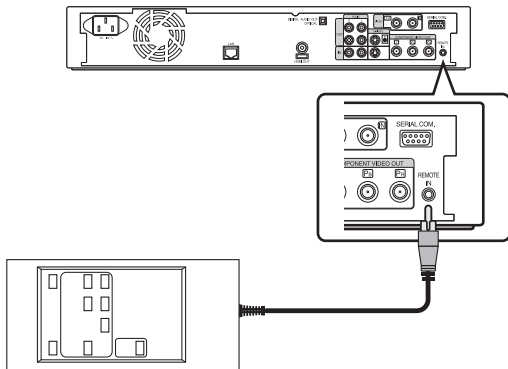

Using a wired connection enables stable control of this unit from an external device.

Operation is possible using any code (1 to 4) regardless of the remote control code settings of this unit.

Memo:

- There is currently no compatible remote control unit available.
- To create a wired remote controller, refer to “External Control (only for SR-HD1700)” (page 92) .

Connecting using an RS-232C cable (only for SR-HD1700)

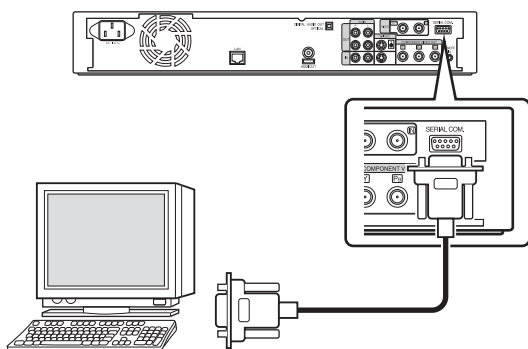

External operation is enabled by connecting an RS-232C cable to a PC or similar device.

For details on external operation, refer to “External Control (only for SR-HD1700)” (page 92) .

Connecting using a LAN cable (only for SR-HD1700)

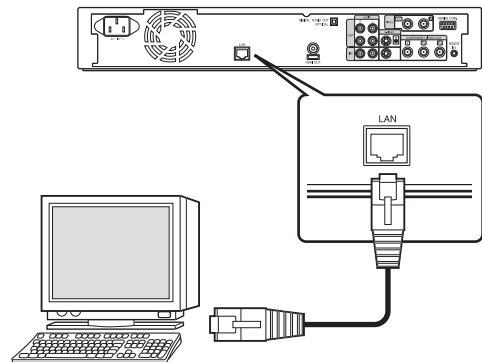

External operation is enabled by connecting to a PC or similar device using a LAN cable.

For details on external operation, refer to “External Control (only for SR-HD1700)” (page 92) .

Connecting the Power Supply

Connect the supplied power cable to this unit as follows.

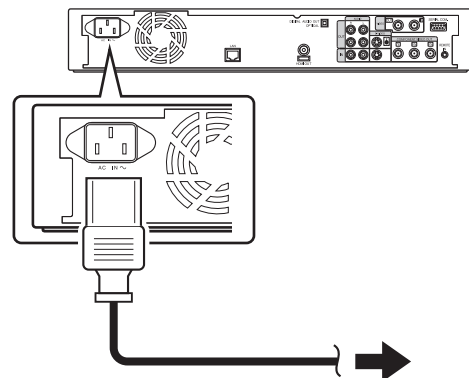

- 1 Connect the supplied power cable to the AC IN terminal of this unit
- 2 Connect the other end of the power cable to a power point
- 3 Press the [⏻/⏻] button on the remote control or this unit to switch on the unit.

- The power of this unit turns on, and a “HELLO” message appears on the display window.

Note:

- Do not use power cables other than that supplied with this unit. Doing so may cause this unit to malfunction.

Setting and Displaying Date/Time

Set the date/time of the built-in clock as follows. The recording date/time is stored on the disc.

Setting the date/time

Set the date/time of the built-in clock as follows.

1 Press the [SET UP] button on the remote control unit

- The Settings menu screen appears.

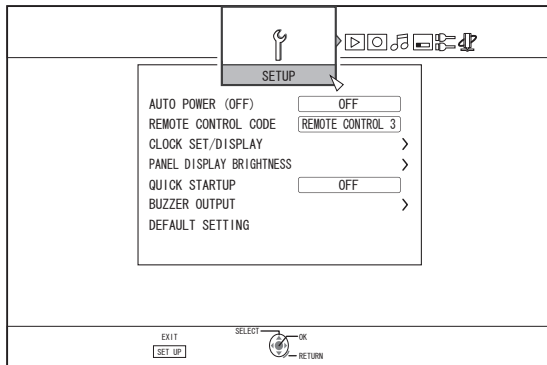

2 Select "SETUP", and press the [OK] button

3 Select "CLOCK SET/DISPLAY", and press the [OK] button

- "CLOCK SET/DISPLAY" menu screen appears.

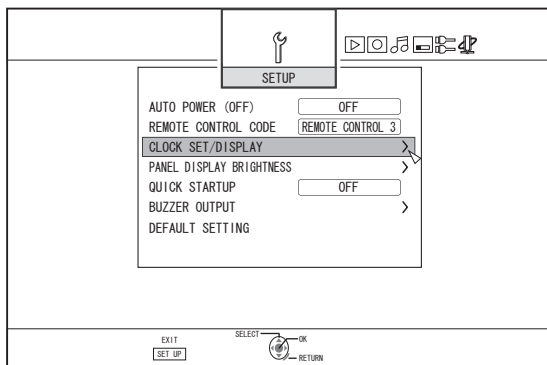

4 Select "CLOCK SET", and press the [OK] button

- The Clock Set menu screen appears.

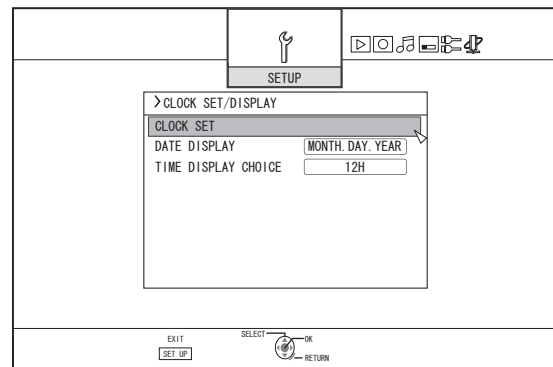

5 Set the time and date

- Repeat the steps below to specify the time and date.

① Press the [▲] or [▼] button, select the Clock Set item, and press the [OK] button.

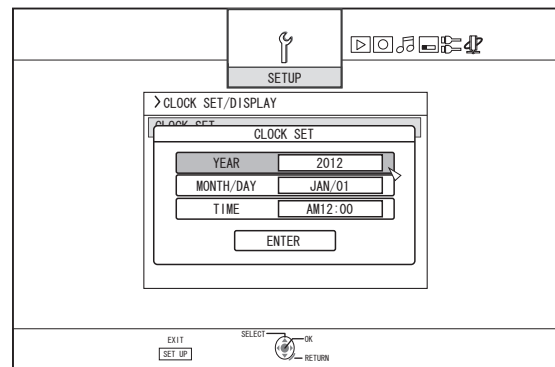

② Press the [▲] or [▼] button, change the setting value, and press the [OK] button.

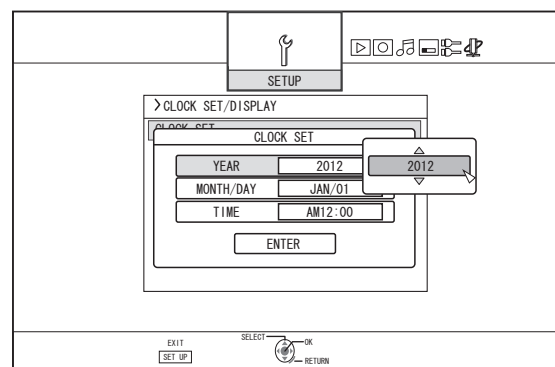

Setting and Displaying Date/Time (Continued)

- After setting is complete, select “ENTER”, and press the [OK] button
- Doing so exits date/time setting, and returns to the initial screen.

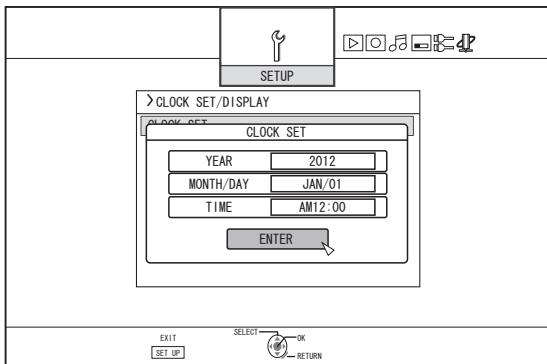

Memo:

- The value for seconds cannot be set. After setting the minute, press the [SET UP] button according to the time signal.
- To cancel date/time setting, press the [RETURN] button. Doing so cancels date/time setting and returns to the initial screen.
- The year can be set from 2012 to 2037. If “2037.12.31 23:59” is set, the time will change to “2012.1.1 00:00” after one minute.

Changing the date display style

You can specify the display style of the date as follows.

- Press the [SET UP] button on the remote control unit
- Select “SETUP”, and press the [OK] button
- The Settings menu screen appears.

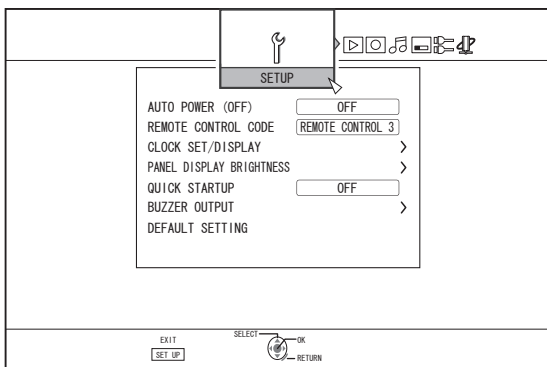

- Select “CLOCK SET/DISPLAY”, and press the [OK] button
- The Clock Set/Display menu screen appears.

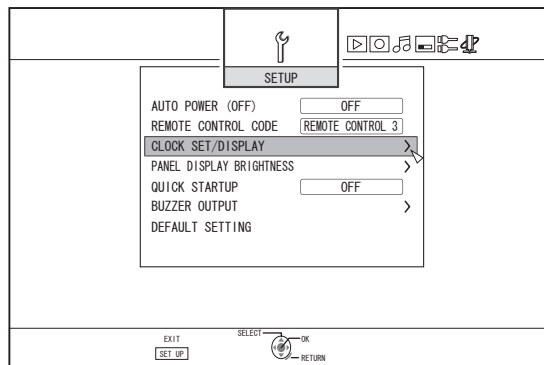

- Select “DATE DISPLAY”, and press the [OK] button
- The Date Display menu screen appears.

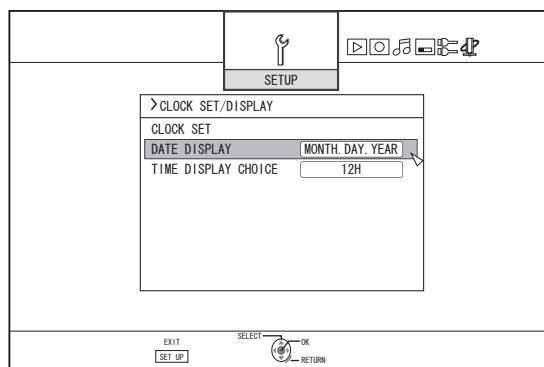

- Select the date display style.

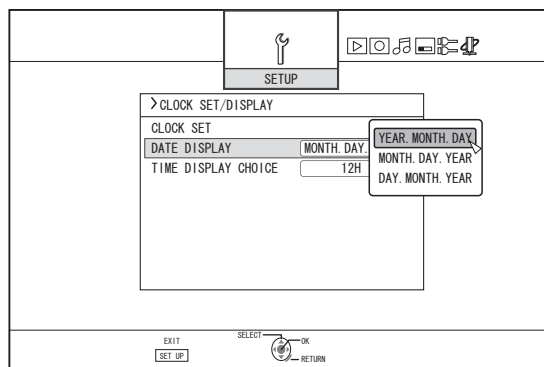

- Select a date display style from the following items.
 - YEAR.MONTH.DAY : Displays the date in the year/month/day order.
 - MONTH.DAY.YEAR : Displays the date in the month/day/year order.
 - DAY.MONTH.YEAR : Displays the date in the day/month/year order.

- After selecting, press the [OK] button
- The date display style will be saved.

Memo: _____

The date display style will be applied in the following information displays.

- Recording date of the title that is shown in the playback navigation screen (The recording date will be shown in place of the title if the title has not been input).
- Date that is displayed in the title information display screen

Changing the time display style

You can specify the display style of the time as follows.

1 Press the [SET UP] button on the remote control unit

2 Select “SETUP”, and press the [OK] button

- The Settings menu screen appears.

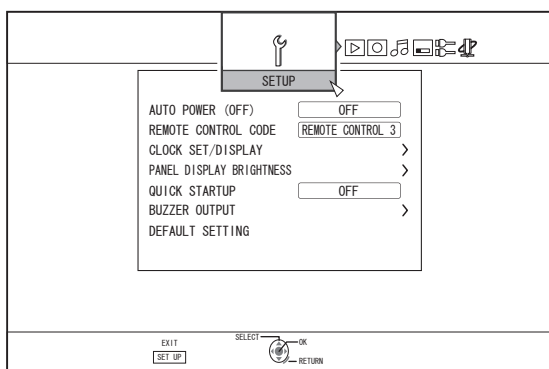

3 Select “CLOCK SET/DISPLAY”, and press the [OK] button

- The Clock Set/Display menu screen appears.

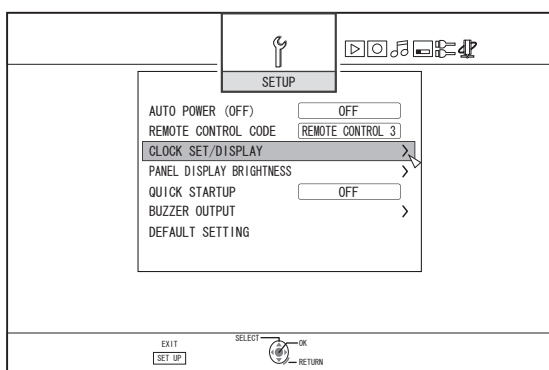

4 Select “TIME DISPLAY CHOICE”, and press the [OK] button

- The Time Display menu screen appears.

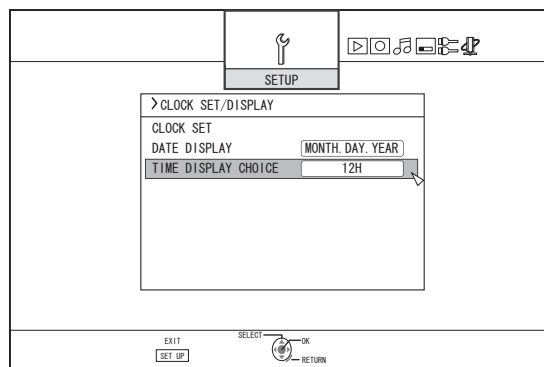

5 Select the time display style

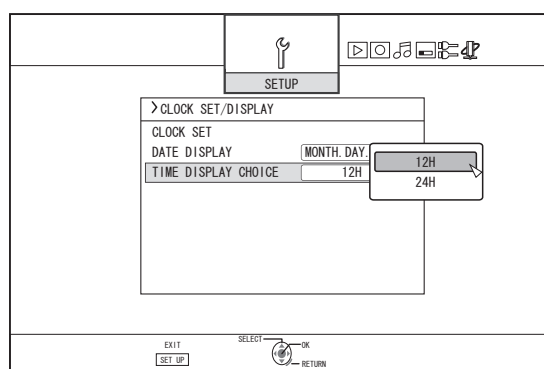

Select from “12H” or “24H”.

12H: Displays the time in AM/PM format.

24H: Displays the time in 24-hour format.

6 After selecting, press the [OK] button

- The time display style will be saved.

Memo: _____

- The time display style applies to the following.

- Current time
- Date/time registered on the disc
- Recording date of the title that is shown in the playback navigation screen (The recording date will be shown in place of the title if the title has not been input.)
- Time of recording that is displayed in the title information display screen

Dubbing/Importing

Bi-directional dubbing between the HDD and a BD/DVD is possible using this unit alone. Also, data can be imported to the HDD from a video camera by connecting it via i.LINK or USB.

Dubbing from the HDD to a BD/DVD

High-speed dubbing

Select this option if you want to significantly shorten the time required for dubbing. Make use of a BD/DVD disc that supports high-speed recording.

Dubbing in a specific recording mode

Select this option when you want to specify the recording mode for dubbing. Dubbing can be performed in the recording mode of your preference, such as whether to “maintain a high picture quality” or “save as many titles as possible”. For details, refer to “Recording Modes” (page 31).

Memo:

- The image quality will not improve even when a recording mode with image quality higher than that of the original recording mode is chosen.
- Dubbing using a specific recording mode will cause the disc to be re-encoded.

Other options for importing data into the HDD

Importing data from a BD/DVD to the HDD

You can import titles from a BD/DVD.

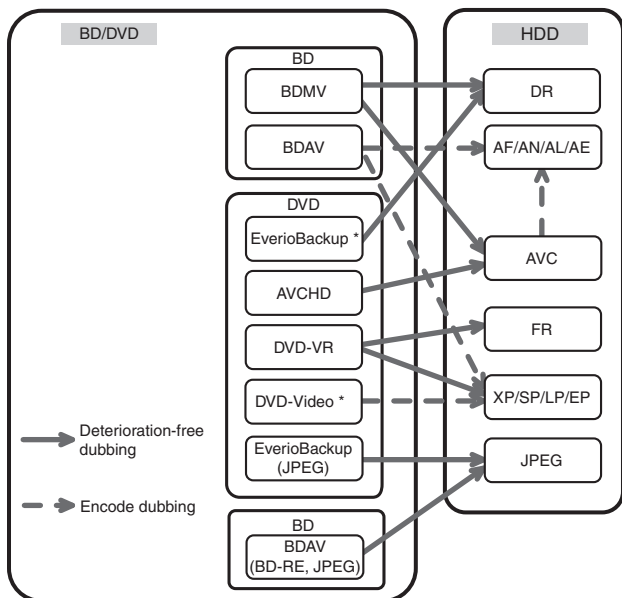

- DVD-video* : Discs that are not finalized cannot be imported.
- EverioBackup* : Data disc containing high-definition videos that are recorded in the MPEG2 format using a DVD writer for Everio.

Importing data from a SDHC/SD to the HDD

Videos captured using a video camera can be imported to the HDD by inserting the SDHC/SD card that the videos are saved on.

Importing data from a video camera to the HDD

Videos captured using a video camera can be imported to the HDD.

This unit supports video camera connections via i.LINK and USB.

Memo:

- For MOV format videos, only videos in the MOV format (SP mode and HQ mode) taken using JVC ProHD MEMORY CARD CAMERA RECORDER GY-HM series are compatible. There is no guarantee for importing videos taken on devices by other company.
- For MXF format videos, only videos in the MXF format (SP mode and HQ mode) taken using JVC ProHD MEMORY CARD CAMERA RECORDER GY-HM650 are compatible. There is no guarantee for importing videos taken on devices by other company.

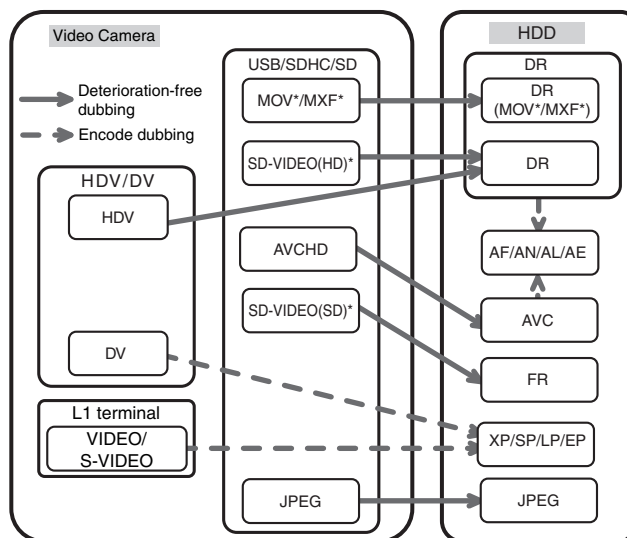

- MOV* : MOV format files recorded in the SP mode and HQ mode using the JVC ProHD MEMORY CARD CAMERA RECORDER GY-HM series
- MXF* : MXF format files recorded in the SP mode and HQ mode using JVC ProHD MEMORY CARD CAMERA RECORDER GY-HM650
- SD-VIDEO(HD)* : SD-VIDEO (JVC Everio MPEG2 TS)
- SD-VIDEO(SD)* : SD-VIDEO (JVC Everio MPEG2 PS)

Importing data from a video deck

You can import data to the HDD from an external video deck by connecting it to a composite video or S input terminal. For details, refer to “Recording Using External Inputs” (page 53).

■ **Importing from a LAN-compatible device**

Data on devices connected to the LAN terminal can be imported to the HDD.
 For details, refer to “Importing Data from a LAN-compatible Device to the HDD (only for SR-HD1700)” (☞ page 43) .

Memo:

- Videos that are copy-controlled cannot be imported.
- Motion JPEG is not supported

Dubbing chart

■ **Dubbing the video data from the HDD**

| Content Quality \ Dubbing Quality | Format (BD) | | | Format (DVD) | |
|-----------------------------------|--------------------|----------------------------------|-------------------|----------------------------------|----------------------------------|
| | BDMV (HD Quality) | BDAV (HD Quality) | BDAV (SD Quality) | DVD-VR | DVD-VIDEO |
| DR (MOV*/MXF*) | High-speed dubbing | High-speed dubbing / Re-encoding | Re-encoding | Re-encoding | Re-encoding |
| DR (Other) | - | High-speed dubbing / Re-encoding | Re-encoding | Re-encoding | Re-encoding |
| AF/AN/AL/AE | High-speed dubbing | High-speed dubbing / Re-encoding | Re-encoding | Re-encoding | Re-encoding |
| AVC | High-speed dubbing | High-speed dubbing / Re-encoding | Re-encoding | Re-encoding | Re-encoding |
| FR | - | - | Re-encoding | High-speed dubbing / Re-encoding | Re-encoding |
| XP/SP/LP/EP* | - | - | Re-encoding | High-speed dubbing / Re-encoding | High-speed dubbing / Re-encoding |

Memo:

- High-speed dubbing to DVD-VIDEO format discs may not be performed for XP/SP/LP/EP mode titles that are not recorded using the external inputs of this unit.

EP* : High-speed dubbing to DVD-VIDEO format discs in EP mode title
 To perform high-speed dubbing of a EP mode title to a DVD-VIDEO format disc, set “HIGH-SPEED DUBBING” (☞ page 85) in the settings menu to “4:3” before recording or importing. Only re-encoding will be performed when dubbing a title that is recorded or imported with a setting other than “4:3”.

MOV* : MOV format files recorded in the SP mode and HQ mode using the JVC ProHD MEMORY CARD CAMERA RECORDER GY-HM series

MXF* : MXF format files recorded in the SP mode and HQ mode using JVC ProHD MEMORY CARD CAMERA RECORDER GY-HM650

■ **Dubbing the picture data from the HDD**

| Importing file (HDD) | Media | |
|----------------------|--------------|---------|
| | BDAV (BD-RE) | SDHC/SD |
| JPEG | ✓ | ✓ |

Memo:

- Video images may be distorted in the following situations during reencoding/dubbing when the monitor (TV) is connected to this unit using an HDMI cable, or when the screen resolution is set to 1080p.
 - Proceeding with dubbing from the menu screen
 - Returning to the normal screen after dubbing has finished
- This is not a malfunction. Change the screen resolution to a setting other than 1080p if you feel that this is annoying.

Formatting

Unused discs or SD cards may require formatting in some cases.

When the need arises, format the disc or SD card accordingly.

Memo:

- Formatting a disc or SD card erases all existing data from the media.
Double-check carefully before formatting so as not to erase important titles.

Format chart

Refer to the following chart for the disc types and format when formatting a disc.

Note:

- If a disc is formatted using an equipment not manufactured by JVC, the disc may not be read correctly even though it corresponds to the chart below.
In this case, reformat the disc using this unit, or make use of another blank disc.

Memo:

- BD-R and DVD-R discs can only be formatted once.
- When a disc is re-formatted into another format, remove the disc and load it again.

■ DVD format chart

| | Format | VR Format | Video Format |
|--------|-------------------------------------|-----------|--------------|
| DVD-RW | Single-sided, single layer (4.7 GB) | ✓ | ✓ |
| DVD-R | Single-sided, single layer (4.7 GB) | ✓ | ✓ |
| | Single-sided, dual layer (8.5 GB) | ✓ | ✓ |

✓ : Format supported.

■ BD format chart

| | | BDAV Format | BDMV Format |
|-------|------------------------------------|-------------|-------------|
| BD-RE | Single-sided, single layer (25 GB) | ✓ | ✓ |
| | Single-sided, dual layer (50 GB) | ✓ | ✓ |
| BD-R | Single-sided, single layer (25 GB) | ✓ | ✓ |
| | Single-sided, dual layer (50 GB) | ✓ | ✓ |

✓ : Format supported.

Formatting a disc

- 1 Set the DVD or BD to be formatted on the disc tray
- 2 Press the [MEDIA MANAGE] button on the remote control unit
 - The Media Management menu screen appears.

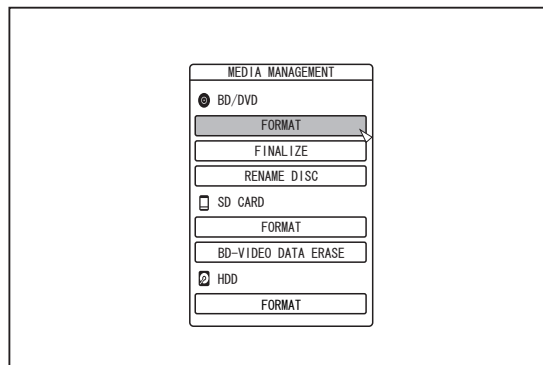

- 3 Select "FORMAT" from "BD/DVD"

- A format selection screen appears.

- 4 Select a format mode from the format selection screen

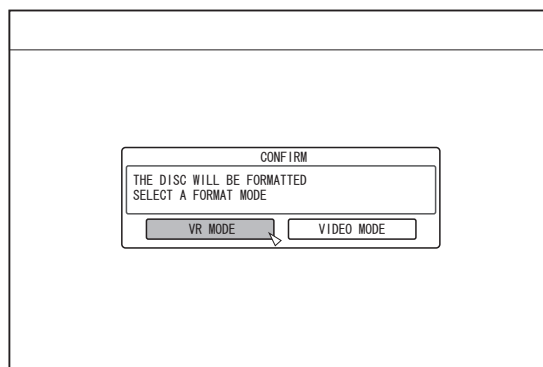

DVD : Select a "Format mode" from "VR MODE" or "VIDEO MODE".

BD : Select a "Format mode" from "BDAV MODE" or "BDMV MODE".

Memo:

- When "BDMV MODE" is selected, a "FOR DIRECT RECORDING" or "FOR DUBBING" selection screen appears after "Format mode" is selected.
- To record directly to a BDMV format disc, select "FOR DIRECT RECORDING".
- To use a BDMV format disc for purposes other than direct recording, select "FOR DUBBING".

5 Select “YES”, and press the [OK] button in the format confirmation screen

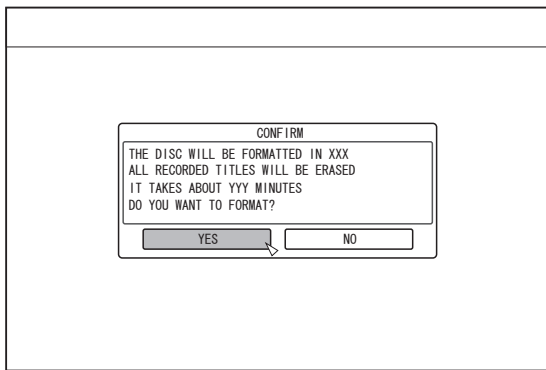

- Formatting starts.
- After formatting is complete, a “THE DISC HAS BEEN FORMATTED” message appears on the monitor, and the normal screen is displayed.

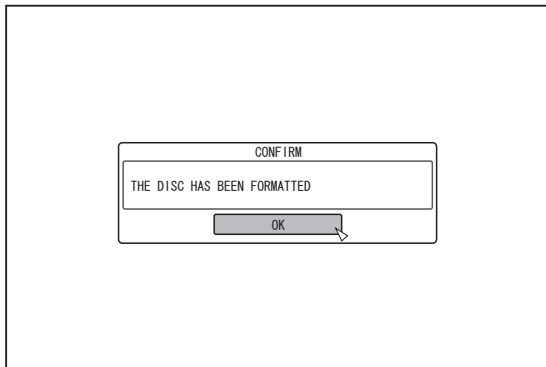

Memo:

- To return to the initial screen without formatting the disc, select “DO NOT FORMAT” and press the [OK] button. Alternatively, you can press the [RETURN] button to return to the initial screen without formatting.

Note:

- Do not turn off the power or unplug the power cable when the “FORMATTING DISC...” message is displayed.
- Note that formatting a disc with copyright-protected titles erases all the titles from the disc.

Cancel formatting

1 Press the [OPTION] button while formatting

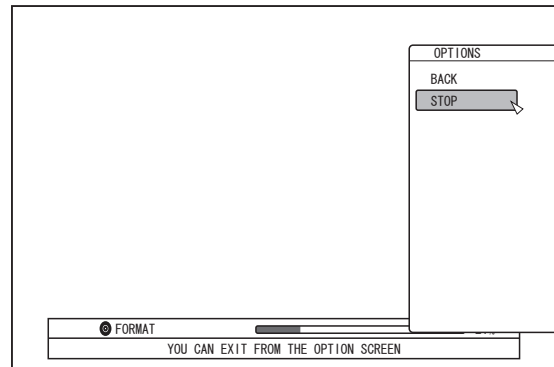

2 Select “STOP”, and press the [OK] button

- A confirmation screen to stop formatting appears.

3 Select “YES” on the confirmation screen and press the [OK] button

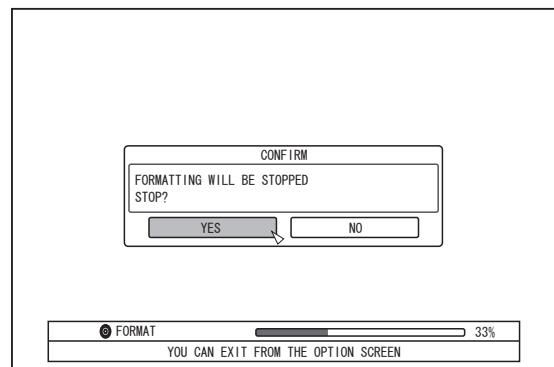

- Formatting is stopped.

Note:

- Formatting can be stopped if it seems to take a long time (more than two minutes).
- If for any reason formatting cannot be stopped, the confirmation screen for stopping formatting will not appear even if the [OPTION] button is pressed.

Formatting (Continued)

Formatting an SD Card

1 Insert the SD card to be formatted into the [SD SLOT]

- With the terminal side facing down, insert the SD card until a “click” sound is heard.

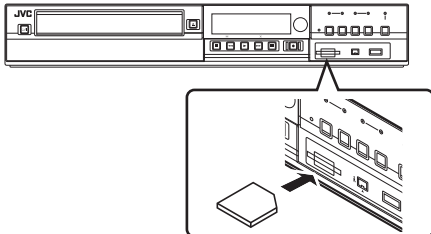

Note:

- Formatting cannot be performed if the SD card is write-protected. In this case, turn off the write-protect lock before inserting the SD card.

2 Press the [MEDIA MANAGE] button on the remote control unit

- The Media Management menu screen appears.

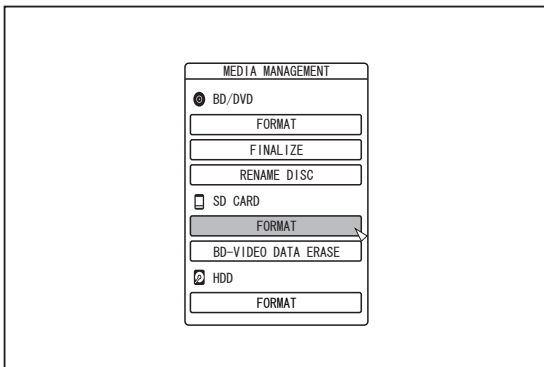

3 Select “FORMAT” from “SD CARD”

- A confirmation screen to execute formatting appears.

4 Select “YES”, and press the [OK] button

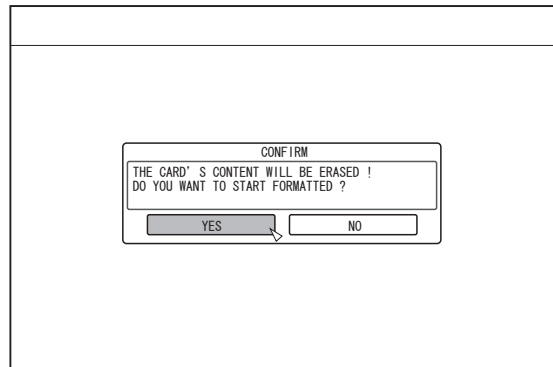

- Formatting starts.
- After formatting is complete, a “THE SD CARD HAS BEEN FORMATTED” message appears on the monitor, and the normal screen is displayed.

Memo:

- To return to the initial screen without formatting the disc, select “NO” and press the [OK] button. Alternatively, you can press the [RETURN] button to return to the initial screen without formatting.

Note:

- Do not turn off the power or unplug the power cable when the “FORMATTING SD CARD...” message is displayed. Do not remove the SD card as well. Doing so may damage the SD card.
- Note that formatting a disc with copyright-protected titles erases all the titles from the disc.
- Once the formatting of the SD card begins, it cannot be stopped.

Recording Modes

Maximum recording time for each recording mode

You can specify a recording mode according to the intended use. Setting the video to a high picture quality shortens the maximum recording time, while setting to a lower picture quality lengthens the recording time.

Refer to the following table for the maximum recording time in the respective modes. All figures shown in the table are approximate values.

| Recording Mode | Quality | BD (Single-sided, Single Layer) | BD (Single-sided, Dual Layer) | DVD (Single-sided, Single Layer) | DVD (Single-sided, Dual Layer) | HDD (500 GB) (*1) |
|----------------|---------|---------------------------------|-------------------------------|----------------------------------|--------------------------------|-------------------|
| DR | HD | 1.9 hours | 3.8 hours | - | - | 40 hours (*2) |
| AF | | 4 hours | 8 hours | - | - | 80 hours |
| AN | | 6 hours | 12 hours | - | - | 126 hours |
| AL | | 9 hours | 18 hours | - | - | 189 hours |
| AE | | 12 hours | 24 hours | - | - | 252 hours |
| XP | SD | 5.25 hours | 10.5 hours | 1 hours | 1.7 hours | 110 hours |
| SP | | 10.5 hours | 21 hours | 2 hours | 3.5 hours | 222 hours |
| LP | | 21 hours | 42 hours | 4 hours | 7.1 hours | 442 hours |
| EP | | 42 hours | 84 hours | 8 hours | 14.3 hours | 887 hours |

*1 : If the HDD capacity is 320 GB (SR-HD1350), the recording time will be about 0.6 times the value stated.

*2 : An estimated figure when HDV is imported.

Memo:

- DR mode
Abbreviation for Direct Recording. Videos are recorded in the original picture quality.
- AF/AN/XP/SP mode
Recommended for recording images with fast motion, such as sports videos.
 - The AF/AN mode record images at the high-quality HD level.
 - The XP/SP modes record images at the high-quality SD level.
- AL/AE/LP mode
Recommended for recording images with slow motion and little contrast, such as dramas.
 - AL/AE mode records images at the low-quality HD level.
 - LP mode records images at the low-quality SD level.
- EP mode
Recommended for recording images with sharp outlines, such as animation videos, and when the recordable time (remaining time) is limited.
- You can change the recording mode by pressing the [OPTION] button on the remote control unit while playback, dubbing or editing is not in progress.
 - ① Press the [OPTION] button on the remote control unit
 - ② Select "RECORDING MODE", and press the [OK] button on the remote control unit
 - ③ Select "RECORDING MODE" to which you want to change, and press the [OK] button on the remote control unit
- There may be cases where it is not possible to record up to the maximum recording time as indicated in the table due to the limitations of the BD standards.

Recording Modes (Continued)

HD picture quality

- Using BD enables dubbing to be done with HD picture quality. To dub HD picture quality titles that are imported in the HDD, it is recommended to use BD.

Note:

- Dubbing to a DVD cannot be done in HD picture quality.
-

DR mode

- HDV, MOV*/MXF* and SD-VIDEO (JVC Everio MPEG2 TS) titles can be imported using the DR mode.

MOV* : MOV format files recorded in the SP mode and HQ mode using the JVC ProHD MEMORY CARD CAMERA RECORDER GY-HM series

MXF* : MXF format files recorded in the SP mode and HQ mode using JVC ProHD MEMORY CARD CAMERA RECORDER GY-HM650

FR mode

FR mode is displayed as the recording mode in the following cases.

- FR mode during import into HDD
During import of SD-VIDEO (JVC Everio MPEG2 PS) titles via high-speed dubbing. During import of data via high-speed dubbing from DVD-VR discs recorded using other units.
- FR mode during dubbing from HDD
When selecting the most appropriate mode automatically between XP and EP according to the remaining memory on the disc.

Importing Data to the HDD Using the ONE TOUCH DUBBING Button

Titles can be imported to the HDD from an SD card or device connected to a USB or i.LINK terminal simply by pressing the [ONE TOUCH DUBBING] button on the unit.

- File formats that can be imported
 - USB connection device, SD card**
AVCHD, SD-VIDEO (JVC Everio MPEG2 TS, PS), MOV*/MXF*, and JPEG
MOV* : MOV format files recorded in the SP mode using the JVC ProHD MEMORY CARD CAMERA RECORDER GY-HM series
MXF* : MXF format files recorded in the SP mode and HQ mode using JVC ProHD MEMORY CARD CAMERA RECORDER GY-HM650
 - i.LINK-connected device**
DV and HDV content

Memo:

- Data is searched according to the order of priority listed below when multiple devices are connected to this unit.
USB ⇒ SD card ⇒ i.LINK
Data is retrieved only from the first device and imported to the HDD. Connect only the device that contains data you want to import to the HDD.
The i.LINK connected device can only be used to import from tape media.
- All video files (scenes) imported using "ONE TOUCH DUBBING" are combined into one title.
This unit does not support combining of titles during the editing operation after import is complete. To combine and import data, select "ONE TOUCH DUBBING".
- Titles of two or more scenes cannot be combined if the recording criteria, such as video size, are different.
- Import of MOV files recorded using JVC GY-HM series SP mode 1080i requires a duration that is about 1.3 times longer than the usual time.
- Continuous recording can be performed up to the maximum recording time, however, the title is automatically divided during recording.
During recording of L-1 input signals to HDD, DVD-Video format disc, or DVD-VR format disc: 8-hour interval
During recording of DV input signals to HDD, DVD-Video format disc, or DVD-VR format disc: 8-hour interval
During recording in conditions other than those above: 24-hour interval

Note:

- Do not unplug the cable while importing to the HDD is in progress.
Doing so may result in loss or damage of the titles.
- For MOV format videos, only videos in the MOV format (SP mode) taken using JVC ProHD MEMORY CARD CAMERA RECORDER GY-HM series are compatible. There is no guarantee for importing videos taken on devices by other company.
- Only titles that are not copyright-protected can be imported.
- Recognizing the device and importing the files may take a long time depending on the amount of files in the device or media.

■ Procedure for one-touch importing

1 Connect the device to be used. Alternatively, insert an SD card.

- Once preparations for importing have been done, the message below will be shown on this unit's display window.

i.LINK device : "HDV/DV RDY"

USB device : "USB RDY"

SD card : "SD RDY"

2 Press the [ONE TOUCH DUBBING] button on the unit

- One-touch importing starts.

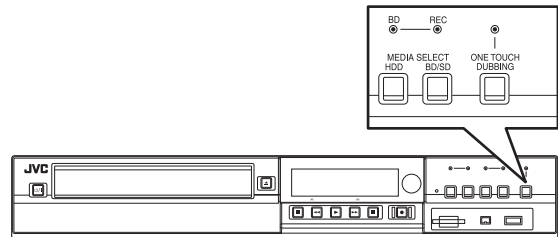

Memo:

- Refer to the following for the flow of operations by the system of this unit.

3 System checks the device connection

- The system of this unit detects the connected device. Search for devices is performed in the sequence of USB, SD card, followed by i.LINK.

4 System detects the titles to import

- All titles that can be imported will be detected and imported.

5 Importing of titles by this unit starts

6 After titles are successfully imported, a "DUBBING IS COMPLETED" message appears on the monitor

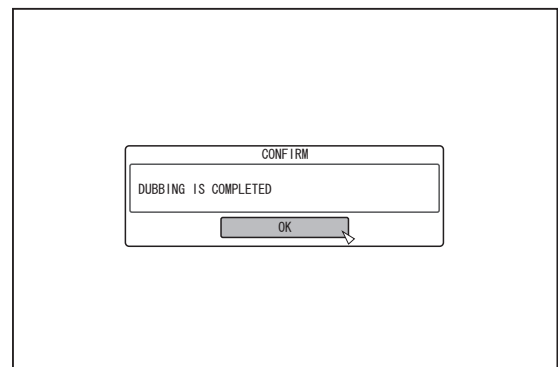

Memo:

- The following buttons are enabled when importing is in progress.

[⏻/⏸] : Continues importing while switching this unit to the Standby mode.

[ONE TOUCH DUBBING] : Press this button for three seconds or longer to cancel importing.

[OPTION] : Displays a pop-up menu for canceling importing.

[ON SCREEN] : Pressing this button each time displays or hides the importing information.

Note:

- Importing stops and a message appears on the monitor if an error occurs during the importing process.

Importing Data from a BD/DVD to the HDD

Data can be imported from a BD/DVD to the HDD as follows.

- File formats that can be imported
 - Videos : BDMV, BDAV, AVCHD, DVD-VR, DVD-VIDEO, EverioBackup
 - Still Images : EverioBackup, BDAV (BD-RE)

Memo:

- BDMV, AVCHD and EverioBackup titles that are imported using “FULL IMPORT” are combined into one title. This unit does not support combining of titles during the editing operation after import is complete. To combine and import data, select “FULL IMPORT”.
- For data that is selected for import via “SEL. TITLE(VIDEO)”, titles with the same date are combined.
- Titles of two or more scenes cannot be combined if the recording criteria, such as video size, are different.

Note:

- Only titles that are not copyright-protected can be imported.
- Recognizing the device and importing the files may take a long time depending on the amount of files in the device.

■ Preparations

- 1 Set a BD or DVD on the disc tray
 - 2 Press the [DUBBING] button on the remote control unit
- The importing screen appears.

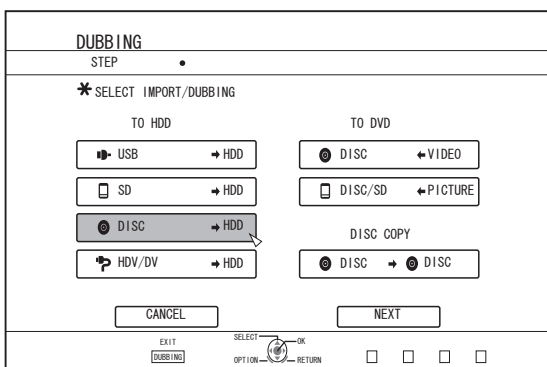

3 Select “DISC⇒HDD” in the importing screen, and press the [OK] button

- A check mark is added to the “DISC⇒HDD” item.

4 Select “NEXT”, and press the [OK] button

- The import selection screen appears.

Memo:

- A recording mode selection appears instead of the import selection screen when DVD-VIDEO is detected. For details, refer to “Importing DVD-VIDEO” (page 36).

Full import

1 Select “FULL IMPORT” in the import selection screen, and press the [OK] button

- A check mark is added to the “FULL IMPORT” item.

2 Select “NEXT”, and press the [OK] button

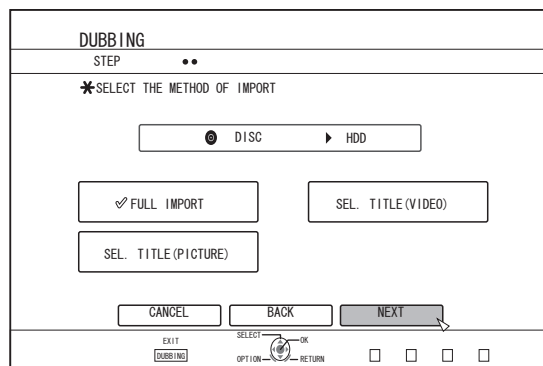

- “START” will appear instead of “NEXT” in the menu if the disc is of a format other than “BDAV”. In this case, go to step 5.

3 Select “RECORDING MODE”, and press the [OK] button

- A pop-up menu appears.

4 Select the “RECORDING MODE” option.

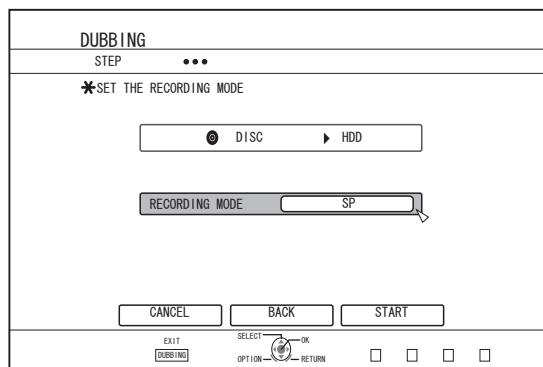

For details, refer to “Recording Modes” (page 31).

5 Select “START”, and press the [OK] button

- Importing of the titles starts.
- After titles are successfully imported, a “DUBBING IS COMPLETED” message appears on the monitor.

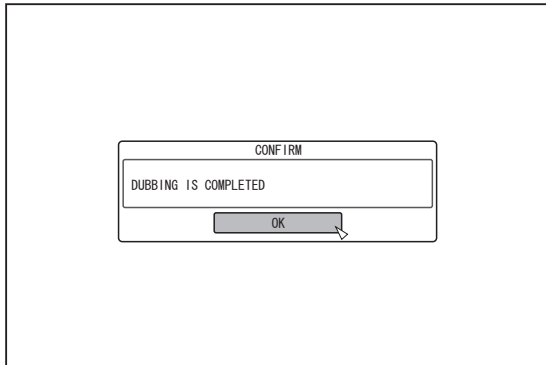

Specify a title

1 Select “SEL. TITLE(VIDEO)” in the import selection screen, and press the [OK] button

- A check mark is added to the “SEL. TITLE(VIDEO)” item.

2 Select “NEXT”, and press the [OK] button

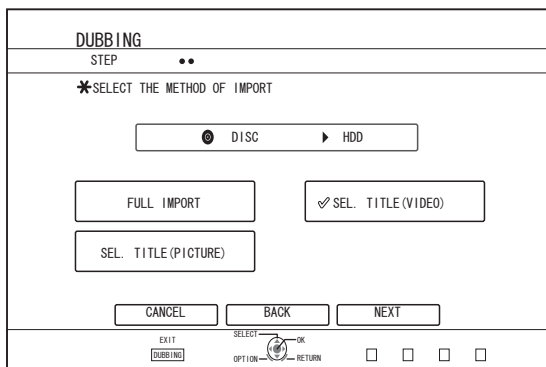

- If a “BDAV” disc is set, a recording mode selection screen will appear.
- If the disc is of a format other than “BDAV”, a screen for creating an import title list will appear. In this case, go to step 5.

3 Select “RECORDING MODE”, and press the [OK] button

- A pop-up menu appears.

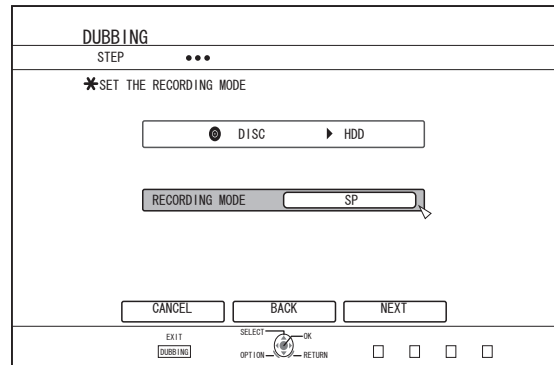

4 Select the “RECORDING MODE” option.

For details, refer to “Recording Modes” (page 31).

5 Select “NEXT”, and press the [OK] button

- A screen for creating the import title list appears.

6 Create an import title list

- Follow the steps below to create an import title list.

① Select “ADD TITLE LIST FOR DUBBING”, and press the [OK] button

The Title List screen is displayed.

② Select the titles to import, and press the [OK] button

Titles selected are added to the list.

Memo:

- Press the [MARK] button. A check mark will appear beside the title.
All titles with a check mark can be added to the list at the same time.
- Select a title from the dubbing title list, and press the [OK] button to perform the following changes.
 - Delete the selected title from the list
- Thumbnails may not be displayed during title selection depending on the discs used.

Importing Data from a BD/DVD to the HDD (Continued)

7 Select "START", and press the [OK] button

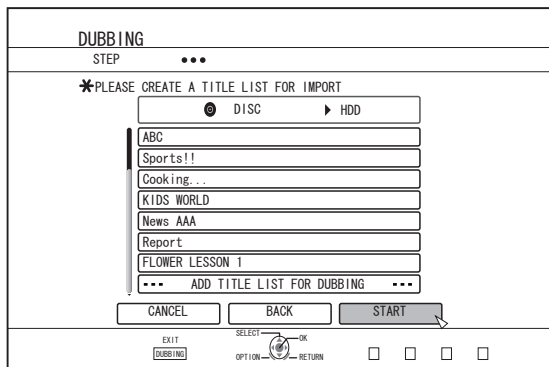

- Importing of titles starts according to the sequence in the created title list.
- After titles are successfully imported, a "DUBBING IS COMPLETED" message appears on the monitor.

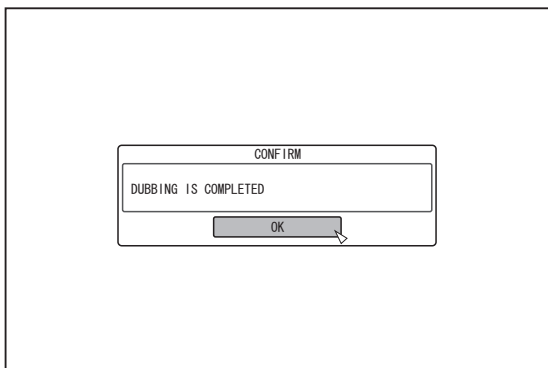

Note:

- "START" cannot be selected for the following cases.
 - A title that cannot be dubbed has been selected
 - HDD memory is insufficient
 - The amount of titles in the HDD has reached the maximum amount
 - A dubbing title list has not been created

Check "Troubleshooting" (page 110), and operate accordingly.

Importing DVD-VIDEO

When DVD-VIDEO is detected, a recording mode selection screen appears.

Follow the steps below to import DVD-VIDEO to the HDD.

1 Select "RECORDING MODE", press the [OK] button, and select "RECORDING MODE" from the recording mode selection screen

- Select the "RECORDING MODE" option.

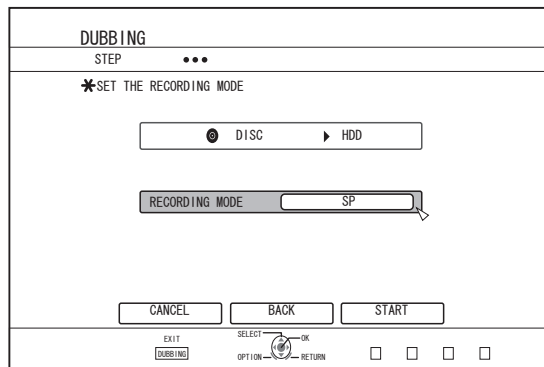

For details, refer to "Recording Modes" (page 31).

2 Select "START", and press the [OK] button

- Importing of the titles starts.
- After titles are successfully imported, a "DUBBING IS COMPLETED" message appears on the monitor.

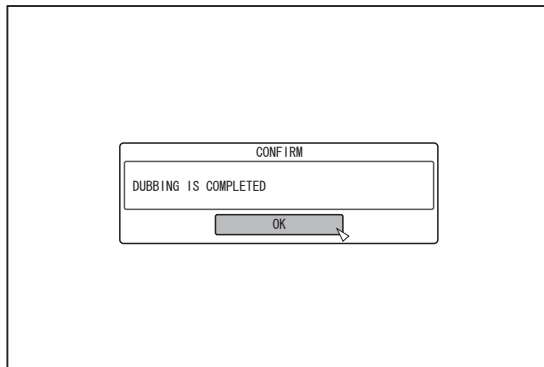

Memo:

- If the first play setting of the DVD-video has been set to top menu or other settings, the title will not playback. If playback does not start, press the play button or playback the DVD-Video.

Canceling importing

To cancel importing before it starts

- Select "CANCEL" from the menu, and press the [OK] button to cancel importing of a title.
- Alternatively, you can press the [RETURN] button to cancel importing and return to the initial screen.

To cancel importing while it is in progress

- Press the [OPTION] button to display the pop-up menu. Select "CANCEL" from the pop-up menu and press the [OK] button. Doing so imports data to the HDD up to the position where you have chosen to stop.
- Importing will also be stopped when the [■] button is pressed to stop playback.

Importing Data from a USB-compatible Device to the HDD

Data on devices connected to the USB terminal can be imported to the HDD as follows.

- File formats that can be imported
AVCHD, SD-VIDEO (JVC Everio MPEG2 TS, PS), MOV*/MXF*, and JPEG
- MOV* : MOV format files recorded in the SP mode and HQ mode using the JVC ProHD MEMORY CARD CAMERA RECORDER GY-HM series
- MXF* : MXF format files recorded in the SP mode and HQ mode using JVC ProHD MEMORY CARD CAMERA RECORDER GY-HM650

Memo:

- Titles that are imported using “FULL IMPORT” combined into one title. This unit does not support combining of titles during the editing operation after import is complete. To combine and import data, select “FULL IMPORT”. However, titles of MXF files will not be combined.
- For data that is selected for import via “SEL. TITLE(VIDEO)”, titles with the same date are combined.
- Titles of two or more scenes cannot be combined if the recording criteria, such as video size, are different.
- Import of MOV files recorded using JVC GY-HM series SP mode 1080i requires a duration that is about 1.3 times longer than the usual time.

Note:

- Turn off the power for this unit and the connecting device if an USB compatible device is to be connected to this unit.
- Do not unplug the USB cable while importing a title. Doing so may result in loss or damage of the titles.
- Only titles that are not copyright-protected can be imported.
- For MOV format videos, only videos in the MOV format (SP mode and HQ mode) taken using JVC ProHD MEMORY CARD CAMERA RECORDER GY-HM series are compatible. There is no guarantee for importing videos taken on devices by other company.
- Recognizing the device and importing the files may take a long time depending on the amount of files in the USB device.
- If a USB connection is used, this unit will only recognize one device out of all the recording devices. Depending on the video camera, the memory card slot will be recognized but the internal device will not be recognized. Use the following methods to solve this.
 - If the internal device is not recognized:
Copy the data from the camera’s internal memory or HDD onto the SD card.
 - If using a JVC camcorder that has two memory card slots:
Put the memory card that has the required data in slot A.
- If the target device is not recognized using the USB connection, use the camcorder’s burner or a similar device to dub the disc before proceeding with dubbing on this unit. For details, refer to “Importing Data from a BD/DVD to the HDD” (page 34).
- When importing videos from a USB-connected camcorder, data reading from the internal memory of the camcorder may fail. If both the camcorder’s internal memory and SD card are available, the SD card may be detected first. To prevent this from occurring, remove the SD card before reading data from the internal memory.

Preparations

- Connect the USB device (Everio, etc.) to this unit using a USB cable

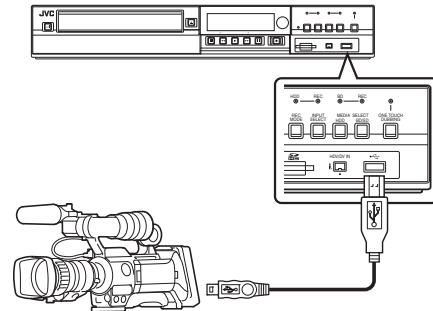

Memo:

- After connecting the USB cable, turn on the camera and switch the mode of the camera. (Choose “Connect to a computer” or a similar option. For details refer to the camera’s instruction manual.)
- “USB RDY” appears on the display window of the unit when an USB device is recognized.

- Press the [DUBBING] button on the remote control unit

- The importing screen appears.

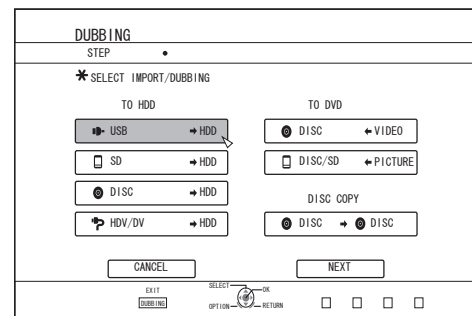

- Select “USB⇒HDD” in the importing screen, and press the [OK] button

- A check mark is added to the “USB⇒HDD” item.

- Select “NEXT”, and press the [OK] button

- The import selection screen appears.

Full import

- Select “FULL IMPORT” in the import selection screen, and press the [OK] button

- A check mark is added to the “FULL IMPORT” item.

- Select “START”, and press the [OK] button

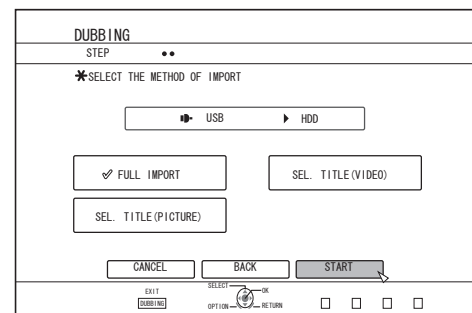

- Importing of the titles starts.

Importing Data from a USB-compatible Device to the HDD (Continued)

- After titles are successfully imported, a “DUBBING IS COMPLETED” message appears on the monitor.

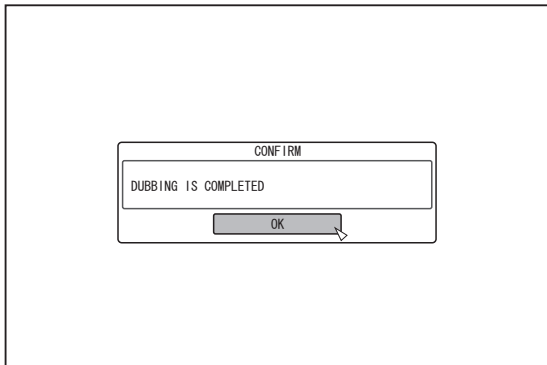

Specify a title

- 1 Select “SEL. TITLE(VIDEO)” in the import selection screen, and press the [OK] button
 - A check mark is added to the “SEL. TITLE(VIDEO)” item.
- 2 Select “NEXT”, and press the [OK] button

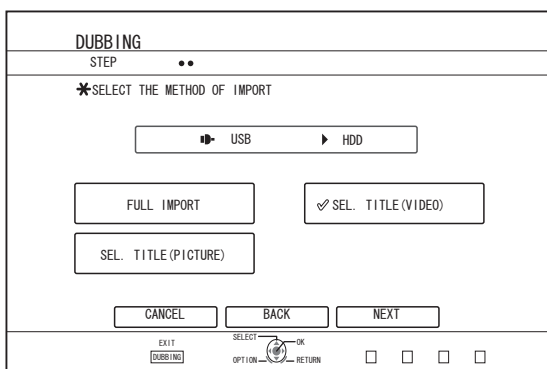

- A screen for creating the import title list appears.

3 Create an import title list

- Follow the steps below to create an import title list.
 - ① Select “ADD TITLE LIST FOR DUBBING”, and press the [OK] button
The Title List screen is displayed.
 - ② Select the titles to import, and press the [OK] button
Titles selected are added to the list.

Memo:

- Press the [MARK] button. A check mark will appear beside the title.
All titles with a check mark can be added to the list at the same time.
- Select a title from the dubbing title list, and press the [OK] button to perform the following changes.
 - Delete the selected title from the list
- Thumbnails will not be displayed when a title is selected.

4 Select “START”, and press the [OK] button

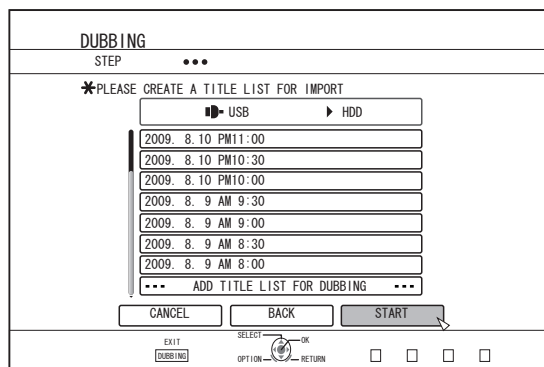

- Importing of titles starts according to the sequence in the created title list.
- After titles are successfully imported, a “DUBBING IS COMPLETED” message appears on the monitor.

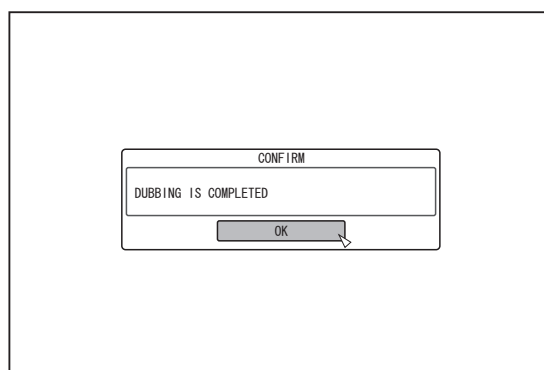

Note:

- “START” cannot be selected for the following cases.
 - A title that cannot be dubbed has been selected
 - HDD memory is insufficient
 - The amount of titles in the HDD has reached the maximum amount
 - A dubbing title list has not been created

Check “Troubleshooting” (page 110), and operate accordingly.

Canceling importing

■ To cancel importing before it starts

- Select “CANCEL” from the menu, and press the [OK] button to cancel importing of a title.
- Alternatively, you can press the [RETURN] button to cancel importing and return to the initial screen.

■ To cancel importing while it is in progress

- Press the [OPTION] button. Select “CANCEL” from the Cancel Importing menu, and press the [OK] button. Doing so imports data to the HDD up to the position where you have chosen to stop.

Importing Data from an SD Card to the HDD

Data can be imported from a SD (SDHC) card to the HDD as follows.

- File formats that can be imported
AVCHD, SD-VIDEO (JVC Everio MPEG2 TS, PS), MOV*/MXF*, and JPEG
- MOV* : MOV format files recorded in the SP mode and HQ mode using the JVC ProHD MEMORY CARD CAMERA RECORDER GY-HM series
- MXF* : MXF format files recorded in the SP mode and HQ mode using JVC ProHD MEMORY CARD CAMERA RECORDER GY-HM650

Memo:

- The SD SLOT does not support SDXC cards.
- To use an SDXC card, connect a SDXC-compatible USB card reader (sold separately) via USB connection.
- This unit may not recognize the SD card if a USB card reader with three or more card slots is used.
- Use a card reader with no more than two card slots.
- Titles that are imported using "FULL IMPORT" combined into one title. This unit does not support combining of titles during the editing operation after import is complete. To combine and import data, select "FULL IMPORT". However, titles of MXF files will not be combined.
- For data that is selected for import via "SEL. TITLE(VIDEO)", titles with the same date are combined.
- Titles of two or more scenes cannot be combined if the recording criteria, such as video size, are different.
- Import of MOV files recorded using JVC GY-HM series SP mode 1080i requires a duration that is about 1.3 times longer than the usual time.

Note:

- Do not remove the SD card when importing of the titles is in progress or when the importing screen is displayed. Doing so may result in loss or damage of the titles.
- For MOV format videos, only videos in the MOV format (SP mode and HQ mode) taken using JVC ProHD MEMORY CARD CAMERA RECORDER GY-HM series are compatible. There is no guarantee for importing videos taken on devices by other company.
- For MXF format videos, only videos in the MXF format (SP mode and HQ mode) taken using JVC ProHD MEMORY CARD CAMERA RECORDER GY-HM650 are compatible. There is no guarantee for importing videos taken on devices by other company.
- Only titles that are not copyright-protected can be imported.

Preparations

1 Insert the SD (SDHC) card into the [SD SLOT]

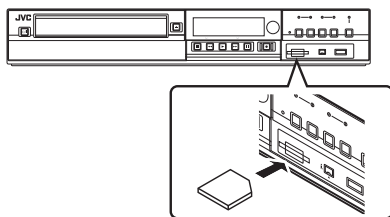

Memo:

- "SD RDY" appears on the display window of the unit when an SD card is recognized.

2 Press the [DUBBING] button on the remote control unit

- The importing screen appears.

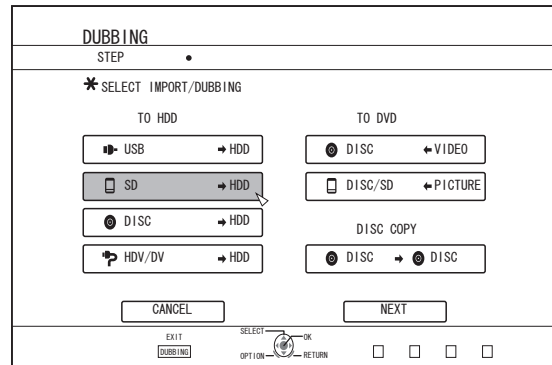

3 Select "SD⇒HDD" in the importing screen, and press the [OK] button

- A check mark is added to the "SD⇒HDD" item.

4 Select "NEXT", and press the [OK] button

- The import selection screen appears.

Full import

1 Select "FULL IMPORT" in the import selection screen, and press the [OK] button

- A check mark is added to the "FULL IMPORT" item.

2 Select "START", and press the [OK] button

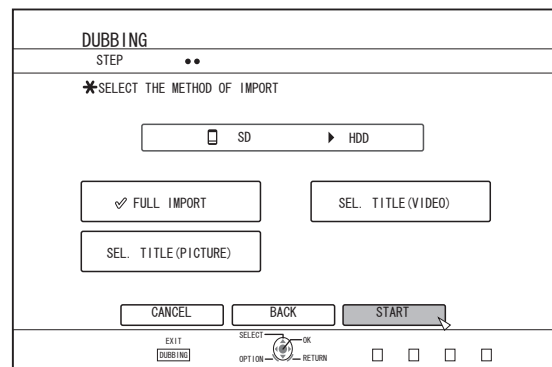

- Importing of the titles starts.
- After titles are successfully imported, a "DUBBING IS COMPLETED" message appears on the monitor.

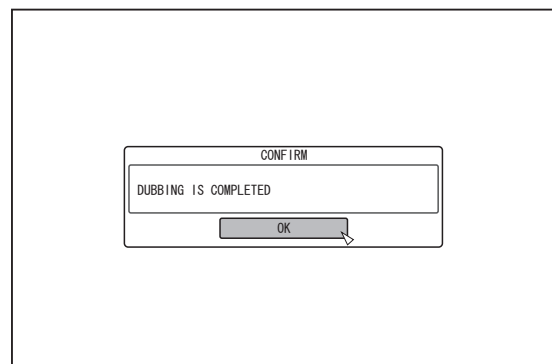

Memo:

- Choose "BACK" from the menu and press the [OK] button to return to the previous screen.

Importing Data from an SD Card to the HDD (Continued)

Specify a title

- 1 Select “SEL. TITLE(VIDEO)” in the import selection screen, and press the [OK] button
 - A check mark is added to the “SEL. TITLE(VIDEO)” item.
- 2 Select “NEXT”, and press the [OK] button

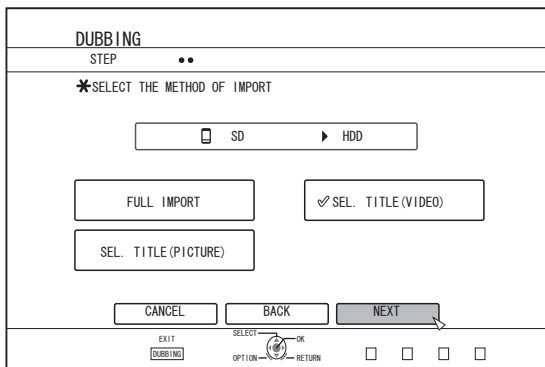

- A screen for creating the import title list appears.

3 Create an import title list

- Follow the steps below to create an import title list.
 - ① Select “ADD TITLE LIST FOR DUBBING”, and press the [OK] button

The Title List screen is displayed.
 - ② Select the titles to import, and press the [OK] button

Titles selected are added to the list.

Memo:

- Press the [MARK] button. A check mark will appear beside the title. All titles with a check mark can be added to the list at the same time.
- Select a title from the dubbing title list, and press the [OK] button to perform the following changes.
 - Delete the selected title from the list
- When there are files of different formats (AVCHD, SD-VIDEO, MOV*/MXF*) in the SD card, press the [RED] button to select the format you want to display.

MOV* : MOV format files recorded in the SP mode and HQ mode using the JVC ProHD MEMORY CARD CAMERA RECORDER GY-HM series

MXF* : MXF format files recorded in the SP mode and HQ mode using JVC ProHD MEMORY CARD CAMERA RECORDER GY-HM650

4 Select “START”, and press the [OK] button

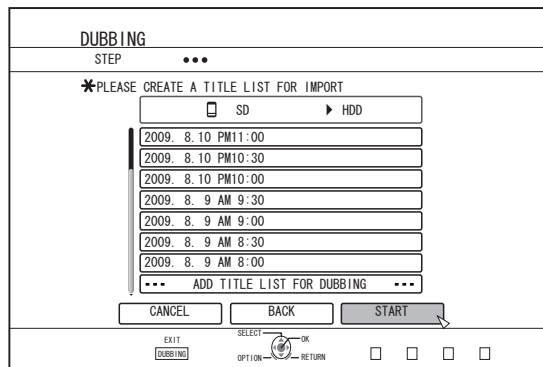

- Importing of titles starts according to the sequence in the created title list.
- After titles are successfully imported, a “DUBBING IS COMPLETED” message appears on the monitor.

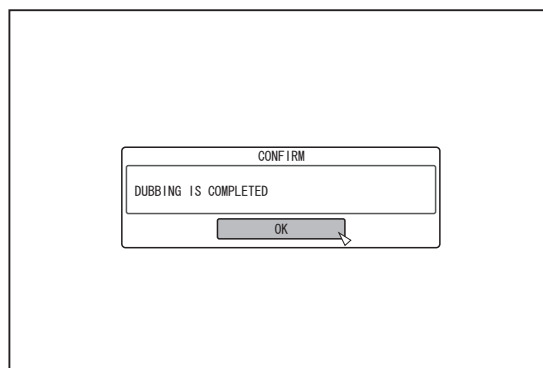

Memo:

- Choose “BACK” from the menu and press the [OK] button to return to the previous screen.

Note:

- “START” cannot be selected for the following cases.
 - A title that cannot be dubbed has been selected
 - HDD memory is insufficient
 - The amount of titles in the HDD has reached the maximum amount
 - A dubbing title list has not been created

Check “Troubleshooting” (page 110), and operate accordingly.

- Thumbnails will not be displayed when a title is selected.

Canceling importing

■ To cancel importing before it starts

- Select “CANCEL” from the menu, and press the [OK] button to cancel importing of a title.
- Alternatively, you can press the [RETURN] button to cancel importing and return to the initial screen.

■ To cancel importing while it is in progress

- Press the [OPTION] button. Select “CANCEL” from the Cancel Importing menu, and press the [OK] button. Doing so imports data to the HDD up to the position where you have chosen to stop.

Importing Data from an i.LINK-compatible Device to the HDD

Data on devices connected to the i.LINK terminal can be imported to the HDD as follows.

- Video formats that can be imported:
DV and HDV content

Memo:

- Only titles that are not copyright-protected can be imported.
- Devices that have in-built copyright protection such as D-VHS and digital tuners cannot be connected. This unit only allows import from tape media.
- Importing will not be performed if no tape has been inserted into the HDV/DV camera.
- Importing will be cancelled when the mode is changed from HDV to DV or vice versa.
- For camcorders that support both HDV and DV recording, use only one of the modes for recording and playback.
- There is no support for editing using a connected PC.
- Only one i.LINK device can be connected to this unit at a time.

Note:

- Turn off the power for this unit and the connecting device when connecting using an i.LINK compatible device.
 - Do not unplug the i.LINK cable while importing to the HDD is in progress. Doing so may result in loss or damage of the titles.
 - For example, during full import of HDV content from JVC GY-HD100 via i.LINK connection, the beginning of the image may not be captured if GY-HD100 is not set as follows.
 - (1) Set the [IEEE1394] switch at the rear of the GY-HD100 unit to [HDV] or [DV] according to the recorded content.
 - (2) Set [MENU]/[VIDEO FORMAT]/[PB TAPE] on the GY-HD100 unit to [HDV] or [DV].
(As with (1), set according to the recorded content. Setting to [AUTO] is not allowed.)
 - (3) Check to ensure that the [HDV] or [DV] lamp on the side of the GY-HD100 unit is lit.
(Check to ensure that the lamp that is lit corresponds to the setting in (1) and (2).)
- When importing from a tape that contains data captured in the HDV recording and DV recording modes, change the video camera setting according to each recording mode, check to ensure that the corresponding lamp in (3) is lit, and choose to start import from the current position.

Preparations

- 1 Connect the device (camera, etc.) to this unit using an i.LINK cable

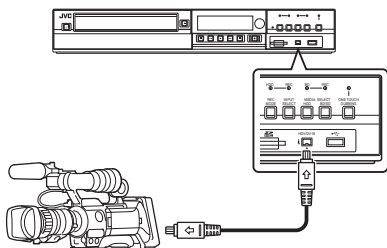

Memo:

- After the device (camera, etc.) has been connected using an i.Link cable, turn on the power of the device and switch it to playback mode. (refer to the device's (camera, etc.) instruction manual for more details.)
- "HDV/DV RDY" appears on the display window of the unit when an i.LINK device is recognized.

- 2 Press the [DUBBING] button on the remote control unit

- The importing screen appears.

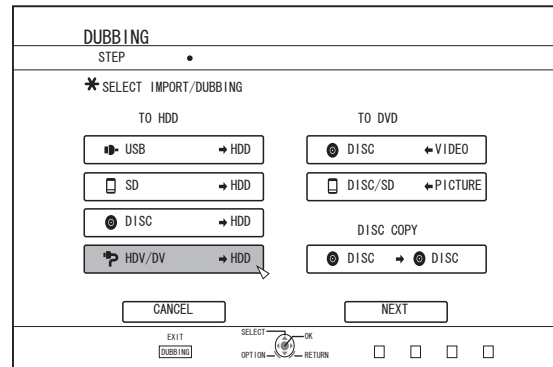

- 3 Select "HDV/DV⇒HDD" in the importing screen, and press the [OK] button

- A check mark is added to the "HDV/DV⇒HDD" item.

- 4 Select "NEXT", and press the [OK] button

- The import selection screen appears.

Imports data from the beginning

You can import videos from the beginning till the end as follows. If the current position is halfway through the tape, import after rewinding the tape to the beginning.

- 1 Select "IMPORT FROM BEGINNING", and press the [OK] button

- A check mark is added to the "IMPORT FROM BEGINNING" item.

- 2 Select "NEXT", and press the [OK] button

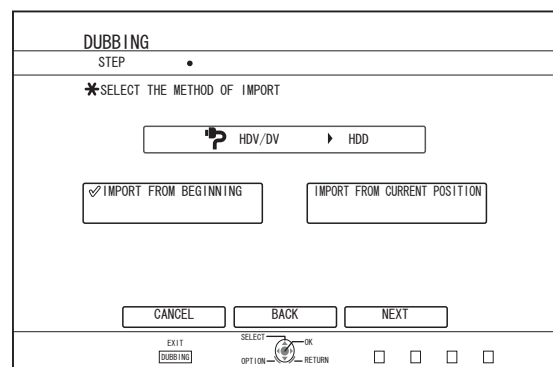

- A recording mode selection screen appears.

- 3 Select "RECORDING MODE", press the [OK] button, and select from the pop-up menu

Importing Data from an i.LINK-compatible Device to the HDD (Continued)

- Select “XP”, “SP”, “LP”, or “EP” from the “RECORDING MODE” option.

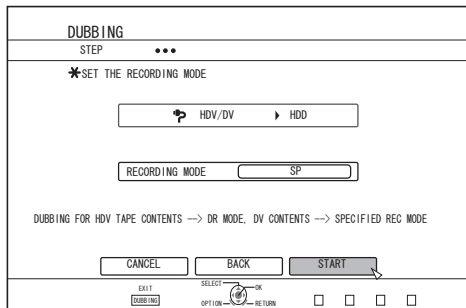

Memo:

- HDV contents will be imported in DR mode.

For details, refer to “Recording Modes” (page 31).

4 Select “START”, and press the [OK] button

- Importing of the titles starts.
- After titles are successfully imported, a “DUBBING IS COMPLETED” message appears on the monitor.

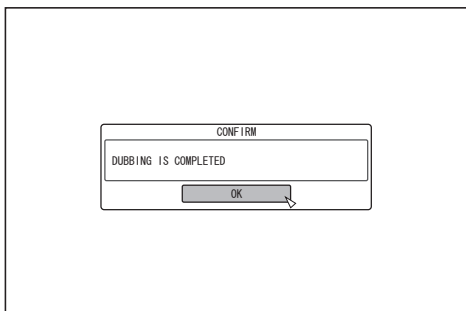

Imports data from current position

You can import videos from the current tape position till the end as follows.

1 Select “IMPORT FROM CURRENT POSITION”, and press the [OK] button

- A check mark is added to the “IMPORT FROM CURRENT POSITION” item.

2 Select “NEXT”, and press the [OK] button

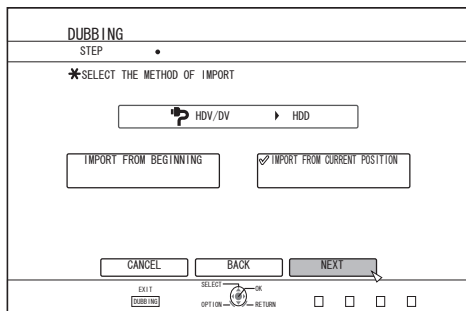

- A recording mode selection screen appears.

3 Select “RECORDING MODE” and press the [OK] button to display the pop-up menu

- Select “XP”, “SP”, “LP”, or “EP” from the “RECORDING MODE” option.

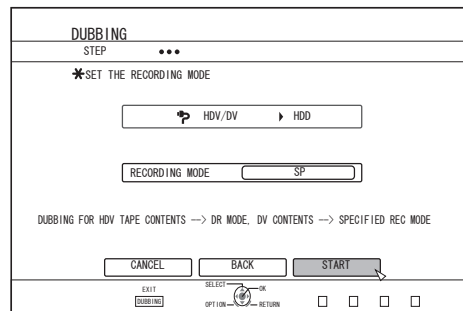

Memo:

- HDV contents will be imported in DR mode.

For details, refer to “Recording Modes” (page 31).

4 Select “START”, and press the [OK] button

- Importing of the titles starts.
- After titles are successfully imported, a “DUBBING IS COMPLETED” message appears on the monitor.

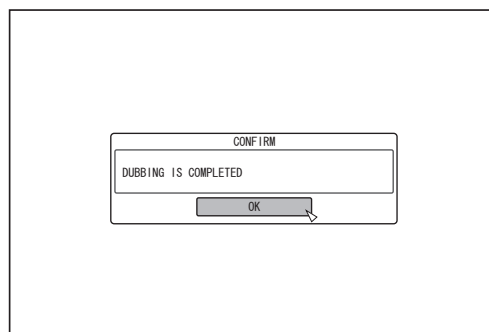

Canceling importing

■ To cancel importing before it starts

- Select “CANCEL” from the menu, and press the [OK] button to cancel importing of a title.
- Alternatively, you can press the [RETURN] button to cancel importing and return to the initial screen.

■ To cancel importing while it is in progress

- Press the [OPTION] button. Select “CANCEL” from the Cancel Importing menu, and press the [OK] button. Doing so imports data to the HDD up to the position where you have chosen to stop.

Importing Data from a LAN-compatible Device to the HDD (only for SR-HD1700)

Data on devices connected to the LAN terminal can be imported to the HDD as follows.

- File formats that can be imported
MOV (MPEG2-TS), MXF (MPEG2-TS)
- Image resolutions that can be imported
(for NTSC)
1920x1080/59.94i, 1920x1080/29.97p, 1920x1080/23.98p,
1440x1080/59.94i,
1280x720/59.94p, 1280x720/29.97p, 1280x720/23.98p
(for PAL)
1920x1080/50i, 1920x1080/25p, 1440x1080/50i,
1280x720/50p, 1280x720/25p

Memo:

- Still image files cannot be imported.
- MOV (H.264) and MXF (H.264) files cannot be imported.
- SR-HD1350 does not support import from a LAN-compatible device.

■ Preparations

1 Connect the LAN device (PC, etc.) to this unit using a LAN cable

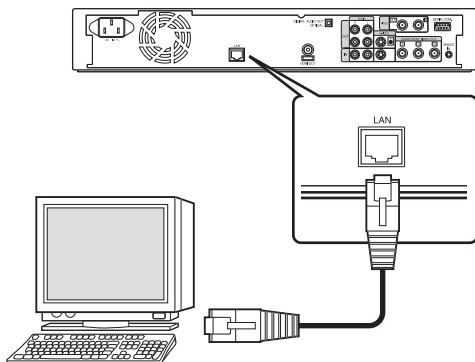

Memo:

- Execute the network setting.
For details, refer to "NETWORK SETTING(only for SR-HD1700)" (page 90).
- Make use of FTP for file transfer.
- Use the PC as the FTP client, and this unit as the FTP server.

2 Perform FTP transfer

- Importing of the files starts.

Memo:

- Do not unplug the LAN cable while importing to the HDD is in progress.
- You can execute FTP transfer with multiple files selected.
- In the event that an error occurs during FTP transfer, import of the file for which transfer is in progress and those that are not transferred will be canceled.
- Make use of an FTP client software for FTP transfer.
Examples of FTP client software
Windows : FTP client function of Internet Explorer, etc.
Mac OS : Cyberduck, etc.

- To import to the HDD, the capacity of the HDD must be twice the size of the transfer files.
The available disk space in the HDD is stated in the Readme.txt (*1) file.
Download the file to check when transferring the files.
(*1) : The file is located in the current directory of the HDD in this unit.
- Setting items for FTP communication

| | |
|--------------------|----------------------------|
| user (user name) | : Optional |
| pass (password) | : Optional |
| mode | : Either passive or active |
| port (port number) | : 21 |

Dubbing a Title from the HDD to a BD/DVD

Titles stored in the internal HDD can be dubbed to a BD/DVD as follows.

Memo:

- Disc types that can be used for dubbing with this unit are: BD-RE, BD-R, DVD-RW, and DVD-R.

For details, refer to “Discs that enable both dubbing and playback” (page 13).

- HD content for which the delete scene operation has been applied cannot be dubbed to BDMV. Perform seamless conversion before starting a dubbing operation.
- Contents imported from HDV (DR mode) and HD Everio cannot be dubbed to a BDMV disc. Perform mode conversion before starting a dubbing operation.

For details, refer to “Mode conversion” (page 81).

Note:

- The following high bit-rate files may not meet the Blu-ray Disc standards when they are dubbed to a BD.
 - When a BDAV/BDMV disc is created (high-speed dubbing) by importing content recorded in the JVC GY-HM series (SP mode or HQ mode).
 - When a BDAV disc is created (high-speed dubbing) by importing content captured in the JVC GZ-HD7/6 etc FHD mode.
 - When a BDAV/BDMV disc is created by importing content that is captured using another video camera at a peak bit-rate that exceeds 28.8 Mbps.
- If the Blu-ray Disc standards are not met, playback on another player may fail. To ensure that the standards are satisfied, perform high-speed dubbing after converting the recording mode, or perform dubbing by specifying a recording mode.

Dubbing from the HDD to a BD/DVD

■ Preparation

1 Set a BD or DVD on the disc tray

Memo:

- A message appears on the monitor in the following cases where a disc cannot be written to. Take the necessary actions according to the message.
 - When an incompatible disc type is set
 - When there is insufficient space on the set disc
 - When a finalized disc is set

2 Press the [DUBBING] button on the remote control unit

- The Dubbing menu screen appears.

3 On this screen, select “DISC↔VIDEO”

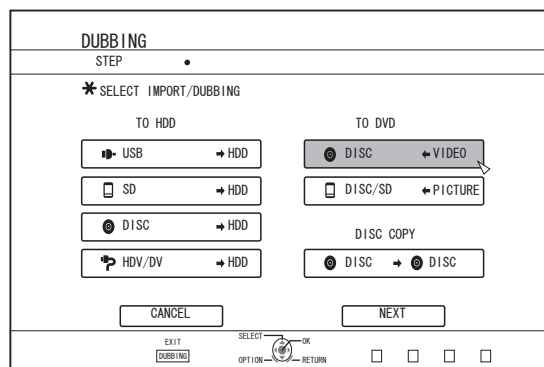

- A check mark is added to the “DISC↔VIDEO” item.

4 Select “NEXT”, and press the [OK] button

Memo:

- Dubbing can also be performed from the Playback Navigation screen.
 - ① Select the titles to dub, and press the [OPTION] button
 - ② Select “DUB”, and press the [OK] button
 - ③ Follow Steps 3 to 4 of “Preparation”

■ Dubbing titles

1 Select “RECORDING FORMAT”, and press the [OK] button

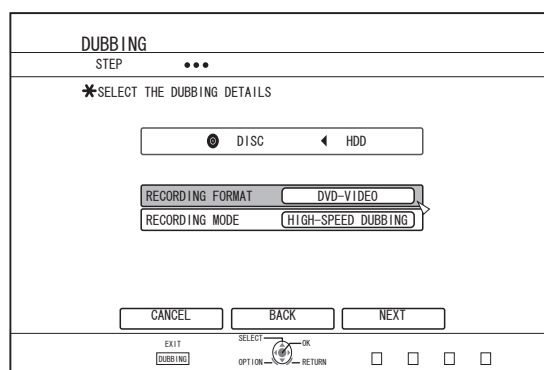

- Choose a format.

For details, refer to “Format chart” (page 28).

2 Select “RECORDING MODE”, and press the [OK] button

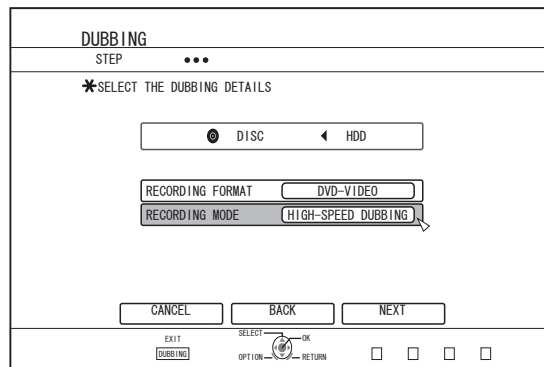

- Select “HIGH-SPEED DUBBING” or a recording mode of your preference.

Memo:

- High-speed dubbing
Select this option if you want to significantly shorten the time required for dubbing.
Make use of a disc that supports high-speed recording.
- AF/AN/AL/AE
Can be selected for BD-R and BD-RE. Dubbing is done with HD picture quality.
- XP/SP/LP/EP
Dubbing is done with SD picture quality.
- FR
An appropriate mode will be chosen automatically between XP to EP according to the remaining memory on the disc.
For details, refer to “Dubbing chart” (page 27) and “Recording Modes” (page 31).

3 Select “NEXT”, and press the [OK] button

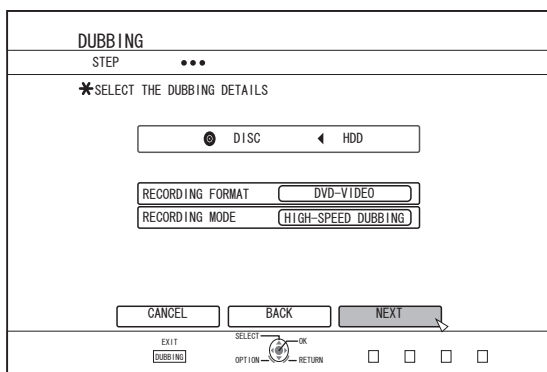

- A screen for creating a dubbing title list appears.

4 Create a dubbing title list

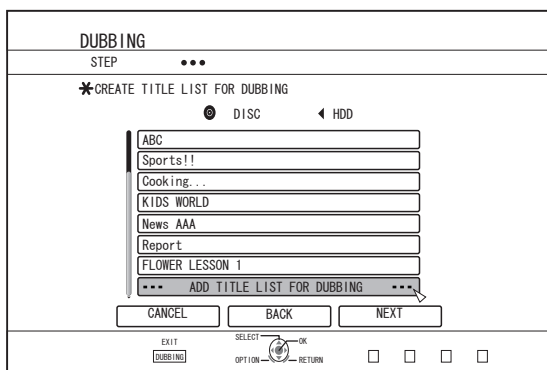

- Follow the steps below to create a dubbing title list.
 - ① Select “ADD TITLE LIST FOR DUBBING”, and press the [OK] button
 - ② Select the titles to dub, and press the [OK] button

Memo:

- Press the [MARK] button. A check mark will appear beside the title.
All titles with a check mark can be added to the list at the same time.
- Select a title from the dubbing title list, and press the [OK] button to perform the following changes.
 - Delete the selected title from the list
 - Change the list arrangement
 - Change the name of the selected title
Select “RENAME TITLE”, and press the [OK] button to change the title of the dubbing source. Dubbing of the new title is performed.
- The recording mode and recording time of the selected video title is displayed at the top right corner of the screen.

5 Select “NEXT”, and press the [OK] button

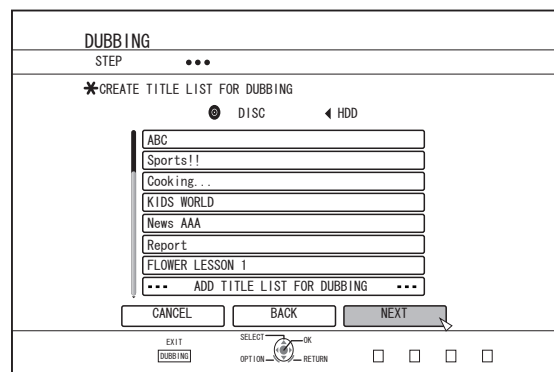

Note:

- “NEXT” cannot be selected for the following cases.
 - A title that cannot be dubbed has been selected
 - Disc memory is insufficient
 - A dubbing title list has not been created

Check “Troubleshooting” (page 110), and operate accordingly.

Memo:

- Steps 6 and 7 are not applicable for “BD-DAV” and “DVD-VR” disc formats. Go to step 8.

6 Select a background image for the disc menu

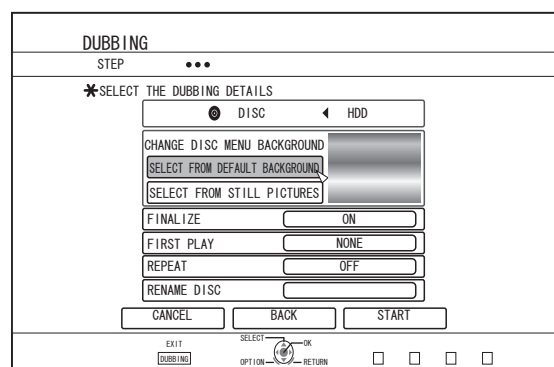

- Select a background image for the disc menu from “Background” or “Still Picture”.
 - “SELECT FROM DEFAULT BACKGROUND”
A default background set is used for the disc menu.

Dubbing a Title from the HDD to a BD/DVD (Continued)

- “SELECT FROM STILL PICTURES”

Use a still image on the HDD for the disc menu.
The largest size allowed for a still image that is used as the background is 5120 x 3840.

Memo:

- The background image of the disc menu can be selected (only for DVD-Video and BDMV).
- The following sizes are recommended for still images.
BD : 1920 x 1080
DVD : 720 x 480 (for NTSC)
720 x 576 (for PAL)
- When a still image is used, the two vertical or horizontal edges are trimmed based on the side that is smaller than the aspect ratio of the video to be dubbed.

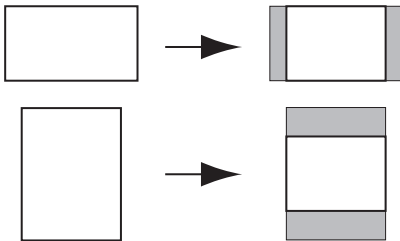

Example of Side-cut Still Image

7 Set the operations for finalize

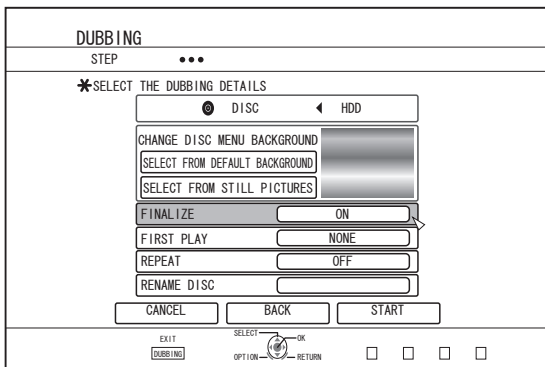

- Finalize will be performed after dubbing if “ON” has been set for “FINALIZE”.
If a BDMV disc is being dubbed, “OFF” cannot be set for “FINALIZE”. And once the BDMV disc is dubbed the disc cannot be rewritten.
- If a DVD-Video or BDMV disc is being dubbed, the settings for “FIRST PLAY”, “REPEAT” and “RENAME DISC” can be changed.
 - ① **Select “FIRST PLAY”, and select either “NONE”, “TOP MENU” or “TITLE 1”**
 - “NONE”
A finalized disc will not be automatically played back when it is inserted into another device.
 - “TOP MENU”
The disc menu will be displayed automatically when a finalized disc is inserted into another device.

- “TITLE 1”

The first title on a finalized disc will be played back automatically when it is inserted into another device.

Memo:

- “NONE” cannot be selected for “FIRST PLAY” for BDMV.
- ② **Select “REPEAT”, and choose either “OFF” or “ON”**
 - “OFF”
The disc will stop and the menu will be displayed after all the titles are played back.
 - “ON”
Repeat playback from the first title will start automatically after all the titles are played back.
 - ③ **Select “RENAME DISC”, and press the [OK] button**
 - A screen for entering the disc name appears.
Finalization is performed using the entered disc name.

8 Select “START”, and press the [OK] button

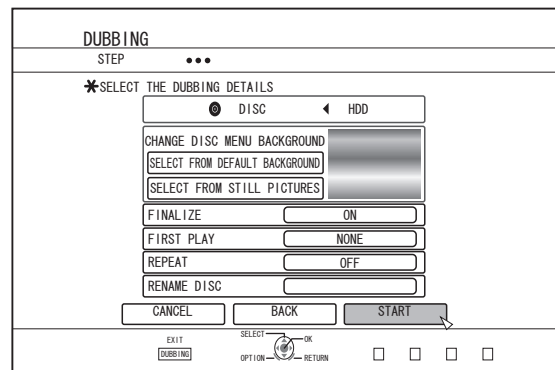

- Dubbing starts. A progress bar is displayed during the dubbing process.
- After dubbing is complete, a “DUBBING IS COMPLETED” message appears on the monitor.

Memo:

- Choose “BACK” from the menu and press the [OK] button to return to the previous screen.

Cancel dubbing

To cancel dubbing before it starts

- Select “CANCEL” from the menu, and press the [OK] button to cancel dubbing.
- Alternatively, you can press the [RETURN] button to cancel dubbing and return to the initial screen.

To discontinue dubbing while it is in progress

- Press the [OPTION] button. Select “CANCEL” from the Cancel Dubbing menu, and press the [OK] button. Data will be written onto the disc up to the point where import is cancelled.

Memo:

- When dubbing to a BD-R or DVD-R, the disc memory will be reduced as data will still be written onto the disc up to the point where dubbing is discontinued.

Dubbing Still Images from the HDD

Still images stored in the internal HDD can be dubbed to a BD-RE or an SD card as follows.

Memo:

- Only “JPEG” still image format is supported.
- For details, refer to “Dubbing chart” (page 27) .

■ Before dubbing

- Dubbing to a disc
Set the BD-RE for dubbing on the disc tray
- Dubbing to an SD card
Insert the SD card to be dubbed into the [SD SLOT]

■ Dubbing still images

1 Press the [DUBBING] button on the remote control unit

- The Dubbing menu screen appears.

2 On this screen, select “DISC/SD⇄PICTURE”

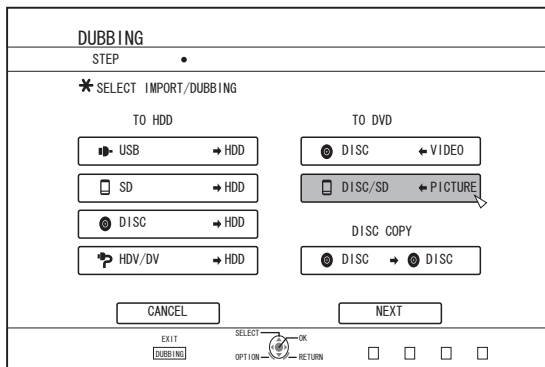

3 Select the media to dub to from the media selection screen

- A checkmark will be added to the selected media.

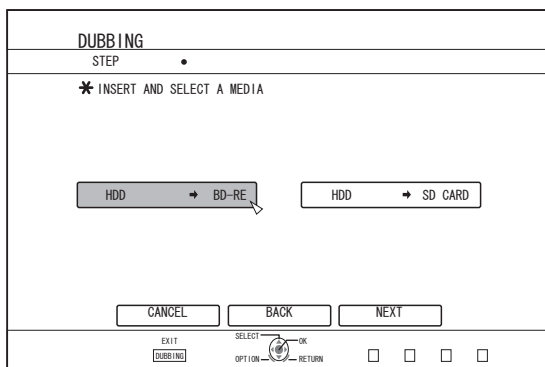

4 Select “NEXT”, and press the [OK] button

Memo:

- A message appears on the monitor when dubbing cannot be performed in the following cases. When this occurs, replace the disc or SD card with one that is usable.
 - When an incompatible disc or SD card is set
 - When there is insufficient space on the set disc or SD card
 - When an unformatted disc or SD card is set

For details, refer to “Formatting a disc” (page 28) or “Formatting an SD Card” (page 30) .

5 Select the still images to dub, and press the [MARK] button

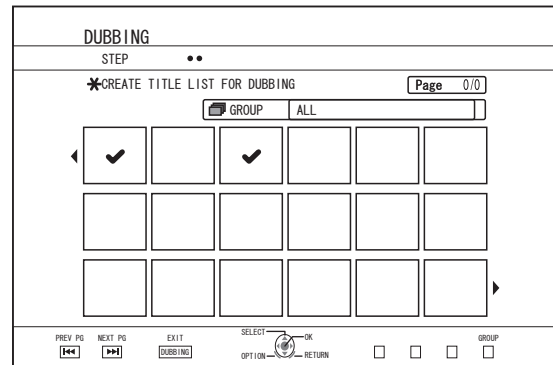

- Pressing the [MARK] button adds a check mark to the selected image.
All still images with a check mark are dubbed.

Memo:

- To clear the check mark, select the corresponding still image, and press the [MARK] button.
- Pressing the [OPTION] button displays a pop-up menu. The pop-up menu enables you to perform the following operations.

- BACK : Exits the pop-menu and returns to the initial screen.
- SELECT ALL : Selects all still images within the same group.
- DESELECT ALL : Clears the selection of all still images within the same group.

Note:

- A message appears if the selected still images do not fit into the disc. Check mark cannot be added to a still image if there is insufficient space on the disc.

Dubbing Still Images from the HDD (Continued)

6 Select "START", and press the [OK] button

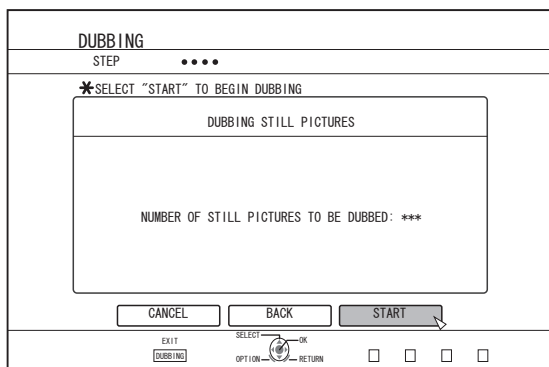

- Dubbing starts. A progress bar is displayed during the dubbing process.
- After dubbing is complete, a "DUBBING IS COMPLETED" message appears on the monitor.

Memo:

- A directory of the following configuration is created in the media, and still images are written with file names ranging from "PIC_0001.jpg" to "PIC_9999.jpg".

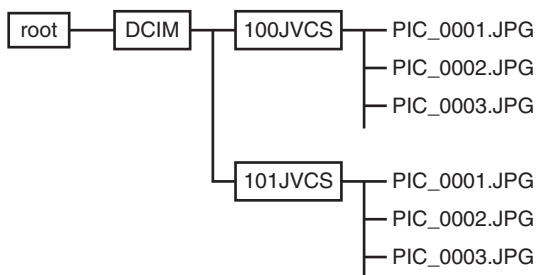

■ Dubbing from the Playback Navigation screen

Dubbing can also be performed from the Playback Navigation screen.

7 Select the still images to dub, and press the [OPTION] button

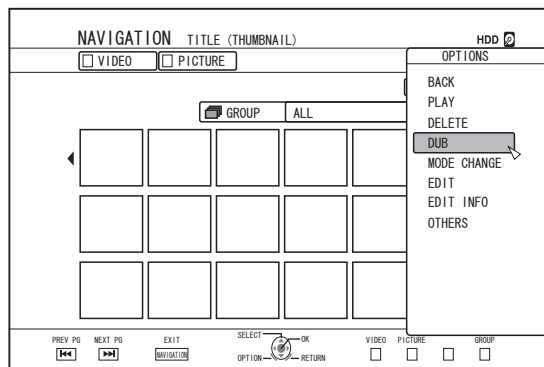

2 Select "DUB", and press the [OK] button

3 Follow steps 3 to 5 of "Dubbing still images"

Memo:

- Check marks of still images that appear on the Playback navigation screen will remain added to the image on the still image selection screen.

■ Cancel dubbing

To cancel dubbing before it starts

- Select "CANCEL" from the menu, and press the [OK] button to cancel dubbing.
- Alternatively, you can press the [RETURN] button to cancel dubbing and return to the initial screen.

To discontinue dubbing while it is in progress

- Press the [OPTION] button. Select "CANCEL" from the Cancel Dubbing menu, and press the [OK] button. Data will be written onto the disc up to the point where import is cancelled.

Enabling Playback on Other Devices (Finalizing)

DVD-R and DVD-RW discs may need to be finalized before they can be played on other DVD players. BD-R discs need to be finalized before they can be played on other BD players.

Memo:

- Discs in the Video mode becomes a DVD-Video format with a title menu after finalizing.
- Discs containing DVD-Video data can be finalized by setting the disc operation settings according when the disc is inserted into this unit.
- Recording or editing of the disc will not be possible after it is finalized.
- If a DVD that was recorded using VR mode has been finalized, the disc can only be played back on VR mode compatible devices.

Finalizing

- 1 Set the BD or DVD to be finalized on the disc tray
 - 2 Press the [MEDIA MANAGE] button on the remote control unit
- The Media Management menu screen appears.

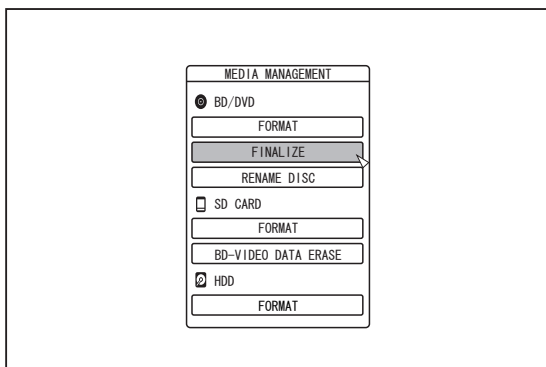

- 3 Select "FINALIZE" from "BD/DVD"
 - 4 Select "YES" and press the [OK] button
- The top menu setting screen appears.

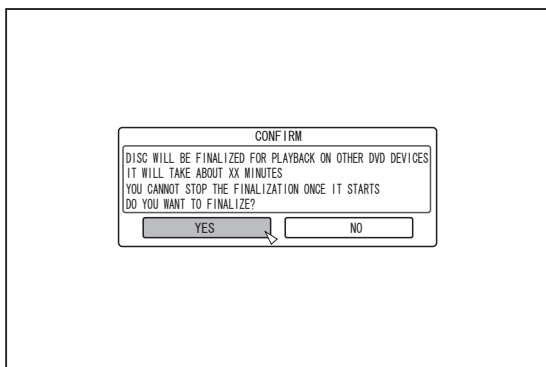

Memo:

- To cancel the finalizing operation, select "NO" and press the [OK] button.

5 Setting the top menu items

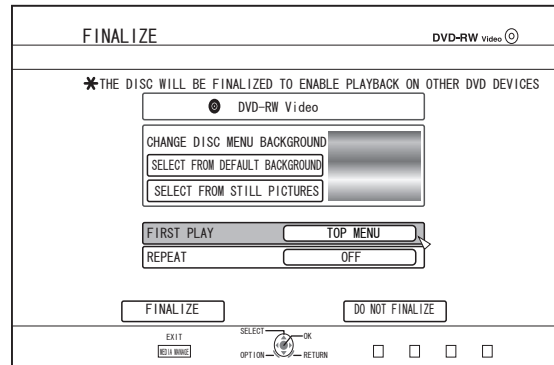

- Before finalizing, set "FIRST PLAY", "REPEAT", and "CHANGE DISC MENU BACKGROUND" accordingly. Set according to the steps below.
 - ① Select "FIRST PLAY", and select an appropriate first play setting item
 - This item is used for setting the disc operation when a finalized disc is inserted into another device.
 - NONE : A finalized disc will not be automatically played back when it is inserted into another device.
 - TOP MENU : The disc menu will be displayed automatically when a finalized disc is inserted into another device.
 - TITLE 1 : The first title on a finalized disc will be played back automatically when it is inserted into another device.
 - ② Select "REPEAT", and select an appropriate repeat setting item
 - Set the disc action to be taken after all titles have been played back.
 - OFF : The disc will stop and the menu will be displayed after all the titles are played back.
 - ON : Repeat playback from the first title will start automatically after all the titles are played back.

Enabling Playback on Other Devices (Finalizing) (Continued)

- ③ Select “CHANGE DISC MENU BACKGROUND” to select a background image for the top menu
- You can register and use a background image of your preference.

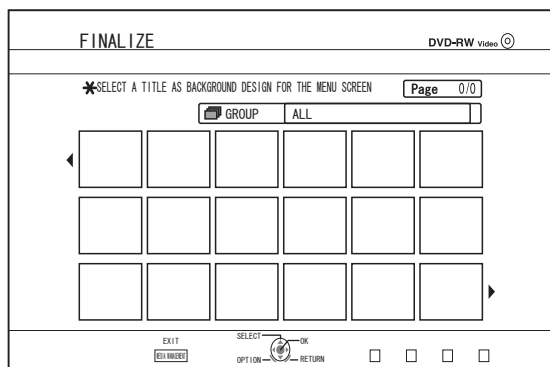

Memo:

- The items in “FIRST PLAY”, “REPEAT” and “CHANGE DISC MENU BACKGROUND” can also be set in “Dubbing a Title from the HDD to a BD/DVD” (page 44).

6 Select “FINALIZE”, and press the [OK] button

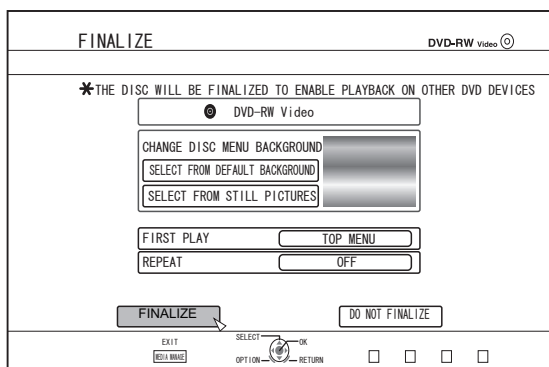

- Finalizing starts.
- After finalization is complete, a “THE DISC HAS BEEN FINALIZED” message appears on the monitor.

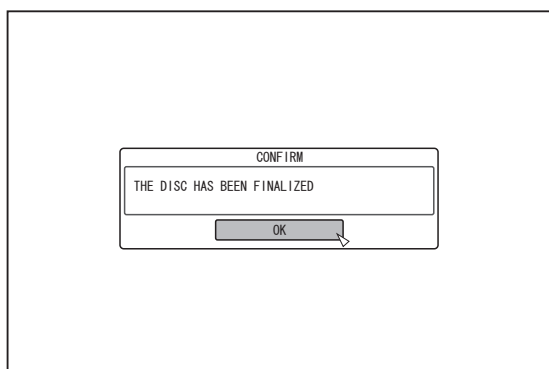

Unfinalizing a disc

Only DVD-RW discs that are finalized on this unit can be unfinalized. After a disc is unfinalized, addition of new titles and editing are possible.

Note:

- All discs except DVD-RW (VR mode) cannot be unfinalized.

■ To unfinalize a disc

- 1 Set a DVD-RW disc that is finalized by this unit on the disc tray
- 2 Press the [MEDIA MANAGE] button on the remote control unit
- The Media Management menu screen appears.

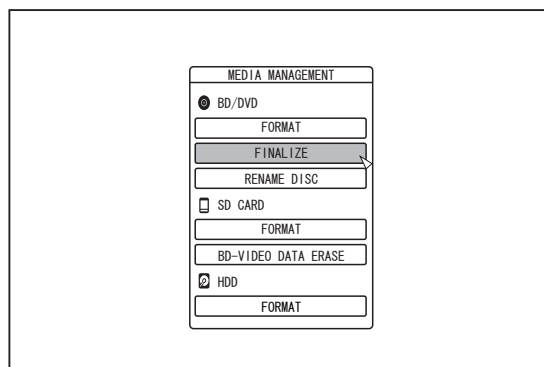

3 Select “FINALIZE” from “BD/DVD”

4 Select “YES” and press the [OK] button

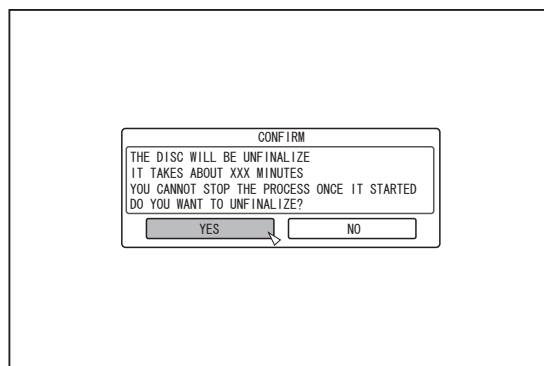

- Unfinalizing starts.
- After unfinalizing is complete, a “THE DISC HAS BEEN UNFINALIZED” message appears on the monitor.

Copying the Entire Disc

Copying the entire disc allows all contents on a BD (BD-RE, BD-R, BDMV) or DVD (AVCHD, DVD-Video, DVD-VR) to be copied onto another disc.

Note:

- Contents on a DVD-VR that is not finalized cannot be copied to other discs.
- Content cannot be copied to a formatted BD-R or DVD-R disc. Make use of an unformatted disc.
- To copy to a BD disc, use BD-R or BD-RE discs. To copy to a DVD, use DVD-R/-RW discs.
- The disc to be copied onto will be formatted when copy is performed. Check that the disc has not been used before or if it is ok to delete data on the disc when using a BD-RE or a DVD-RW.
- In the case of BD, volume labels are not copied.
- If an unsupported disc is set, “UNABLE TO IMPORT FROM DISC” or “UNABLE TO DUB ONTO DISC INSERT ANOTHER DISC” will be displayed on the monitor. Use a disc that is supported by this unit.
- For details on discs that are supported by this unit, refer to “Discs that enable both dubbing and playback” (page 13) and “Discs that enable playback only” (page 13).

1 Press the [DUBBING] button on the remote control unit

- The Dubbing screen appears.

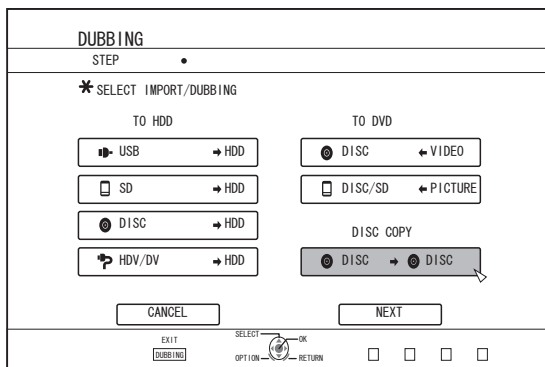

2 Select “DISC⇒DISC”, and press the [OK] button

- A menu screen for copying the entire disc appears.

Memo:

- During copy of the entire disc, data is temporarily copied to the internal HDD.
- Only discs that are not copyright-protected can be copied.

3 Set the number of discs to copy using the [▲/▼] buttons

- You can specify up to a maximum of 10 discs.

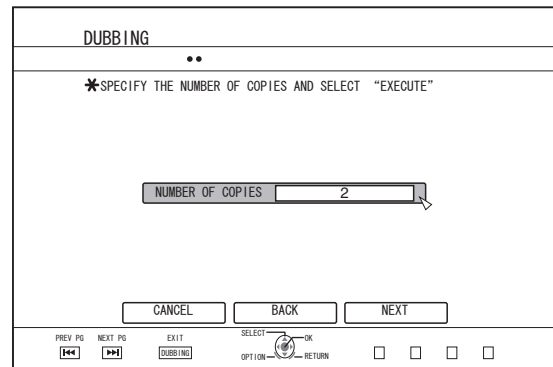

4 Select “NEXT”, and press the [OK] button

- The disc tray will open automatically.

5 Set the source BD or DVD on the disc tray

6 Select “START”, and press the [OK] button

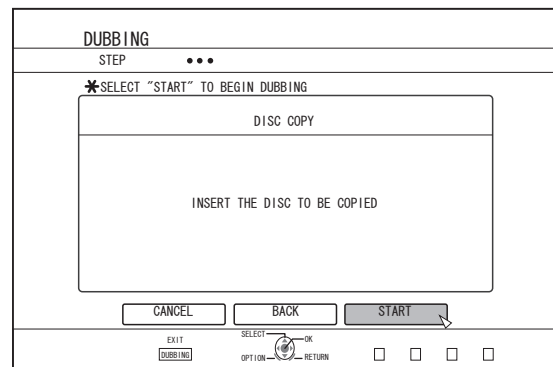

- The disc tray will close automatically. The source BD or DVD will be recognized, and copying to the internal HDD will proceed.
- The disc tray will open automatically after copying has finished and “READY TO COPY NOW. INSERT THE DISC FOR COPYING” will be displayed on the monitor.

Memo:

- Confirm the insufficient space on the internal HDD when the copy interrupts.

7 Set a BD or DVD to copy on the disc tray

Copying the Entire Disc (Continued)

8 Select "START", and press the [OK] button

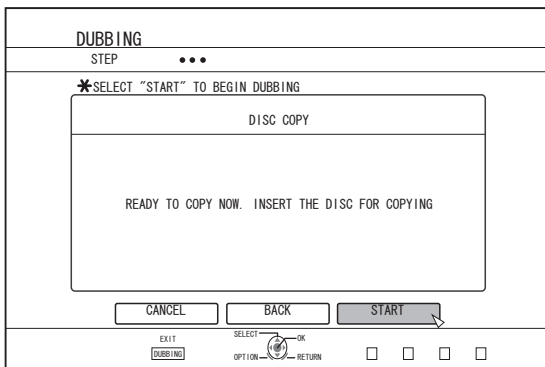

- The disc tray will close automatically. BD or DVD will be recognized, and the contents that were copied to the HDD will be copied to the disc.

Memo:

- The copy operation will not be performed when the remaining disc memory is not sufficient.

9 Complete the entire disc copying

- After copy is complete the tray will open automatically, and copy of the entire disc ends.

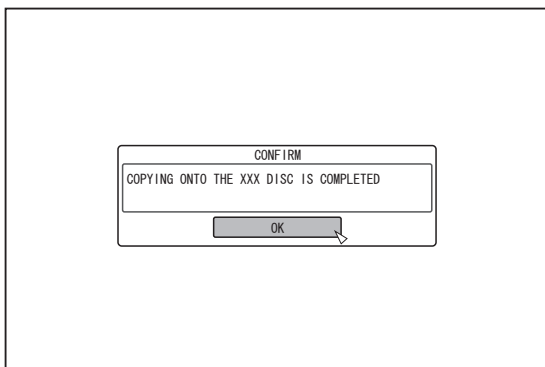

Memo:

- The screen prompting you to insert a new disc appears repeatedly until this unit has finished copying the number of discs specified in Step 3. When the message appears, set a new BD or DVD on the disc tray, select "START", and press the [OK] button.

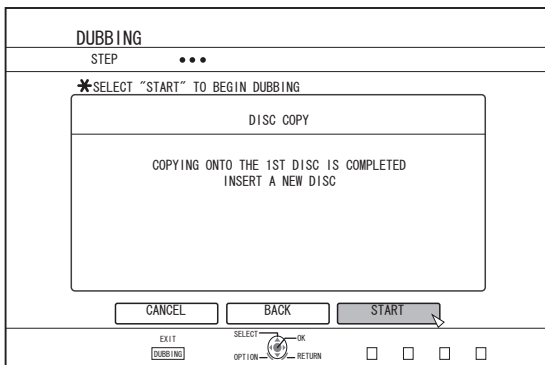

- After copy is complete, the data copied onto the HDD will be deleted.
- Select "CANCEL" from the menu, and press the [OK] button to cancel disc copying.

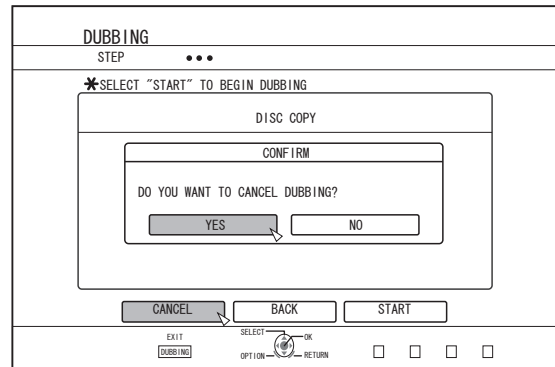

Direct recording to discs

The video from the external device can be recorded to the optical disc directly.

- 1 Press the [BD/SD] button on either this unit or the remote control to specify the “BD” as a recording medium
- 2 Press the [▲] button on either this unit or the remote control to set a DISC on the disc tray
- 3 Format a DISC
 - For details on formatting, refer to “Formatting” (page 28).
- 4 Press the [INPUT SELECT] button either on this unit or the remote control to start the video to be recorded
- 5 Press the [●] and [▶] buttons either on this unit or on the remote control together to start recording

Memo:

- Supported discs are BD-R/RE and DVD-R/RW.
- Format the BD-R/RE disc to the BDAV or BDMV format.
- Menu cannot be created when recording directly to a BDMV format disc.
- Format the DVD-R/RW disc to the VR or Video format.

Pausing recording

You can pause the process while recording videos to the HDD or a BD/DVD.

- 1 Select the location to record videos to
- 2 Press the [■] button on this unit or the remote control

Memo:

- Titles for which recording is in progress will not be divided when recording is paused.

Resuming Recording

- 1 While recording is paused, press the [■] button on this unit or the remote control

Memo:

- You can also resume recording by pressing the [●] button on the unit.
- You can also resume recording by pressing the [▶] button while holding down the [●] button on the remote control.
- A chapter is automatically created when recording resumes.

Recording Using External Inputs

Videos on an external device that is connected to i.LINK (HDV/DV) or video/S-video input can be recorded to the HDD. BD, DVD can be recorded from the [VIDEO]/[S-VIDEO] or SDI input.

Memo:

- Only titles that are not copyright-protected can be imported.

- 1 Press the [HDD] or [BD/SD] button to select the location to record the file
- 2 Press the [INPUT SELECT] button on the remote control, and select an external input (HDV/DV or L-1)
- 3 Press the [REC MODE] button and select a recording mode
- 4 Press the [●] and [▶] remote control buttons together to start the recording process
 - Recording can also be start by pressing the [●] button on this unit.
- 5 Operate the external device to output the videos to be recorded to the i.LINK (HDV/DV) or the video/S-video input.
- 6 Press the [■] button on either this unit or the remote control to display the pop-up screen, choose “STOP” and press the [OK] button

- End the recording.

Memo:

- When recording images via a video camera using i.LINK connection, recording may stopped if the video camera is loaded with a DV tape while in the shooting mode. In this case, remove the DV tape before recording.
- Recording will be stopped if the maximum recording time has been reached, or if there is insufficient memory in the media.
- It takes a little moment to start recording after the button is pressed.

For the recording modes and maximum recording time for each disc, refer to “Maximum recording time for each recording mode” (page 31).

Recording Using External Inputs (Continued)

■ RECORDABLE MEDIA

| RECORDING MODE | RECORDABLE MEDIA | | | |
|----------------|------------------|---|--------------------------|--------------------------|
| | HDD | DVD-R/RW (VR Format/Video Format) | BD-R/RE (BDAV format) | BD-R/RE (BDMV Format) |
| DR | HDV | - | HDV | - |
| AF (HD) | HDV | - | HDV | HDV |
| AN (HD) | HDV | - | HDV | HDV |
| AL (HD) | HDV | - | HDV | HDV |
| AE (HD) | HDV | - | HDV | HDV |
| XP (SD) | DV/L-1 | DV/L-1 | L-1 | - |
| SP (SD) | DV/L-1 | DV/L-1 | L-1 | - |
| LP (SD) | DV/L-1 | DV/L-1 | L-1 | - |
| EP (SD) | DV/L-1 | DV/L-1 | L-1 | - |

About Playing Back

Videos or edited videos stored on the internal HDD, as well as videos stored on a disc or SD card can be played back on this unit.

The types of media that are playable on this unit are as follows.

- Videos and still images stored on the internal HDD
- Videos stored on different disc types
- Videos and still images stored on backup discs created using the “Everio Writer”
- Videos and still images stored on SD cards

These videos can be easily played back for viewing using the “Playback Navigation” software that comes with this unit.

For details on the “Playback Navigation” software, refer to “Using Playback Navigation” (page 55).

Memo:

- This unit does not support DivX videos.
- If AVCHD files are displayed in thumbnails, black bars may appear on the left and right borders depending on the video resolution.
- To display MOV*/MXF* files stored on an SD card using Playback Navigation, make use of list display. Thumbnail display is not supported. Files on the SD card cannot be played back directly. To do so, import them into a HDD.
- For details on importing MOV*/MXF* files from an SD card, refer to “Importing Data from an SD Card to the HDD” (page 39).

MOV* : MOV format files recorded in the SP mode and HQ mode using the JVC ProHD MEMORY CARD CAMERA RECORDER GY-HM series

MXF* : MXF format files recorded in the SP mode and HQ mode using JVC ProHD MEMORY CARD CAMERA RECORDER GY-HM650

Display Marks on the Playback Navigation Screen

| Icon | Mark name | Explanation |
|------|-----------------------------|---|
| | Protect Mark | Indicates protected titles. |
| | Mode Conversion Preset Mark | Indicates titles for which mode conversion has been preset. |
| | Not Viewed Mark | Indicates titles that have not been viewed or groups containing titles that have not been viewed. |
| | Scene Delete Mark | Indicates titles for which scene delete or chapter delete has been applied. |
| | Group Mark | Indicates a group. |
| | Playlist Mark | Indicates a playlist. |
| | Not Playable Mark | Indicates titles that cannot be played. |
| | Question Mark | Indicates titles of which the thumbnails cannot be displayed. Playback may not be possible. |

Using Playback Navigation

Videos can be easily played back for viewing using the “Playback Navigation” function available on this unit.

Displaying the Playback Navigation screen

1 Select the location of the playback file

- Press the [HDD] button on the remote control unit
Play back videos or still images stored on the HDD.
- Press the [BD/SD] button on the remote control unit.
Play back videos or still images stored on a BD/DVD or a SD.

2 Press the [NAVIGATION] button on the remote control unit

- The Playback Navigation screen appears.

Memo:

- Pressing the [BD/SD] button each time switches the media to play back between BD/DVD and SD.
- You can also switch the media to play back by pressing the [HDD] or [BD/SD] button when the Playback Navigation screen is displayed.
- The recording mode and recording time of the selected video title is displayed at the top right corner of the screen.

Operating Playback Navigation

■ Playing a video/still image

Plays the selected video/still image.

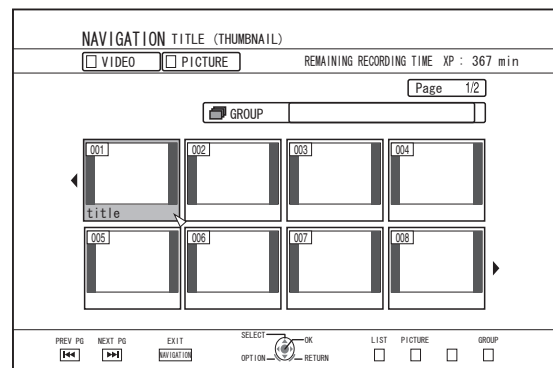

- Select a title to play back, followed by pressing the [OK] or [▶] button to play the selected video/still image.

Memo:

- Select a group and press the [OK] button to display all titles in the group.

Using Playback Navigation (Continued)

Switching between thumbnail and list displays

You can switch between the thumbnail display and list display of a video.

- When the video thumbnail list screen is displayed

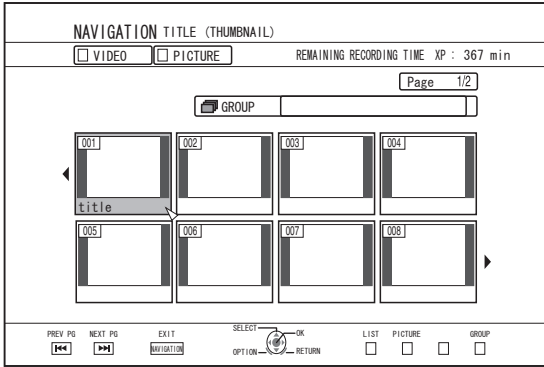

Press the [RED] button to display the title list screen.

- When the title list screen is displayed

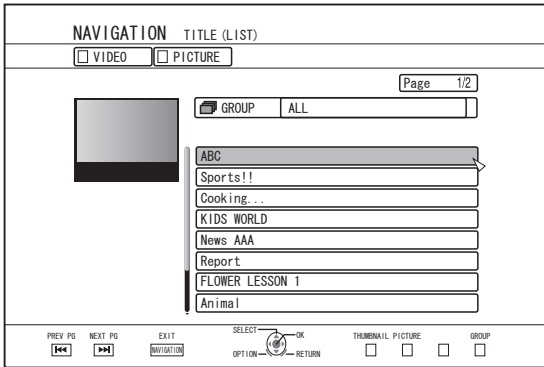

Press the [RED] button to display the video thumbnail list screen.

Displaying a group/folder

A group/folder screen can be displayed.

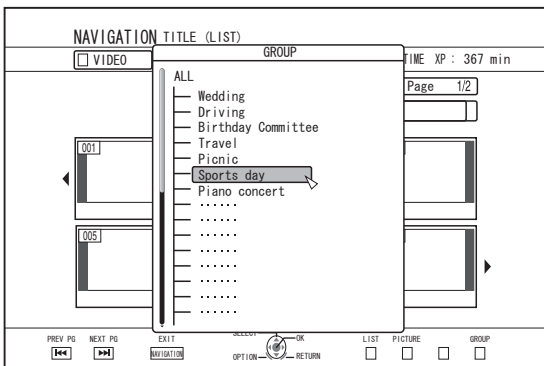

Press the [YELLOW] button to display the group/folder screen.

Switching between video and still image displays

You can switch the display between the video thumbnail list screen and still image thumbnail screen.

- When the video thumbnail list screen is displayed

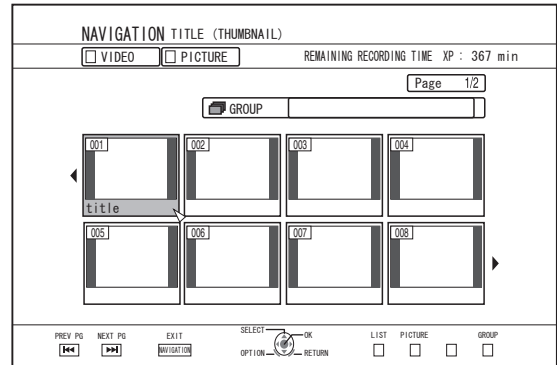

Press the [GREEN] button to display the still image thumbnail list screen.

- When the still image thumbnail list screen is displayed

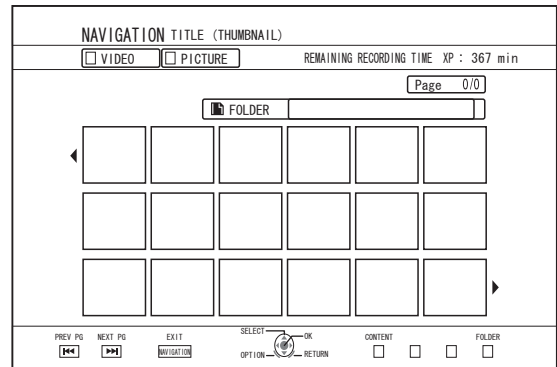

Press the [RED] button to display the video thumbnail list screen.

Displaying the Option menu

Displaying the Option menu enables you to perform different operations on a selected title/group, including "BACK", "PLAY", "DELETE", "DUB", "GROUP", "UNGROUP", "DO NOT GROUP", "MODE CHANGE", "EDIT", "EDIT INFO" and "OTHERS".

1 Select a title/group, and press the [OPTION] button

- An Option menu appears.

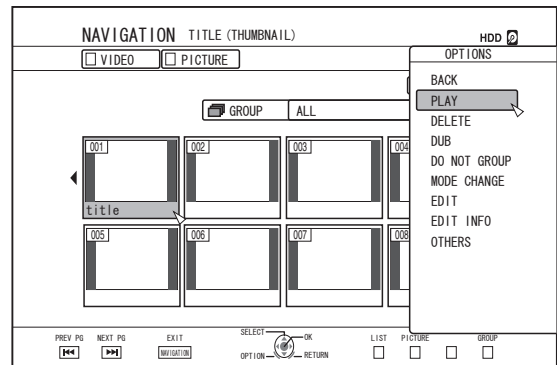

2 Select an operation option, and press the [OK] button

- Options that cannot be operated are displayed in gray and cannot be selected.

For details on the Option menu items, refer to “Option menu list” (☞ page 57) .

Option menu list

- BACK**
Returns to the previous screen.
- PLAY**
Plays back the selected title/group.
For details on the button operations during playback, refer to “Video Playback Operation” (☞ page 58) .
- DELETE**
Deletes a selected title/group.
For details, refer to “Deleting a Title/Group” (☞ page 70) .
- DUB**
Performs dubbing of a selected title/group.
For details, refer to “Dubbing/Importing” (☞ page 26) .
- GROUP**
Groups the selected titles/groups.
For details, refer to “Grouping” (☞ page 68) .
- UNGROUP**
Ungroups a selected group.
For details, refer to “Ungrouping” (☞ page 68) .
- DO NOT GROUP**
Removes the selected titles from a group.
For details, refer to “Excluding from a group” (☞ page 69) .
- MODE CHANGE**
Changes the mode of the selected title/group.
For details, refer to “Mode conversion” (☞ page 81) .
- CHAPTER LIST**
Displays the chapters of a selected title.
- EDIT**
Switches to the menu screen of the sub-items.
 - CHAPTER EDIT**
Switches to the chapter edit screen of the selected title.
For details, refer to “Editing a Chapter” (☞ page 75) .
 - PLAYLIST EDIT**
Switches to the playlist edit screen of the selected title.
For details, refer to “Creating a Playlist” (☞ page 73) .
 - DELETE SCENE**
Switches to the delete scene screen of the selected title.
For details, refer to “Delete Scenes” (☞ page 78) .
 - DIVIDE**
Switches to the dividing screen of the selected title.
For details, refer to “Dividing” (☞ page 77) .

- EDIT INFO**
Switches to the menu screen of the sub-items.
 - MODIFY TITLE NAME/MODIFY GROUP NAME**
Switches to the rename screen for the selected title/group name.
For details, refer to “Changing the Title/Group Name” (☞ page 70) .
 - MODIFY THUMBNAIL**
Switches to the thumbnail modification screen of the selected title.
For details, refer to “Editing a Thumbnail” (☞ page 74) .
 - CHANGE SHOOTING DATE/TIME**
Switches to the recording date modification screen of the selected title.
For details, refer to “Changing the Shooting Date/Time” (☞ page 80) .
 - PROTECT**
Switches to the protection screen of the selected title/group.
For details, refer to “Turning On Title/Group Protection” (☞ page 71) .
 - UNPROTECT**
Switches to the screen for turning off protection of the selected title/group.
For details, refer to “Turning Off Title/Group Protection” (☞ page 72) .
- OTHERS**
Switches to the menu screen of the other-items.
 - CHAPTER LIST
 - DETAILS
 - THUMBNAIL
 - LIST
 - VIDEO
 - PICTURE
 - GROUP
 - FOLDER SELECT
 - CONTENT

Video Playback Operation

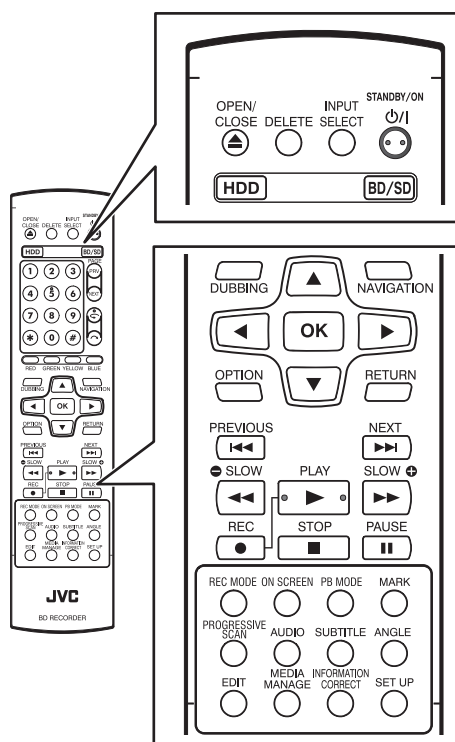

Frequently used button operations

■ [▶] button

- If the stop position (resume point) is memorized in the selected video, pressing the button plays back the video from this position. The video may not resume playback depending on the media and settings used. For details, refer to “RESUME” (page 85).
- If playback is paused (Still mode), pressing the button resumes playback.

■ [■] button

- Pressing the button stops playback after memorizing the stop position (resume point).
- Pressing the button again after playback stops clears the memory of the stop position (resume point).

■ [||] button

- Pressing the button stops playback temporarily.

■ [▶▶] button

- Pressing the button once during playback switches to a playback speed of 1.3 times (with audio sound).
- Pressing the button in the 1.3x playback or fast forward mode fast forwards the video. Pressing the button each time switches the search speed. (5x⇒10x⇒30x⇒60x)

Memo:

- The listed speed for searching and slow motion is an approximate amount.

- Pressing the button in the Still mode forwards the video frame by frame.

- Pressing and holding down the button in the Still mode starts playback in slow motion. Pressing the button during playback in slow motion switches the playback speed. The speed changes each time the button is pressed. (1/24x⇒1/16x⇒1/8x⇒1/2x)

■ [◀◀] button

- During normal playback, 1.3x playback, fast forward, or fast reverse, pressing the button fast reverses playback. Pressing the button each time switches the search speed. (1x⇒5x⇒10x⇒30x)
- Pressing the button in the Still mode reverses the video frame by frame.
- Pressing and holding down the button in the Still mode starts reverse playback of the video in slow motion. Pressing the button during playback in slow motion switches the playback speed. The speed changes each time the button is pressed. (1/24x⇒1/16x⇒1/8x⇒1/2x)

Memo:

- The listed speed for searching and slow motion is an approximate amount.

■ [▶▶] / [◀◀] button

- Pressing any of the buttons moves the chapter position.

■ [MARK] button

- Pressing the button enables you to add a chapter mark to a title.

■ [] button

- During normal playback, 1.3x playback, slow motion playback, fast forward, or fast reverse, pressing the button moves the playback position forward by about 30 seconds. Pressing the button multiple times moves playback to the position equivalent to the number of times pressed multiplied by 30 seconds.
- Normal playback will resume after the position has been moved. If pressed during 1.3x playback, 1.3x playback will continue after the position has been moved. Contents may be played back in the normal mode depending on the type of disc or content.
- Pressing the button in the Still mode moves the current paused position forward by about 30 seconds while maintaining the Still mode.

■ [] button

- During normal playback, 1.3x playback, slow motion playback, fast forward, or fast reverse, pressing the button moves the playback position back by about seven seconds. Pressing the button multiple times moves playback to the position equivalent to the number of times pressed multiplied by seven seconds.
- Normal playback will resume after the position has been moved. If pressed during 1.3x playback, 1.3x playback will continue after the position has been moved. Contents may be played back in the normal mode depending on the type of disc or content.
- Pressing the button in the Still mode moves the current paused position back by about seven seconds while maintaining the Still mode.

■ [HDD] button

- During playback of videos on a “BD/DVD” or “SD”, pressing the button stops the current playback and switches to the “HDD” mode.
Pressing the button during display of the Playback Navigation screen switches to the Playback Navigation screen for the “HDD” mode.

■ [BD/SD] button

- During playback of videos on a “BD/DVD” or “SD”, pressing the button stops the current playback and switches from “BD/DVD” to “SD” or vice versa.
Pressing the button during display of the Playback Navigation screen switches to the Playback Navigation screen for the other media. During playback of videos on the “HDD”, pressing the button stops the current playback and switches to “BD/DVD” mode.

Memo: _____

- The display switches automatically to the SD mode only if the inserted SD card contains playable videos or still images.

Useful button operations

■ [PB MODE] button

- Displays the Playback Settings screen, which enables you to modify the settings.
For details, refer to “Changing Playback Settings”.

■ [AUDIO] button

- Switches the audio channel.

■ [SUB TITLE] button

- Switches the subtitle display.

■ [ANGLE] button

- Switches the angle.

Memo: _____

- Pressing the [AUDIO], [SUB TITLE], or [ANGLE] button has no effect if their selection is not available in the playback video.

Playing Videos on a BD/DVD

Playback starts automatically after a BD/DVD is set. If the Auto Play feature is disabled, play the title using Playback Navigation.

Memo:

- For details on the button operations during playback, refer to “Video Playback Operation” (page 58).

Playing a disc when Auto Play is enabled

1 Set a BD or DVD on the disc tray

- Auto Play starts.

Playing a disc when Auto Play is disabled

1 Set a BD or DVD on the disc tray

2 Press the [NAVIGATION] button

- The Playback Navigation screen appears.

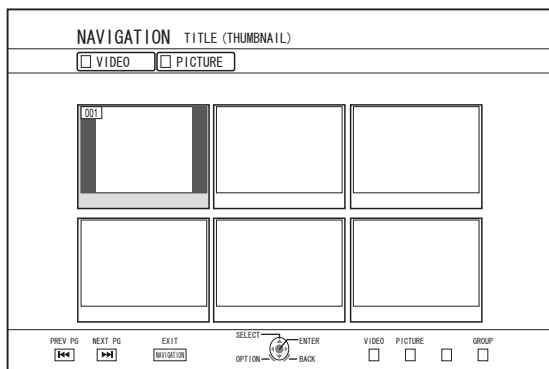

3 Select a title, and press the [OK] button

- Playback of the selected title starts.

Memo:

- If the current playback location is “HDD” or “SD”, press the [BD/SD] button on the remote control unit to switch it to “BD/DVD”.
- Videos can also be played back without starting up Playback Navigation. Pressing the [▶] button starts playback from the stop position (resume point) of the disc. If the stop position (resume point) is not memorized or if the setting for “RESUME” has been set to “OFF”, playback starts from the beginning of the disc.

Playing an EverioBackup Disc*

EverioBackup : Data disc containing high-definition videos that are recorded in the MPEG2 format using a DVD writer for Everio.

1 Set the disc on the disc tray

2 Press the [NAVIGATION] button

- The Playback Navigation screen appears.

3 Select a title, and press the [OK] button

- Playback of the selected title starts.

Memo:

- If the current playback location is “HDD” or “SD”, press the [BD/SD] button on the remote control unit to switch it to “BD/DVD”.
- Videos can also be played back without starting up Playback Navigation. Pressing the [▶] button plays back titles starting from that with the oldest recording date.

Playing Video Discs Created Using a PC

Videos that are created using a PC can be played back using Playback Navigation.

1 Set the disc on the disc tray

2 Press the [NAVIGATION] button

- The Playback Navigation screen appears.

3 Select a title, and press the [OK] button

- Playback of the selected title starts.

Memo:

- The formats that can be played back are BDAV, BDMV, DVD-Video and DVD-VR (CPRM-compatible).
- If the current playback location is “HDD” or “SD”, press the [BD/SD] button on the remote control unit to switch it to “BD/DVD”.
- Videos can also be played back without starting up Playback Navigation. Pressing the [▶] button starts playback from the stop position (resume point) of the disc. If the stop position (resume point) is not memorized or if the setting for “RESUME” has been set to “OFF”, playback starts from the beginning of the disc.
- Playback may not be possible due to compatibility problems.

Playing Videos on the HDD

Titles stored on the HDD can be played back using Playback Navigation.

You can select a video to play from “Title”, “Group”, or “Playlist”.

Memo:

- For details on the button operations during playback, refer to “Video Playback Operation” (page 58).

Playing titles stored on the HDD

1 Press the [NAVIGATION] button

- The Playback Navigation screen appears.

2 Select the titles to playback, and press the [▶] button

- Playback of the selected title starts.

Memo:

- If the current playback location is “BD/DVD” or “SD CARD”, press the [HDD] button on the remote control unit to switch it to “HDD”.
- To play back specific titles within a group, select the group, press the [OK] button, and select the titles accordingly.
- Videos can also be played back without starting up Playback Navigation.
Pressing the [▶] button starts playback of the most recently played title.
If there are no recently played titles, playback starts from the title with the most recent recording date.

Playing Videos on a SD Card

Titles stored on an SD card can be played back using Playback Navigation.

You can select a video to play from “Title”.

1 Insert the SD card into the [SD SLOT]

- Switch the playback location to “SD CARD” after the SD card is detected by the unit.

2 Press the [NAVIGATION] button

- The Playback Navigation screen appears.

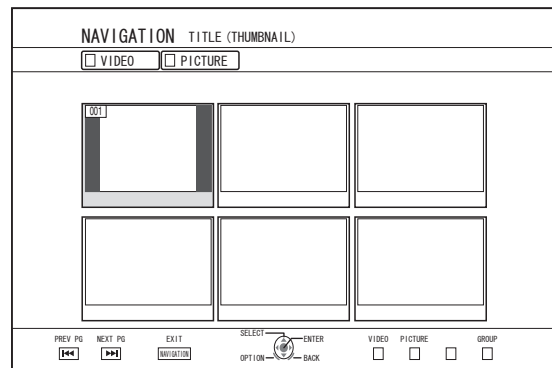

3 Select a title, and press the [OK] button

- Playback of the selected title starts.

Memo:

- Playback navigation displays AVCHD files stored on the SD card in titles, not in scenes (chapters). Titles are grouped such as according to the date, recording mode, or number of scenes. Make use of thumbnail display to display titles. List display is not supported.
- The formats that can be played back are AVCHD and SD-VIDEO. If AVCHD files are displayed in thumbnails, black bars may appear on the left and right borders depending on the video resolution.
- When there are files of different formats (AVCHD, SD-VIDEO, MOV*/MXF*) in the SD card, press the [RED] button to select the format you want to display.
 MOV* : MOV format files recorded in the SP mode and HQ mode using the JVC ProHD MEMORY CARD CAMERA RECORDER GY-HM series
 MXF* : MXF format files recorded in the SP mode and HQ mode using JVC ProHD MEMORY CARD CAMERA RECORDER GY-HM650
- Videos can also be played back without starting up Playback Navigation.
Pressing the [▶] button starts playback from the stop position (resume point).
If the stop position (resume point) is not memorized, playback starts from the beginning of the playable content.
If the setting for “QUICK STARTUP” is set to “OFF”, the resume point will not be memorized when the power is turned OFF.

For details on the button operations during playback, refer to “Video Playback Operation” (page 58).

Playing Still Images (JPEG)

Still images stored on the HDD/BD/DVD/SD card can be played back using Playback Navigation.

Playing still images

1 Select the playback location

- HDD : If the current playback location is “BD/DVD” or “SD CARD”, press the [HDD] button on the remote control unit to switch it to “HDD”.
- BD/DVD : If the current playback location is “HDD” or “SD CARD”, press the [BD/SD] button on the remote control unit to switch it to “BD/DVD”.
- SD : If the current playback location is “HDD” or “BD/DVD”, press the [BD/SD] button on the remote control unit to switch it to “SD CARD”.

2 Set the media

- To play a media other than “HDD”, set the media on which the still images are stored.

BD/DVD : Set a BD or DVD on the disc tray

SD : Insert the SD card into the [SD SLOT]

3 Select the still images to play, and press the [▶] button

- Images selected are played back in a slideshow.

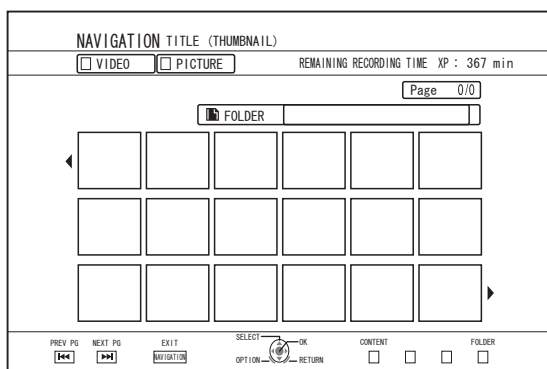

Memo:

- The slide show plays back images according to the date of the files.
- If folders exist, files inside the selected folder will be played.
- You can specify the “REPEAT”, “SLIDESHOW INTERVAL” and “SLIDESHOW EFFECTS” settings in the Playback Settings menu.
For details, refer to the “REPEAT” (page 63), “SLIDESHOW INTERVAL” (page 63), and “SLIDESHOW EFFECTS” (page 63) items under “Playback Settings”.

Enabled button operations during still image playback

■ [▶] button

- Pressing the button when a title/group is selected starts playback of the still images in the title/group in a slideshow.

■ [■] button

- Pressing the button stops the slideshow and displays the Playback Navigation screen.

■ [||] button

- Pressing the button stops the slideshow temporarily.

■ [◀◀] / [▶▶] button

- Pressing the button displays the previous or next still image.

■ [⏻/⏿] button

- Pressing the button ends playback of the still images and turns the power of the unit to “Off”.

Memo:

- The display of still images can be zoomed in/out or rotated using the following buttons when the slideshow is paused.
 - [↶]/[BLUE] button
Rotates the still image by 90° in the anti-clockwise direction.
 - [↷]/[YELLOW] button
Rotates the still image by 90° in the clockwise direction.
 - [OK]/[RED] button
Enlarges the still image.
 - [RETURN]/[GREEN] button
Reduces the enlarged still image.
 - [▲ / ▼ / ◀ / ▶] button
Moves the display position of the enlarged still image toward the direction indicated by the button.
- This unit does not have a still image edit feature. Still images cannot be saved when they are zoomed in or rotated.
- Priority of display is given to the media (“BD/DVD” or “SD CARD”) that contains playable still images. If both “BD/DVD” and “SD CARD” contain playable videos, priority of display will be given to the most recently used media.

Changing Playback Settings

Displaying the playback settings menu

- 1 Press the [PB MODE] button on the remote control unit during the playback of a title
- The Settings Menu screen appears.
 - The playback settings menu can only be displayed during the playback of a title.
 - Only settings that are supported by the current title being played back can be changed in the playback settings menu.
Items displayed in gray cannot be set.

Playback Settings Menu

Audio/subtitle settings

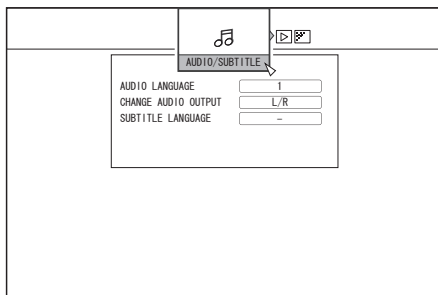

Memo:

- "AUDIO/SUBTITLE" will be displayed only if they are available in the video content. The setting value differs depending on the content. Items that are not available in the content cannot be set.

- **AUDIO LANGUAGE**
- **CHANGE AUDIO OUTPUT**
- **SIGNAL TYPE (BD-ROM)**
 - PRIMARY VIDEO
 - PRIMARY AUDIO
 - SECONDARY VIDEO
 - CHANGE SECONDARY VIDEO
 - SECONDARY AUDIO
 - SECONDARY AUDIO LANGUAGE
- **SUBTITLE LANGUAGE**
- **SUBTITLE STYLE**
- **CHANGE ANGLE**

Playback settings

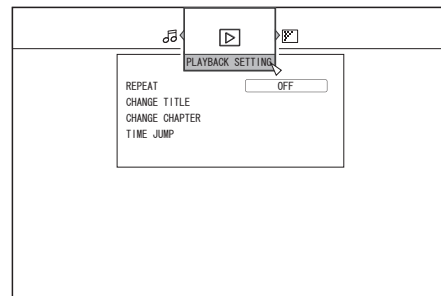

■ REPEAT

The following items can be set.
Items are not displayed if they cannot be set.

| Setting Values | Description |
|----------------|---|
| OFF | Turns off repeat. |
| TITLE | Repeats playback of the currently played title. |
| CHAPTER | Repeats playback of the currently played chapter. |
| TRACK | Repeats playback of the currently played track. |
| FOLDER | Repeats playback within the currently played folder. |
| ALL | Repeats playback of the entire disc. |
| A-B | Repeats playback of the section between the specified starting and ending points. Pressing the [OK] button specifies the displayed scene as the starting point (Point A). Pressing the [OK] button after forwarding playback specifies the displayed scene as the ending point (Point B). |

■ CHANGE TITLE

You can change to a different title by entering the corresponding numeric value. Any value that is larger than the number of titles cannot be entered.

■ CHANGE CHAPTER

You can change to a different chapter by entering the corresponding numeric value. Any value that is larger than the number of chapters cannot be entered.

■ TIME JUMP

You can move to a specific playback position by entering a time. This is not possible if the specified time is not valid.

■ SLIDESHOW INTERVAL

The following items can be set.
3SEC/5SEC/10SEC/20SEC/30SEC modes

■ SLIDESHOW EFFECTS

The following items can be set.

| Setting Values | Description |
|----------------|--|
| OFF | Turns off slideshow effect. |
| ON | Turns on slideshow effect. "Fade out" and "Fade in" effects can be applied when switching from one slide to another. |

Playback Settings Menu (Continued)

Video settings

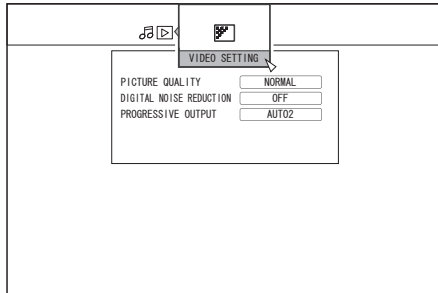

■ PICTURE QUALITY

The following items can be set.

| Setting Values | Description |
|----------------|--|
| NORMAL | Standard picture quality. |
| CINEMA | Effective when playing movies. |
| FINE | Produces sharp images with enhanced outlines. |
| SOFT | Reduces noise that is prominent in the video image. |
| USER SETTING | Enables the Details setting. For details, refer to "DETAIL SETTING". |

■ DETAIL SETTING

The following items can be set.

Choose an option and press [OK] to set the respective values.

| Setting Values | Description |
|----------------|---|
| CONTRAST | A value between "-7" and "+7" can be set. |
| BRIGHTNESS | A value between "0" and "15" can be set. |
| SHARPNESS | A value between "-6" and "+6" can be set. |
| COLOR | A value between "-7" and "+7" can be set. |
| GAMMA | A value between "0" and "5" can be set. |

■ DIGITAL NOISE REDUCTION

The following items can be set.

| Setting Values | Description |
|----------------|--|
| OFF | Turns off DNR (Digital Noise Reduction). |
| ON | Reduces noise that is prominent in images of lengthy videos. |

■ PROGRESSIVE OUTPUT

The following items can be set.

| Setting Values | Description |
|----------------|--|
| AUTO1 | Displays video images after they are converted according to the film material. |
| AUTO2 | In addition to the "AUTO1" option, support is also provided for progressive videos recorded at 30 frames per second. |
| VIDEO | Most suitable for video images (TV broadcast, etc.). Select this option when playing videos with significant movements or animated videos. |

Editing

Before editing

This unit mainly edits video images stored on the HDD. To edit video images stored in a disc or SD card, do so after importing them to the HDD.

Data on a finalized disc cannot be edited. To edit a finalized disc, you have to either unfinalize the disc, or do so after importing the data to the HDD.

Memo:

- Only discs that are finalized using this unit can be unfinalized.

Editable items for different media

Items that are editable vary according to the type of media on which the video data is stored. For details, refer to the media chart below.

Media chart

| Editing option | HDD | BD-R/BD-RE (BDAV) | BD-R/BD-RE (BDMV) | DVD-RW/DVD-R | SD | HDD/BD-RE/SD picture |
|------------------------------------|-----|-------------------|-------------------|--------------|----|----------------------|
| Grouping | ✓ | - | - | - | - | - |
| Changing the Title/Group Name | ✓ | ✓ | - | ✓ | - | - |
| Deleting a Title/Group | ✓ | ✓ | *3 | ✓ | - | ✓ |
| Turning On Title/Group Protection | ✓ | ✓ | - | *1 | - | ✓ |
| Turning Off Title/Group Protection | ✓ | ✓ | - | *1 | - | - |
| Creating a Playlist | ✓ | - | - | - | - | - |
| Editing a Thumbnail | ✓ | ✓ | - | ✓ | - | - |
| Editing a Chapter | ✓ | *2 | - | *1, *2 | - | - |
| Dividing | ✓ | - | - | - | - | - |
| Delete Scene | ✓ | - | - | - | - | - |
| Changing the Disc Name | - | ✓ | - | ✓ | - | - |
| Changing the Shooting Date/Time | ✓ | - | - | - | - | - |

Memo:

*1 : Supports only the "VR MODE".

*2 : Supports only dividing and combining of chapters.

*3 : For BDMV disc (BD-R/BD-RE) created during dubbing, the titles cannot be deleted.

For BDMV disc (BD-R) created during direct recording, the titles can be deleted before finalizing the disc. The titles cannot be deleted after finalization.

For BDMV disc (BD-RE) created during direct recording, the titles can be deleted. (☞ page 70)

Entering Characters

Names can be changed or given to stored videos or groups. You can enter characters while referring to the input on the monitor.

Character input screen

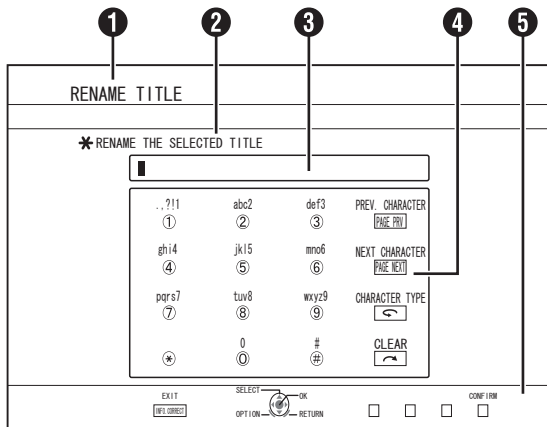

1 Function name field

2 Screen description

3 Input window

Characters entered appear on the input window.

4 Operation guide 1

The [0]-[9], [*], [#], [PAGE PRV], [PAGE NEXT], [↶] and [↷] buttons are displayed.

5 Operation guide 2

[▲ / ▼ / ◀ / ▶], [OK], [RETURN], [OPTION], [BLUE], [RED], [GREEN] and [YELLOW] buttons are displayed.

6 Character input keyboard

A character input keyboard appears during input of symbol. You can enter characters by selecting them accordingly from the keyboard.

Entering characters

1 Enter characters using the [0]-[9], [*] or [#] buttons

2 After character input is complete, press the [BLUE] button

Memo:

- Switch between alphanumeric and symbol input by pressing the [↶] button.
- For details on the correspondence between each button and the input characters, refer to the “Character List”.
- Press the [↷] button to delete an input character. Press and hold down the [↷] button to delete all input characters.
- Pressing the [RETURN] button calls up the confirmation screen to cancel character input. To cancel character input and return to the initial screen, select “YES” and press the [OK] button. To return to the character input screen, select “NO” and press the [OK] button.
- Up to about 20 alphanumeric characters can be displayed on the disc menu of BDMV and DVD-VIDEO. (The number of characters that can be displayed varies with the character.)

Note:

- If you switch the screen display before confirming the input characters, a message will appear on the screen. To cancel character input and return to the initial screen, select “STOP” and press the [OK] button. To return to the character input screen, select “BACK” and press the [OK] button.
- If the converted characters exceed the maximum number of input characters, a message will appear on the screen. Select “OK” and press the [OK] button to delete the excess characters and to input the remaining ones. Select “RETURN” and press the [OK] button to restore the unconfirmed characters.
- No more characters can be input if the maximum character limit has been reached.

Grouping

Multiple titles stored on the HDD can be combined into a group.

Memo:

- Only video data stored on the HDD can be grouped.

Grouping

1 Press the [NAVIGATION] button on the remote control unit

- The Playback Navigation screen appears.

2 Select the titles or groups to be grouped, and press the [MARK] button

- Pressing the [MARK] button adds a check mark to the selected titles/groups.
All titles and groups with the check mark will be grouped together.

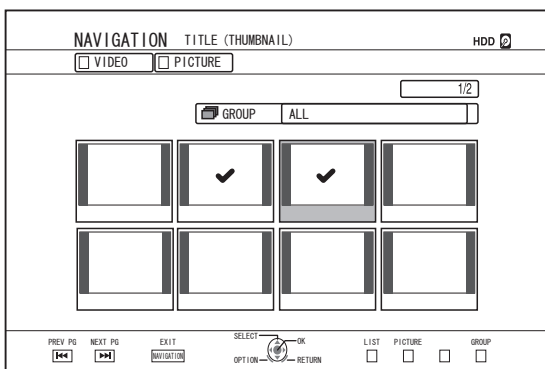

3 Press the [OPTION] button on the remote control unit

- A pop-up option list appears.

4 Select “GROUP”, and press the [OK] button

- A grouping confirmation screen appears.

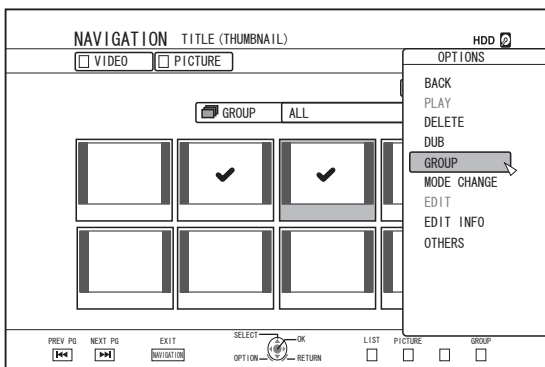

5 Select “GROUP”, and press the [OK] button

- The selected titles and groups are now grouped together.

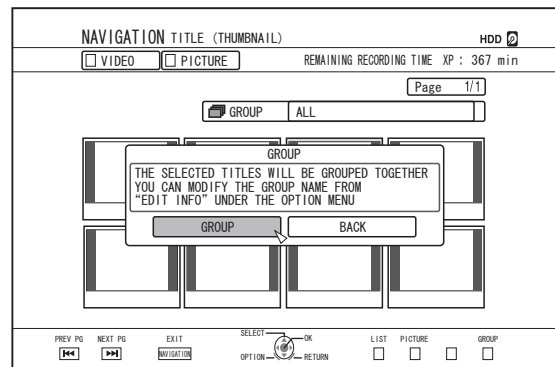

Memo:

- To cancel grouping, select “BACK” and press the [OK] button.
- Alternatively, you can press the [RETURN] button to cancel grouping and return to the initial screen.

Ungrouping

1 Press the [NAVIGATION] button on the remote control unit

- The Playback Navigation screen appears.

2 Select the group to ungroup, and press the [OPTION] button

- A pop-up option list appears.

3 Select “UNGROUP”, and press the [OK] button

- An ungroup confirmation screen appears.

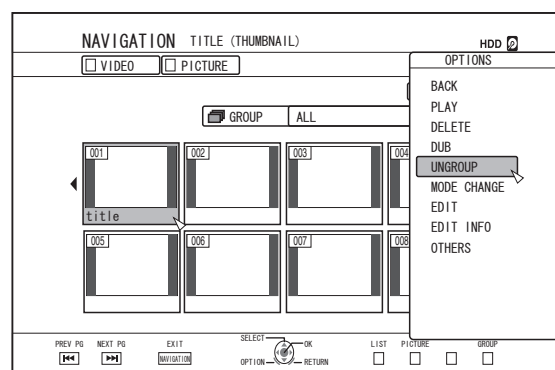

Memo:

- You cannot ungroup multiple groups at the same time. When multiple groups are selected, the “UNGROUP” item does not appear in the option list.

4 Select “YES”, and press the [OK] button

- All titles within the selected group are ungrouped.

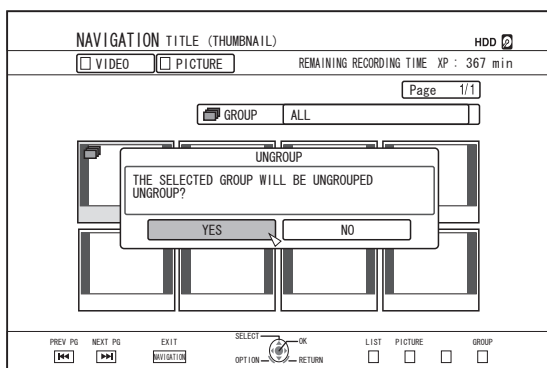

Memo:

- To cancel ungrouping, select “NO” and press the [OK] button.
- Alternatively, you can press the [RETURN] button to cancel ungrouping and return to the initial screen.

Excluding from a group

You can select titles and exclude them from a group.

1 Press the [NAVIGATION] button on the remote control unit

- The Playback Navigation screen appears.

2 Select the titles to exclude from the group, and press the [MARK] button

- Pressing the [MARK] button adds a check mark to the selected titles/groups. All titles with the check mark will be excluded from the group.

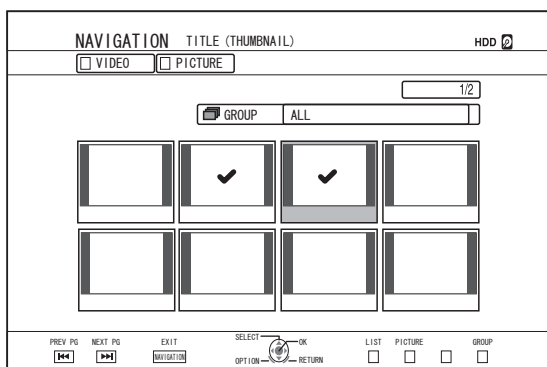

3 Press the [OPTION] button on the remote control unit

- A pop-up option list appears.

4 Select “DO NOT GROUP”, and press the [OK] button

- A confirmation screen for group exclusion appears.

5 Select “YES”, and press the [OK] button

- The selected titles are now excluded from the group.

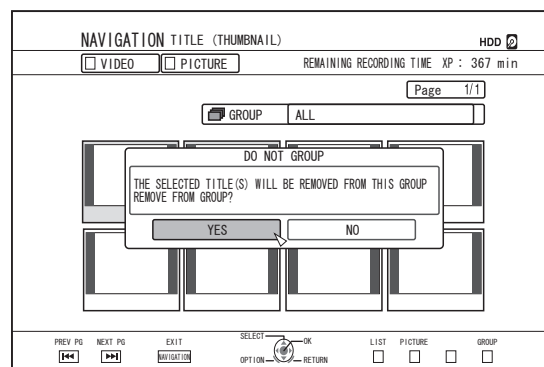

Memo:

- To cancel, select “NO” and press the [OK] button.
- Alternatively, you can press the [RETURN] button to cancel group exclusion and return to the initial screen.

Changing the Title/Group Name

The saved title/group name can be changed as follows.

Memo:

- A title/group name can be added to video data stored on the HDD, BD-RE, BD-R, DVD-RW, or DVD-R, and the name can be changed.
- For video data stored on a DVD-RW or DVD-R in the Video mode, the title/group name cannot be changed. However, you can change the name if the disc has not been finalized.

1 Press the [NAVIGATION] button on the remote control unit

- The Playback Navigation screen appears.

2 Select the title/group for which the name is to be changed, and press the [OPTION] button

- A pop-up option list appears.

3 Select “EDIT INFO”, and press the [OK] button

- An information editing screen appears.

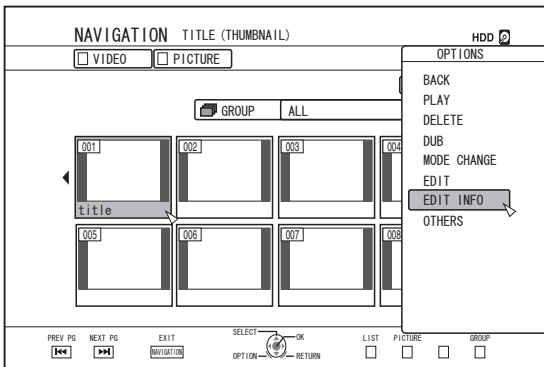

4 Select “MODIFY TITLE NAME” or “MODIFY GROUP NAME”, and press the [OK] button

- A title/group name modifying screen appears.

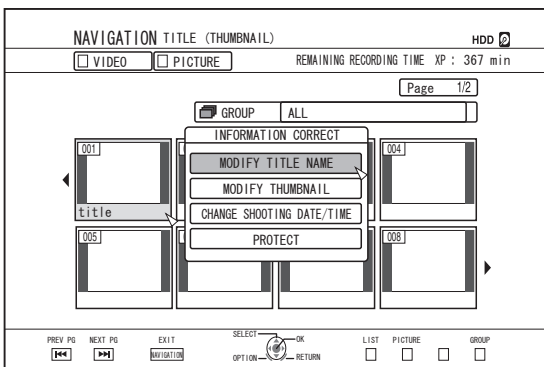

5 Modify the title/group name

- The modified title/group name is now saved.

Memo:

- For details on the method of character input, refer to “Entering Characters” (page 66).

Deleting a Title/Group

Titles/groups can be deleted. When you delete a group, all titles contained within the group are deleted.

Memo:

- When a title/group is deleted from the HDD, BD-RE, or DVD-RW, the remaining space on the media increases according to the size of the deleted title/group. Deleting a title/group from a BD-R or DVD-R does not increase the amount of available space on the disc.

1 Press the [NAVIGATION] button on the remote control unit

- The Playback Navigation screen appears.

2 Select the titles/groups to delete, and press the [OPTION] button

- To delete the entire group, select the thumbnails with the group icon indication.
- Pressing the button displays a pop-up option list.

3 Select “DELETE”, and press the [OK] button

- A confirmation screen for title/group deletion appears.

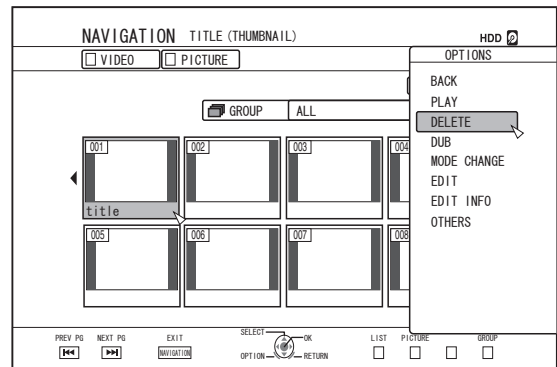

4 Select “DELETE”, and press the [OK] button

- The selected titles/groups are deleted.

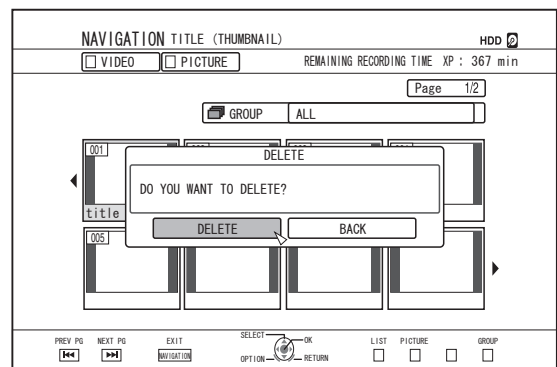

Memo:

- To cancel the title/group deletion operation, select “BACK” and press the [OK] button.
- Alternatively, you can press the [RETURN] button to cancel the deletion operation and return to the initial screen.
- Titles recorded directly to a BDMV disc can be deleted by pressing the [DELETE] button on the remote control when the title is currently being played. During playback of a title, you can also delete it by pressing the [OPTION] button and selecting “DELETE”.

Turning On Title/Group Protection

Titles/groups can be protected.

Editing and deletion cannot be performed on protected titles/groups.

- Title/group protection can be turned on for video data stored on the HDD, BD-RE (BD-RE), BD-R (BD-RE), and DVD-RW (VR).

1 Press the [NAVIGATION] button on the remote control unit

- The Playback Navigation screen appears.

2 Select the titles/groups to be protected, and press the [OPTION] button

- A pop-up option list appears.

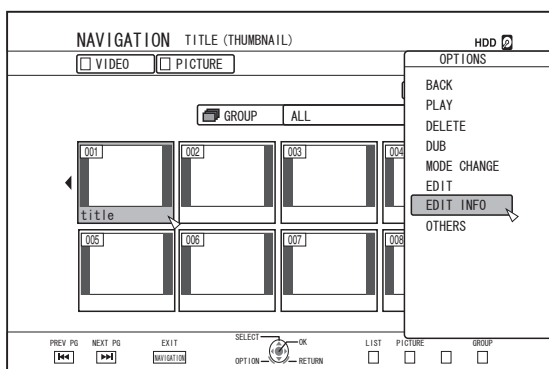

3 Select "EDIT INFO", and press the [OK] button

- An information editing screen appears.

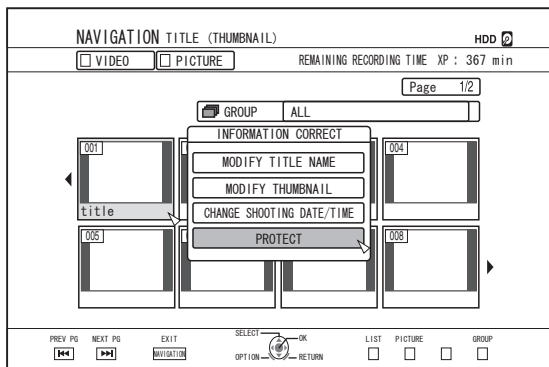

4 Select "PROTECT", and press the [OK] button

- If only a single title was selected in step 2, a confirmation screen for title protection will appear.

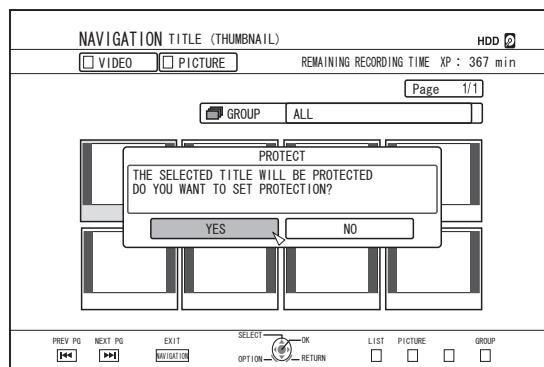

- If multiple titles or groups were selected in step 2, "PROTECT" and "UNPROTECT" items will be displayed.

5 Select "YES", and press the [OK] button

- The selected titles/groups are now protected.

Memo:

- All selected titles and groups will be protected when multiple titles or groups are selected.
- To turn off the title/group protection, select "NO" and press the [OK] button.
- Alternatively, you can press the [RETURN] button to turn off the protection and return to the initial screen.

Turning Off Title/Group Protection

Protection of a title/group can be turned off. Titles/groups can be edited and deleted after their protection is turned off.

- Title/group protection can be turned off for video data stored on the HDD, BD-RE (BD-RE), BD-R (BD-RE), and DVD-RW (VR).

1 Press the [NAVIGATION] button on the remote control unit

- The Playback Navigation screen appears.

2 Select the titles/groups to turn off protection for, and press the [OPTION] button

- A pop-up option list appears.

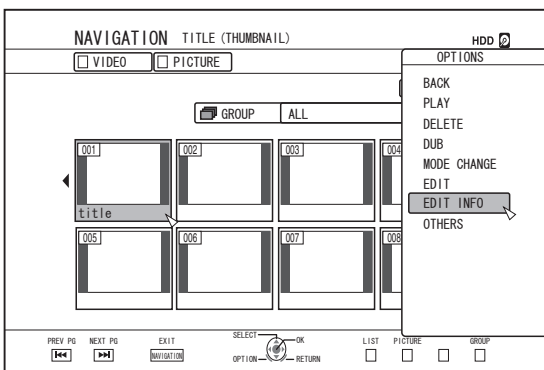

3 Select "EDIT INFO", and press the [OK] button

- An information editing screen appears.

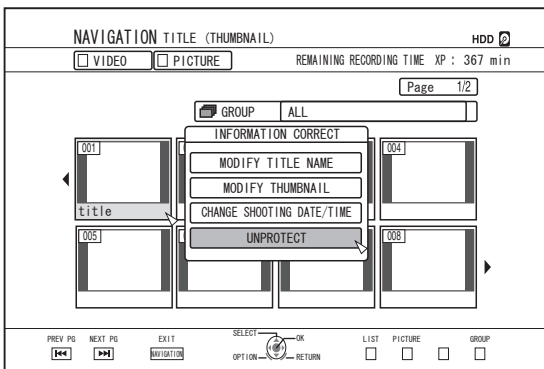

4 Select "UNPROTECT", and press the [OK] button

- If only a single title was selected in step 2, a confirmation screen for turning off protection will appear.

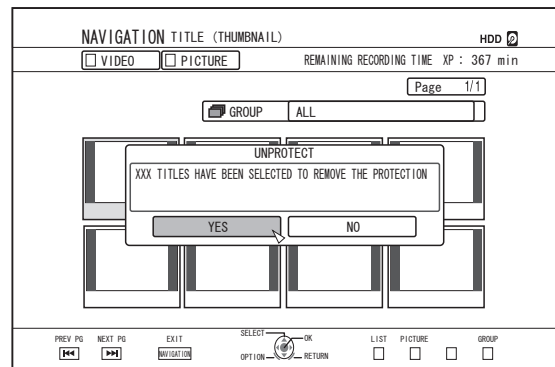

- If multiple titles or groups were selected in step 2, "UNPROTECT" and "PROTECT" items will be displayed.

5 Select "YES", and press the [OK] button

- Protection of the selected titles/groups is now turned off.

Memo:

- Protection will be turned off from all selected titles and groups when multiple titles or groups are selected.
- If you do not want to turn off the title/group protection, select "NO" and press the [OK] button.
- Alternatively, you can press the [RETURN] button to cancel protection removal and return to the initial screen.

Creating a Playlist

A playlist can be created from the video titles on the HDD.

- Playlists can only be created for titles that are stored on the HDD.

Playlist : Enables you to create a program by selecting chapters from a specific title and editing their playback sequence.

Memo:

- The playlist created comes in handy during playback and dubbing to a disc.

Creating a Playlist

1 Press the [NAVIGATION] button on the remote control unit

- The Playback Navigation screen appears.

2 Select the title for which a playlist is to be created, and press the [OPTION] button

3 Select “EDIT”, and press the [OK] button

- The Edit menu screen appears.

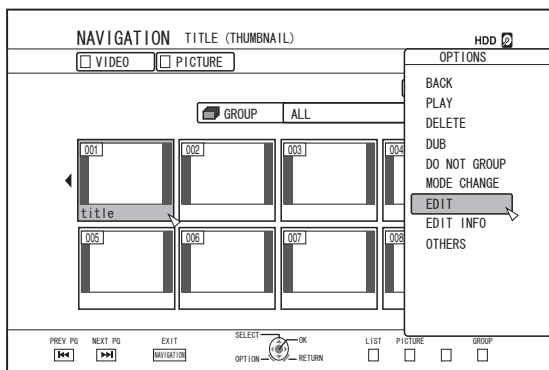

4 Select “PLAYLIST EDIT”, and press the [OK] button

- The playlist edit screen appears.

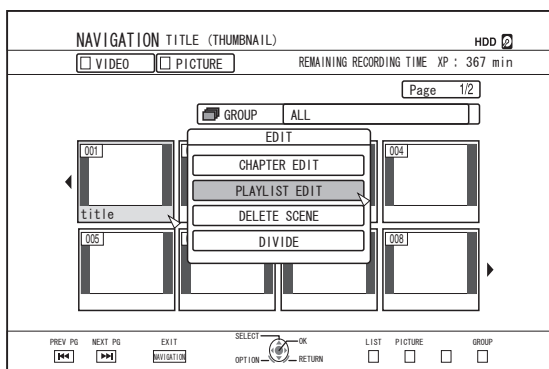

5 Edit the playlist accordingly by selecting chapters from the source title according to your preference

- Edit the playlist.

For details, refer to “Editing the playlist”.

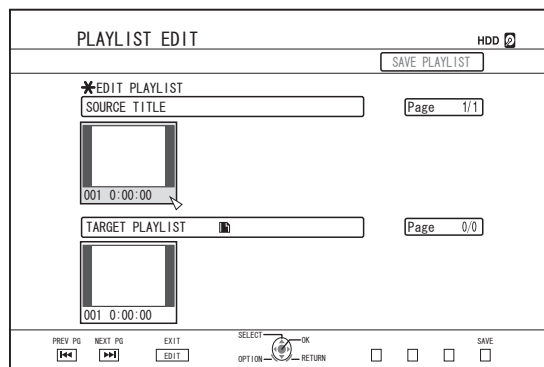

6 Press the [BLUE] button on the remote control unit

- A playlist is created.

Editing the playlist

■ **Chapter insertion**

- ① Select the chapter to insert from the thumbnails of the “SOURCE TITLE”, and press the [OK] button
- ② Select the position to insert the chapter from the “TARGET PLAYLIST”, and press the [OK] button

■ **Chapter deletion**

- ① Select the chapter to delete from the thumbnails of the “TARGET PLAYLIST”, and press the [OK] button
- ② Select “DELETE”, and press the [OK] button

■ **Entering the playlist name**

- ① Select “TARGET PLAYLIST”, and press the [OK] button.
- ② Enter a playlist name, and press the [OK] button

Memo:

- For details on the method of character input, refer to “Entering Characters” (page 66) .

Note:

- Deleting the original title list will cause the playlist to be deleted as well. Editing the original title list, or changing the recording mode may cause the playlist to be deleted.

Editing a Thumbnail

Thumbnails (index images) can be changed to a still image according to your preference.

Memo:

- Thumbnails of titles stored on the HDD, BD-RE, BD-R, DVD-RW, and DVD-R can be edited.
- However, thumbnails of titles that are stored on an SD card or finalized disc cannot be edited.

1 Press the [INFORMATION CORRECT] button on the remote control unit

- An information editing screen appears.

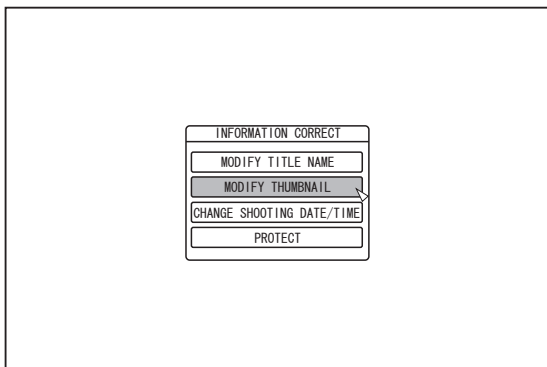

2 Select “MODIFY THUMBNAIL”, and press the [OK] button

- A thumbnail modification screen appears.

3 Play the video, and press the [III] button to stop at the scene you want to use as thumbnail display

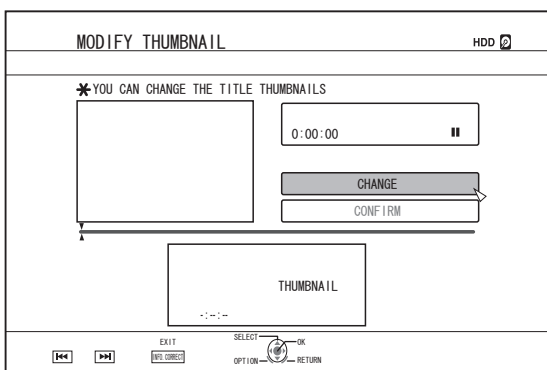

Memo:

- For details on the button operations during playback, refer to “Video Playback Operation” (page 58).

4 Select “CHANGE”, and press the [OK] button

- The displayed still image now becomes the thumbnail image.

5 Select “CONFIRM”, and press the [OK] button

- Doing so ends the editing of thumbnails.

Memo:

- You can also display the thumbnail modification screen from the Playback Navigation screen.

- ① Select the title for which the thumbnail is to be changed, and press the [OPTION] button
 - ② Select “EDIT INFO”, and press the [OK] button
- An information editing screen appears.

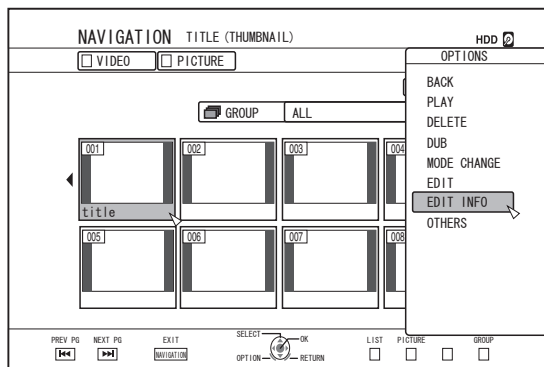

③ Select “MODIFY THUMBNAIL”, and press the [OK] button

- A thumbnail modification screen appears.

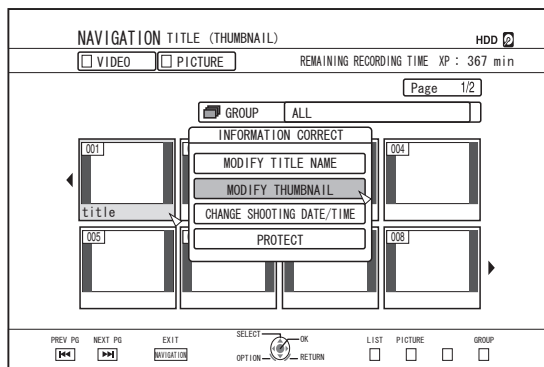

Editing a Chapter

Creating a chapter mark for a saved title enables you to find a specific scene within the title.

Memo:

- All chapter editing functions can be performed on titles stored on the HDD.
Titles stored on a BD-RE (BD-RE), BD-R (BD-R), DVD-R (VR), or DVD-RW (VR) only allow chapters to be divided or combined.
- The chapters of titles that are stored on an SD card or finalized disc cannot be edited.
- Also, protected titles cannot be edited. To perform chapter edit of a title, turn off the protection.

For details on turning off the title protection, refer to “Turning Off Title/Group Protection” (page 72).

Chapter edit functions

- Chapter mark insertion (divide chapter)
Divides a chapter by inserting a chapter mark.
- Chapter mark deletion (combine chapters)
Combine chapters by deleting the chapter mark.
- Chapter deletion
Deletes a specified chapter.

Editing a chapter

- 1 Press the [EDIT] button on the remote control unit
 - The Edit menu screen appears.
- 2 Select “CHAPTER EDIT”, and press the [OK] button
 - The title screen appears.

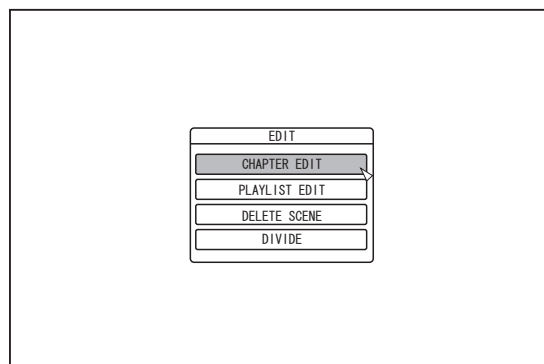

- 3 Select a title, and press the [OK] button

Memo:

- The chapter edit screen can also be called up from the Playback Navigation screen.
- ① Select the title to perform chapter edit, and press the [OPTION] button
- ② Select “EDIT”, and press the [OK] button

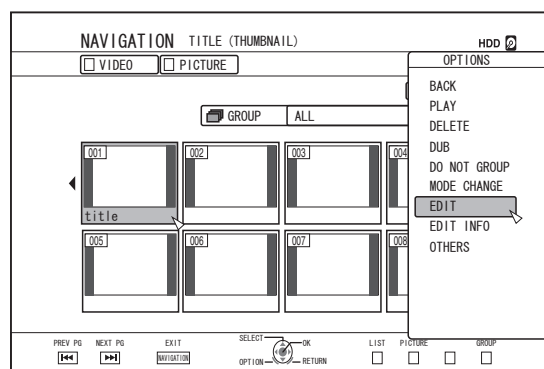

- ③ Select “CHAPTER EDIT”, and press the [OK] button

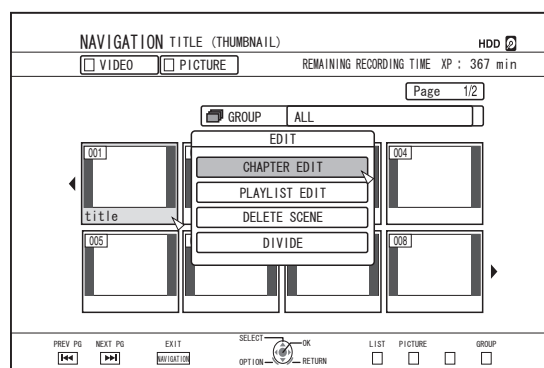

- For details on the button operations during playback, refer to “Video Playback Operation” (page 58).
- Frame movement on the Chapter Edit screen can only be performed one frame at a time regardless of the “STILL MODE” (page 85) setting.

Editing a Chapter (Continued)

Chapter mark insertion (divide chapter)

- 1 Play the video, and press the [III] button to stop at the scene you want to add a chapter mark
 - 2 Press the [MARK] button on the remote control unit
- A chapter mark is inserted into the paused scene.

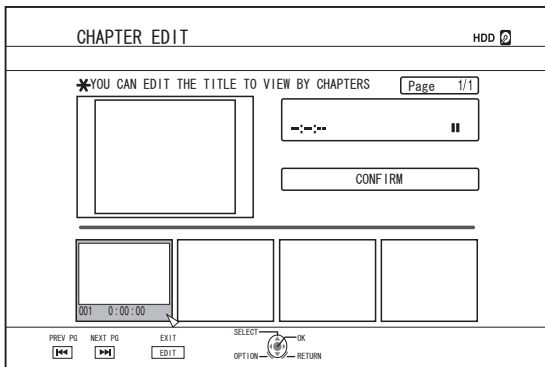

Memo:

- The chapter is now divided into two parts at the position of the chapter mark.

Chapter mark deletion (combine chapters)

- 1 Play the video, and press the [III] and [◀/▶] buttons to display the scene for which you want to delete the chapter mark
 - 2 Press the [MARK] button on the remote control unit
- A confirmation screen for deleting the chapter mark appears.

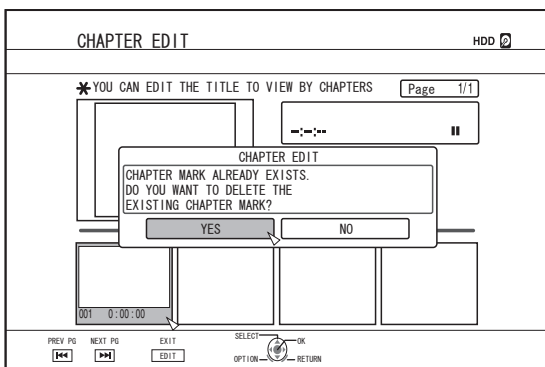

3 Select "YES", and press the [OK] button

- The chapter mark is deleted from the selected scene.

Memo:

- The chapters before and after the position of the chapter mark are now combined.
- Pressing the [▶▶|◀◀] button displays the next/previous page.

Deleting a video chapter

- 1 Select the chapter for which you want to delete the video from the chapter edit screen
 - 2 Press the [DELETE] button on the remote control unit
- A confirmation screen for deleting the chapter appears.

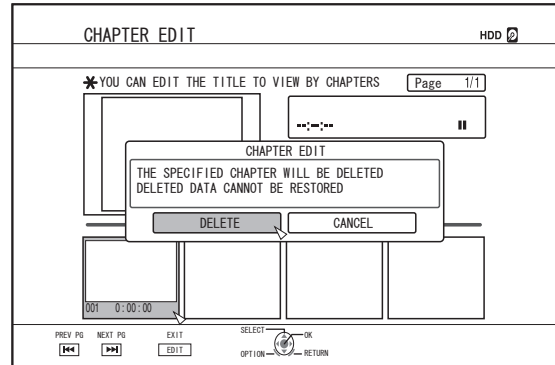

3 Select "DELETE", and press the [OK] button

- The selected video chapter is deleted.

Note:

- Videos cannot be restored once they are deleted.
- Deletion of the video may fail if the length of the chapter is too short.

Chapter options

Pressing the [OPTION] button on the remote control when the Chapter Edit screen is displayed enables you to perform the following editing operations.

Combining with previous chapter

- Combines the selected chapter with the previous chapter.
 - 1 Select a chapter, followed by "COMB. W/PREV CH", and press the [OK] button
 - Combines chapters.

Combining with next chapter

- Combines the selected chapter with the next chapter.
 - 1 Select a chapter, followed by "COMB. W/NEXT CH", and press the [OK] button
 - Combines chapters.

Combining all chapters

- Combines all chapters.
 - 1 Select "COMB. ALL CHAP.", and press the [OK] button
 - A confirmation screen for combining all the chapters is displayed.
 - 2 Select "YES", and press the [OK] button
 - Combines all the chapters.

Dividing

You can select a saved title and divide it into two titles.

Memo:

- Dividing can only be applied to titles stored on the HDD.
- Titles that are protected cannot be divided. To divide a title, turn off the protection.

For details on turning off the title protection, refer to “Turning Off Title/Group Protection” (page 72).

Dividing

1 Press the [EDIT] button on the remote control unit

- The Edit menu screen appears.

2 Select “DIVIDE”, and press the [OK] button

- The title screen appears.

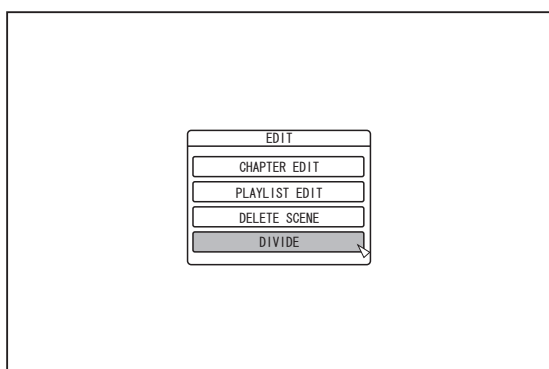

3 Select a title, and press the [OK] button

4 Play the video, and press the [■] button at the scene where you want to perform dividing

5 Select “DIVIDING POINT”, and press the [OK] button

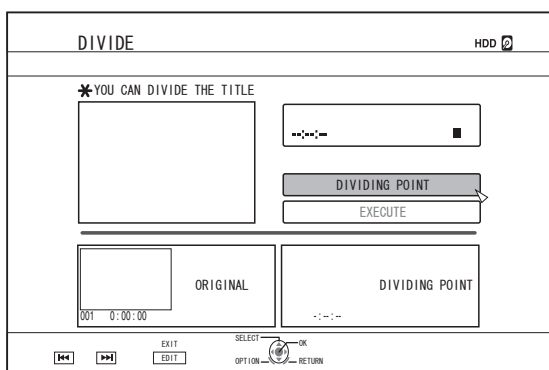

Memo:

- For details on the button operations during playback, refer to “Video Playback Operation” (page 58).
- Frame movement on the Chapter Edit screen can only be performed one frame at a time regardless of the “STILL MODE” (page 85) setting.

6 Select “EXECUTE”, and press the [OK] button

- A confirmation screen for performing dividing appears.

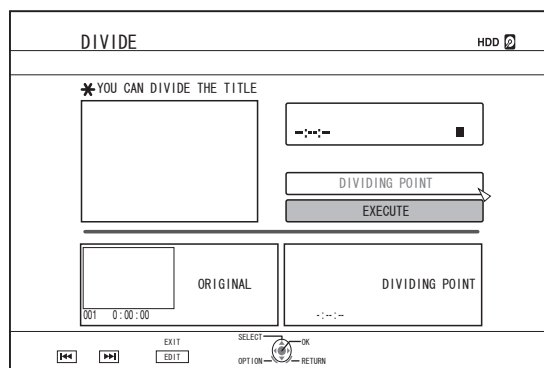

7 Select “DIVIDE”, and press the [OK] button

- Dividing starts.

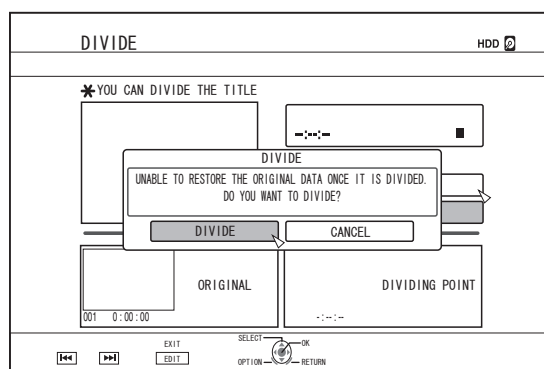

Dividing (Continued)

Memo:

- To cancel the dividing operation, select "CANCEL" and press the [OK] button.
- Alternatively, you can press the [RETURN] button to cancel the divide operation and return to the initial screen.
- The dividing edit screen can also be called up from the Playback Navigation screen.
 - Select the titles to divide, and press the [OPTION] button
 - Select "EDIT", and press the [OK] button

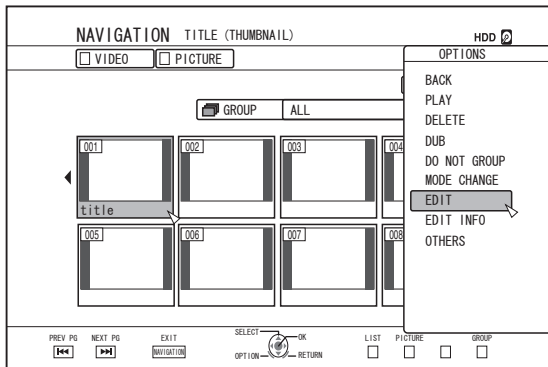

- Select "DIVIDE", and press the [OK] button

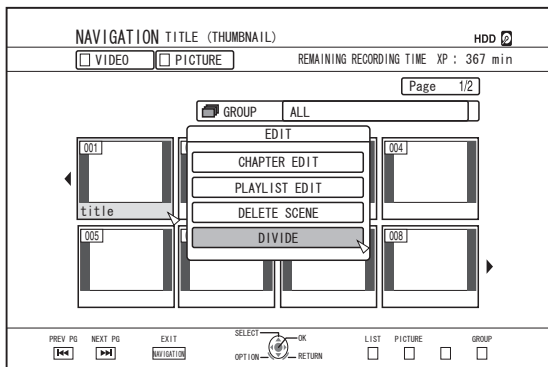

Delete Scenes

Unwanted scenes of a saved title can be deleted. Doing so helps to increase the free space on the disc.

Memo:

- Deleting scenes can only be applied to titles stored on the HDD.
- Titles that are protected cannot be deleted. To enable scene delete of a title, turn off the protection.

For details on turning off the title protection, refer to "Turning Off Title/Group Protection" (page 72).

- HD content for which the delete scene operation has been applied cannot be dubbed to BDMV. Perform seamless conversion before starting a dubbing operation.

For details, refer to "Mode conversion" (page 81).

Delete Scenes

- Press the [EDIT] button on the remote control unit
 - The Edit menu screen appears.
- Select "DELETE SCENE", and press the [OK] button
 - Displays the Title Display screen.

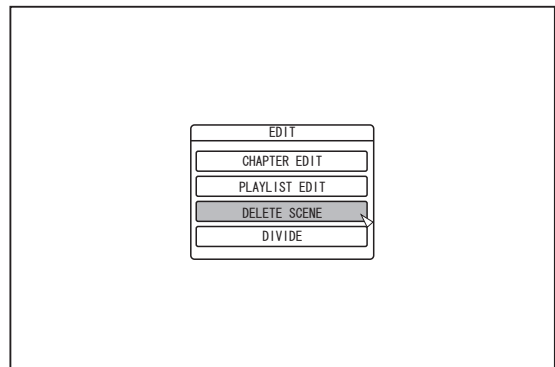

- Select a title, and press the [OK] button

4 Edit the delete scene section

Follow the steps below to edit the section for which delete scene is to be applied.

- ① Play the video, and press the [PAUSE] button at the point where you want to start the delete operation
- ② Select “START”, and press the [OK] button

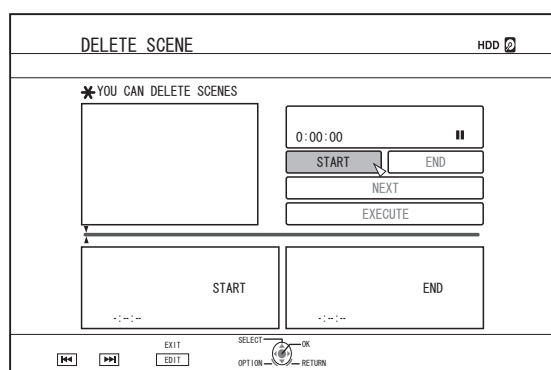

- ③ Play the video, and press the [PAUSE] button at the point where you want to end the delete operation
- ④ Select “END”, and press the [OK] button

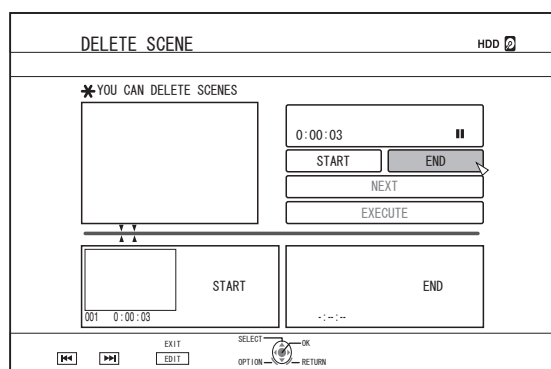

- ⑤ To continue specifying other sections to delete, select “NEXT”, and press the [OK] button

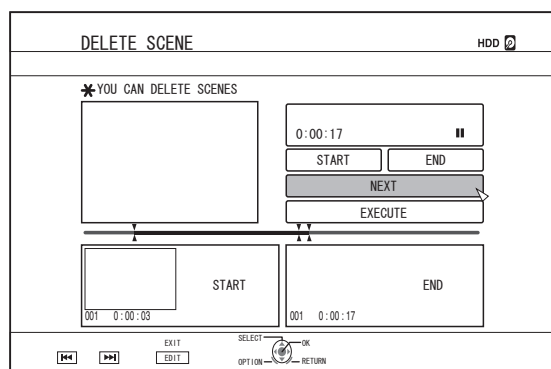

- ⑥ Repeat Steps 1 to 4 to specify the sections to delete

Memo:

- For details on the button operations during playback, refer to “Video Playback Operation” (page 58).
- Frame movement on the Chapter Edit screen can only be performed one frame at a time regardless of the “STILL MODE” (page 85) setting.

- 5 Select “EXECUTE”, and press the [OK] button
 - A confirmation screen for performing scene delete appears.
- 6 Select “EXECUTE”, and press the [OK] button
 - Scene deletion starts.

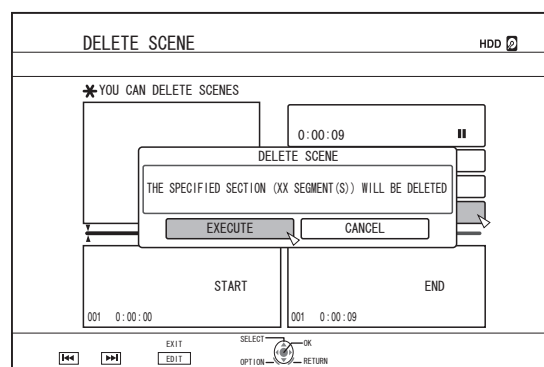

Memo:

- To cancel the delete scene operation, select “CANCEL” and press the [OK] button.
- Alternatively, you can press the [RETURN] button to cancel delete scene and return to the initial screen.

Changing the Disc Name

The name of a BD or DVD disc can be changed as follows.

1 Set the BD or DVD for which the disc name is to be changed on the disc tray

2 Press the [MEDIA MANAGE] button on the remote control unit

- The Media Management menu screen appears.

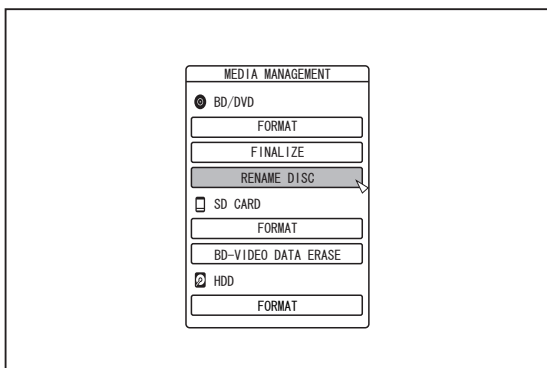

3 Select “RENAME DISC” under “BD/DVD”, and press the [OK] button

- A disc name modification screen appears.

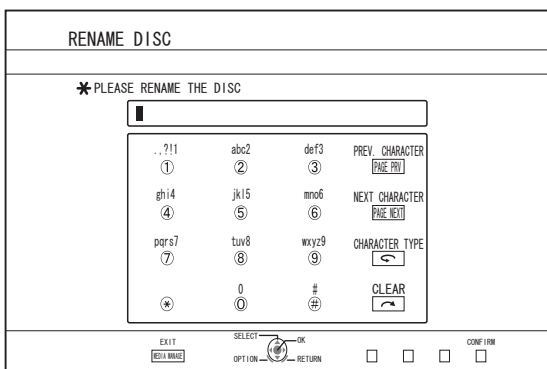

4 Modifying the Disc Name

- The new disc name is now saved.

Memo:

- For details on the method of character input, refer to “Entering Characters” (page 66).

Changing the Shooting Date/Time

The date/time of the stored video can be changed as follows.

- The shooting date/time of videos stored on the HDD can be changed.

1 Press the [INFORMATION CORRECT] button on the remote control unit

- An information correct screen appears.

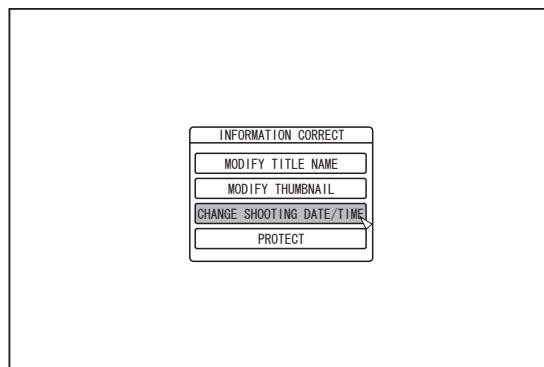

2 Select “CHANGE SHOOTING DATE/TIME”, and press the [OK] button

- A thumbnail screen appears.

3 Select the title for which the shooting date/time is to be changed, and press the [OK] button

- The screen for changing the shooting date/time appears.

4 Change the shooting date/time

- Perform the following steps to change the shooting date/time.

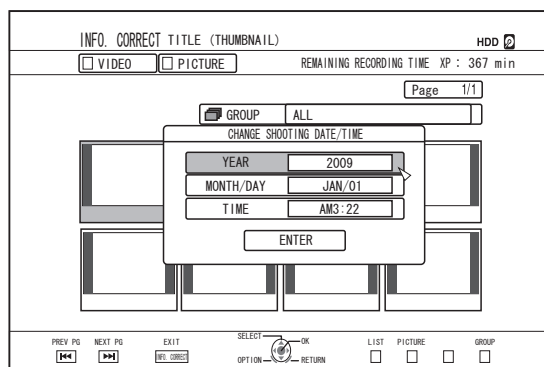

- Use the [▲] and [▼] buttons to move the cursor to the item you want to change
- Press the [OK] button to display the pop-up screen
- Use the [▲] and [▼] buttons to select a desired value
- Press the [OK] button to choose the value
- Repeat Steps 1 to 4 to change settings for any desired items

5 Select “ENTER”, and press the [OK] button

- The modified shooting date/time is saved.

Memo:

- Alternatively, you can press the [RETURN] button to cancel the shooting date/time modification and return to the initial screen.
- The shooting date/time modification will not be reflected on a title that was dubbed.
- Pressing the [OPTION] button in the playback navigation screen instead of the [INFORMATION CORRECT] button will also display the shooting date/time edit screen.
 - ① **Select the title for which the shooting date/time is to be changed, and press the [OPTION] button**
 - ② **Select “EDIT INFO”, and press the [OK] button**

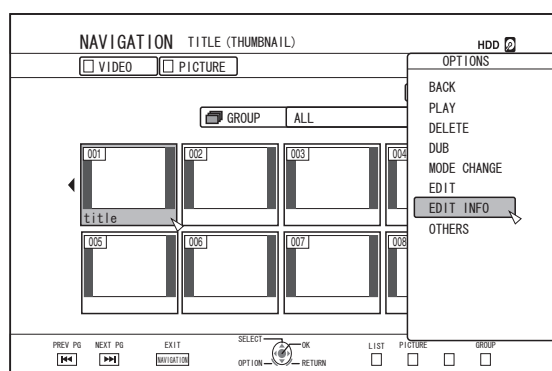

③ Select “CHANGE SHOOTING DATE/TIME”, and press the [OK] button

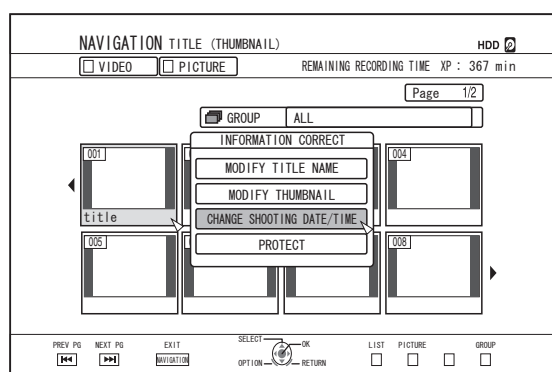

Mode conversion

You can convert HD quality video titles saved on the HDD if they are recorded in the DR, AVC, AF, AN, AL, or AE mode.

- Seamless conversion** : Seamless conversion can be performed to enable smooth playback of joined scenes after dubbing to a BD. (Titles recorded in the DR recording mode ⇒ seamless)
- Recording mode conversion** : Enables conversion of recording mode. (Titles recorded in the DR, AVC, AF, AN, AL, or AE mode ⇒ AF/AN/AL/AE/XP/SP/LP/EP)

Memo:

- As seamless conversion does not re-encode video and audio, there is no deterioration in the image quality.
- Re-encoding is performed during recording mode conversion.
- Only titles that are recorded in the DR mode enable conversion to the XP/SP/LP/EP mode.
- To apply “MODE CHANGE” after turning off the power, select “AFTER POWER OFF” for “START METHOD” under the “MODE CHANGE”.

Note:

- When seamless conversion is performed, the chapters (excluding joints of scenes) will be combined. To divide the chapters, insert chapter marks after seamless conversion. For details on dividing the chapters, refer to “Chapter mark insertion (divide chapter)” (page 76).

1 Press the [NAVIGATION] button on the remote control unit

2 Select a title/group, and press the [OPTION] button

3 Select “MODE CHANGE” from the Option menu, and press the [OK] button

- The “MODE CHANGE” screen appears.

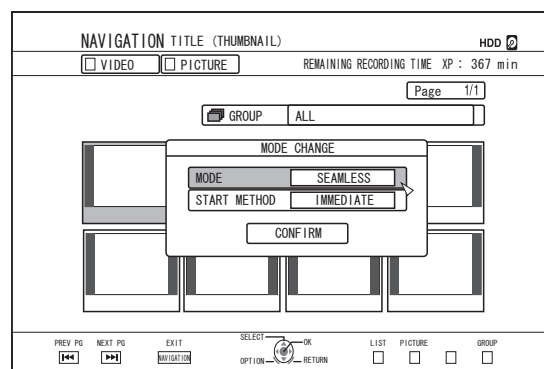

4 Select a recording mode from “MODE”, and press the [OK] button

5 Select “CONFIRM”, and press the [OK] button

Changing Settings of this Unit

Settings changed in the Settings Menu screen are stored on this unit even when its power is turned off.

Displaying the Settings Menu

1 Press the [SET UP] button on the remote control unit

- The Settings Menu screen appears.

Memo:

- When playback is in progress, pressing the button stops it and displays the Settings Menu screen.
- The cursor position appears at the position when the screen was last closed.

Setting Menu List

The following items can be set. Items that cannot be set cannot be selected.

| | |
|-----------------------------------|-----------|
| SETUP | (page 83) |
| AUTO POWER (OFF) | (page 83) |
| REMOTE CONTROL CODE | (page 83) |
| CLOCK SET/DISPLAY | (page 83) |
| CLOCK SET | (page 83) |
| DATE DISPLAY | (page 83) |
| TIME DISPLAY CHOICE | (page 83) |
| DIMMER (POWER ON) | (page 83) |
| QUICK STARTUP | (page 84) |
| BUZZER OUTPUT | (page 84) |
| REMOTE CONTROL SENSOR TONE | (page 84) |
| ALERT/WARNING TONE | (page 84) |
| DEFAULT SETTING | (page 84) |
| PLAYBACK SETTING | (page 84) |
| BD-/DVD-VIDEO PB SETTING | (page 84) |
| BD-VIDEO RATINGS | (page 84) |
| COUNTRY CODE | (page 84) |
| AUDIO LANGUAGE | (page 84) |
| SUBTITLE LANGUAGE | (page 84) |
| MENU LANGUAGE | (page 84) |
| RESUME | (page 85) |
| STILL MODE | (page 85) |
| SEAMLESS PLAYBACK | (page 85) |
| RECORD | (page 85) |
| XP MODE RECORDING AUDIO | (page 85) |
| HIGH-SPEED DUBBING | (page 85) |
| VIDEO MODE RECORDING ASPECT | (page 85) |
| DISC RECORDING AUDIO | (page 86) |
| AUTO MARKING | (page 86) |
| AUDIO | (page 86) |

| | |
|---------------------------------|-----------|
| DYNAMIC RANGE CONTROL | (page 86) |
| DOWN MIX | (page 86) |
| DIGITAL OUT | (page 87) |
| PCM DOWN SAMPLING | (page 87) |
| Dolby Digital | (page 87) |
| Dolby Digital Plus/TrueHD | (page 87) |
| DTS | (page 87) |
| DTS-HD | (page 87) |
| AAC | (page 87) |
| DV IN AUDIO SETTING | (page 87) |
| BD MIX SOUND | (page 87) |
| DISPLAY | (page 88) |
| ON SCREEN GUIDE | (page 88) |
| BLUE BACK | (page 88) |
| SCREEN SAVER | (page 88) |
| OSD LANGUAGE | (page 88) |
| CONNECTION | (page 88) |
| MONITOR TYPE | (page 88) |
| HDMI CONNECTION | (page 88) |
| VIDEO PRIORITY MODE | (page 88) |
| HDMI OUTPUT RESOLUTION | (page 89) |
| BD-VIDEO 24p OUT | (page 89) |
| x.v.Color | (page 89) |
| Deep Color | (page 89) |
| HDMI RGB OUTPUT RANGE | (page 89) |
| HDMI --> DVI COLOR | (page 89) |
| HDMI AUDIO OUTPUT | (page 89) |
| HDMI-CEC | (page 89) |
| COMPONENT OUTPUT | (page 90) |
| VIDEO INPUT SETTING | (page 90) |
| HDCP | (page 90) |
| NETWORK SETTING | (page 90) |
| IP ADDRESS SETTING | (page 90) |
| IP ADDRESS | (page 90) |
| SUBNET MASK | (page 90) |
| DEFAULT GATEWAY | (page 90) |
| MAC ADDRESS | (page 90) |

Memo:

- The highlighted value is the default setting.

SETUP

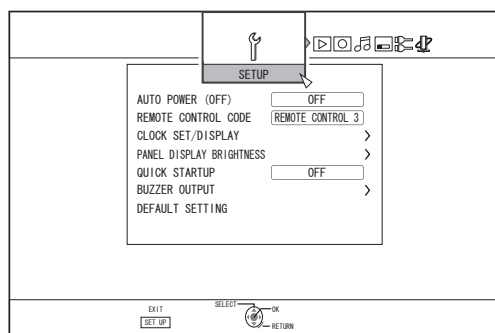

■ AUTO POWER (OFF)

You can specify a time for the power of the unit to turn off automatically when it is not being operated.

| Setting Values | Description |
|----------------|--|
| OFF | Power does not turn off automatically. |
| 2 HOURS | Turns off power after two hours. |
| 6 HOURS | Turns off power after six hours. |

■ REMOTE CONTROL CODE

For remote control units compliant with JVC's products, different remote control codes can be specified for those that are used with this unit.

| Setting Values | Description |
|------------------|--------------------------------|
| REMOTE CONTROL 1 | Sets remote control code to 1. |
| REMOTE CONTROL 2 | Sets remote control code to 2. |
| REMOTE CONTROL 3 | Sets remote control code to 3. |
| REMOTE CONTROL 4 | Sets remote control code to 4. |

■ CLOCK SET/DISPLAY

The current date/time and the display format on the screen can be specified using the "CLOCK SET", "DATE DISPLAY", and "TIME DISPLAY CHOICE" items.

- **CLOCK SET**

Sets the current date and time.

Memo:

- For details on the setting procedures, refer to "Setting the date/time" (page 23).

- **DATE DISPLAY**

For setting the date (year, month, and day) display format.

| Setting Values | Description |
|----------------|--|
| YEAR.MONTH.DAY | Displays the date in the year/month/day order. |
| MONTH.DAY.YEAR | Displays the date in the month/day/year order. |
| DAY.MONTH.YEAR | Displays the date in the day/month/year order. |

- **TIME DISPLAY CHOICE**

For setting the time display format.

| Setting Values | Description |
|----------------|--------------------------------------|
| 12H | Displays the time in AM/PM format. |
| 24H | Displays the time in 24-hour format. |

■ DIMMER (POWER ON)

For setting the brightness of the display window when the power is turned "On".

| Setting Values | Description |
|----------------|--------------|
| BRIGHT | Bright |
| DIMMED1 | Slightly dim |
| DIMMED2 | Dim |
| DIMMED3 | Dimmer |
| OFF | Off |

Setting Menu List (Continued)

■ QUICK STARTUP

For turning on/off the display window during quick startup and standby mode.

| Setting Values | Description |
|----------------|---|
| OFF | Starts up in the normal way. Display window turns off during standby mode. |
| ON | Operation is speedily enabled after turning on the power. (Quick start) Display window turns on during standby mode. |

Memo:

- When "QUICK STARTUP" is set to "OFF" for the purposes of environmental care, the display window turns off during standby mode. To turn on the display window during standby mode, set to "ON".
- Setting to "ON" increases power consumption while the unit is in the standby mode.

■ BUZZER OUTPUT

The buzzer setting can be specified as follows.

- REMOTE CONTROL SENSOR TONE

For setting whether to sound the buzzer when the remote control sensor receives signals.

| Setting Values | Description |
|----------------|--|
| OFF | Buzzer does not sound when the remote control sensor receives signals. |
| ON | Sounds the buzzer when the remote control sensor receives signals. |

- ALERT/WARNING TONE

For setting whether to sound the buzzer when an operation is completed or when a warning message appears.

| Setting Values | Description |
|----------------|------------------------|
| OFF | Buzzer does not sound. |
| ON | Sounds the buzzer. |

■ DEFAULT SETTING

Restores the setting values on the setting screen to their factory default values.

| Setting Values | Description |
|----------------|---|
| YES | Restores the factory default values. |
| NO | Returns to the initial screen without resetting the values. |

Memo:

- "BD-VIDEO RATINGS" and "COUNTRY CODE" settings cannot be reset once they have been specified.

PLAYBACK SETTING

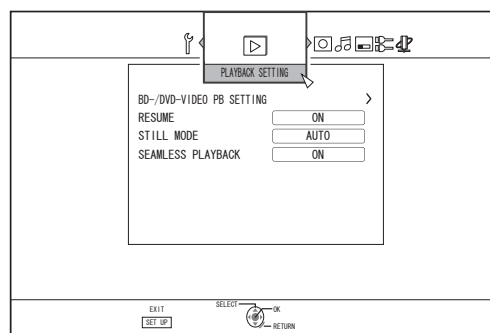

■ BD-/DVD-VIDEO PB SETTING

BD-Video and DVD-Video playback settings can be specified using the "BD-VIDEO RATINGS", "COUNTRY CODE", "AUDIO LANGUAGE", "SUBTITLE LANGUAGE", and "MENU LANGUAGE" items.

- BD-VIDEO RATINGS

For setting the lower age limit for BD-Video ratings.

| Setting Values | Description |
|-----------------------|---|
| NO LIMIT | All BD-Videos can be viewed. |
| 254 YEAR(S)-0 YEAR(S) | BD-Videos that are subject to the age limit cannot be viewed. |

Memo:

- In order to set the restrictions, password (four-digit number) registration is required.
- The password status becomes unregistered if the restriction setting is disabled. A new password can be registered after setting the age limit again.
- It is recommended that you note down the password in case it is lost or forgotten.

- COUNTRY CODE

For setting the country code.

For details on the country codes, refer to the "Country Code List" (page 106).

Memo:

- If the "BD-VIDEO RATINGS" setting is specified, you will be required to enter the password registered for the "BD-VIDEO RATINGS" in order to change the "COUNTRY CODE".

- AUDIO LANGUAGE

For setting the audio sound when playing back BD-Videos or DVD-Videos.

For details on the language codes, refer to the "Language Code List" (page 104).

- SUBTITLE LANGUAGE

For setting the subtitle language when playing back BD-Videos or DVD-Videos.

For details on the language codes, refer to the "Language Code List" (page 104).

- MENU LANGUAGE

For setting the menu language when playing back BD-Videos or DVD-Videos.

For details on the language codes, refer to the "Language Code List" (page 104).

RESUME

The stop position can be stored when playback of a BD-Video, DVD-Video, BDMV, AVCHD, finalized discs, or SD card is stopped halfway.

| Setting Values | Description |
|----------------|-----------------------------------|
| OFF | Resume information is not stored. |
| ON | Stores resume information. |

Memo:

- Resume information is stored at all times for other discs as well as the HDD regardless of this setting.
- When a HDD title is selected using Playback Navigation, it is played back from the beginning.
- Some discs do not allow playback from the resume point.

STILL MODE

For setting the method for displaying paused images during playback of the HDD or a disc.

| Setting Values | Description |
|----------------|--|
| AUTO | Automatic control. |
| FIELD | Use this setting for moving images or when there is blurring in the "AUTO" mode. |
| FRAME | Use this setting when detailed patterns or designs are not clear in the "AUTO" mode. |

Memo:

- This setting is disabled for programs in the DR mode and during playback of AVCHD videos.

SEAMLESS PLAYBACK

For setting the method for playing back partially erased scenes.

| Setting Values | Description |
|----------------|--------------------------------|
| OFF | Plays back with high accuracy. |
| ON | Plays back smoothly. |

Memo:

- SD picture quality is retained during re-encode dubbing.
- For joints of scenes that are 15 seconds or shorter, seamless playback may fail even when it is set to "ON". The same applies during re-encode dubbing in the SD picture quality.

RECORD

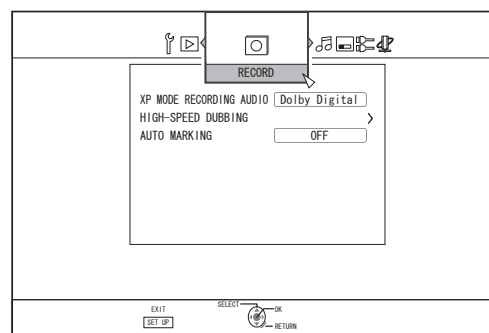

XP MODE RECORDING AUDIO

For changing the settings of audio mode during recording in the XP mode.

| Setting Values | Description |
|----------------|-----------------------------|
| Dolby Digital | Records in "Dolby Digital". |
| LPCM | Records in "LPCM". |

HIGH-SPEED DUBBING

Items under "VIDEO MODE RECORDING ASPECT" and "DISC RECORDING AUDIO" can be set to support high-speed dubbing.

- VIDEO MODE RECORDING ASPECT

For setting the aspect ratio during recording.

| Setting Values | Description |
|----------------|---|
| AUTO | Performs recording in the aspect ratio setting when recording starts. |
| 4:3 | Records at the fixed aspect ratio of 4:3. |
| 16:9 | Records at the fixed aspect ratio of 16:9. |

Memo:

- High-speed dubbing to a DVD-Video disc cannot be performed when there are different aspect ratios in a title. In this case, fix the aspect ratio to 4:3 or 16:9. This setting remains valid during re-encode dubbing.

For details on high-speed dubbing and re-encode dubbing, refer to the "Dubbing chart" (page 27).

Setting Menu List (Continued)

• DISC RECORDING AUDIO

For changing the settings of audio to be recorded to the disc when in the AF, AN, AE or AL mode.

| Setting Values | Description |
|----------------|---|
| AUTO | Records "Stereo", "Surround" or "Dual broadcast" audio sounds as they are. |
| FIXED | Records "Stereo" and "Surround" sounds in "Stereo". "Dual broadcast" audio sounds are recorded as they are. |

Memo:

- Surround sounds of a title become stereo sounds when re-encode dubbing is performed.

■ AUTO MARKING

During direct recording to a recording media (HDD or optical disc), you can append chapters by adding a mark at a fixed interval of 10 minutes or 1 hour.

| Setting Values | Description |
|----------------|---------------------------------------|
| OFF | Disables addition of chapters. |
| 10 MINUTES | Adds chapters at 10-minute intervals. |
| 1 HOUR | Adds chapters at 1-hour intervals. |

Memo:

- Regardless of whether "AUTO MARKING" is set to "OFF", "10 MINUTES", or "1 HOUR", you can perform manual marking using the Mark button on the remote control. During manual marking, an on-screen message is displayed regardless of the "ON SCREEN GUIDE" setting under "DISPLAY".

AUDIO

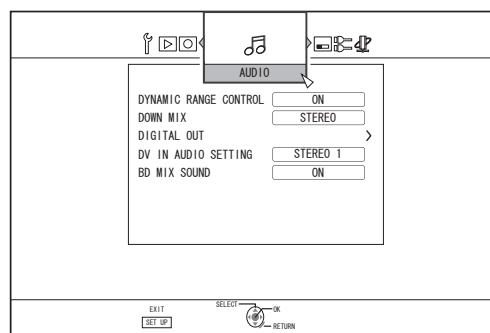

■ DYNAMIC RANGE CONTROL

For setting the dynamic range compression ratio (ratio between the maximum and minimum volume) during Dolby Digital playback.

| Setting Values | Description |
|----------------|--|
| AUTO | Perform compression only for Dolby TrueHD. |
| OFF | Not compressed. |
| ON | Perform maximum compression. |

Memo:

- Setting to "OFF" may produce the same effects as the "ON" mode for some discs.
- Performing compression allows even the slightest sound to be heard clearly.
- There may be differences in the effect depending on the disc used.

■ DOWN MIX

For setting whether to output analog audio.

| Setting Values | Description |
|----------------|---|
| STEREO | Use this setting when connecting an audio amplifier or TV. |
| DOLBY SURROUND | Use this setting when connecting an amplifier that supports Dolby Surround. |

■ **DIGITAL OUT**

Set this item according to the device connected to the digital audio output terminal (optical digital).

- PCM DOWN SAMPLING

For specifying settings on sampling frequency conversion.

| Setting Values | Description |
|----------------|--|
| OFF | Sampling frequency is not converted. |
| ON | Audio recorded at a sampling frequency of 96 kHz or 88.2 kHz is converted to 48 kHz and 44.1 kHz respectively. |

Memo:

- Setting to "OFF" may produce the same effects as the "ON" mode for some discs.

- Dolby Digital

For setting audio output to "BITSTREAM" or "PCM".

| Setting Values | Description |
|----------------|---|
| BITSTREAM | Use this setting when connecting a device that is able to decode "Dolby Digital". |
| PCM | Audio input will be changed and output as "PCM". Use this setting when connecting a device that is unable to decode "Dolby Digital". |

- Dolby Digital Plus/TrueHD

For setting audio output to "BITSTREAM" or "PCM".

| Setting Values | Description |
|----------------|---|
| BITSTREAM | Use this setting when connecting a device that is able to decode "Dolby Digital Plus/TrueHD". |
| PCM | Audio input will be changed and output as "PCM". Use this setting when connecting a device that is unable to decode "Dolby Digital Plus/TrueHD". |

- DTS

For setting audio output to "BITSTREAM" or "PCM".

| Setting Values | Description |
|----------------|---|
| BITSTREAM | Use this setting when connecting a device that is able to decode "DTS". |
| PCM | Audio input will be changed and output as "PCM". Use this setting when connecting a device that is unable to decode "DTS". |

- DTS-HD

For setting audio output to "BITSTREAM" or "PCM".

| Setting Values | Description |
|----------------|--|
| BITSTREAM | Use this setting when connecting a device that is able to decode "DTS-HD". |
| PCM | Audio input will be changed and output as "PCM". Use this setting when connecting a device that is unable to decode "DTS-HD". |

- AAC

For setting audio output to "BITSTREAM" or "PCM".

| Setting Values | Description |
|----------------|---|
| BITSTREAM | Use this setting when connecting a device that is able to decode "AAC". |
| PCM | Audio input will be changed and output as "PCM". Use this setting when connecting a device that is unable to decode "AAC". |

Memo:

- Audio sound may not be properly played back if the audio equipment in use does not support "BITSTREAM" output. In this case, set to "PCM".

■ **DV IN AUDIO SETTING**

For changing the audio recording settings during DV input.

| Setting Values | Description |
|----------------|---|
| STEREO 1 | Records the audio sound during video recording (L1, R1). |
| STEREO 2 | Records audio sound that is added later (L2, R2), such as during editing. |
| MIX | Records "STEREO 1" and "STEREO 2" sounds. |

■ **BD MIX SOUND**

For setting a mixture of BD video secondary audio and operation sounds output.

| Setting Values | Description |
|----------------|--|
| OFF | Outputs main audio only. |
| ON | Outputs a mixture of BD video secondary audio and operation sounds during playback of BD-Videos that contain BD video secondary audio and menu operation sounds. |

Memo:

- Output is converted to Dolby Digital or DTS according to the main audio when the "DIGITAL OUT" item is set to "BITSTREAM".

Setting Menu List (Continued)

DISPLAY

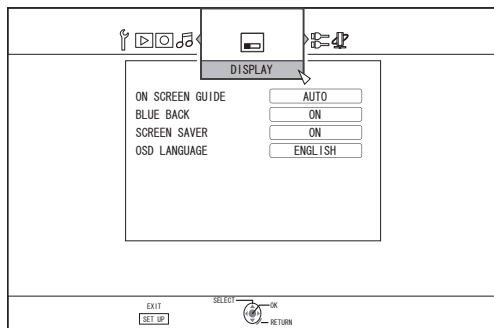

■ ON SCREEN GUIDE

For displaying operation details.

| Setting Values | Description |
|----------------|--|
| AUTO | Appears for five seconds when an operation is performed. |
| OFF | Not displayed. |

■ BLUE BACK

For setting the screen display when there is no signal input.

| Setting Values | Description |
|----------------|------------------------------------|
| OFF | Displays screen as it is. |
| ON | Switches display to a blue screen. |

■ SCREEN SAVER

For setting whether to use a screensaver.

| Setting Values | Description |
|----------------|---|
| OFF | Screen saver is not used. |
| ON | Screen saver is used. Switches to the burn-in prevention screen when the unit is not operated for more than five minutes. |

■ OSD LANGUAGE

For setting the language for messages displayed on-screen.

CONNECTION

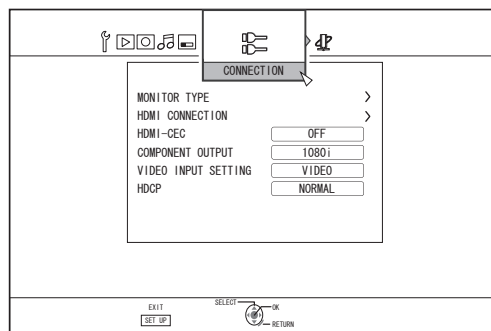

■ MONITOR TYPE

For setting the aspect ratio according to the connected monitor.

| Setting Values | Description |
|----------------|---|
| 16:9 | Set to this value when connected to monitors with 16:9 aspect ratio. |
| 16:9FULL | Choose this setting when a 16:9 monitor is connected to display images without the black borders. |
| 4:3 PAN&SCAN | Set to this value when connecting to monitors with an aspect ratio of 4:3. Plays back videos with the left and right edges trimmed off. |
| 4:3 LETTERBOX | Set to this value when connecting to monitors with an aspect ratio of 4:3. Plays back videos with a black band at the upper and lower ends. |

■ HDMI CONNECTION

- VIDEO PRIORITY MODE

| Setting Values | Description |
|----------------|---|
| COMPONENT | Set to this value for output at a resolution of "480p" (NTSC)/"576p" (PAL) or higher from the [COMPONENT VIDEO OUT] terminal. |
| HDMI | Set to this value when priority is to be given to the "HDMI OUTPUT RESOLUTION" setting. |

Memo:

- During data output from the [HDMI] terminal, setting to "COMPONENT" automatically outputs data in the "COMPONENT OUTPUT" setting. Setting to "HDMI" outputs data in the "HDMI OUTPUT RESOLUTION" setting.
- During data output from the [HDMI] and [COMPONENT VIDEO OUT] terminals, setting to "COMPONENT" automatically outputs data in the "COMPONENT OUTPUT" setting. Setting to "HDMI" outputs data at the "576i" resolution from the [COMPONENT VIDEO OUT] terminal.
- When there is no output from the [HDMI] terminal, data is automatically output from the [COMPONENT VIDEO OUT] terminal in the "COMPONENT OUTPUT" resolution.

- HDMI OUTPUT RESOLUTION

| Setting Values | Description |
|---------------------------|--|
| AUTO | Automatically selects an appropriate resolution according to the connected device. |
| 480p (NTSC) 576p (PAL) | Fixes the resolution at 480p or 576p. |
| 1080i | Fixes the resolution at 1080i. |
| 720p | Fixes the resolution at 720p. |
| 1080p | Fixes the resolution at 1080p. |

Memo:

- When the resolution is set to "720p", videos are output at "1080i" other than those recorded at "720p" even though "720p" is shown on the display.
- Depending on the conditions (monitor type 4:3, resolution "720p" and above, aspect "16:9"), the on-screen display from the component output may be cut off. In this case, set "VIDEO PRIORITY MODE" to "COMPONENT". The on-screen display from the [VIDEO OUT]/[S-VIDEO OUT] terminal may be cut off when "VIDEO PRIORITY MODE" is set to "COMPONENT". In this case, set "COMPONENT OUTPUT" to "480p (NTSC)"/"576p (PAL)" or below, or set the monitor type to a setting other than "16:9".

- BD-VIDEO 24p OUT

| Setting Values | Description |
|----------------|--|
| OFF | Outputs in the resolution set by "HDMI OUTPUT RESOLUTION". |
| ON | Outputs 24p elements at 24p. |

Memo:

- 24p playback is possible for commercially available BD-Videos or BDMVs that are recorded in 24p. Content other than BDMVs that is dubbed or recorded on this unit at 24p, as well as 24p content on SD cards are played back at 60p or 60i.
- This is applicable for BD-ROM and DVD-Video titles. This is available when connected to a 24p compatible monitor.
- Elements other than 24p ones are output at 60p (for NTSC) or 50p (for PAL).
- No video images will be output from the [VIDEO OUT], [S-VIDEO OUT] and [COMPONENT VIDEO OUT] terminals when the output resolution from the [HDMI] terminal is at 1080/24p.

- x.v.Color

| Setting Values | Description |
|----------------|---|
| AUTO | Outputs x.v.Color information with HDMI when video images that include x.v.Color information are played back. |
| OFF | Does not output x.v.Color information with HDMI when video images that include x.v.Color information are played back. |

Memo:

- This is applicable when an x.v.Color compatible monitor is connected.

- Deep Color

| Setting Values | Description |
|----------------|---|
| AUTO | Set to this value when a "Deep Color" device is connected. |
| OFF | Set to this value when the video image is distorted, or colors are unnatural. |

- HDMI RGB OUTPUT RANGE

| Setting Values | Description |
|----------------|---|
| STANDARD | Set to this value for standard uses. |
| ENHANCED | Set to this value when the black and white parts of the video image are not distinct. |

Memo:

- This is available when connected to a DVI device that only supports RGB input.

- HDMI --> DVI COLOR

| Setting Values | Description |
|----------------|--|
| AUTO | Value is set automatically according to the monitor. |
| RGB FIX | Use this setting when video images are not correctly displayed on the monitor. |

Memo:

- This is available when the "x.v.Color" setting is set to "OFF".
When the "x.v.Color" setting is set to "AUTO", this setting will be set to "AUTO" automatically.
- Change this setting when no video image appears while connected to a DVI device.

- HDMI AUDIO OUTPUT

| Setting Values | Description |
|----------------|---|
| OFF | Use this setting if you do not want to send audio output from the HDMI cable. |
| ON | Use this setting to send audio output from the HDMI cable. |

- HDMI-CEC

For setting the HDMI-CEC operation from the connected device.

| Setting Values | Description |
|----------------|--------------------|
| OFF | Disables HDMI-CEC. |
| ON | Enables HDMI-CEC. |

Setting Menu List (Continued)

■ COMPONENT OUTPUT

For setting the resolution of video output from the [COMPONENT VIDEO OUT] terminal.

| Setting Values | Description |
|---------------------------|----------------------------------|
| 480i (NTSC) 576i (PAL) | Sets output to "480i" or "576i". |
| 480p (NTSC) 576p (PAL) | Sets output to "480p" or "576p". |
| 720p | Sets output to "720p". |
| 1080i | Sets output to "1080i". |

Memo:

- When the resolution is set to "720p", videos are output at "1080i" other than those recorded at "720p" even though "720p" is shown on the display.
- This unit does not support component output at "1080p". To output at "1080p", do so via HDMI connection.
- If "VIDEO PRIORITY MODE" is set to "HDMI", the unit will output at "480i" or "576i" regardless of the current setting.
- If "VIDEO PRIORITY MODE" is set to "COMPONENT", or when an HDMI connection is used, DVD videos and BDMV will be output at "480p" or "576p" even if "720p" or "1080i" has been set.
- The aspect ratio of video/S-video output changes according to the component output setting. As such, there may be cases where the aspect ratio of the video/S-video output is different from the predefined setting of the content.

■ VIDEO INPUT SETTING

Choose a setting according to the video terminal to be connected when an external analog input terminal is used.

| Setting Values | Description |
|----------------|--|
| VIDEO | Use this setting when connecting via the video (BNC) terminal. |
| S-VIDEO | Use this setting when connecting via the S-video (black) terminal. |

■ HDCP

For setting the output of copyright-free contents to devices that do not support HDCP.

| Setting Values | Description |
|----------------|---|
| FIXED | Encrypts copyright-free contents during playback. |
| AUTO | Does not encrypt copyright-free contents during playback. |

Memo:

- If "HDCP" is set to "AUTO" while a device incompatible with HDCP is used, images may appear distorted. Operate as follows if the images are distorted. Press and hold the "0" button on the remote control for 5 seconds to set HDCP to "AUTO".

NETWORK SETTING (only for SR-HD1700)

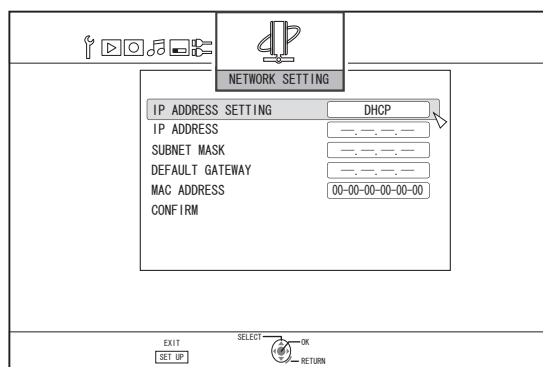

For specifying settings related to the LAN terminal.

■ IP ADDRESS SETTING

For setting whether to obtain the IP address using "DHCP" or to enter it manually using "MANUAL".

| Setting Values | Description |
|----------------|--|
| DHCP | Obtains information from the DHCP server each time the unit starts up. |
| MANUAL | For entering the IP address manually. |

Memo:

- Upon setting to DHCP, "IP ADDRESS", "SUBNET MASK", and "DEFAULT GATEWAY" are grayed out, and input is disabled.

■ IP ADDRESS

For setting the IP address.

■ SUBNET MASK

For setting the subnet mask.

■ DEFAULT GATEWAY

For setting the default gateway.

■ MAC ADDRESS

Displays the MAC address.

■ CONFIRM

Confirms the network settings that are currently displayed.

Memo:

- The settings are not applied until the confirmation items are selected.
- The default values when "IP ADDRESS SETTING" is set to "MANUAL" are as follows.

| | |
|-----------------|-------------------|
| IP ADDRESS | : 192.168.100.100 |
| SUBNET MASK | : 255.255.255.0 |
| DEFAULT GATEWAY | : 192.168.100.254 |
- Perform settings such that the same IP address is not used within the network environment.
- For details, check with the person in charge of setting the network.

Locking the Disc Tray

By turning on the lock for the disc tray, the tray cannot be opened or closed using the [▲] button.

Memo:

- When the [▲] button is pressed while the disc tray lock is turned on, a "LOCKED" message will appear on the display window of the unit for about three seconds.

Locking the disc tray

- Press the [⏻/|] button on the unit to turn "Off" the power
 - Press and hold the [■] button on this unit, then press the [▲] button
- A "LOCKED" message appears on the display window of the unit, indicating that the disc tray is locked.

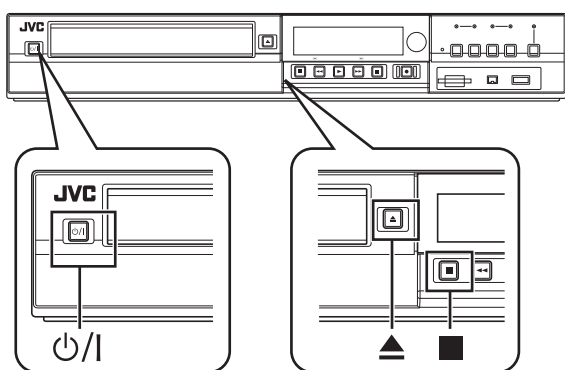

Unlocking the disc tray

- Press the [⏻/|] button on the unit to turn "Off" the power
 - Press and hold the [■] button on this unit, then press the [▲] button
- An "UNLOCK" message appears on the display window of the unit, indicating that the disc tray is unlocked.

Turning on the Mode Lock

Turning on the mode lock disables all operations using the buttons on the unit and remote control, except for "Play" and "Record".

Memo:

- When a button that is disabled is pressed, a "LOCKED" message will appear on the display window of the unit for three seconds.

Turning on the mode lock

- Press the [*] button on the remote control for five seconds or longer when in the "Normal Recording", "Stop", or "Normal Playback" mode
- A "LOCKED" message appears on the display window of the unit, indicating that the mode lock is turned on.

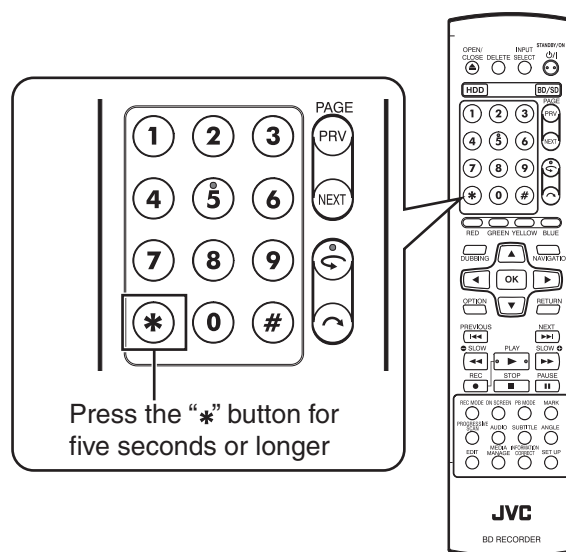

Turning off the mode lock

- Press the [*] button on the remote control for five seconds or longer when the mode lock is turned on
- An "UNLOCK" message appears on the display window of the unit, indicating that the mode lock is turned off.

Last Function Memory

When the power plug is disconnected from unit or when power failure occurs, your settings for the following functions are kept in the memory. These settings will resume when the unit is turned on again.

- Various setting menus (☞ page 82 - 90)
- Deck selection: HDD/BD/SD
- Recording mode: XP, etc. (☞ page 31)
- Input selection: HDV/DV/L-1 (☞ page 53)
- Repeat playback of the disc playback settings menu (☞ page 63)
Kept for DVD-Video/AVCHD/BDMV and title/chapter only.

External Control (only for SR-HD1700)

This unit can be controlled using a PC, etc. by connecting them with an RS-232C or LAN cable.

RS-232C Specifications

- Pin layout

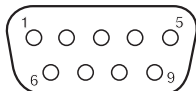

| PIN No. | Signal | Operation | Direction of signal |
|---------|--------|------------------|---------------------|
| 2 | TxD | Transmit data | This unit ⇔ PC |
| 3 | RxD | Receive data | This unit ⇔ PC |
| 5 | GND | Signal grounding | |

Mode : Non-synchronous
 Character length : 8 bits
 Parity check : Odd
 Start bit : 1
 Stop bit : 1
 Data rate : 9600 bps

- Bit configuration

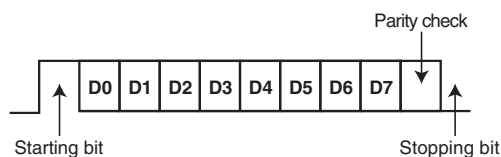

Memo:

- When using the Serial Command Connector, the cable to be used should be an RS-232C interface cable (straight type, 3 m or shorter).
- During command transmission, a minimum interval of 50 ms is required between each command.
- During command transmission, do not send the next command until the ACK (refer to “System Commands” (page 100)) or response (refer to “Response Commands” (page 100)) for each command is received.
- The recommended maximum waiting time for the ACK or response for each command is as follows.

ACK : About 50 ms
 Response : About 5 seconds

LAN Connection

To use a LAN connection, run the IP settings in “NETWORK SETTING(only for SR-HD1700)” (page 90) .

Connect by specifying 1111 for the port.

During command transmission, a minimum interval of 100 ms is required between each command.

Command Table

| Lower Order → Higher Order ↓ | 0 | 1 | 2 | 3 | 4 | 5 | 6 | 7 | 8 | 9 | A | B | C | D | E | F |
|---------------------------------|----------------|--------------------------|------------|--------------|--------------|--------------|--------------|--------------|---------------|----------------|-----------------|-------|------|------------------|-----------------|------------------|
| 0 | | Complete | Error | Cassette Out | | Not Target | Not Ready | | | | ACK | NAK | | | | |
| 1 | | | | | | | | | | | | | | | | |
| 2 | | | | | | | | | | | | | | | | |
| 3 | | | | | | | | | | | Play | | | | | Stop |
| 4 | | | | | | | | | | | | | | | | Still |
| 5 | | | | | | | Clear | | | | | | | | | |
| 6 | Sense Chapter | Title Sense | | | | | | | | | | | | | | |
| 7 | | | | | | | | | | | | | | | | |
| 8 | Chapter Search | Title Search | | | | | | | | | | | | | Date Preset | Clock Preset |
| 9 | Finalize | Cancel Disc Finalization | Disc Erase | TOP MENU | MEDIA MANAGE | NEXT CHAPTER | PREV CHAPTER | Setup | SET | UP | DOWN | RIGHT | LEFT | Next Title | Prev Title | Remote Data |
| A | Standby On | Standby Off | | Eject | | | | | | | | FF | REW | Fwd Field Step | Rev Field Step | |
| B | | | | | | Fwd Shtl | Rev Shtl | | Select Preset | Select Sense | | | | | Date Data Sense | Clock Data Sense |
| C | | | | | | | | | | | Rec | | | | | |
| D | | | | | | | | Status Sense | TC Data Sense | CTL Data Sense | | | | JVC Status Sense | | |
| E | | | | | | | | | | | | | | | | |
| F | Command Target | | | | | | | | | | Rec/Dub Request | | | | | |

External Control (only for SR-HD1700) (Continued)

Command

■ Operation Commands

Commands for operating functions such as PLAY and REC on the BLU-RAY DISC & HDD RECORDER

| Command | Description |
|---------|--|
| 3A | Plays the selected deck. |
| 3F | Stops the selected deck. Resume will be cleared when this is pressed while in the Stop mode. Rec Request will be cleared. |
| 4F | Switches the selected deck to the Still mode. |
| 56 | Clear: Clears the Error status. |
| 80 | Searches the specified chapter and starts playback from the beginning. |
| 81 | Searches the specified title under "ORIGINAL" or in the "PLAY LIST" by its number and starts playback from the beginning. |
| 8E | For setting the date. |
| 8F | For setting the time. |
| 90 | Finalizes the disc. (BD Deck) |
| 91 | Cancels disc finalization. (BD Deck) |
| 92 | For erasing rewritable discs. |
| 93 | Displays/Closes the top menu of a disc. (BD Deck) |
| 94 | Displays/Close the Media Manage Menu. (BD Deck) |
| 95 | Advances to the next chapter. Functions like the ►► button on the remote control. |
| 96 | Returns to the previous chapter. Functions like the ◀◀ button on the remote control. |
| 97 | Displays/Closes the Main Menu, Editing, Library Database Navigation or Dubbing screen. 97 ⇨ 30: Closes the screen. 97 ⇨ 31: Displays the Main Menu screen. 97 ⇨ 32: Displays the Library Database Navigation screen. 97 ⇨ 35: Displays the Editing screen. 97 ⇨ 37: Displays the Dubbing screen. |
| 98 | Functions as a confirmation key. |
| 99 | Functions as an up key. |
| 9A | Functions as a down key. |
| 9B | Functions as a right key. |
| 9C | Functions as a left key. |
| 9D | Advances to the next title. Functions like the ►► button on the remote control. |
| 9E | Returns to the previous title. Functions like the ◀◀ button on the remote control. |
| 9F | Issues the same codes as the wired remote control via RS-232C. |
| A0 | Power On |
| A1 | Power Off |
| A3 | Eject: Opens/Closes tray. (BD Deck) |
| AB | FF: Functions only during playback. Activates forward search. |
| AC | REW: Functions only during playback. Activates reverse search. |
| AD | Functions as a key for advancing (FWD) a frame. When this command is received during still mode, the unit advances the still picture by one frame (or field) in the FWD direction. |
| AE | Functions as a key for reversing (REV) a frame. When this command is received during still mode, the unit reverses the still picture by one frame (or field) in the REV direction. |
| B5 | Fwd Shtl: Functions only during playback. Activates forward search. B5 ⇨ 30: STILL B5 ⇨ 31: FWD SLOW at the slowest speed B5 ⇨ 32: FWD SLOW at a slow speed B5 ⇨ 33: FWD SLOW at a fast speed B5 ⇨ 34: FWD SLOW at the fastest speed B5 ⇨ 35: 1x B5 ⇨ 36: FWD SEARCH at the slowest speed B5 ⇨ 37: FWD SEARCH at a slow speed B5 ⇨ 38: FWD SEARCH at a fast speed B5 ⇨ 39: FWD SEARCH at a faster speed B5 ⇨ 3A: FWD SEARCH at the fastest speed B5 ⇨ 3B: 1.3x |
| B6 | Rev Shtl: Functions only during playback. Activates reverse search. B6 ⇨ 30: STILL B6 ⇨ 31: REV SLOW at the slowest speed B6 ⇨ 32: REV SLOW at a slow speed B6 ⇨ 33: REV SLOW at a fast speed B6 ⇨ 34: REV SLOW at the fastest speed B6 ⇨ 36: REV SEARCH at the slowest speed B6 ⇨ 37: REV SEARCH at a slow speed B6 ⇨ 38: REV SEARCH at a fast speed B6 ⇨ 39: REV SEARCH at a faster speed B6 ⇨ 3A: REV SEARCH at the fastest speed |
| B8 | For setting the input/output, recording mode, audio language selection and subtitle selection. |

| | |
|----|---|
| CA | Rec: Starts recording at the selected deck when a Rec Request is received. |
| F0 | Command Target: F0 ⇒ 34: For selecting HDD deck. F0 ⇒ 38: For selecting BD deck. F0 ⇒ 3C: For selecting SD deck. |
| FA | Rec/Dub Request: For issuing approval for recording. This can be cleared using "Stop". |

80-8F

80 : Chapter Search

| | 1st Byte | 2nd Byte | 3rd Byte |
|-----------------------|----------|----------|----------|
| Chapter Search | Hundreds | Tens | Ones |
| ASCII codes (30 - 39) | 3* | 3* | 3* |
| E.g. (012) | 30 | 31 | 32 |

E.g. : When searching the 12th chapter.

81 : Title Search under "ORIGINAL"

| | 1st Byte | 2nd Byte | 3rd Byte | 4th Byte |
|-------------------------|----------|----------|----------|----------|
| Title Search (ORIGINAL) | 30 | Hundreds | Tens | Ones |
| ASCII codes (30 - 39) | 30 | 3* | 3* | 3* |
| E.g. (345) | 30 | 33 | 34 | 35 |

E.g. : When searching the 345th title, as indicated by the title number on the top right corner of the index, under "ORIGINAL".

81 : Title Search in "PLAY LIST"

| | 1st Byte | 2nd Byte | 3rd Byte | 4th Byte |
|--------------------------|----------|----------|----------|----------|
| Title Search (PLAY LIST) | 38 | Hundreds | Tens | Ones |
| ASCII codes (30 - 39) | 38 | 3* | 3* | 3* |
| E.g. (028) | 38 | 30 | 32 | 38 |

E.g. : When searching the 28th play list, as indicated by the play list number on the top right corner of the index, in the "PLAY LIST".

8E : Date Preset

| | 1st Byte | 2nd Byte | 3rd Byte | 4th Byte | 5th Byte | 6th Byte |
|-----------------------|------------|------------|------------|------------|-----------|-----------|
| Date Preset | Mth (Tens) | Mth (Ones) | Day (Tens) | Day (Ones) | Yr (Tens) | Yr (Ones) |
| ASCII codes (30 - 39) | 3* | 3* | 3* | 3* | 3* | 3* |
| E.g. (09.14.2012) | 30 | 39 | 31 | 34 | 31 | 32 |

E.g. : When setting the date to September 14 2012.

8F : Clock Preset

| | 1st Byte | 2nd Byte | 3rd Byte | 4th Byte | 5th Byte | 6th Byte |
|-----------------------|-----------|-----------|------------|------------|------------|------------|
| Clock Preset | Hr (Tens) | Hr (Ones) | Min (Tens) | Min (Ones) | Sec (Tens) | Sec (Ones) |
| ASCII codes (30 - 39) | 3* | 3* | 3* | 3* | 3* | 3* |
| E.g. (12:34:56) | 31 | 32 | 33 | 34 | 35 | 36 |

E.g. : When setting the time to 12 hrs 34 min and 56 sec.

External Control (only for SR-HD1700) (Continued)

9F

9F : Remote Data

The remote control codes for controlling the wired remote controller via RS-232C is as shown in the following table. The codes apply to all three HDD, BD and SD deck unless otherwise stated.

| Code | Items | Remarks |
|------|---------------------------|---------|
| 01 | INPUT SELECT | |
| 03 | STOP | |
| 06 | F.F/SPEED+ | |
| 07 | REW/SPEED- | |
| 0B | POWER ON/OFF | |
| 0C | PLAY | |
| 0D | PAUSE/STILL | |
| 14 | FWD SKIP | |
| 15 | REV SKIP | |
| 17 | AUDIO | |
| 1A | Power Off | |
| 1D | Power On | |
| 21 | TEN KEY 1 | |
| 22 | TEN KEY 2 | |
| 23 | TEN KEY 3 | |
| 24 | TEN KEY 4 | |
| 25 | TEN KEY 5 | |
| 26 | TEN KEY 6 | |
| 27 | TEN KEY 7 | |
| 28 | TEN KEY 8 | |
| 29 | TEN KEY 9 | |
| 2A | KEY * | |
| 2B | TEN KEY 0 | |
| 2C | KEY # | |
| 31 | REC MODE (XP/SP/LP/EP...) | |
| 32 | BD/DVD DECK | |
| 34 | DUBBING | |
| 37 | SET UP | |
| 3C | OK/ENTER | |
| 3E | ON SCREEN | |
| 44 | HDD DECK | |
| 48 | MEDIA MANAGEMENT | |

| | | |
|----|------------------|---|
| 80 | CURSOR 0° | Moves the arrow in the index list to the right. (▶) |
| 81 | MENU | BD/DVD Deck only |
| 82 | CURSOR 90° | Moves the arrow in the index list to the up. (▲) |
| 84 | CURSOR 180° | Moves the arrow in the index list to the left. (◀) |
| 86 | CURSOR 270° | Moves the arrow in the index list to the down. (▼) |
| 87 | OPEN/CLOSE | BD/DVD Deck only |
| 8E | PROGRESSIVE | HDD/BD Deck only |
| 8F | TOP MENU | DVD Deck only |
| 90 | MARK | HDD/DVD Deck only |
| 96 | CM SKIP | |
| AF | REV FRAME | |
| B0 | -SLOW D | |
| B1 | SHUTTLE-C | |
| B2 | SHUTTLE-B | |
| B3 | SHUTTLE-A | |
| B4 | SHUTTLE-2 | |
| B5 | SHUTTLE-1 | |
| B6 | -SLOW B | |
| B7 | -SLOW C | |
| B8 | +SLOW C | |
| B9 | +SLOW B | |
| BA | SHUTTLE +1 | |
| BB | SHUTTLE +2 | |
| BC | SHUTTLE +A | |
| BD | SHUTTLE +B | |
| BE | SHUTTLE +C | |
| BF | +SLOW D | |
| C0 | ANGLE/LIVE CHECK | ANGLE (BD/DVD Deck only) LIVE CHECK (HDD/BD Deck only) |
| C4 | SUBTITLE | DVD Deck only |

| | | |
|----|------------------|--|
| CC | REC | |
| D3 | OPTION | |
| D4 | RETURN | |
| D5 | COLOR KEY BLUE | |
| D7 | COLOR KEY RED | |
| D9 | JOG -1/6 | |
| DA | JOG +1/6 | |
| DB | JOG +1 | |
| DC | INSTANT REPLAY | |
| DD | EDIT | |
| DE | COLOR KEY GREEN | |
| DF | COLOR KEY YELLOW | |

| | | |
|----|----------------------------|---------------|
| E0 | NAVIGATION | |
| E1 | L-1 Y/C INPUT SELECT | HDD Deck only |
| E2 | L-1 COMPOSITE INPUT SELECT | HDD Deck only |
| E3 | PLAYBACK SETTING | |
| E4 | DELETE | |
| E5 | INFORMATION CORRECT | |
| ED | FWD FRAME | |
| F2 | MODE LOCK | |
| F3 | HDCP AUTO | |

B8

B8 : Input/Output Selection

| | | 1st Byte | 2nd Byte |
|--------------------------|-------------|----------|----------|
| External input selection | L-1 VIDEO | 30 | 31 |
| External input selection | L-1 S-VIDEO | 30 | 39 |
| External input selection | DV | 30 | 34 |

B8 : Recording Mode Selection

| | 1st Byte | 2nd Byte |
|----|----------|----------|
| XP | 34 | 30 |
| SP | 34 | 31 |
| LP | 34 | 32 |
| EP | 34 | 33 |
| DR | 34 | 3A |
| AF | 34 | 3B |
| AN | 34 | 3C |
| AL | 34 | 3D |
| AE | 34 | 3E |

External Control (only for SR-HD1700) (Continued)

Subtitle Selection

B8 : Subtitle Selection

| | 1st Byte | 2nd Byte | | 1st Byte | 2nd Byte | | 1st Byte | 2nd Byte | | 1st Byte | 2nd Byte |
|-----------|----------|----------|----|----------|----------|----|----------|----------|----|----------|----------|
| OFF | 3C | 10 | EL | 3C | 31 | LO | 3C | 56 | SL | 3C | 78 |
| JAPANESE | 3C | 11 | EO | 3C | 32 | LT | 3C | 57 | SM | 3C | 79 |
| ENGLISH | 3C | 12 | ET | 3C | 33 | LV | 3C | 58 | SN | 3C | 7A |
| GERMAN | 3C | 13 | EU | 3C | 34 | MG | 3C | 59 | SO | 3C | 7B |
| FRENCH | 3C | 14 | FA | 3C | 35 | MI | 3C | 5A | SQ | 3C | 7C |
| ITALIAN | 3C | 15 | FJ | 3C | 36 | MK | 3C | 5B | SR | 3C | 7D |
| SPANISH | 3C | 16 | FO | 3C | 37 | ML | 3C | 5C | SS | 3C | 7E |
| DUTCH | 3C | 17 | FY | 3C | 38 | MN | 3C | 5D | ST | 3C | 7F |
| SWEDISH | 3C | 18 | GA | 3C | 39 | MO | 3C | 5E | SU | 3C | 80 |
| NORWEGIAN | 3C | 19 | GD | 3C | 3A | MR | 3C | 5F | SW | 3C | 81 |
| FINNISH | 3C | 1A | GL | 3C | 3B | MS | 3C | 60 | TA | 3C | 82 |
| DANISH | 3C | 1B | GN | 3C | 3C | MT | 3C | 61 | TE | 3C | 83 |
| AA | 3C | 1C | GU | 3C | 3D | MY | 3C | 62 | TG | 3C | 84 |
| AB | 3C | 1D | HA | 3C | 3E | NA | 3C | 63 | TH | 3C | 85 |
| AF | 3C | 1E | HI | 3C | 3F | NE | 3C | 64 | TI | 3C | 86 |
| AM | 3C | 1F | HR | 3C | 40 | OC | 3C | 65 | TK | 3C | 87 |
| AR | 3C | 20 | HU | 3C | 41 | OM | 3C | 66 | TL | 3C | 88 |
| AS | 3C | 21 | HY | 3C | 42 | OR | 3C | 67 | TN | 3C | 89 |
| AY | 3C | 22 | IA | 3C | 43 | PA | 3C | 68 | TO | 3C | 8A |
| AZ | 3C | 23 | IE | 3C | 44 | PL | 3C | 69 | TR | 3C | 8B |
| BA | 3C | 24 | IK | 3C | 45 | PS | 3C | 6A | TS | 3C | 8C |
| BE | 3C | 25 | IS | 3C | 47 | PT | 3C | 6B | TT | 3C | 8D |
| BG | 3C | 26 | KA | 3C | 4B | QU | 3C | 6C | TW | 3C | 8E |
| BH | 3C | 27 | KK | 3C | 4C | RM | 3C | 6D | UK | 3C | 8F |
| BI | 3C | 28 | KL | 3C | 4D | RN | 3C | 6E | UR | 3C | 90 |
| BN | 3C | 29 | KM | 3C | 4E | RO | 3C | 6F | UZ | 3C | 91 |
| BO | 3C | 2A | KN | 3C | 4F | RU | 3C | 70 | VI | 3C | 92 |
| BR | 3C | 2B | KO | 3C | 50 | RW | 3C | 71 | VO | 3C | 93 |
| CA | 3C | 2C | KS | 3C | 51 | SA | 3C | 72 | WO | 3C | 94 |
| CO | 3C | 2D | KU | 3C | 52 | SD | 3C | 73 | XH | 3C | 95 |
| CS | 3C | 2E | KY | 3C | 53 | SG | 3C | 74 | YO | 3C | 96 |
| CY | 3C | 2F | LA | 3C | 54 | SI | 3C | 76 | ZH | 3C | 97 |
| DZ | 3C | 30 | LN | 3C | 55 | SK | 3C | 77 | ZU | 3C | 98 |

"Language Code List" (☞ page 104)

Audio Language Selection

B8 : Audio Language Selection

| | 1st Byte | 2nd Byte | | 1st Byte | 2nd Byte | | 1st Byte | 2nd Byte | | 1st Byte | 2nd Byte |
|-----------|----------|----------|----|----------|----------|----|----------|----------|----|----------|----------|
| JAPANESE | 39 | 11 | EO | 39 | 32 | LT | 39 | 57 | SM | 39 | 79 |
| ENGLISH | 39 | 12 | ET | 39 | 33 | LV | 39 | 58 | SN | 39 | 7A |
| GERMAN | 39 | 13 | EU | 39 | 34 | MG | 39 | 59 | SO | 39 | 7B |
| FRENCH | 39 | 14 | FA | 39 | 35 | MI | 39 | 5A | SQ | 39 | 7C |
| ITALIAN | 39 | 15 | FJ | 39 | 36 | MK | 39 | 5B | SR | 39 | 7D |
| SPANISH | 39 | 16 | FO | 39 | 37 | ML | 39 | 5C | SS | 39 | 7E |
| DUTCH | 39 | 17 | FY | 39 | 38 | MN | 39 | 5D | ST | 39 | 7F |
| SWEDISH | 39 | 18 | GA | 39 | 39 | MO | 39 | 5E | SU | 39 | 80 |
| NORWEGIAN | 39 | 19 | GD | 39 | 3A | MR | 39 | 5F | SW | 39 | 81 |
| FINNISH | 39 | 1A | GL | 39 | 3B | MS | 39 | 60 | TA | 39 | 82 |
| DANISH | 39 | 1B | GN | 39 | 3C | MT | 39 | 61 | TE | 39 | 83 |
| AA | 39 | 1C | GU | 39 | 3D | MY | 39 | 62 | TG | 39 | 84 |
| AB | 39 | 1D | HA | 39 | 3E | NA | 39 | 63 | TH | 39 | 85 |
| AF | 39 | 1E | HI | 39 | 3F | NE | 39 | 64 | TI | 39 | 86 |
| AM | 39 | 1F | HR | 39 | 40 | OC | 39 | 65 | TK | 39 | 87 |
| AR | 39 | 20 | HU | 39 | 41 | OM | 39 | 66 | TL | 39 | 88 |
| AS | 39 | 21 | HY | 39 | 42 | OR | 39 | 67 | TN | 39 | 89 |
| AY | 39 | 22 | IA | 39 | 43 | PA | 39 | 68 | TO | 39 | 8A |
| AZ | 39 | 23 | IE | 39 | 44 | PL | 39 | 69 | TR | 39 | 8B |
| BA | 39 | 24 | IK | 39 | 45 | PS | 39 | 6A | TS | 39 | 8C |
| BE | 39 | 25 | IS | 39 | 47 | PT | 39 | 6B | TT | 39 | 8D |
| BG | 39 | 26 | KA | 39 | 4B | QU | 39 | 6C | TW | 39 | 8E |
| BH | 39 | 27 | KK | 39 | 4C | RM | 39 | 6D | UK | 39 | 8F |
| BI | 39 | 28 | KL | 39 | 4D | RN | 39 | 6E | UR | 39 | 90 |
| BN | 39 | 29 | KM | 39 | 4E | RO | 39 | 6F | UZ | 39 | 91 |
| BO | 39 | 2A | KN | 39 | 4F | RU | 39 | 70 | VI | 39 | 92 |
| BR | 39 | 2B | KO | 39 | 50 | RW | 39 | 71 | VO | 39 | 93 |
| CA | 39 | 2C | KS | 39 | 51 | SA | 39 | 72 | WO | 39 | 94 |
| CO | 39 | 2D | KU | 39 | 52 | SD | 39 | 73 | XH | 39 | 95 |
| CS | 39 | 2E | KY | 39 | 53 | SG | 39 | 74 | YO | 39 | 96 |
| CY | 39 | 2F | LA | 39 | 54 | SI | 39 | 76 | ZH | 39 | 97 |
| DZ | 39 | 30 | LN | 39 | 55 | SK | 39 | 77 | ZU | 39 | 98 |
| EL | 39 | 31 | LO | 39 | 56 | SL | 39 | 78 | | | |

“Language Code List” (☞ page 104)

External Control (only for SR-HD1700) (Continued)

Response Commands

RS-232C commands send from the deck.

| Command | Description |
|---------|--|
| 01 | Complete: Issued by the external recorder upon completing all specified operations by commands. |
| 02 | Error: Issued by the external recorder when receiving invalid commands in the context. In such cases, commands that are sent will not be accepted. However, a return command will be issued but only to the Status Sense. To clear the Error status, perform command 56 (Clear). |
| 05 | Not Target: Issued by the external recorder when specified operations by commands cannot be completed properly. |
| 06 | Not Ready: This command is returned when the command request cannot be executed due to the following conditions. <ul style="list-style-type: none"> • Power is OFF • Sending of control command is forbidden |
| 0A | ACK: A return command issued when a defined command is received. |
| 0B | NAK: A return command issued when an undefined or possibly nonexistent command is received. |
| 03 | Cassette Out: Issued upon completing the operation of opening and closing the tray when the HDD/DVD deck is selected. |

System Commands

Commands for acquiring information such as deck status.

| Command | Description |
|---------|---|
| 60 | Chapter Sense: For acquiring the current chapter number. (*) |
| 61 | Title/Track Sense: For acquiring the current title number under "ORIGINAL" or in the "PLAY LIST". (*) |
| B9 | Select Sense: For acquiring the status of the inputs, outputs, recording mode, audio language selection and subtitle selection. (*) |
| BE | Date Sense: For acquiring the currently configured year, month and day. (*) |
| BF | Time Sense: For acquiring the currently configured hour, minute and second. (*) |
| D7 | Status Sense: For acquiring the deck information. (*) |
| D8 | TC Data Sense: For acquiring the total remaining time in the current recording mode when there is a media in the selected deck. (*) |
| D9 | CTL Data Sense: For acquiring the lapse counter when there is a media in the selected deck. (*) |
| DD | JVC Status Sense: Returns data from the unit. (*) |
| FB | VTR Ind: A command for checking whether the connected device is the external recorder. |

(*) : See  pages 100-103 for data format.

Sense

- Chapter Sense

| | 1st Byte | 2nd Byte | 3rd Byte |
|---------------|----------|----------|----------|
| Chapter Sense | Hundreds | Tens | Ones |
| 60 | 3* | 3* | 3* |
| E.g. (012) | 30 | 31 | 32 |

E.g. : When the current chapter is the 12th chapter.

- Title/Track Sense under “ORIGINAL”

| | 1st Byte | 2nd Byte | 3rd Byte | 4th Byte |
|------------------------------|----------|----------|----------|----------|
| Title/Track Sense (ORIGINAL) | 30 | Hundreds | Tens | Ones |
| 61 | 30 | 3* | 3* | 3* |
| E.g. (345) | 30 | 33 | 34 | 35 |

E.g. : When the current title under “ORIGINAL” is the 345th title.

- Title/Track Sense in “PLAY LIST”

| | 1st Byte | 2nd Byte | 3rd Byte | 4th Byte |
|-------------------------------|----------|----------|----------|----------|
| Title/Track Sense (PLAY LIST) | 38 | Hundreds | Tens | Ones |
| 61 | 38 | 3* | 3* | 3* |
| E.g. (028) | 38 | 30 | 32 | 38 |

E.g. : When the current title under “PLAY LIST” is the 28th title.

- Select Sense

| | 1st Byte | 2nd Byte | 3rd Byte | 4th Byte | 5th Byte |
|-------------------|--------------------------|------------------|--------------------------|--------------------------|--------------------|
| Select Sense | External input selection | Output selection | Recording mode selection | Audio language selection | Subtitle selection |
| B9 | 3* | 3* | ** | ** | ** |
| E.g. (3930311213) | 39 | 30 | 31 | 12 | 13 |

E.g. : When the selection status of the video deck is as follows:

External input selection ⇒ L-1 S-VIDEO

Output selection ⇒ Common output (Frame is fixed at 0.)

Recording mode selection ⇒ SP

Audio language selection ⇒ ENGLISH

Subtitle selection ⇒ GERMAN

For response data for B9, see data format for “B8 (Select Preset)” (page 97-99).

When the current status cannot be acquired, the value is fixed as “-” (0x2D).

- Date Data Sense

For acquiring the currently configured year, month and day in ASCII codes.

| | 1st Byte | 2nd Byte | 3rd Byte | 4th Byte | 5th Byte | 6th Byte |
|-------------------|------------|------------|------------|------------|-----------|-----------|
| Date Sense | Mth (Tens) | Mth (Ones) | Day (Tens) | Day (Ones) | Yr (Tens) | Yr (Ones) |
| BE | 3* | 3* | 3* | 3* | 3* | 3* |
| E.g. (09.14.2012) | 30 | 39 | 31 | 34 | 31 | 32 |

When the current date is not set, the value is fixed as “-” (0x2D).

- Time Data Sense

For acquiring the currently configured hour, minute and second in ASCII codes.

| | 1st Byte | 2nd Byte | 3rd Byte | 4th Byte | 5th Byte | 6th Byte |
|-----------------|-----------|-----------|------------|------------|------------|------------|
| Time Sense | Hr (Tens) | Hr (Ones) | Min (Tens) | Min (Ones) | Sec (Tens) | Sec (Ones) |
| BF | 3* | 3* | 3* | 3* | 3* | 3* |
| E.g. (12:34:56) | 31 | 32 | 33 | 34 | 35 | 36 |

When the current time is not set, the value is fixed as “-” (0x2D).

External Control (only for SR-HD1700) (Continued)

• Status Data Sense

For acquiring the remaining time in the current recording mode in hours, minutes and seconds for HDD/BD/SD.

| D7 STATUS SENSE | 1st Byte | 1st Byte | 1st Byte | 2nd Byte | 3rd Byte | 4th Byte | 5th Byte |
|-----------------|---|---|---|----------------------------------|--|---------------------------------|--|
| | HDD | BD | SD | HDD/BD/SD | HDD/BD/SD | HDD/BD/SD | HDD/BD/SD |
| bit7 | 1 (Fixed) | 1 (Fixed) | 1 (Fixed) | Video EE | 0 (Fixed) | During PLAY | During PAUSE (Set to 1 simultaneously with "During PLAY" in STILL mode. Set to 1 simultaneously with "During REC" in record pause mode.) |
| bit6 | 0 (Fixed) | 1 (Fixed) | 1 (Fixed) | Audio EE | 0 (Fixed) | 0 (Fixed) | 0 (Fixed) |
| bit5 | 0 (Fixed) | 0 (Fixed) | 1 (Fixed) | 0 (Fixed) | 0 (Fixed) | 0 (Fixed) | During Reverse Shuttle Search (Excluding STILL) |
| bit4 | Record Forbidden | Record Forbidden | 1 (Fixed) | 0 (Fixed) | 0 (Fixed) | During STOP | During Forward Shuttle Search (Excluding STILL) |
| bit3 | Disc Not Inserted | Disc Not Inserted | Disc Not Inserted | Occurrence of abnormality in VTR | 0 (Fixed) | During STANDBY (Unit Power Off) | Refer to the SEARCH SPEED table. |
| bit2 | 0 (Fixed) | 0 (Fixed) | 0 (Fixed) | 0 (Fixed) | During Repeat Playback (Including PAUSE) | 0 (Fixed) | Refer to the SEARCH SPEED table. |
| bit1 | 0 (Fixed) | 0 (Fixed) | 0 (Fixed) | 0 (Fixed) | 0 (Fixed) | During REC | Refer to the SEARCH SPEED table. |
| bit0 | RS-232C command error status. Clear using 56 (Clear). | RS-232C command error status. Clear using 56 (Clear). | RS-232C command error status. Clear using 56 (Clear). | 0 (Fixed) | 0 (Fixed) | 0 (Fixed) | Refer to the SEARCH SPEED table. |

• TC Data Sense

| | 1st Byte | 2nd Byte | 3rd Byte | 4th Byte | 5th Byte | 6th Byte | 7th Byte | 8th Byte |
|-----------------|-----------|-----------|------------|------------|------------|------------|--------------|--------------|
| TC Data Sense | Hr (Tens) | Hr (Ones) | Min (Tens) | Min (Ones) | Sec (Tens) | Sec (Ones) | Frame (Tens) | Frame (Ones) |
| D8 | 3* | 3* | 3* | 3* | 3* | 3* | 3* | 3* |
| E.g. (01:23:45) | 30 | 31 | 32 | 33 | 34 | 35 | 30 | 30 |

E.g. : When remaining time for the current recording mode of the selected deck is 1 hr 23 min 45 sec.

Frame is fixed as 0.

• SEARCH SPEED

| | bit3 | bit2 | bit1 | bit0 |
|---------|------|------|------|------|
| STILL | 0 | 0 | 0 | 0 |
| x1 | 0 | 1 | 0 | 1 |
| x1.3 | 1 | 0 | 1 | 0 |
| SLOW1 | 0 | 0 | 0 | 1 |
| SLOW2 | 0 | 0 | 1 | 0 |
| SLOW3 | 0 | 0 | 1 | 1 |
| SLOW4 | 0 | 1 | 0 | 0 |
| SEARCH1 | 0 | 1 | 1 | 0 |
| SEARCH2 | 0 | 1 | 1 | 1 |
| SEARCH3 | 1 | 0 | 0 | 0 |
| SEARCH4 | 1 | 0 | 0 | 1 |
| SEARCH5 | 1 | 0 | 0 | 1 |

• CTL Data Sense

For acquiring lapse counter of selected deck in hours, minutes and seconds.

| | 1st Byte | 2nd Byte | 3rd Byte | 4th Byte | 5th Byte | 6th Byte | 7th Byte | 8th Byte |
|-----------------|-----------|-----------|------------|------------|------------|------------|--------------|--------------|
| CTL Data Sense | Hr (Tens) | Hr (Ones) | Min (Tens) | Min (Ones) | Sec (Tens) | Sec (Ones) | Frame (Tens) | Frame (Ones) |
| D9 | 3* | 3* | 3* | 3* | 3* | 3* | 3* | 3* |
| E.g. (01:23:45) | 30 | 31 | 32 | 33 | 34 | 35 | 30 | 30 |

E.g. : When time lapse counter is 1 hr 23 min 45 sec.

Frame is fixed as 0.

• JVC Status Sense

| | 1st Byte | 2nd Byte | 3rd Byte | 4th Byte |
|------|-----------|-------------------------------------|----------------------------------|----------------------------------|
| | HDD/BD/SD | HDD/BD/SD | HDD/BD/SD | HDD/BD/SD |
| bit7 | 1 (Fixed) | 0 (Fixed) | 1 (Fixed) | 1 (Fixed) |
| bit6 | 0 (Fixed) | 0 (Fixed) | 0 (Fixed) | 1 (Fixed) |
| bit5 | 0 (Fixed) | 1 (Fixed) | 0 (Fixed) | 0 (Fixed) |
| bit4 | 0 (Fixed) | 0 (Fixed) | 0 (Fixed) | 0 (Fixed) |
| bit3 | 0 (Fixed) | Refer to the DISC TYPE table below. | 0 (Fixed) | During dubbing (Including PAUSE) |
| bit2 | 0 (Fixed) | Refer to the DISC TYPE table below. | 0 (Fixed) | 0 (Fixed) |
| bit1 | 0 (Fixed) | Refer to the DISC TYPE table below. | 0 (Fixed) | 0 (Fixed) |
| bit0 | 1 (Fixed) | Refer to the DISC TYPE table below. | During dubbing (Including PAUSE) | 0 (Fixed) |

• DISC TYPE

| | bit3 | bit2 | bit1 | bit0 | | bit3 | bit2 | bit1 | bit0 |
|---------|------|------|------|------|---------|------|------|------|------|
| DVD | 0 | 0 | 0 | 0 | CD | 0 | 1 | 1 | 1 |
| DVD-RAM | 0 | 0 | 0 | 1 | BD-ROM | 1 | 0 | 0 | 0 |
| DVD-R | 0 | 0 | 1 | 0 | BD-R | 1 | 0 | 0 | 1 |
| DVD-RW | 0 | 0 | 1 | 1 | BD-RE | 1 | 0 | 1 | 0 |
| DVD+R | 0 | 0 | 0 | 0 | No disc | 1 | 1 | 1 | 1 |
| DVD+RW | 0 | 0 | 0 | 0 | Unknown | 1 | 1 | 1 | 0 |

When SD deck is selected, the values are fixed as bit3:0, bit2:0, bit1:1 and bit0:0.

Language Code List

| Code | Language | Code | Language | Code | Language |
|------|--------------------|------|--|------|----------------|
| AA | Afar | HI | Hindi | OS | Ossetian |
| AB | Abkhazian | HO | Hiri Motu | PA | Panjabi |
| AF | Afrikaans | HU | Hungarian | FA | Persian |
| AK | Akan | IG | Igbo | PI | Pali |
| SQ | Albanian | IS | Icelandic | PL | Polish |
| AM | Amharic | IO | Ido | PT | Portuguese |
| AR | Arabic | II | Sichuan Yi | PS | Pashto |
| AN | Aragonese | IU | Inuktitut | QU | Quechua |
| HY | Armenian | IE | Interlingue | RM | Rhaeto-Romance |
| AS | Assamese | IA | Interlingua (International Auxiliary language Association) | RO | Romanian |
| AV | Avar | ID | Indonesian | RN | Kirundi |
| AE | Avestan | IK | Inupiak | RU | Russian |
| AY | Aymara | IT | Italian | SG | Sango |
| AZ | Azerbaijani | JV | Javanese | SA | Sanskrit |
| BA | Bashkir | JA | Japanese | SR | Serbia |
| BM | Bambara | KL | Kalaallisut | HR | Croatian |
| EU | Basque | KN | Kannada | SI | Sinhala |
| BE | Belarusian | KS | Kashmiri | SK | Slovak |
| BN | Bengali | KR | Kanuri | SL | Slovenian |
| BH | Bihari | KK | Kazakh | SE | Northern Sami |
| BI | Bislama | KM | Khmer | SM | Samoan |
| BS | Bosnian | KI | Kikuyu | SN | Shona |
| BR | Breton | RW | Kinyarwanda | SD | Sindhi |
| BG | Bulgarian | KY | Kirghiz | SO | Somali |
| MY | Burmese | KV | Komi | ST | Southern Sotho |
| CA | Catalan, Valencian | KG | Kongo | ES | Spanish |
| CH | Chamorro | KO | Korean | SC | Sardinian |
| CE | Chechen | KJ | Kwanyama | SS | Swati |
| ZH | Chinese | KU | Kurukh | SU | Sundanese |
| CU | Church Slavic | LO | Lao | SW | Swahili |
| CV | Chuvash | LA | Latin | SV | Swedish |
| KW | Cornish | LV | Latvian | TY | Tahitian |
| CO | Corsican | LI | Limburchish | TA | Tamil |
| CR | Cree | LN | Lingala | TT | Tatar |
| CS | Czech | LT | Lithuanian | TE | Telugu |
| DA | Danish | LB | Luxembourgish | TG | Tajik |

| | | | | | |
|----|-----------------|----|-------------------|----|------------|
| DV | Divehi | LU | Luba-Katanga | TL | Tagalog |
| NL | Dutch | LG | Ganda | TH | Thai |
| DZ | Dzongkha | MK | Macedonian | BO | Tibetan |
| EN | English | MH | Marshallese | TI | Tigrinya |
| EO | Esperanto | ML | Malayalam | TO | Tongan |
| ET | Estonian | MI | Māori | TN | Tswana |
| EE | Ewe | MR | Marathi | TS | Tsonga |
| FO | Faroese | MS | Malay | TK | Turkmen |
| FJ | Fijian | MG | Malagasy | TR | Turkish |
| FI | Finnish | MT | Maltese | TW | Twi |
| FR | French | MO | Moldavian | UG | Uighur |
| FY | Western Frisian | MN | Mongolian | UK | Ukrainian |
| FF | Fulah | NA | Nauruan | UR | Urdu |
| KA | Georgian | NV | Navajo | UZ | Uzbek |
| DE | German | NR | South Ndebele | VE | Venda |
| GD | Scottish Gaelic | ND | North Ndebele | VI | Vietnamese |
| GA | Irish | NG | Ndonga | VO | Volapük |
| GL | Galician | NE | Nepali | CY | Welsh |
| GV | Manx | NN | Norwegian Nynorsk | WA | Walloon |
| EL | Greek | NB | Norwegian Bokmål | WO | Wolof |
| GN | Guaraní | NO | Norwegian | XH | Xhosa |
| GU | Gujarati | NY | Chichewa | YI | Yiddish |
| HT | Haitian | OC | Occitan | YO | Yoruba |
| HA | Hausa | OJ | Ojibwa | ZA | Zhuang |
| HE | Hebrew | OR | Oriya | ZU | Zulu |
| HZ | Herero | OM | Oromo | | |

Country Code List

| Code | Country Name | Code | Country Name | Code | Country Name |
|------|--------------------------|------|--|------|--------------------------------|
| AD | Andorra | GM | Gambia | NU | Niue |
| AE | United Arab Emirates | GN | Guinea | NZ | New Zealand |
| AF | Afghanistan | GP | Guadeloupe | OM | Oman |
| AG | Antigua and Barbuda | GQ | Equatorial Guinea | PA | Panama |
| AI | Anguilla | GR | Greece | PE | Peru |
| AL | Albania | GS | South Georgia and South Sandwich Islands | PF | Polynesia |
| AM | Armenia | GT | Guatemala | PG | Papua New Guinea |
| AN | Netherlands Antilles | GU | Guam | PH | Philippines |
| AO | Angola | GW | Guinea-Bissau | PK | Pakistan |
| AQ | Antarctica | GY | Guyana | PL | Poland |
| AR | Argentina | HK | Hong Kong | PM | Saint Pierre and Miquelon |
| AS | American Samoa | HM | Heard and McDonald Islands | PN | Pitcairn Islands |
| AT | Austria | HN | Honduras | PR | Puerto Rico |
| AU | Australia | HR | Croatia | PT | Portugal |
| AW | Aruba | HT | Haiti | PW | Palau |
| AZ | Azerbaijan | HU | Hungary | PY | Paraguay |
| BA | Bosnia and Herzegovina | ID | Indonesia | QA | Qatar |
| BB | Barbados | IE | Ireland | RE | Reunon Island |
| BD | Bangladesh | IL | Israel | RO | Romania |
| BE | Belgium | IN | India | RU | Russian Federation |
| BF | Burkina Faso | IO | British Indian Ocean Territory | RW | Rwanda |
| BG | Bulgaria | IQ | Iraq | SA | Saudi Arabia |
| BH | Bahrain | IR | Iran | SB | Solomon Islands |
| BI | Burundi | IS | Iceland | SC | Seychelles |
| BJ | Benin | IT | Italy | SD | Sudan |
| BM | Bermuda | JM | Jamaica | SE | Sweden |
| BN | Brunei | JO | Jordan | SG | Singapore |
| BO | Bolivia | JP | Japan | SH | Saint Helena |
| BR | Brazil | KE | Kenya | SI | Slovenia |
| BS | Bahamas | KG | Kyrgyzstan | SJ | Svalbard and Jan Mayen Islands |
| BT | Bhutan | KH | Cambodia | SK | Slovakia |
| BV | Bouvet Island | KI | Kiribati | SL | Sierra Leone |
| BW | Botswana | KM | Comoros | SM | San Marino |
| BY | Belarus | KN | Saint Kitts and Nevis | SN | Senegal |
| BZ | Belize | KP | Korea, Democratic People's Republic of | SO | Somalia |
| CA | Canada | KR | Korea, Republic of | SR | Suriname |
| CC | Cocos Islands | KW | Kuwait | ST | Sao Tome and Principe |
| CF | Central African Republic | KY | Cayman Islands | SV | El Salvador |
| CG | Congo, Republic of | KZ | Kazakhstan | SY | Syria |
| CH | Switzerland | LA | Laos | SZ | Swaziland |
| CI | Cote d'Ivoire | LB | Lebanon | TC | Turks and Caicos Islands |

| | | | | | |
|----|--|----|--------------------------|----|-------------------------------------|
| CK | Cook Islands | LC | Saint Lucia | TD | Chad |
| CL | Chile | LI | Liechtenstein | TF | French Southern Territories |
| CM | Cameroon | LK | Sri Lanka | TG | Togo |
| CN | China | LR | Liberia | TH | Thailand |
| CO | Colombia | LS | Lesotho | TJ | Tajikistan |
| CR | Costa Rica | LT | Lithuania | TK | Tokelau |
| CU | Cuba | LU | Luxembourg | TM | Turkmenistan |
| CV | Cape Verde | LV | Latvia | TN | Tunisia |
| CX | Christmas Island | LY | Libya | TO | Tonga |
| CY | Cyprus | MA | Morocco | TP | East Timor |
| CZ | Czech Republic | MC | Monaco | TR | Turkey |
| DE | Germany | MD | Moldova | TT | Trinidad and Tobago |
| DJ | Djibouti | MG | Madagascar | TV | Tuvalu |
| DK | Denmark | MH | Marshall Islands | TW | Taiwan |
| DM | Dominica, Commonwealth of | ML | Mali | TZ | Tanzania |
| DO | Dominican Republic | MM | Myanmar | UA | Ukraine |
| DZ | Algeria | MN | Mongolia | UG | Uganda |
| EC | Ecuador | MO | Macau | UM | Minor Outlying Islands |
| EE | Estonia | MP | Northern Mariana Islands | US | United States |
| EG | Egypt | MQ | Martinique | UY | Uruguay |
| EH | Western Sahara | MR | Mauritania | UZ | Uzbekistan |
| ER | Eritrea | MS | Montserrat | VA | Vatican |
| ES | Spain | MT | Malta | VC | Saint Vincent and the Grenadine |
| ET | Ethiopia | MU | Mauritius | VE | Venezuela |
| FI | Finland | MV | Maldives | VG | British Virgin Islands |
| FJ | Fiji | MW | Malawi | VI | Virgin Islands of the United States |
| FK | Falkland Islands (Malvinas) | MX | Mexico | VN | Vietnam |
| FM | Micronesia (Federated States of) | MY | Malaysia | VU | Vanuatu |
| FO | Faroe Islands | MZ | Mozambique | WF | Wallis and Futuna |
| FR | France | NA | Namibia | WS | Samoa |
| FX | France, Metropolitan | NC | New Caledonia | YE | Yemen |
| GA | Gabon | NE | Niger | YT | Mayotte |
| GB | United Kingdom of Great Britain and Northern Ireland | NF | Norfolk Island | YU | Yugoslavia |
| GD | Grenada | NG | Nigeria | ZA | South Africa |
| GE | Georgia | NI | Nicaragua | ZM | Zambia |
| GF | French Guiana | NL | Netherlands | ZR | Zaire |
| GH | Ghana | NO | Norway | ZW | Zimbabwe |
| GI | Gibraltar | NP | Nepal | | |
| GL | Greenland | NR | Nauru | | |

Using the HDMI Consumer Electronics Control (HDMI CEC)

HDMI Consumer Electronics Control

- By using an HDMI cable to connect this unit with a TV that supports the HDMI CEC standard, this unit and the TV can be linked and operated together.
- HDMI CEC (Consumer Electronics Control) is an industrial standard that allows HDMI devices to be linked and operated among each other by connecting them with an HDMI cable.

HDMI Consumer Electronics Control operations

- Perform the following operations when this unit is turned on, and the TV will switch automatically to the HDMI input that this unit is connected to.
 - Playback from HDD, BD/DVD or SD CARD
 - Press the [NAVIGATION] or [SET UP] button
- Turning off the power for the TV will also turn the power off for this unit automatically.
If HDD, BD/DVD or SD CARD is being used for dubbing, the power will be turned off after dubbing finishes.

Using HDMI Consumer Electronics Control (activating the function)

1 Connect this unit to a TV that is HDMI CEC compatible using an HDMI cable

2 Change the setting of “HDMI-CEC” to “ON”

- Check the monitor (TV) setting if the HDMI CEC function does not work.

Memo:

- If you are not using the HDMI CEC function (deactivating), change the setting of “HDMI-CEC” to “OFF”.

Note:

- The HDMI CEC function cannot be used if a TV that is not compatible with HDMI CEC has been connected.
- If an HDMI cable is not used for connecting, the HDMI CEC function will not be usable.

Creating a Seamless BD

When titles are imported into the HDD in the HD quality from a video camera, or when edited titles (e.g., after applying scene delete) are dubbed to a disc, seamless playback may not be possible at the joints of scenes. In this case, perform dubbing after executing “SEAMLESS” under the “MODE CHANGE” setting menu.

For details, refer to “Mode conversion” (page 81).

Creating a seamless BD that uses “MODE CONVERSION” (seamless conversion, recording mode conversion)

- Procedures to create a seamless BDMV

| File to import | If you do not want to perform scene delete/chapter delete | If you want to perform scene delete/chapter delete |
|-------------------|---|---|
| AVCHD | Recording mode conversion | - |
| MOV*/MXF* | Conversion not required | Seamless conversion |
| SD-VIDEO(HD)* HDV | Recording mode conversion after seamless conversion | Recording mode conversion after seamless conversion |

SD-VIDEO(HD)* : SD-VIDEO (JVC Everio MPEG2 TS)

MOV* : MOV format files recorded in the SP mode and HQ mode using the JVC ProHD MEMORY CARD CAMERA RECORDER GY-HM series

MXF* : MXF format files recorded in the SP mode and HQ mode using JVC ProHD MEMORY CARD CAMERA RECORDER GY-HM650

- Procedures to create a seamless BDAV

| File to import | If you do not want to perform scene delete/chapter delete | If you want to perform scene delete/chapter delete |
|-------------------|---|--|
| AVCHD | Conversion not required | - |
| MOV*/MXF* | Conversion not required | Seamless conversion |
| SD-VIDEO(HD)* HDV | Seamless conversion | Seamless conversion |

SD-VIDEO(HD)* : SD-VIDEO (JVC Everio MPEG2 TS)

MOV* : MOV format files recorded in the SP mode and HQ mode using the JVC ProHD MEMORY CARD CAMERA RECORDER GY-HM series

MXF* : MXF format files recorded in the SP mode and HQ mode using JVC ProHD MEMORY CARD CAMERA RECORDER GY-HM650

Memo:

- During dubbing to BDMV, the recording mode cannot be specified.
- Do not perform recording mode conversion before seamless conversion. Otherwise, seamless conversion cannot be performed.
- If scene delete or chapter delete is applied to a title, it cannot be dubbed to a BDMV disc without performing seamless conversion.
- For titles that are imported into the HDD in the SD picture quality, you can create a seamless DVD by setting “SEAMLESS PLAYBACK” under the “Setting Menu List” to “ON”, followed by performing re-encode dubbing.

For details, refer to “SEAMLESS PLAYBACK” (page 85).

Troubleshooting

| Problem | Symptom | Action | Reference Page |
|--|---|---|----------------|
| Power does not turn on | The "HELLO" message remains displayed, and the unit does not start up. | Press the [RESET] button on the front panel. If it does not start up, stop using this unit, unplug the plug from the outlet, and bring it to the dealer or Service Center. | (☞ page 16) |
| The cooling fan motor is not working | "FAN LOCKED" is displayed on the display window of this unit. | The cooling fan motor is spoiled. Stop using the unit, remove the power plug from the outlet, and consult the dealer or Service Center. | - |
| Power turns off automatically | The "AUTO POWER (OFF)" setting is set to "2 HOURS" or "6 HOURS". | Change the "AUTO POWER (OFF)" setting of "SETUP" to "OFF". | (☞ page 83) |
| | The temperature of this unit has rose, and operation has ceased for safety purposes. | Place this unit in an area with ventilation if possible, and wait approximately 30 minutes for it to cool down. | - |
| The power turns on automatically | The "HDMI-CEC" setting is set to "ON". | Change the "HDMI-CEC" setting of "CONNECTION" to "OFF". | (☞ page 89) |
| Input cannot be switched | i.LINK connection is currently being established. | Cancel importing, or wait until the connection ends. | (☞ page 41) |
| There are no video images on the monitor | Monitor only supports RGB input. | Set "HDMI --> DVI COLOR" in the setting menu to "RGB FIX". | (☞ page 89) |
| | "HDCP ERROR" is displayed. | Use a monitor that supports HDCP. | - |
| | Video images may be distorted during reencoding/dubbing when the monitor (TV) is connected to this unit using an HDMI cable, or when the screen resolution is set to "1080p". | This is not a malfunction. Change the "HDMI OUTPUT RESOLUTION" to a value other than "1080p" (e.g., 1080i) if you find it annoying. | (☞ page 89) |
| Screen is distorted | Video images may be distorted during reencoding/dubbing when the monitor (TV) is connected to this unit using an HDMI cable, or when the screen resolution is set to "1080p". | This is not a malfunction. Change the "HDMI OUTPUT RESOLUTION" to a value other than "1080p" (e.g., 1080i) if you find it annoying. | (☞ page 27) |
| There is no audio sound | The "HDMI AUDIO OUTPUT" setting is set to "OFF". | Change the "HDMI AUDIO OUTPUT" setting of "CONNECTION" to "ON". | (☞ page 89) |
| | The amplifier does not support "BITSTREAM" output. | Use an amplifier that supports bitstream output. | (☞ page 87) |
| Dubbing cannot be performed | The title to be dubbed is copyright protected. | Titles that are copyright-protected cannot be dubbed. Select a title that is not copyright-protected. | (☞ page 27) |
| | A finalized disc has been inserted. | Insert a disc that has not been finalized. | - |
| | The disc is not formatted. | Format the disc. | (☞ page 28) |
| | The SD card is write-protected. | Remove the SD card and remove the write protect lock. | (☞ page 30) |

Troubleshooting (Continued)

| Problem | Symptom | Action | Reference Page |
|---|--|---|------------------------|
| Dubbing cannot be performed | "NEXT" cannot be selected when a title that cannot be dubbed is chosen. | <ul style="list-style-type: none"> Dubbing may start when you return to recording mode selection to change the recording mode. Some titles cannot be dubbed depending on their recording mode and format. You can distinguish titles that cannot be dubbed by selecting the titles one by one. | (page 31) |
| | "NEXT" cannot be selected due to insufficient disc space. | <ul style="list-style-type: none"> Dubbing may start when you return to recording mode selection to change the recording mode. Dubbing may start after reducing the number of titles to be dubbed. Dubbing may start by switching to a dual-layer disc. | (page 31) |
| | "NEXT" cannot be selected as a dubbing title list is not created. | Select at least one content for dubbing. | (page 35) (page 45) |
| High-speed dubbing cannot be performed for EP mode titles | Dubbing cannot be performed and "SOME TITLES CANNOT BE DUBBED" is displayed when trying to perform high-speed dubbing of a EP mode title to a DVD-VIDEO mode disc. | Set "HIGH-SPEED DUBBING" in the settings menu to "4:3" before recording or importing in the EP mode. | (page 27) (page 85) |
| Data cannot be imported | The title to be dubbed is copyright protected. | Titles that are copyright-protected cannot be dubbed. Select a title that is not copyright-protected. | (page 27) |
| | The number of titles stored in the HDD has reached the maximum amount. | Delete or combine the titles in the HDD to reduce the amount of titles to less than 500. | (page 70) |
| | The remaining space on the HDD is running out. | Delete the titles in the HDD to increase the remaining space. | (page 70) |
| | "START" cannot be selected when a title that cannot be dubbed is chosen. | <ul style="list-style-type: none"> When importing data from a BD/DVD to the HDD, selection of "START" may be enabled after you return to recording mode selection to change the recording mode. Some titles cannot be dubbed depending on their recording mode and format. You can distinguish titles that cannot be dubbed by selecting the titles one by one. | (page 31) |
| | "START" cannot be selected due to insufficient HDD space or upon reaching the maximum number of titles in the HDD. | Delete unwanted titles from the HDD. Alternatively, format the HDD. | (page 70) (page 11) |
| | "START" cannot be selected as a dubbing title list is not created. | Select at least one content for dubbing. | (page 35) (page 40) |
| The title/group name cannot be changed | Protection of the title/group name is turned on. | Turn protection off for the title/group name. | (page 72) |

| Problem | Symptom | Action | Reference Page |
|--|--|--|----------------|
| The remote control unit does not work | The battery of the remote control unit has run out. | Change new batteries for the remote control. | (☞ page 19) |
| | The remote control code of this unit and the remote control unit are different from each other. | Change the "REMOTE CONTROL CODE" for the remote control to the same number used by this unit. | (☞ page 19) |
| | A "LOCKED" message appears on the display window of the unit. | Disable the "mode lock" setting. | (☞ page 91) |
| The disc cannot be ejected | A "LOCKED" message appears on the display window of the unit. | Disable the "tray lock" setting. | (☞ page 91) |
| | The "READING" message does not disappear from the unit's display window, and the disc tray does not open when the [▲] button is pressed. | Pressing the [▲] button at the front of the unit for five seconds or longer opens the disc tray. To close the disc tray after removing the disc, press the [⏻/] button, and wait until the tray is closed and power is turned off. (If the disc tray does not open after pressing the [▲] button for five seconds or longer, consult our authorized dealer.) | - |
| The disc cannot be played | A disc that cannot be played on this unit is inserted. | Confirm that the disc is playable on this unit. | (☞ page 13) |
| | The region code of the BD or DVD is different from that of this unit. | Confirm that the region number is playable on this unit. | (☞ page 13) |
| | An unfinalized DVD disc that is recorded using another device is inserted. | Use that device to finalize the disc. | - |
| Output is at "480i" (for NTSC) or "576i" (for PAL) regardless of the component output resolution setting | The component output setting may be changed to "480i" (for NTSC) or "576i" (for PAL) after viewing at a setting of 1080/24p using an HDMI connection. | Turn the power off, and turn it on again. | - |
| The aspect ratios of the HDMI output and component output are different | When two monitors are connected respectively to the HDMI output and component output terminals of this unit, the screen aspect ratio of the component output may not be appropriate if "VIDEO PRIORITY MODE" is set to "HDMI". | When two monitors are connected simultaneously, users are recommended to set "VIDEO PRIORITY MODE" to "COMPONENT". | (☞ page 88) |
| Mode Conversion cannot be performed although "SEAMLESS" in the "MODE CHANGE" menu is set to "AFTER POWER OFF" and the power is turned off. | Turning off the power may not start mode conversion even if "AFTER POWER OFF" in "SEAMLESS" is set and mode conversion is interrupted by the power being turned on while mode conversion is in progress. | Cancel mode conversion. | (☞ page 81) |

Frequently Asked Questions on Dubbing

| Problem | Symptom | Cause | Action | Reference Page |
|------------------------|--|--|--|---|
| Unable to dub from HDD | "SOME TITLES CANNOT BE DUBBED" is displayed. | <ul style="list-style-type: none"> Titles that cannot be dubbed at high speed are selected after "HIGH-SPEED DUBBING" has been selected at the recording mode selection. | <ul style="list-style-type: none"> Select a setting other than "HIGH-SPEED DUBBING" at the recording mode selection. Remove titles that cannot be dubbed at high speed from the dubbing title list. | (☞ page 44) (☞ page 45) Memo (☞ page 113) |
| | | <ul style="list-style-type: none"> Titles that are recorded using "XP/SP/LP/EP" mode are selected after "BDAV" has been selected as the disc format. | <ul style="list-style-type: none"> Change the disc format to DVD-VR or DVD-Video. For BDAV format, change the recording mode to "XP/SP/LP/EP". Remove titles that cannot be dubbed from the dubbing title list. | (☞ page 27) |
| | | <ul style="list-style-type: none"> The total recording time of the titles selected in the dubbing title list has exceeded the recordable capacity of the disc. | <ul style="list-style-type: none"> Select other recording mode at the recording mode selection. Reselect the titles in the dubbing title list such that the total recording time can fit within the recordable capacity of the disc. Change to a dual-layer disc. | (☞ page 31) |
| | | <ul style="list-style-type: none"> The total number of the selected titles in the dubbing title list and the recorded titles on the media to dub to has exceeded the limit. | <ul style="list-style-type: none"> Reselect the titles in the dubbing title list such that the total number of titles is within the allowable quantity of the media to dub to. | (☞ page 45) Memo (☞ page 113) |
| | | <ul style="list-style-type: none"> The total number of chapters of the selected titles in the dubbing title list and the recorded titles on the media to dub to has exceeded the limit. | <ul style="list-style-type: none"> Reselect the titles in the dubbing title list such that the total number of chapters is within the allowable quantity of the media to dub to. | (☞ page 75) Memo (☞ page 113) |
| | | <ul style="list-style-type: none"> Titles that are copyright-protected are selected. | <ul style="list-style-type: none"> Titles that are copyright-protected cannot be dubbed. | (☞ page 26) |
| | | <ul style="list-style-type: none"> An attempt has been made to dub titles with MPEG audio using the BDMV format. | <ul style="list-style-type: none"> Change the disc format to BDAV. Perform mode conversion of the title. | (☞ page 28) (☞ page 81) |
| | | <ul style="list-style-type: none"> An attempt has been made to dub EP mode titles, recorded with "VIDEO MODE RECORDING ASPECT" under "HIGH-SPEED DUBBING" in the settings menu set to a setting other than "4:3", to a DVD-Video format disc. | <ul style="list-style-type: none"> To dub EP mode titles, use titles that are recorded or imported with "VIDEO MODE RECORDING ASPECT" under "HIGH-SPEED DUBBING" in the settings menu set to "4:3". | (☞ page 85) |

Memo:

When "SOME TITLES CANNOT BE DUBBED" appears after selecting high-speed dubbing, check the followings.

- Titles that are copyright-protected cannot be dubbed.
- Titles that are recorded in a recording mode that does not support high-speed dubbing cannot be dubbed.
(When performing high-speed dubbing in DVD-Video format, titles recorded in a mode such as AF mode cannot be dubbed.)
- Content for which editing, such as deleting of scene, has been performed cannot be dubbed at high speed using BDMV format.
(High-speed dubbing is made possible by performing mode conversion.)
- There is a limit to the number of titles and chapters recordable depending on the type of disc and format used.

| | |
|-----------|--|
| DVD-Video | : Maximum 99 titles and 999 chapters (maximum 99 chapters per title) |
| DVD-VR | : Maximum 99 titles and 999 chapters (maximum 999 chapters per title) |
| BDAV | : Maximum 200 titles and 999 chapters (maximum 100 chapters per title) |
| BDMV | : Maximum 99 titles and 99 x 999 chapters |

| Problem | Symptom | Cause | Action | Reference Page |
|-------------------------|--|---|---|----------------|
| Unable to import to HDD | "SOME TITLES CANNOT BE DUBBED" is displayed. | • HDD memory is insufficient. | • Delete unwanted titles recorded in the HDD. | (☞ page 70) |
| | | • The amount of titles in the HDD has reached the maximum amount. | • Delete unwanted titles recorded in the HDD. • A maximum of 499 titles are recordable to the HDD. | (☞ page 70) |
| | | • Titles that are copyright-protected are selected. | • Titles that are copyright-protected cannot be imported. | (☞ page 26) |

Remarks

■ VIDEO output

When HD-quality contents are output from the [VIDEO] terminal, the resolution will deteriorate.

■ Image quality

When the video is down converted during playback, the image quality may be lowered.

Noise may appear at the bottom of the screen if the video is dubbed from DVC_pro.

Specifications

■ General

Power requirement

SR-HD1700US/SR-HD1350US:

AC 120 V \sim , 60 Hz

SR-HD1700EU/SR-HD1350EU/SR-HD1700ER/
SR-HD1700AG:

AC 220 V - 240 V \sim , 50 Hz / 60 Hz

Power consumption

Power on : 36 W

Power off : 0.5 W

Laser specification

For CD

Wavelength : 779 nm to 789 nm

Output : No hazardous radiation is emitted with the safety protection.

For DVD

Wavelength : 656 nm to 663 nm

Output : No hazardous radiation is emitted with the safety protection.

For BD

Wavelength : 400 nm to 410 nm

Output : No hazardous radiation is emitted with the safety protection.

Temperature

Operating : 5 °C to 35 °C (41 °F to 95 °F)

Storage : -20 °C to 60 °C (-4 °F to 140 °F)

Operating position : Horizontal only

Dimensions : 435 mm x 70 mm x 351 mm
(W x H x D) (17-1/10" x 2-6/8" x 13-13/16")

Weight : 4.9 kg (10.8 lbs)

■ Input/Output

Video input : 1.0 V(p-p), 75 Ω (BNC)

Video output : 1.0 V(p-p), 75 Ω (BNC)

Audio input : Max 2 Vrms / 10 kΩ (pin jack)

Audio output : 2 Vrms / 10 kΩ terminated (pin jack)

S-video input

Y : 1.0 V(p-p), 75 Ω

C : SR-HD1700US/SR-HD1350US:
0.3 V(p-p), 75 Ω
SR-HD1700EU/SR-HD1350EU/
SR-HD1700ER/SR-HD1700AG:
0.286 V(p-p), 75 Ω

S-video output

Y : 1.0 V(p-p), 75 Ω

C : SR-HD1700US/SR-HD1350US:
0.3 V(p-p), 75 Ω
SR-HD1700EU/SR-HD1350EU/
SR-HD1700ER/SR-HD1700AG:
0.286 V(p-p), 75 Ω

DV : 4-pin for HDV/DV IN

Remote Input : ϕ 3.5 mm Jack

Serial Command : D-SUB 9-PIN

Component video output:

Y : 1.0 V(p-p), 75 Ω

CB/CR, PB/PR : 0.7 V(p-p), 75 Ω

LAN : 10BASE-T/100BASE-TX

Memo:

- Corresponding to copy protection
- Only SR-HD1700 is equipped with the LAN terminal.

Digital audio output:

Optical : PCM, AAC, Dolby Digital and DTS

HDMI output

19-pin type A

(Deep Color, x.v.Color, Ver1.3)

USB terminal

USB2.0

■ SD memory card

SD, SDHC

■ HDD Deck

500 GB (SR-HD1700)

320 GB (SR-HD1350)

Recording compression system

Video

MPEG2 (VBR)

H.264/AVC

Audio

Dolby Digital (2 ch)

Linear PCM (2ch, XP mode only)

MPEG1 Audio Layer2 (recorded in 2ch)

■ BD/DVD Deck

Recording compression system

Video

MPEG2 (CBR/VBR)

H.264/AVC

Audio

Dolby Digital (2 ch)

Linear PCM (2ch, XP mode only)

MPEG1 Audio Layer2 (recorded in 2ch)

Region code

BD : Region *1

DVD : *2

*1: SR-HD1700US/SR-HD1350US/SR-HD1700AG: A,
SR-HD1700EU/SR-HD1350EU: B, SR-HD1700ER: C

*2: SR-HD1700US/SR-HD1350US: 1,
SR-HD1700EU/SR-HD1350EU: 2, SR-HD1700AG: 3,
SR-HD1700ER: 5

■ ACCESSORIES

Provided accessories

- AC power cord (SR-HD1700US/SR-HD1350US/
SR-HD1700ER/SR-HD1700AG)
- AC power cord x 2 (for continental Europe, U.K.)
(SR-HD1700EU/SR-HD1350EU)
- Infrared remote control unit
- "AA" battery x 2
- CD-ROM

Design and specifications subject to change without notice.

Important Notice Concerning the Software

Software License Attached to the Product

The Software embedded in the Product is composed of several independent software components, and in each of such individual components, a copyright of either JVC KENWOOD or a third party subsists.

The Product uses the software component designated in the End-User License Agreement that was executed between JVC KENWOOD and a third party (hereinafter "EULA").

"EULA" covers those corresponding to free software, and, as a condition of distribution of the software component in executable format which is based on the license granted under the GNU General Public License or Lesser General Public License (hereinafter "GPL/LGPL"), it requires an availability of the source code for the relevant component. For details of the software component covered by "GPL/LGPL", please visit the following website:

URL : <http://www3.jvckenwood.com/english/download/gpl/index.html>

Please note that we are unable to answer any inquiry relating to the contents, etc. of the source code.

Please note that any software component licensed under "EULA" which is not subject to "GPL/LGPL", and those developed or created independently by JVC KENWOOD shall not be subject to the requirement for provision of the source code.

The software component distributed under "GPL/LGPL" shall be licensed to users without charge, and, therefore, no warranty is given for such software component, either express or implied, within the scope of the applicable laws and regulations. Unless otherwise permitted by applicable laws and regulations or agreed in written form, none of the owners of the copyright or persons entitled to alter or redistribute the software component under the said license shall have any liability for any type of damage or loss resulting from the use of or inability to use such software component. For further details of the conditions of use of such software component or matters required to be complied with, please refer to the relevant "GPL/LGPL".

Users are urged to read the details for the relevant license carefully before using the software component covered by "GPL/LGPL" and embedded in the Product. Since the terms and conditions of individual licenses are provided by parties other than JVC KENWOOD, the original English version will be included.

Important Notice Concerning the Software (continued)

GNU GENERAL PUBLIC LICENSE Version 2, June 1991

Copyright (C) 1989, 1991 Free Software Foundation, Inc.
51 Franklin Street, Fifth Floor, Boston, MA 02110-1301 USA

Everyone is permitted to copy and distribute verbatim copies of this license document, but changing it is not allowed.

Preamble

The licenses for most software are designed to take away your freedom to share and change it. By contrast, the GNU General Public License is intended to guarantee your freedom to share and change free software—to make sure the software is free for all its users. This General Public License applies to most of the Free Software Foundation's software and to any other program whose authors commit to using it. (Some other Free Software Foundation software is covered by the GNU Lesser General Public License instead.) You can apply it to your programs, too.

When we speak of free software, we are referring to freedom, not price. Our General Public Licenses are designed to make sure that you have the freedom to distribute copies of free software (and charge for this service if you wish), that you receive source code or can get it if you want it, that you can change the software or use pieces of it in new free programs; and that you know you can do these things.

To protect your rights, we need to make restrictions that forbid anyone to deny you these rights or to ask you to surrender the rights.

These restrictions translate to certain responsibilities for you if you distribute copies of the software, or if you modify it.

For example, if you distribute copies of such a program, whether gratis or for a fee, you must give the recipients all the rights that you have. You must make sure that they, too, receive or can get the source code. And you must show them these terms so they know their rights.

We protect your rights with two steps: (1) copyright the software, and (2) offer you this license, which gives you legal permission to copy, distribute and/or modify the software.

Also, for each author's protection and ours, we want to make certain that everyone understands that there is no warranty for this free software. If the software is modified by someone else and passed on, we want its recipients to know that what they have is not the original, so that any problems introduced by others will not reflect on the original authors' reputations.

Finally, any free program is threatened constantly by software patents. We wish to avoid the danger that redistributors of a free program will individually obtain patent licenses, in effect making the program proprietary. To prevent this, we have made it clear that any patent must be licensed for everyone's free use or not licensed at all.

The precise terms and conditions for copying, distribution and modification follow.

GNU GENERAL PUBLIC LICENSE TERMS AND CONDITIONS FOR COPYING, DISTRIBUTION AND MODIFICATION

0. This License applies to any program or other work which contains a notice placed by the copyright holder saying it may be distributed under the terms of this General Public License. The "Program", below, refers to any such program or work, and a "work based on the Program" means either the Program or any derivative work under copyright law; that is to say, a work containing the Program or a portion of it, either verbatim or with modifications and/or translated into another language. (Hereinafter, translation is included without limitation in the term "modification".) Each licensee is addressed as "you".

Activities other than copying, distribution and modification are not covered by this License; they are outside its scope. The act of running the Program is not restricted, and the output from the Program is covered only if its contents constitute a work based on the Program (independent of having been made by running the Program). Whether that is true depends on what the Program does.

1. You may copy and distribute verbatim copies of the Program's source code as you receive it, in any medium, provided that you conspicuously and appropriately publish on each copy an appropriate copyright notice and disclaimer of warranty, keep intact all the notices that refer to this License and to the absence of any warranty, and give any other recipients of the Program a copy of this License along with the Program.

You may charge a fee for the physical act of transferring a copy, and you may at your option offer warranty protection in exchange for a fee.

2. You may modify your copy or copies of the Program or any portion of it, thus forming a work based on the Program, and copy and distribute such modifications or work under the terms of Section 1 above, provided that you also meet all of these conditions:

a) You must cause the modified files to carry prominent notices stating that you changed the files and the date of any change.

b) You must cause any work that you distribute or publish, that in whole or in part contains or is derived from the Program or any part thereof, to be licensed as a whole at no charge to all third parties under the terms of this License.

c) If the modified program normally reads commands interactively when run, you must cause it, when started running for such interactive use in the most ordinary way, to print or display an announcement including an appropriate copyright notice and a notice that there is no warranty (or else, saying that you provide a warranty) and that users may redistribute the program under these conditions, and telling the user how to view a copy of this License.

(Exception: if the Program itself is interactive but does not normally print such an announcement, your work based on the Program is not required to print an announcement.)

These requirements apply to the modified work as a whole. If identifiable sections of that work are not derived from the Program, and can be reasonably considered independent and separate works in themselves, then this License, and its terms, do not apply to those sections when you distribute them as separate works. But when you distribute the same sections as part of a whole which is a work based on the Program, the distribution of the whole must be on the terms of this License, whose permissions for other licensees extend to the entire whole, and thus to each and every part, regardless of who wrote it.

Thus, it is not the intent of this section to claim rights or contest your rights to work written entirely by you; rather, the intent is to exercise the right to control the distribution of derivative or collective works based on the Program.

In addition, mere aggregation of another work not based on the Program with the Program (or with a work based on the Program) on a volume of a storage or distribution medium does not bring the other work under the scope of this License.

3. You may copy and distribute the Program (or a work based on it, under Section 2) in object code or executable form under the terms of Sections 1 and 2 above provided that you also do one of the following:

a) Accompany it with the complete corresponding machine-readable source code, which must be distributed under the terms of Sections 1 and 2 above on a medium customarily used for software interchange; or,

b) Accompany it with a written offer, valid for at least three years, to give any third party, for a charge no more than your cost of physically performing source distribution, a complete copy of the source code for all modules it contains, to be distributed under the terms of Sections 1 and 2 above on a medium customarily used for software interchange; or,

c) Accompany it with the information you received as to the location of the distributing source code. (This alternative is allowed only for noncommercial distribution and only if you received the program in object code or executable form with such an offer, in accord with Subsection b above.)

The source code for a work means the preferred form of the work for making modifications to it. For an executable work, complete source code means all the source code for all modules it contains, plus any associated interface definition files, plus the scripts used to control compilation and installation of the executable. However, as a special exception, the source code distributed need not include anything that is normally distributed (in either source or binary form) with the major components (compiler, kernel, and so on) of the operating system on which the executable runs, unless that component itself accompanies the executable.

If distribution of executable or object code is made by offering access to copy from a designated place, then offering equivalent access to copy the source code from the same place counts as distribution of the source code, even though third parties are not compelled to copy the source code along with the object code.

4. You may not copy, modify, sublicense, or distribute the Program except as expressly provided under this License. Any attempt otherwise to copy, modify, sublicense or distribute the Program is void, and will automatically terminate your rights under this License. However, parties who have received copies, or rights, from you under this License will not have their licenses terminated so long as such parties remain in full compliance.

5. You are not required to accept this License, since you have not signed it. However, nothing else grants you permission to modify or distribute the Program or its derivative works. These actions are prohibited by law if you do not accept this License. Therefore, by modifying or distributing the Program (or any work based on the Program), you indicate your acceptance of this License to do so, and all its terms and conditions for copying, distributing or modifying the Program or works based on it.

6. Each time you redistribute the Program (or any work based on the Program), the recipient automatically receives a license from the original licensor to copy, distribute or modify the Program subject to these terms and conditions. You may not impose any further restrictions on the recipients' exercise of the rights granted herein. You are not responsible for enforcing compliance by third parties to this License.

7. If, as a consequence of a court judgment or allegation of patent infringement or for any other reason (not limited to patent issues), conditions are imposed on you (whether by court order, agreement or otherwise) that contradict the conditions of this License, they do not excuse you from the conditions of this License. If you cannot distribute so as to satisfy simultaneously your obligations under this License and any other pertinent obligations, then as a consequence you may not distribute the Program at all. For example, if a patent license would not permit royalty-free redistribution of the Program by all those who receive copies directly or indirectly through you, then the only way you could satisfy both it and this License would be to refrain entirely from distribution of the Program.

If any portion of this section is held invalid or unenforceable under any particular circumstance, the balance of the section is intended to apply and the section as a whole is intended to apply in other circumstances.

It is not the purpose of this section to induce you to infringe any patents or other property right claims or to contest validity of any such claims; this section has the sole purpose of protecting the integrity of the free software distribution system, which is implemented by the public license practices. Many people have made generous contributions to the wide range of software distributed through that system in reliance on consistent application of that system; it is up to the author/donor to decide if he or she is willing to distribute software through any other system and a licensee cannot impose that choice.

This section is intended to make thoroughly clear what is believed to be a consequence of the rest of this License.

8. If the distribution and/or use of the Program is restricted in certain countries either by patents or by copyrighted interfaces, the original copyright holder who places the Program under this License may add an explicit geographical distribution limitation excluding those countries, so that distribution is permitted only in or among countries not thus excluded. In such case, this License incorporates the limitation as if written in the body of this License.

9. The Free Software Foundation may publish revised and/or new versions of the General Public License from time to time. Such new versions will be similar in spirit to the present version, but may differ in detail to address new problems or concerns.

Each version is given a distinguishing version number. If the Program specifies a version number of this License which applies to it and "any later version", you have the option of following the terms and conditions either of that version or of any later version published by the Free Software Foundation. If the Program does not specify a version number of this License, you may choose any version ever published by the Free Software Foundation.

10. If you wish to incorporate parts of the Program into other free programs whose distribution conditions are different, write to the author to ask for permission. For software which is copyrighted by the Free Software Foundation, write to the Free Software Foundation; we sometimes make exceptions for this. Our decision will be guided by the two goals of preserving the free status of all derivatives of our free software and of promoting the sharing and reuse of software generally.

NO WARRANTY

11. BECAUSE THE PROGRAM IS LICENSED FREE OF CHARGE, THERE IS NO WARRANTY FOR THE PROGRAM, TO THE EXTENT PERMITTED BY APPLICABLE LAW. EXCEPT WHEN OTHERWISE STATED IN WRITING, THE COPYRIGHT HOLDERS AND/OR OTHER PARTIES PROVIDE THE PROGRAM "AS IS" WITHOUT WARRANTY OF ANY KIND, EITHER EXPRESSED OR IMPLIED, INCLUDING, BUT NOT LIMITED TO, THE IMPLIED WARRANTIES OF MERCHANTABILITY AND FITNESS FOR A PARTICULAR PURPOSE. THE ENTIRE RISK AS TO THE QUALITY AND PERFORMANCE OF THE PROGRAM IS WITH YOU. SHOULD THE PROGRAM PROVE DEFECTIVE, YOU ASSUME THE COST OF ALL NECESSARY SERVICING, REPAIR OR CORRECTION.

12. IN NO EVENT UNLESS REQUIRED BY APPLICABLE LAW OR AGREED TO IN WRITING WILL ANY COPYRIGHT HOLDER, OR ANY OTHER PARTY WHO MAY MODIFY AND/OR REDISTRIBUTE THE PROGRAM AS PERMITTED ABOVE, BE LIABLE TO YOU FOR DAMAGES, INCLUDING ANY GENERAL, SPECIAL, INCIDENTAL OR CONSEQUENTIAL DAMAGES ARISING OUT OF THE USE OR INABILITY TO USE THE PROGRAM (INCLUDING BUT NOT LIMITED TO LOSS OF DATA OR DATA BEING RENDERED INACCURATE OR LOSSES SUSTAINED BY YOU OR THIRD PARTIES OR A FAILURE OF THE PROGRAM TO OPERATE WITH ANY OTHER PROGRAMS), EVEN IF SUCH HOLDER OR OTHER PARTY HAS BEEN ADVISED OF THE POSSIBILITY OF SUCH DAMAGES.

Important Notice Concerning the Software (continued)

END OF TERMS AND CONDITIONS

How to Apply These Terms to Your New Programs

If you develop a new program, and you want it to be of the greatest possible use to the public, the best way to achieve this is to make it free software which everyone can redistribute and change under these terms.

To do so, attach the following notices to the program. It is safest to attach them to the start of each source file to most effectively convey the exclusion of warranty; and each file should have at least the "copyright" line and a pointer to where the full notice is found.

<one line to give the program's name and a brief idea of what it does.>

Copyright (C) <year> <name of author>

This program is free software; you can redistribute it and/or modify it under the terms of the GNU General Public License as published by the Free Software Foundation; either version 2 of the License, or (at your option) any later version.

This program is distributed in the hope that it will be useful, but WITHOUT ANY WARRANTY; without even the implied warranty of MERCHANTABILITY or FITNESS FOR A PARTICULAR PURPOSE. See the GNU General Public License for more details.

You should have received a copy of the GNU General Public License along with this program; if not, write to the Free Software Foundation, Inc., 51 Franklin Street, Fifth Floor, Boston, MA 02110-1301 USA

Also add information on how to contact you by electronic and paper mail.

If the program is interactive, make it output a short notice like this when it starts in an interactive mode:

```
Gnomovision comes 69 Copyright (C) year name of author
Gnomovision comes with ABSOLUTELY NO WARRANTY; for
details type `show w'.
```

This is free software, and you are welcome to redistribute it under certain conditions; type `show c' for details.

The hypothetical commands `show w' and `show c' should show the appropriate parts of the General Public License. Of course, the commands you use may be called something other than `show w' and `show c'; they could even be mouse-clicks or menu items—whatever suits your program.

You should also get your employer (if you work as a programmer) or your school, if any, to sign a "copyright disclaimer" for the program, if necessary. Here is a sample; alter the names:

```
Yoyodyne, Inc., hereby disclaims all copyright interest in the
program `Gnomovision' (which makes passes at compilers)
written by James Hacker.
```

```
<signature of Ty Coon>, 1 April 1989
Ty Coon, President of Vice
```

This General Public License does not permit incorporating your program into proprietary programs. If your program is a subroutine library, you may consider it more useful to permit linking proprietary applications with the library. If this is what you want to do, use the GNU Lesser General Public License instead of this License.

GNU LESSER GENERAL PUBLIC LICENSE

Version 2.1, February 1999

Copyright (C) 1989, 1991 Free Software Foundation, Inc., 51 Franklin Street, Fifth Floor, Boston, MA 02110-1301 USA

Everyone is permitted to copy and distribute verbatim copies of this license document, but changing it is not allowed.

[This is the first released version of the Lesser GPL. It also counts as the successor of the GNU Library Public License, version 2, hence the version number 2.1.]

These disadvantages are the reason we use the ordinary General Public License for many libraries. However, the Lesser license provides advantages in certain special circumstances.

For example, on rare occasions, there may be a special need to encourage the widest possible use of a certain library, so that it becomes a de-facto standard. To achieve this, non-free programs must be allowed to use the library. A more frequent case is that a free library does the same job as widely used non-free libraries. In this case, there is little to gain by limiting the free library to free software only, so we use the Lesser General Public License.

In other cases, permission to use a particular library in non-free programs enables a greater number of people to use a large body of free software. For example, permission to use the GNU C Library in non-free programs enables many more people to use the whole GNU operating system, as well as its variant, the GNU/Linux operating system.

Although the Lesser General Public License is less protective of the users' freedom, it does ensure that the user of a program that is linked with the library has the freedom and the wherewithal to run that program using a modified version of the library.

The precise terms and conditions for copying, distribution and modification follow. Pay close attention to the difference between a "work based on the library" and a "work that uses the library". The former contains code derived from the library, whereas the latter must be combined with the library in order to run.

GNU LESSER GENERAL PUBLIC LICENSE TERMS AND CONDITIONS FOR COPYING, DISTRIBUTION AND MODIFICATION

0. This License Agreement applies to any software library or other program which contains a notice placed by the copyright holder or other authorized party saying it may be distributed under the terms of this Lesser General Public License (also called "this License"). Each licensee is addressed as "you".

A "library" means a collection of software functions and/or data prepared so as to be conveniently linked with application programs (which use some of those functions and data) to form executables.

The "library" below, refers to any such software library or work which has been distributed under these terms. A "work based on the library" means either the library or any derivative work under copyright law; that is to say, a work containing the library or a portion of it, either verbatim or with modifications and/or translated straightforwardly into another language. (Hereinafter, translation is included without limitation in the term "modification".)

"Source code" for a work means the preferred form of the work for making modifications to it. For a library, complete source code means all the source code for all modules it contains, plus any associated interface definition files, plus the scripts used to control compilation and installation of the library.

Activities other than copying, distribution and modification are not covered by this License; they are outside its scope. The act of running a program using the Library is not restricted, and output from such a program is covered only if its contents constitute a work based on the Library (independent of the use of the Library in a tool for writing it). Whether that is true depends on what the Library does and what the program that uses the Library does.

1. You may copy and distribute verbatim copies of the Library's complete source code as you receive it, in any medium, provided that you conspicuously and appropriately publish on each copy an appropriate copyright notice and disclaimer of warranty; keep intact all the notices that refer to this License and to the absence of any warranty; and distribute a copy of this License along with the Library.

You may charge a fee for the physical act of transferring a copy, and you may at your option offer warranty protection in exchange for a fee.

2. You may modify your copy or copies of the Library or any portion of it, thus forming a work based on the Library, and copy and distribute such modifications or work under the terms of Section 1 above, provided that you also meet all of these conditions:

a) The modified work must itself be a software library.

b) You must cause the files modified to carry prominent notices stating that you changed the files and the date of any change.

c) You must cause the whole of the work to be licensed at no charge to all third parties under the terms of this License.

d) If a facility in the modified Library refers to a function or a table of data to be supplied by an application program that uses the facility, other than as an argument passed when the facility is invoked, then you must make a good faith effort to ensure that, in the event an application does not supply such function or table, the facility still operates, and performs whatever part of its purpose remains meaningful.

(For example, a function in a library to compute square roots has a purpose that is entirely well-defined independent of the application. Therefore, Subsection 2d requires that any application-supplied function or table used by this function must be optional: if the application does not supply it, the square root function must still compute square roots.)

These requirements apply to the modified work as a whole. If identifiable sections of that work are not derived from the Library, and can be reasonably considered independent and separate works in themselves, then this License, and its terms, do not apply to those sections when you distribute them as separate works. But when you distribute the same sections as part of a whole which is a work based on the Library, the distribution of the whole must be on the terms of this License, whose permissions for other licensees extend to the entire whole, and thus to each and every part regardless of who wrote it.

Thus, it is not the intent of this section to claim rights or contest your rights to work written entirely by you; rather, the intent is to exercise the right to control the distribution of derivative or collective works based on the Library.

In addition, mere aggregation of another work not based on the Library with the Library (or with a work based on the Library) on a volume of a storage or distribution medium does not bring the other work under the scope of this License.

3. You may opt to apply the terms of the ordinary GNU General Public License instead of this License to a given copy of the Library. To do this, you must alter all the notices that refer to this License, so that they refer to the ordinary GNU General Public License, version 2, instead of to this License. (If a newer version than version 2 of the ordinary GNU General Public License has appeared, then you can specify that version instead if you wish.) Do not make any other change in these notices.

Once this change is made in a given copy, it is irreversible for that copy, so the ordinary GNU General Public License applies to all subsequent copies and derivative works made from that copy. This option is useful when you wish to copy part of the code of the Library into a program that is not a library.

4. You may copy and distribute the Library (or a portion or derivative of it, under Section 2) in object code or executable form under the terms of Sections 1 and 2 above provided that you accompany it with the complete corresponding machine-readable source code, which must be distributed under the terms of Sections 1 and 2 above on a medium customarily used for software interchange.

If distribution of object code is made by offering access to copy from a designated place, then offering equivalent access to copy the source code from the same place satisfies the requirement to distribute the source code, even though third parties are not compelled to copy the source along with the object code.

Important Notice Concerning the Software (continued)

5. A program that contains no derivative of any portion of the Library, but is designed to work with the Library by being compiled or linked with it, is called a "work that uses the Library". Such a work, in isolation, is not a derivative work of the Library, and therefore falls outside the scope of this License.

However, linking a "work that uses the Library" with the Library creates an executable that is a derivative of the Library (because it contains portions of the Library), rather than a "work that uses the Library". The executable is therefore covered by this License. Section 6 states terms for distribution of such executables.

When a "work that uses the Library" uses material from a header file that is part of the Library, the object code for the work may be a derivative work of the Library, even though the source code is not. Whether this is true is especially significant if the work can be linked without the Library, or if the work is itself a library. The threshold for this to be true is not precisely defined by law.

If such an object file uses only numerical parameters, data structure layouts and accessors, and small macros and small inline functions (ten lines or less in length), then the use of the object file is unrestricted, regardless of whether it is legally a derivative work. (Executables containing this object code plus portions of the Library will still fall under Section 6.)

Otherwise, if the work is a derivative of the Library, you may distribute the object code for the work under the terms of Section 6. Any executables containing that work also fall under Section 6, whether or not they are linked directly with the Library itself.

6. As an exception to the Sections above, you may also combine or link a "work that uses the Library" with the Library to produce a work containing portions of the Library, and distribute that work under terms of your choice, provided that the terms permit modification of the work for the customer's own use and reverse engineering for debugging such modifications.

You must give prominent notice with each copy of the work that the Library is used in it and that the Library and its use are covered by this License. You must supply a copy of this License, if the work during execution displays copyright notices, you must include the copyright notice for the Library among them, as well as a reference directing the user to the copy of this License. Also, you must do one of these things:

- Accompany the work with the complete corresponding machine-readable source code for the Library including whatever changes were used in the work (which must be distributed under Sections 1 and 2 above); and, if the work is an executable linked with the Library, with the complete machine-readable "work that uses the Library", as object code and/or source code, so that the user can modify the Library and then relink to produce a modified executable containing the modified Library. (It is understood that the user who changes the contents of definitions files in the Library will not necessarily be able to recompilate the application to use the modified definitions.)
- Use a suitable shared library mechanism for linking with the Library. A suitable mechanism is one that: (1) uses at run time a copy of the library already present on the user's computer system, rather than copying library functions into the executable; and (2) will operate properly with a modified version of the library, if the user installs one, as long as the modified version is interface-compatible with the version that the work was made with.

7. Accompany the work with a written offer, valid for at least three years, to give the same user the materials specified in Subsection 6a, above, for a charge no more than the cost of performing this distribution.

d) If distribution of the work is made by offering access to copy from a designated place, offer equivalent access to copy the above-specified materials from the same place.

e) Verify that the user has already received a copy of these materials or that you have already sent this user a copy.

For an executable, the required form of the "work that uses the Library" must include any data and utility programs needed for reproducing the executable from it. However, as a special exception, the materials to be distributed need not include anything that is normally distributed (in either source or binary form) with the major components (compiler, kernel, and so on) of the operating system on which the executable runs, unless that component itself accompanies the executable.

It may happen that this requirement contradicts the license restrictions of other proprietary libraries that do not normally accompany the operating system. Such a contradiction means you cannot use both them and the Library together in an executable that you distribute.

7. You may place library facilities that are a work based on the Library side-by-side in a single library together with other library facilities not covered by this License, and distribute such a combined library, provided that the separate distribution of the work based on the Library and of the other library facilities is otherwise permitted, and provided that you do these two things:

- Accompany the combined library with a copy of the same work based on the Library, uncombined with any other library facilities. This must be distributed under the terms of the Sections above.
- Give prominent notice with the combined library of the fact that part of it is a work based on the Library, and explaining where to find the accompanying uncombined form of the same work.

8. You may not copy, modify, sublicense, link with, or distribute the Library except as expressly provided under this License. Any attempt otherwise to copy, modify, sublicense, link with, or distribute the Library is void, and will automatically terminate your rights under this License. However, parties who have received their copies or rights from you under this License will not have their copies or rights terminated so long as such parties remain in full compliance.

9. You are not required to accept this License, since you have not signed it. However, nothing else grants you permission to modify or distribute the Library or its derivative works. These actions are prohibited by law if you do not accept this License. Therefore, by modifying or distributing the Library (or any work based on the Library), you indicate your acceptance of this License to do so, and all its terms and conditions for copying, distributing or modifying the Library or works based on it.

10. Each time you redistribute the Library (or any work based on the Library), the recipient automatically receives a license from the original licensor to copy, distribute, link with or modify the Library subject to these terms and conditions. You may not impose any further restrictions on the recipients' exercise of the rights granted herein. You are not responsible for enforcing compliance by third parties with this License.

11. If, as a consequence of a court judgment or allegation of patent infringement or for any other reason (not limited to patent issues), conditions are imposed on you (whether by court order, agreement or otherwise) that contradict the conditions of this License, they do not excuse you from the conditions of this License. If you cannot distribute so as to satisfy simultaneously your obligations under this License and any other pertinent obligations, then as a consequence you may not distribute the Library at all. For example, if a patent license would not permit royalty-free redistribution of the Library by all those who receive copies directly or indirectly through you, then the only way you could satisfy both it and this License would be to refrain entirely from distribution of the Library.

If any portion of this section is held invalid or unenforceable under any particular circumstance, the balance of the section is intended to apply, and the section as a whole is intended to apply in other circumstances.

It is not the purpose of this section to induce you to infringe any patents or other property right claims or to contest validity of any such claims; this section has the sole purpose of protecting the integrity of the free software distribution system which is implemented by public license practices. Many people have made generous contributions to the wide range of software distributed through that system in reliance on consistent application of that system; it is up to the author/donor to decide if he or she is willing to distribute software through any other system and a licensee cannot impose that choice.

This section is intended to make thoroughly clear what is believed to be a consequence of the rest of this License.

12. If the distribution and/or use of the Library is restricted in certain countries either by patents or by copyrighted interfaces, the original copyright holder who places the Library under this License may add an explicit geographical distribution limitation excluding those countries, so that distribution is permitted only in or among countries not thus excluded. In such case, this License incorporates the limitation as if written in the body of this License.

13. The Free Software Foundation may publish revised and/or new versions of the Lesser General Public License from time to time. Such new versions will be similar in spirit to the present version, but may differ in detail to address new problems or concerns.

Each version is given a distinguishing version number. If the Library specifies a version number of this License, which applies to it and "any later version", you have the option of following the terms and conditions either of that version or of any later version published by the Free Software Foundation. If the Library does not specify a license version number, you may choose any version ever published by the Free Software Foundation.

14. If you wish to incorporate parts of the Library into other free programs whose distribution conditions are incompatible with these, write to the author to ask for permission. For software which is copyrighted by the Free Software Foundation, write to the Free Software Foundation; we sometimes make exceptions for this. Our decision will be guided by the two goals of preserving the free status of all derivatives of our free software and of promoting the sharing and reuse of software generally.

NO WARRANTY

15. BECAUSE THE LIBRARY IS LICENSED FREE OF CHARGE, THERE IS NO WARRANTY FOR THE LIBRARY, TO THE EXTENT PERMITTED BY APPLICABLE LAW, EXCEPT WHEN OTHERWISE STATED IN WRITING THE COPYRIGHT HOLDERS AND/OR OTHER PARTIES PROVIDE THE LIBRARY "AS IS" WITHOUT WARRANTY OF ANY KIND, EITHER EXPRESSED OR IMPLIED, INCLUDING, BUT NOT LIMITED TO, THE IMPLIED WARRANTIES OF MERCHANTABILITY AND FITNESS FOR A PARTICULAR PURPOSE. THE ENTIRE RISK AS TO THE QUALITY AND PERFORMANCE OF THE LIBRARY IS WITH YOU. SHOULD THE LIBRARY PROVE DEFECTIVE, YOU ASSUME THE COST OF ALL NECESSARY SERVICING, REPAIR OR CORRECTION.

16. IN NO EVENT UNLESS REQUIRED BY APPLICABLE LAW OR AGREED TO IN WRITING WILL ANY COPYRIGHT HOLDER, OR ANY OTHER PARTY WHO MAY MODIFY AND/OR REDISTRIBUTE THE LIBRARY AS PERMITTED ABOVE, BE LIABLE TO YOU FOR DAMAGES, INCLUDING ANY GENERAL, SPECIAL, INCIDENTAL OR CONSEQUENTIAL DAMAGES ARISING OUT OF THE USE OR INABILITY TO USE THE LIBRARY (INCLUDING BUT NOT LIMITED TO LOSS OF DATA OR DATA BEING RENDERED INACCURATE OR LOSSES SUSTAINED BY YOU OR THIRD PARTIES OR A FAILURE OF THE LIBRARY TO OPERATE WITH ANY OTHER SOFTWARE), EVEN IF SUCH HOLDER OR OTHER PARTY HAS BEEN ADVISED OF THE POSSIBILITY OF SUCH DAMAGES.

END OF TERMS AND CONDITIONS
How to Apply These Terms to Your New Libraries
 If you develop a new library, and you want it to be of the greatest possible use to the public, we recommend making it free software that everyone can redistribute and change. You can do so by permitting redistribution under these terms (or, alternatively, under the terms of the ordinary General Public License).

To apply these terms, attach the following notices to the library. It is safest to attach them to the start of each source file to most effectively convey the exclusion of warranty, and each file should have at least the "copyright" line and a pointer to where the full notice is found.

<one line to give the library's name and a brief idea of what it does.>

Copyright (C) <year> <name of author>

This library is free software; you can redistribute it and/or modify it under the terms of the GNU Lesser General Public License as published by the Free Software Foundation; either version 2.1 of the License, or (at your option) any later version.

This library is distributed in the hope that it will be useful, but WITHOUT ANY WARRANTY; without even the implied warranty of MERCHANTABILITY or FITNESS FOR A PARTICULAR PURPOSE. See the GNU Lesser General Public License for more details.

You should have received a copy of the GNU Lesser General Public License along with this library; if not, write to the Free Software Foundation, Inc., 51 Franklin Street, Fifth Floor, Boston, MA 02110-1301 USA

Also add information on how to contact you by electronic and paper mail.

You should also get your employer (if you work as a programmer) or your school, if any, to sign a "copyright disclaimer" for the library, if necessary. Here is a sample; alter the names:

Yoodyne, Inc., hereby disclaims all copyright interest in the library 'Frob' (a library for tweaking knobs) written by James Random Hacker.

<signature of Ty Coon>, 1 April 1990

Ty Coon, President of Vice

That's all there is to it!

Index

- A** AACs 10
 AUDIO CABLE 17, 21, 20
 AUDIO LANGUAGE 63, 84, 99
 AUDIO/SUBTITLE SETTINGS 63
 AUTO MARKING 86
- B** BD (BD-R/BD-RE) 12, 13, 28, 44, 65, 103
 BD MIX SOUND 87
 BD VIDEO DATA 12
 BDAV 12, 13, 27
 BDMV 12, 13, 27
 BD-ROM 13, 63, 103
 BD-VIDEO RATINGS 84
 BLUE BACK 88
- C** CHANGE ANGLE 63
 CHANGE AUDIO OUTPUT 63
 CHANGE CHAPTER 63
 CHAPTER EDIT 57, 75
 CHAPTER MARK 19, 58, 75, 76
 COMPONENT OUTPUT 90
 COMPONENT VIDEO CABLE 17, 20
 CONNECTION 20, 21, 22, 88
 COUNTRY CODE LIST 84, 106
- D** DATE DISPLAY STYLE 24, 83
 DETAIL SETTING 64
 DIGITAL NOISE REDUCTION 64
 DIMMER (POWER ON) 83
 DISPLAY WINDOW 16, 17, 91
 Dolby Digital 85, 86
 Dolby Digital Plus/TrueHD 87
 DTS 13, 87
 DTS-HD 87
 DUAL DISC 14
 DVD (DVD-R/DVD-RW)
 12, 13, 26, 28, 34, 44, 51, 60, 65, 80, 103
 DVD VIDEO 13, 27, 34, 36, 84
- F** FINALIZE 13, 46, 49, 65
- H** HDMI 17, 88, 89
 HDMI AUDIO OUTPUT 89
 HDMI CABLE 17, 20, 108
 HDMI OUTPUT RESOLUTION 89
 HDMI-CEC 89, 108
 HIGH-SPEED DUBBING 13, 26, 27, 44, 85
- I** i.LINK 16, 21, 26, 41
- J** JPEG 27, 37, 39, 47, 62
- L** LANGUAGE CODE 84, 104
 LOCKING THE DISC TRAY 91
- M** MENU LANGUAGE 84
 MODE LOCK 91
 MPEG2 12
- O** ON-SCREEN 15, 88
 OPTICAL 17, 21, 87
 OSD LANGUAGE 88
- P** PICTURE QUALITY 26, 31, 45, 64
 PLAYBACK NAVIGATION 18, 48, 55
 PLAYBACK SETTINGS 19, 59, 63, 84
 PROGRESSIVE OUTPUT 64
- R** RECORDING MODE 16, 18, 26, 27, 31, 53, 57, 97
 REGION CODE 13
 REMOTE CONTROL 16, 17, 18, 19, 91
 REMOTE CONTROL CODE 19, 83
 RESUME POINT 58, 60, 61, 85
 RS-232C 17, 22, 93
- S** SCREEN SAVER 88
 SEAMLESS PLAYBACK 85
 SETTING THE DATE/TIME 23
 SUBTITLE LANGUAGE 63, 84
 S-VIDEO 17, 20, 21, 90
- T** TIME DISPLAY STYLE 25, 83
- U** USB 16, 21, 26, 37
- V** VIDEO CABLE 17, 20
 VIDEO INPUT SETTING 90
 VIDEO MODE 12, 13, 85
 VIDEO SETTINGS 64
 VR MODE 12, 13

SR-HD1700US/SR-HD1350US/
SR-HD1700EU/SR-HD1350EU/
SR-HD1700ER/SR-HD1700AG
BLU-RAY DISC & HDD RECORDER

JVC