

# JVC



## DVD DIGITAL THEATER SYSTEM

# TH-P3

Consists of XV-THP3, SP-WP5,  
SP-THP3F, SP-THP3C and SP-THP3S

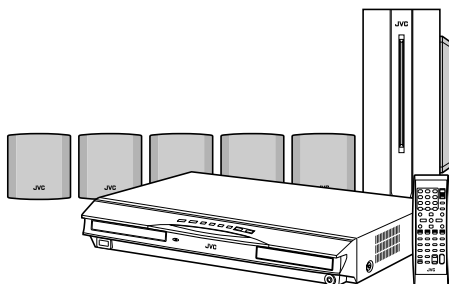

**MPEG-4**  
ASF PLAYBACK

**DVD**  
VIDEO

COMPACT  
**disc**  
SUPER VIDEO

**DOLBY**  
DIGITAL  
PRO LOGIC II

DIGITAL  
**dts**  
SURROUND

**DIVX**

**DIVX**  
ULTRA

*Digital Direct Progressive Scan*

## INSTRUCTIONS

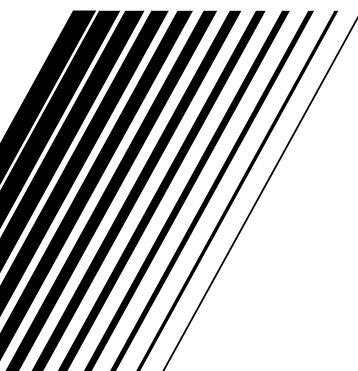

LVT1523-014A  
[UJ]

# Warnings, Cautions and Others

## CAUTION

To reduce the risk of electrical shocks, fire, etc.:

1. Do not remove screws, covers or cabinet.
2. Do not expose this appliance to rain or moisture.

## CAUTION— $\phi$ /I button!

Disconnect the mains plug to shut the power off completely (the STANDBY lamp goes off). When installing the apparatus, ensure that the plug is easily accessible.

The  $\phi$ /I button in any position does not disconnect the mains line.

- When the system is on standby, the STANDBY lamp lights red.
- When the system is turned on, the STANDBY lamp goes off.

The power can be remote controlled.

## CAUTION

- Do not block the ventilation openings or holes. (If the ventilation openings or holes are blocked by a newspaper or cloth, etc., the heat may not be able to get out.)
- Do not place any naked flame sources, such as lighted candles, on the apparatus.
- When discarding batteries, environmental problems must be considered and local rules or laws governing the disposal of these batteries must be followed strictly.
- Do not expose this apparatus to rain, moisture, dripping or splashing and that no objects filled with liquids, such as vases, shall be placed on the apparatus.

## IMPORTANT FOR LASER PRODUCTS

1. CLASS 1 LASER PRODUCT
2. **CAUTION:** Do not open the top cover. There are no user serviceable parts inside the unit; leave all servicing to qualified service personnel.
3. **CAUTION:** Visible and/or invisible class 1M laser radiation when open. Do not view directly with optical instruments.

### Caution: Proper Ventilation

To avoid risk of electric shock and fire and to protect from damage, place the apparatus on a level surface. The minimal clearances are shown below:

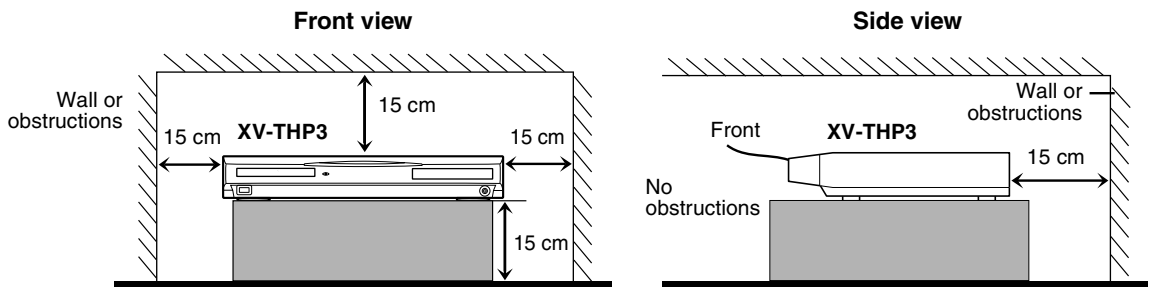

[European Union only]

# Table of contents

---

<b>Introduction .....</b>	<b>2</b>	<b>Playback .....</b>	<b>15</b>
Notes on handling .....	2	Basic Playback .....	15
Supplied accessories .....	2	One Touch Replay .....	17
<b>About discs .....</b>	<b>3</b>	Fast-forward/fast-reverse search .....	17
Playable disc types .....	3	Skip to the beginning of a desired selection .....	17
Playable file types .....	4	Skipping at about 5-minute intervals.....	18
<b>Index of parts and controls .....</b>	<b>5</b>	Locating a desired title/group using number buttons ....	18
<b>Connections .....</b>	<b>7</b>	Selecting the desired title/playlist from the control display .....	18
Connecting the FM and AM antennas .....	7	<b>Advanced operations .....</b>	<b>19</b>
Connecting the satellite (front, center, surround) speakers and the subwoofer .....	8	Using the surround mode .....	19
Speaker layout .....	9	Using the on-screen bar .....	21
Connecting a TV .....	9	Playing from a specified position on a disc .....	22
Connecting an external component.....	10	Using the file control display .....	24
Connecting a USB mass storage class device .....	10	Resume Playback .....	25
Connecting the power cord .....	10	Selecting a view angle .....	25
<b>Operating the TV .....</b>	<b>11</b>	Selecting the subtitle .....	26
<b>Basic operations .....</b>	<b>12</b>	Selecting the audio .....	26
Turning the system on/off .....	12	Special picture playback .....	27
Selecting the source to play .....	13	Program Playback .....	28
Adjusting the volume [VOLUME] .....	13	Random Playback .....	28
Listening with headphones (not supplied) .....	13	Repeat Playback .....	29
Turning off the sound temporarily [MUTING] .....	13	Tray lock .....	30
Adjusting the brightness of the indications [DIMMER] .....	13	Sound and other settings .....	30
Sleep Timer [SLEEP] .....	14	<b>Setting DVD preferences .....</b>	<b>31</b>
Adjusting the output level of the front/center/surround speakers and subwoofer .....	14	Using the setup menus .....	31
Changing the scan mode .....	14	Menu description .....	31
		<b>Tuner operations .....</b>	<b>34</b>
		Setting the AM tuner interval spacing.....	34
		Manual tuning .....	34
		Preset tuning .....	35
		Selecting the FM reception mode .....	35
		<b>References .....</b>	<b>36</b>
		Maintenance .....	36
		Troubleshooting .....	36
		Specifications .....	37

# Introduction

## Notes on handling

### ■ Important cautions

#### Installation of the system

- Select a place which is level, dry and neither too hot nor too cold; between 5°C and 35°C.
- Leave sufficient distance between the system and the TV.
- Do not use the system in a place subject to vibration.

#### Power cord

- Do not handle the power cord with wet hands.
- A small amount of power is always consumed while the power cord is connected to the wall outlet.
- When unplugging the power cord from the wall outlet, always pull on the plug, not the power cord.

#### To prevent malfunctions of the system

- There are no user-serviceable parts inside. If anything goes wrong, unplug the power cord and consult your dealer.
- Do not insert any metallic object into the system.
- Do not use any non-standard shape disc (like a heart, flower or credit card, etc.) available on the market, because it may damage the system.
- Do not use a disc with tape, stickers, or paste on it, because it may damage the system.

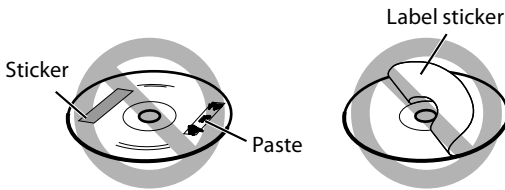

#### Note about copyright laws

Check the copyright laws in your country before recording from the discs. Recording of copyrighted material may infringe copyright laws.

#### Note about copyguard system

The discs are protected by copyguard system. When you connect the system to your VCR directly, the copyguard system activates and the picture may not be played back correctly.

### ■ Safety precautions

#### Avoid moisture, water and dust

Do not place the system in moist or dusty places.

#### Avoid high temperatures

Do not expose the system to direct sunlight and do not place it near a heating device.

#### When you are away

When away on travel or for other reasons for an extended period of time, disconnect the power cord plug from the wall outlet.

#### Do not block the vents

Blocking the vents may damage the system.

#### Care of the cabinet

When cleaning the system, use a soft cloth and follow the relevant instructions on the use of chemically-coated cloths. Do not use benzene, thinner or other organic solvents including disinfectants. These may cause deformation or discoloring.

#### If water gets inside the system

Turn the system off and disconnect the power cord plug from the wall outlet, then call the store where you made your purchase. Using the system in this condition may cause a fire or electrical shock.

## Supplied accessories

Check to be sure you have all of the supplied accessories. The number in parentheses is the quantity of the pieces supplied.





If anything is missing, contact your dealer immediately.

- Remote control (1)
- Batteries (2)
- FM antenna (1)
- AM loop antenna (1)
- Composite Video cord (1)
- AC plug adapter

# About discs

## Playable disc types

This system has been designed to play back the following discs:

DVD VIDEO	Audio CD
	
VCD	SVCD
	

The ✓ in the list below shows available disc types and recording formats.

Disc type Recording format	Disc type		
	CD-R/-RW* <sup>1</sup>	DVD-R* <sup>1</sup>	DVD-RW* <sup>1</sup>
DVD Video	—	✓	✓
DVD VR	—	✓	✓
VCD/SVCD	✓	—	—
Audio CD	✓	—	—
MP3	✓	✓* <sup>2</sup>	✓* <sup>2</sup>
WMA	✓	✓* <sup>2</sup>	✓* <sup>2</sup>
JPEG	✓	✓* <sup>2</sup>	✓* <sup>2</sup>
ASF	✓	✓* <sup>2</sup>	✓* <sup>2</sup>
MPEG-2	✓* <sup>3</sup>	✓* <sup>2</sup>	✓* <sup>2</sup>
MPEG-1	✓* <sup>3</sup>	✓* <sup>2</sup>	✓* <sup>2</sup>
DivX	✓	✓* <sup>2</sup>	✓* <sup>2</sup>

\*<sup>1</sup> This system can play finalized discs only.

\*<sup>2</sup> Recorded with UDF Bridge format.

\*<sup>3</sup> This system may not be able to play back a file if the file size is too large.

- It is possible to play back finalized +R/+RW (DVD Video Format only) discs. “DVD” lights on the display panel when a +R/+RW disc is loaded.
- This system accommodates the NTSC and PAL system. When you play an NTSC disc with the scan mode set to “PAL” (see page 14), the NTSC video signal is converted to the PAL60 signal and output.
- The Non-DVD side of a “DualDisc” does not comply with the “Compact Disc Digital Audio” standard. Therefore, the use of Non-DVD side of a DualDisc on this product may not be recommended.
- **On some DVD VIDEOS, VCDs or SVCDs, their actual operation may be different from what is explained in this manual. This is due to the disc programming and disc structure, not a malfunction of this system.**

DVD Logo is a trademark of DVD Format/Logo Licensing Corporation.

### Notes on DVD-R and DVD-RW

- This system does not support “multi-border” disc.

### Notes on CD-R and CD-RW

- This system can play CD-Rs or CD-RWs recorded with ISO 9660 format.
- This system supports “multi-session” discs (up to 20 sessions).
- This system cannot play “packet write” discs.

### Region code of DVD VIDEO

DVD VIDEO players and DVD VIDEO discs have their own Region Code numbers. This system can play back DVD VIDEO discs whose Region Code numbers include the system’s Region Code, which is indicated on the rear panel.

- Example of playable DVD:



If a DVD with an improper Region Code number is loaded, “REGION CODE ERROR!” appears on the TV screen and playback cannot start.

Some discs may not be played back because of their disc characteristics, recording conditions, or damage or stain on them.

### Unplayable discs

DVD-ROM, DVD-RAM, CD-I (CD-I Ready), Photo CD, SACD, etc.

Playing back these discs will generate noise and damage the speakers.

### Playable file types

#### For all playable files

- The system can only recognize and play files with one of the following extensions, which can be in any combination of upper and lower case:  
**MP3:** “.MP3”, “.mp3”  
**WMA:** “.WMA”, “.wma”  
**JPEG:** “.JPG”, “.JPEG”, “.jpg”, “.jpeg”  
**ASF:** “.ASF”, “.asf”  
**MPEG-2/MPEG-1:** “.MPG”, “.MPEG”, “.mpg”, “.mpeg”  
**DivX:** “.DIVX”, “.DIV”, “.divx”, “.div”, and “.AVI”, “.avi”
- The system recognizes up to 150 tracks (files) per group, 99 groups per disc/device, and the total number of the tracks (files) that the system can play is 4000.
- Some files may not be played back normally because of their disc characteristics or recording conditions.
- MP3/WMA/JPEG/ASF/MPEG-2/MPEG-1/DivX files require a longer readout time. (It differs due to the complexity of the directory/file configuration.)
- If different kinds of files are mixed, set the FILE TYPE setting in the PICTURE menu to the appropriate setting for the data to be read (“AUDIO”, “STILL PICTURE” or “VIDEO”). (See page 32.)

#### For MP3/WMA files

- The system supports MP3/WMA files recorded with a bit rate of 32 – 320 kbps and a sampling frequency of 16 kHz, 22.05 kHz, 24 kHz\*, 32 kHz, 44.1 kHz, or 48 kHz.
- If the track information (album name, artist, and track title, etc.) is recorded, it appears in the file control display on the TV screen. (See page 24.)
- We recommend to record each piece of material (song) at a sample rate of 44.1 kHz and at a data transfer rate of 128 (96\*) kbps.  
\* For WMA only

#### For JPEG files

- We recommend to record a file at 640 x 480 resolution. (If a file has been recorded at a resolution of more than 640 x 480, it will take a longer time to be displayed.)
- This system can only play baseline JPEG files.

#### For ASF files

- The system supports the types of the advanced simple profile as MPEG-4 files (MPEG-4 ASF).
- The system supports MPEG-4 files with the following conditions:  
File format: ASF  
Visual profile: MPEG-4 SP (Simple Profile)  
Audio CODEC: G.726  
Max. picture size: 352 x 288 (CIF)  
Max. bit rate: 384 kbps

#### For MPEG-2/MPEG-1 files

- The stream format should conform to MPEG system/program stream.
- 720 x 576 pixels (25 fps)/720 x 480 pixels (30 fps) is recommended for the highest resolution.
- This system also supports the resolutions of 352 x 576/480 x 576/352 x 288 pixels (25 fps) and 352 x 480/480 x 480/352 x 240 pixels (30 fps).
- The file format should be MP@ML (Main Profile at Main Level)/SP@ML (Simple Profile at Main Level)/MP@LL (Main Profile at Low Level).
- Audio streams should conform to MPEG1 Audio Layer-2 or MPEG2 Audio Layer-2.

#### For DivX files

- The system supports DivX 6.x, 5.x, 4.x and 3.11.
- The system supports DivX files whose resolution is 720 x 480 pixels or less (30 fps), and 720 x 576 pixels or less (25 fps).
- Audio stream should conform to Dolby Digital (including multi channel) or MPEG1 Audio Layer-3 (MP3).
- The system does not support GMC (Global Motion Compression).
- The file encoded in the interlaced scanning mode may not be played back correctly.
- The system has its own Registration Code for DivX playback.  
If necessary, you can confirm the Registration Code of your system using the OTHERS menu. (See page 33.)

- This product incorporates copyright protection technology that is protected by U.S. patents and other intellectual property rights. Use of this copyright protection technology must be authorized by Macrovision, and is intended for home and other limited viewing uses only unless otherwise authorized by Macrovision. Reverse engineering or disassembly is prohibited.
- “CONSUMERS SHOULD NOTE THAT NOT ALL HIGH DEFINITION TELEVISION SETS ARE FULLY COMPATIBLE WITH THIS PRODUCT AND MAY CAUSE ARTIFACTS TO BE DISPLAYED IN THE PICTURE. IN CASE OF 525 OR 625 PROGRESSIVE SCAN PICTURE PROBLEMS, IT IS RECOMMENDED THAT THE USER SWITCH THE CONNECTION TO THE ‘STANDARD DEFINITION’ OUTPUT.

IF THERE ARE QUESTIONS REGARDING OUR TV SET COMPATIBILITY WITH THIS MODEL 525p AND 625p DVD PLAYER, PLEASE CONTACT OUR CUSTOMER SERVICE CENTER.”

- USE OF THIS PRODUCT IN ANY MANNER THAT COMPLIES WITH THE MPEG-4 VISUAL STANDARD IS PROHIBITED, EXCEPT FOR USE BY A CONSUMER ENGAGING IN PERSONAL AND NON-COMMERCIAL ACTIVITIES.
- DivX, DivX Ultra Certified, and associated logos are trademarks of DivX, Inc. and are used under license.
- Official DivX® Ultra Certified product
- Plays all versions of DivX® video (including DivX® 6) with enhanced playback of DivX® media files and the DivX® Media Format

# Index of parts and controls

The numbers in the figures indicate the pages where the details of the parts are described.

## Front panel (center unit)

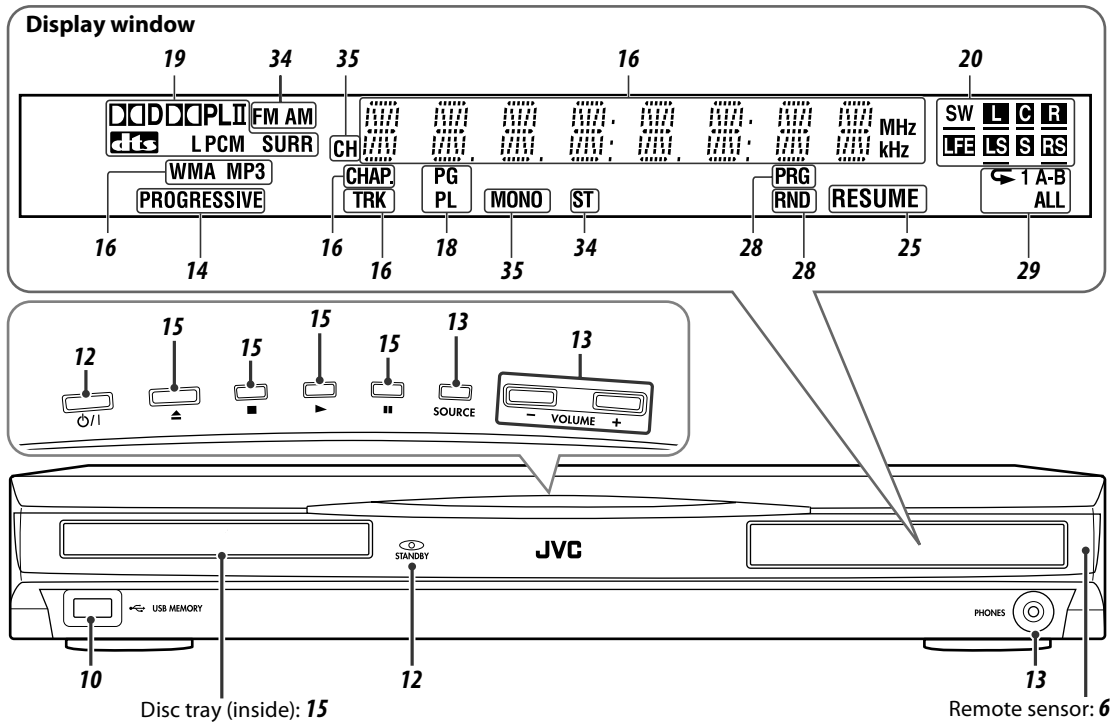

## Rear panel (center unit)

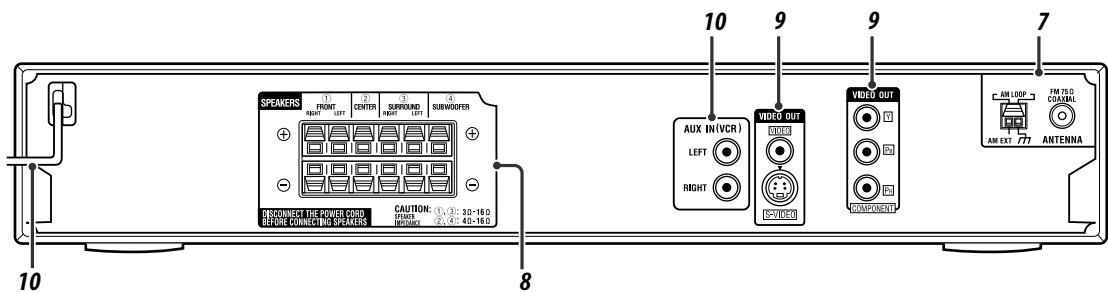

# Index of parts and controls

## Remote control

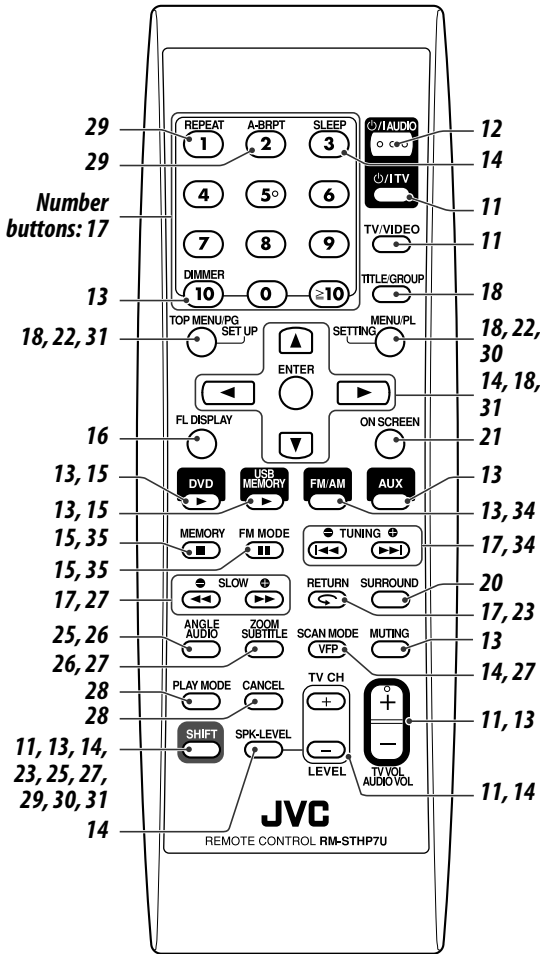

## Putting batteries in the remote control

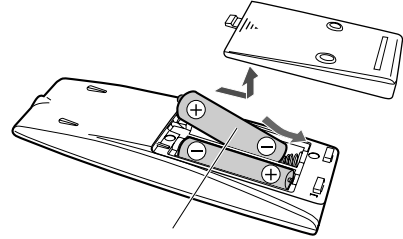

R6P (SUM-3)/AA (15F) type dry-cell batteries (supplied)

If the range or effectiveness of the remote control decreases, replace both batteries.

### CAUTION

- Do not expose batteries to heat or flame.

## Operating the system from the remote control

Aim the remote control directly to the front panel of the center unit.

- Do not block the remote sensor.



## Connecting the FM and AM antennas

### ■ AM loop antenna

#### Setting up supplied AM loop antenna

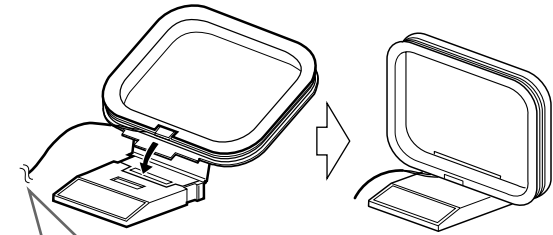

 If the antenna cord is covered with the insulation coat, twist and pull the insulation coat off and remove.

#### Connecting AM loop antenna

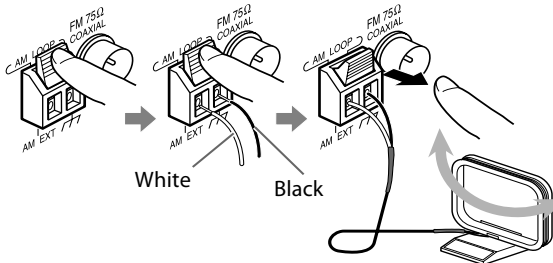

- Turn the loop antenna until you have the best reception during AM broadcast program reception.

#### NOTE

- Make sure the antenna conductors do not touch any other terminals, connecting cords or power cords. This could cause poor reception.

#### If reception is poor

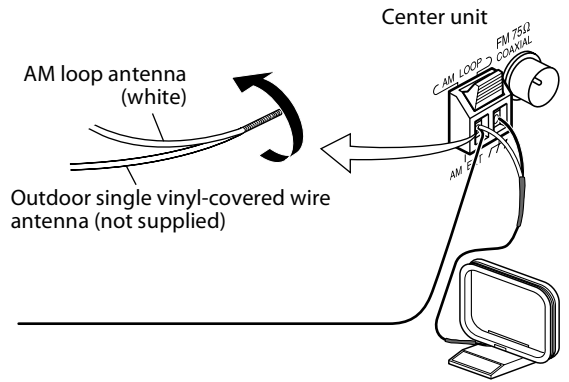

### ■ FM antenna

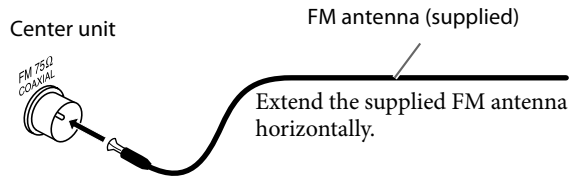

#### If reception is poor

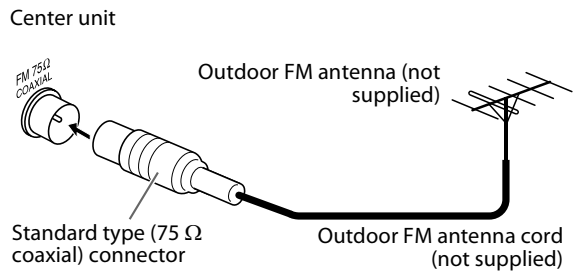

#### NOTE

- We recommend that you use coaxial cable for the FM antenna as it is well-shielded against interference.

# Connecting the satellite (front, center, surround) speakers and the subwoofer

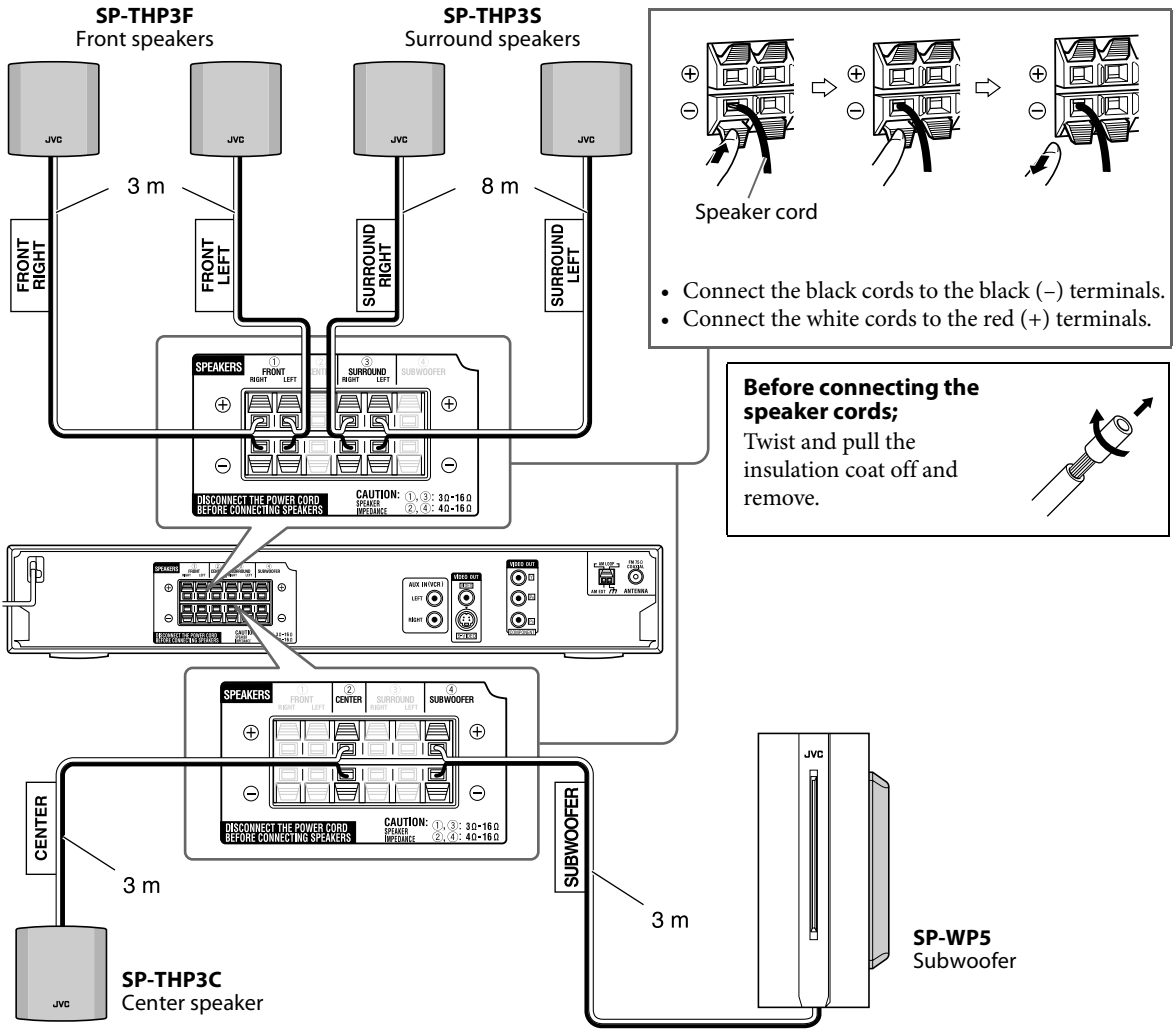

**CAUTION**

- If you connect speakers other than the supplied ones, use speakers of the same speaker impedance (SPEAKER IMPEDANCE) indicated on the rear of the center unit.
- DO NOT connect more than one speaker to one speaker terminal.
- When installing the satellite speakers on the wall;
  - Be sure to have them installed on the wall by qualified personnel.
  - DO NOT install the satellite speakers on the wall by yourself to avoid unexpected damage from falling off the wall due to incorrect installation or weakness in wall structure.
  - Care must be taken in selecting a location for speaker installation on a wall. Injury to personnel or damage to equipment may result if the speakers installed interfere with daily activities.

**Precautions for daily use**

- When moving the speakers, do not pull the speaker cords; otherwise, the speakers may fall over, causing damage or injury.
- Do not reproduce sounds at so high a volume that the sound is distorted; otherwise, the speakers may be damaged by internal heat buildup.

## Speaker layout

To obtain the best possible sound from this system, you need to place all the speakers except the subwoofer at the same distance from the listening position.

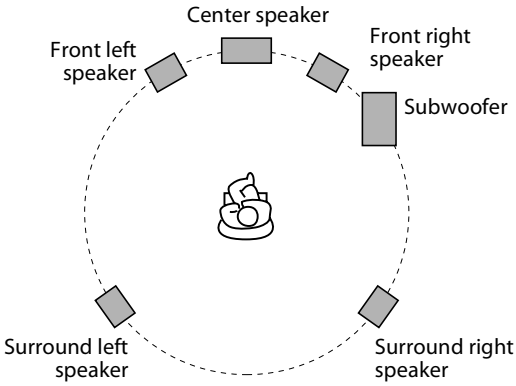

### If your speakers cannot be placed at the same distance from the listening position

You can adjust the delay time of the speakers. See “Delay menu (DELAY)” on page 32.

#### NOTE

- Place the satellite speakers on a flat and level surface.
- The front and center speakers are magnetically shielded to avoid color distortions on TVs. However, if not installed properly, they may cause color distortions. So, pay attention to the following when installing the speakers.
  - When placing the speakers near a TV set, turn off the TV’s main power switch or unplug it before installing the speakers. Then wait at least 30 minutes before turning on the TV’s main power switch again.

Some TVs may still be affected even though you have followed the above. If this happens, move the speakers away from the TV.

- The surround speakers and the subwoofer are not magnetically shielded. If they are located nearby the TV or monitor, it will probably cause color distortion on the screen. To avoid this, do not place the speakers nearby the TV or monitor.
- Be sure to place the subwoofer to the TV’s right. If you place the subwoofer to the TV’s left, keep sufficient distance between them to prevent the TV screen from appearing mottled.

## Connecting a TV

- You can get better picture quality in the order — Component video > S-video > Composite video.
- Distortion of picture may occur when connecting the TV via a VCR, or to a TV with a built-in VCR.
- You need to set “MONITOR TYPE” in the PICTURE menu correctly according to the aspect ratio of your TV. (See page 31.)

### ■ To connect a TV equipped with the component video input jacks

If your TV supports progressive video input, you can enjoy a high quality picture by setting the progressive scan mode to active. (See page 14.)

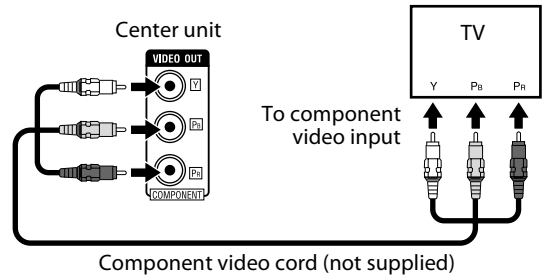

#### NOTE

- If the component video input jacks of your TV are of the BNC type, use a plug adapter (not supplied) to convert the pin plugs to BNC plugs.
- The component video signals can be output only when you select DVD or USB MEMORY as the source to play. (See page 13.)

### ■ To connect a TV equipped with the composite or S-video jack

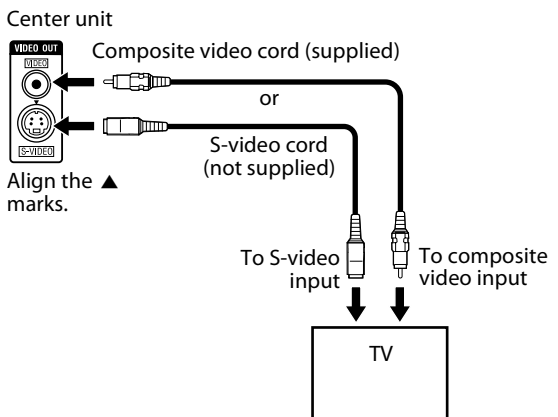

#### NOTE

- Select the appropriate scan mode according to your TV. (See page 14.)
- The composite and S-video signals can be output only when you select DVD or USB MEMORY as the source to play. (See page 13.)

## Connecting an external component

You can enjoy the sound of an analog component.

Center unit

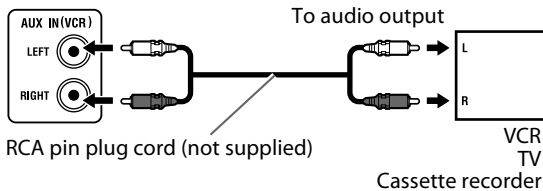

### NOTE

- If you connect a sound-enhancing device such as a graphic equalizer between the source components and this system, the sound output through this system may be distorted.
- When playing a video component such as a VCR;
  - To listen to the sound, select AUX as the source to play. (See page 13.)
  - To see the picture, connect the video output jack of the component to the video input jack of the TV directly, and select the correct input mode on the TV.

## Connecting a USB mass storage class device

You can connect a USB mass storage class device such as a USB flash memory device, hard disc drive, multimedia card reader, digital camera, etc. to this system.

- After connecting a USB mass storage class device to this system and selecting USB MEMORY as the source, the file control display appears on the TV screen. (See page 24.)

Center unit (on the front panel)

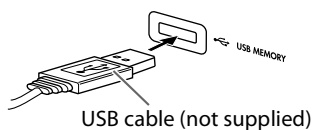

### NOTE

- When connecting a USB mass storage class device, refer also to its manual.
- Connect one USB mass storage class device to the system at a time. Do not use a USB hub.
- You cannot charge the USB mass storage class device while connecting it to the USB MEMORY jack.
- While playing back a file in a USB mass storage class device, do not disconnect the device. It may cause a malfunction of both the system and the device.
- JVC bears no responsibility for any loss of data in the USB mass storage class device while using this system.

- When connecting with a USB cable, use a cable less than 1 m in length.
- This system is compatible with the USB 2.0 Full-Speed (not compatible with the USB 1.1).
- You can play back the following types of files in a USB mass storage class device (maximum data transfer rate: 2 Mbps):
  - Music: MP3, WMA
  - Picture: JPEG
  - Movie: MPEG-4 (ASF), DivX (maximum frame rate of 30 fps for progressive)
- You cannot play back a file larger than 2 GB.
- When playing a file which has a large transfer rate, frames or sounds may be dropped during playback.
- This system cannot recognize a USB mass storage class device whose rating exceeds 5 V/500 mA.
- This system may not recognize some USB mass storage class devices.
- This system may not play back some files even though their formats are listed above.

## Connecting the power cord

Make sure that all other connections have been completed.

Center unit

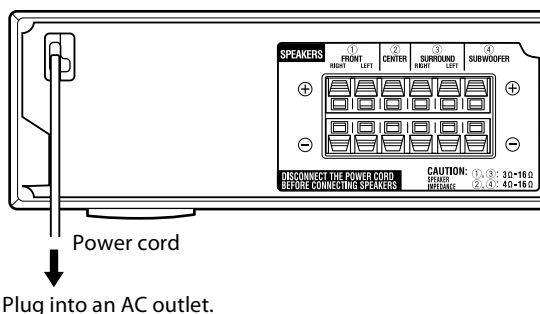

### CAUTION

- Disconnect the power cord before cleaning or moving the system.
- Do not pull on the power cord to unplug the cord. When unplugging the cord, always grasp and pull the plug so as not to damage the cord.

### NOTE

- Preset settings, such as preset stations and surround mode adjustment, may be erased in a few days in the following cases;
  - If you unplug the power cord of the center unit.
  - If a power failure occurs.
- If the wall outlet does not match the AC plug, use the supplied AC plug adapter.

# Operating the TV

You can use the remote control to operate not only this unit but also JVC TVs.

- Refer also to the manuals supplied for the TV.
- To operate the TV, aim the remote control directly at the remote sensor on the TV.

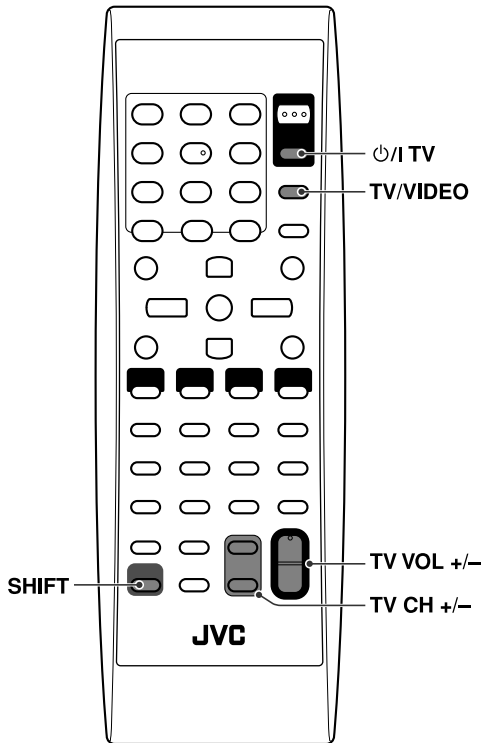

## ■ To operate a JVC's TV

You can perform the following operations on the TV.

<b>TV:</b>	Turn on or off the TV.
<b>TV VOL +/- with SHIFT pressed and held:</b>	Adjust the volume.
<b>TV/VIDEO:</b>	Set the input mode (either TV or VIDEO).
<b>TV CH +/- with SHIFT pressed and held:</b>	Change the channels.



## Selecting the source to play

**On the remote control:**

**Press one of the source selecting buttons (DVD ►, USB MEMORY ►, FM/AM or AUX).**

DVD ►: To play back a disc (DVD VIDEO, VCD etc.). (See page 15.)

USB MEMORY ►: To play back a file in a USB mass storage class device. (See page 15.)

FM/AM: To tune in an FM or AM station. (See page 34.)

Each time you press the button, the band alternates between FM and AM.

AUX: To select the external component connected to the center unit. (See page 10.)

**On the center unit:**

**Press SOURCE repeatedly until the source name you want appears on the display window.**

### NOTE

- When a source except DVD or USB MEMORY is selected, this system does not output video signals.
- It may take time to change the source.

## Adjusting the volume [VOLUME]

### CAUTION

- Always set the volume to minimum level before starting any source. If the volume is set at a high level, the sudden blast of sound could permanently damage your hearing and/or blow out the speakers.

**On the remote control:**

**Press AUDIO VOL +/-.**

**On the center unit:**

**Press VOLUME +/-.**

## Listening with headphones (not supplied)

### CAUTION

Be sure to turn down the volume;

- Before connecting or putting on headphones as high volume may damage both the headphones and your hearing.
- Before disconnecting headphones as high volume may be suddenly output from the speakers.

While connecting a pair of headphones to the PHONES jack on the center unit, the system automatically cancels the surround mode (see page 19) currently selected, deactivates the speakers, and activates the headphone mode.

“H.PHONE” appears on the display window.

### Headphone mode

When using the headphones, the following signals are output regardless of your speaker setting;

- For 2 channel sources, the front left and right channel signals are output from the headphones.
- Multi-channel signals are down-mixed and output from the headphones.

## Turning off the sound temporarily [MUTING]

### Press MUTING.

**To restore the sound**

Perform one of the following:

- Press MUTING again.
- Press AUDIO VOL +/- (or VOLUME +/- on the center unit).

## Adjusting the brightness of the indications [DIMMER]

### Press DIMMER with SHIFT pressed.

Each time you repeat the procedure, you can change the brightness level in 3 steps.

## Sleep Timer [SLEEP]

The system turns off automatically when the specified period of time has passed.

### Press SLEEP with SHIFT pressed.

Each time you repeat the procedure, the shut-off time changes.

Example:



#### To check the remaining time

Press SLEEP once with SHIFT pressed.

#### To change the remaining time

Press SLEEP repeatedly with SHIFT pressed.

#### To cancel

Press SLEEP repeatedly with SHIFT pressed, until "SLEEP - -" appears.

- Turning off the power also cancels the Sleep Timer.

## Adjusting the output level of the front/center/surround speakers and subwoofer

### 1 Press SPK-LEVEL to show the target speaker indication on the display window.

Each time you press the button, the indication of the speakers changes as follows:

FRNT L (Front left speaker) → FRNT R (Front right speaker) → CENTER (Center speaker) → SURR L (Surround left speaker) → SURR R (Surround right speaker) → SUBWFR (Subwoofer) → (back to the beginning)

### 2 Press LEVEL +/- to adjust the output level from -6 to 6.

#### NOTE

- You can also make adjustments by using the setup menu shown on the TV screen. (See page 32.)
- The adjustments take effect for all sources.

## Changing the scan mode

The system can be accommodated to your TV's scan mode.

#### NOTE

- To use the system in the progressive mode, it is required that the center unit is connected to the TV by using a component video cord (not supplied). (See page 9.)

- While DVD or USB MEMORY is selected as the source and before playback

### 1 Press and hold SCAN MODE for 2 seconds.

The current setting appears on the display window.

### 2 Press Cursor ▶ / ◀ to select the desired mode.

- **NTSC:** Select when your TV supports the NTSC interlaced video input only.
- **NTSC PRG:** Select when your TV equipped with component jacks supports the NTSC progressive video input.
- **PAL:** Select when your TV supports the PAL interlaced video input only.
- **PAL PRG:** Select when your TV equipped with component jacks supports the PAL progressive video input.

You can get better picture quality in NTSC PRG, PAL PRG mode than in NTSC, PAL mode.

### 3 Press ENTER while the selected mode is displayed.

When "NTSC PRG" or "PAL PRG" is selected, the PROGRESSIVE indicator lights on the display window.

#### NOTE

- Although the picture may be distorted when you press ENTER, this is not a malfunction of the system.

- There are some progressive TVs and High-Definition TVs that are not fully compatible with this system, resulting in an unnatural picture when playing back a DVD VIDEO in the progressive scan mode. In such a case, change the scan mode to "PAL" or "NTSC".
- All JVC progressive TVs and High-Definition TVs are fully compatible with this system.



# Playback

- The icon such as  shows the disc formats or file types the operation is available for.

The buttons described below are used on pages 15 to 18.

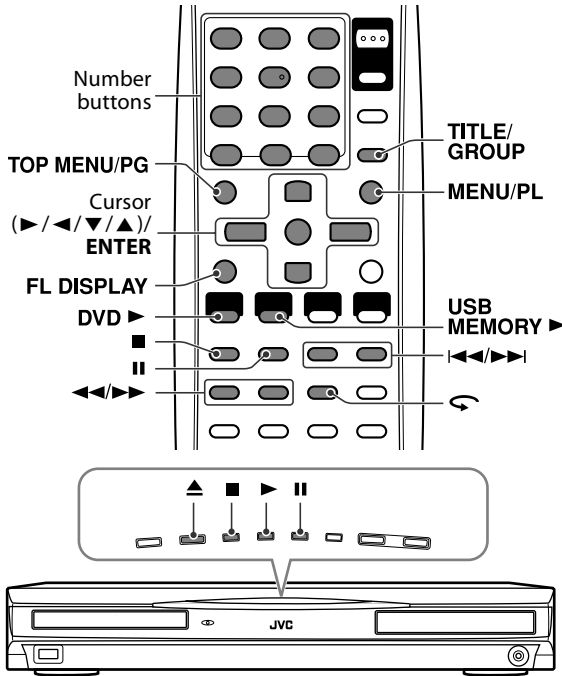

## For MP3/WMA files

The file control display (see page 24) appears on the TV screen.

## For JPEG files

Each file (still pictures) is shown on the TV screen for about 3 seconds (slide-show). When stopping playback, the file control display (see page 24) appears on the TV screen.

## For ASF/MPEG-2/MPEG-1 files

Pressing TOP MENU/PG or MENU/PL shows the file control display (see page 24) on the TV screen during playback.

## For DivX files

During the readout time, "READING INDEX" may appear on the TV screen.

Pressing TOP MENU/PG or MENU/PL shows the file control display (see page 24) on the TV screen during playback.

## NOTE

- When several types of files are recorded on a disc/device, select appropriate file type on the setup menu. (See page 32.)

## ■ To pause

### Press II.











To continue playback, press play button for corresponding source (DVD ► or USB MEMORY ►).

## ■ To stop

### Press ■.

## ■ On-screen guide icons

During DVD VIDEO playback, the following guide icons may appear for a while on the TV screen;

- : appears at the beginning of a scene containing multi-subtitle languages.
- : appears at the beginning of a scene containing multi-audio languages.
- : appears at the beginning of a scene containing multi-angle views.
-  (Play),  (Pause),  /  (Fast forward/fast-reverse),  /  (Slow-motion forward/reverse): appears when you perform each operation.
- : the disc cannot accept an operation you have tried to do.

## NOTE

- (For JPEG) The system cannot accept operations even though you press any buttons before the entire picture appears on the TV screen.
- If you do not want the on-screen guide icons to appear, see page 33.

## Basic Playback

### ■ To play a disc

#### 1 Press on the center unit.

The system turns on and the disc tray comes out.

#### 2 Place a disc.

DVD VIDEO	DVD VR	VCD
SVCD	CD	MP3 WMA
JPEG	ASF	MPEG 2/1
		DivX

Label side up

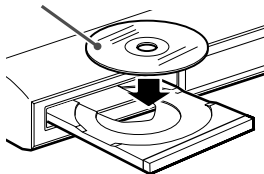

When placing an 8 cm disc

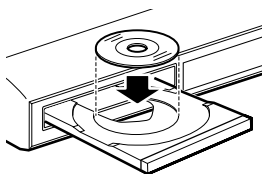

#### 3 Press DVD ► (play button).

### ■ To play a file in a USB mass storage class device

#### Press USB MEMORY ► (play button).

The operations of the files in a USB mass storage class device depend on the file types stored in the device.

## ■ Playback information on the display window

### DVD VIDEO

Example: When a DVD VIDEO encoded with Dolby Digital 5.1ch is played

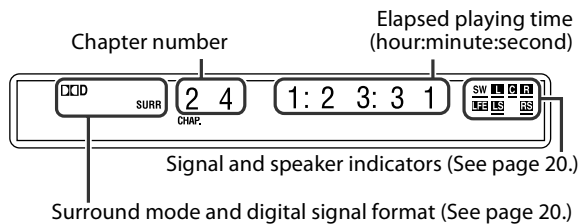

Pressing FL DISPLAY

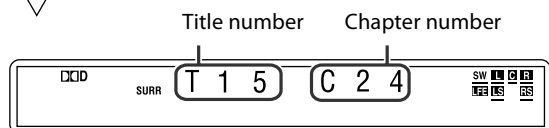

### DVD VR disc

Example: During playback on the Original program\*1

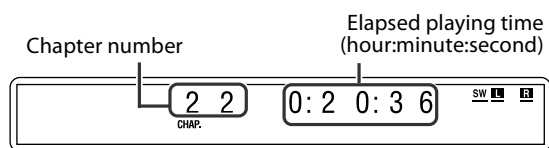

Pressing FL DISPLAY

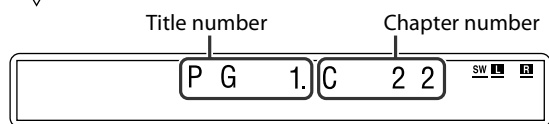

Example: During playback on the Playlist\*1

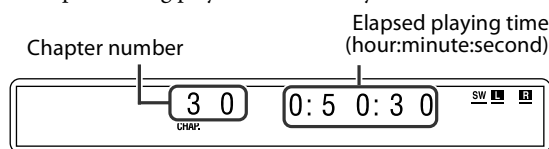

Pressing FL DISPLAY

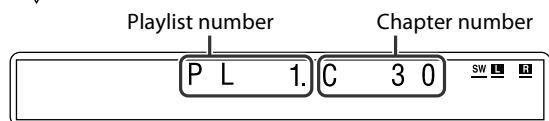

\*1 Pressing TOP MENU/PG or MENU/PL, you can change the play mode. (See page 18.)

### VCD/SVCD/CD

Example: When a CD is played back

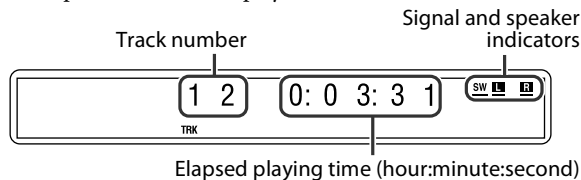

### NOTE

- When a VCD or SVCD with PBC function is played, the elapsed playing time does not appear, but "PBC" appears.

### MP3/WMA file

Example: When an MP3 file is played back

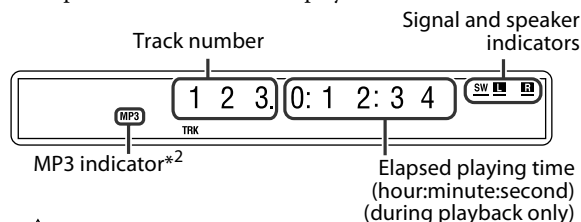

Pressing FL DISPLAY

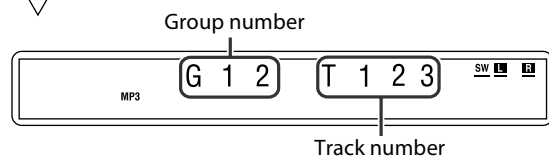

\*2 WMA indicator lights for WMA file.

### ASF/MPEG-2/MPEG-1/DivX file

Example: When an ASF file is played

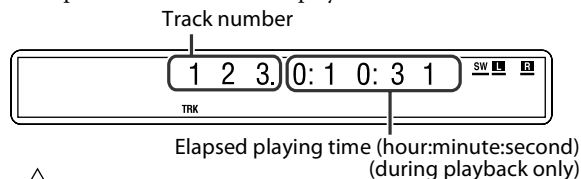

Pressing FL DISPLAY

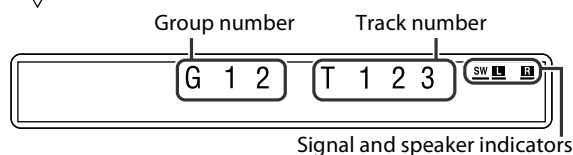

## JPEG file

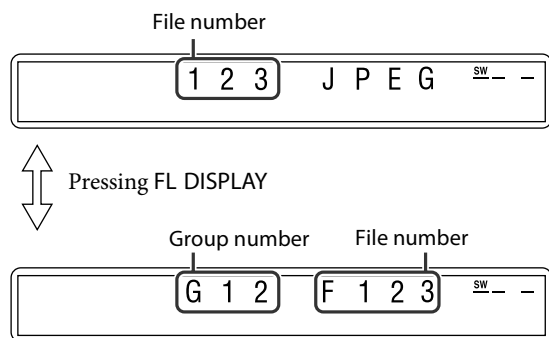

### NOTE

- You can change the time information mode (except for MP3/WMA/ASF/MPEG-2/MPEG-1/DivX). (See page 22.)
- You can also check the playback information on the TV screen. (See page 21.)

### ■ Screen saver

An image may burn in on a TV screen if a static picture is displayed for a long time. To prevent this, the system automatically dims the screen if a static picture is displayed for over 5 minutes (the screen saver function).

- Pressing any button will cancel the screen saver function.
- If you do not want to use the screen saver function, see page 32.

## One Touch Replay

You can move back the playback position by 10 seconds from the current position.



- During playback

Press ◀.

### NOTE

- This function works in the same title.
- This feature may not work for some discs.

## Fast-forward/fast-reverse search

- During playback

Press ►► or ◀◀.

Each time you press the button, the search speed changes (x2, x5, x10, x20, x60).

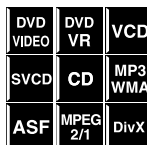

### To return to normal speed playback

Press play button for corresponding source (DVD ► or USB MEMORY ►).

### NOTE

- When a CD or MP3/WMA is played back, sound is intermittent and low during fast-forward/reverse search.
- This feature may not work for some discs/files.
- For MP3/WMA, the search speed is not shown.
- The search speed for DivX is ►► 1, ►► 2, ►► 3 for forward search, and ◀◀ 1, ◀◀ 2 and ◀◀ 3 for reverse search.

## Skip to the beginning of a desired selection

### ■ Using ►►| / |◀◀ buttons

- For DVD VIDEO/DVD VR (chapter): During playback
- For VCD/SVCD (track): During playback without PBC function
- For CD/MP3/WMA/JPEG/ASF/MPEG-2/MPEG-1/DivX (track/file): During playback or while stopped



Press ►►| or |◀◀ repeatedly.

### NOTE

- When playing back an MP3/WMA/JPEG/ASF/MPEG-2/MPEG-1/DivX, you can make operations using the file control display. (See page 24.)
- This feature may not work for some discs/files.

### ■ Using number buttons on the remote control

- For DVD VIDEO/DVD VR (title, chapter): While stopped, the title number is selected. During playback, the chapter number is selected.
- For VCD/SVCD (track): During playback or while stopped without PBC function
- For CD/MP3/WMA/JPEG/ASF/MPEG-2/MPEG-1/DivX (track/file): During playback or while stopped

Press number buttons (0-10, ≥10) to select the desired number.

- For details on using the number buttons, see "How to use the number buttons" below.

#### How to use the number buttons

- To select 3: Press 3.
- To select 10: Press 10.
- To select 14: Press ≥10, 1, then 4.
- To select 24: Press ≥10, 2, then 4.
- To select 40: Press ≥10, 4, then 0.
- To select 114: Press ≥10, ≥10, 1, 1, then 4.

## Skipping at about 5-minute intervals

While playing back a long file, you can skip within the file at about 5-minute intervals.



■ During playback

**Press Cursor ▶ / ◀.**

Each time you press the button, the playback position skips to the beginning of the previous or next interval.

### NOTE

- Intervals are automatically assigned from the beginning of a file.
- This feature is available only within the same file.
- This feature may not work for some discs/files.

## Locating a desired title/group using number buttons

■ During playback or while stopped

**1 Press TITLE/GROUP.**

“--” is shown in the title/group display area in the display window.



Example: During DVD VIDEO playback

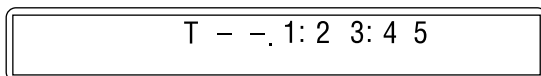

**2 While the display window shows “--”, use number buttons (0-10, ≥10) to enter the desired title or group number.**

The system starts playback from the first chapter/track/file of the selected title/group.

- For details on using the number buttons, see “How to use the number buttons”. (See page 17.)

### NOTE

- When locating a title of a DVD VR disc, PG or PL indicator may light on the display window.
- This feature may not work for some discs/files.

## Selecting the desired title/playlist from the control display

■ During playback or while stopped

**1 Press TOP MENU/PG or MENU/PL.**



The control display is shown on the TV screen, and the system starts playback of the first title/playlist.

- The PLAY LIST is shown only when the playlist is on the DVD VR disc.

TOP MENU/PG: shows the ORIGINAL PROGRAM.

Example:

ORIGINAL PROGRAM				
No	Date	Ch	Time	Title
1	25/04/04	4ch	19:00	JVC DVD World 2004
2	17/05/04	8ch	10:30	
3	22/05/04	8ch	17:00	Music Festival children 001
4	26/05/04	L-1	13:19	
5	20/06/04	4ch	22:00	
6	25/06/04	L-1	8:23	children 002

- \*1: Title number
- \*2: Recording date
- \*3: Recording source (TV station, the input terminal of the recording equipment etc.)
- \*4: Start time of recording
- \*5: Title of the original program/playlist (The title may not be displayed depending on the recording equipment.)
- \*6: Current title

MENU/PL: shows the PLAY LIST.

Example:

PLAY LIST				
No	Date	Chap	Length	Title
1	25/05/04	001	1:03:16	My JVC World
2	17/06/04	005	1:35:25	
3	20/06/04	003	0:10:23	Favorite music children001-002
4	25/06/04	001	0:07:19	

- \*7: Playlist number
- \*8: Creating date of playlists
- \*9: Number of chapters
- \*10: Total playing time
- \*11: Current playlist

**2 Press Cursor ▼ / ▲ to select the desired title/playlist.**

The system starts playback of the selected title/playlist.

**To clear the control display**

Press ENTER.

### About the play mode on a DVD VR disc

- Original program (ORIGINAL PROGRAM):  
The system can play back the original picture in the recorded order.
- Playlist (PLAY LIST):  
The system can play back the playlist edited by the recording equipment.

# Advanced operations

- The icon such as  shows the disc formats or file types the operation is available for.

The buttons described below are used on pages 19 to 30.

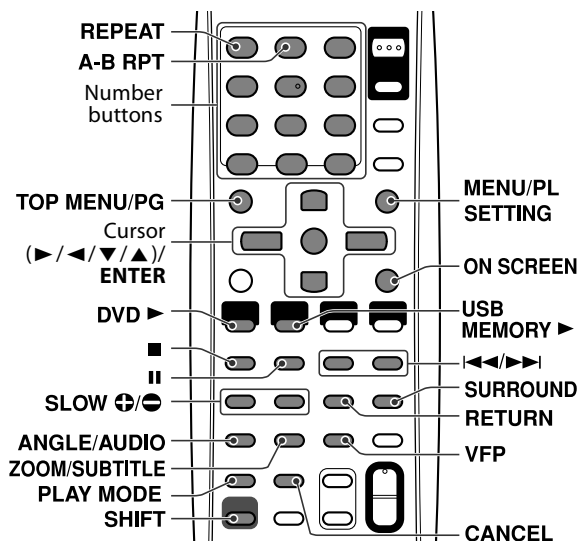

## Using the surround mode

You can enjoy more realistic sound field than a stereo sound by using the surround mode.

### ■ Auto Surround (AUTO SUR)

This function automatically selects the appropriate surround mode according to the input signals. For example, a multichannel source is automatically reproduced in multichannel audio.

### Available Surround modes for each input signal

The √ marks show available surround modes.

Signal	Mode		Dolby Surround			DTS Digital Surround	DSP	
	Surround off	Auto Surround	MOVIE* <sup>3</sup>	MUSIC* <sup>3</sup>	DOLBY D	DTS	STADIUM* <sup>3</sup>	ALL ST* <sup>3</sup>
Dolby Digital (Multichannel)	√	√	—	—	√	—	—	—
Dolby Digital (2 channel)	√	√	√	√	—	—	√	√
DTS Digital Surround (Multichannel)	√	√	—	—	—	√	—	—
DTS Digital Surround (2 channel)	√	√	√	√	—	—	√	√
Analog or Linear PCM	√	√	√	√	—	—	√	√

\*<sup>1</sup> Manufactured under license from Dolby Laboratories. “Dolby”, “Pro Logic”, and the double-D symbol are trademarks of Dolby Laboratories.

\*<sup>2</sup> “DTS” and “DTS Digital Surround” are registered trademarks of Digital Theater Systems, Inc.

\*<sup>3</sup> You can select these modes by pressing SURROUND. (See page 20.)

### ■ Dolby Surround

#### Dolby Pro Logic II\*<sup>1</sup>

Dolby Pro Logic II has a developed multichannel playback format to decode all 2 channel sources — stereo source and Dolby Surround encoded source — into a 5.1 channel. Dolby Pro Logic II has two modes — Movie mode and Music mode:

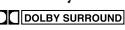
- **Pro Logic II Movie (MOVIE)**  
Suitable for reproduction of Dolby Surround encoded sources bearing the mark .
- **Pro Logic II Music (MUSIC)**  
Suitable for reproduction of any 2 channel stereo music sources.

#### Dolby Digital\*<sup>1</sup>

Used to reproduce multichannel soundtracks of the software encoded with Dolby Digital ().

- There are other encoding formats of digital surround introduced by Dolby Laboratories, such as Dolby Digital EX.

#### ■ DTS Digital Surround\*<sup>2</sup>

Used to reproduce multichannel soundtracks of the software encoded with DTS Digital Surround (). DTS Digital Surround (DTS) is another discrete multichannel digital audio format available on CD and DVD software.

- There are other encoding formats of multi-channel digital surround introduced by Digital Theater Systems, Inc., such as DTS-ES, DTS 96/24.

Continued on the next page

## ■ DSP

### • STADIUM

STADIUM mode adds clarity and spreads the sound, like in an outdoor stadium.

### • All Channel Stereo

All Channel Stereo (ALL ST) mode can reproduce a larger stereo sound field using all the connected (and activated) speakers.

All Channel Stereo can be used while reproducing 2 channel stereo source.

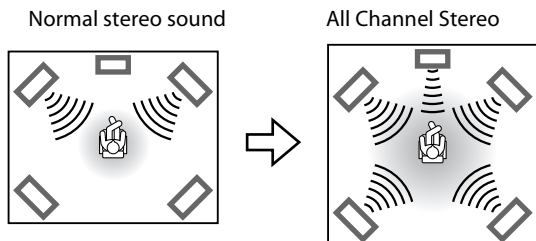

## ■ Indicators on the display window

### Digital signal format indicators

LPCM: Lights when Linear PCM signal comes in.

DD: Lights when Dolby Digital signals come in.

DS: Lights when DTS Digital (Surround) signals come in.

No indication: No digital signal indicator lights when analog signals come in.

### Dolby Surround mode indicator

PLII: Lights when Dolby Pro Logic II mode is activated.

### Surround indicator

SURR: Lights when the surround mode is activated.

### Source signal indicators, etc.

Light to indicate the incoming signals.



**L**: Lights when the front left channel signal comes in.

**C**: Lights when the center channel signal comes in.

**R**: Lights when the front right channel signal comes in.

**LFE**: Lights when the LFE channel signal comes in.

**LS**: Lights when the surround left channel signal comes in.

**RS**: Lights when the surround right channel signal comes in.

**S**: Lights when the monaural surround channel signal or 2 channel Dolby Surround signal comes in.

**SW**: Always lights.

The channel with “—” shows that the corresponding speakers are reproducing the channels’ sound.

If the channels’ sound decoded into 5.1 channel is reproduced, only “—” lights.

## Selecting the surround mode

The system is set up to automatically select the optimal surround mode for input signal from digital multichannel software.

When playing back a 2 channel source, you can select the desired surround mode manually.

### NOTE

- This function also takes effect for the sources other than DVD.
- For ASF, MPEG-2, MPEG-1 and DivX (except DivX version 6), the surround mode takes no effects.

### ■ When playing back digital multichannel software (except while OFF is selected)

The appropriate multichannel surround mode (Dolby Digital or DTS Digital Surround) is automatically selected.

### ■ When playing back a 2 channel source

You can select either Dolby Pro Logic II (MOVIE/MUSIC) or the DSP mode.

### Press SURROUND repeatedly to select the desired mode.

The surround mode is turned on and the current surround mode appears on the display window.

Each time you press the button, the surround mode changes.

For details on each mode, see “Available Surround modes for each input signal”. (See page 19.)

### To turn off the surround mode

### Press SURROUND repeatedly until “OFF” appears on the display window.

### Storing adjustments — auto memory

When you turn the power off, the system memorizes the current surround mode. The memorized mode is automatically recalled when you turn the power on.

## Using the on-screen bar

You can check disc information and you can use some functions using the on-screen bar.

### Showing the on-screen bar

■ Whenever a disc is loaded

#### Press ON SCREEN.

Each time you press the button, the on-screen bar changes as follows on the TV screen.

DVD VIDEO	DVD VR	VCD
SVCD	CD	ASF
MPEG 2/1	DivX	

Example: During DVD VIDEO playback

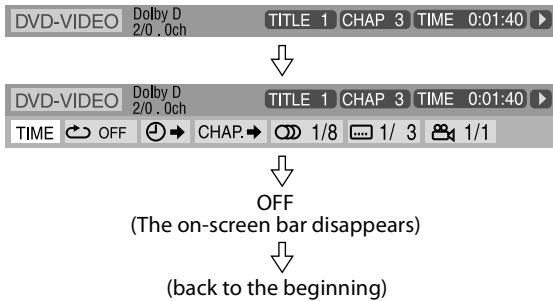

• The currently selected item shows green.

### ■ Contents of the on-screen bar during playback

#### DVD VIDEO

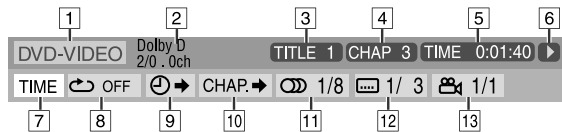

#### DVD VR disc

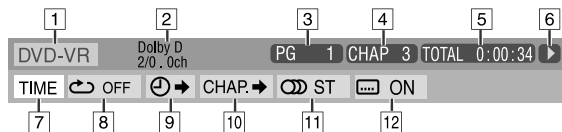

#### VCD

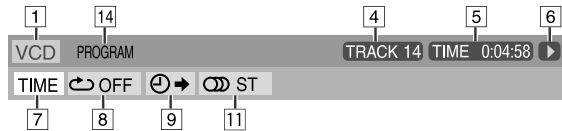

#### SVCD

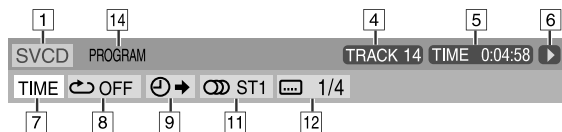

#### CD



#### ASF/MPEG-2/MPEG-1/DivX



- 1 Shows disc type.
- 2 Shows audio information.
- 3 For DVD VIDEO: Shows current title number.  
For DVD VR: Shows current play mode (PG: for Original program, PL: for Playlist) and title number.
- 4 For DVD VIDEO and DVD VR: Shows current chapter number.  
For other type of discs: Shows current track number.
- 5 Shows time information. See “Changing the time information”. (See page 22.)
- 6 Shows playback status.  
▶ : appears during playback.  
▶▶ / ◀◀ : appears during fast forward/reverse.  
▶◀ / ◀▶ : appears during playback in forward slow-motion/reverse slow-motion.  
⏸ : appears when paused.  
■ : appears when stopped.
- 7 Select this to change time information (5). See “Changing the time information”. (See page 22.)
- 8 Select this for Repeat Playback. (See page 29.)
- 9 Select this for time search function. (See page 24.)
- 10 Select this for chapter search function. (See page 23.)
- 11 Select this to change audio language or channel. (See page 26.)
- 12 Select this to change subtitle language. (See page 26.)
- 13 Select this to change view angle. (See page 25.)
- 14 Shows Playback mode status.  
**PROGRAM:** appears during Program Playback. (See page 28.)  
**RANDOM:** appears during Random Playback. (See page 28.)
- 15 Shows Repeat mode status. (See page 29.)

## Changing the time information

You can change the time information in the on-screen bar on the TV screen and the display window of the center unit.



■ During playback

### 1 Press ON SCREEN twice.

The on-screen bar appears on the TV screen.

### 2 Press Cursor ► / ◀ to highlight

TIME .

### 3 Press ENTER repeatedly to select the desired information.

Example: When elapsed playing time of disc is selected.

TOTAL 1:25:58

■ DVD VIDEO/DVD VR

- TIME: Elapsed playing time of current chapter
- REM: Remaining time of current chapter
- TOTAL: Elapsed time of Title/Program
- T. REM: Remaining time of Title/Program

■ VCD/SVCD/CD

- TIME: Elapsed playing time of current track
- REM: Remaining time of current track
- TOTAL: Elapsed time of disc
- T. REM: Remaining time of disc

### 4 Press ON SCREEN.

The on-screen bar disappears.

#### NOTE

- When playing back DVD VR, "TIME" and "REM" cannot be shown.

## Playing from a specified position on a disc

You can start playing a title, chapter or track you specify. You can also play a disc from specified time.

## Locating a desired scene from the DVD menu

DVD VIDEOS generally have their own menus which show disc contents and you can display them on the TV screen. You can locate a desired scene by using these menus.



■ Whenever a DVD VIDEO is loaded

### 1 Press TOP MENU/PG or MENU/PL.

The menu appears on the TV screen.

Example:

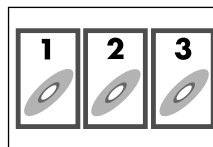

Normally, a DVD VIDEO which contains more than one title will have a "top" menu which lists the titles. Press TOP MENU/PG to show the title menu. Some DVD VIDEO may also have a different menu which is shown by pressing MENU/PL. See the instructions for each DVD VIDEO regarding its particular menu.

### 2 Use Cursor ► / ◀ / ▼ / ▲ to select a desired item.

### 3 Press ENTER.

- With some discs, you can also select items by entering the corresponding number using number buttons.

#### NOTE

- This feature may not work for some discs.



## Locating a desired scene using a VCD/SVCD menu with PBC

A VCD or SVCD recorded with PBC has its own menus such as a list of contained songs. You can locate a specific scene by using these menus.



■ During playback with PBC function

**1 Press RETURN repeatedly with SHIFT pressed, until the menu appears on the TV screen.**

Example:

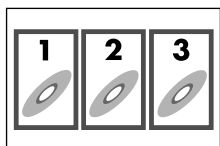

**2 Press number buttons (1-10,  $\geq 10$ ) to select the number of the desired item.**

- For details on using the number buttons, see “How to use the number buttons”. (See page 17.)

### To return to the menu

Press RETURN repeatedly with SHIFT pressed, until the menu screen appears.

### When “NEXT” or “PREVIOUS” is shown on the TV screen:

- To go to the next page, press ►►.
- To return to the previous page, press ◀◀.

### NOTE

- If you want to play a PBC-compatible VCD/SVCD without using the PBC function, perform any of the following:
  - Start playback by pressing number buttons while stopped.
  - Press ►► repeatedly until the desired track number is displayed, then start playback by pressing DVD ► (play button). The track number appears on the display window instead of “PBC”.
- To activate the PBC function when playing a PBC-compatible VCD/SVCD without using the PBC function, perform any of the following:
  - Press TOP MENU/PG or MENU/PL.
  - Press ■ twice to stop playback, then press DVD ► (play button).

## Locating a desired chapter using the on-screen bar

■ During playback



**1 Press ON SCREEN twice.**

The on-screen bar appears on the TV screen.

**2 Press Cursor ► / ◀ to highlight**

CHAP.►.

**3 Press ENTER.**

Example: During DVD VIDEO playback



**4 Press number buttons (0-9) to enter the desired chapter number.**

Example:

- To select 8: Press 8.
- To select 10: Press 1, then 0.
- To select 20: Press 2, then 0.
- To select 37: Press 3, then 7.

### To correct a misentry

Repeat step 4.

**5 Press ENTER.**

**6 Press ON SCREEN.**

The on-screen bar disappears.

### NOTE

- You can select up to the 99th chapter.

## Locating a desired position by specifying the time

You can locate a desired position by specifying the time from the beginning the disc (while stopped) or the current title/track (during playback).

- For DVD VIDEO/DVD VR: During playback
- For VCD/SVCD: While stopped or during playback without PBC function
- For CD: During playback or while stopped



### ■ When specifying the elapsed playing time from the beginning of the disc

Perform the following procedure while stopped.

### ■ When specifying the elapsed playing time from the beginning of current title/track

Perform the following procedure during playback.

#### 1 Press ON SCREEN twice.

The on-screen bar appears on the TV screen.

#### 2 Press Cursor ► / ◀ to highlight



#### 3 Press ENTER.



#### 4 Use number buttons (0-9) to enter the time.

You can specify the elapsed playing time from the beginning of the disc (while stopped) or from the beginning of the current title/track (during playback).

Example: To play back from a point 2 (hours): 34 (minutes): 08 (seconds) elapsed

TIME \_ : \_ : \_ \_ ⇒ TIME 2 : \_ : \_ \_ ⇒  
Press 2 Press 3

TIME 2 : 3 : \_ \_ ⇒ TIME 2 : 3 4 : \_ \_ ⇒  
Press 4 Press 0

TIME 2 : 3 4 : 0 \_ ⇒ TIME 2 : 3 4 : 0 8  
Press 8

#### To cancel a misentry

Press Cursor ◀ repeatedly.

#### 5 Press ENTER.

#### 6 Press ON SCREEN.

The on-screen bar disappears.

## Using the file control display

You can search and play desired groups and tracks/files using the file control display on the TV screen.

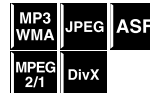

Example: When the source is DVD.

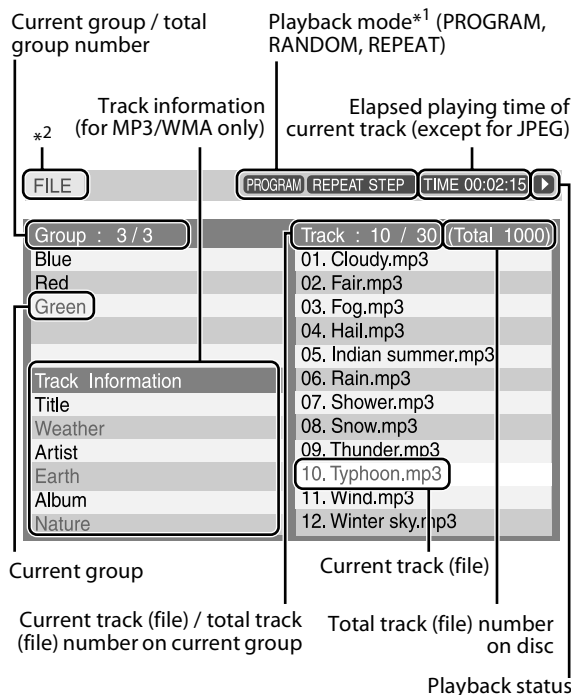

\*1 (For JPEG/ASF/MPEG-2/MPEG-1/DivX) The Program and Random mode are not available.

\*2 When the source is USB MEMORY, "USB" appears.

The file control display appears automatically during playback (for MP3/WMA) or while stopped.

- For MP3/WMA: During playback or while stopped
- For JPEG/ASF/MPEG-2/MPEG-1/DivX: While stopped

## 1 Press Cursor **▶** / **◀** / **▼** / **▲** to select the desired group/track/file.

- For MP3/WMA, playback starts from the selected track.
- For JPEG, proceed to perform the following operation.

## 2 Press play button for corresponding source (DVD **▶** or USB MEMORY **▶**) or ENTER.

- Track playback/slide-show starts from the selected track/file.
- When you press ENTER for JPEG, only the selected file is played back.

### To skip the file during playback

Press **▶▶** / **◀◀** or Cursor **▲** / **▼**.

### NOTE

- You can also check playback information on the display window. (See page 16.)
- Some group, track and file names may not be displayed correctly depending on recording conditions.
- The order of groups, tracks, and files may be displayed differently from the order displayed on your personal computer.

## Resume Playback

When Resume Playback is set to "ON" (see page 33) and you stop playback by the following operations, the position where playback has been stopped is stored. (RESUME indicator lights on the display window.)



- Turning off the power (see page 12)
- Pressing **■** once
- Changing the source (see page 13)

### To start playback from the stored position

- Press play button for corresponding source (DVD **▶** or USB MEMORY **▶**) on the remote control or **▶** (play button) on the center unit.
- Select DVD or USB MEMORY as the source again if you changed the source.

### To clear the stored position

Press **■** again.

- Opening the disc tray or disconnecting the USB mass storage class device also clears the stored position.

### NOTE

- (For DivX) The beginning of a scene where playback has been stopped may be stored.

## Selecting a view angle

- During playback of a disc containing multi-view angles



### When using the ANGLE button:

## 1 Press ANGLE with SHIFT pressed.

Example: The first view angle is selected out of 3 view angles recorded.

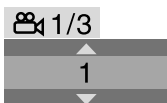

## 2 Press ANGLE repeatedly with SHIFT pressed, or Cursor **▼** / **▲** to select the desired view angle.

### When using the on-screen bar:

## 1 Press ON SCREEN twice.

The on-screen bar appears on the TV screen.

## 2 Press Cursor **▶** / **◀** to highlight



## 3 Press ENTER.



## 4 Press Cursor **▼** / **▲** to select the desired view angle.

## 5 Press ENTER.

## 6 Press ON SCREEN.

The on-screen bar disappears.

## Selecting the subtitle

- During playback of a disc/file containing subtitles in several languages



When using the **SUBTITLE** button:

### 1 Press SUBTITLE.

Example (DVD VIDEO): “ENGLISH” is selected out of 3 subtitle languages recorded.

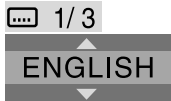

### 2 Press Cursor ▼ / ▲ to select the desired subtitle.

For DVD VR

- Pressing SUBTITLE activates the subtitles (subpictures) regardless of whether the subtitles are recorded or not. (Subpictures will not change if no subpicture is recorded.)

For SVCD

- An SVCD can contain up to four subtitles. Pressing SUBTITLE changes the subtitles regardless of whether the subtitles are recorded or not. (Subtitles will not change if no subtitle is recorded.)

When using the on-screen bar:

### 1 Press ON SCREEN twice.

The on-screen bar appears on the TV screen.

### 2 Press Cursor ► / ◀ to highlight



### 3 Press ENTER.



### 4 Press Cursor ▼ / ▲ repeatedly to select the desired subtitle.

### 5 Press ENTER.

### 6 Press ON SCREEN.

The on-screen bar disappears.

#### NOTE

- Some subtitle or audio languages are abbreviated in the pop-up window. See “The language codes list”. (See page 33.)
- Each time you press SUBTITLE, the subtitle appears and disappears alternately.
- For DivX, you cannot operate this procedure using the on-screen bar.

## Selecting the audio

- During playback of a disc/file containing audio in several languages



When using the **AUDIO** button:

### 1 Press AUDIO.

Example (DVD VIDEO): “ENGLISH” is selected out of 3 audio languages recorded.

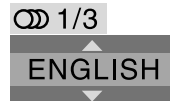

### 2 Press AUDIO repeatedly or Cursor ▼ / ▲ to select the desired audio.

When using the on-screen bar:

### 1 Press ON SCREEN twice.

The on-screen bar appears on the TV screen.

### 2 Press Cursor ► / ◀ to highlight

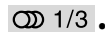

### 3 Press ENTER.



### 4 Press Cursor ▼ / ▲ to select the desired audio.

### 5 Press ENTER.

### 6 Press ON SCREEN.

The on-screen bar disappears.

#### NOTE

- Some subtitle or audio languages are abbreviated in the pop-up window. See “The language codes list”. (See page 33.)
- “ST”, “L”, or “R” is displayed when playing a VCD respectively representing “stereo”, “left sound” and “right sound”.  
When playing a SVCD, “ST1”, “ST2”, “L1”, “R1”, “L2”, or “R2” is displayed.
- For DivX, you cannot operate this procedure using the on-screen bar.

## Special picture playback

### Frame-by-frame playback

■ During playback

#### Press **II** repeatedly.

Each time you press the button, the still picture advances by one frame.

#### To return to normal playback

Press play button for corresponding source (DVD ► or USB MEMORY ►).

DVD VIDEO	DVD VR	VCD
SVCD	MPEG 2/1	DivX

### Playing back in slow-motion

■ During playback

#### 1 Press **II** at the point where you want to start playback in slow-motion from.

The system pauses playback.

#### 2 Press **SLOW** .

Playback in forward slow-motion starts.

For DVD VIDEO only:

- To play back in reverse slow-motion, press **SLOW** .

Each time you press the button, the playback speed becomes faster (1/32, 1/16, 1/8, 1/4, 1/2).

#### To return to normal playback

Press DVD ►.

#### NOTE

- Sound cannot be heard during slow-motion playback.

### Zooming in

■ During playback or while paused

#### 1 Press **ZOOM** with **SHIFT** pressed.





Each time you repeat the procedure, the scene magnification changes.

#### 2 While zoomed in, press **Cursor** / / / to move zoom-in area.

#### To return to normal playback

Press **ZOOM** repeatedly with **SHIFT** pressed, to select OFF.

#### NOTE

- The number of the magnification steps varies depending on the disc type.
- During slide-show playback of JPEG, zooming in is not available. In such a case, press **II** to pause slide-show playback, then zoom in.
- During playback, there may be a case where **Cursor** ( /  /  / ) does not work in step 2.

DVD VIDEO	DVD VR	VCD
SVCD	JPEG	ASF
MPEG 2/1	DivX	

## Changing the VFP setting

The VFP (Video Fine Processor) function enables you to adjust the picture character according to the type of programming, picture tone or personal preference.

DVD VIDEO	DVD VR	VCD
SVCD	JPEG	ASF
MPEG 2/1	DivX	

■ During playback

#### 1 Press **VFP**.

The current VFP settings appear on the TV screen.

Example:

NORMAL	
GAMMA	0
BRIGHTNESS	0
CONTRAST	0
SATURATION	0
TINT	0
SHARPNESS	0

#### 2 Press **Cursor** / repeatedly to select the VFP mode.

- **NORMAL**: Normally select this.
  - **CINEMA**: Suitable for movies.
- When you select "NORMAL" or "CINEMA", press **VFP** to complete the setting.
- **USER 1** and **USER 2**: You can adjust parameters that affect picture appearance.

**Only when selecting "USER 1" or "USER 2" in step 2, proceed to perform the following operation;**

#### 3 Press **Cursor** / repeatedly to select a parameter you want to adjust.

Adjust gradually and confirm picture appearance results are as preferred.

- **GAMMA**: Controls brightness of neutral tints while maintaining brightness of dark and bright portions (-3 to +3).
- **BRIGHTNESS**: Controls screen brightness (-8 to +8).
- **CONTRAST**: Controls screen contrast (-7 to +7).
- **SATURATION**: Controls screen color depth (-7 to +7).
- **TINT**: Controls screen tint (-7 to +7).
- **SHARPNESS**: Controls screen sharpness (-8 to +8).

#### 4 Press **ENTER**.

Example:

GAMMA	0
-------	---

#### 5 Press **Cursor** / to change the setting.

**6 Press ENTER.**

The current VFP settings appear again.

**7 Repeat steps 3 to 6 to adjust other parameters.**

**8 Press VFP.**

**NOTE**

- Although the setting display disappears in the middle of the procedure, the setting at that time will be stored.

**Program Playback**

■ While stopped



**1 Press PLAY MODE repeatedly until program window appears on the TV screen.**

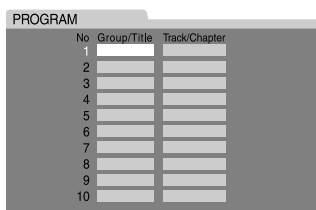

USE NUMERIC KEYS TO PROGRAM TRACKS.  
USE CANCEL TO DELETE THE PROGRAM.

**2 Follow the instructions that appear on the TV screen to program the desired chapters/tracks.**

- For details on using the number buttons, see “How to use the number buttons”. (See page 17.)
- The content’s numbers that you have to specify for programming varies depending on the disc/file type:
  - DVD VIDEO: Titles and chapters
  - VCD, SVCD, CD: Tracks
  - MP3/WMA: Groups and tracks
- You can specify the chapters/tracks whose number is up to 99.

**To clear the programs one by one from the last entered number**

Press CANCEL repeatedly.

**To clear all programs**

Press and hold CANCEL.

You can also clear the program by turning off the system.

**3 Press DVD ► to start Program Playback.**

If all of the programmed tracks/files have been played back, playback stops and the program window appears again. Note that program setting remains.

**To check the program contents**

During playback, press ■. Playback stops and the program window appears.

**To quit the Program mode**

While stopped, press PLAY MODE repeatedly until both program window and “RANDOM” disappear from the TV screen.

**NOTE**

- When the source is USB MEMORY, Program Playback does not work.
- The Resume function cannot be used with Program Playback.
- Program Playback may not work for some discs.

**Random Playback**

You can play titles or tracks on a disc in random order.



■ While stopped

**1 Press PLAY MODE repeatedly until “RANDOM” appears on the TV screen.**

**2 Press DVD ►.**

After playing all titles/tracks on the disc, the system stops playback.

**To quit the Random mode**

While stopped, press PLAY MODE repeatedly until both program window and “RANDOM” disappear from the TV screen.

You can also clear the Random mode by turning off the system.

**NOTE**

- When the source is USB MEMORY, Random Playback does not work.
- The same title/track will not be played back more than once during Random Playback.

## Repeat Playback

### Repeating the current selection

- For DVD VIDEO/DVD VR: During playback
- For VCD/SVCD: During playback without PBC function or while stopped
- For CD/MP3/WMA/JPEG/ASF/MPEG-2/MPEG-1/DivX: During playback or while stopped

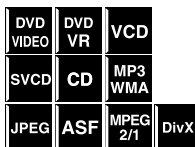

When using the REPEAT button:  
Press REPEAT with SHIFT pressed.

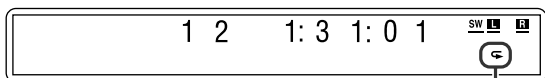

Repeat mode indicator

Each time you press REPEAT, the Repeat mode changes.

Display window	TV screen	Meanings
↶	↶GROUP	Repeats the current group for MP3/WMA/JPEG/ASF/MPEG-2/MPEG-1/DivX.
	REPEAT GROUP	
	↶TITLE	Repeats the current title for DVD VIDEO.
	↶PG	Repeats the current title for Original program for DVD VR.
	↶PL	Repeats the current playlist for Playlist for DVD VR.
↶ ALL	↶ALL	Repeats all title/tracks/files for DVD VR/VCD/SVCD/CD/MP3/WMA/JPEG/ASF/MPEG-2/MPEG-1/DivX.
	REPEAT ALL	
↶ 1	↶TRACK , ↶STEP	Repeats the current track for VCD/SVCD/CD/MP3/WMA/ASF/MPEG-2/MPEG-1/DivX.
	REPEAT TRACK, REPEAT STEP	
	↶CHAP , ↶STEP	Repeats the current chapter for DVD VIDEO/DVD VR.
No indication	↶OFF	Repeat mode is off. The system plays back the disc/file normally.

When using the on-screen bar (except for MP3/WMA/JPEG/ASF/MPEG-2/MPEG-1/DivX):

- 1 Press ON SCREEN twice.  
The on-screen bar appears on the TV screen.
- 2 Press Cursor ▶ / ◀ to highlight ↶ OFF.
- 3 Press ENTER.
- 4 Press Cursor ▼ / ▲ repeatedly to select the Repeat mode.
- 5 Press ENTER.
- 6 Press ON SCREEN.  
The on-screen bar disappears.



To cancel Repeat Playback

Select "OFF" in step 4.

### Repeating a desired part [A-B Repeat]

You can repeat playback of a desired part by specifying the beginning (point A) and ending (point B).



- During playback

When using the A-B RPT button:

- 1 Press A-B RPT with SHIFT pressed, at the beginning of the part you want to repeat (point A).  
The repeat mode indicator "↶ A -" appears on the display window.
- 2 Press A-B RPT again with SHIFT pressed, at the end of the part you want to repeat (point B).  
The repeat mode indicator on the display window changes to "↶ A - B" and A-B Repeat Playback starts. The selected part of the disc (between point A and B) is played repeatedly.

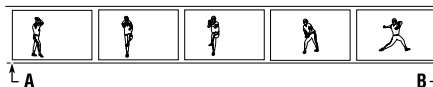

To cancel

Press A-B RPT, with SHIFT pressed during A-B Repeat Playback.

When using the on-screen bar:

## 1 Press ON SCREEN twice.

The on-screen bar appears on the TV screen.

## 2 Press Cursor ► / ◀ to highlight

⏪ OFF.

## 3 Press ENTER.

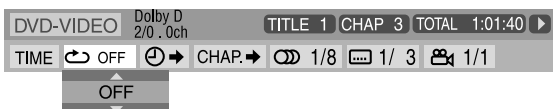

## 4 Press Cursor ▼ / ▲ repeatedly to select "A-B".

## 5 Press ENTER at the beginning of the part you want to repeat (point A).



## 6 Press ENTER at the end of the part you want to repeat (point B).

A-B Repeat Playback starts.

## 7 Press ON SCREEN.

The on-screen bar disappears.

### To cancel

Select "OFF" in step 4, then press ENTER.

### NOTE

- When playing back a DVD VIDEO, A-B Repeat Playback is possible only within the same title.
- "A-B" cannot be selected during Program and Random Playback.
- "A-B" cannot be selected during playback with PBC function.

## Tray lock

You can lock the tray and prohibit unwanted disc ejection.

### On the center unit ONLY:

While the system is on standby mode, press ▲ with ■ pressed and held.

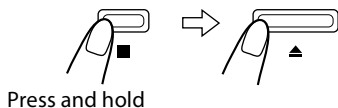

Press and hold

- "LOCKED" appears on the display window.
- If you try to eject the disc, "LOCKED" appears to indicate that the tray is locked.

### To cancel

Carry out the same operation again.

- "UNLOCKED" appears on the display window.

## Sound and other settings

### NOTE

- Before you start the operation; There is a time limit when doing the following steps. If the setting is cancelled before you finish, start from step 1 again.

## 1 Press SETTING with SHIFT pressed.

Example:

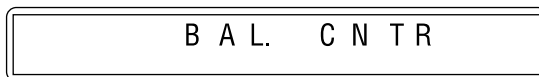

## 2 Press Cursor ▼ / ▲ to select the item you want to set.

- **BAL.** (Balance): You can adjust the balance of the sound between "R (right) -21" and "L (left) -21". To set the balance to normal, select "CNTR (center)".
- **AUX. LVL** (Aux level): You can select the audio input level through AUX IN (VCR) terminal.
  - AUX. LVL1:** Normally select this.
  - AUX. LVL2:** Select this when the source from the component connected to the AUX IN (VCR) terminal is too quiet with "AUX. LVL1" selected.

## 3 Press Cursor ► / ◀ to make an adjustment or selection.

Example:

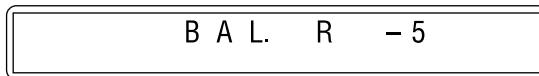

The adjustment display automatically disappears a few seconds later with the current setting.



# Setting DVD preferences

## Using the setup menus

- You can change the language used in the setup menus. See “Menu description” below.

## Basic operation on the setup menus

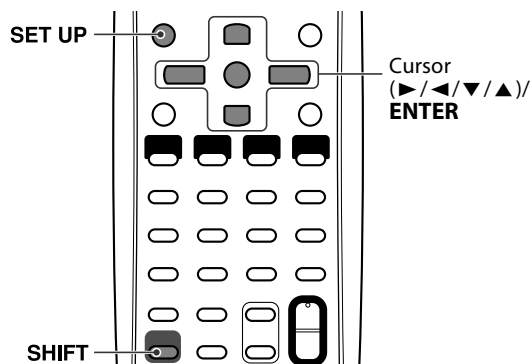

- While stopped

### 1 Press SET UP with SHIFT pressed.

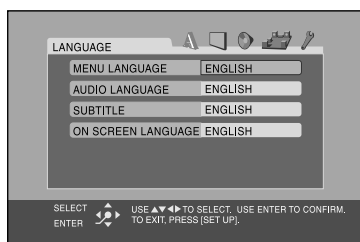

### 2 Follow the instructions that appear on the TV screen.

## Menu description

### A: Language menu (LANGUAGE)

#### ■ MENU LANGUAGE

Some DVDs have their own menus in multiple languages.

- Select the initial menu language\*.

#### ■ AUDIO LANGUAGE

Some DVDs have multiple audio languages.

- Select the initial audio language\*.

#### ■ SUBTITLE

Some DVDs have multiple subtitle languages.

- Select the initial subtitle language\*.

#### ■ ON SCREEN LANGUAGE

- Select the language shown on the TV screen when operating this system.

- \* When the language you have selected is not recorded to a disc, the original language is automatically used as the initial language.

#### NOTE

- See “The language codes list” (see page 33) for the code of each language, such as “AA”, etc.

### Picture menu (PICTURE)

#### ■ MONITOR TYPE

You can select the monitor type to match your TV when you play DVDs recorded in the picture's height/width ratio of 16:9.

- 16:9/16:9 MULTI (Wide television conversion)**  
Select this when the aspect ratio of your TV is 16:9 (wide TV).
- 4:3 LB/4:3 MULTI LB (Letter Box conversion)**  
Select this when the aspect ratio of your TV is 4:3 (conventional TV). While viewing a wide screen picture, the black bars appear on the top and the bottom of the screen.
- 4:3 PS/4:3 MULTI PS (Pan Scan conversion)**  
Select this when the aspect ratio of your TV is 4:3 (conventional TV). While viewing a wide screen picture, the black bars do not appear, however, the left and right edges of the pictures will not be shown on the screen.

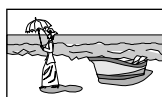

Ex.: 16:9



Ex.: 4:3 LB



Ex.: 4:3 PS

#### NOTE

- Even if “4:3 PS” or “4:3 MULTI PS” is selected, the screen size may become “4:3 LB” or “4:3 MULTI LB” with some DVDs. This depends on how DVDs are recorded.
- When selecting “MULTI” options as the monitor type for the multi-color system TV, the system outputs PAL or NTSC video signal according to the disc/file, regardless of the scan mode setting (see page 14).

## Setting DVD preferences

### ■ PICTURE SOURCE

You can obtain optimal picture quality by selecting whether the content on the disc/file is processed by field (video source) or by frame (film source).

Normally set to "AUTO".

#### • AUTO

Used to play a disc/file containing both video and film source materials.

This system recognizes the source type (video or film) of the current disc/file according to the disc/file information.

– If the playback picture is unclear or noisy, or the oblique lines of the picture are rough, try to change to other modes.

#### • FILM

Suitable for playing back a film source disc/file.

#### • VIDEO

Suitable for playing back a video source disc/file.

### ■ SCREEN SAVER (See page 17.)

You can activate or deactivate screen saver function.

### ■ FILE TYPE

When several types of files are recorded on a disc/device, you can select which files to play.

#### • AUDIO

Select this to play MP3/WMA files.

#### • STILL PICTURE

Select this to play JPEG files.

#### • VIDEO

Select this to play ASF/MPEG-2/MPEG-1/DivX files.

## Audio menu (AUDIO)

### ■ D. RANGE COMPRESSION

(Dynamic range compression)

You can enjoy low level recorded sound clearly at night even at a low volume when listening to the sound with Dolby Digital.

#### • AUTO

Select this when you want to enjoy surround sound with its full dynamic range (no effect applied).

#### • ON

Select this when you want to fully apply the compression effect (useful at midnight).

#### NOTE

- When you play a multichannel Dolby Digital source with the surround mode is off, the setting of D. RANGE COMPRESSION is set to ON automatically.

## Speaker setting menu (SPK. SETTING)

### ■ Level menu (LEVEL)

#### FRONT LEFT SPEAKER/FRONT RIGHT SPEAKER/ CENTER SPEAKER/SURROUND RIGHT SPEAKER/ SURROUND LEFT SPEAKER

While monitoring the test tone, adjust the output level of the speakers.

You can adjust the output level in the -6 dB to +6 dB range.

#### TEST TONE\*

Outputs the test tone.

\* The test tone comes out of all of the activated speakers in the following sequence:

⇒ Front left speaker ⇒ Center speaker ⇒ Front right speaker ⇒ Surround right speaker ⇒ Surround left speaker ⇒ (back to the beginning)

#### NOTE

- Adjustment of subwoofer output level is not available.

### ■ Delay menu (DELAY)

Example:

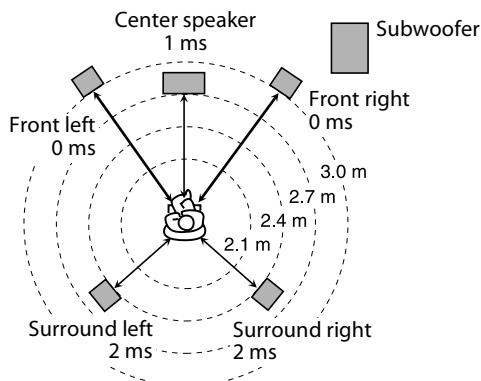

1 ms increase (or decrease) in delay time corresponds to about 30 cm decrease (or increase) in distance.

Set to "0 ms" for the furthest speaker from your position as the basis for the delay time setting.

In this case, set the delay time of each speaker as follows;

- Delay time of front speakers: 0 ms
- Delay time of center speaker: 1 ms
- Delay time of surround speakers: 2 ms

#### FRONT LEFT SPEAKER/FRONT RIGHT SPEAKER/ CENTER SPEAKER/SURROUND RIGHT SPEAKER/ SURROUND LEFT SPEAKER

Adjust the distance from the listening position to the speakers.

Within the range from 0 ms to 15 ms (by 1 ms).

## Setting DVD preferences

### ■ Subwoofer menu (SUBWOOFER)

#### LEVEL

You can set the output level of the subwoofer in the -6 dB to +6 dB range.

#### CROSS OVER

The signals below the preset frequency level will be sent to and be reproduced by the subwoofer.

Select one of the crossover frequency levels according to the size of the small speaker connected.

- **120Hz:** Select when the cone speaker unit built in the speaker is about 8 cm.
- **150Hz:** Select when the cone speaker unit built in the speaker is about 6 cm.
- **200Hz:** Select when the cone speaker unit built in the speaker is about 5 cm.

### : Other setting menu (OTHERS)

#### ■ RESUME (See page 25.)

You can activate or deactivate Resume Playback function.

#### ■ ON SCREEN GUIDE

You can activate or deactivate the on-screen guide icons. (See page 15.)

#### ■ DivX registration menu (DivX REGISTRATION)

The system has its own Registration Code for DivX playback.

You can confirm the code of your system.

- Once you play back a disc created by using the Registration Code, the system's code is overwritten by a totally different new one for copyright protection purpose.

## The language codes list

AA	Afar	EL	Greek	IN	Indonesian	ML	Malayalam	RW	Kinyarwanda	TI	Tigrinya
AB	Abkhazian	EO	Esperanto	IS	Icelandic	MN	Mongolian	SA	Sanskrit	TK	Turkmen
AF	Afrikaans	ET	Estonian	IW	Hebrew	MO	Moldavian	SD	Sindhi	TL	Tagalog
AM	Ameharic	EU	Basque	JI	Yiddish	MR	Marathi	SG	Sangho	TN	Setswana
AR	Arabic	FA	Persian	JW	Javanese	MS	Malay (MAY)	SH	Serbo-Croatian	TO	Tonga
AS	Assamese	FI	Finnish	KA	Georgian	MT	Maltese	SI	Singhalese	TR	Turkish
AY	Aymara	FJ	Fiji	KK	Kazakh	MY	Burmese	SK	Slovak	TS	Tsonga
AZ	Azerbaijani	FO	Faroese	KL	Greenlandic	NA	Nauru	SL	Slovenian	TT	Tatar
BA	Bashkir	FY	Frisian	KM	Cambodian	NE	Nepali	SM	Samoan	TW	Twi
BE	Byelorussian	GA	Irish	KN	Kannada	NL	Dutch	SN	Shona	UK	Ukrainian
BG	Bulgarian	GD	Scots Gaelic	KO	Korean (KOR)	NO	Norwegian	SO	Somali	UR	Urdu
BH	Bihari	GL	Galician	KS	Kashmiri	OC	Occitan	SQ	Albanian	UZ	Uzbek
BI	Bislama	GN	Guarani	KU	Kurdish	OM	(Afan) Oromo	SR	Serbian	VI	Vietnamese
BN	Bengali, Bangla	GU	Gujarati	KY	Kirghiz	OR	Oriya	SS	Siswati	VO	Volapuk
BO	Tibetan	HA	Hausa	LA	Latin	PA	Panjabi	ST	Sesotho	WO	Wolof
BR	Breton	HI	Hindi	LN	Lingala	PL	Polish	SU	Sundanese	XH	Xhosa
CA	Catalan	HR	Croatian	LO	Laothian	PS	Pashto, Pushto	SV	Swedish	YO	Yoruba
CO	Corsican	HU	Hungarian	LT	Lithuanian	PT	Portuguese	SW	Swahili	ZU	Zulu
CS	Czech	HY	Armenian	LV	Latvian, Lettish	QU	Quechua	TA	Tamil		
CY	Welsh	IA	Interlingua	MG	Malagasy	RM	Rhaeto-Romance	TE	Telugu		
DA	Danish	IE	Interlingue	MI	Maori	RN	Kirundi	TG	Tajik		
DZ	Bhutani	IK	Inupiak	MK	Macedonian	RO	Rumanian	TH	Thai		

# Tuner operations

The buttons described below are used on pages 34 and 35.

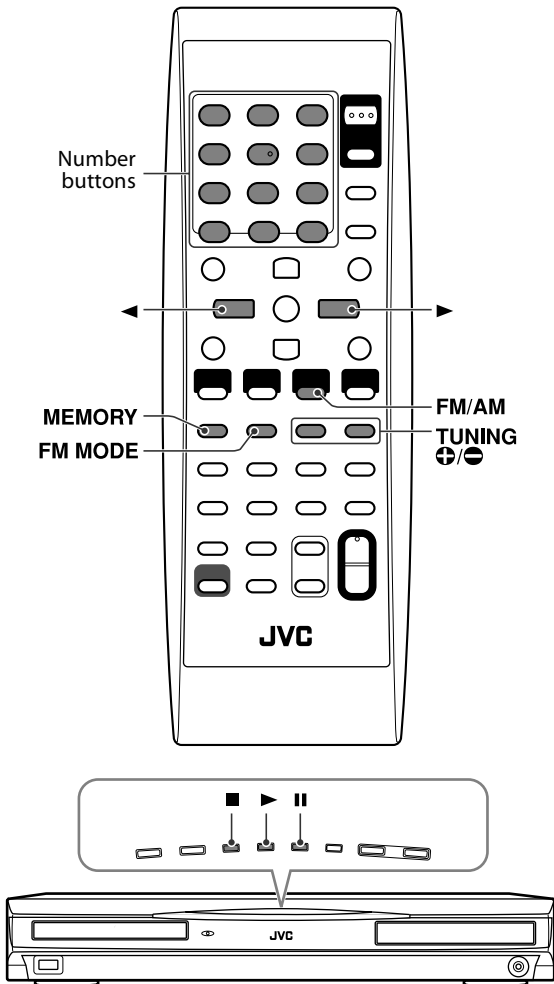

## Setting the AM tuner interval spacing

Some countries space AM stations 9 kHz apart, and some countries use 10 kHz spacing.

You can only change the AM tuner interval spacing while selecting AM as the band.

**On the center unit ONLY:**

■ To change the interval spacing into 10 kHz

**Press ■ while holding down ■.**

■ To change the interval spacing into 9 kHz

**Press ► while holding down ■.**

## Manual tuning

**1 Press FM/AM repeatedly to select the band.**

Example: When the system is tuned in to 810 kHz.

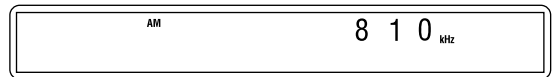

**2 Press TUNING ⊕/⊖ repeatedly until you find the frequency you want.**

When you hold down the button until the system starts searching for stations and then release it, the system stops searching automatically when a station of sufficient signal strength is tuned in to.

### NOTE

- When an FM stereo program is received, the ST indicator lights on the display window.

## Preset tuning

Once a station is assigned to a channel number, the station can be quickly tuned in. You can preset 30 FM and 15 AM stations.

### ■ To preset the stations

#### 1 Tune in the station you want to preset.

- If you want to store the FM reception mode for an FM station, select the reception mode you want. See “Selecting the FM reception mode” on the right column.

Example: When the system is tuned in to 103.5 MHz.

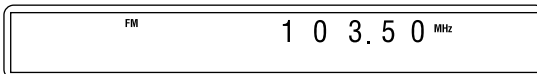

#### 2 Press MEMORY.

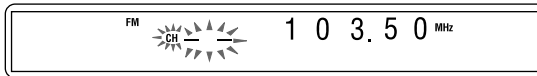

While “\_ \_” are flashing:

#### 3 Press number button(s) (1-10, ≥10) to select a preset number you want.

- For details on using the number buttons, see “How to use the number buttons”. (See page 17.)

Example: When the preset channel 1 is selected.

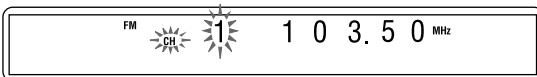

If the setting is cancelled before you finish, start from step 2 again.

While the selected number is flashing:

#### 4 Press MEMORY.

“STORED” appears on the display window. The station is assigned to the selected preset number. If the setting is cancelled before you finish, start from step 2 again.

#### 5 Repeat steps 1 to 4.

- Storing a new station to a used number erases the previously stored one.

### ■ To tune in to a preset station

#### 1 Press FM/AM repeatedly to select FM or AM.

#### 2 Press number button(s) (1-10, ≥10) to select a preset number.

- For details on using the number buttons, see “How to use the number buttons”. (See page 17.)
- You can also select a preset number by pressing Cursor ► and ◀.

## Selecting the FM reception mode

When the stereo FM program currently tuned in is noisy, you can change the FM reception mode to improve the reception.

### ■ While listening to an FM station

#### Press FM MODE.

The FM reception mode appears on the display window. Each time you press the button, the FM reception mode changes.

- **AUTO:**  
When a program is broadcast in stereo, you will hear stereo sound. (The ST indicator lights on the display window.) When in monaural, you will hear monaural sound. This mode is also useful to suppress static noise between stations.
- **MONO:**  
Reception will be improved although you will lose the stereo effect. (The MONO indicator lights on the display window.) In this mode, you will hear noise until you are tuned in to a station.

# References

## Maintenance

### ■ Handling Discs

- Remove the disc from its case by holding it at the edge while pressing the center hole lightly.
- Do not touch the shiny surface of the disc or bend the disc.
- Put the disc back in its case after use to prevent warping.
- Be careful not to scratch the surface of the disc when placing it back in its case.
- Avoid exposure to direct sunlight, extreme temperature and moisture.

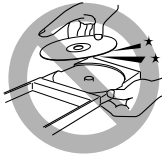

### To clean the disc

Wipe the disc with a soft cloth in a straight line from center to edge.

- **DO NOT use any solvent — such as conventional record cleaner, spray, thinner or benzine — to clean the disc.**



### ■ Cleaning the system

- Stains on the system should be wiped off with a soft cloth. If the system is heavily stained, wipe it with a cloth soaked in water diluted neutral detergent and wrung well, then wipe clean with a dry cloth.
- Since the system may deteriorate in quality, become damaged or get its paint peeled off, be careful about the following.
  - DO NOT wipe it with a hard cloth.
  - DO NOT wipe it forcefully.
  - DO NOT wipe it with thinner or benzine.
  - DO NOT apply any volatile substance such as insecticides to it.
  - DO NOT allow any rubber or plastic to remain in contact with it for a long time.

## Troubleshooting

PROBLEM	POSSIBLE CAUSE	SOLUTION
Power does not come on.	The power cord is not connected.	Connect the power cord correctly. (See page 10.)
The remote control does not work.	The batteries are exhausted.	Replace the batteries. (See page 6.)
	Sunlight is shining directly on the remote sensor.	Hide the remote sensor from direct sunlight.
The remote control does not work as expected.	The remote control mode is not for the desired source.	Before operation, press one of the source selecting buttons for the desired source.
No sound.	The speaker cord is not connected.	Check the connection. (See page 8.)
	An incorrect source has been selected.	Select the correct source. (See page 13.)
No picture is displayed on the TV screen.	The video cord is not connected correctly.	Connect the cable correctly. (See page 9.)
	The disc or file is not playable.	Use a playable disc or file. (See pages 3 and 4.)
No picture is displayed on the TV screen, the picture is blurred, or the picture is divided into two parts.	The scan mode is set to “NTSC PRG” or “PAL PRG” though the center unit is connected to the TV which does not support the progressive video input.	Change the scan mode to “PAL” or “NTSC”. (See page 14.)
Video and audio are distorted.	The disc is scratched or dirty.	Replace or clean the disc.
	A VCR is connected between the center unit and the TV.	Connect the center unit and TV directly. (See page 9.)
The picture does not fit the TV screen.	The monitor type is not set correctly.	Set “MONITOR TYPE” properly. (See page 31.)
The broadcast is hard to hear because of noise.	Antennas are disconnected.	Reconnect the antennas correctly and securely. (See page 7.)
The system suddenly turns off.	The playback level of the current source is too high.	Play back the source with lower volume level.

## Specifications

### ■ Center unit (XV-THP3)

#### Audio section

Front/Surround:	40 W per channel, RMS at 3 Ω at 1 kHz, with 10 % total harmonic distortion.
Center:	100 W, RMS at 4 Ω at 1 kHz, with 10 % total harmonic distortion.
Subwoofer:	100 W, RMS at 4 Ω at 30 Hz, with 10 % total harmonic distortion.

#### Video section

Video System:	PAL/NTSC
Horizontal Resolution:	500 lines
Signal-to-Noise Ratio:	64 dB
Video output level	
Composite:	1.0 V(p-p)/75 Ω
S-video-Y:	1.0 V(p-p)/75 Ω
S-video-C:	For PAL: 0.3 V(p-p)/75 Ω For NTSC: 0.286 V(p-p)/75 Ω
Component (Interlace/Progressive):	
Y:	1.0 V(p-p)/75 Ω
PB/PR:	0.7 V(p-p)/75 Ω

#### USB storage

USB specification:	Compatible with the USB 2.0 Full-Speed
Compatible device:	Mass Storage Class
Compatible file system:	FAT16, FAT32
Bus power supply:	Max. 500 mA

#### Tuner section

Tuning Range	
FM:	87.50 MHz to 108.00 MHz
AM:	At 10 kHz intervals 530 kHz to 1 710 kHz At 9 kHz intervals 531 kHz to 1 710 kHz

#### Speaker impedance

Front/Surround:	3 Ω to 16 Ω
Center/Subwoofer:	4 Ω to 16 Ω

#### General

Power Requirements:	AC 110 V - 240 V ~, 50/60 Hz
Power Consumption:	60 W (at operation) 1.4 W (in standby mode)
Dimensions (W × H × D):	435 mm × 70 mm × 308 mm
Mass:	3.0 kg

### ■ Subwoofer (SP-WP5)

Type:	Bass-Reflex Type
Speaker:	16 cm cone × 1
Power Handling Capacity:	100 W
Impedance:	4 Ω
Frequency Range:	35 Hz to 200 Hz
Sound Pressure Level:	75 dB/W-m
Dimensions (W × H × D):	129 mm × 284 mm × 337 mm
Mass:	3.1 kg

### ■ Satellite speakers

#### Front speakers (SP-THP3F)

Type:	1-Way Bass-Reflex Type (Magnetically-shielded Type)
Speaker:	6.5 cm cone × 1
Power Handling Capacity:	40 W
Impedance:	3 Ω
Frequency Range:	90 Hz to 20 000 Hz
Sound Pressure Level:	75 dB/W-m
Dimensions (W × H × D):	92 mm × 99 mm × 95.5 mm
Mass:	0.45 kg each

#### Center speaker (SP-THP3C)

Type:	1-Way Bass-Reflex Type (Magnetically-shielded Type)
Speaker:	6.5 cm cone × 1
Power Handling Capacity:	100 W
Impedance:	4 Ω
Frequency Range:	90 Hz to 20 000 Hz
Sound Pressure Level:	76 dB/W-m
Dimensions (W × H × D):	92 mm × 99 mm × 95.5 mm
Mass:	0.45 kg

#### Surround speakers (SP-THP3S)

Type:	1-Way Bass-Reflex Type
Speaker:	6.5 cm cone × 1
Power Handling Capacity:	40 W
Impedance:	3 Ω
Frequency Range:	90 Hz to 20 000 Hz
Sound Pressure Level:	72 dB/W-m
Dimensions (W × H × D):	92 mm × 99 mm × 95.5 mm
Mass:	0.48 kg each

Designs & specifications are subject to change without notice.

**JVC**