

JVC DVD PLAYER

XV-N320B XV-N322S

INSTRUCTIONS



EN GNT0059-004B[EK]
©2005 Victor Company of Japan, Limited
1005MOC-MW-SC

Region code of DVD VIDEO
This player can play back DVD VIDEO discs whose region code numbers include "2."
Examples of playable DVD VIDEO discs:



The player's region code is printed on the rear of the player.
Note of Color system format
This player accommodates the PAL system, and also can play back discs recorded with NTSC system. (NTSC video signals are converted to an PAL signal and output.)

Supplied accessories
If anything is missing, consult your dealer immediately.
• Remote control (x 1)
• R6(SUM-3)/AA(15F) battery (x 2)

Warnings, Cautions and Others

IMPORTANT for the U.K.
DO NOT cut off the mains plug from this equipment. If the plug fitted is not suitable for the power points in your home or the cable is too short to reach a power point, then obtain an appropriate safety approved extension lead or consult your dealer.
BE SURE to replace the fuse only with an identical approved type, as originally fitted.
If nonetheless the mains plug is cut off ensure to remove the fuse and dispose of the plug immediately, to avoid a possible shock hazard by inadvertent connection to the mains supply. If this product is not supplied fitted with a mains plug then follow the instructions given below:

IMPORTANT.
DO NOT make any connection to the terminal which is marked with the letter E or by the safety earth symbol or coloured green or green-and-yellow.
The wires in the mains lead on this product are coloured in accordance with the following code:
Blue : Neutral
Brown : Live
As these colours may not correspond with the coloured markings identifying the terminals in your plug proceed as follows:
The wire which is coloured blue must be connected to the terminal which is marked with the letter N or coloured black.
The wire which is coloured brown must be connected to the terminal which is marked with the letter L or coloured red.

IF IN DOUBT - CONSULT A COMPETENT ELECTRICIAN.

CAUTION
To reduce the risk of electrical shocks, fire, etc.:
1. Do not remove screws, covers or cabinet.
2. Do not expose this appliance to rain or moisture.

Caution — **STANDBY/ON** button!
Disconnect the mains plug to shut the power off completely. The **STANDBY/ON** button in any position does not disconnect the mains line. The power can be remote controlled.

IMPORTANT FOR LASER PRODUCTS
1. CLASS 1 LASER PRODUCT
2. **CAUTION:** Do not open the top cover. There are no user serviceable parts inside the unit; leave all servicing to qualified service personnel.
3. **CAUTION:** Visible and invisible laser radiation when open and interlock failed or defeated. Avoid direct exposure to beam.
4. REPRODUCTION OF LABEL: CAUTION LABEL, PLACED INSIDE THE UNIT.

CAUTION: Visible and invisible laser radiation when open and interlock failed or defeated. Avoid direct exposure to beam.
ADVERTISSEL: Spritzig oder strobliertes Licht bei geöffneter Abdeckung. Vermeidung direkter Exposition des Auges.
AVVERTENZA: Radiazione laser visibile e invisibile quando il coperchio è aperto e il sistema di interblocco fallisce o è disattivato. Evitare l'esposizione diretta al fascio.
VARO: Hazards in connection with the use of the laser. Do not look into the beam. Do not shine the beam on people or animals. Do not use the beam for signaling or for any other purpose.

CAUTION:
• Do not block the ventilation openings or holes. (If the ventilation openings or holes are blocked by a newspaper or cloth, etc., the heat may not be able to get out.)
• Do not place any naked flame sources, such as lighted candles, on the apparatus.
• When discarding batteries, environmental problems must be considered and local rules or laws governing the disposal of these batteries must be followed strictly.
• Do not expose this apparatus to rain, moisture, dripping or splashing and that no objects filled with liquids, such as vases, shall be placed on the apparatus.

Caution: Proper Ventilation
To avoid risk of electric shock and fire and to protect from damage, locate the apparatus as follows:
Front: No obstructions and open spacing.
Sides: No obstructions in 3 cm from the sides.
Top: No obstructions in 5 cm from the top.
Back: No obstructions in 15 cm from the back.
Bottom: No obstructions, place on the level surface.
Spacing 15 cm or more

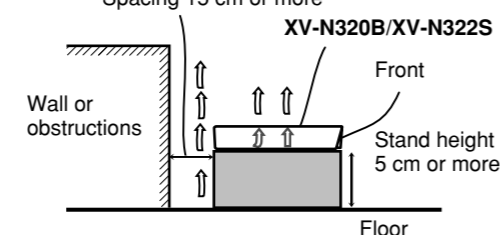

Precautions
Notes on the power cord
• When you are away on travel or otherwise for an extended period of time, remove the plug from the wall outlet. A small amount of power (1.0 W) is always consumed while the power cord is connected to the wall outlet.
• When unplugging the player from the wall outlet, always pull the plug, not the power cord.
• Do not handle the power cord with wet hands!
• Disconnect the power cord before cleaning the player or moving the player.
• Do not alter, twist or pull the power cord, or put anything heavy on it, which may cause fire, electric shock, or other accidents.
• If the cord is damaged, consult a dealer and have the power cord replaced with a new one.

Avoid moisture, water, dust, and high temperatures
• Do not place the player in moist or dusty places.
• If water gets inside the player, turn off the power and remove the plug from the wall outlet, then consult your dealer. Using the player in this state may cause a fire or electrical shock.
• Do not expose the player to direct sunlight or place it near a heating device.

Notes on installation
• Select a place which is level, dry and neither too hot nor too cold between 5°C and 35°C.
• Leave sufficient distance between the player and the TV.
• Do not install the player in a place subject to vibrations.
• Do not put heavy objects on the player.

To prevent malfunction of the player
• There are no user-serviceable parts inside. If anything goes wrong, unplug the power cord and consult your dealer.
• Do not insert any metallic objects, such as wires, hairpins, coins, etc. into the player.
• Do not block the vents. Blocking the vents may damage the player.
To clean the cabinet
• Use a soft cloth. Follow the relevant instructions on the use of chemically-coated cloths.
• Do not use benzene, thinner or other organic solvents and disinfectants. These may cause deformation or discoloring.

Playable discs

- DVD VIDEO, Audio CD, Video CD, SVCD
- DVD-R/RW written in the DVD VIDEO format
- CD-R/RW written in the SVCD, Video CD or Audio CD format
- CD-R/RW written in MP3/JPEG in accordance with the "ISO 9660" format

Supported Digital audio formats:
Linear PCM, MPEG Multichannel, Dolby Digital, DTS (Digital Theater Systems)*

NOTES
• If a disc gets dirty, scratched or warped, or due to the disc characteristics or recording conditions, the player may not be able to play back such discs.
• The player can play back audio signals recorded in MIX-MODE CD, CD-G, CD-EXTRA and CD TEXT.
• With some discs, operations may not be possible.
* To play back DTS-encoded DVD VIDEO or DTS-encoded Audio CD discs correctly, connect the player to an amplifier with a built-in DTS decoder. Otherwise, playback sound will be distorted.

Unplayable discs
If you try to play back discs listed below, noise may be generated and causes damage to speakers.
• DVD-RW written in the VR format
• DVD-ROM, DVD-RAM, DVD AUDIO, CD-ROM, PHOTO CD, SACD
• Unfinalized discs
• Discs of irregular shape or discs with tape, seals or paste on either the label side or playback side. Playing back these discs may damage the player.

The Non-DVD side of a "DualDisc" does not comply with the "Compact Disc Digital Audio" standard. Therefore, the use of Non-DVD side of a DualDisc on this product may not be recommended.

Connections

Before making connections:
• Do not connect the AC power cord until all other connections have been made.
• Connect VIDEO OUT of the player directly to the video input of your TV. Connecting VIDEO OUT of the player to a TV via a VCR/an integrated TV/Video system may cause a monitor problem.

Connecting to a TV with SCART connector

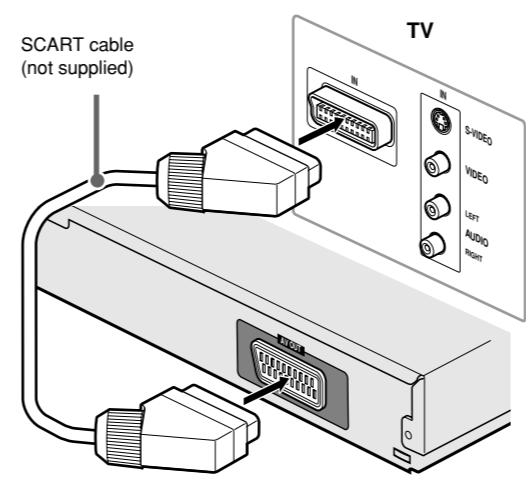

NOTE
The VIDEO jack, AV OUT terminal, and component (Y, Pb, Pr) jacks cannot be used at the same time.

Connecting to a TV with composite jacks

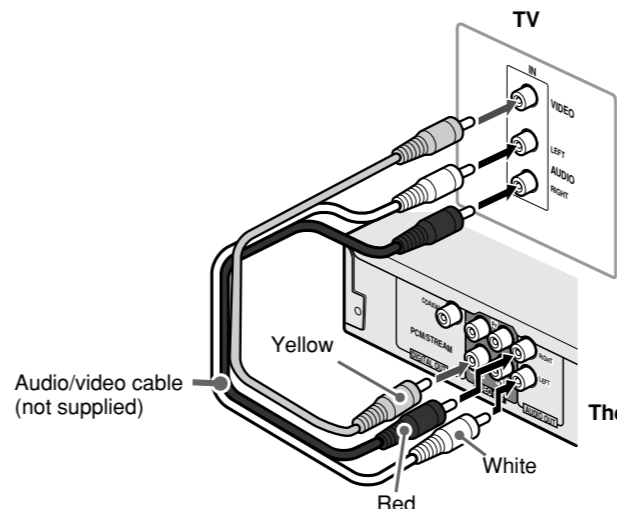

NOTES
• If your TV has a monaural audio input instead of stereo, use an optional audio cable which converts stereo audio output to monaural.
• The VIDEO jack, AV OUT terminal, and component (Y, Pb, Pr) jacks cannot be used at the same time.

Connecting to a TV with component jacks

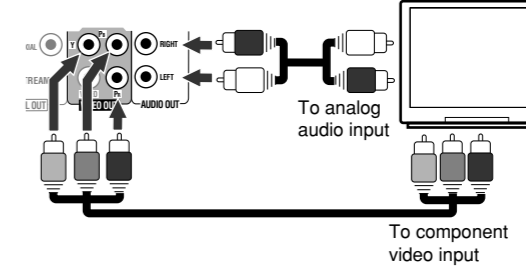

To switch the scanning mode between Progressive and Interlace, press and hold VFP-I/P on the remote control for a few seconds.

NOTES
• Connect to a TV with composite jacks and set [CONNECTIONS] to [VIDEO COMPONENT] before connecting with component jacks. (See "CONNECTIONS" in "Initial settings.")
• Connect "Y" to "Y," "Pb" to "Pb(Cb)," "Pr" to "Pr(Cr)" correctly.
• The VIDEO jack, AV OUT terminal, and component (Y, Pb, Pr) jacks cannot be used at the same time.

About the scanning mode indicator

[PICTURE SOURCE] of the PICTURE menu	Source type of DVD VIDEO	Film source	Video source
AUTO	[DDP]	[P]	[P]
FILM	[DDP]	[DDP]	[DDP]
VIDEO(NORMAL)/(ACTIVE)	[P]	[P]	[P]

NOTE
Some progressive TV and High-Definition TV sets are not fully compatible with the player. To check the compatibility of your TV, contact your local JVC customer service center.

Connecting to a stereo audio amplifier (receiver)

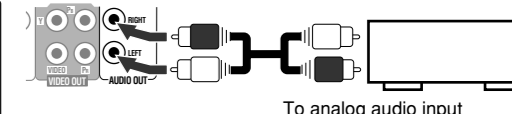

Connecting to a digital audio device
To enjoy high-quality surround sound, connect the DIGITAL OUT (COAXIAL) jack to a Dolby Digital or DTS decoder or an amplifier with a built-in decoder.

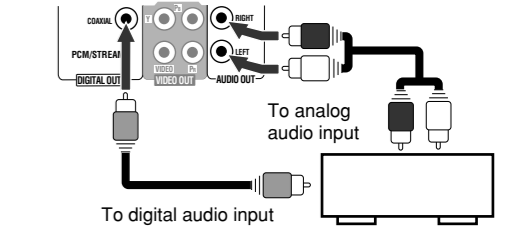

NOTES
• Depending on the disc, no signal may be outputted from the DIGITAL OUT. Make an analog connection in this case.
• Set [DIGITAL AUDIO OUTPUT] in the [AUDIO] preference display correctly according to the connected digital audio equipment. (See "DIGITAL AUDIO OUTPUT" in "Initial settings.")

Turning on the power

Inserting the AC power plug
After all other connections have been made, insert the AC power plug to the wall outlet firmly.

Installing the batteries in the remote control
Open the compartment cover, and place the two supplied R6(SUM-3)/AA(15F) batteries in the remote control according to the polarity markings ("+" and "-") inside the compartment. Then replace the cover.

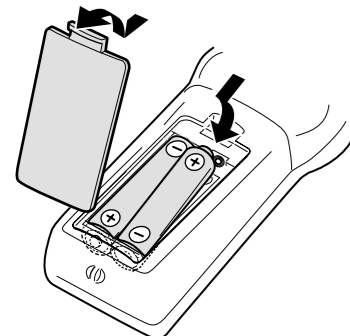

The batteries will last about six months with normal use. If the functions of the remote control become erratic, replace the batteries.

Precautions of the safe use of batteries
Observe the following precautions for the safe use of batteries. If they are used improperly their lives will be shortened, they may burst or their contents may leak.
• Remove the batteries from the remote control if it is not going to be used for a long period of time.
• Remove dead batteries and dispose of them properly.
• Never leave dead batteries lying around, take them apart, mix them with other refuse, or throw them into an incinerator.
• Never touch liquid that has leaked out of a battery.
• Do not mix new and old batteries, or batteries of different types, when placing them.

Turning on and off the player

Press **STANDBY/ON**.
When you turn on the player for the first time after purchase, the following message appears on the TV screen.
EXECUTE DVD PLAYER SETUP? - BASIC PICTURE/AUDIO SETTING
YES - PRESS ENTER NO - PRESS CANCEL
Before enjoying this player, make the initial settings as follows:
1 Press **ENTER**.
2 Press **▲/▼** to select the on-screen language for the preference displays, etc., then press **ENTER**.
3 Press **▲/▼** to select the monitor type, then press **ENTER**.
4 Press **▲/▼** to select a desired digital output signal type, then press **ENTER**.
Set this item correctly according to the logo on your receiver or decoder.
• Receiver/decoder bearing Dolby Digital logo and no DTS, select "DOLBY DIGITAL/PCM."
• Receiver/decoder bearing both Dolby Digital and DTS logos, select "STREAM/PCM."
• Receiver/decoder bearing neither Dolby Digital nor DTS logo, or digital recorder, select "PCM ONLY."

Initial setup

When you turn on the player for the first time after purchase, the following message appears on the TV screen.

EXECUTE DVD PLAYER SETUP? - BASIC PICTURE/AUDIO SETTING
YES - PRESS ENTER NO - PRESS CANCEL

Before enjoying this player, make the initial settings as follows:

- Press **ENTER**.
- Press **▲/▼** to select the on-screen language for the preference displays, etc., then press **ENTER**.
- Press **▲/▼** to select the monitor type, then press **ENTER**.
 - For a normal (conventional) TV, select "4:3 LB" or "4:3 PS." (See "MONITOR TYPE" in "Initial settings.")
 - For a wide-screen TV, select "16:9."
- Press **▲/▼** to select a desired digital output signal type, then press **ENTER**.
Set this item correctly according to the logo on your receiver or decoder.
 - Receiver/decoder bearing Dolby Digital logo and no DTS, select "DOLBY DIGITAL/PCM."
 - Receiver/decoder bearing both Dolby Digital and DTS logos, select "STREAM/PCM."
 - Receiver/decoder bearing neither Dolby Digital nor DTS logo, or digital recorder, select "PCM ONLY."

To bring up the DVD PLAYER SETUP display later
Press SET UP for a few seconds until the DVD PLAYER SETUP display appears.

Basic Operations

Turning on and off the player

Insert a disc

- Press **▲** to open the disc tray.
- Place a disc in the disc tray.
• To insert an 8-cm disc, place it in the inner recess.
- Press **▲** to close the disc tray.

With the label side up

Point toward the remote sensor directly as possible (the operating range is approx. 5 m.)

About On-screen guide icons

- ▶: Playback.
- ⏸: Pause.
- ⏮/⏭: Slow-motion playback with the current speed.
- ⏮/⏭: Fast forward/backward playback with the current speed.
- 📺: At the beginning of a scene containing multi-angle views.
- 🔊: At the beginning of a scene containing multi-audio sounds.
- 📄: At the beginning of a scene containing multi-subtitles.

You can change the setting so that the on-screen guide icons do not appear on the TV screen. (See "ON SCREEN GUIDE" in "Initial settings.")

Turning on and off the player

Open/close the disc tray

Basic playback

Buttons	To do
▶	Start/resume normal Playback
■	Stop • When RESUME is ON or DISC RESUME, this player memorizes the position on the disc where you interrupted playback. - To resume playback, press ▶. - To stop playback completely, press ■ again.
⏸	Pause • Each time you press the button, the still picture advances to the next frame.
⏮/⏭	Fast forward/backward (While paused) Slow-motion playback • Each time you press the button, the playback speed changes.
⏮/⏭	Skip chapter/track • If you press and hold the button during playback, playback is advanced/reversed at 5 times normal speed.

VARIABLE PLAYBACK (For DVD Video)
The disc is played back at about 1.2 or 1.5 times (FAST)/0.8 or 0.6 times (SLOW) normal speed. The sound is not muted, and the subtitle does not go off (except for DTS).
(For SVCD/VCD)
The disc is played back at about 2 times (FAST)/0.5 times (SLOW) normal speed.

Using the disc menu

You can operate a disc—SVCD/VCD with Playback Control* (PBC)—using the disc menu shown on the TV screen.
* A method of controlling disc play for SVCD/VCD by using the disc menu.

Turning on and off the player

Changing the display window contents

Each time you press **DISPLAY**, the display window contents changes.

Locating the beginning of a scene or song

You can select a title/chapter/track directly and start playback. For DVD Video: (While stopped) select title. (While playing back) select chapter. For SVCD/VCD/CD: Select track.
To select 5: press 5.
To select 23: press 2, then 3.
To select 40: press 4, then 0.
• If you press **TITLE/GROUP** before entering the number, you can select the title instead of the chapter.

Using the disc menu

You can operate a disc—SVCD/VCD with Playback Control* (PBC)—using the disc menu shown on the TV screen.
* A method of controlling disc play for SVCD/VCD by using the disc menu.

Turning on and off the player

Changing the display brightness

Press **DIMMER** to change the brightness of the display window.

Turning on and off the player

Open/close the disc tray

Basic playback

Buttons	To do
▶	Start/resume normal Playback
■	Stop • When RESUME is ON or DISC RESUME, this player memorizes the position on the disc where you interrupted playback. - To resume playback, press ▶. - To stop playback completely, press ■ again.
⏸	Pause • Each time you press the button, the still picture advances to the next frame.
⏮/⏭	Fast forward/backward (While paused) Slow-motion playback • Each time you press the button, the playback speed changes.
⏮/⏭	Skip chapter/track • If you press and hold the button during playback, playback is advanced/reversed at 5 times normal speed.

VARIABLE PLAYBACK (For DVD Video)
The disc is played back at about 1.2 or 1.5 times (FAST)/0.8 or 0.6 times (SLOW) normal speed. The sound is not muted, and the subtitle does not go off (except for DTS).
(For SVCD/VCD)
The disc is played back at about 2 times (FAST)/0.5 times (SLOW) normal speed.

Using the disc menu

You can operate a disc—SVCD/VCD with Playback Control* (PBC)—using the disc menu shown on the TV screen.
* A method of controlling disc play for SVCD/VCD by using the disc menu.

Turning on and off the player

Changing the display window contents

Each time you press **DISPLAY**, the display window contents changes.

Locating the beginning of a scene or song

You can select a title/chapter/track directly and start playback. For DVD Video: (While stopped) select title. (While playing back) select chapter. For SVCD/VCD/CD: Select track.
To select 5: press 5.
To select 23: press 2, then 3.
To select 40: press 4, then 0.
• If you press **TITLE/GROUP** before entering the number, you can select the title instead of the chapter.

Using the disc menu

You can operate a disc—SVCD/VCD with Playback Control* (PBC)—using the disc menu shown on the TV screen.
* A method of controlling disc play for SVCD/VCD by using the disc menu.

Turning on and off the player

Changing the display brightness

Press **DIMMER** to change the brightness of the display window.

Advanced Operations

Changing the language, sound and scene angle

- Press the button.
- Press the button repeatedly or **▲/▼** to select the desired item.
- Press **ENTER** to finish the setting.

Buttons	To do
AUDIO	For DVD Video: select audio languages. For SVCD/VCD: select the audio channel.
SUBTITLE	select the subtitle.
ANGLE	select the view-angle.

Changing the Sound Field

Each time you press **SOUND EFFECT**, the Sound Effect mode changes.
• As the value becomes bigger, the Sound Effect works stronger.

Zooming the picture

Each time you press **ZOOM**, the magnification changes.
• You can use **▲/▼/◀/▶** button to move the zoomed position.
To return to the normal playback, select the normal size by pressing **ZOOM** repeatedly.

Changing the picture tone (VFP)

The VFP (Video Fine Processor) function allows you to adjust the picture character according to the type of programming, picture tone or personal preferences.
1 Press **VFP-I/P**.
2 Press **◀/▶** to select the desired preset.

Parameter	Selected Preset
GAMMA	MID
BRIGHTNESS	+4
CONTRAST	+3
SATURATION	+3
TINT	+3
SHARPNESS	LOW
Y DELAY	+2

Normal For watching TV in a general room.
CINEMA For watching a movie software in a room with suppressed light.
USER1 USER2 You can adjust parameters that affect the picture character and store the settings as a user preset. See below.

To adjust the picture tone

- Select "USER1" or "USER2."
- Press **▲/▼** to select a parameter, then press **ENTER**.
- Press **▲/▼** to adjust the parameter, then press **ENTER**.
- Repeat step 2 and 3 to adjust other parameters.
- Press **VFP-I/P** to finish the setting.

* Adjustable when setting [CONNECTIONS] in the Initial settings to [VIDEO COMPONENT] or [SCART S-VIDEO].

Menu bar functions

You can use various functions from the menu bar.

To bring up the menu bar

When a disc is inserted, press ON SCREEN twice.

A menu bar for the type of disc inserted will appear under the status bar.

Ex.: Menu bar for DVD VIDEO



To dismiss the menu bar and the status bar, press ON SCREEN.

Basic operation procedure

1 Press ◀▶ to select the icon you want to work with. 2 Press ENTER.

After pressing ENTER:

- When a pull-down menu appears, press ▲/▼ to select the setting you want, then press ENTER.
- When a number-entry box appears, use the numeric buttons to enter the number you want, then press ENTER.

- When changing **TIME** setting, press ENTER repeatedly to select the setting you want.

NOTES

- The selected item on the menu bar is shown in green.
- The available functions differ depending on the player status. Refer to the explanation below to check when you can use a certain function.

Menu bar functions

TIME selects the time mode shown in the display window and the status bar.

- TOTAL:** Elapsed time of current title (DVD) or a disc (CD/VCD/SVCD)
- T.REM:** Remaining time of current title (DVD) or a disc (CD/VCD/SVCD) (Except for DVD: while stopped, disc total time)
- TIME:** Elapsed time of current chapter (DVD) or track (CD/VCD/SVCD)
- REM:** Remaining time of current chapter (DVD) or track (CD/VCD/SVCD) (while stopped, current track total time)

 selects repeat mode.

DVD: During playback
CD: In any condition
VCD/SVCD: In any condition except PBC playback
CHAPTER: Current chapter repeat (DVD)
TITLE: Current title repeat (DVD)
TRACK: Current track repeat (CD/VCD/SVCD)
ALL: All track repeat (CD/VCD/SVCD)
A-B: A-B repeat (During playback). After selecting A-B, press ENTER at the beginning point of repeat, then press ENTER again at the end point.

- OFF:** Repeat mode deactivated. Select this to quit repeat mode.

 specifies beginning point of a title (DVD) or a disc (CD/VCD/SVCD) by the time.
DVD: In any condition
CD: In any condition except program or random playback

VCD/SVCD: In any condition except PBC or program or random playback

 specifies a chapter to play back from (DVD only).

 selects the audio language (DVD), sound track (DVD), or audio channel (VCD/SVCD) during playback.

 selects the subtitle language (DVD) or subtitle (SVCD) during playback.

 selects a desired scene angle in a multi-angle part (DVD only).

PROG. specifies the playback order of tracks while stopped (unavailable for DVD). You can program up to 99 tracks.

1. After selecting **PROG.** icon, press the numeric buttons to specify tracks in the desired order.

- To correct the program, press ▲/▼ to move  to the track to be corrected, then press CANCEL. The track is erased and the subsequent programmed tracks move up.

Pressing  clears all the programmed tracks.

2. Press  (SELECT) to start program playback.

- During program playback, you cannot edit the program contents.

- To exit the program mode, press ON SCREEN after clearing the program.

RND. activates random playback while stopped (unavailable for DVD).

After selecting **RND.** icon, press ENTER.

The player starts random playback.

Audio/Video files playback

You can play back MP3/JPEG files on a CD/CD-R/RW.

Precautions

- Use "ISO 9660" as the disc format.
- The player does not support "packet writing (UDF files)" discs.
- The player supports discs recorded with up to five multiple sessions.
- The player may be unable to play back a disc due to the characteristics or recording conditions.
- The player recognizes up to the fifth layer of groups, 999 files per group (including unplayable files), and up to 250 groups per disc.
- Add the appropriate extension (*.mp3 and ".jpg") to the file name.
- MP3i and MP3 Pro are not available.
- The player cannot play back a picture of more than 5120 x 3413 pixels (baseline JPEG) or 2048 x 1536 pixels (progressive JPEG).

Selecting a specific file or group

You can select files or folders (groups) using the Control display on the TV screen.

Control display

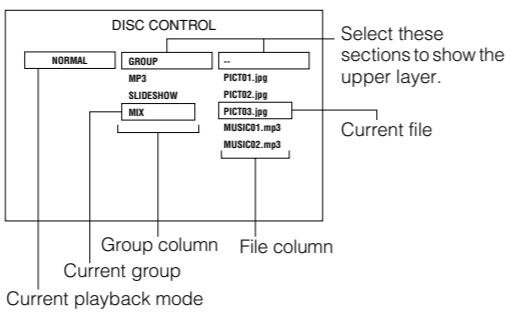

Press ▲/▼/◀▶ to move the cursor bar to a desired file, then press  (SELECT).

- When you press ENTER, only the selected file is played back (except for MP3 files).

Various playback mode



- To play back a disc continuously, select NORMAL.

Repeat playback



1. While stopped, press ▲/▼/◀▶ to move the cursor bar to playback mode.

2. Press ENTER repeatedly to select the desired repeat mode.



- REPEAT 1: Repeats the current file.
- REPEAT GROUP: Repeats all files in the current group.
- REPEAT ALL: Repeats all files on the disc.

3. Press  to move the cursor bar to the file column, then press  (SELECT).

Random playback

- While stopped, press ▲/▼/◀▶ to move the cursor bar to playback mode.
- Press ENTER repeatedly to select RANDOM.
- Press  to move the cursor bar to the file column, then press  (SELECT).

Program playback

- While stopped, press ▲/▼/◀▶ to move the cursor bar to playback mode.
- Press ENTER repeatedly to select PROGRAM.
- Press ▲/▼/◀▶ to select the desired file, then press ENTER.
- Repeat step 3 until all the desired files are selected.
 - To erase the last programmed file, press  to move the cursor bar to the programmed files column, then press CANCEL.
- Press  (SELECT).

Various JPEG files playback

To zoom in a picture

Press ZOOM.



Each time you press ZOOM, you can magnify a JPEG file (x1.5/x2).

NOTE

This function is not available for some JPEG files depending on their resolution size and JPEG format.

To rotate/reflect a still picture

While a still picture is played back:

- Pressing  rotates the picture by 90°.
- Pressing  reflects the picture vertically.
- Pressing  reflects the picture horizontally.

To select a JPEG files from the thumbnail list

1. Press and hold THUMBNAIL/LIST while a JPEG file is selected on the Control display.

2. Press ▲/▼/◀▶ to select the desired picture, then press ENTER.

- You can change the page of thumbnail list by pressing /▶.

Slide show playback of JPEG files

Press  (SELECT) while a JPEG file is selected on the Control display.

- To select slide show effect

Press and hold ANGLE-SLIDE EFFECT until [SLIDE EFFECT MODE:] and the current mode appears on the TV screen.

By pressing and holding the button repeatedly, you can select the effect from 11 effects, random effect selection (RAND), and no effect (NONE).

The effect is not applied to progressive JPEG files.

Initial settings

You can change the settings of this player according to your preferences and playing environment.

How to set the Initial settings

- Press SET UP.**
- Press ▲/▼ to select the menu.**
- Press  to move to select the item.**
- Press ENTER.**
- Press ▲/▼ to select the options, then press ENTER.**

To dismiss a preference display

Press SET UP.

LANGUAGE menu

Item	Contents
MENU LANGUAGE	You can select the default menu language of DVD VIDEO.
AUDIO LANGUAGE	You can select the default audio language of DVD VIDEO.
SUBTITLE	You can select the default subtitle language of DVD VIDEO.
ON SCREEN LANGUAGE	You can select "ENGLISH," "FRENCH," or "GERMAN" as the on-screen language.

PICTURE menu

Item	Contents
MONITOR TYPE	You can select the monitor type to match your TV when you play back DVD VIDEO discs recorded for wide-screen televisions. <p>[16:9] (Wide television screen): For a wide-screen (16:9) TV.</p> <p>[4:3 LB] (Letter Box conversion): For a normal (4:3) TV. Displays a wide-screen picture to fit the width of the TV screen keeping the aspect ratio.</p> <p>[4:3 PS] (Pan Scan conversion): For a normal (4:3) TV. The picture is zoomed up to filling the screen vertically and the left and right sides of the picture are cut off.</p>
PICTURE SOURCE	You can obtain optimal picture quality by selecting the source type of the disc contents. <p>[AUTO]: Normally, select this option. The player recognizes the picture type (film or video source) of the current disc according to the disc information.</p> <p>[FILM]: For a film source disc.</p> <p>[VIDEO(NORMAL)]: For a video source disc with relatively a few movements.</p> <p>[VIDEO(ACTIVE)]: For a video source disc with relatively a lot of movements.</p>
SCREEN SAVER	You can set the screen saver function to ON or OFF.
CONNECTIONS	You need to select the video signal type when you connect the player to a TV with a SCART connector. <p>[VIDEO COMPONENT]: A TV accommodates component signals.</p> <p>[SCART S-VIDEO]: A TV accommodates S-video (Y/C) signals.</p> <p>[SCART RGB]: A TV accommodates RGB signals.</p> <p>Note: If a TV accommodates composite signals, select [VIDEO COMPONENT] or [SCART RGB].</p>
BACKGROUND	You can use your favorite image as the opening display. <p>[STANDARD]: Display the JVC original image.</p> <p>[USER]: Display your favorite image as the opening display when a JPEG image is registered.</p> <p>[SAVE AS BACKGROUND]: To register a new image, select this while a JPEG image is displayed on the TV.</p>

Specifications

Specifications and appearance are subject to change without prior notice.

General

Readable discs:

DVD VIDEO, DVD-R (Video format), DVD-RW (Video format), SVCD, Video CD, Audio CD (CD-DA), CD-R/RW (CD-DA, SVCD, Video CD, MP3 format, JPEG)

Video format: PAL, 625i/625p selectable

Other

Power requirements: AC 230 V ~ , 50 Hz

Power consumption:

11.0 W (POWER ON), 1.0 W (STANDBY mode)

Mass: 1.5 kg

Dimensions (W x H x D):

435 mm x 44 mm x 201.5 mm

Video outputs

VIDEO OUT (pin jack): 1.0 Vp-p (75 Ω)

RGB Output: 700 mVp-p (75 Ω)

Component (pin jacks)

Y Output: 1.0 Vp-p (75 Ω)

Pa/Pb Output: 0.7 Vp-p (75 Ω)

Horizontal resolution: 500 lines or more

Audio outputs

ANALOG OUT (pin jack): 2.0 Vrms (10 kΩ)

DIGITAL OUT (COAXIAL): 0.5 Vp-p (75 Ω termination)

Audio characteristics

Frequency response

CD (sampling frequency 44.1 kHz): 2 Hz to 20 kHz

DVD (sampling frequency 48 kHz):

2 Hz to 22 kHz(4 Hz to 20 kHz for DTS and Dolby Digital bitstream signals)

DVD (sampling frequency 96 kHz): 2 Hz to 44 kHz

Wow and flutter: Unmeasurable (less than ± 0.002%)

Total harmonic distortion: less than 0.009%

AUDIO menu

Item	Contents
DIGITAL AUDIO OUTPUT	Set this item correctly according to the logo on your receiver or decoder. <p>[PCM ONLY]: Receiver/decoder bearing neither Dolby Digital nor DTS logo, or digital recorder.</p> <p>[DOLBY DIGITAL/PCM]: Receiver/decoder bearing Dolby Digital logo and no DTS. [STREAM/PCM]: Receiver/decoder bearing both Dolby Digital and DTS logos.</p>
ANALOG DOWNMIX	Set this item properly according to your analog audio connection to play the sound of the surround multichannel audio on a DVD VIDEO. <p>[DOLBY SURROUND]: Select this when connecting to a surround decoder.</p> <p>[STEREO]: Select this when connecting to a stereo amplifier or TV, or in case you want to record from a DVD VIDEO to a MiniDisc, cassette, etc.</p>
D.RANGE CONTROL	Set this item to listen to DVD VIDEO recorded in Dolby Digital format at low or middle volume. <p>[WIDE RANGE]: You can enjoy powerful playback sound.</p> <p>[NORMAL]: Normally, select this.</p> <p>[TV MODE]: Select this if the sound level of DVD VIDEO is lower than the one of TV program to make the sound at a lower volume clear.</p>
OUTPUT LEVEL	Set this item to attenuate the level of the signal output from the analog AUDIO OUT terminals. If the sound from the speaker is distorted, select [LOW].

OTHERS menu

Item	Contents
RESUME	You can select the resume playback mode. <p>[ON]: The player resumes playback from the position where playback has been stopped if the disc is still in the disc tray.</p> <p>[OFF]: This function is deactivated.</p> <p>[DISC RESUME]: The player resumes playback of the last 10 discs played. The player retains a memory of the stopped position of each disc even if the disc is removed from the disc tray.</p>
ON SCREEN GUIDE	Activate or deactivate the on-screen guide.
AUTO STANDBY	Set the time until the player turns off (into standby) automatically if playback is stopped for more than 30 minutes or 60 minutes.
PARENTAL LOCK	Select this item, then press ENTER to show the PARENTAL LOCK menu for limiting playback by children. Scenes which are limited by this function are not played or replaced with other scenes. <p>[COUNTRY CODE]: Select the code of your country/area.</p> <p>[SET LEVEL]: Select the level of restriction. ("1" is the strictest.)</p> <p>[PASSWORD]: Enter your 4-digit password by pressing the numeric buttons (0 to 9).</p> <p>[TEXT]: Select this and press ENTER to go back to the OTHERS menu.</p> <p>Notes:</p> <ul style="list-style-type: none">Some DVD VIDEO cannot be played by this function. If you try to play such a disc, the PARENTAL LOCK menu appears on the TV and asks whether you want to release the lock or not. To release the lock and play, select "TEMPORARY RELEASE," press ENTER, then enter your password. Otherwise, eject the disc. To change the setting of the limitation, you need to enter your password. If you forget your password, enter "8888."

SAFETY INSTRUCTIONS

“SOME DOS AND DON'TS ON THE SAFE USE OF EQUIPMENT”

SAFETY INSTRUCTIONS

This equipment has been designed and manufactured to meet international safety standards but, like any electrical equipment, care must be taken if you are to obtain the best results and safety is to be assured.

Do read the operating instructions before you attempt to use the equipment.

Do ensure that all electrical connections (including the mains plug, extension leads and interconnections between pieces of equipment) are properly made and in accordance with the manufacturer's instructions. Switch off and withdraw the mains plug when making or changing connections.

Do consult your dealer if you are ever in doubt about the installation, operation or safety of your equipment.

Do be careful with glass panels or doors on equipment.

DON'T continue to operate the equipment if you are in any doubt about it working normally, or if it is damaged in any way—switch off, withdraw the mains plug and consult your dealer.

DON'T remove any fixed cover as this may expose dangerous voltages.

DON'T leave equipment switched on when it is unattended unless it is specifically stated that it is designed for unattended operation or has a standby mode.

Switch off using the switch on the equipment and make sure that your family know how to do this.

Special arrangements may need to be made for infirm or handicapped people.

DON'T use equipment such as personal stereos or radios so that you are distracted from the requirements of traffic safety. It is illegal to watch television whilst driving.

DON'T listen to headphones at high volume as such use can permanently damage your hearing.

DON'T obstruct the ventilation of the equipment, for example with curtains or soft furnishings.

Overheating will cause damage and shorten the life of the equipment.

DON'T use makeshift stands and NEVER fix legs with wood screws — to ensure complete safety always fit the manufacturer's approved stand or legs with the fixings provided according to the instructions.

DON'T allow electrical equipment to be exposed to rain or moisture.

ABOVE ALL

—NEVER let anyone, especially children, push anything into holes, slots or any other opening in the case—this could result in a fatal electrical shock.;

—NEVER guess or take chances with electrical equipment of any kind—it is better to be safe than sorry!

Troubleshooting

Power

Power does not come on.

- Power plug is not inserted securely. Plug in securely.

Operation

“REGION CODE ERROR!” is shown on the TV.

→ Region code of the inserted disc does not match the player. Check the region code of the disc printed on the disc jacket.





Operation is not possible.

→ Microcomputer malfunction due to lightning or static electricity. Turn off the power and unplug the power cord, then connect the power cord again.

→ Moisture condensation caused by a sudden change of temperature or humidity. Turn off the power, then turn it on a few hours later.

→ The disc does not allow the operation, or an unplayable disc is inserted. Check and replace the disc.

[LOCK] is displayed on the display window and the disc tray does not open.

→ When you press  while pressing down  on the player in standby mode, the tray lock function is activated. The disc tray cannot be opened or closed in this status. To release this status, press  while pressing down  on the player control mode.

Picture

Picture is noisy.

→ The player is connected to a VCR directly and the copyguard function is activated. Connect the player so that the picture signal flows directly to the TV. With some discs, the picture may be blurred when [PICTURE SOURCE] is set to [FILM] or [AUTO]. Set [PICTURE SOURCE] to [VIDEO (NORMAL)] or [VIDEO (ACTIVE)].

No picture is displayed on the TV screen or the screen is blurred or divided into two parts.

→ The player is in the progressive scanning mode though it is connected to a TV via the VIDEO or SCART connector. Observe the display window. If [P] is turned on, the player is in the progressive scanning mode.

Make the Progressive scanning mode inactive by using the VFP - I/P button.

9

Troubleshooting

Audio

DVD VIDEO disc playback sound level is lower than TV broadcast sound level.

→ Set the [D.RANGE CONTROL] preference to [TV MODE].

Analog audio output is distorted.

→ Set the [OUTPUT LEVEL] preference to [LOW].

MP3/JPEG

No sound and/or no picture comes out.

→ MP3/JPEG disc is recorded with the "packet writing (UDF file)." It cannot be played. Check the files you want to play back.

Files (tracks) are not played in the recorded order.

→ This player plays the files in the alphabetic order. So, the playback order can vary.

Country/Area code list for Parental Lock

AD Andorra	CY Cyprus	IL Israel	IV Maldives	SO Somalia
AE United Arab Emirates	IN India	IZ Czech Republic	MW Malawi	SR Suriname
AF Afghanistan	DE Germany	IO British Indian Ocean Territory	MX Mexico	ST Sao Tome and Principe
AG Antigua and Barbuda	DJ Djibouti	IQ Iraq	MY Malaysia	SV El Salvador
AI Anguilla	DK Denmark	IR Iran (Islamic Republic of)	MZ Mozambique	SY Syrian Arab Republic
AL Albania	DM Dominica			