

JVC[®]

NETWORK PACK

KA-DV300

User's Guide

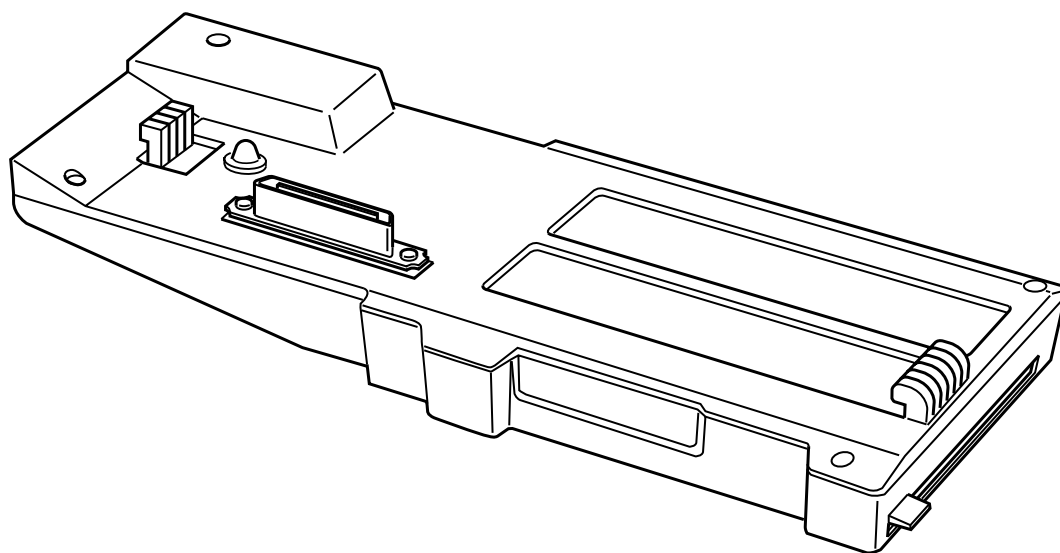

When attaching Network Pack KA-DV300 to DV Camcorder GY-DV300, network related menus are added to the GY-DV300 menu screen.

This User's Guide explains settings for the network related menus, operation for recording streaming data to a CF (Compact Flash) memory card and operation for sending streaming data using a LAN card. When a LAN card is connected, menu screen settings for the Network Pack and GY-DV300 can be operated from your PC.

Contents

Introduction

Inserting/removing CF memory card/LAN card	3
LCD screen/viewfinder screen	4

Menu screen

Menu screen structure	5
NETWORK PACK CONFIG menu screen items	6
Setting the NETWORK PACK CONFIG menu screen	8
Returning the NETWORK PACK CONFIG menu screen to factory settings	9

Network settings

Setting the NETWORK SET menu screen	10
NETWORK SET menu screen items	11
Making network related settings	12
Detailed IP settings (LAN)	13
Detailed network settings (WLAN)	14

Recording on a CF card

Formatting a CF memory card	16
CF memory recording time	16
Recording video on a DV cassette tape and CF memory card	17
Recording video on a CF memory card only	18
Recording playback signals of a DV cassette tape on a CD memory card	19
Deleting all clip files on a CF memory card	20

Movie clips

Playing back video/audio recorded on a CF memory card	21
Protecting a clip file on a CF memory card	23
Deleting a clip file on a CF memory card	24
Playing back CF memory card clips on your PC	25

LAN card

Sending video using LAN card while recording on a DV cassette tape	26
Sending video using a LAN card (no DV cassette tape recording)	27
Sending playback signals of a DV cassette tape using a LAN card	28

NETWORK PACK SETUP

Controlling GY-DV300/KA-DV300 via LAN card	29
CAMERA CONTROL screen	30
NETWORK SETUP screen	31
PORT SETUP screen	32
ENCODE PARAMETERS screen	33
VTR CONTROL screen	34
STREAM CAPTURE screen (Playing back video/audio using a PC and saving to file)	35

Others

Trouble shooting	37
Checking communication/connection	39
Terminology	40

Characters and symbols used in this instruction book

CAUTION	Cautionary notes concerning operation of the unit
MEMO	Reference such as restrictions of features, etc.
	Reference page or item

* In general, the names of products manufactured by other companies and mentioned in these instructions are trademarks or registered trademarks of these companies.
Symbols like ™, ©, ®, etc., are not used in these instructions.

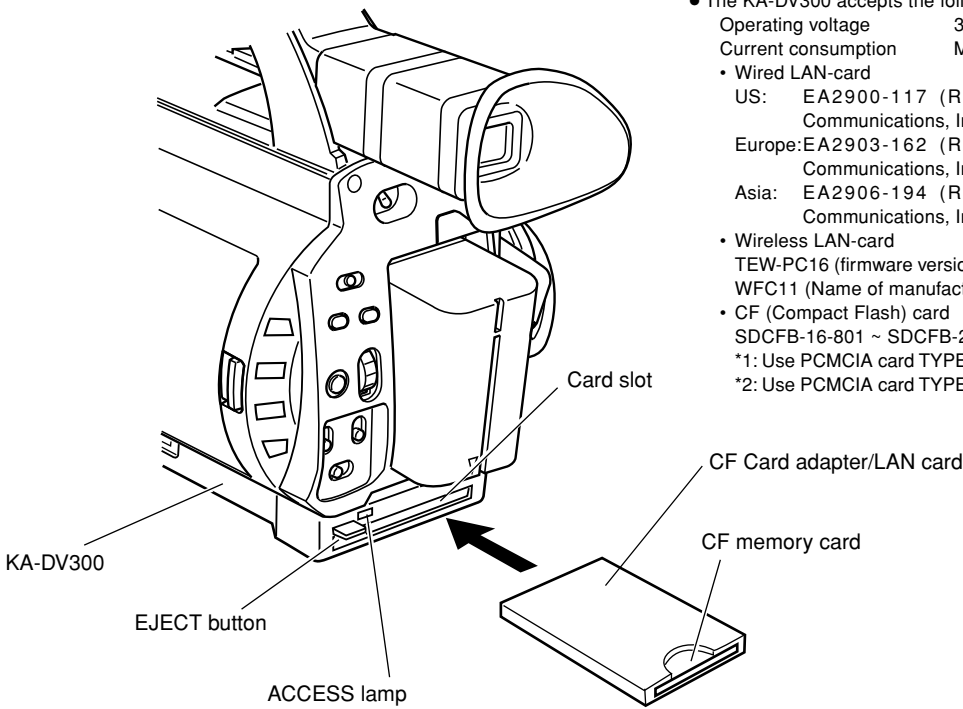

- The KA-DV300 accepts the following cards for which operation has been confirmed:
 - Operating voltage 3.3 V
 - Current consumption Max. 300 mA
 - Wired LAN-card
 - US: EA2900-117 (Revision C) (Name of manufacturer: Socket Communications, Inc)^{*1}
 - Europe:EA2903-162 (Revision C) (Name of manufacturer: Socket Communications, Inc)^{*1}
 - Asia: EA2906-194 (Revision C) (Name of manufacturer: Socket Communications, Inc)^{*1}
 - Wireless LAN-card
 - TEW-PC16 (firmware version 0.8.3 or later) (Name of manufacturer: TRENDware)
 - WFC11 (Name of manufacturer: LINKSYS)^{*2}
 - CF (Compact Flash) card
 - SDCFB-16-801 ~ SDCFB-256-801 (Name of manufacturer: SunDisk)^{*1}
- *1: Use PCMCIA card TYPE I or TYPE II adapter
*2: Use PCMCIA card TYPE II adapter

Caution

- Make sure the power of GY-DV300 is off when inserting/removing a CF memory card/LAN card. Inserting/removing a card with the unit power on may damage the data storage section of the CF memory card or the card itself.
- Do not use the wireless LAN card continuously for more than 48 hours.

Inserting card

1. Turn off the GY-DV300 power.
2. Insert a card into the KA-DV300 card slot.
3. Turn on the GY-DV300 power.

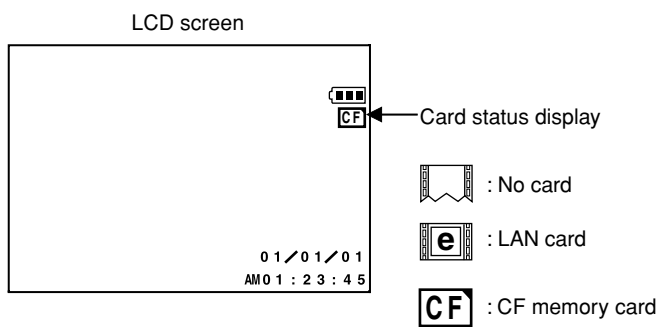

- Card status according to the inserted card type is displayed on the LCD screen/viewfinder screen. (☞ page 4)

Memo

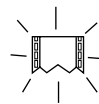

When turning the power on, the card status display shown on left will flash during initialization.

Removing card



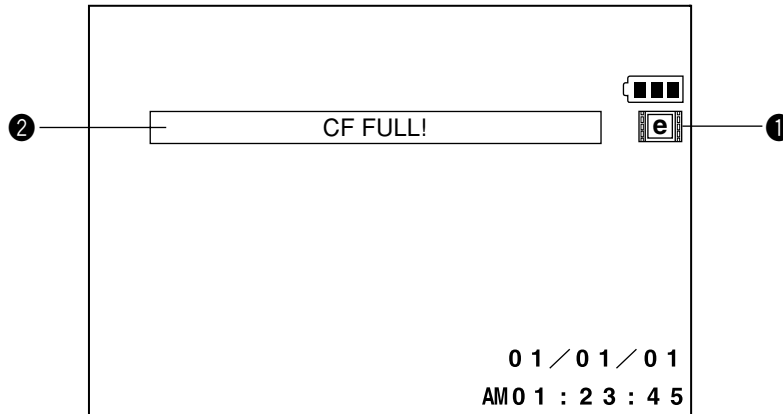

- Check to make sure the ACCESS lamp of KA-DV300 is off. The ACCESS lamp will light when the card is in operation.

1. Turn off the GY-DV300 power.
2. Press the EJECT button of KA-DV300 and remove the card.

Information from Network Pack KA-DV300 is displayed on the GY-DV300 LCD screen/viewfinder screen.

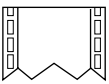
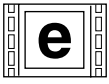
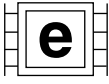
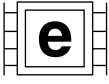

① Card status displays

Display	Description
	No card is inserted in Network Pack. Flashing display during initialization (after power on).
 (White display)	LAN card is inserted in Network Pack.
 (Yellow display)	Video/audio data is being sent from LAN card.
 (Red display)	Video/audio data from LAN card is being recorded by remote media.
 (White display)	CF memory card is inserted in Network Pack.
 (Red display)	CF memory card is being recorded with data.
 Flashing display	Card is inserted in Network Pack but transmission is not available. There is possibility of unit malfunction. Contact your nearest JVC dealer.

② CF Memory card warning display

Displays CF memory card status and system errors.

* For details concerning warning displays, see page 37.

Menu screen

Menu screen structure

When attaching Network Pack KA-Dv300 to DV Camcorder GY-DV300, NETWORK PACK CONFIG menu and MOVIE CLIP menu are added to the GY-DV300 TOP MENU screen.

MODE switch: When CAM-A or CAM-B is selected

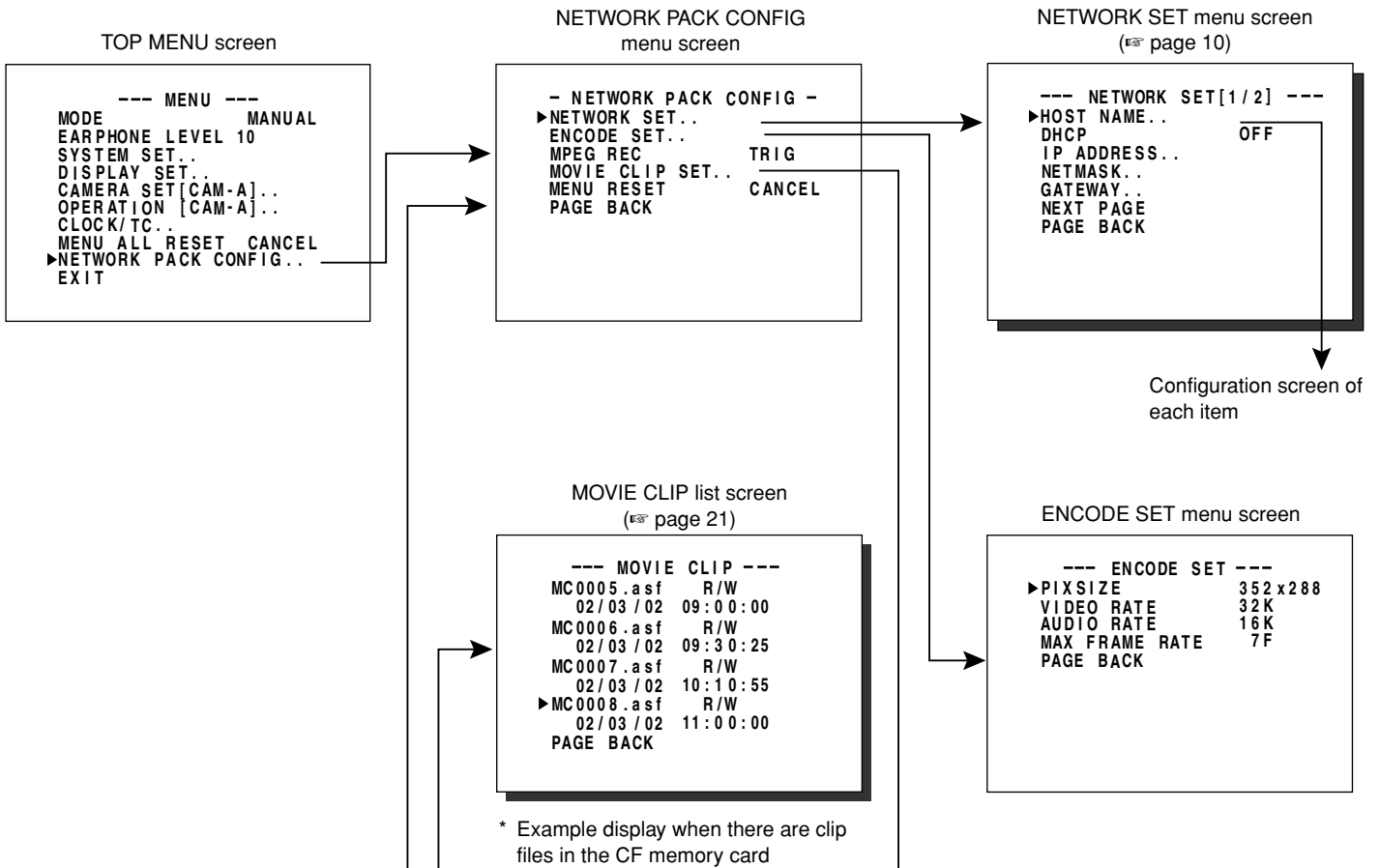

When MODE switch: VTR is selected.



Menu screen

NETWORK PACK CONFIG menu screen items

● indicates default factory setting.

Item	Setting	Description																												
NETWORK SET		Displays menu screen for network related settings such as DHCP, IP address, subnet mask, etc. (page 11)																												
ENCODE SET		Displays menu screen for setting video and audio compressions.																												
PIX SIZE	●352 X 288 176 X 144	Sets the video compression size. 352 X 288: Sets the image size to 352 X 288 pixels. (CIF) 176 X 144: Sets the image size to 176 X 144 pixels. (QCIF) (1/4 image size of CIF.)																												
VIDEO RATE	●32K 64K 128K 256K 384K	Sets the video streaming speed (Kbps).																												
AUDIO RATE	OFF ●16K 32K	Sets the audio streaming speed (Kbps).																												
MAX FRAME RATE (): for E model	30F (25F) 15F (13F) ●7F (6F) 4F (3F)	Sets the frame rate per second. 30F (25F): Transfer is made using the frame rate of the original video. 15F (13F): Transfer is made using maximum of 1/2 the frame rate of the original video. 7F (6F): Transfer is made using maximum of 1/4 the frame rate of the original video. 4F (3F): Transfer is made using maximum of 1/8 the frame rate of the original video.																												
<p>Memo</p> <p>The relationship of PIX SIZE, VIDEO RATE and MAX FRAME RATE are as follows:</p> <table border="1" style="width: 100%; border-collapse: collapse;"> <thead> <tr> <th rowspan="2">VIDEO RATE (Kbps)</th> <th colspan="2">PIX SIZE</th> <th rowspan="2">VIDEO RATE (Kbps)</th> <th colspan="2">PIX SIZE</th> </tr> <tr> <th>352 X 288</th> <th>176 X 144</th> <th>352 X 288</th> <th>176 X 144</th> </tr> </thead> <tbody> <tr> <td>384K</td> <td>15 (12) FRAMES</td> <td>30 (25) FRAMES</td> <td>64K</td> <td>15 (12) FRAMES</td> <td>30 (25) FRAMES</td> </tr> <tr> <td>256K</td> <td>15 (12) FRAMES</td> <td>30 (25) FRAMES</td> <td>32K</td> <td>7 (6) FRAMES</td> <td>30 (25) FRAMES</td> </tr> <tr> <td>128K</td> <td>15 (12) FRAMES</td> <td>30 (25) FRAMES</td> <td></td> <td></td> <td></td> </tr> </tbody> </table>			VIDEO RATE (Kbps)	PIX SIZE		VIDEO RATE (Kbps)	PIX SIZE		352 X 288	176 X 144	352 X 288	176 X 144	384K	15 (12) FRAMES	30 (25) FRAMES	64K	15 (12) FRAMES	30 (25) FRAMES	256K	15 (12) FRAMES	30 (25) FRAMES	32K	7 (6) FRAMES	30 (25) FRAMES	128K	15 (12) FRAMES	30 (25) FRAMES			
VIDEO RATE (Kbps)	PIX SIZE			VIDEO RATE (Kbps)	PIX SIZE																									
	352 X 288	176 X 144	352 X 288		176 X 144																									
384K	15 (12) FRAMES	30 (25) FRAMES	64K	15 (12) FRAMES	30 (25) FRAMES																									
256K	15 (12) FRAMES	30 (25) FRAMES	32K	7 (6) FRAMES	30 (25) FRAMES																									
128K	15 (12) FRAMES	30 (25) FRAMES																												
PAGE BACK		Pressing the SELECT dial returns to the NETWORK PACK CONFIG menu screen.																												
MPEG REC	●TRIG SPLIT OFF	Selects the operation method for recording video data to a CF memory card or sending data to a remote media from a LAN card. TRIG: Pressing the REC START/STOP button of GY-DV300 starts operation. Use this setting when simultaneously recording to a DV tape. SPLIT: Pressing the SELECT dial starts operation. Use this setting when recording or transferring with CF memory card or LAN card only. OFF: Pressing the REC START/STOP button or SELECT dial will not start recording to CF memory card or transmission from LAN card.																												

→ OVER

Menu screen

NETWORK PACK CONFIG menu screen items

Item	Setting	Description
MOVIE CLIP SET		Displays the menu screen for CF memory card related settings such as formatting or deleting all recorded event files.
DELETE ALL	●CANCEL EXECUTE	Selecting EXECUTE and pressing the SELECT dial deletes all event files on the CF memory card. Protected event files are not deleted.
FORMAT	●CANCEL EXECUTE	Selecting EXECUTE and pressing the SELECT dial starts formatting the card.
PAGE BACK		Pressing the SELECT dial returns to the NETWORK PACK CONFIG menu screen.
MENU RESET	●CANCEL EXECUTE	Selecting EXECUTE and pressing the SELECT dial returns NETWORK PACK CONFIG menu screen settings to the original factory settings.
PAGE BACK		Pressing the SELECT dial returns to the TOP MENU screen.

Menu screen settings can be made regardless of whether a card is inserted. Settings will be stored in the KA-DV300 memory even when turning the power off.

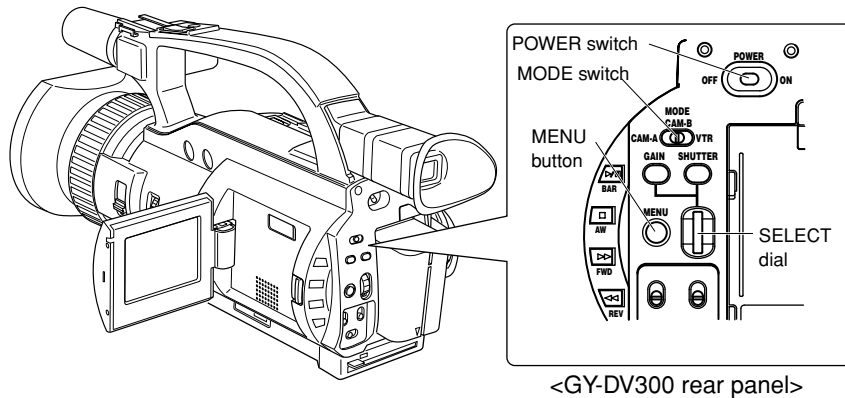

- The NETWORK PACK CONFIG menu screen will not appear during card initialization (flashing display).

■ **Settings are made by viewing the LCD screen or viewfinder screen.**

If **OUTPUT CHAR** of the **DISPLAY [2/2]** menu screen is set to **MIX**, the menu screen also appears on the monitor screen connected to the **VIDEO OUT** or **Y/C** connector.

1. Set the POWER switch to ON.
2. Set the MODE switch.
 - Set to "CAM-A" or "CAM-B" when shooting a video.
 - Set to "VTR" for VTR playback, clip file playback or DV signal recording.
3. Press the MENU button for about 1 seconds. The TOP MENU screen appears.
4. Turn the SELECT dial, move the cursor (▶) to NETWORK PACK CONFIG and press the SELECT dial.
 - The NETWORK PACK CONFIG menu screen appears.
5. Select the item to set.

Turn the SELECT dial, move the cursor to the desired item to set and press the SELECT dial.

 - The selected menu screen appears.
 - When selecting MPEG REC or MENU RESET, the setting area flashes and the setting can be changed. Set the item according to step 7.
 - When selecting NETWORK SET, the network related setting screen appears. (page 10)
6. Select an item within the menu screen.

Turn the SELECT dial, move the cursor (▶) to the desired item to set and press the SELECT dial.

 - The setting area flashes and the setting can be changed.
7. Change the setting.

Turn the SELECT dial to change the setting and press the SELECT dial.

 - Flashing of the setting area stops and the new setting is confirmed.

■ **When changing multiple settings, repeat steps 6 and 7 above.**

8. Return to the TOP MENU screen.

Turn the SELECT dial, move the cursor (▶) to PAGE BACK and press the SELECT dial.
9. When quitting menu screen setting and returning to the normal screen, perform one of the following operations.
 - Press the MENU button.
 - Move the cursor (▶) to EXIT in the TOP MENU screen and press the SELECT dial.

TOP MENU screen

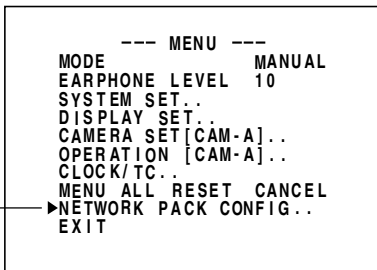

Cursor

NETWORK PACK CONFIG menu screen

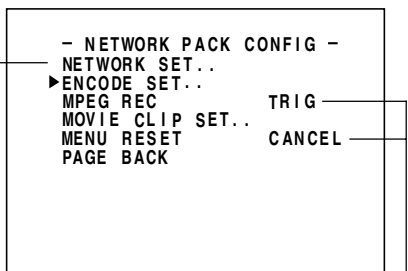

NETWORK SET menu screen (page 10)

Setting

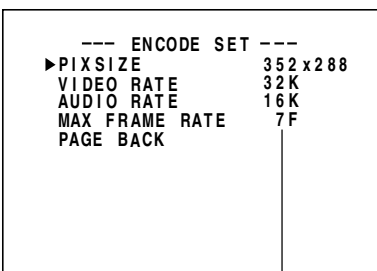

Setting

Menu screen Returning the NETWORK PACK CONFIG menu screen to factory settings

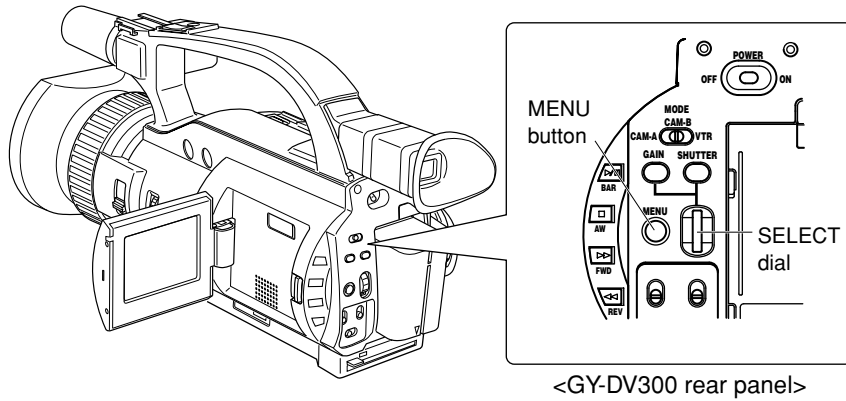

NETWORK PACK CONFIG
menu screen

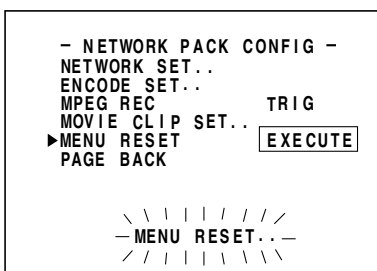

- 1.** Press the MENU button to display the TOP MENU screen.
- 2.** Turn the SELECT dial to select NETWORK PACK CONFIG and press the SELECT dial.
 - The NETWORK PACK CONFIG menu screen appears.
- 3.** Turn the SELECT dial to set MENU RESET to "EXECUTE" and press the SELECT dial.
 - When resetting the menu, "MENU RESET.." will appear at the bottom of the screen for about 5 seconds.
 - The NETWORK PACK CONFIG menu screen settings will return to the factory settings.

Network settings

Setting the NETWORK SET menu screen

When using a LAN card, network related settings for KA-DV300 are made using NETWORK SET of the NETWORK PACK CONFIG menu. Settings will be stored in the KA-DV300 memory even when turning the power off.

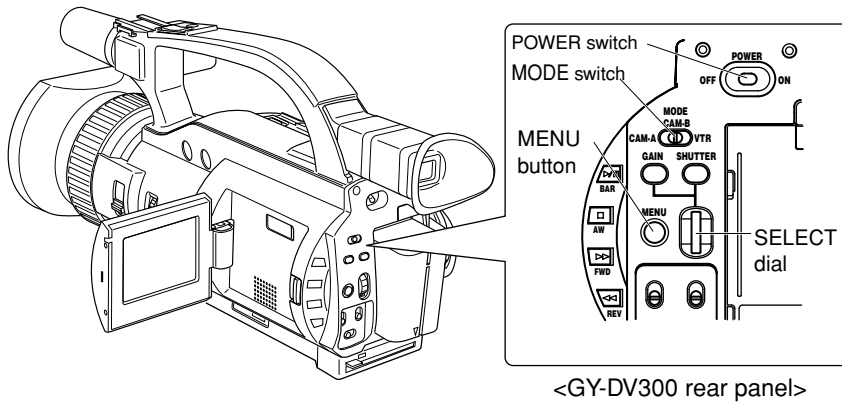

TOP MENU screen

```

--- MENU ---
MODE          MANUAL
EARPHONE LEVEL 10
SYSTEM SET..
DISPLAY SET..
CAMERA SET [CAM-A]..
OPERATION [CAM-A]..
CLOCK/TC..
MENU ALL RESET CANCEL
▶NETWORK PACK CONFIG..
EXIT
    
```

NETWORK PACK CONFIG menu screen

```

- NETWORK PACK CONFIG -
▶NETWORK SET..
ENCODE SET..
MPEG REC          TRIG
MOVIE CLIP SET..
MENU RESET       CANCEL
PAGE BACK
    
```

NETWORK SET [1/2] menu screen

```

--- NETWORK SET [1/2] ---
▶HOST NAME..
DHCP          OFF
IP ADDRESS..
NETMASK..
GATEWAY..
NEXT PAGE
PAGE BACK
    
```

NETWORK SET [2/2] menu screen

```

--- NETWORK SET [2/2] ---
▶RTP..
RTSP..
HTTP..
WLAN AD HOC MODE    OFF
WLAN ESS-ID..
WLAN CH            2CH
USER NAME..
PASS WORD..
PAGE BACK
    
```

■ **Settings are made by viewing the LCD screen or viewfinder screen.**

If OUTPUT CHAR of the DISPLAY [2/2] menu screen is set to MIX, the menu screen also appears on the monitor screen connected to the VIDEO OUT or Y/C connector.

Display the NETWORK SET menu screen

1. Turn on the GY-DV300 power.
2. Press the MENU button to display the TOP MENU screen.
3. Turn the SELECT dial, move the cursor (▶) to NETWORK PACK CONFIG and press the SELECT dial.
 - The NETWORK PACK CONFIG menu screen appears.
4. Turn the SELECT dial, move the cursor (▶) to NETWORK SET and press the SELECT dial.
 - The NETWORK SET [1/2] menu screen will appear.
 - The NETWORK SET menu screen is structured by 2 pages.

■ **Select NEXT PAGE and press the SELECT dial to display the NETWORK SET [2/2] menu screen.**

Select PAGE BACK in the NETWORK SET [2/2] menu screen and press the SELECT dial to return to the NETWORK SET [1/2] menu screen.

5. Set DHCP to ON or OFF in the NETWORK SET [1/2] menu screen.
 - Items other than DHCP are set in the individual setting screen. (☞ page 12)
6. To return to the normal screen after completing setting, perform one of the following operations.
 - Press the MENU button
 - Select PAGE BACK to return to the TOP MENU screen. Select EXIT in the TOP MENU screen and press the SELECT dial.

Network settings

NETWORK SET menu screen items

[1/2] screen ● indicates default factory setting.

Item	Setting	Description
HOST NAME		Displays the host name input setting screen. (Max. 64 alphanumerical characters) [Factory setting: none]
DHCP	●OFF ON	Select whether DHCP server is used. OFF: Use this setting when using LAN connection rather than DHCP. When this setting is used, IP ADDRESS and NETMAST, GATEWAY must also be set. ON: Use this setting when using DHCP connection. When using this setting, IP ADDRESS and NETMASK, GATEWAY are automatically set.
IP ADDRESS		Displays the IP address setting screen. (Max. 12 numerical characters) When using LAN connection with DHCP set to OFF, this setting is required. Set a unique IP address. IP ADDRESS setting is not available when DHCP is set to ON. [Factory setting] 192.168.100.101]
NETMASK		Displays the subnet mask input screen. (Max. 12 numerical characters) This setting is required when using LAN connection with DHCP set to OFF. NETMASK setting is not available if DHCP is set to ON. [Factory setting: 255.255.255.000]
GATE WAY		Displays the gateway address input screen. (Max. 12 numerical characters) GATEWAY setting is not available when DHCP is set to ON. [Factory setting: 192.168.100.254]
NEXT PAGE		Pressing the SELECT dial displays the NETWORK SET [2/2] menu screen.
PAGE BACK		Pressing the SELECT dial returns to the NETWORK PACK CONFIG menu screen.

[2/2] screen

Item	Setting	Description
RTP		Displays the RTP port input setting screen. (Max. 5 numerical characters) Changing ports require special knowledge. Always consult the administrator of the connecting network when making changes. [Factory setting: 5004]
RTSP		Displays the RTSP port input setting screen. (Max. 4 numerical characters) Changing ports require special knowledge. Always consult the administrator of the connecting network when making changes. [Factory setting: 8554]
HTTP		Displays the HTTP port input setting screen. (Max. 4 numerical characters) Changing ports require special knowledge. Always consult the administrator of the connecting network when making changes. [Factory setting: 0080]
WLAN AD HOC MODE	●OFF ON	Wireless LAN setting OFF: Use this setting when performing communication via access point. ON: Use this setting when performing communication in AD HOC mode with a PC connected with a wireless LAN card. (☞ page 14)
WLAN ESS-ID		Displays the wireless LAN ESS-ID input setting screen (Max. 32 alphanumerical characters)
WLAN CH	1CH ●2CH : 14CH	Wireless LAN channel setting
USER NAME		Displays the user name input setting screen. (Max. 8 alphanumerical characters) Used when controlling GY-DV300 via LAN card. (☞ page 29) [Factory setting: jvc]
PASS WORD		Displays the password input setting screen. (Max. 8 alphanumerical characters) Used when controlling GY-DV300 via LAN card. (☞ page 29) [Factory setting: ka-dv300] (Password is hidden) Caution • Keep a memo of the password since it is only displayed during the actual setting. The password will be hidden using asterisks (*) when accessing the password menu screen again. • When performing MENU RESET, KA-DV300 will return to its factory settings. (☞ page 9)
PAGE BACK		Pressing the SELECT dial returns to the NETWORK SET [1/2] menu screen.

Network related settings are made in the individual input setting screens.

Here, USER NAME is set as an example. Other settings are also made in the same manner.

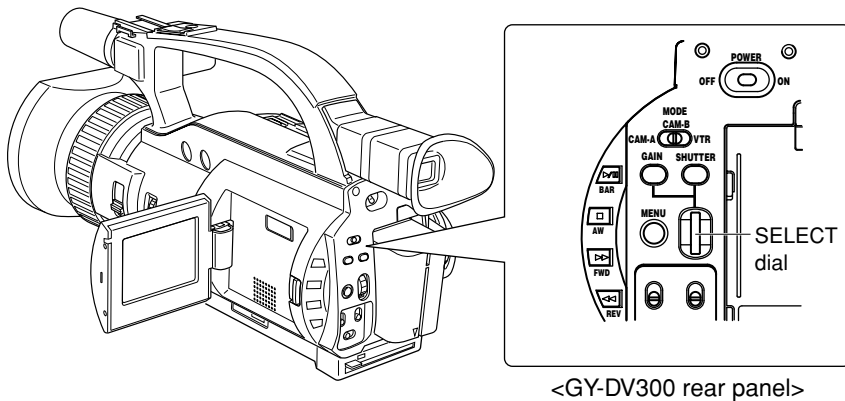

USER NAME input setting screen

Currently inputted number of characters/
max.number of characters

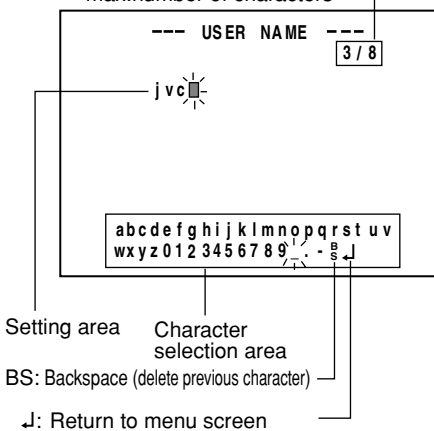

Example: Changing USER NAME from jvc to jvc-1234

■ Select USER NAME in the NETWORK SET [2/2] menu screen and press the SELECT dial.

- The USER NAME input setting screen appears.

1. Characters are selected from the character selection area on the bottom of the screen.

Turn the SELECT dial to flash “_” in the character selection area and press the SELECT dial.

- The setting changes to “jvc_” and the following digit of the setting area flashes.

2. Turn the SELECT dial to select “1” in the character selection area and press the SELECT dial.

- The setting changes to “jvc_1” and the following digit of the setting area flashes.

3. Repeat the above step to set “jvc_1234” in the setting area.

■ To delete or edit set characters, select “BS” within the character selection area and press the SELECT dial.

The previous character will be deleted. The character on the left will be deleted each time this operation is repeated.

■ The currently inputted number of characters and the maximum number of characters are displayed on the upper right of the screen.

4. When completed, select “↓” within the character selection area and press the SELECT dial.

- NETWORK SET [2/2] menu screen returns in the LCD or viewfinder.

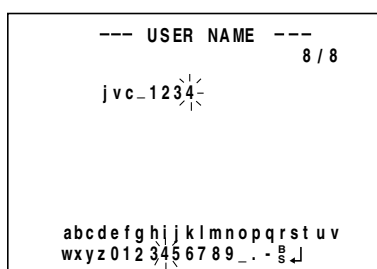
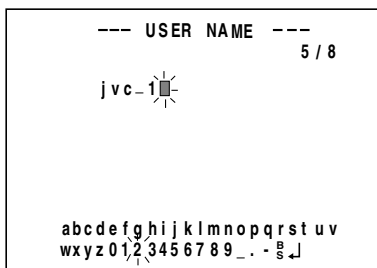
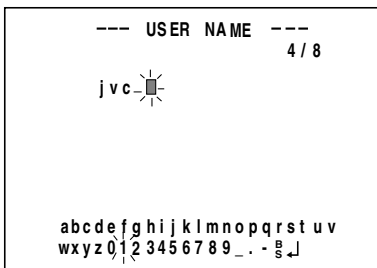

Example of IP address and subnet mask settings when using LAN is shown below.

- Operation is only guaranteed for Windows 2000.
- Internet Explorer 5.0 or later
- Windows Media Player 7.01 or later

1. For 1:1 communication between PC and GY-DV300/KA-DV300

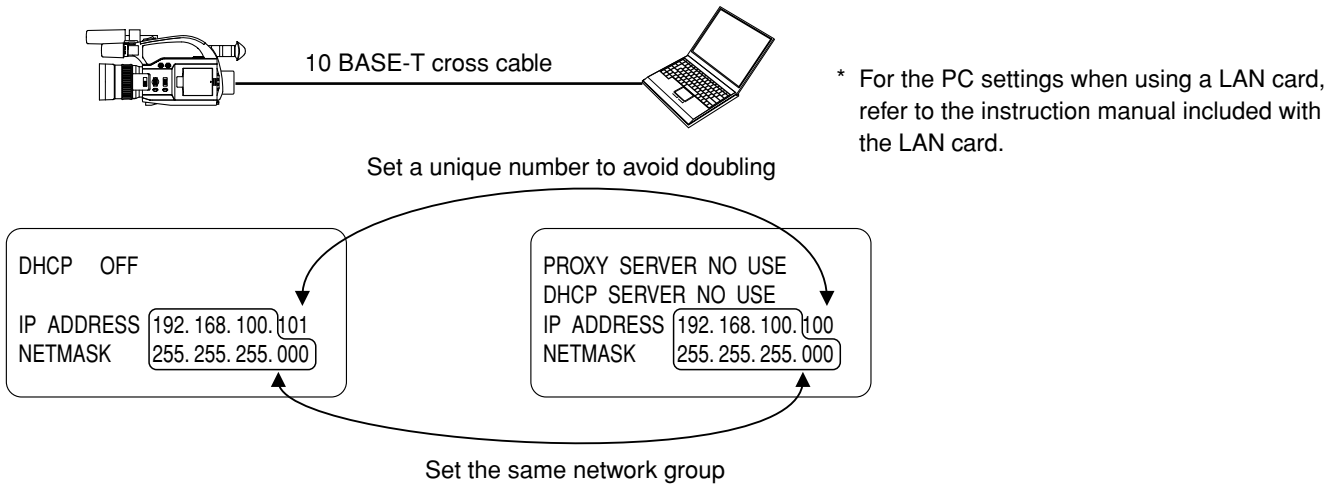

2. For communication between PC and multiple GY-DV300/KA-DV300

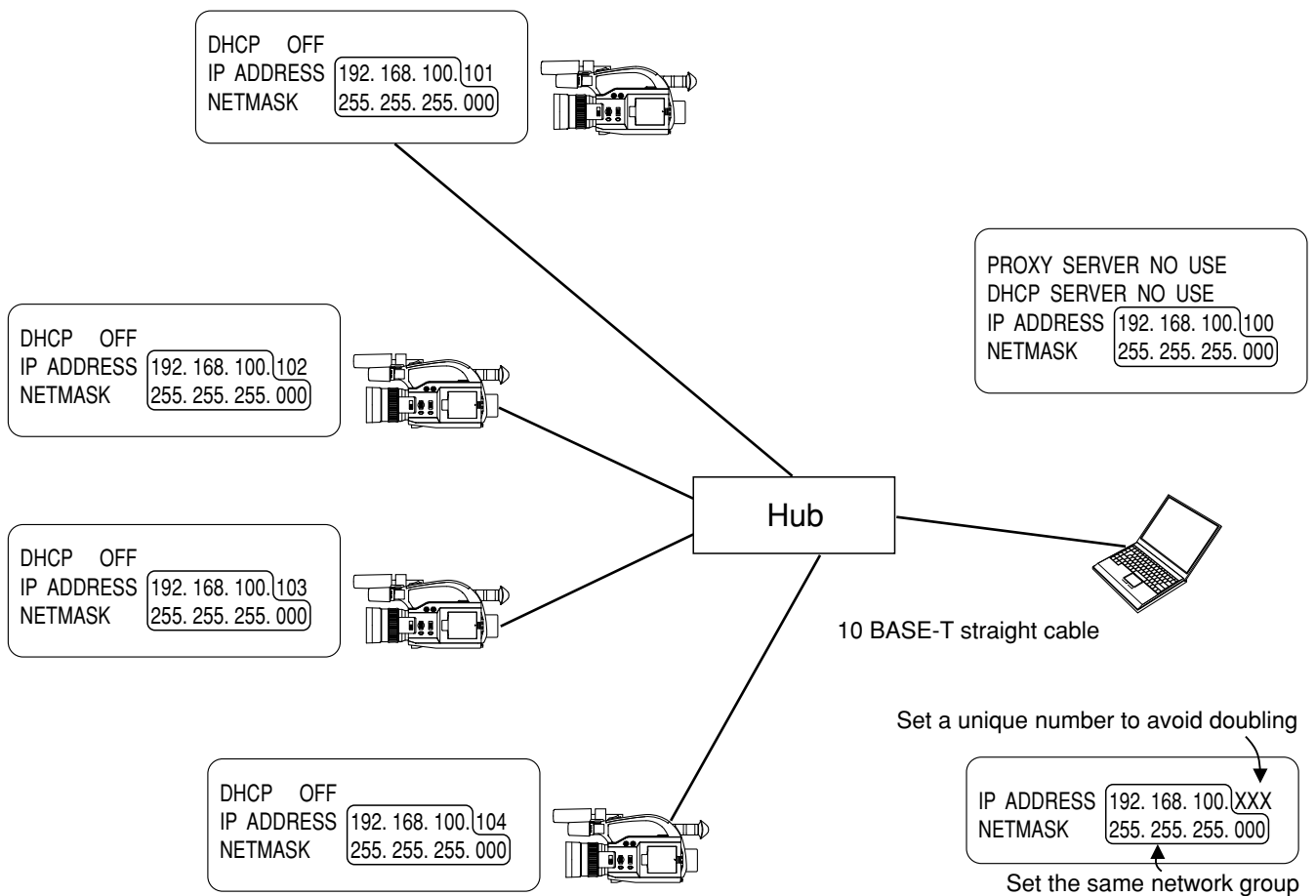

Example of network settings when using wireless LAN is shown below.

- Operation is only guaranteed for Windows 2000.
- Internet Explorer 5.0 or later
- Windows Media Player 7.01 or later

1. For communication with PC without returning access point (Ad hoc mode)



* Do not perform encryption of the wireless LAN.

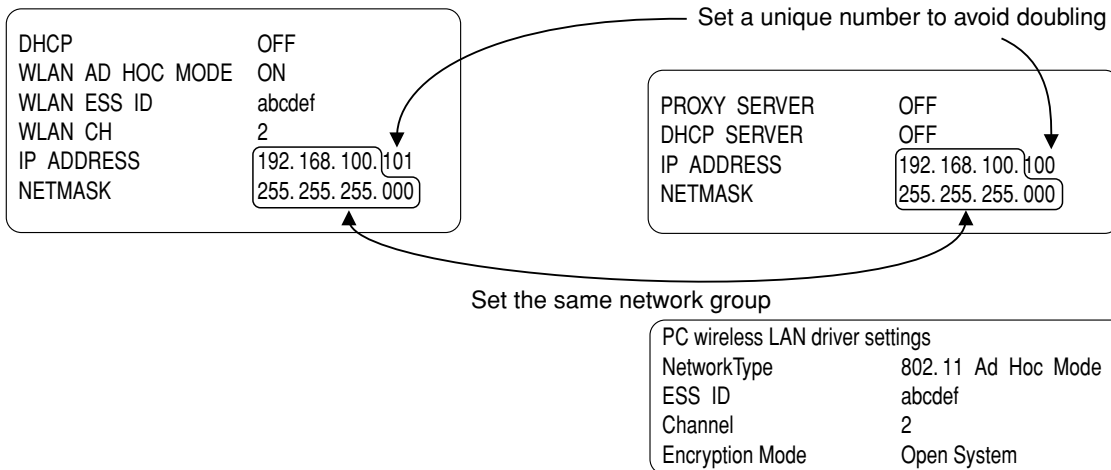

* For the PC settings when using a LAN card, refer to the instruction manual included with the LAN card.

Cautionary items concerning Wireless LAN (WLAN)

- For the WLAN ESS ID, input the values of ESSID set in:
Ad hoc mode: PC of other party
Infrastructure: Access point
- When setting WLAN AD HOC MODE, the network mode setting of the wireless LAN card on the PC side must be set to 802.11 Adhoc.
- WLAN CH is the wireless frequency band used for communication. If there is an access point, adapter, etc., using the same band in the proximity, there may be a hindrance in the communication and may reduce throughput or the quality of communication. When setting, check the settings of surrounding access points, etc., to avoid doubling.

Frequency bands (ISM bands) and channels (IEEE803.11b standard)

- N. America : FCC / 2.412~2.462GHz (11 channels)
- Europe : CE ETSI / 2.412~2.472GHz (13 channels)
- Japan : 2.412~2.4835GHz (14 channels)
- France : 2.457~2.472GHz (4 channels)
- Spain : 2.457~2.462GHz (2 channels)

14 channels of the 2.4GHz band used by the wireless LAN. Since adjacent channels causes signal interference, channels are normally spaced 5 channels apart.

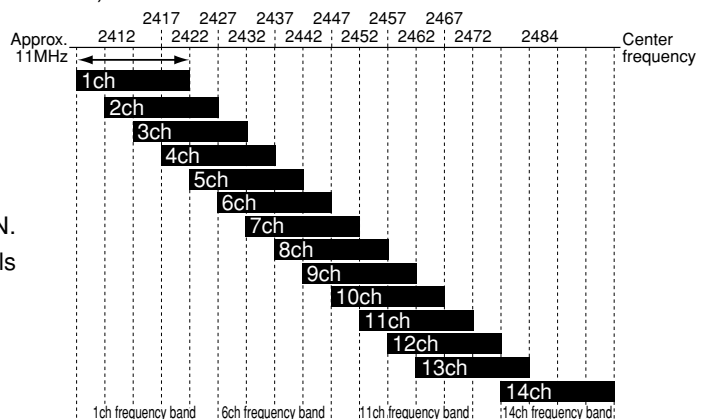

2. For communication with PC via access point (Infrastructure mode)

DHCP	OFF
WLAN AD HOC MODE	OFF
WLAN ESS ID	abcdef
WLAN CH	2
IP ADDRESS	192.168.100.102
NETMASK	255.255.255.000

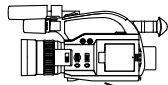

DHCP	OFF
WLAN AD HOC MODE	OFF
WLAN ESS ID	abcdef
WLAN CH	2
IP ADDRESS	192.168.100.101
NETMASK	255.255.255.000

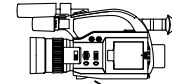

* Do not perform encryption of the wireless LAN.

STATION
ESS ID abcdef
Channel 2
Encryption Mode Open System

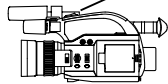

PROXY SERVER	NO USE
DHCP SERVER	NO USE
IP ADDRESS	192.168.100.100
NETMASK	255.255.255.000

DHCP	OFF
WLAN AD HOC MODE	OFF
WLAN ESS ID	abcdef
WLAN CH	2
IP ADDRESS	192.168.100.103
NETMASK	255.255.255.000

PC wireless LAN driver settings	
NetworkType	Infrastructure
ESS ID	abcdef
Channel	2
Encryption Mode	Open System

* For the PC settings when using a LAN card, refer to the instruction manual included with the LAN card.

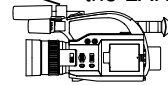

Network Type (Ad Hoc/Infrastructure)
Make sure ESS ID and Channel settings are the same.

Set a unique number to avoid doubling

IP ADDRESS	192.168.100.XXX
NETMASK	255.255.255.000

Set the same network group

DHCP	OFF
WLAN AD HOC MODE	OFF
WLAN ESS ID	abcdef
WLAN CH	2
IP ADDRESS	192.168.100.104
NETMASK	255.255.255.000

Memo

For network settings and LAN card driver settings, refer to the respective instruction manuals.

Recording on a CF memory card

Formatting a CF memory card

When an unformatted CF memory card is inserted and the GY-DV300 power is turned on, "NO CF FORMAT!" appears in the LCD screen/viewfinder screen.

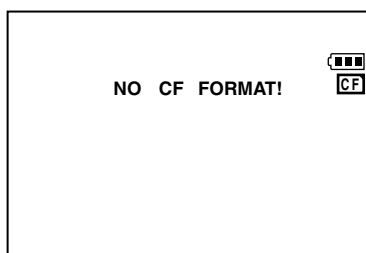
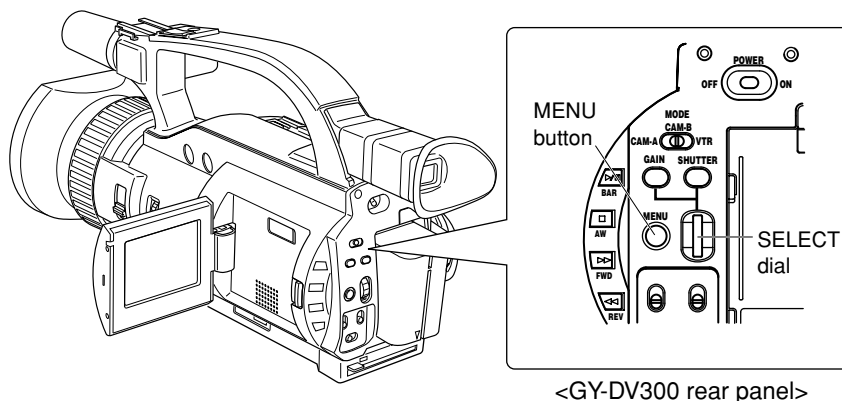

NETWORK PACK CONFIG menu screen

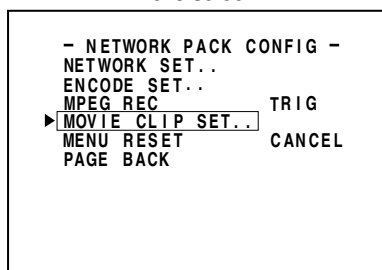

MOVIE CLIP SET menu screen

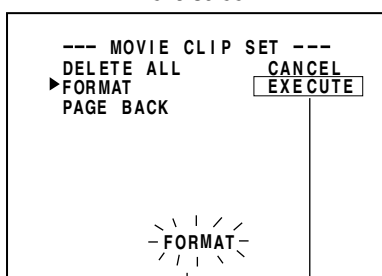

Set to EXECUTE
Flashing display during formatting

1. Press the MENU button to display the TOP MENU screen.
2. Use the SELECT dial to select NETWORK PACK CONFIG menu screen → MOVIE CLIP SET menu screen.
3. Set FORMAT in the MOVIE CLIP SET menu screen to "EXECUTE" and press the SELECT dial.
 - The formatting begins. During formatting, "FORMAT" appears on the screen.
4. When formatting is completed, to the MOVIE CLIP SET menu screen returns. The FORMAT setting will return to CANCEL.
5. To return to the NETWORK PACK CONFIG menu screen, select PAGE BACK and press the SELECT dial.
 - To return to the normal screen, press the MENU button.

CF memory recording time

Estimated recording time of CF memory cards is shown below:

CF memory card size	Video compression rate (when fixed at audio 32k)		
	384kbps	256kbps	128kbps ~ 32kbps
16MByte	3min.	5min.	10min. or more
32MByte	7min.	11min.	20min. or more
64MByte	15min.	22min.	40min. or more
128MByte	30min.	44min.	80min. or more
192MByte	46min.	66min.	120min. or more
256MByte	61min.	88min.	160min. or more

Caution
The recording time may be shorter than the above estimate depending on the movement of the subject.

Recording on a CF memory card

Recording video on a DV cassette tape and CF memory card

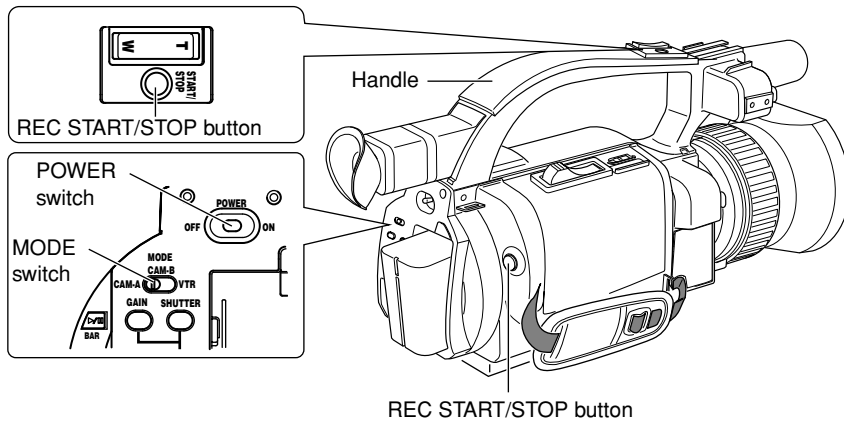

- “NO CF FORMAT!” will appear if the inserted CF memory card is not formatted. Format the card in the MOVIE CLIP SET menu screen. (page 16)

LCD screen



CF : Red display during recording

CF : Initializing

NETWORK PACK CONFIG menu screen

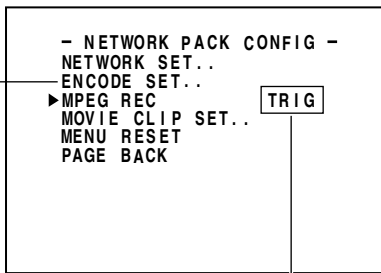

ENCODE SET menu screen

Set to TRIG

LCD screen

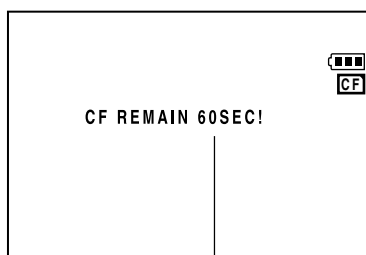

CF memory card remaining warning

1. Insert a CF memory card into the Network Pack.
2. Turn on the GY-DV300 power.
Check to see that the CF display appears on the LCD screen/viewfinder screen. (When the power is turned on, CF display will flash during initialization.)
3. Insert a recordable DV cassette tape.
4. Set the MODE switch to “CAM-A” or “CAM-B”.
5. Set the NETWORK PACK CONFIG menu screen.
 - ① Set MPEG REC to “TRIG”.
 - ② Set the video/audio compression in the ENCODE SET menu screen. (page 6)
 - ③ When completed with settings, press the MENU button to return to the normal screen.
6. Press the REC START/STOP button on GY-DV300 to start recording on the DV cassette tape as well as video/audio streaming data on the CF memory card.
 - During CF memory card recording, CF display will light red.
7. To stop recording, press the REC START/STOP button.
8. To resume recording, press the REC START/STOP button once more.
9. To end recording, press the REC START/STOP button to stop recording and turn off the power.
Lastly, remove the CF memory card.

Memo

- When the DV cassette tape has reached the end during recording, CF memory card recording will also stop.
- Every time recording is performed, the recorded event is stored in the clip list of the CF memory card.
Stored contents of clip list: Clip number and date/time when recording was started. All events can be played back on the MOVIE CLIP screen. (page 21)
- The CF memory card remaining warning is displayed on the LCD screen/viewfinder screen. (page 38)

Recording on a CF memory card Recording video on a CF memory card only

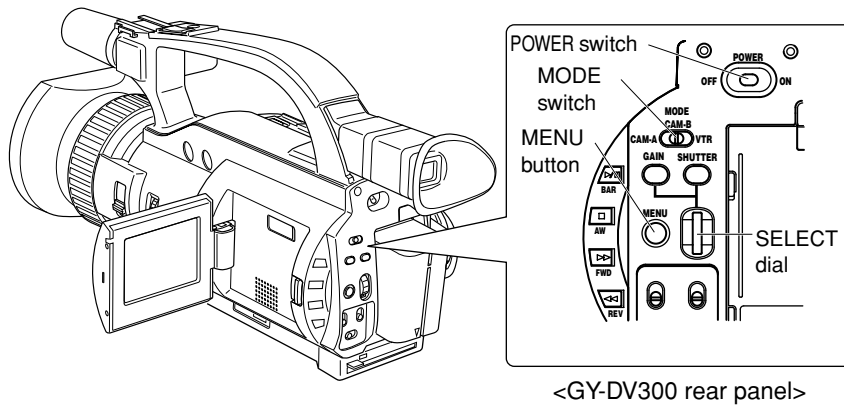

<GY-DV300 rear panel>

- “NO CF FORMAT!” will appear if the inserted CF memory card is not formatted. Format the card in the MOVIE CLIP SET menu screen. (☞ page 16)

1. Insert a CF memory card into the Network Pack.
2. Turn on the GY-DV300 power.
Check to see that the **CF** display appears on the LCD screen/viewfinder screen. (When the power is turned on, display will flash during initialization.)
3. Set the MODE switch to “CAM-A” or “CAM-B”.
4. Set the NETWORK PACK CONFIG menu screen.
 - ① Set MPEG REC to “SPLIT”.
 - ② Set the video/audio compression in the ENCODE SET menu screen. (☞ page 6)
 - ③ When completed with settings, press the MENU button to return to the normal screen.
5. Press the SELECT dial on GY-DV300 to start recording streaming data on the CF memory card.
 - During recording, **CF** display will light red.
6. To stop recording, press the SELECT dial.
7. To resume recording, press the SELECT dial once more.
8. To end recording, press the SELECT dial to stop recording and turn off the power. Lastly, remove the CF memory card.

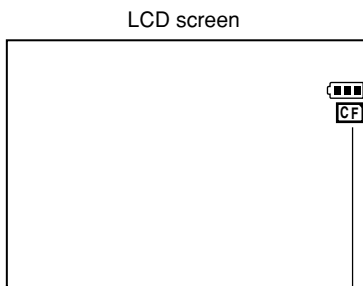

CF : Red display during recording

: Initializing

NETWORK PACK CONFIG menu screen

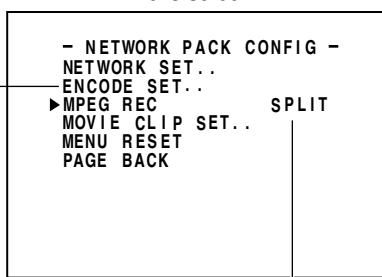

ENCODE SET menu screen

Set to SPLIT

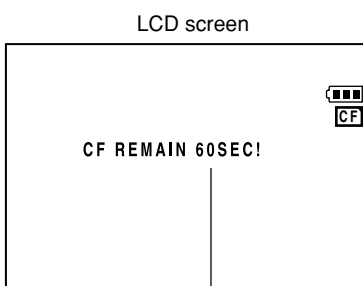

CF memory card remaining warning

Memo

- Every time recording is performed, the recorded event is stored in the clip list of the CF memory card.
Stored contents of clip list: Clip number and date/time when recording was started. All events can be played back on the MOVIE CLIP screen. (☞ page 21)
- The CF memory card remaining warning is displayed on the LCD screen/viewfinder screen. (☞ page 38)
- Recording will not be made on the DV cassette tape even if a tape is inserted.
- When using the SELECT dial for GAIN or SHUTTER operation, no operation on the SELECT dial will be accepted for about 3 seconds after the operation is completed.

Recording on a CF memory card Recording playback signals of a DV cassette tape on a CF memory card

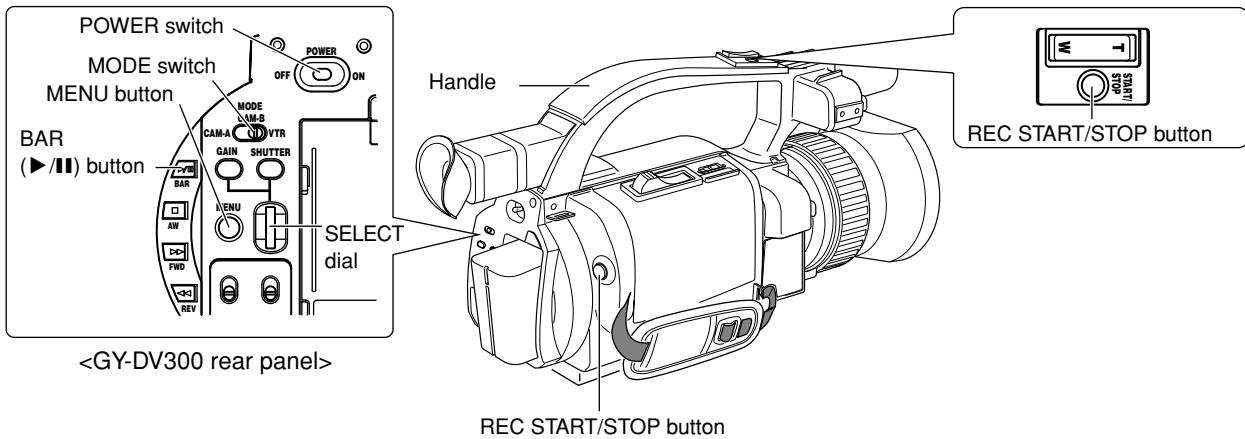

- “NO CF FORMAT!” will appear if the inserted CF memory card is not formatted. Format the card in the MOVIE CLIP SET menu screen. (☞ page 16)

1. Insert a CF memory card into the Network Pack.
2. Turn on the GY-DV300 power.
Check to see that the **CF** display appears on the LCD screen/viewfinder screen. (When the power is turned on, display will flash during initialization.)
3. Insert the recorded DV cassette tape.
4. Set the MODE switch to “VTR”.
5. Set the NETWORK PACK CONFIG menu screen.
 - ① Set MPEG REC.
When recording using the REC START/STOP button of GY-DV300, set to “TRIG”.
When recording using the SELECT dial, set to “SPLIT”.
 - ② Set the video/audio compression in the ENCODE SET menu screen. (☞ page 6)
 - ③ When completed with settings, press the MENU button to return to the normal screen.
6. Press the BAR (▶/||) button of GY-DV300 to start DV cassette tape playback.
7. Press the REC START/STOP button or SELECT dial at the scene to start recording on the CF memory card. (The recording method of using REC START/STOP button or SELECT dial is set in MPEG REC.)
 - During recording, the **CF** display appears in red.
8. To stop recording, press the REC START/STOP button or SELECT dial.
9. To resume recording, press the REC START/STOP button or SELECT dial once more.
10. To end recording, press the REC START/STOP button or SELECT dial to stop recording and turn off the power. Lastly, remove the CF memory card.

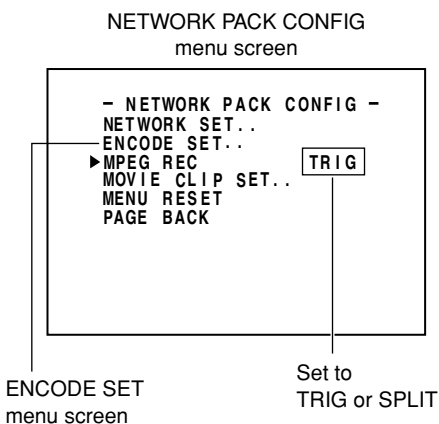
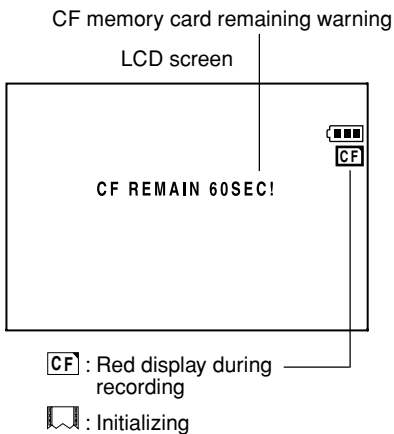

Memo

- Every time recording is performed, the recorded event is stored in the clip list of the CF memory card.
Stored contents of clip list: Clip number and date/time when recording was started. All events can be played back on the MOVIE CLIP screen. (☞ page 21)
- The CF memory card remaining time is displayed on the LCD screen/viewfinder screen.

Recording on a CF memory card Deleting all clips on a CF memory card

MOVIE CLIP of the NETWORK PACK CONFIG menu screen is used to delete all clips on a CF memory card.

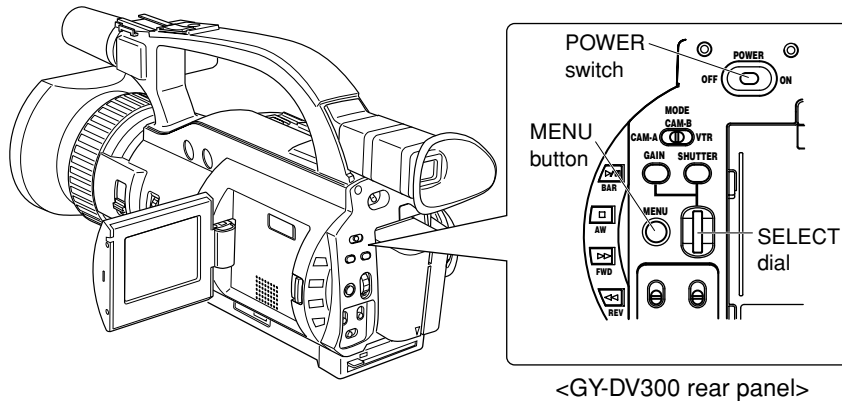

NETWORK PACK CONFIG menu screen

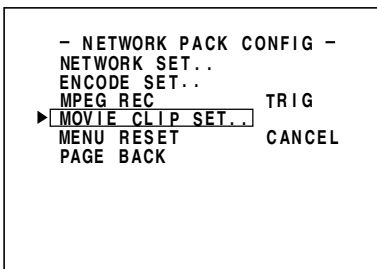

MOVIE CLIP SET menu screen

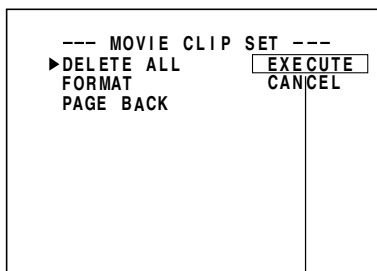

Set to EXECUTE

Deleting

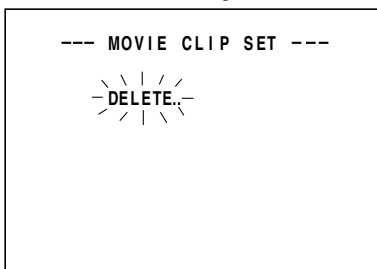

MOVIE CLIP SET menu screen

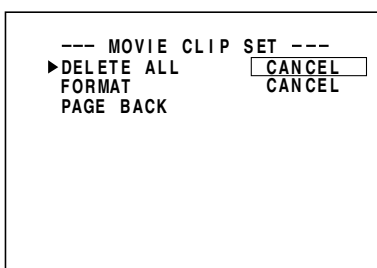

- 1.** Insert an already recorded CF memory card.
- 2.** Turn on the GY-DV300 power.
Check to see that the **CF** display appears on the LCD screen/viewfinder screen.
- 3.** Press the MENU button to display the TOP MENU screen.
- 4.** Use the SELECT dial to select NETWORK PACK CONFIG menu screen → MOVIE CLIP SET menu screen.
- 5.** Set DELETE ALL in the MOVIE CLIP SET menu screen to “EXECUTE” and press the SELECT dial.
 - Deletion is executed and “DELETE..” appears flashing on the screen.
- 6.** When deletion is completed, to the MOVIE CLIP SET menu screen returns. DELETE ALL setting will return to “CANCEL”.
- 7.**
 - To return to the NETWORK CONFIG menu screen, select PAGE BACK and press the SELECT dial.
 - To return to the normal screen, press the MENU button.

Memo

- Protected clips are not deleted.

MOVIE CLIP

Playing back video/audio recorded on a CF memory card

Every time recording is performed, the recorded event is stored in the clip list of the CF memory card. The clip list is stored with the recorded event number (clip number) and the date/time when the recording was started. All events (clip numbers) can be played back on the MOVIE CLIP screen.

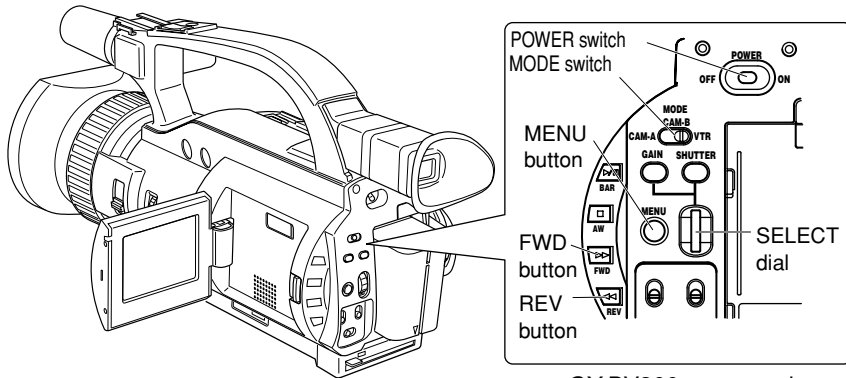

<GY-DV300 rear panel>

- MOVIE CLIP will not appear during card initialization (flashing display).

TOP MENU screen

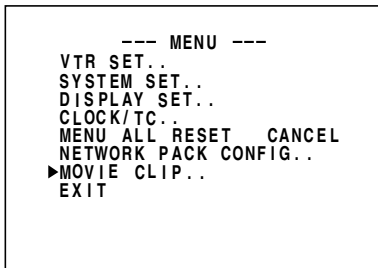

1. Insert an already recorded CF memory card.
2. Turn on the GY-DV300 power. Check to see that the **CF** display appears on the LCD screen/viewfinder screen. (When the power is turned on, display will flash during initialization.)
3. Set the MODE switch to "VTR".
4. Make sure GY-DV300 is not in operation.
5. Display the MOVIE CLIP screen.
 - ① Press the MENU button to display the TOP MENU screen.
 - ② Turn the SELECT dial, move the cursor (▶) to MOVIE CLIP and press the SELECT dial.

- The movie clip list of the latest clip page recorded on the CF memory card and the still image (starting point) of the latest clip number appear by overlapping.

MOVIE CLIP screen

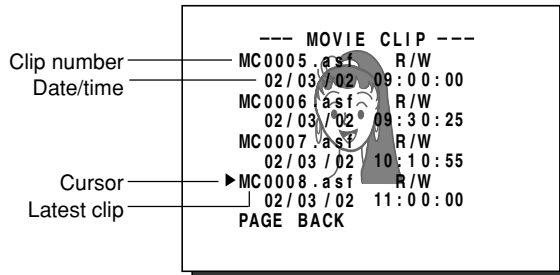

The clip page in the MOVIE CLIP screen displays 4 lists per page.

Memo

When a MOVIE CLIP menu item is selected and the SELECT dial is pressed with no clips recorded on the CF memory card, "NO CLIP!" will flash for about 3 seconds.

If there is no CF memory card inserted, "NO CF CARD!" will flash for about 3 seconds.

6. Select the clip to play back.
 - ① Turn the SELECT dial and move the cursor (▶) to the clip to play back.
 - Turning the SELECT dial up scrolls to the page with smaller (older) clip numbers.
 - Turning the SELECT dial down scrolls to the page with larger (newer) clip numbers.
 - Press the [FWD] button to scroll to the next page. Press the [REV] button to scroll to the previous page.
 - Press and hold the [FWD] button for about 2 seconds to scroll to the page with the newest clip.
 - Press and hold the [REV] button for about 2 seconds to scroll to the page with the oldest clip.
 - ② Press the SELECT dial. CLIP FUNCTION screen of the selected clip appears.
 - Still image (starting point) of the selected clip appears.

CLIP FUNCTION screen

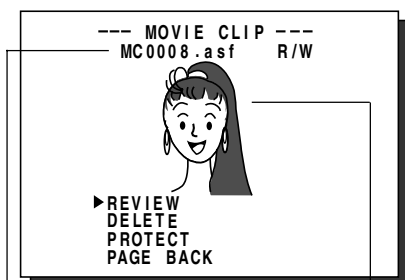

Selected clip number Still image (starting point) of the selected clip

Note

ASF files recorded using another device may not play back properly on this unit.

→ OVER

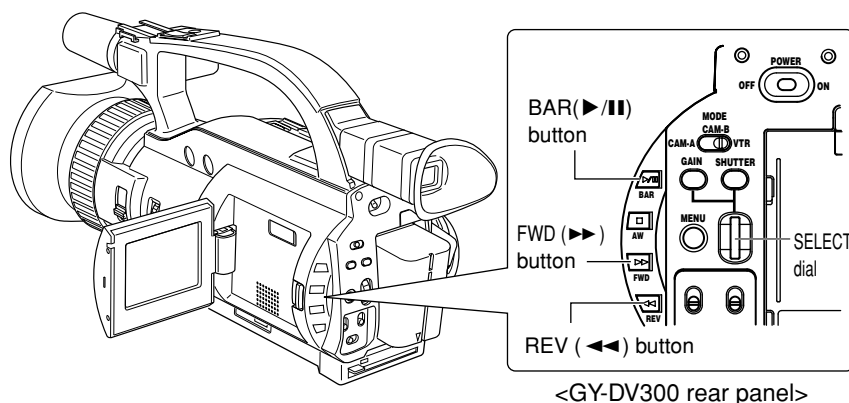

<GY-DV300 rear panel>

CLIP FUNCTION screen

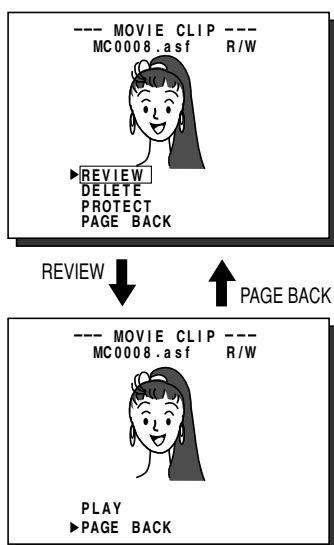

7. Play back the clip.
Turn the SELECT dial, move the cursor to REVIEW and press the SELECT dial.
 - The movie clip is played back after the still image is displayed for about 1 second. The value of the recorded pixel size (352 X 288 or 176 X 144) appears during displaying the still image. The value of the recorded max. bit rate appears during playback.
8. To pause playback, press the BAR (▶/||) button.
9. To resume playback, press the BAR (▶/||) button once more.
10. The following operations are performed when the playback of the selected clip ends.
 - When there are no following clips, the unit pauses at the beginning of the current clip.
 - When there are following clips, the unit displays the still image of the next clip for about 1 second, then starts playback.
When all remaining clips are played back, the unit pauses at the beginning of the played back clip.

■ Selecting PAGE BACK during playback or pausing and press the SELECT dial will return to the MOVIE CLIP screen.

To move to another clip during playback

- Playback will remain on the current clip even when the FWD (▶▶) button is pressed if the latest clip is being played back.
 - Pressing the REV (◀◀) button during playback of the oldest clip will start playback at the starting point of the that clip.
- To move to the next clip during middle of playback or pausing, press the FWD (▶▶) button of GY-DV300.
 - The playback of the current clip stops and the unit pauses at the starting point of the next clip.
Pressing the FWD (▶▶) button again pauses at the starting point of the following the next clip.
 - To move to the previous clip during middle of playback or pausing, press the REV (◀◀) button of GY-DV300.
 - The playback of the current clip stops and the unit pauses at the starting point of the previous clip.
Pressing the REV (◀◀) button again pauses at the starting point of the clip before the previous clip.
 - To move to the latest clip during middle of playback or pausing, press the FWD (▶▶) button of GY-DV300 for more than 2 seconds.
 - The unit pauses at the starting point of the latest clip.
To start playback, press the BAR (▶/||) button.
 - To move to the oldest clip during middle of playback or pausing, press the REV (◀◀) button of GY-DV300 for more than 2 seconds.
 - The unit pauses at the starting point of the oldest clip.
To start playback, press the BAR (▶/||) button.

MOVIE CLIP

Protecting a clip file on a CF memory card

Clips recorded on a CF memory card can be protected using the MOVIE CLIP screen.

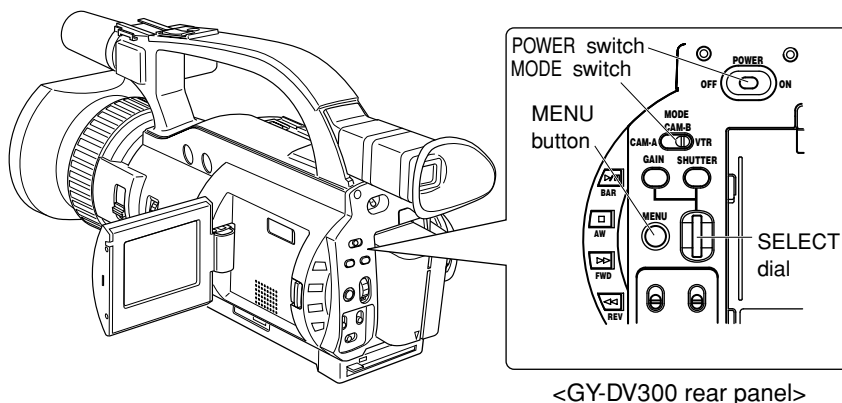

- When executing FORMAT in the MOVIE CLIP SET menu screen, protected clips will also be deleted.
- Protected clips will not be deleted even when executing DELETE ALL in the MOVIE CLIP SET menu screen.

1. Insert an already recorded CF memory card.
2. Turn on the GY-DV300 power.
Check to see that the **CF** display appears on the LCD screen/viewfinder screen. (When the power is turned on, display will flash during initialization.)
3. Set the MODE switch to "VTR".
4. Make sure GY-DV300 is not in operation.
5. Display the MOVIE CLIP screen.
 - ① Press the MENU button to display the TOP MENU screen.
 - ② Turn the SELECT dial, move the cursor (▶) to MOVIE CLIP and press the SELECT dial.
 - The latest page of the MOVIE CLIP screen appears.
R/W display appears on the right of the clip number.
6. Select the clip to protect.
Turn the SELECT dial, move the cursor (▶) to the clip to protect and press the SELECT dial.
 - The CLIP FUNCTION screen of the selected clip appears.
7. Turn the SELECT dial, move the cursor to PROTECT in the CLIP FUNCTION screen and press the SELECT dial.

TOP MENU screen

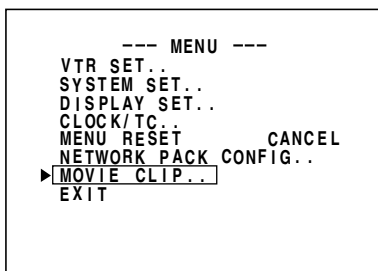

MOVIE CLIP screen

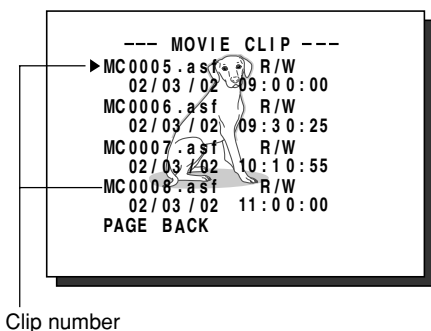

CLIP FUNCTION screen

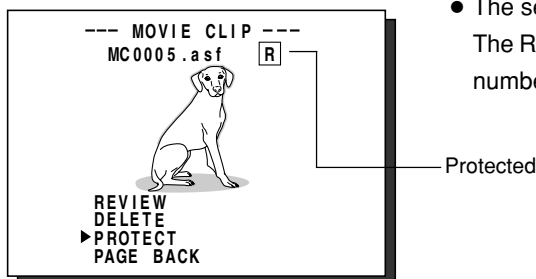

CLIP FUNCTION screen

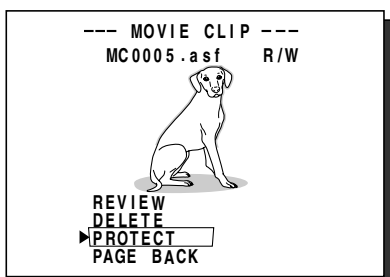

8. To return to the MOVIE CLIP screen after completing setting, select PAGE BACK and press the SELECT dial.

■ To cancel the protection, select PROTECT in the CLIP FUNCTION screen and press the SELECT dial.

- The R display will change to an R/W display and the protection on the clip will be canceled.

Clips recorded on a CF memory card can be deleted using the MOVIE CLIP screen.

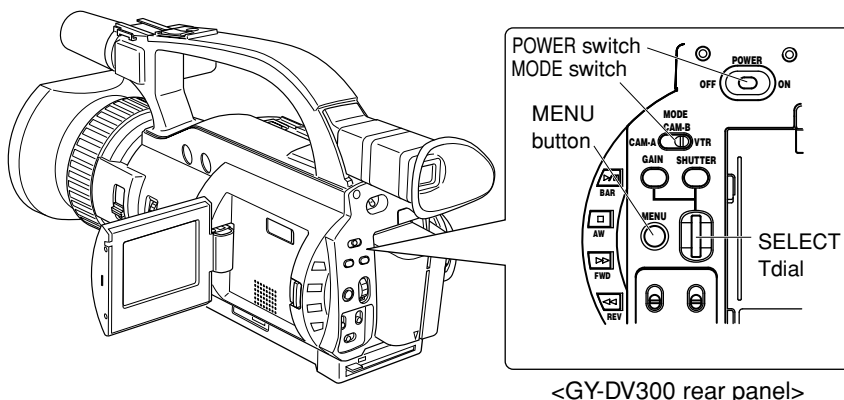

TOP MENU screen

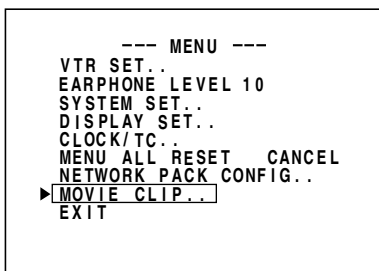

MOVIE CLIP screen

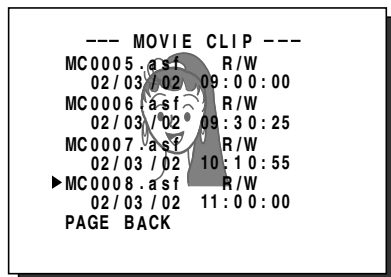

CLIP FUNCTION screen

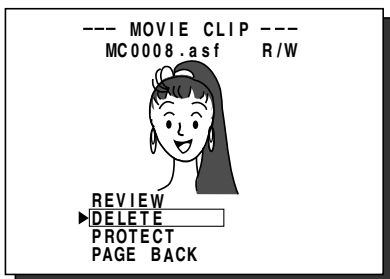

Confirmation screen

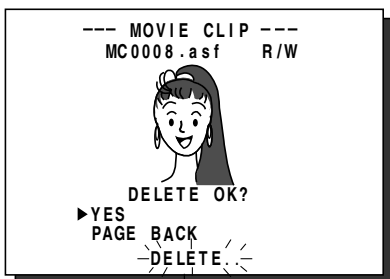

Deleting Flashing display

1. Insert an already recorded CF memory card.
2. Turn on the GY-DV300 power.
Check to see that the **CF** display appears on the LCD screen/viewfinder screen.
(When the power is turned on, display will flash during initialization.)
3. Set the MODE switch to "VTR".
4. Make sure GY-DV300 is not in operation.
5. Display the MOVIE CLIP screen.
 - ① Press the MENU button to display the TOP MENU screen.
 - ② Turn the SELECT dial, move the cursor (▶) to MOVIE CLIP and press the SELECT dial.
 - The latest page of the MOVIE CLIP screen appears.
6. Select the clip to delete.
Turn the SELECT dial, move the cursor (▶) to the clip to delete and press the SELECT dial.
 - The CLIP FUNCTION screen of the selected clip appears.
7. Turn the SELECT dial, move the cursor to DELETE in the CLIP FUNCTION screen and press the SELECT dial.
 - A "DELETE OK?" confirmation message appears. (Confirmation screen)
8. To delete, select YES using the SELECT dial and press the SELECT dial.
 - "DELETE ." flashes on the screen for about 5 seconds and then the MOVIE CLIP screen returns. The clip is deleted from the MOVIE CLIP screen.
 - To cancel the deletion, select PAGE BACK and press the SELECT dial.

Memo

- Protected clips cannot be deleted even when selecting DELETE.
In this case, "PROTECT!" will flash for about 2 seconds and then CLIP FUNCTION screen returns.
- After deleting a clip and there are no remaining clips left on the CF memory card, "NO CLIP!" flashes on the screen for about 3 seconds and then the TOP MENU screen returns.
- To delete all clips, use the MOVIE CLIP SET in the NETWORK PACK CONFIG menu screen. (page 20)

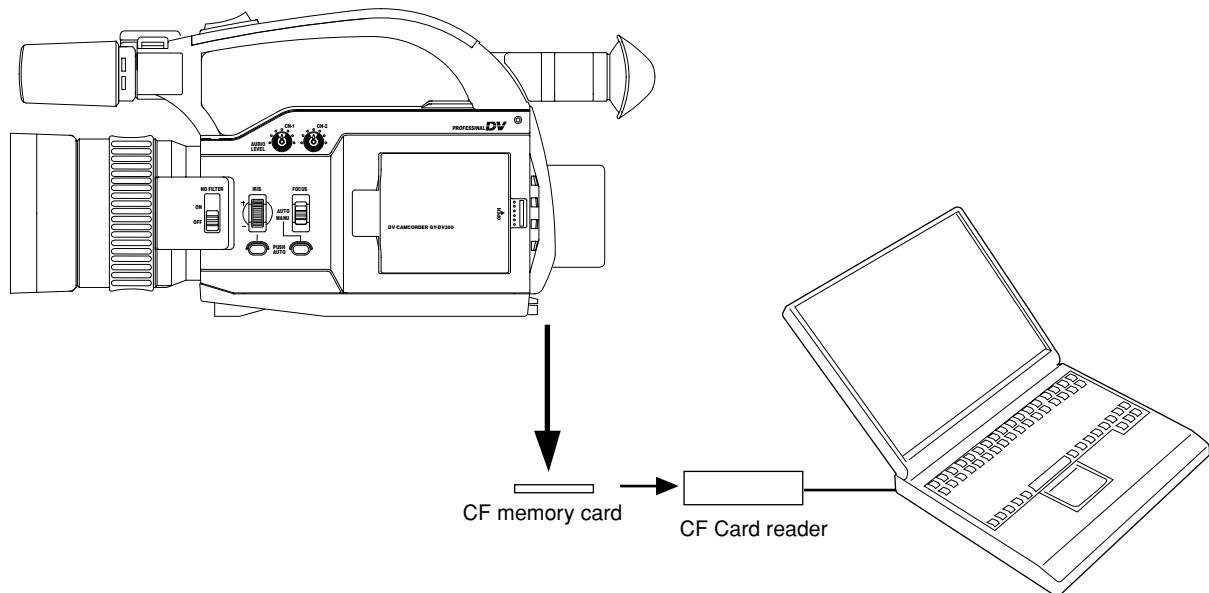

Clips recorded on a CF memory card can be played back on your PC.

* If the PC is equipped with PCMCIA slot(s), CF card reader is not required.

Caution

- Clips recorded on CF memory cards are stored in ASF file format.
- To play back a clip on your PC, Windows Media Player 7.01 is required.

* Media Player can be downloaded from the Microsoft Website.

During this time, download the following codec software as well.

The codec software is automatically downloaded when opening the clip file and running Windows Media Player.

- Video codec (decoder) ISO MPEG4
- Audio codec (decoder) G.726

Operation

- 1.** Load data already recorded on a CF memory card to your PC using a CF card reader, etc.
- 2.** Launch Explorer, etc., and open the recorded clip file in ASF format.
 - Windows Media Player launches and the clip is played back.

Memo

Video and audio files (clip files) in CF memory cards can be appended to email as attachment files.

LAN card Sending video using LAN card while recording on a DV cassette tape

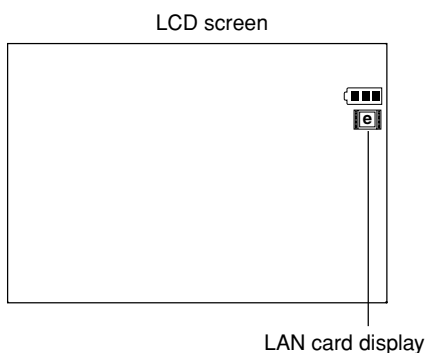
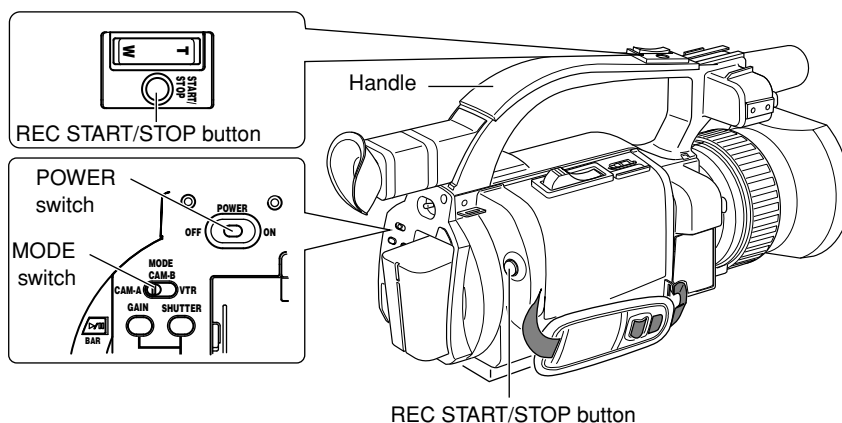

No LAN card is inserted when the  display appears. Turn off the power and insert a LAN card. Then, turn the power back on.

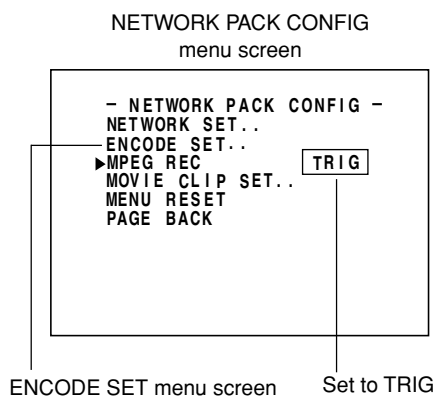

1. Insert a LAN card into the Network Pack.
2. Turn on the GY-DV300 power.
Check to see that the LAN card display is showing on the LCD screen/viewfinder screen.
3. Set the MODE switch to "CAM-A" or "CAM-B".
4. Insert a recordable DV cassette tape.
• GY-DV300 will be in the standby mode.
5. Set the NETWORK PACK CONFIG menu screen.
 - ① Set MPEG REC to "TRIG".
 - ② Set the video/audio compress in the ENCODE SET menu screen. (See page 6)
 - ③ When completed, press the MENU button to return to the normal screen.
6. When pressing the REC START/STOP button of GY-DV300 while Streamproducer is in operation*, transmission of video/audio streaming data from the LAN card is started simultaneously with recording to DV cassette tape.
• The LAN card display on the LCD screen/viewfinder screen will be as follows:
 : Yellow display during data transmission.
 Displayed in red when the media operating Streamproducer* at the destination of transmission starts recording.
 * Perform setting described in "5-2 Operating video from DV camcorder • Trigger mode function" of network distribution software "Streamproducer" User's Guide.
7. To stop transmission or recording, press the REC START/STOP button.
• GY-DV300 will be in the standby mode.
8. To resume transmission or recording, press the REC START/STOP button once more.
9. To end, press the REC START/STOP button to stop transmission and recording and turn off the power.
Lastly, remove the LAN card.

Memo

- Streaming data will be sent from the LAN card even when a DV cassette tape is not inserted.
- When the DV cassette tape reaches the end during recording, the transmission of streaming data from the LAN card is also stopped.

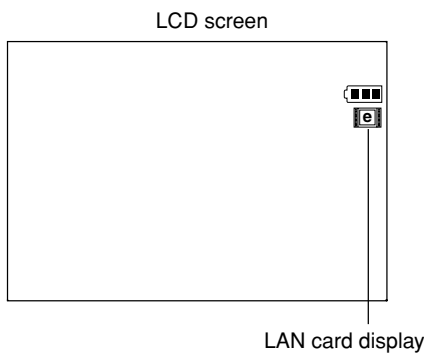
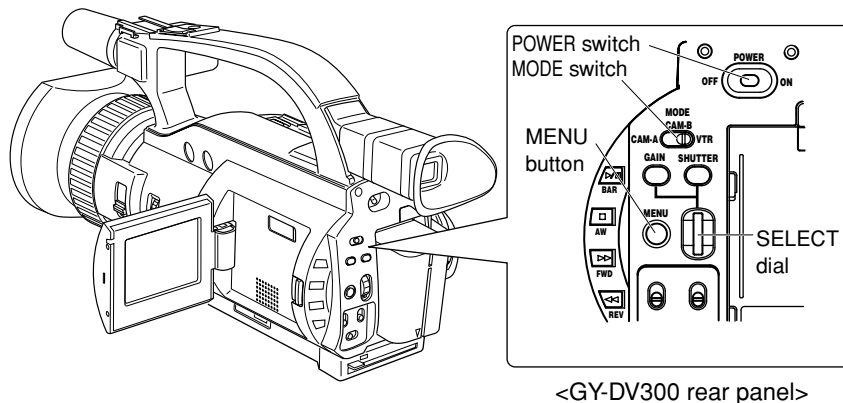

No LAN card is inserted when the  display appears. Turn off the power and insert a LAN card. Then, turn the power back on.

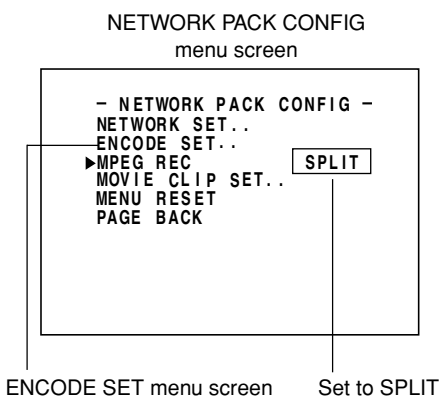

- 1.** Insert a LAN card into the Network Pack.
- 2.** Turn on the GY-DV300 power.
Check to see that the LAN card display is showing on the LCD screen/viewfinder screen.
- 3.** Set the MODE switch to "CAM-A".
- 4.** Set the NETWORK PACK CONFIG menu screen.
 - ① Set MPEG REC to "SPLIT".
 - ② Set the video/audio compress in the ENCODE SET menu screen. (see page 6)
 - ③ When completed, press the MENU button to return to the normal screen.
- 5.** When turning the SELECT dial of GY-DV300 while Streamproducer is in operation*, transmission of video/audio streaming data from the LAN card is started.
 - The LAN card display on the LCD screen/viewfinder screen will be as follows:
 -  : Yellow display during data transmission.
 - Displayed in red when the media operating Streamproducer* at the destination of transmission starts recording.

* Perform setting described in "5-2 Operating video from DV camcorder • Trigger mode function" of network distribution software "Streamproducer" User's Guide.
- 6.** To stop transmission, press the SELECT dial.
- 7.** To resume transmission, press the SELECT dial once more.
- 8.** To end, press the SELECT dial to stop transmission and turn off the power. Lastly, remove the LAN card.

MEMO

- When using the SELECT dial for GAIN or SHUTTER operation, no operation on the SELECT dial will be accepted for about 3 seconds after the operation is completed.
- Recording will not be made on the DV cassette tape even if a tape is inserted.

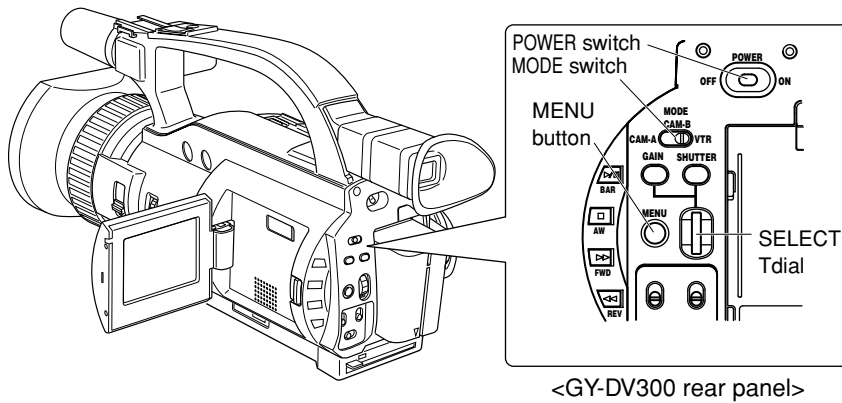

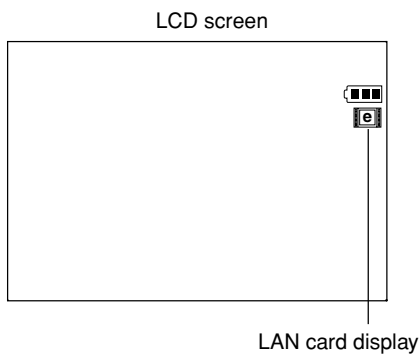

<GY-DV300 rear panel>

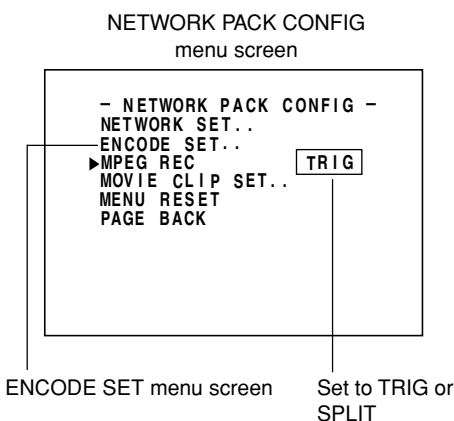

No LAN card is inserted when the  display appears on. Turn off the power and insert a LAN card. Then, turn the power back on.



- 1.** Insert a LAN card into the Network Pack.
- 2.** Turn on the GY-DV300 power.
Check to see that the LAN card display is showing on the LCD screen/viewfinder screen.
- 3.** Set the MODE switch to "VTR".
- 4.** Insert the recorded DV cassette tape.
- 5.** Set the NETWORK PACK CONFIG menu screen.
 - ① Set MPEG REC to "SPLIT".
 - ② Set the video/audio compression in the ENCODE SET menu screen.
( page 6)
 - ③ When completed with settings, press the MENU button to return to the normal screen.
- 6.** Launch Streamproducer.*
- 7.** Press the BAR (▶/||) button of GY-DV300 to start DV cassette tape playback.
- 8.** Press the SELECT dial at the beginning of the scene to send from LAN card.
 - Start transmission. The LAN card display on the LCD screen/viewfinder screen will be as follows:
 : Yellow display during data transmission.
 Displayed in red when the media operating Streamproducer* at the destination of transmission starts recording.

* Perform setting described in "5-2 Operating video from DV camcorder • Trigger mode function" of network distribution software "Streamproducer" User's Guide.
- 9.** To stop transmission, press the SELECT dial.
- 10.** To resume transmission, press the SELECT dial once more.
- 11.** To end, stop transmission and turn off the power. Lastly, remove the LAN memory card.

NETWORK PACK SETUP

Controlling GY-DU300/KA-DU300 via a LAN card

With the Network Pack, GY-DV300/KA-DV300 can be controlled via LAN.

It is also possible to playback video and audio from KA-DV300 on your PC in the STREAMCAPTURE screen in realtime (live display) as well as save data to files. However, note that video and audio from KA-DV300 can be played back only on one PC at a time.

Peer-to-peer connection that directly connects the unit with a PC is explained here.

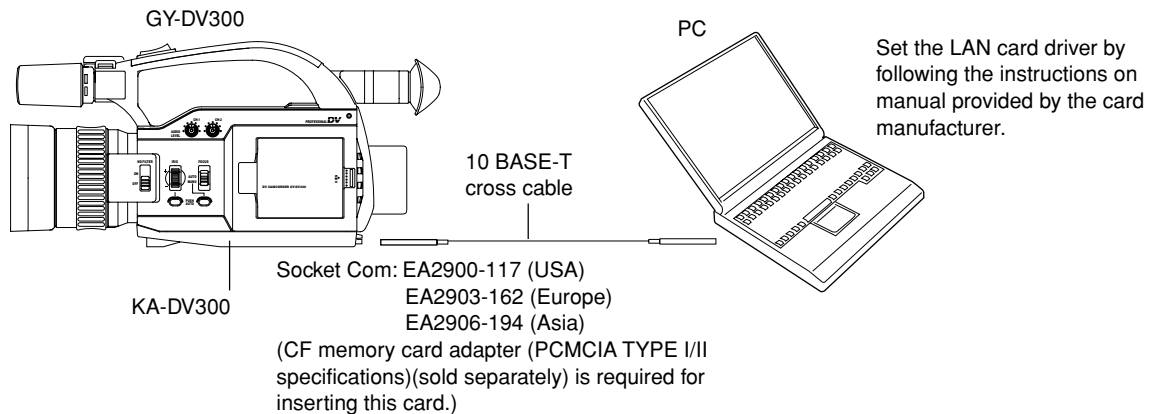

1. Turn your PC and GY-DV300 power off.
2. Insert the PCMCIA LAN card to specify into KA-DV300.
3. Connect the unit and PC using a 10 BASE-T cross cable.
4. Turn the PC and GY-DV300 power on.
5. Insert a recordable DV cassette tape.
6. PC settings
 - Set the LAN card driver according to the manual provided by the card manufacturer.
 - Network settings
 - ① Set the following items in the TCP IP properties:
IP address: 192.168.100.105
Subnet mask: 255.255.255.000
 - ② Setting the proxy server.
 - Set the proxy server using the “LAN SETTINGS” of Windows.
 - When using peer-to-peer communication that directly connects the PC and KA-DV300, deselect the “Use a proxy server” checkbox.
 - When the “Use a proxy server” setting must be enabled due to a LAN environment (in-company LAN, etc.), click “Advanced...” and input the IP address of GY-DV300 in “Exceptions” of the “Use a proxy server” setting.
(☞ “About proxy servers,” Page 41)
7. Launch the browser on your PC and enter 192.168.100.101 in the address bar and press ENTER.
 - A confirmation window for user ID and password appears.
8. Input the user ID and password.
 - ① For the user ID, input “jvc” (factory setting).
For the password, input “ka-dv300” (factory setting) or the name set in the NETWORK SET [2/2] menu screen.
(☞ page 10)
 - ② Check to make sure the inputted user ID and password are correct and click the OK icon.
(Check “Save password” so that the password does not need to be inputted for future accesses.)
9. If the user ID and password are correct, the NETWORK PACK SETUP screen appears on the PC monitor.
 - GY-DV300/KA-DV300 settings and operations can be controlled using the NETWORK PACK SETUP. (☞ page 30)

Caution

When setting the NETWORK PACK SETUP screen (CAMERA CONTROL, NETWORK SETUP, PORT SETUP or ENCODE PARAMETERS) and the same menu screen is displayed on the LCD screen or viewfinder of GY-DV300, values set in the NETWORK PACK SETUP screen will not appear on menu screen of the LCD screen or the viewfinder of GY-DV300.
The values set in the NETWORK PACK SETUP screen will appear after the menu screen of GY-DV300 is closed once and reopened.

Enter Network Password

Please enter your authentication information.

OK

Cancel

Resource: secured

User name:

Password:

When the correct user ID and password are accepted, the following Streamcorder screen appears.

Camera adjustments of GY-DV300 can be made in the CAMERA CONTROL screen.

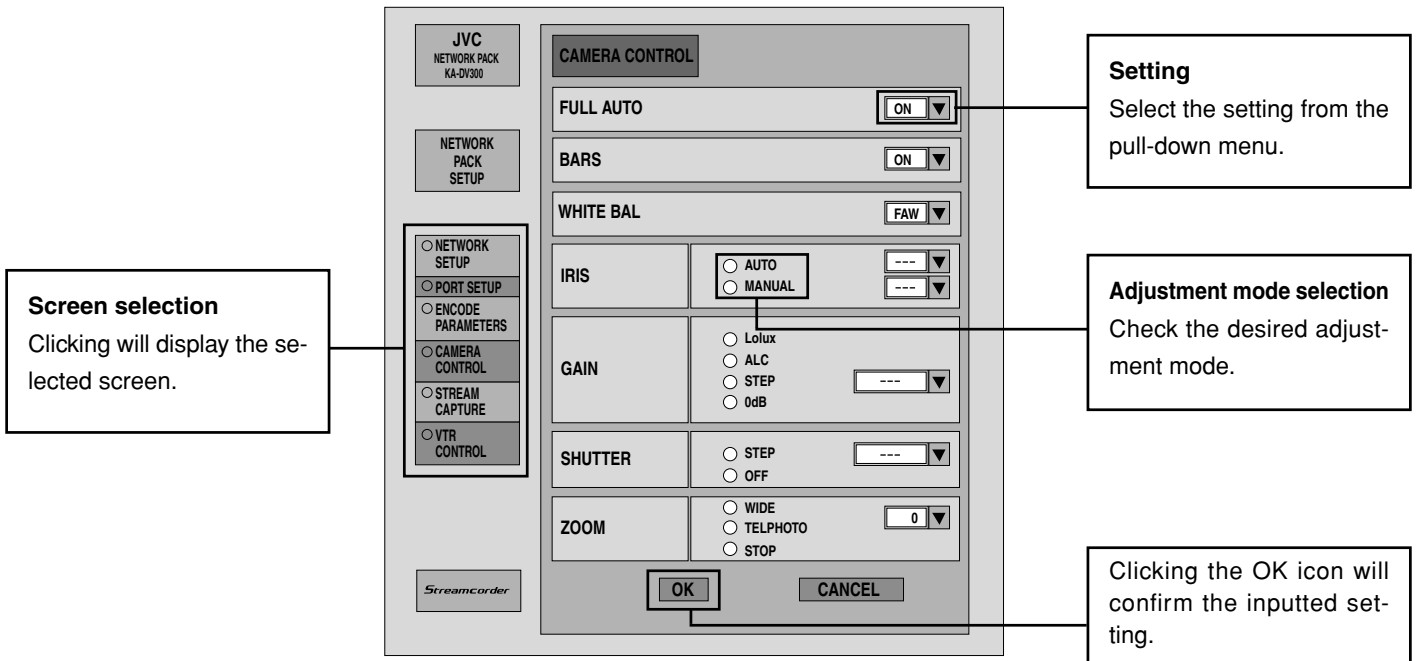

Setting range

- When setting AUTO to ON, items other than BARS will not be available.
- When setting BARS to ON, all other items will not be available.
- When setting GAIN to ALC, IRIS and SHUTTER will not be available.

Item	Adjustment mode	Setting/description
AUTO		ON: Auto mode on. Items other than BARS cannot be set. OFF: Auto mode off
BARS		ON: Color bar signals are outputted. Other items cannot be set. OFF: Color bar signals are not outputted.
WHITE BAL		FAW: Full white balance mode PRESET: White balance will be in the preset state. (3200K) MEMORY 1 ~ 3: White balance setting stored in the GY-DV300 memory will be used.
IRIS	AUTO	Auto iris mode. Iris will be adjusted within the following range: [-3, -2, -1, 0, 1, 2, 3,]
	MANUAL	Manual iris mode. Iris will be adjusted within the following range: [CLOSE, F16, F11, F8, F5.6, F4, F2.8, F2, F1.6]
GAIN	Lolux	Lolux mode
	ALC	ALC (Auto Level Control) mode. IRIS and SHUTTER cannot be set
	STEP	Gain can be set within the following range. (1 dB steps) [-3dB ~ 0dB ~ 18dB]
	0dB	0dB
SHUTTER	STEP	Shutter speed can be set within the following range: [1/100 (1/120), 1/250, 1/500, 1/1000, 1/2000] (): for E model
	OFF	Shutter speed will be 1/60 (1/50). (): for E model
ZOOM	WIDE	Zoom is set to WIDE. Setting can be made within the following range: [0, 1, 2, 3, 4, 5, 6, 7, 8, 9, 10]
	TELEPHOTE	Zoom is set to TELEPHOTE. Setting can be made within the following range: [0, 1, 2, 3, 4, 5, 6, 7, 8, 9, 10]
	STOP	Use this setting when not using zoom.

Clicking NETWORK SETUP on the left of the Streamcorder screen displays the NETWORK SETUP screen for performing network related settings.

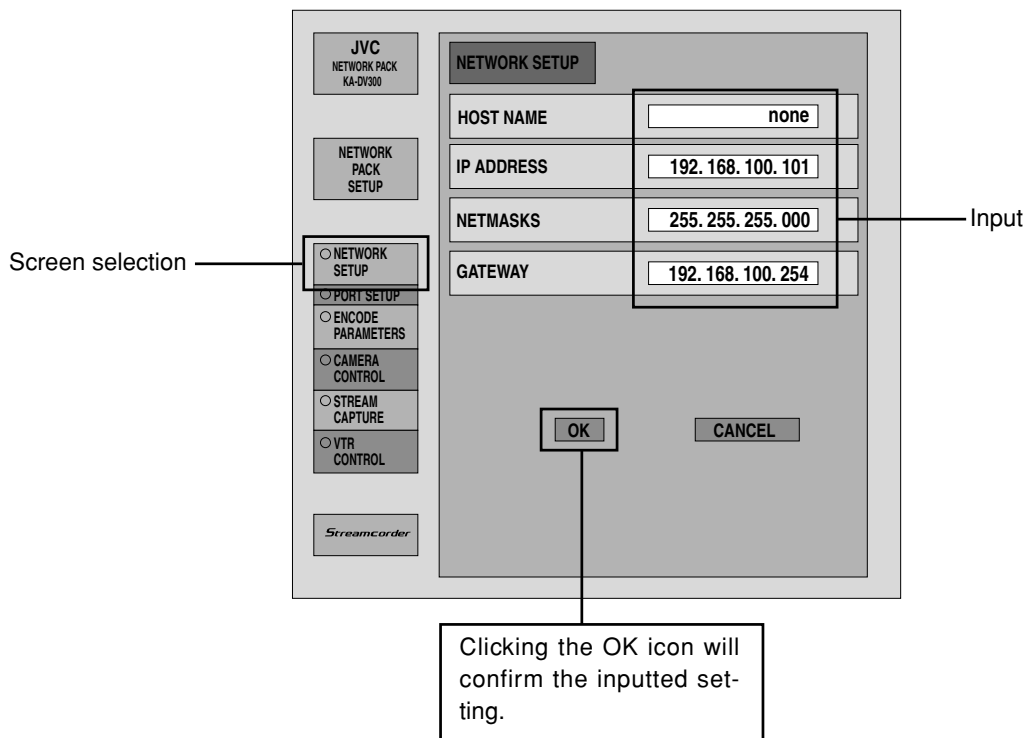

Contact your network administrator for any unclear points concerning network settings.

Item	Description	Factory setting
HOST NAME	The host name can be set. (Max: 64 alphanumerical characters)	none
IP ADDRESS	The IP address can be set. (Max: 12 numerical characters)	192.168.100.101
NETMASK	The subnet mask can be set. (Max: 12 numerical characters)	255.255.255.000
GATE WAY	The gateway address can be set. (Max: 12 numerical characters)	192.168.100.254

Caution

When changing the IP address in the Streamcorder screen, set the browser URL of the PC again. (Ⓜ operation **7.** on pages 29)

Clicking PORT SETUP on the left of the Streamcorder screen displays the PORT SETUP screen for performing port settings.

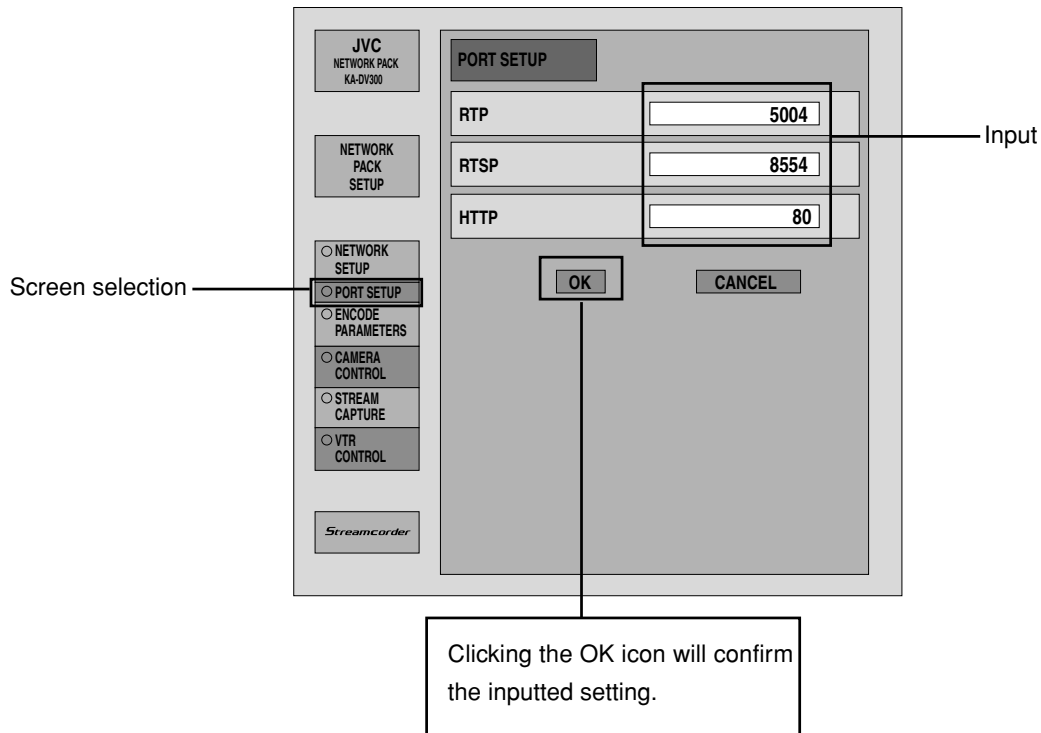

Item	Description	Factory setting
RTP	The RTP port can be set. (Max: 5 numerical characters)	5004
RTSP	The RTSP port can be set. (Max: 4 numerical characters)	8554
HTTP	The HTTP port can be set. (Max: 4 numerical characters)	0080

Changing ports require special knowledge. Always consult the administrator of the connecting network when making changes.

Clicking ENCODE PARAMETERS on the left of the Streamcorder screen displays the ENCODE PARAMETERS screen for performing video/audio compression settings.

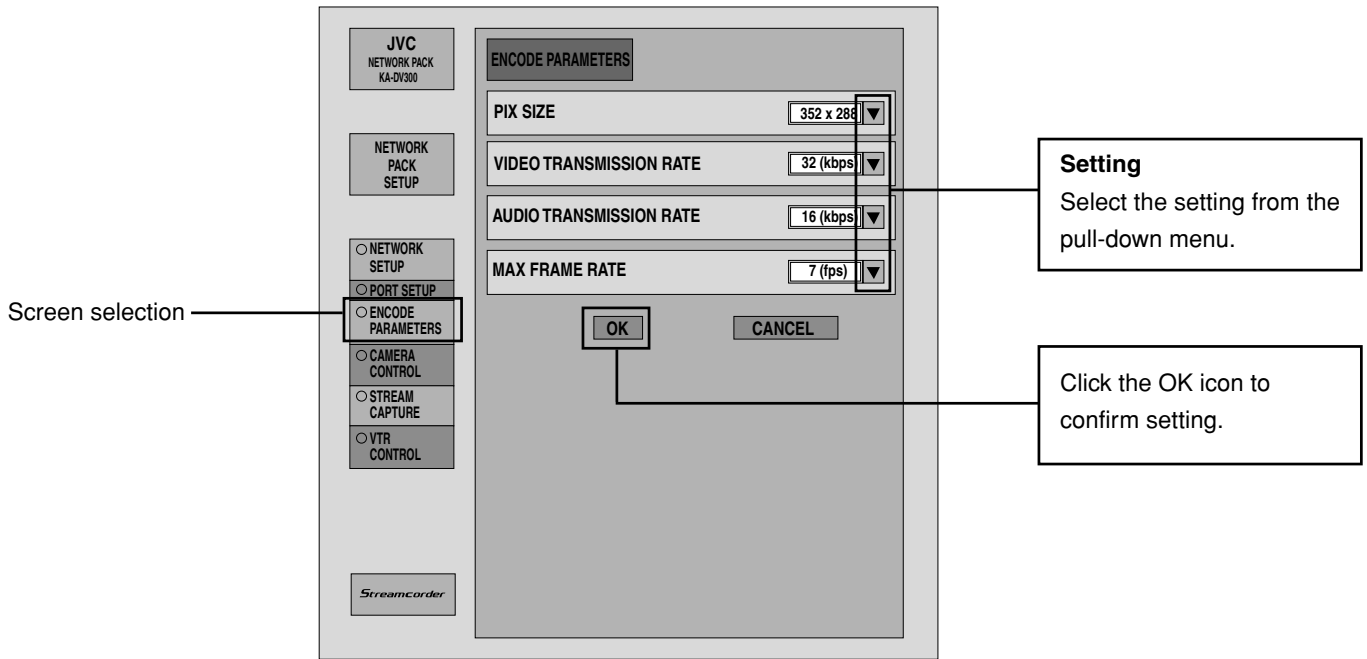

Setting range

● indicates default factory setting.

Item	Setting	Description
PIX SIZE	● 352X288 176X144	Sets the video compression size. 352 X 288: Sets the image size to 352 X 288 pixels. (CIF) 176 X 144: Sets the image size to 176 X 144 pixels. (QCIF) (1/4 image size of CIF.)
VIDEO TRANSMISSION RATE	● 32 (kbps) 64 (kbps) 128 (kbps) 256 (kbps) 384 (kbps)	Sets the video streaming speed (Kbps).
AUDIO TRANSMISSION RATE	OFF ● 16 (kbps) 32 (kbps)	Sets the audio streaming speed (Kbps).
MAX FRAME RATE (): for E model	30F (25F) 15F (13F) ● 7F (6F) 4F (3F)	Sets the frame rate per second. 30F (25F): Transfer is made using the frame rate of the original video. 15F (13F): Transfer is made using 1/2 the frame rate of the original video. 7F (6F): Transfer is made using 1/4 the frame rate of the original video. 4F (3F): Transfer is made using 1/8 the frame rate of the original video.

Memo

The relationship of PIX SIZE, VIDEO RATE and MAX FRAME RATE are as follows:

VIDEO TRANSMISSION RATE (kbps)	PIX SIZE		VIDEO TRANSMISSION RATE (kbps)	PIX SIZE	
	352 X 288	176 X 144		352 X 288	176 X 144
384	15 (12) Frames	30 (25) Frames	64	15 (12) Frames	30 (25) Frames
256	15 (12) Frames	30 (25) Frames	32	7 (6) Frames	30 (25) Frames
128	15 (12) Frames	30 (25) Frames			

Clicking VTR CONTROL on the Streamcorder screen displays the following VTR CONTROL screen for controlling the VTR functions of GY-DV300.

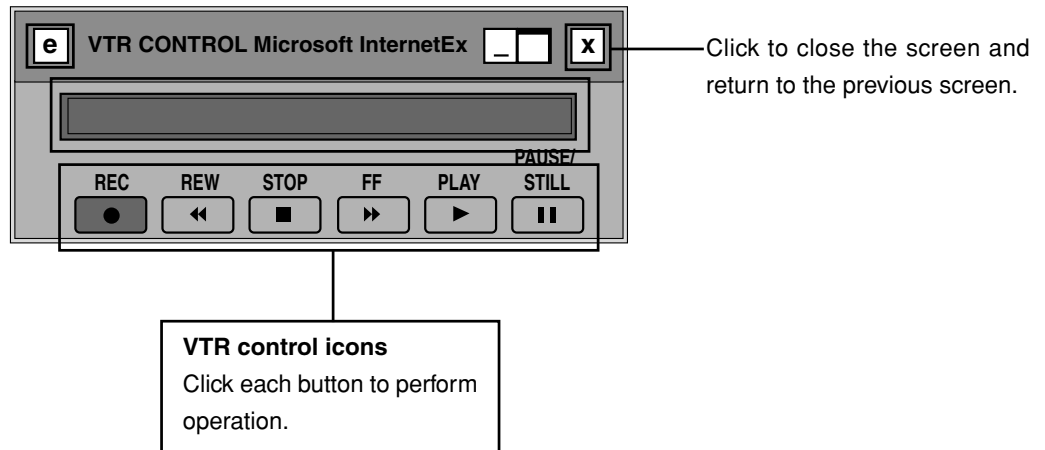

■ To control the VTR in the Streamcorder screen, the following menu items of GY-DV300 must be set in advance.

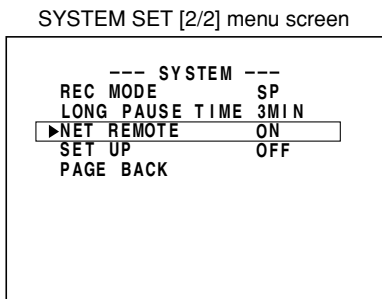

- Set NET REMOTE in the SYSTEM SET [2/2] menu screen to ON.
When set to OFF, the VTR cannot be controlled from the Streamcorder screen.

■ VTR control icon operations by MODE switch settings of GY-DV300 are as follows:

—: Mode will not change

GY-DV300 state		Clicking VTR control icon					
MODE switch	Previous mode	REC	REW	STOP	FF	PLAY	PAUSE/STILL
VTR	STOP	REC	REW	—	FF	PLAY	—
	FF	—	REW	STOP	—	PLAY	—
	REW	—	—	STOP	FF	PLAY	—
	PLAY	—	REV search	STOP	FWD search	—	STILL
	STILL	—	REV search	STOP	FWD search	PLAY	—
	FWD search	—	REV search	STOP	—	PLAY	STILL
	REV search	—	—	STOP	FWD search	PLAY	STILL
CAM-A or CAM-B	STOP	REC	—	—	—	—	—
	REC	—	—	—	—	—	STBY
	STBY	REC	—	STOP	—	—	—

NETWORK PACK SETUP STREAMCAPTURE screen (Playing back video/audio using a PC and saving to file)

Clicking STREAMCAPTURE on the left of the Streamcorder screen displays the Streamcapture screen shown below.

Video and audio sent from KA-DV300 via LAN can be played back on your PC in the Streamcapture screen or data can be saved to files. It can be used on a PC that has Streamproducer installed.

* Since video on the STREAMCAPTURE screen is converted video data, images will take more time to appear than the actual video taken with GY-DV300.

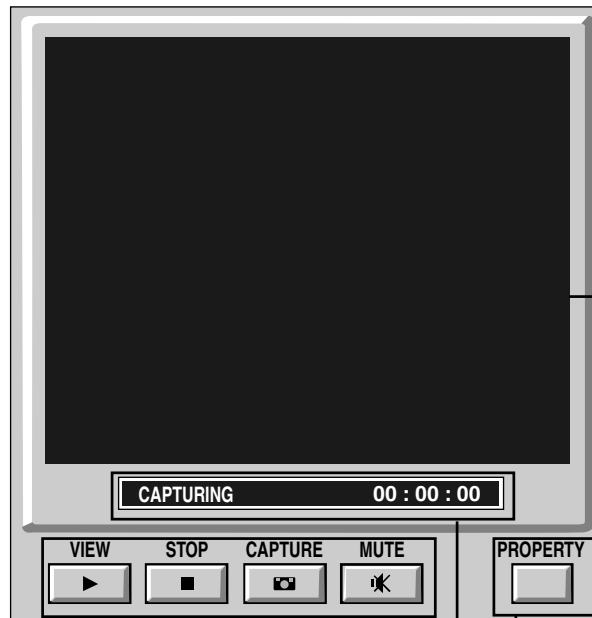

Operation buttons — Clicking will start operation. When on, the button will light.	
VIEW	Click to view video or listen to audio from KA-DV300 on your PC.
STOP	Click to stop operation.
CAPTURE	Click to save video or audio to a PC. Default destination My Document¥Streamcorder (¥IPAddress) Saved file name: The file name based on the capture start time will be used. 2 0 0 2 0 3 0 4 - 1 5 3 0 0 0 .asf □ □ □ □ □ □ Year Month Day Hour Minute Second
MUTE	Click to turn on/off the mute setting. When on, the playback sound will be muted.

Video display
The display size can be changed in the Property dialog box. (page 36)

The button is available when playback is stopped.
Clicking the button will display the Property dialog box.
Video display size and the save destination folder can be changed. (page 36)

Status/Time elapsed display

- The current status is displayed.
 VIEWING: Video or audio from KA-DV300 is being played back in realtime (live display).
 CAPTURING: Video or audio is being saved in your PC.
 STOP: Playback is stopped.
 BUFFERING: Data is being buffered from KA-DV300.
- Displays the time elapsed since the start of Preview or Capture operation. (Time: minutes:seconds)

Caution
About 10 seconds is required for video to be played back after pressing the VIEW or CAPTURE button.

Property dialog box

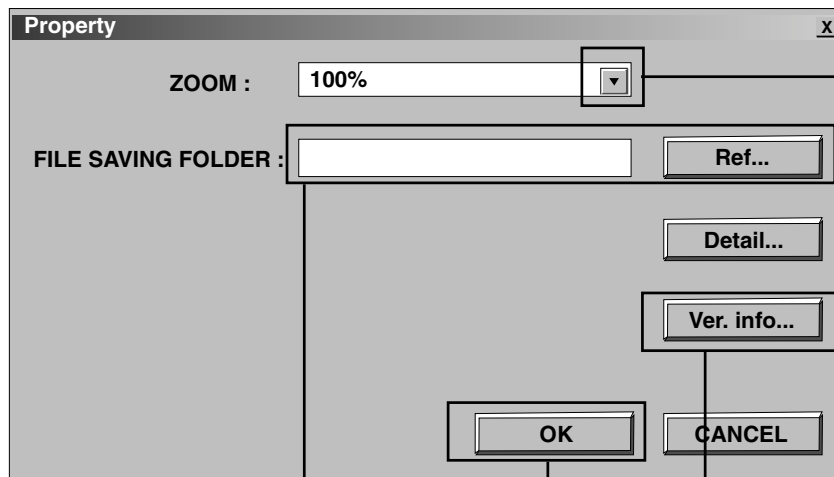

Save destination folder

The default save destination is as follows:
Set this field when changing the save destination folder.

My Document¥Streamcorder (¥IPAddress)

When changing the destination folder, press the Ref... button and select the desired folder. The changed destination folder will be the default folder for future save operations.

Click the OK button to confirm settings.

Select the video display size

Select the display size from the pull-down menu.

Setting range:
50%, 100%, 200%,
fit to window

Advanced settings dialog box

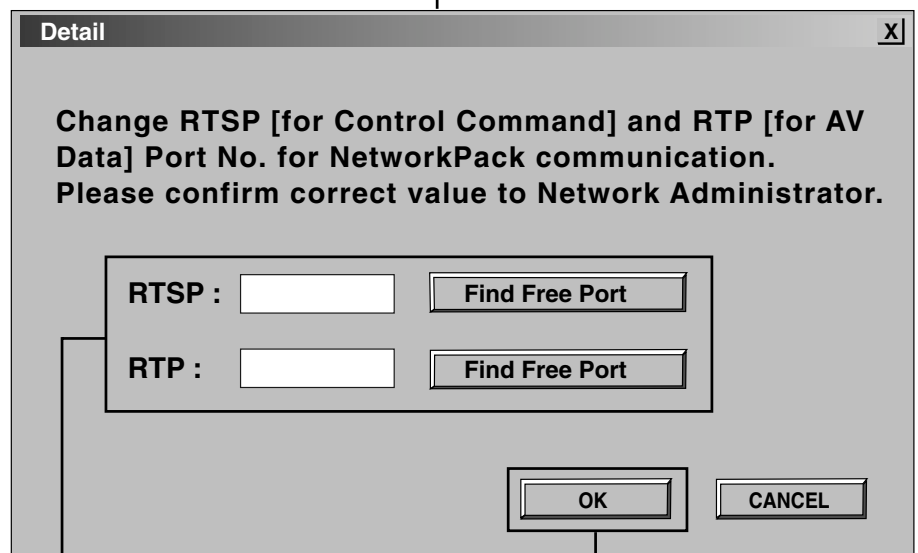

Client side RTSP port setting/RTP port setting

Follow the instructions given by the network administrator for these settings.

(Default settings: RTSP 8554
RTP 5004)

Click the OK button to confirm settings.

When there is a system error, network error, unit malfunction, etc., KA-DV300 displays the error on the GY-DV300 LCD screen or viewfinder screen.

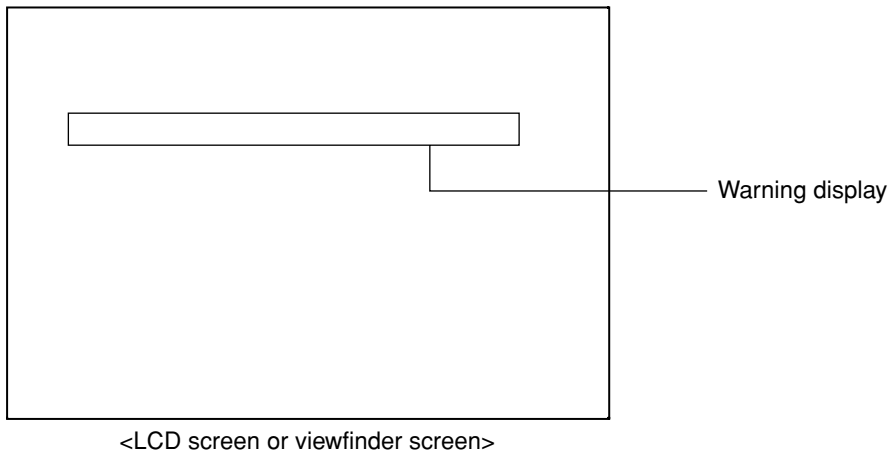

Screen display	Cause	Remedy	Reference page
<File system related>			
CF REMAIN 60SEC! (Flashing for 3 sec.)	Remaining time became less than 60 seconds during recording to CF memory card.	Stop recording and replace with a new CF memory card, or delete files on the current CF memory card to secure recording space.	24
CF REMAIN 30SEC!	Remaining time became less than 30 seconds during recording to CF memory card.		
CF REMAIN 20SEC!	Remaining time became less than 20 seconds during recording to CF memory card.		
CF REMAIN 10SEC!	Remaining time became less than 10 seconds during recording to CF memory card.		
CF FULL! (Displayed until CF recording stops)	Remaining time has run out during recording to CF memory card.		
CF FULL! (Flashing for 3 sec.)	Recording is being attempted on CF memory card with remaining time of less than 10 seconds.		
FORMAT ERROR!	Failed to format CF memory card.	Check the CF memory card and format again. If the card still cannot be formatted, contact your nearest JVC-authorized service agent.	16
NO CF FORMAT! (Flashing)	CF memory card is unformatted, or an unknown format is being used.	Check the CF memory card and format.	16

→ OVER

Screen display	Cause	Remedy	Reference page
<Operation related>			
NO CF CARD! (Flashing for 3 sec.)	There is no CF memory card inserted.	Insert a CF memory card.	3
PROTECT! (Flashing for 3 sec.)	Deletion of a protected clip file was attempted.	To delete the clip file, remove the protection.	23
NO CLIP! (Flashing for 3 sec.)	There is no CF memory card inserted, or there is no clip file available.	Check the CF memory card.	—
SET WLAN AD HOC MODE OFF! (Flashing for 3 sec.)	Use of DHCP server was attempted while in the AD HOC mode.	Set DHCP in the NETWORK SET menu screen to OFF when using the AD HOC mode.	11
SET DHCP OFF! (Flashing for 3 sec.)	Selection of AD HOC mode was attempted while using DHCP server.	Set WLAN AD MOC MODE in the NETWORK SET menu screen to OFF when using DHCP server.	11
SET VIDEO RATE 64k – 384k! (Flashing for 3 sec.)	Attempted to set MAX FRAM RATE to 15F when VIDEO RATE is set to 32k in the ENCODE SET menu.	Use VIDEO RATE between 64k ~ 384k.	6
SET MAX FRAME RATE 7F OR 4F! (Flashing for 3 sec.)	Attempted to set VIDEO RATE to 32k when MAX FRAME RATE is set to 15F in the ENCODE SET menu.	Use MAX FRAME RATE 7F or 4F.	6
SET MAX FRAME RATE 15F – 4F! (Flashing for 3 sec.)	Attempted to set PIX SIZE to 352 X 288 with MAX FRAME RATE set to 30F.	Use MAX FRAME RATE 15F ~ 4F.	6
SET PIX SIZE 176 x 144! (Flashing for 3 sec.)	Attempted to set MAX FRAME RATE to 30F with PIX SIZE set to 352 X 288.	Use PIX SIZE 176 X 144.	6

By using the PING command standard to Windows, it is possible to check whether the connection is correct and that communication can be made from the PC to KA-DV300.

- 1.** Launch the command prompt.
 - For Windows 2000
From the Start button, select [Programs] → [Accessories] → [Command Prompt].
- 2.** Input the following and press the Enter key.
PING xxx.xxx.xxx.xxx
(xxx.xxx.xxx.xxx is the IP address of the other party)
Input example: When the IP address of the other party is "192.168.0.10"
PING 192.168.0.10
- 3.** Check to see that the other party is successfully displayed.
If connection is not successful, "Request timed out" or "Destination host unreachable" message will appear.

- **IP address**

Identification number assigned to each computer that is connected to a network. The address is used for communication between network devices.

- **LAN (Local Area Network)**

A network structured within a relatively small range such as in a single building or an office of a company.

- **DHCP (Dynamic Host Control Protocol)**

Service that automatically assigns IP addresses within a LAN. When installed with a DHCP server, the network devices such as a PC, etc., are automatically assigned IP addresses.

- **WAN (Wide Area Network)**

A network structured within a wide area such as between the main office of a company and its branch offices. Internet is also generally referred to as WAN.

- **Netmask**

An IP address has the following two roles: 1) address for identifying the network, and 2) address for identifying individual computers. Netmask is a 32-bit value that defines the number of bits of the IP address to use for identifying the network.

- **Gateway**

Hardware and software used to relay when a computer communicates with another computer outside the network. The gateway IP address is referred to as the gateway address.

- **RTP (Realtime Transport Protocol)**

Protocol to transmit in realtime digitalized video/audio data via a network.

- **RTSP (Real Time Streaming Protocol)**

Protocol to control realtime transmission of video/audio data via a network.

- **HTTP (Hypertext Transport Protocol)**

Protocol used when transferring HTML (Hypertext Markup Language) files between WWW server and browser.

- **Protocol**

A set rule for a computer or communication device to perform communication over a network, etc.

- **IEEE802,11b**

International standard for wireless LAN with maximum communication speed of 11Mbps.

- **Channel (wireless LAN)**

Frequency range used by wireless LAN. The same frequency must be set by two sides for proper communication.

If there is an access point, adapter, etc., using the same band in the proximity, there may be a hindrance in the communication and may reduce throughput or the quality of communication. When setting, check the settings of surrounding access points, etc., to avoid doubling.

- **ESS-ID (wireless LAN)**

Network identification name used by wireless LAN. The name is used to distinguish other wireless LAN devices.

- **Ad hoc mode (wireless LAN)**

A mode for direct communication without passing through an access point.

- **Infrastrucure (wireless LAN)**

Form of communication via an access point.

- **Encryption mode**

Setting for encrypting the flow of data during wireless communication.

Following settings are available:

None (Open System): No encryption. Setting will be unavailable and throughput will be improved. However, there is the risk of information leakage.

40bit WEP: Encryption is performed using 40-bit encryption key.

128bit: Encryption is performed using 104-bit + 24-bit (1V) keys. Although throughput will decline compared to Open System, security of data will be improved.

- **Access point (wireless LAN)**

Relay point for infrastructure communication. It can also serve as the relay point for cable LAN or wireless LAN.

- **ASF (Advanced Streaming Format)**

Data streaming format developed by Microsoft Corporation (U.S.) for transmission of video and audio.

■ About IP address

Global IP address and local IP address

There are 2 types of IP addresses: “global IP address” and “local IP address”.

Global IP address: Just as different IP addresses are needed on a network, all PCs using the Internet worldwide must use a unique IP address. This IP address is referred to as “global IP address”.
Normally, the global address is assigned by the IS provider.

Local IP address: In an environment not connected to the Internet (within a household, within a company, etc.), separate IP addresses can be used freely within a network.
This IP address is referred to as “local IP address”.

IP address classes

IP addresses are categorized into 3 classes depending on the number of PCs structuring a network.

“Class A IP addresses” are used for large-scale networks, “Class B IP addresses” are used for medium-scale networks and “Class C IP addresses” are used for small-scale networks.

Within a network, all IP addresses must be of the same class. Each IP address is structured by a series of 4 digit numbers separated by a period. The first number of the IP address indicates the class.

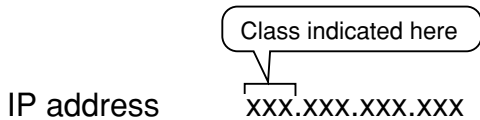

First number of the IP address	Class	Application (number of PCs structuring the network)
1~127	Class A	For large-scale networks (max. approx. 16 million units)
128~191	Class B	For medium-scale networks (max. approx. 65,000 units)
192~223	Class C	For small-scale networks (max. approx. 120 units)

* “224 ~ 255” are normally not used for IP addresses.

For example, a network structured by a few PCs to dozens of PCs would use Class C IP addresses.

Normally, the following special IP addresses are used when structuring a network.

Class	Set IP address
Class A	10.0.0.0 ~ 10.255.255.255
Class B	172.16.0.0 ~ 172.31.255.255
Class C	192.168.0.0 ~ 192.168.255.255

About proxy server

A proxy is a “relay point” for accessing the Internet. When enabling “Use a proxy server”, the proxy server will make access to the Internet.

Since various access information is cached at this time, downloading will be faster when reloading the same information from the Internet since the data is loaded from the proxy server.



JVC[®] is a registered trademark owned by VICTOR COMPANY OF JAPAN, LTD.

JVC[®] is a registered trademark in Japan, the U.S.A., the U.K. and many other countries.

© 2002 VICTOR COMPANY OF JAPAN, LIMITED