

OWNER'S MANUAL

J-400™ Collection

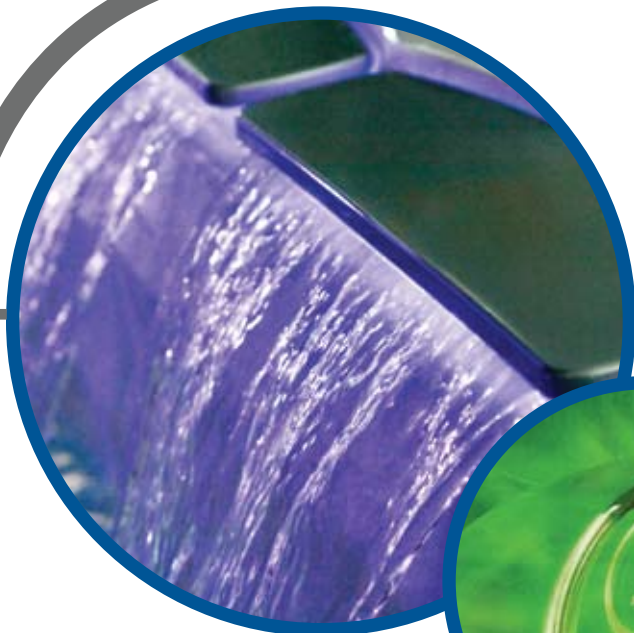

J - 460

J - 465

J - 470

J - 480

2530-442W Rev. E



Attention New Spa Owner!

Congratulations on the purchase of your new Jacuzzi® spa! The following is a list of automated functions performed by your spa. These functions are listed below in an attempt to suppress any operational concerns you may have during the first 24 hours of ownership! Also listed below are important maintenance recommendations you should observe on a regular basis to protect your new investment.

Automated Spa Operations

Your new spa is equipped with an automated “clean-up” cycle that clears all plumbing lines daily to promote maximum water sanitation. Each day at 12:00 PM (noon), each pump will activate and run for one minute. If either pump has just finished a 20 minute time out, it will not automatically activate for the clean-up cycle. Be aware, the factory programmed clean-up cycle cannot be canceled or altered!

Maintain Healthy Spa Water

Always maintain your spa’s water chemistry within the following parameters as defined by the Association of Pool And Spa Professionals/ USA:

pH	7.4-7.6
Free chlorine	3.0-4.0 ppm
Free bromine	2.0-4.0 ppm
Total Alkalinity	100-120 ppm
Calcium Hardness	150-250 ppm

 **TO DECREASE RISK OF INFECTION OR DISEASE!** Always maintain your spa filter as outlined below to ensure healthy spa water. Refer to pages 67-68 (Sec. 14.0) for additional information.

Required Filter Maintenance

Your new spa is equipped with an advanced water filtration system that provides unsurpassed water quality! To ensure maximum water quality at all times, you should clean the skimming filter cartridge every three months, or as necessary. See pages 67-68 (Sec. 14.0) for detailed filter cartridge cleaning instructions.

Required Water Replacement

 **TO DECREASE RISK OF INFECTION OR DISEASE!** You should replace the spa’s water every 3 months. The frequency depends on a number of variables including frequency of use, number of users and attention paid to water quality maintenance. You will know it is time for a change when you cannot control sudsing and/or you can no longer get the normal feel or sparkle to the water, even though the key water balance measurements are all within the proper parameters. See pages 72-73 (Sec. 15.0) for additional information.

Table of Contents

1.0	Important Spa Owner Information	1
2.0	FCC Notice	1
2.1	Industry Canada (IC) Information	1
3.0	Important Safety Instructions for all Spa Owners	2
3.1	Entrapment Risk	6
3.2	Hyperthermia	7
3.3	Important CSA safety instructions (Canada only).....	8
4.0	Choosing a Location	8
4.1	Outdoor Location	9
4.2	Indoor Location	10
5.0	General Electrical Safety Instructions	11
6.0	Electrical Installation Instructions (240V Service)	11
7.0	Power Requirements	16
8.0	Spa Fill Up Procedure	17
9.0	Spa Features	22
9.1	J-480 Spa Features	22
9.2	J-480 Massage/Waterfall Selector Diagram	23
9.3	J-480 Air Controls Diagram	24
9.4	J-470 Spa Features	25
9.5	J-470 Massage/Waterfall Selector Diagram	26
9.6	J-470 Air Controls Diagram	27
9.7	J-465 Spa Features	28
9.8	J-465 Massage/Waterfall Selector Diagram	29
9.9	J-465 Air Controls Diagram	30
9.10	J-460 Spa Features	31
9.11	J-460 Massage/Waterfall Selector Diagram	32
9.12	J-460 Air Controls Diagram	33
10.0	Control Panel Main Menu	34
10.1	Control Panel.....	34
10.2	Main Menu Features.....	35
10.3	Menu Flowchart.....	37
10.4	Entertainment Menu Display	38
10.5	iPod®/AUX Submenu	40
10.6	AUX Submenu.....	41
10.7	USB Submenu.....	42
10.8	NAND Submenu	44
10.9	FM Radio Submenu.....	45
10.10	AM Radio Submenu	47
10.11	CD Submenu.....	49

11.0	Operating Instructions	50
11.1	J-1000™ Control Panel	50
11.2	Activate Jets Pump	50
11.3	Activate Lights	51
11.4	Optional Exterior Lighting	53
11.5	Adjusting Individual Jet Flow	53
11.6	Adjusting PowerPro™ MX2 Jets	53
11.7	Adjusting RX Jets	53
11.8	WaterColour™ Waterfall Control	54
11.9	Air Controls	54
11.10	Selecting the Desired Massage Action	54
11.11	Optional J-1000™ JBL Audio System	54
12.0	Programming Instructions for Settings 1 Menu.....	55
12.1	To access the Settings 1 Menu:.....	55
12.2	Choosing the Language	55
12.3	Setting the Check Filter Reminder.....	56
12.4	Setting the Date.....	56
12.5	Setting the Time.....	57
12.6	Locking and Unlocking the Topside	58
13.0	Programming Instructions for Settings 2 Menus.....	59
13.1	Programming Heating Cycles.....	59
13.2	Auto-Heating Mode.....	60
13.3	Programmable Heating Mode.....	60
13.4	Clean-Up “Blow-Out” Cycle	63
13.5	Programming the Primary Filter Cycle	64
13.6	Programming the Secondary Filter Cycle	65
14.0	Spa Maintenance.....	66
14.1	Cleaning the Filter Cartridges.....	67
14.2	Draining and Refilling	68
14.3	Cleaning the Spa Interior.....	69
14.4	Pillow Care	69
14.5	Maintaining the Synthetic Cabinet.....	69
14.6	Cleaning the Control Panel.....	69
14.7	Vinyl Cover Care and Maintenance.....	70
14.8	Winterizing.....	70
14.9	Restarting Your Spa in Cold Weather.....	72
15.0	Water Quality Maintenance	72
15.1	pH Control	72
15.2	Sanitizing.....	73
15.3	Other Additives	73
15.4	Ozone Water Maintenance System (Optional)	73
16.0	Error/Display Messages	74
17.0	Troubleshooting Procedures.....	78

18.0	Typical Spa Wiring Diagrams	80
18.1	Wiring diagram for North American 60 Hz Models Only	80
19.0	Optional Jacuzzi J-1000™ Audio System Stereo System Features..	81
19.1	J-1000 Audio System Sound System Controls.....	81
19.2	J-1000 Audio System Sound System Operation	82
19.3	J-1000 Audio System Radio Operation	84
19.4	J-1000 Audio System CD Player Operation	85
19.5	J-1000 Audio System USB & NAND Operation.....	86
19.6	J-1000 Audio System iPod Operation.....	87
19.7	Docking your iPod Music Player.....	88
19.8	Generic MP3 Player Operation.....	89
19.9	J-1000 Audio System Stereo Troubleshooting	90
19.10	J-1000 Audio System Stereo Specifications.....	90
19.11	J-1000 Wireless Remote	91
19.12	J-1000 Wireless Remote Battery Replacement.....	98

1.0 Important Spa Owner Information

Your Jacuzzi® spa is constructed to the highest standards and is capable of providing many years of trouble-free use. However, because heat retentive materials are utilized to insulate the spa for efficient operation, an uncovered spa surface and wall fittings directly exposed to sunlight and high temperatures for an extended period is subject to permanent damage or discoloration. Damage caused by exposing the spa to this abuse is not covered under warranty. We recommend that you always keep the spa full of water when it is exposed to direct sunlight and that you keep the Jacuzzi insulating cover in place at all times when the spa is not in use. Read and carefully follow the requirements for your spa's support base found in the Section 4.0 titled, "Choosing a Location" (page 8).

Jacuzzi® spas constantly strives to offer the finest spas available, therefore, modifications and enhancements may be made which affect the specifications, illustrations and/or instructions contained herein.

2.0 FCC Notice

This device complies with part 15 of the FCC Rules. Operation is subject to the following two conditions: (1) This device may not cause harmful interference, and (2) this device must accept any interference received, including interference that may cause undesired operation.

This equipment has been tested and found to comply with the limits for a Class B Digital Device, pursuant to Part 15 of the FCC Rules. These limits are designed to provide reasonable protection against harmful interference in a residential installation. This equipment generates, uses and can radiate radio frequency energy and, if not installed and used in accordance with the instructions, may cause harmful interference to radio communications. However, there is no guarantee that interference will not occur in a particular installation. If this equipment does cause harmful interference to radio or television reception, which can be determined by turning the equipment off and on, the user is encouraged to try to correct the interference by one or more of the following measures:

1. Rearrange or relocate the receiving antenna;
2. Increase the separation between the equipment and receiver;
3. Connect the equipment into an outlet on a circuit different from the circuit connected;
4. Consult the dealer or an experienced radio/TV technician for help. (Changes or modifications not expressly approved by the party responsible for FCC compliance could void the user's authority to operate this equipment.)

2.1 Industry Canada (IC) Information

The installer of this radio equipment must ensure that the antenna is located or pointed such that it does not emit RF field in excess of Health Canada limits for the general population; consult Safety Code 6, obtainable from Health Canada's website: www.hc-sc.gc.ca/rpb.

3.0 Important Safety Instructions for all Spa Owners

READ AND FOLLOW ALL INSTRUCTIONS CAREFULLY!

This spa was manufactured to meet the standards and specifications outlined in the "Virginia Graeme Baker Pool and Spa Safety Act" (VGB Safety Act). When installing and using this spa, basic safety precautions should always be followed, including:

1.  **DANGER: RISK OF SEVERE INJURY OR DROWNING!**
 - Extreme caution must be exercised to prevent unauthorized access by children.
 - To avoid accidents, ensure that children do not use this spa unless supervised at all times. Adult supervision is a critical safety factor in preventing children from drowning.
 - Use the straps and clip tie downs to secure the spa cover when not in use. This will help discourage unsupervised children from entering the spa. Keep the spa cover secure in high-wind conditions.
 - There is no representation that the cover, clip tie-downs, or actual locks will prevent access to the spa.

2.  **DANGER: RISK OF SEVERE INJURY OR DROWNING!**
 - Keep hair, loose articles of clothing or hanging jewelry away from suction fittings, rotating jets or other moving components to avoid entrapment that could lead to drowning or severe injury.
 - Never use the spa unless all suction guards, filter, filter lid, or skimmer assembly are installed to prevent body and/or hair entrapment.
 - Never operate or use the spa if the filter, filter lid, or skimmer assembly are broken or any part of the skimmer assembly is missing. Please contact your dealer or nearest service center for service.
 - The suction fittings and suction covers in this spa are sized to match the specific water flow created by the pump(s). If it is necessary to replace the suction fittings, suction covers or pump(s), be sure that the flow rates are compatible and are in compliance with the VGB Safety Act.
 - Never replace a suction fitting or suction cover with one rated less than the flow rate marked on the original suction fitting. Using improper suction fittings or suction covers can create a body or hair suction entrapment hazard that may lead to drowning or severe injury.

3.  **DANGER: RISK OF SEVERE INJURY FROM ELECTRIC SHOCK OR DEATH FROM ELECTROCUTION!**
 - Install the spa at least 5 feet (1.5m), from all metal surfaces. As an alternative, a spa may be installed within 5 feet of metal surfaces if each metal surface is permanently connected (bonded) by a minimum No. 8 AWG (8.4 mm²) solid copper conductor attached to the wire connector

on the grounding lug, inside the equipment compartment on the equipment box.



- A grounding wire connector is provided on this unit to connect a minimum No. 8 AWG (8.4 mm²) solid copper conductor between this unit and any metal equipment, metal enclosures of electrical equipment, metal water pipe, or conduit within 5 feet (1.5m) of the unit.
- Never permit any electrical appliance, such as a light, telephone, radio, television, etc. within 5 feet (1.5m) of a spa unless such appliances are built-in by the manufacturer.
- Never bring any electrical appliances into or near the spa.
- Never operate any electrical appliances from inside the spa or when you are wet.
- The electrical supply for this product must include a suitably rated switch or circuit breaker to open all ungrounded supply conductors to comply with Section 422-20 of the National Electrical Code/USA, ANSI/NFPA 70. The disconnecting means must be readily accessible and visible to the spa occupant but installed at least 5 feet (1.5m), from the spa.
- The electrical circuit supplied for the hot tub must include a suitable ground fault circuit interrupter (GFCI) as required by NEC Article 680-42.

4.  **WARNING: RISK OF SEVERE INJURY OR DEATH!**

- Extreme caution must be exercised to prevent diving or jumping into the spa or slipping and falling, which could result in unconsciousness, drowning, or serious injury. Remember that wet surfaces can be very slippery.
- Never stand, walk or sit on the top railing of the spa.

5.  **WARNING: RISK OF HYPERTHERMIA (OVER-HEATING) CAUSING SEVERE INJURY, BURNS, WELTS OR DEATH!**

- Water temperature in excess of 104°F (40°C) may be injurious to your health.
- Refer to Section 3.2 Hyperthermia for specific causes and symptoms of this condition.
- The water in the spa should never exceed 104°F (40°C). Water temperatures between 100°F (38°C) and 104°F (40°C) are considered safe for a healthy adult.
- Lower water temperatures are recommended for young children (children are especially sensitive to hot water) and when spa use may exceed 10 minutes.
- The Consumer Products Safety Commission/USA has stated that the water temperature in a spa should not exceed 104°F (40°C).
- Always test the spa water temperature before entering the spa. The user should measure the water temperature with an accurate thermometer since the tolerance of water temperature-regulating devices may vary as much as +/- 5°F (2°C).

6.  **WARNING: RISK OF SEVERE INJURY OR DEATH!**
- Since excessive water temperatures have a high potential for causing fetal damage during the early months of pregnancy, if pregnant or possibly pregnant, consult your physician before using a spa.
 - Pregnant or possibly pregnant women should limit spa water temperatures to 100°F (38°C).
 - Persons suffering from obesity or a medical history of heart disease, low or high blood pressure, circulatory system problems, diabetes, infectious diseases or immune deficiency syndromes should consult a physician before using a spa.
 - If you experience breathing difficulties in association with using or operating your spa, discontinue use and consult your physician.
 - Persons using medication should consult a physician before using a spa since some medication may induce drowsiness, while other medication may affect heart rate, blood pressure, and circulation.
 - Persons suffering from any condition requiring medical treatment, the elderly, or infants should consult with a physician before using a spa.
 - The use of alcohol, drugs, or medication before or during spa use may lead to unconsciousness with the possibility of drowning.
7.  **WARNING: RISK OF SEVERE INJURY OR DEATH!**
- Prolonged immersion in a spa may be injurious to your health.
 - Observe a reasonable time limit when using the spa. Exposures at higher temperatures can cause high body temperature (over-heating). Symptoms may include dizziness, nausea, fainting, drowsiness, and reduced awareness. These effects could possibly result in drowning or serious injury.
 - Never use a spa immediately following strenuous exercise. Enter and exit the spa slowly. Wet surfaces can be slippery.
8.  **WARNING: TO DECREASE RISK OF INFECTION OR DISEASE!**
- To reduce the risk of contracting a waterborne illness (e.g. an infection, bacteria or virus) and/or respiratory ailments, maintain water chemistry within the parameters listed on the inside cover of this manual and consult with a licensed engineer regarding proper ventilation if installed indoors or in an enclosed area.
 - People with infectious diseases should not use a spa to avoid water contamination, which could result in spreading infections to others.
 - Always shower before and after using your spa. Maintain water chemistry in accordance with manufacturer's instructions. Failure to do so may result in contracting a waterborne illness (e.g. an infection, bacteria or virus).

9.  **WARNING:** In addition to maintenance of filters and water chemistry, proper ventilation is recommended to reduce the risk of contracting a waterborne illness (e.g. an infection, bacteria or virus) and/or respiratory ailments that could be present in the air or water. Consult a licensed architect or building contractor to determine your specific needs if installing your hot tub indoors.

10. **CAUTION: TO DECREASE RISK OF PRODUCT DAMAGE.**

- Maintain water chemistry in accordance with manufacturer's instructions.
- Proper chemical maintenance of spa water is necessary to maintain safe water and prevent possible damage to spa components.

11. **NOTE:**

This spa is not intended nor designed to be used in a commercial or public application. The spa buyer shall determine whether there are any code restrictions on the use or installation of this spa since local code requirements vary from one locality to another.

Hot Tub Safety Literature

To ensure you have a safe and enjoyable hot tub experience, learn all you can about hot tub safety and emergency procedures. Especially useful are the brochures listed below:

- [Children Aren't Waterproof](#)
- [Pool and Spa Emergency Procedures For Infants and Children](#)
- [Layers of Protection](#)
- [The Sensible Way to Enjoy Your Spa or Hot Tub](#)

The Association of Pool and Spa Professionals publishes these brochures. To acquire a brochure:

- Ask your hot tub dealer (they may have copies)
- Go to <http://apsp.org>
- Conduct your own search on the internet
- Write to the following address:

The Association of Pool and Spa Professionals
2111 Eisenhower Avenue
Alexandria VA 22314
703.838.0083

3.1 Entrapment Risk

The Consumer Products Safety Commission/USA has reported that users of pools and spas have become entrapped (stuck) to drain and/or suction fittings causing death, drowning, or serious injury (see diagram below). This spa was manufactured to meet the standards and specifications outlined in the “Virginia Graeme Baker Pool and Spa Safety Act” (VGB Safety Act). Entrapment risk can be minimized if proper precautions are taken.





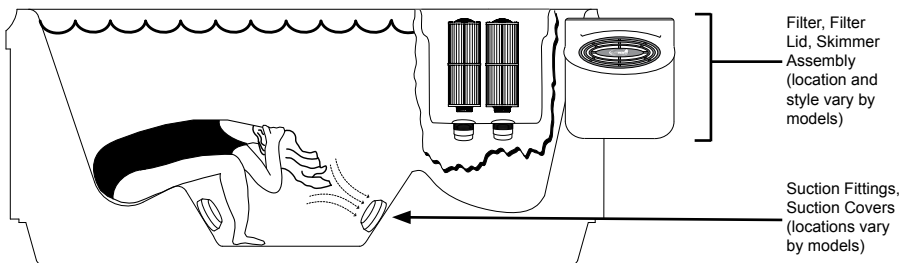

DANGER: RISK OF PERSONAL INJURY OR DEATH!

Never operate the spa if a suction fitting, suction cover, filter, filter lid or skimmer assembly are broken, damaged or missing.



1.  **DANGER: RISK OF SEVERE INJURY OR DROWNING!**
Hair entrapment: May occur if hair is entangled, knotted or snagged in a drain suction or skimmer assembly. This has been reported in persons who when submerge themselves underwater, allowing hair to come close and/or within the reach of the suction fittings, suction covers or skimmer assembly.
 - Keep hair away from suction fittings, suction covers, filter, filter lid or skimmer assembly.
 - Children are at risk for hair entrapment if swimming under water.
 - Never allow children to play or get near the suction fittings, suction covers, filter, filter lid or skimmer assembly.

2.  **DANGER: RISK OF SEVERE INJURY OR DROWNING!**
Limb entrapment: May occur when a limb becomes entrapped, inserted or sucked into a suction or outlet opening.
 - Always keep suction fittings, suction covers, filter, filter lid or skimmer assembly in place when operating to avoid limb entrapment.
 - Never allow children to play or get near the suction fittings, suction covers, filter, filter lid or skimmer assembly.

3.  **DANGER: RISK OF SEVERE INJURY OR DROWNING!**
Body entrapment: May occur when part of the torso becomes entrapped, inserted or sucked into a suction or outlet opening.
- Never allow children to play or get near the suction fittings, suction covers, filter, filter lid or skimmer assembly.
4.  **DANGER: RISK OF SEVERE INJURY OR DROWNING!**
Evisceration (disembowelment) entrapment: May occur when the buttocks becomes entrapped, inserted or sucked into a suction or outlet opening.
- Never sit on suction fittings, suction covers, filter, filter lid or skimmer assembly.
 - Never allow children to play or get near the suction fittings, suction covers, filter, filter lid or skimmer assembly.
5.  **DANGER: RISK OF SEVERE INJURY OR DROWNING!**
Mechanical entrapment: May occur when jewelry, swimsuit, or hair accessories become entangled, knotted or snagged in a drain suction or skimmer assembly.
- Never allow your jewelry, swimsuit, or hair accessories to come close to the suction fittings, suction covers or skimmer assembly.
 - Never allow children to play or get near the suction fittings, suction covers, filter, filter lid or skimmer assembly.

3.2 Hyperthermia

Prolonged immersion in hot water may induce hyperthermia (overheating). The use of alcohol or drugs can greatly increase the risk of fatal hyperthermia in spas. A description of the causes, symptoms, and effects of hyperthermia are as follows:

Hyperthermia occurs when the internal temperature of the body reaches a level several degrees above the normal body temperature of 98.6°F (37°C). The symptoms of hyperthermia include drowsiness, lethargy (fatigue), and an increase in the internal temperature of the body (feeling of being too hot). The effects of hyperthermia include:

- Unawareness of impending hazard;
- Failure to perceive heat;
- Failure to recognize the need to exit spa;
- Physical inability to exit spa;
- Fetal damage in pregnant women; and
- Unconsciousness and danger of drowning.

A Warning Sign is provided in your warranty packet. Please install at a location near your spa, where it is visible to users of the spa. For additional or replacement Warning Signs please contact your local Jacuzzi dealer and reference item number #6530-082.

3.3 Important CSA safety instructions (Canada only)

When using this electrical equipment, basic safety precautions should always be followed, including the following:

1. **READ AND FOLLOW ALL INSTRUCTIONS.**
2. A green colored terminal or a terminal marked G, Gr, Ground, Grounding or the  symbol* is located inside the supply terminal box or compartment. To reduce the risk of electric shock, this terminal must be connected to the grounding means provided in the electric supply service panel with a continuous copper wire equivalent in size to the circuit conductors that supply this equipment. *IEC Publication 417, Symbol 5019.
3. At least two lugs marked "Bonding Lugs" are provided on the external surface or on the inside of the supply terminal box/ compartment. To reduce the risk of electric shock, connect the local common bonding grid in the area of the spa to these terminals with an insulated or bare copper conductor not smaller than No. 6 AWG (10 mm²).
4. All field-installed metal components such as rails, ladders, drains or other similar hardware within 10 feet (3m) of the spa shall be bonded to the equipment grounding buss with copper conductors not smaller than No. 6 AWG (10 mm²).
5. **SAVE THESE INSTRUCTIONS.**

4.0 Choosing a Location

IMPORTANT: Because of the combined weight of the spa, water and users, it is extremely important that the base upon which the spa rests be smooth, flat, level and capable of uniformly supporting this weight, without shifting or settling, for the entire time the spa is in place. If the spa is placed on a surface which does not meet these requirements, damage to the skirt and/or the spa shell may result. Damage caused by improper support is not covered under warranty. It is the responsibility of the spa owner to assure the integrity of the support at all times. We recommend a poured, reinforced concrete slab with a minimum thickness of 4 inches (10 cm). Wood decking is also acceptable provided it is constructed so that it meets the requirements outlined above.



WARNING: For spas that are to rest on balconies, roofs or other platforms not specifically tied into main structural support, consult a professional Structural Engineer with experience in this type of application.

The spa must be installed in such a manner as to provide drainage away from it. Placing the spa in a depression without provisions for proper drainage could allow rain, overflow and other casual water to flood the equipment and create a wet condition in which it would sit in. For spas which will be recessed into a floor or deck, install so as to permit access to the equipment, either from above or below, for servicing. Make certain that there are no obstructions which would prevent removal of all side cabinet side panels and access to the jet components, especially on the side with the equipment bay.



CAUTION: If the spa is indoors or located in an enclosed area, proper ventilation should be discussed with an Engineer or authority competent enough to understand the necessary provisions needed to vent moist or heated air and air associated with chemical odors outdoors. **When the spa is in use considerable amounts of moisture will escape potentially causing mold and mildew. This can cause health risk.** Over time, this can damage certain surfaces, surroundings, and equipment.

4.1 Outdoor Location

In selecting the ideal outdoor location for your spa, we suggest that you take into consideration:

- The proximity to changing area and shelter (especially in colder weather).
- The pathway to and from your spa (this should be free of debris so that dirt and leaves are not easily tracked into the spa).
- The closeness to trees and shrubbery (remember that leaves and birds could create extra work in keeping the spa clean).
- A sheltered environment (less wind and weather exposure can result in lowered operation and maintenance costs).
- The overall enhancement of your environment. It is preferable not to place the spa under an unguttered roof overhang since run-off water will shorten the life expectancy of the spa cover.
- For spas that are to rest on balconies, roofs or other platforms not specifically tied into main structural support, consult a professional Structural Engineer with experience in this type of application.

4.2 Indoor Location

For indoor installations many factors need to be considered before installing a spa indoors.



WARNING: In addition to maintenance of filters and water chemistry, proper ventilation is recommended to reduce the risk of contracting a waterborne illness (e.g. an infection, bacteria or virus) and/or respiratory ailments that could be present in the air or water. Consult a licensed architect or building contractor to determine your specific needs if installing your hot tub indoors.

- **Proper Foundation:** Consult a Structural Engineer when considering a foundation that will adequately support the spa the entire time it is in place. Proper support is critical especially if the spa is to rest on a second story or higher. For spas that are to rest on balconies, roofs or other platforms not specifically tied into the main structural support, you should consult a professional Structural Engineer with experience in this type of application.
- **Proper Drainage:** It is extremely important to have in place measures to sufficiently handle excessive water spillage. Be sure the flooring in which the spa rests on has adequate drainage and can handle the entire contents of the spa. Be sure to make provisions for ceilings and other structures that may be below the spas installation. Areas around your spa can become wet or moist so all flooring and subsequent furniture, walls and adjacent structures should be able to withstand or resist water and moisture.
- **Proper Ventilation:** Proper ventilation should be discussed with an Engineer or authority competent enough to understand the necessary provisions needed to vent moist or heated air and air associated with chemical odors outdoors. When the spa is in use considerable amounts of moisture will escape, potentially causing mold and mildew over time which can damage certain surfaces and/or surroundings.
- **Sufficient Access:** In the unlikely event that you should ever need to access or gain entry to any portion of the spa for servicing, it is highly recommended that you plan your indoor installation to provide full access to the entire spa.
- **Warranty:** Damage caused by not following these guidelines or any improper installation not in accordance to local codes or authorities is not covered under the spas warranty. Please consult your local state or city building ordinances.

5.0 General Electrical Safety Instructions

Your new Jacuzzi® spa is equipped with the J-1000™ system. It contains the most advanced safety and self-protective equipment in the industry. Nonetheless, this spa must be installed properly to ensure dependable usage. Please contact your local Jacuzzi dealer or local building department should you have any questions regarding your installation. Proper grounding is extremely important. Jacuzzi spas are equipped with a current collector system. A pressure wire connector is provided on the surface of the control box, located inside the equipment door (Figure B, page 13) to permit connection of a bonding wire between this point and any ground metal equipment, metal water pipe or conduit within 5 feet (1.5m) of the spa, or copper clad grounding rod buried within 5 feet (1.5m) of the spa. Bonding wire must be at least No. 8 AWG (8.4 mm²) solid copper wire. This is a most important safety assurance feature.

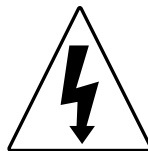

Before installing your spa, check with your local building department to ensure installation conforms to local building codes.

6.0 Electrical Installation Instructions (240V Service)

IMPORTANT NOTICE: The electrical wiring of this spa must meet the requirements of the National Electrical Code/USA (NEC) and any applicable state or local codes. The electrical circuit must be installed by a qualified electrician and approved by a local building/electrical inspection authority.

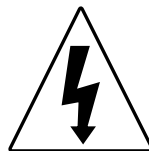

1. **DANGER: TO DECREASE THE RISK OF SHOCK, PRODUCT DAMAGE OR ELECTRICAL FIRE.**

This spa must be permanently connected (hard-wired) to the power supply. **No plug-in connections or extension cords are to be used in conjunction with the operation of this spa.** Supplying power to the spa which is not in accordance with these instructions will void both the independent testing agency listing and the manufacturer's warranty.

2. The power supplied to this spa must be a dedicated circuit with no other appliances or lights sharing the power provided by the circuit.
3. To determine the current, voltage and wire size required, refer to Section 7.0 "Power Requirements" (page 16) for your specific spa model.
 - Wire size must be appropriate per NEC and/or local codes.
 - We recommend type THHN wire.
 - All wiring must be copper to ensure proper connections. **Do not use aluminum wire.**
 - When using wire larger than #6 (10 mm²), add a junction box near the spa and reduce to short lengths of #8 (8.4 mm²) wire to connect to the spa.

4. The electrical supply for this product must include a suitably rated switch or circuit breaker to open all ungrounded supply conductors to comply with Section 422-20 of the National Electrical Code/USA, ANSI/NFPA 70. The disconnecting means must be readily accessible to the spa's occupant but installed at least 5 feet (1.5m) from spa water.
5. The electrical circuit supplied for the spa must include a suitable ground fault circuit interrupter (GFCI) as required by NEC Article 680-42/USA.
6. To gain access to the spa's power terminal block, remove the screws securing the cabinet panel on the side of the spa under the controls. Then remove the four door screws for the small access door on the control box (Figure A).
7. Select the power supply entrance you want to use (Figure A) and remove the short cabinet panel from the front of the spa. Make sure to install a 3/4" electrical fitting and conduit through the large opening provided in the bottom of the control box so you can feed the cable through to the terminal block.
8. Connect wires to the terminal block (Figures B-E, pages 13-15). **ALL WIRES MUST BE SECURELY CONNECTED** or equipment damage could result!
9. Install control access box door and reinstall the cabinet side panels.

**Figure A
Equipment Area**

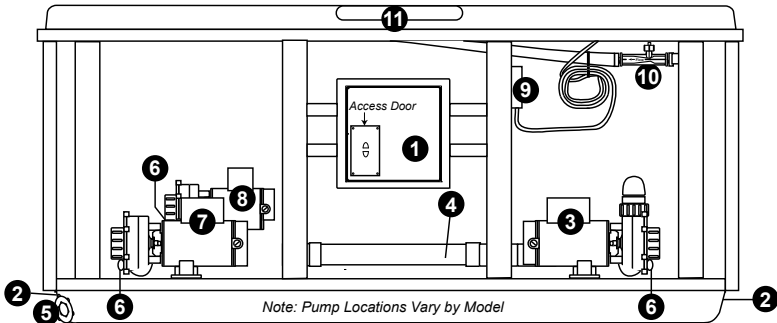

- | | |
|-----------------------------|--|
| 1. J-1000™ Control Box | 7. Jets Pump #2 |
| 2. Power Supply Entrance(s) | 8. Filter/Circulation Pump |
| 3. Jet Pump #1 | 9. Optional CD Ozonator
(Purchase Separately) |
| 4. Heater | 10. Factory Installed Ozone Injector |
| 5. Spa Drain Valve | 11. J-1000 Control Panel |
| 6. Pump Drain Plugs(s) | |

Figure B
60Hz Terminal Block Connection

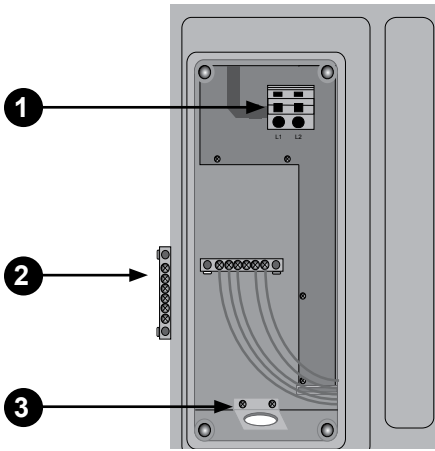

1. Main Terminal Block
2. Bonding Lug/Grounding Terminal
3. Power wires Entrance (Electrical fitting and conduit must be installed)

Figure C
Terminal Connection
(North American 240 VAC Connection Shown)

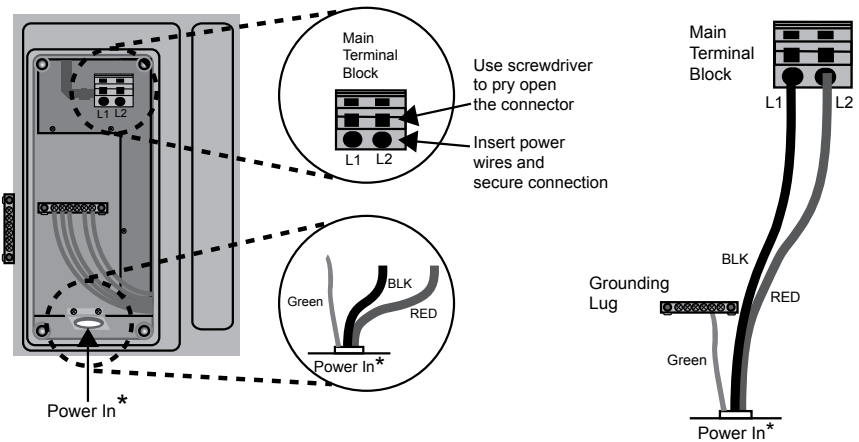

*Electrical fitting and conduit must be installed

Figure D
50Hz Terminal Block Connection

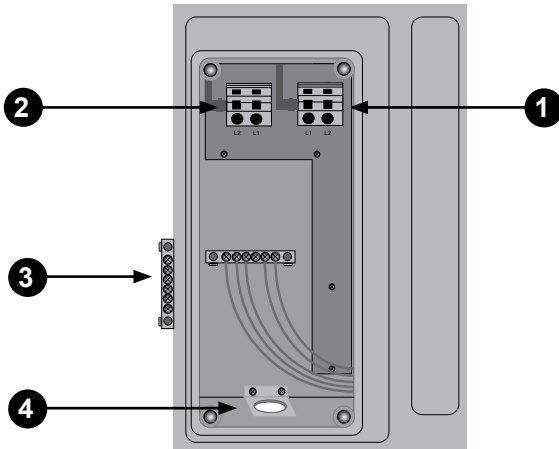

1. Main Terminal Block
2. Heater Terminal Block
3. Bonding Lug/Grounding Terminal
4. Power wires Entrance (Electrical fitting and conduit must be installed)

Figure E
Terminal Connection
(Export 230 VAC 50 Hz Connection Shown)

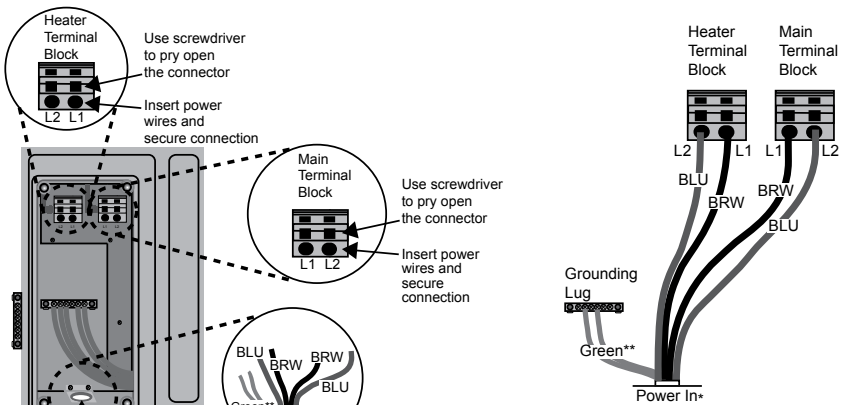

** May only require one green grounding wire. Check your local country codes.

*Electrical fitting and conduit must be installed

Figure F

1. Obtain a flat head screwdriver (3/16" x 6" slotted).
2. Place it flush against the middle slot of the terminal block (diagram 1).

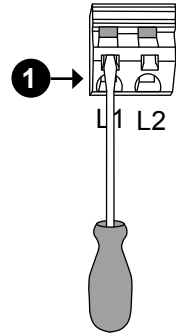
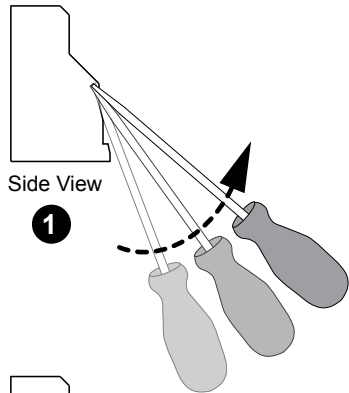
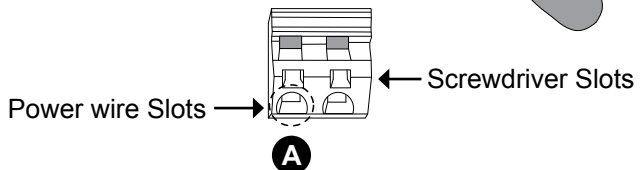
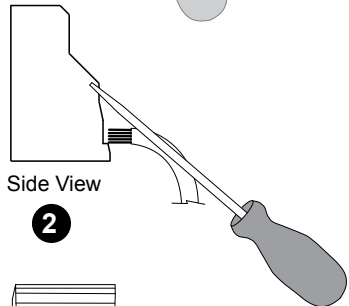

Figure G

1. Firmly press inward and upward on screwdriver blade, then pivot upward to open underlying wire clamp. Hold this position for step 2.



2. Insert power wire into slot A as shown, then remove screwdriver to release terminal block clamp and secure wire in place. Gently pull on wire after installation to verify it is clamped tightly into terminal.



7.0 Power Requirements

Jacuzzi® spas are designed to provide optimum performance and flexibility of use when connected to their maximum electrical service. They are configured at the factory. The most common electrical connections are listed below:

- **All North American 60 Hz Models only:** These models come set for 50A logic. If you prefer, your qualified technician can perform a logic modification that allows the spas to operate on a different electrical service (see table footnotes below).

North American J-460/J-465/J-470/J-480 Models (60 Hz)

Voltage:	240 VAC	240 VAC	240 VAC
Max. Current Draw:	23A	36A	45A
Frequency:	60 Hz	60 Hz	60 Hz
Number of Wires:	3	3	3
Circuit Breaker (2-Pole):	30A*	50A**	60A***

* In 30A configuration, the heater **will not operate** while either jets pump is running.

** In 50A configuration, the heater **will not operate** while both jet pumps are running. ***This is the factory setting.***

*** In 60A configuration the heater **will operate** while both jet pumps are running.

- **All Export 50 Hz Models:** These models have two terminals requiring 2 circuit breakers and only have one logic option available.

Export J-460/J-465/J-470/J-480 Models (50 Hz)

	Main Terminal Breaker*	Heater Terminal Breaker**
Voltage:	230 VAC	230 VAC
Max. Current Draw:	16.6A	12A
Wattage	3.8 kW	2.6 kW
Frequency:	50 Hz	50 Hz
Number of Wires:	3	3

* The main terminal breaker is solely for the pumps, circulation pump, ozone, stereo option (if installed) and accessories.

** The heater breaker is solely for the heater, **to allow the heater to operate** while both jet pumps are running.

Note: Two breakers needed see Figure E page 15.

8.0 Spa Fill Up Procedure

For best results, read each step in its entirety before proceeding with this procedure.

1. Prepare The Spa For Filling

- Clear all debris from the spa. (Although the spa shell has been polished at the factory, you may want to treat it with a specially formulated spa cleaner.) Consult your authorized Jacuzzi dealer for additional information prior to filling spa.
- Remove both ProClear™ Plus skimmer, polishing filter lids and filters as illustrated in Section 14.1 (page 67).

2. Fill Spa

- Place the end of your garden hose into empty skimming filter bucket (filter bucket on your left) as you stand next to the spa. Fill spa half way, then place the garden hose into the opposite filter bucket (filter bucket on your right) while adding the remaining fill water.

CAUTION: TO DECREASE BUILD UP ON COMPONENTS AND MINIMIZE ACRYLIC DAMAGE.

Never fill with water from a water softener. If your water is extremely “hard”, it is preferable to fill half-way with hard water and the rest of the way with softened water. Water that is too soft can be corrosive to metal components.

-  **WARNING: TO DECREASE RISK OF INFECTION OR DISEASE.**

Fill hot tub with clean tap water from garden hose, to reduce risk of contracting a waterborne illness (e.g. an infection, bacteria or virus) and/or respiratory ailments. Fill until water covers all jets but does not touch the bottom of the lowest headrest (DO NOT OVERFILL!).

IMPORTANT: Always fill your spa through both filter buckets after draining. Failure to do so may cause air to be trapped in either pump, preventing the pump from circulating water. Remove the hose and replace both filter cartridges as illustrated in Section 14.1 (page 67).

3. Turn On Power

Turn on power to spa at the home's circuit breaker. The heater and filter/circulation pump will automatically activate. If the LCD display flashes the temperature icon and either “Water is below set-temp” or “Freeze protection” error, this is normal. Refer to page 74 for additional information.



4. Activate Jets Pumps

Turn on all jets(s) pumps when adding chemicals in step 5 (see Section 11.2, page 50 to activate jets).



5. Add Start-Up Chemicals

Add the spa water chemicals as recommended by your authorized Jacuzzi spa dealer. See Section titled "Water Quality Maintenance" (page 72) for general guidance.



WARNING: RISK OF POISONING OR DEATH.

Never leave chemicals opened and accessible to anyone. Use chemicals according to the vendors instructions. Always store chemicals in a safe and/or locked location. Keep away from and out of reach of children.

6. Establish A Stable Sanitizer Reading

Establish a stable sanitizer reading between 3.0-4.0 ppm chlorine or 2.0-4.0 ppm bromine. To ensure healthy water conditions, always maintain a constant sanitizer reading within the levels recommended by the Association of Pool and Spa Professionals/USA printed on the inside cover of this manual. If sanitizer levels cannot be stabilized, perform the Decontamination Procedures on the following page.

Note: The "Decontamination Procedure" should also be used after the spa has been "Winterized" (Sec. 14.8, page 70) or has been sitting without power for an extended period.

7. Set Spa To Heat

To warm spa water to a comfortable temperature, follow these steps:

- The LCD display on the control panel displays the actual temperature of the spa water. Press either the **UP** or **DOWN** button on the Navigational Quad Keypad to increase or decrease the water temperature by 1 degree.
- The heater will turn off 1 degree above set temperature and turn on 1 degree below set temperature.

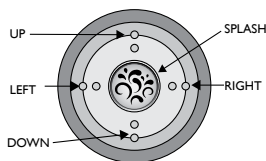

Important Heater Details:

- The maximum temperature for which the spa can be set is 104°F (40°C) and the minimum is 80°F (27°C).
- For North American spas: With a 50 amp service, turn off one of the jet pumps to operate heater. With a 30 amp service, turn off both jet pumps to operate heater. With a 60 amp service, the heater will operate with both jet pumps on.
- Setting the thermostat at maximum will not accelerate the heating process. This will only result in a higher ultimate temperature.
- The heater operates until the water reaches 1 degree above the programmed "set temperature", then turns off. The heater will reactivate after the water cools to approximately 1 degree below the "set temperature."

8. Place Cover On Spa

- Keeping the insulating cover in place anytime the spa is not in use will reduce the time required for heating, thereby minimizing operating costs.
- The time required for initial heat-up will vary depending on the starting water temperature.



DANGER: RISK OF PERSONAL INJURY.

Check water temperature carefully before entering hot tub! Excessive water temperature can cause burns, welts and body temperature to rise, hyperthermia (over-heating).

Decontamination Procedure

Steps 1-7 below are only required when sanitizer levels are unstable after performing Spa Fill Up Procedures steps 1-6. Disregard Decontamination Procedure below if sanitizer levels remain stable at 3.0-4.0 chlorine or 2.0-4.0 bromine ppm after performing Spa Fill Up Procedures steps 1-6.

1. Add 2.5 ounces of sodium dichlor for every 100 gallons of water. Refer to the table below for approximate water fill volume by model.



CAUTION: RISK OF PERSONAL INJURY OR SPA DAMAGE!

Never add chlorine tablets (trichlor) or acid to your hot tub for any reason! These chemical may damage components within your hot tub, burn or irritate your skin, create a rash, and void the manufacturer warranty for your spa.

Water Fill Volume by Model

Model	Average Fill Volume*	Sodium Dichlor
J-460.....	350 Gal (1,325 L)	9.0 oz
J-465.....	380 Gal (1,438 L)	9.5 oz
J-470.....	415 Gal (1,571 L)	10.5 oz
J-480.....	480 Gal (1,817 L)	12.0 oz

*Use average fill volume for chemical maintenance

2. Leave spa cover open during this step to allow excessive chemical vapors to exit spa, protecting pillows and plastic knobs from chemical attack. If spa is indoors, open doors and windows for proper ventilation. Turn on all spa jet pumps for one hour, open all air controls, and place all massage selector knob(s) in their center "combo" position as shown.

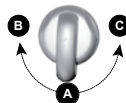

Note: You will need to activate the jet pumps every 20 minutes since these functions have an automatic 20 minute time-out that turns them off.

**WARNING: RISK OF PERSONAL INJURY!**

- To decrease the risk of injury, drowning or entrapment, never leave your hot tub unattended for any reason while the cover is open and accessible, especially to small children and animals!
- Precautions should be taken to minimize your exposure to chemical vapors (that could cause lung, brain, or skin damage).

3. Turn off power to the spa at the circuit breaker, then drain tub as outlined in Section 14.2 (page 68).
4. Refill spa with clean tap water from garden hose until water covers all jets but does not touch the bottom of the lowest headrest with all headrests in their lowest position (DO NOT OVERFILL!)

CAUTION: TO DECREASE BUILD UP ON COMPONENTS AND MINIMIZE ACRYLIC DAMAGE.

Never fill with water from a water softener. If your water is extremely “hard”, it is preferable to fill half-way with hard water and the rest of the way with softened water. Water that is too soft can be corrosive to metal components.

5. Consult your authorized Jacuzzi dealer for chemical recommendations, then add chemicals to spa water to achieve a constant sanitizer reading within the levels recommended by the Association of Pool and Spa Professionals/USA printed on the inside cover of this manual.
6. Turn on all jet pumps when adding chemicals to ensure proper mixing and leave your spa cover open until the sanitizer level falls below 4.0 ppm to protect pillows and plastic knobs from chemical attack.

**WARNING: RISK OF PERSONAL INJURY.**

- To decrease the risk of injury, entrapment or drowning, never leave your hot tub unattended for any reason while the cover is open and accessible to small children and animals!
- To decrease the possibility of contracting a waterborne illness (e.g. an infection, bacteria or virus) and/or respiratory ailments, maintain water chemistry within step 6 parameters. If you or other bathers experience such a condition, discontinue use and seek medical attention.

7. Establish a sanitizer reading between 3.0-4.0 ppm chlorine or 2.0-4.0 ppm bromine, then allow the spa to set undisturbed for 8 hours. Retest water after 8 hours to determine if sanitizer levels are stable. If sanitizer levels are stable, your spa is ready for use. To ensure healthy water conditions, always maintain a constant sanitizer reading within the levels recommended by the Association of Pool and Spa Professionals/USA printed on the inside cover of this manual. If sanitizer levels are not stable at this time, it will be necessary to repeat this procedure in its entirety until stable sanitizer readings are achieved.
8. After adequate sanitizer levels are achieved, close all spa air controls to maximize heat retention when spa is not in use.

9.0 Spa Features

9.1 J-480 Spa Features

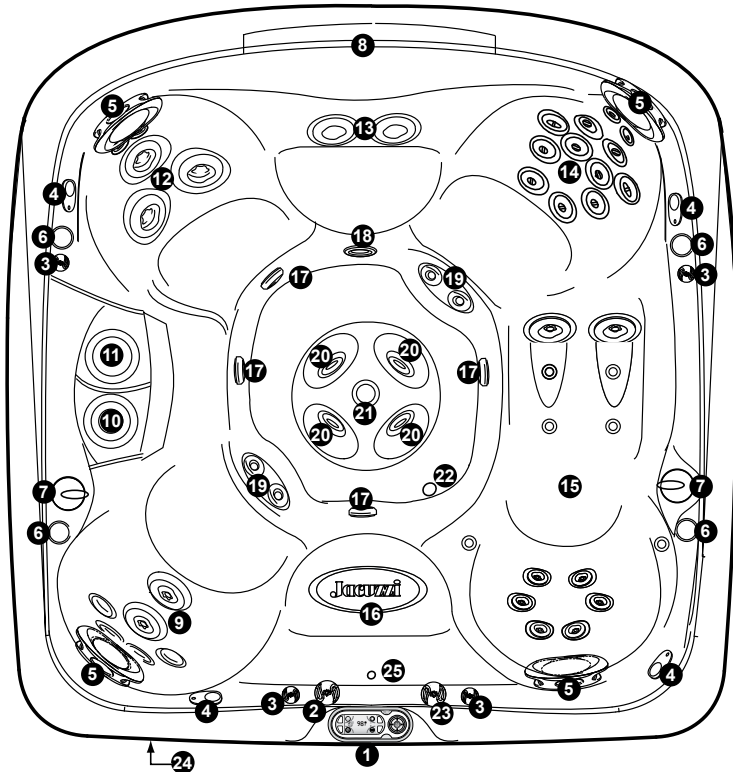

- | | |
|---|---|
| <ol style="list-style-type: none"> 1. J-1000™ Control Panel 2. Waterfall Control Valve 3. Air Control Valves (4 ea.) Introduce Air to Specified Jet Groups 4. Optional Audio System Speakers (4 ea.) 5. Adjustable Pillows (4 ea.) 6. Lighted Cup Holders (4 ea.) 7. Massage Selectors (2 ea.) Controls Specified Jet Groups 8. Waterfalls (2 ea.) 9. FX Jets (4 ea.) and FX2S Jets (2 ea.) 10. ProClear Plus Polishing Filter Bag and Filter 11. ProClear Floating Skimmer and Filter Cartridge with Integrated Chemical Dispenser 12. NX Jets (2 ea.) and MX2 Jets (3 ea.) 13. FX2S Jets (2 ea.) | <ol style="list-style-type: none"> 14. NX Jets (2 ea.) and FX Jets (10 ea.) 15. Lounge Jets:
RX Back Jets (6 ea.)
SX2 Jet for Wrists and Calves (6 ea.) 16. Lighted Seat Logo 17. Footwell Filter Suction Covers (4 ea.) 18. Waterfall Filtration Return 19. FX Calf Jets (4 ea.) 20. FX Footwell Jets (4 ea.) 21. Lighted IX Mass Aspiration Jet 22. Gravity Drain/Heater Input/Optional Ozone Return Fitting 23. Lighted Mass Aspiration Jet Flow Control Valve 24. Optional J-1000 JBL® Audio System 25. Optional Audio System IR Sensor |
|---|---|

9.2 J-480 Massage/Waterfall Selector Diagram

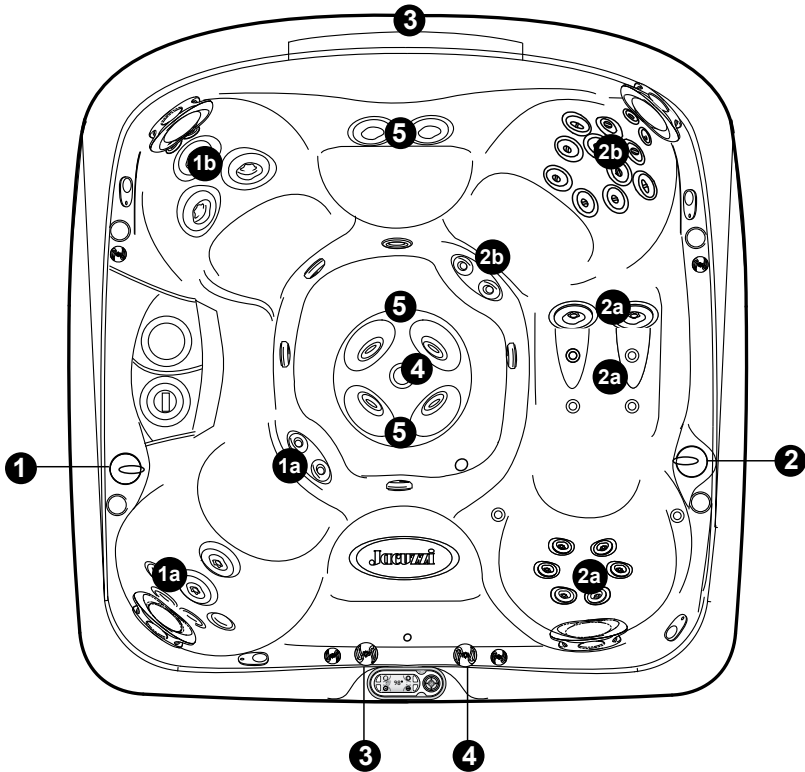

Massage Selectors (1-2)

- Massage selector 1 diverts output between jets groups 1a-1b.
- Massage selector 2 diverts output between jet groups 2a-2b.

Waterfall Selector (3)

- Waterfall selector 3 controls circulation pump output to waterfalls.

Mass Aspiration Jet Flow Control Valve (4)

- Valve 4 controls output to footwell IX Jet.

Jets Without Massage Selector Controls (5)

- Jets 5 are always on when jets pump is running.

9.3 J-480 Air Controls Diagram

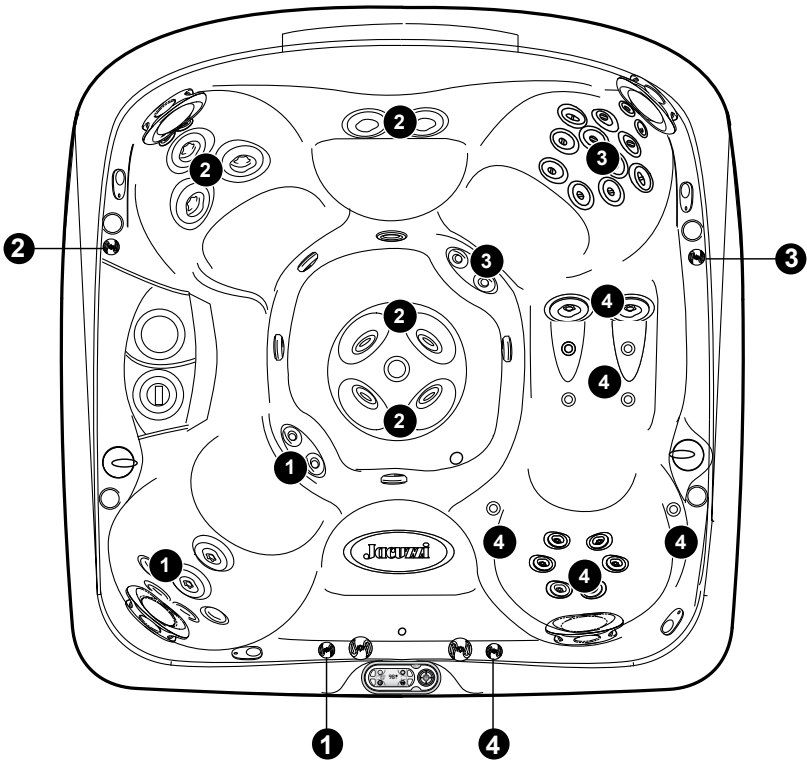
**Air Controls Operation**

- Rotate air controls 1-4 to add air to designated jet groups.
- Center footwell IX Jet draws air at all times when jets pump is running. This jet has no air control.

9.4 J-470 Spa Features

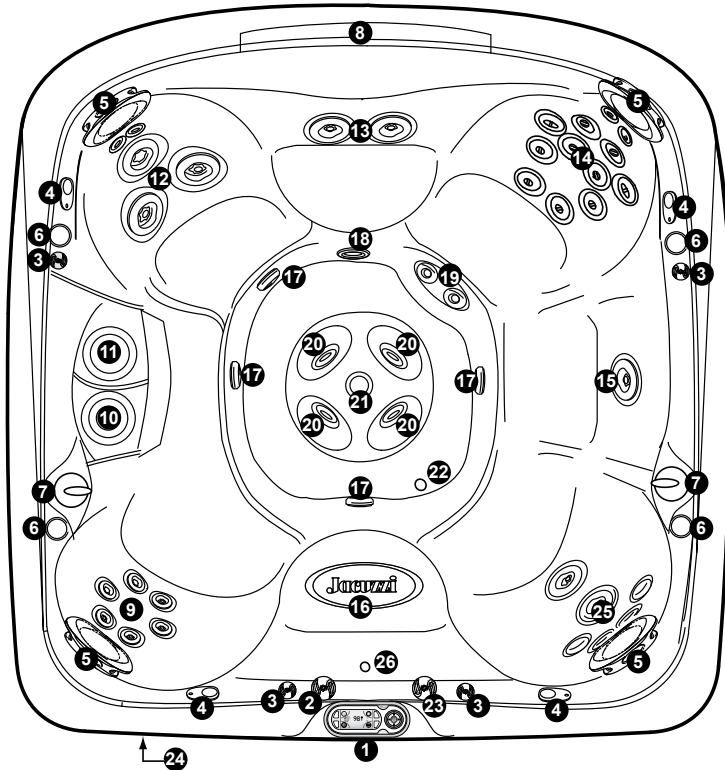

- | | |
|---|--|
| 1. J-1000 Control Panel | 14. NX Jets (2 ea.) and FX Jets (10 ea.) |
| 2. Waterfall Control Valve | 15. FX2S Jet |
| 3. Air Control Valves (4 ea.) Introduce Air to Specified Jet Groups | 16. Lighted Seat Logo |
| 4. Optional Audio System Speakers (4 ea.) | 17. Footwell Filter Suction Covers (4 ea.) |
| 5. Adjustable Pillows (4 ea.) | 18. Waterfall Filtration Return |
| 6. Lighted Cup Holders (4 ea.) | 19. FX Calf Jets (2 ea.) |
| 7. Massage Selectors (2 ea.) Controls Specified Jet Groups | 20. FX Footwell Jets (4 ea.) |
| 8. Waterfalls (2 ea.) | 21. Lighted IX Mass Aspiration Jet |
| 9. RX Jets (6 ea.) | 22. Gravity Drain/Heater Input/Optional Ozone Return Fitting |
| 10. ProClear Plus Polishing Filter Bag and Filter | 23. Lighted Mass Aspiration Jet Flow Control Valve |
| 11. ProClear Floating Skimmer and Filter Cartridge with Integrated Chemical Dispenser | 24. Optional J-1000 Audio System |
| 12. NX Jets (2 ea.) and MX2 Jets (3 ea.) | 25. FX Jets (4 ea.) and FX2S Jets (2 ea.) |
| 13. FX2S Jets (2 ea.) | 26. Optional Audio System IR Sensor |

9.5 J-470 Massage/Waterfall Selector Diagram

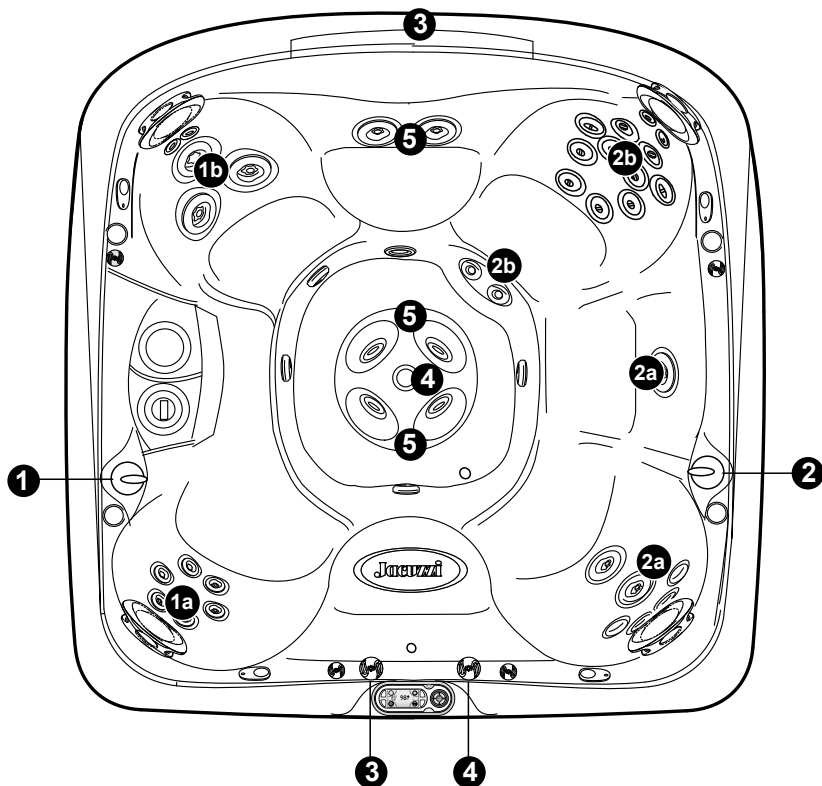
**Massage Selectors (1-2)**

- Massage selector 1 diverts output between jets groups 1a-1b.
- Massage selector 2 diverts output between jet groups 2a-2b.

Waterfall Selector (3)

- Waterfall selector 3 controls circulation pump output to waterfalls.

Mass Aspiration Jet Flow Control Valve (4)

- Valve 4 controls output to footwell IX Jet.

Jets Without Massage Selector Controls (5)

- Jets 5 are always on when jets pump is running.

9.6 J-470 Air Controls Diagram

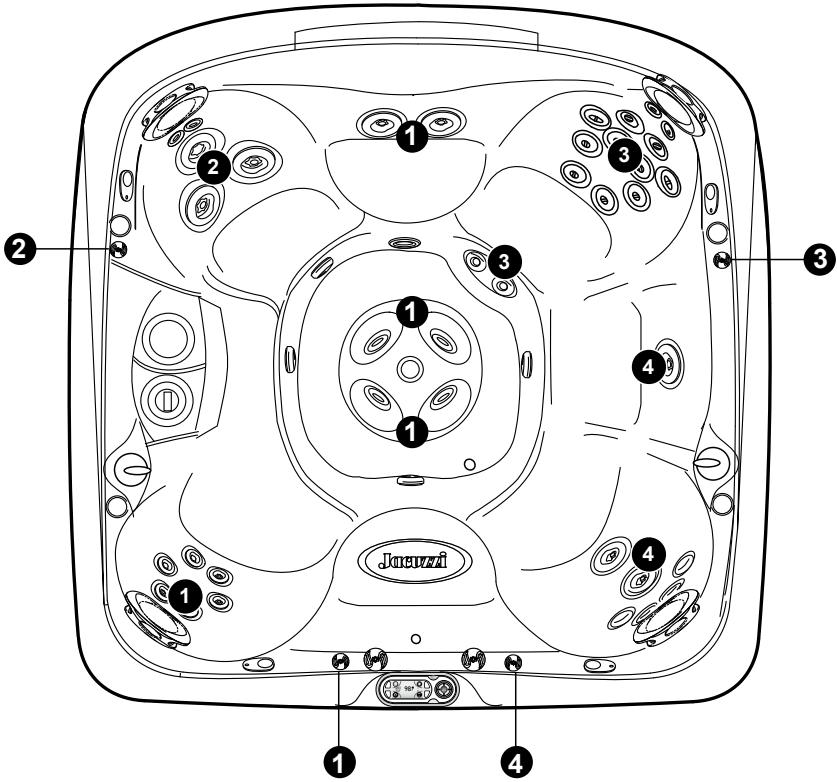

Air Controls Operation

- Rotate air controls 1-4 to add air to designated jet groups.
- Center footwell IX Jet draws air at all times when jets pump is running. This jet has no air control.

9.7 J-465 Spa Features

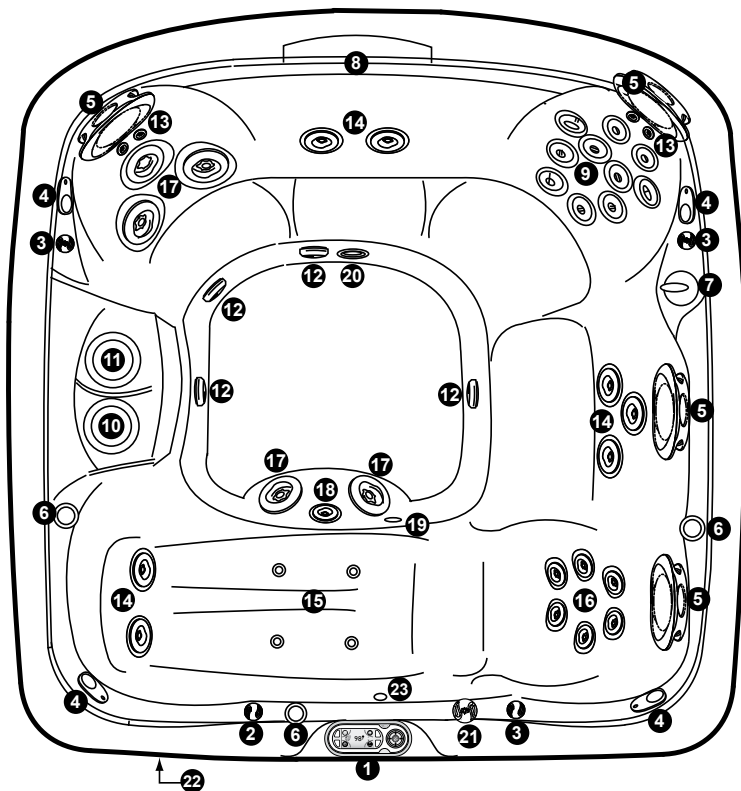

- | | |
|---|--|
| <ol style="list-style-type: none"> 1. J-1000 Control Panel 2. Waterfall Control Valve 3. Air Control Valves (3 ea.) Introduce Air to Specified Jet Groups 4. Optional Audio System Speakers (4 ea.) 5. Adjustable Pillows (4 ea.) 6. Lighted Cup Holders (3 ea.) 7. Massage Selectors (1 ea.) Controls Specified Jet Groups 8. Waterfall 9. FX Jets (10 ea.) 10. ProClear Plus Polishing Filter Bag and Filter 11. ProClear Floating Skimmer and Filter Cartridge with Integrated Chemical Dispenser | <ol style="list-style-type: none"> 12. Footwell Filter Suction Covers (4 ea.) 13. NX Jets (4 ea.) 14. FX2S Jets (7 ea.) 15. SX2 Jets (4 ea.) 16. RX Jets (6 ea.) 17. MX Jets (5 ea.) 18. Lighted IX Mass Aspiration Jet 19. Gravity Drain/Heater Input/Optional Ozone Return Fitting 20. Waterfall Filtration Return 21. Lighted Mass Aspiration Jet Flow Control Valve 22. J-1000 Optional Audio System 23. Optional Audio System IR Sensor |
|---|--|

9.8 J-465 Massage/Waterfall Selector Diagram

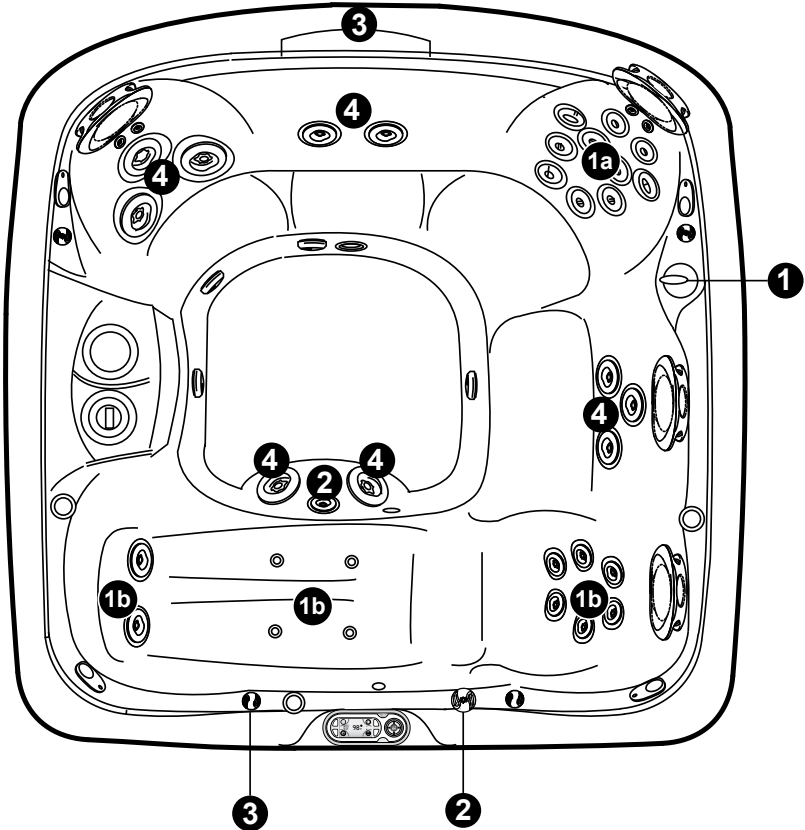

Massage Selectors (1)

- Massage selector 1 diverts output between jets groups 1a-1b.

Mass Aspiration Jet Flow Control Valve (2)

- Valve 2 controls output to footwell IX Jet.

Waterfall Selector (3)

- Waterfall selector 3 controls circulation pump output to waterfall.

Jets Without Massage Selector Controls (4)

- Jets 4 are always on when jets pump is running.

9.9 J-465 Air Controls Diagram

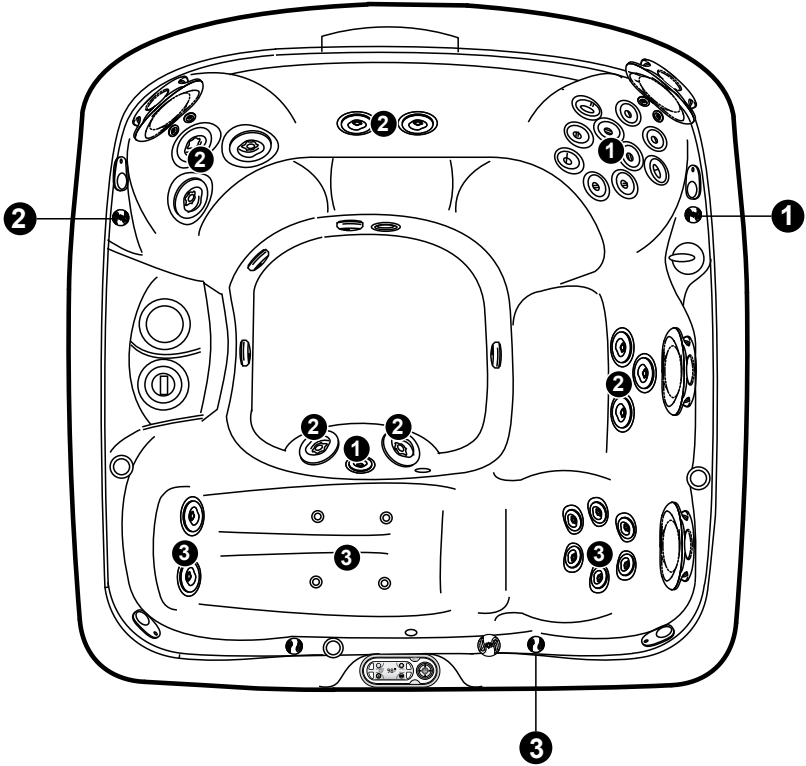

Air Controls Operation

- Rotate air controls 1-3 to add air to designated jet groups.
- Center footwell IX Jet draws air at all times when jets pump is running. This jet has no air control.

9.10 J-460 Spa Features

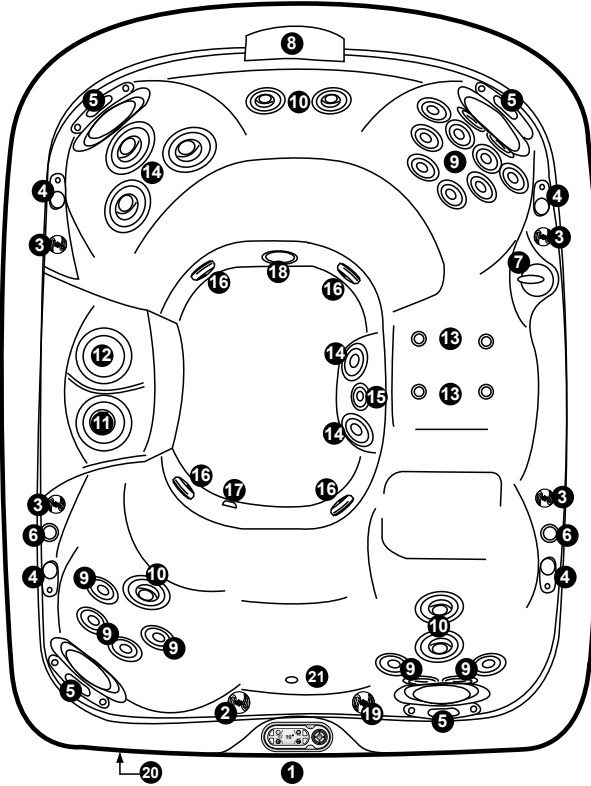

- | | |
|---|--|
| 1. J-1000 Control Panel | 12. ProClear Floating Skimmer and Filter Cartridge with Integrated Chemical Dispenser. |
| 2. Waterfall Control Valve | 13. SX2 Jets (4 ea.) |
| 3. Air Control Valves (4 ea.) Introduce Air to Specified Jet Groups | 14. MX2 Jets (5 ea.) |
| 4. Optional Audio System Speakers (4 ea.) | 15. Lighted IX Mass Aspiration Jet |
| 5. Adjustable Pillows (4 ea.) | 16. Footwell Filter Suction Covers (4 ea.) |
| 6. Lighted Cup Holders (2 ea.) | 17. Gravity Drain/Heater Input/Optional Ozone Return Fitting |
| 7. Massage Selector (1 ea.) Controls Specified Jet Groups | 18. Waterfall Filtration Return |
| 8. Waterfall | 19. Lighted Mass Aspiration Jet Flow Control Valve |
| 9. FX Jets (14 ea.) | 20. Optional J-1000 Audio System |
| 10. FX2S Jets (5 ea.) | 21. Optional Audio System IR Sensor |
| 11. ProClear Plus Polishing Filter Bag and Filter | |

9.11 J-460 Massage/Waterfall Selector Diagram

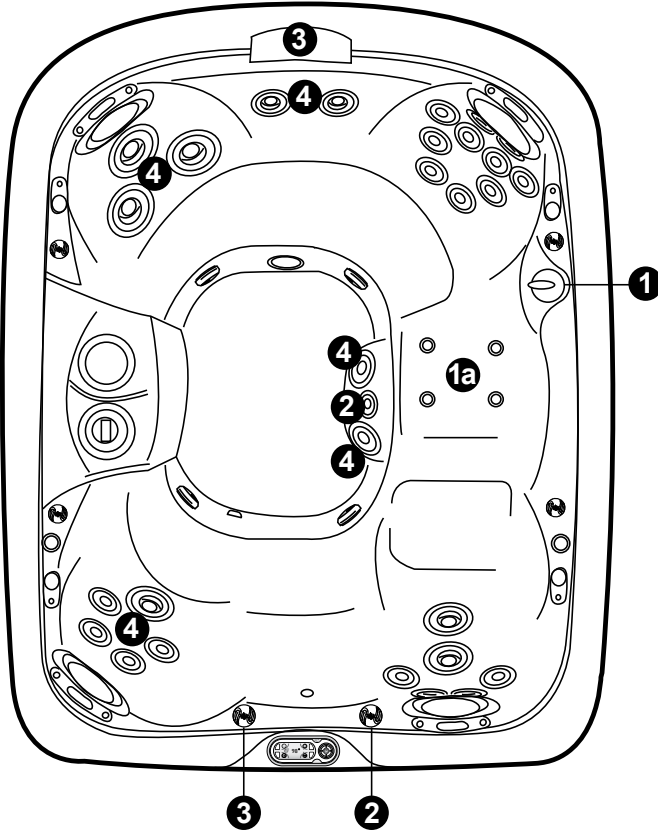

Massage Selector (1)

- Massage selector 1 diverts output between jets groups 1a-1b.

Mass Aspiration Jet Flow Control Valve (2)

- Valve 2 controls output to footwell IX Jet.

Waterfall Selector (3)

- Waterfall selector 3 controls circulation pump output to waterfall.

Jets Without Massage Selector Controls (4)

- Jets 4 are always on when jets is running.

9.12 J-460 Air Controls Diagram

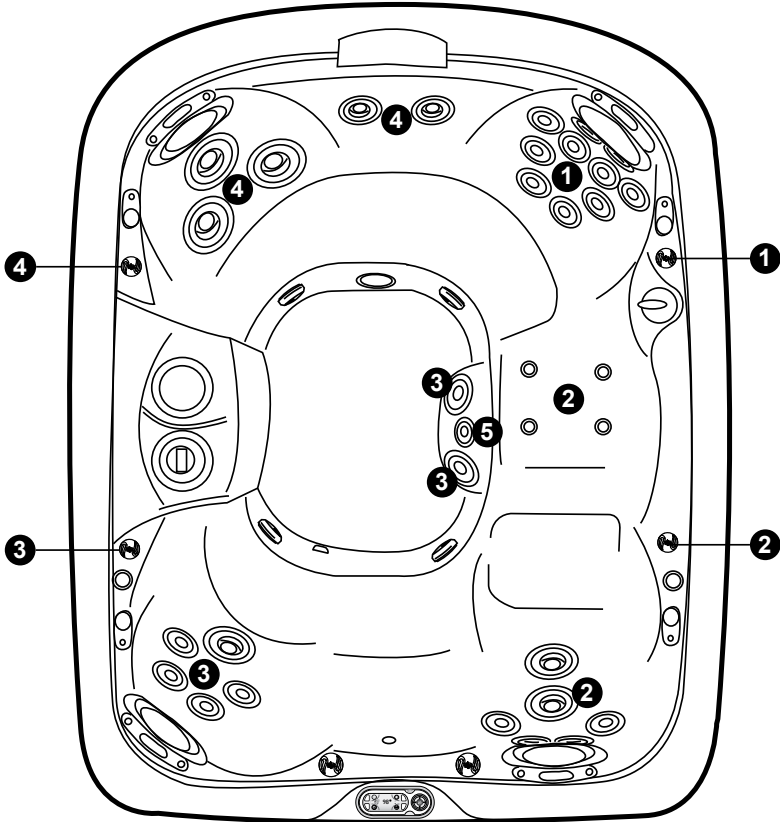
**Air Controls Operation**

- Rotate air controls 1-4 to add air to designated jet groups.
- Center footwell IX Jet (5) draws air at all times when jets pump is running. This jet has no air control.

10.0 Control Panel Main Menu

10.1 Control Panel

Your Jacuzzi Spa is equipped with a state-of-the-art control panel. You will be able to access sets of multi-level menus. Familiarize yourself with the following information, so you can gain the full benefits of your spa. By learning the key features of the control panel, you will navigate through the menus and programming with ease. You will be referred back to this page as you move on to proceeding sections. Please pay close attention to the key points below.

- Although the graphics on the LCD display are vivid and colorful, the screen is not a touch-screen. The screen does display menu icons on every corner. These menus are activated by the button located just to the side of them (buttons A-D).
- At times you will see up, down, left or right arrows surrounding key features that are selected or made by using the Navigational Quad Keypad (see below).
- In the center of the Quad Keypad is the “Splash” button. This button is mostly used to save, set, reset or enter your changes.
- Located to the left, about mid-screen, is an icon that lets you know what menu you are currently in.

Note: The Start up menu will time out after approximately 3 seconds and then change to the display in Section 10.2, page 35.

START UP MENU DIAGRAM

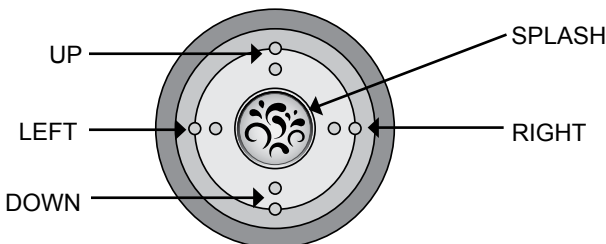
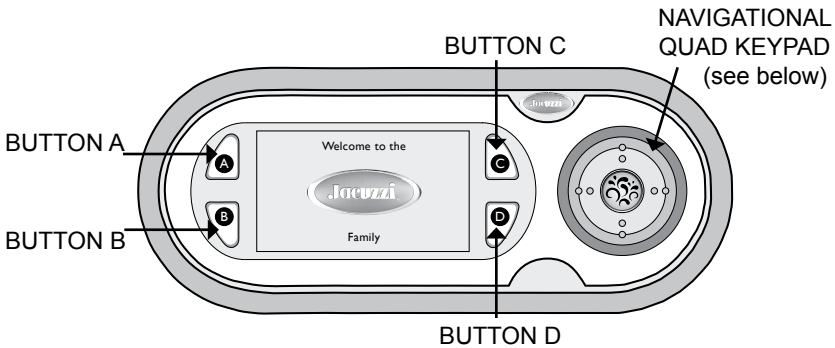

10.2 Main Menu Features

From the Main Menu you can access the main component menus to operate your Jacuzzi Spa. Listed below is a list of the Main Menu icons.

A. Menu Control Buttons



 **Temp.** = **Temperature control:** Indicates that by using the Quad Keypad you can:

- Increase the temperature by pressing the Up button.
- Decrease the temperature by pressing the Down button.
- To display the temperature in °F, press the Right button.
- To display the temperature in °C, press the Left button.

Note: The temperature range for the spa is 80 to 104°F (27 to 40°C). To activate the Extended Temperature feature, that allows the spa to reach 106°F (41°C), refer to page 76.

 = **Heating icon:** Indicates that the heater is on and heating the water. If icon is blinking, refer to page 76.

 = **Temperature indicator:** The thermometer icon will either rise or fall depending on the actual water temperature.



below
79°F



80°-88°F



89°-98°F



99°-104°F







105°F
higher

A = **Button A:** Press this button to access the corresponding menu located to the right side of it.

B = **Button B:** Press this button to access the corresponding menu located to the right side of it.

C = **Button C:** Press this button to access the corresponding menu located to the left side of it.

-  = **Button D:** Press this button to access the corresponding menu located to the left side of it.
-  = **Entertainment Menu Icon:** Press button A to access the menu to operate the J-1000 Audio System powered by JBL (page 38).
-  = **Jets Menu icon:** Press button B to access the menu to operate the jets pump (page 50).
-  = **Lights Menu Icon:** Press button C to access the menu to operate the lights and lighting effects (page 51).
-  = **Settings Menu Icon:** Press button D to access the menu to program and operate a majority of the key functions of the spa (for example setting the language, date, time etc., page 55).

B. Menu Indicators

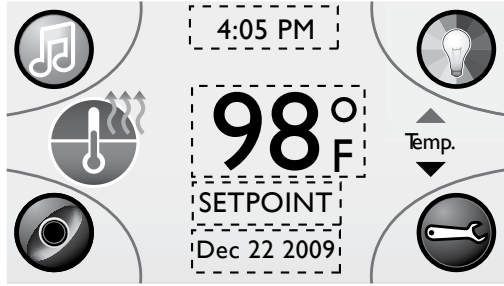

4:05 PM
1605 = **Time indicator:** The time will always be shown when the Main Menu is displayed. The appearance will vary depending on whether the clock is set to a 12-hour or 24-hour configuration.

Note: The spa does not adjust for daylight saving time, so the time must be manually adjusted. The AM or PM indicators will only appear with the 12-hour configuration.



98°F
37.6°C = **Temperature:** Displays the actual water temperature in either °F or °C.

SETPOINT = **Temperature setpoint:** Displays the temperature that the spa has been set to. Press the Up or Down button on the Quad Keypad once to view setpoint. The word “setpoint” will only appear when manually setting the temperature.

Dec 22 2009 = **Date:** The date will always be shown when the Main Menu is displayed.

10.3 Menu Flowchart

The flowchart below is included to help you understand the spa's navigational screens. By pressing the buttons located next to each corner icon, you will enter additional menus and submenus. Each menu is covered in detail in the sections to follow.

Note: If your spa is not equipped with an audio system. The Entertainment Menu and menu icon () will not appear and be replaced with a Lock icon ().

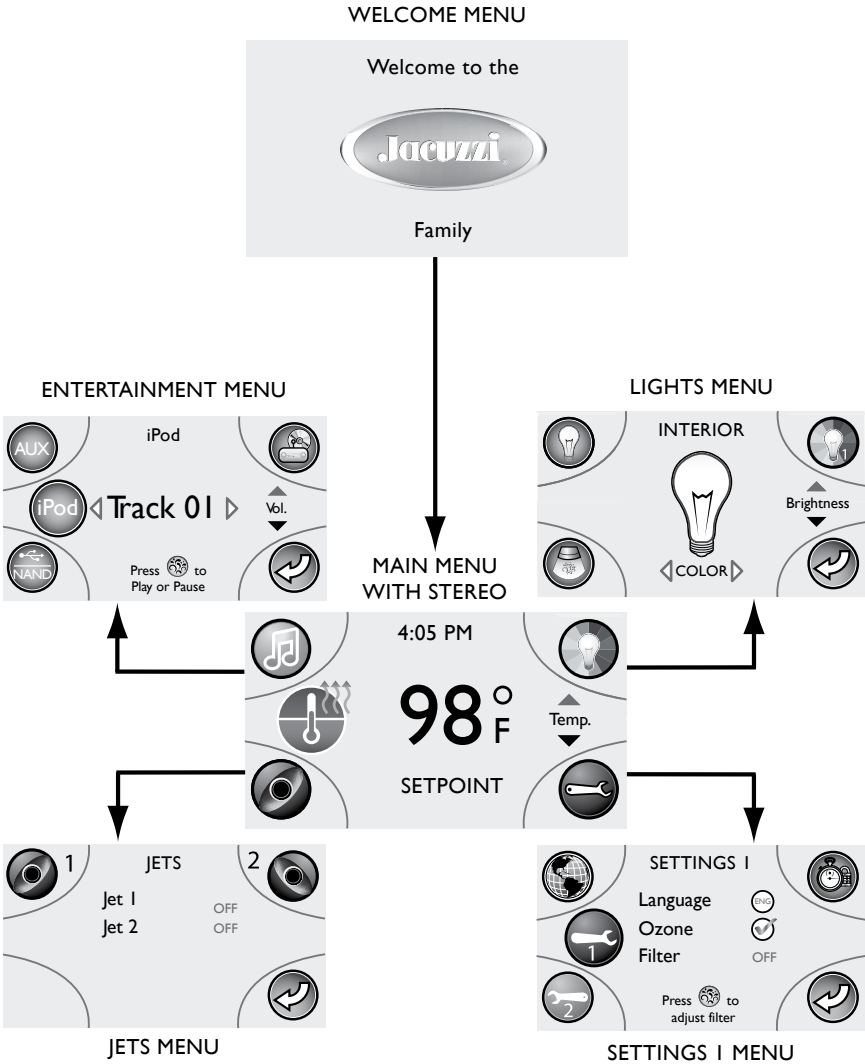

10.4 Entertainment Menu Display

Jacuzzi models equipped with the optional J-1000 Audio System powered by JBL, offer an enhanced spa experience. These models include an integrated AM/FM/CD/MP3 Player receiver, four high fidelity spa engineered speakers for unsurpassed sound quality and long-life, and an integrated subwoofer for an enhanced acoustical experience. A wireless remote control is included to further enhance your experience by providing full sound, lighting and jets control at your fingertips.

Note: When you first enter the Entertainment menu, the screen defaults to the last device used.



= **iPod®/AUX icon:** Press button A to access the iPod/AUX (Auxiliary) submenu when you first enter the Entertainment Menu (page 40).



= **iPod icon:** Indicates that an iPod device is in use (page 40).



= **Auxiliary icon:** Indicates that an Auxiliary device is in use (page 41).



= **USB/NAND Menu icon:** Press button B to access the USB/NAND (Universal Serial Bus/Internal Memory) device submenu (page 42).

Note: When you enter the submenu, the system will default to the last device that was used.



= **USB icon:** Indicates that an USB device is in use. You can access the drive's folders and tracks (page 42).



= **NAND icon:** Indicates that the NAND is in use (page 44).



= **Radio/CD Menu icon:** Press button C to access the radio or CD device submenus (page 45).

Note: When you enter the submenu, the system will default to the last device that was used. If the Radio was used, it will also default to the last broadcast band used (AM/FM).



= **Radio icon:** Allows access to the FM presets, FM tune, AM presets, and AM tune modes (page 45).



= **CD icon:** Indicates that a CD is currently playing (page 49).



= **Previous icon:** Press button D to return to the Previous menu.



= **Splash button:** This is a multi-task button, depending on the menus and action required. The Splash button can select, save, set, pause or play, preset submenus, and turn off the system.

10.5 iPod®/AUX Submenu

While in the Entertainment menu, press button A to access the for iPod/AUX submenu. You can scroll through the tracks, control the volume, and pause/play the device, for the iPod device only.



WARNING: RISK OF ELECTRICAL SHOCK HAZARD EXISTS AND EQUIPMENT DAMAGE! Never install or remove iPod while hands are wet or while sitting partially immersed or fully immersed in spa!



◀ "Displays Audio Information" ▶

Audio information: Displays the track number, artist, song, and time elapsed (if available). The arrows on either side indicate that the Quad Keypad can be used to scroll through the tracks.

- Press the Left button to move back to the previous track.
- Press the Right button to move forward to the next track.



Vol. = Volume control: Allows you to control the volume level. The arrows on the top and bottom of the volume indicate that the Quad Keypad can be used to lower or raise the volume.

- Press the Up button to increase the volume.
- Press the Down button to decrease the volume.



Splash button: Allows you to pause/play the music or turn off the audio system.

- Press the Splash button to pause when playing.
- Press the Splash button again to reactivate.
- Press and hold for longer than 3 seconds and the audio system will turn off. The screen will return to the Main Menu.



Button A: Press this button to access the AUX submenu.



Button B: Press this button to access the USB/NAND submenus (page 42). DRM (Digital rights management) files cannot be played. Personal files (MP3, WMA, iTunes or AAC) can be played as long as they are not DRM encrypted files.

Note: The USB/NAND submenu will always default to the last device used.

- C** = **Button C:** Press this button to access the Radio/CD submenus (page 45).

Note: The Radio/CD submenu will always default to the last device used. If the radio was used, it will also default to the last broadcast band used (AM/FM).

- D** = **Button D:** Press this button to return to the Main Menu (page 35).

10.6 AUX Submenu

The Auxiliary submenu lets you connect to any MP3 device (other than an iPod). When this submenu is active it provides a volume control function, all other functions are controlled through the connected device.



WARNING: RISK OF ELECTRICAL SHOCK HAZARD EXISTS AND EQUIPMENT DAMAGE! Never install or remove MP3 Player while hands are wet or while sitting partially immersed or fully immersed in spa!

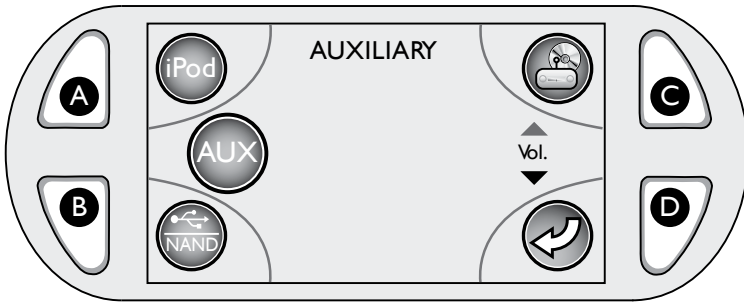

- Vol.** = **Volume control:** Allows you to control the volume level. The arrows on the top and bottom of the volume indicate that the Quad Keypad can be used to lower or raise the volume. When pressing the Up or Down button the "Vol" icon is replaced by the volume level number.
- Press the Up button to increase the volume.
 - Press the Down button to decrease the volume.



- = **Splash button:** Press and hold for longer than 3 seconds and the Audio System will turn off. The screen will return to the Main Menu.

- A** = **Button A:** Press this button to access the iPod submenu (page 40).

- B** = **Button B:** Press this button to access the USB/NAND submenu (page 42).

C = **Button C:** Press this button to access the Radio/CD submenus (page 45).

Note: The Radio/CD submenu will always default to the last device used. If Radio was used, it will also default to the last broadcast band used (AM/FM).

D = **Button D:** Press this button to return to the Main Menu (page 35).

10.7 USB Submenu

When you press button B (while still in the Entertainment Menu) you can access the USB/NAND submenu. The USB/NAND submenu lets you connect to a USB device or the internal memory. You can control the folder selection, track selection, volume, and pause/play of the device.

Note: The USB/NAND submenu will always default to the last device used.

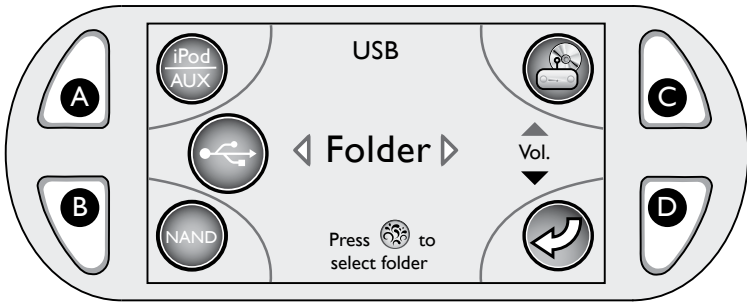

- ◀ FOLDER ▶ = **Folder icon:** Allows you to select the folder from the USB drive. The arrows on either side indicate that the Quad Keypad can be used to scroll through the folders.
- Press the Left button to move to the previous folder.
 - Press the Right button to move to the next folder.
 - Once the folder is located that you would like to listen to, press the Splash button to select it. The LCD display will change to the track information (Figure A).



WARNING: RISK OF ELECTRICAL SHOCK HAZARD EXISTS AND EQUIPMENT DAMAGE! Never install or remove USB device while hands are wet or while sitting partially immersed or fully immersed in spa!

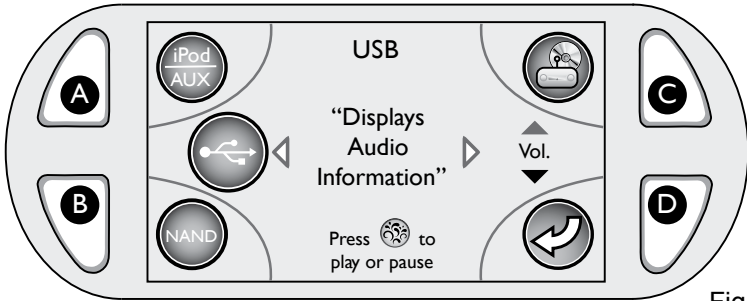

Figure A

◀ "Displays Audio Information" ▶

Audio information: Displays the track number, artist, song, and time elapsed (if available). The arrows on either side indicate that the Quad Keypad can be used to scroll through the tracks.

- Press the Left button to move to the previous track.
- Press the Right button to move to the next track.

▲
Vol.
▼

Volume control: Allows you to control the volume level. The arrows on the top and bottom of the volume indicate that the Quad Keypad can be used to lower or raise the volume.

- Press the Up button to increase the volume.
- Press the Down button to decrease the volume.



Splash button: Allows you to pause or play the music.

- Press the Splash button to pause when playing.
- Press the Splash button again to reactivate.
- Press and hold for longer than 3 seconds and the audio system will turn off. The screen will return to the Main Menu.

A

Button A: Press this button to access the iPod/AUX submenu (page 40).

B

Button B: Press this button to access the NAND submenu (page 44).

C

Button C: Press this button to access the Radio/CD submenus (page 45).

Note: The Radio/CD submenu will always default to the last device used. If Radio was used, it will also default to the last broadcast band used (AM/FM).

D

Button D: Press this button to return to the Main Menu (page 35).

10.8 NAND Submenu

The NAND (internal memory) submenu lets you access files copied onto the hardware (Section 19.5, page 86). You can control the folder selection, track selection, volume, and pause/play of the device.

Note: The USB/NAND submenu will always default to the last device used.

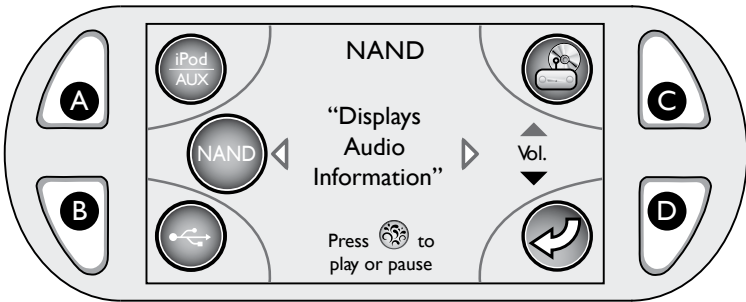

- = **Volume control:** Allows you to control the volume level. The arrows on the top and bottom of the volume indicate that the Quad Keypad can be used to lower or raise the volume.
 - Press the Up button to increase the volume.
 - Press the Down button to decrease the volume.



- = **Splash button:** Press and hold for longer than 3 seconds and the Audio System will turn off. The screen will return to the Main Menu.



- = **Button A:** Press this button to access the iPod/AUX submenu (page 40).



- = **Button B:** Press this button to access the USB submenu (page 42).



- = **Button C:** Press this button to access the Radio/CD submenus (page 45).

Note: The Radio/CD submenu will always default to the last device used. If radio was used, it will also default to the last broadcast band used (AM/FM).



- = **Button D:** Press this button to return to the Main Menu (page 35).

10.9 FM Radio Submenu

The FM radio submenu gives you access to your preset stations and local FM radio stations.

A. Listening to Preset stations

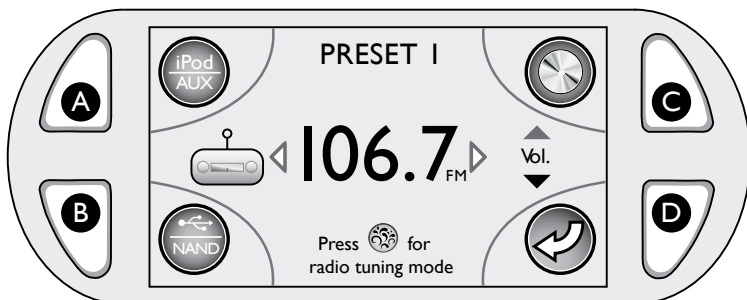

- ◀|106.7|▶ = **Preset number:** Indicates which preset station is currently playing. The arrows on the either side of the station number indicate that the Quad Keypad can be used to scroll through the preset stations 1-6.
- Press the Left button to move back through preset stations.
 - Press the Right button to move forward through preset stations.

- ▲
Vol.
▼ = **Volume control:** Allows you to control the volume level. The arrows on the top and bottom of the volume indicate that the Quad Keypad can be used to lower or raise the volume.
- Press the Up button to increase the volume.
 - Press the Down button to decrease the volume.

-  = **Splash button:** Allows you to:
- Press to access the FM tuning menu and scan through the local radio stations.
 - Press and hold for longer than 3 seconds and the audio system will turn off. The screen will return to the Main Menu.

- A** = **Button A:** Press this button to access the iPod/AUX submenu (page 40).

- B** = **Button B:** Press this button to access the USB/NAND submenu (page 42).

Note: The USB/NAND submenu will always default to the last device used.

- C** = **Button C:** Press this button to access the CD submenu (page 49).

- D** = **Button D:** Press this button to return to the Main Menu (page 35).

B. Listening to local FM radio stations

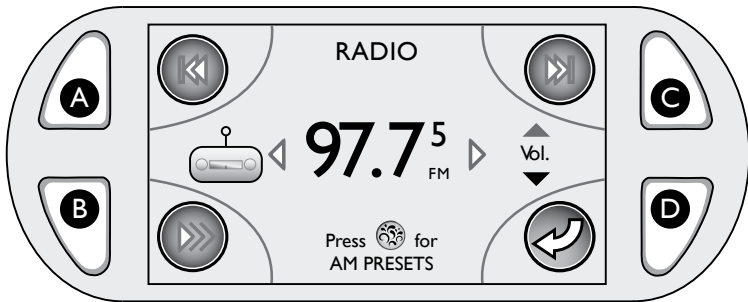

◁ **97.7⁵_{FM}** ▷ = **Station number:** Indicates the station that is currently playing. The arrows on the either side of the station number indicate that the Quad Keypad can be used to scroll through the local stations.

- Press the Left button to move slowly back through stations.
- Press the Right button to move slowly forward through stations.

Note: The superscripted number above the station is used for Export models only.

▲
Vol.
▼ = **Volume control:** Allows you to control the volume level. The arrows on the top and bottom of the volume indicate that the Quad Keypad can be used to lower or raise the volume.

- Press the Up button to increase the volume.
- Press the Down button to decrease the volume.

 = **Splash button:** Allows you to:

- Press to go to the AM Preset submenu.
- Press and hold for longer than 3 seconds and the audio system will turn off. The screen will return to the Main Menu.

A = **Button A:** Press this button to Seek back through stations and stop at the station with the strongest signal.

B = **Button B:** Press this button to start an intro scan. The radio will scan and stop at stations with the strongest signal for about 5 seconds, then continue scanning until button B is pressed again to stop the scan.

C = **Button C:** Press this button to Seek forward through stations and stop at the station with the strongest signal.

D = **Button D:** Press this button to return to the Main Menu.

10.10 AM Radio Submenu

The AM radio submenu gives you access to your preset stations and local AM radio stations.

A. Listening to Preset stations

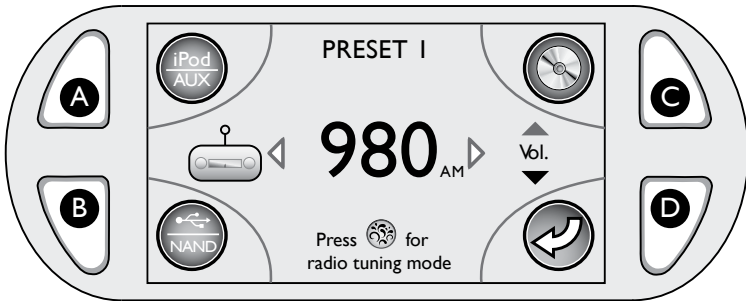

- ◀ 980 AM ▶ = **Preset number:** Indicates which preset station is currently playing. The arrows on the either side of the station number indicate that the Quad Keypad can be used to scroll through the preset stations 1-6.
- Press the Left button to move back through preset stations.
 - Press the Right button to move forward through preset stations.

- ▲
Vol.
▼ = **Volume control:** Allows you to control the volume level. The arrows on the top and bottom of the volume indicate that the Quad Keypad can be used to lower or raise the volume.
- Press the Up button to increase volume.
 - Press the Down button to decrease volume.

- ⦿ = **Splash button:** Allows you to:
- Press to access the AM tuning menu to scan through the local AM radio stations.
 - Press and hold for longer than 3 seconds and the Audio System will turn off. The screen will return to the Main Menu.

- Ⓐ = **Button A:** Press this button to access the iPod/AUX submenu.

- Ⓑ = **Button B:** Press this button to access the USB/NAND submenu.

Note: The USB/NAND submenu will always default to the last device used.

- Ⓒ = **Button C:** Press this button to access the CD submenu.

- Ⓓ = **Button D:** Press this button to return to the Main Menu.

B. Listening to local AM radio stations

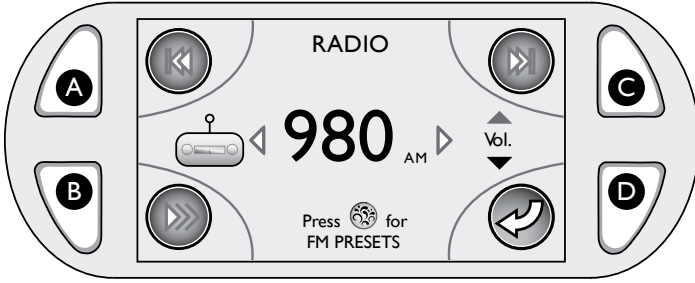

◁ **980** _{AM} ▷ = **Station number:** Indicates the station that is currently playing. The arrows on the either side of the station number indicate that the Quad Keypad can be used to scroll through the local stations.

- Press the Left button to move slowly back through stations.
- Press the Right button to move slowly forward through stations.



= **Volume control:** Allows you to control the volume level. The arrows on the top and bottom of the volume indicate that the Quad Keypad can be used to lower or raise the volume.

- Press the Up button to increase the volume.
- Press the Down button to decrease the volume.



= **Splash button:** Allows you to:

- Press to go to the FM Preset submenu.
- Press and hold for longer than 3 seconds and the Audio System will turn off. The screen will return to the Main Menu.



= **Button A:** Press this button to Seek back through stations and stop at the station with the strongest signal.



= **Button B:** Press this button to start an intro scan. The radio will scan and stop at stations with the strongest signal for about 5 seconds, then continue scanning until button B is pressed again to stop the scan.



= **Button C:** Press this button to Seek forward through stations and stop at the station with the strongest signal.



= **Button D:** Press this button to return to the Main Menu.

10.11 CD Submenu

The CD submenu gives you access select a track, adjust the volume level and pause or play.

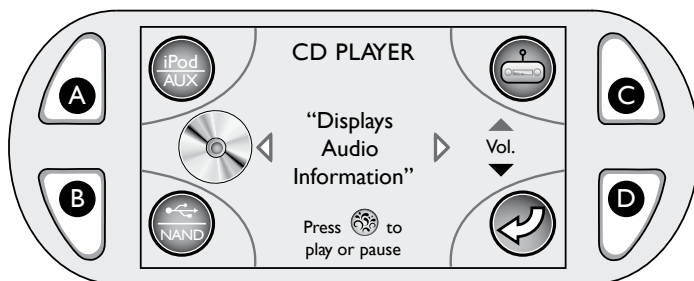

◀ "Displays Audio Information" ▶

Audio Information: Displays the track number, artist, song, and time elapsed (if available). The arrows on either side indicate that the Quad Keypad can be used to scroll through the tracks.

- Press the Left button to move to the previous track.
- Press the Right button to move to the next track.

▲
Vol.
▼

Volume control: Allows you to control the volume level. The arrows on the top and bottom of the volume indicate that the Quad Keypad can be used to lower or raise the volume.

- Press the Up button to increase the volume.
- Press the Down button to decrease the volume.



Splash button: Allows you to pause or play the music:

- Press the Splash button to pause the music.
- Press the Splash button again to reactivate.
- Press and hold for longer than 3 seconds and the audio system will turn off. The screen will return to the Main Menu.

A

Button A: Press this button to access the iPod/AUX submenu.

B

Button B: Press this button to access the USB/NAND submenu.

Note: The USB/NAND submenu will always default to the last device used.

C

Button C: Press this button to access the Radio submenus.

Note: The Radio submenu will always default to the last broadcast band (AM/FM) used.

D

Button D: Press this button to return to the Main Menu.

11.0 Operating Instructions

11.1 J-1000™ Control Panel

Your Jacuzzi spa is equipped with a J-1000™ control panel, massage selectors, and air control knobs located on the top rim of the spa (pages 22-33). These controls let you operate many of the special functions of your Jacuzzi spa. When you press button B from the Main Menu, you will enter the Jets pump submenu (Figure A).

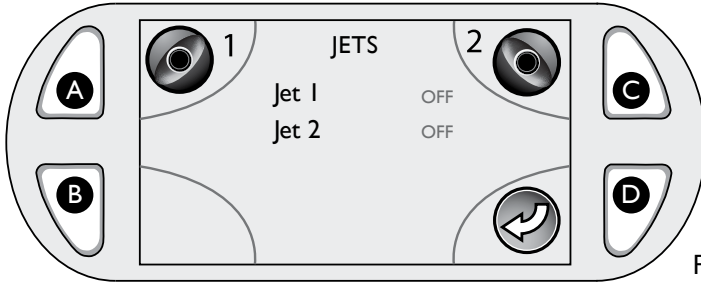



Figure A

 ¹ = Jets Pump 1 icon

 ² = Jets Pump 2 icon

 = **Button A:** Turns Jets pump 1 on and off.

 = **Button C:** Turns Jets pump 2 on and off.

 = **Button D:** Press this button to return to the Main Menu.

11.2 Activate Jets Pump

From the Main Menu (page 35), press button B to enter the Jets Pump Submenu. The LCD screen will display the Jets Pump Submenu (Figure A). From this menu you can control both pumps in the following sequence:

1. Press button A to activate pump #1.
2. Press again to turn pump #1 off.
3. Press button C to activate pump #2.
4. Press again to turn pump #2 off.



JETS ICON
WHEN OFF



JETS ICON
WHEN ON

The pumps will move from an “OFF” state into an ON () state.

Auto Turn Off— Anytime a pump has been manually turned on, it will automatically turn off after approximately 20 minutes. If at this time you desire more jet operation you may simply turn the pump(s) back on.

11.3 Activate Lights

From the Main Menu (page 35), press button C to enter the Lights submenus. The LCD screen will display the Lighting icons (Figure B). From this menu you can control the interior lighting (waterfall, footwell, IX logo, pillows and cup holder lights). The spa is equipped with two light modes; 1) Solid Color or 2) Light Rotation mode for interior lighting.

Note: The interior lights automatically turn off after 2 hours. They can be reactivated if needed.

Figure B

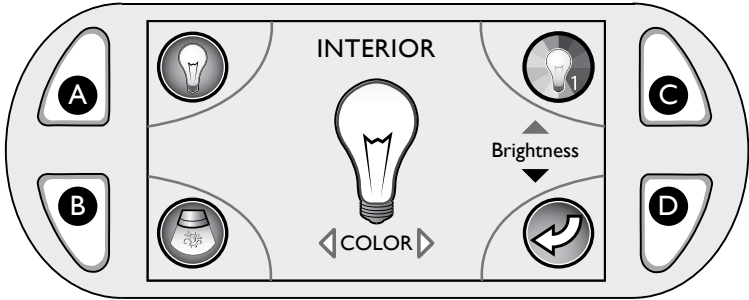

= **Interior Lights icon**



= **Interior Light Rotation icon**



= **Exterior Lights icon** (feature is not available)



= **Exterior Light Rotation icon** (feature is not available)



= **Button A:** Press this button to access the interior lights menu.



= **Button B:** (feature is not available).



= **Button C:** Press this button to access the interior light rotation menu.



= **Button D:** Press this button to return to the Main Menu.



= **Color selection:** Allows you to choose or scroll through the colors by using the Quad Keypad (page 34).



= **Brightness:** Allows you to control the intensity of the light by using the Quad Keypad.



= **Light Rotation selection:** Allows you to control the speed of the light rotation for interior by using the Quad Keypad.

A. To Access the Interior Solid Color Mode:

1. Press button A to activate the solid color mode.

Note: The default color and intensity will always be the last color and intensity used.

2. Press again to turn off.

3. Press either the Left or Right button of the Quad Keypad to scroll through or select one of the 7 different colors (Figure C).

- Press the Left button to move forward in the color sequence. (Blue-Cyan-Green-Yellow-Orange-Red-Purple-Blue).
- Press the Right button to move backwards in the color sequence. (Blue-Purple-Red-Orange-Yellow-Green-Cyan-Blue).

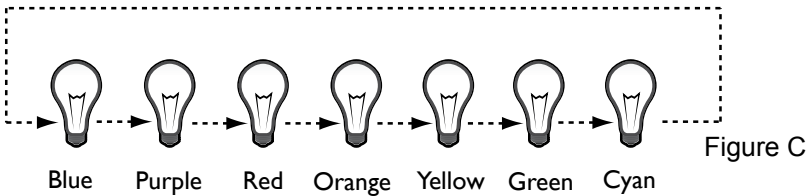

4. The intensity of the lights can be controlled in both the solid color or light rotation modes by using the Quad Keypad (Figure D).

- Press the Up button to increase the intensity in 25% increments.
- Press the Down button to decrease the intensity in 25% increments.

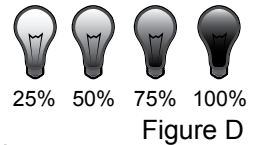

Note: The intensity range is from 25% to 100%, in increments of 25%. As the intensity is increased/decreased the bulb will darken/lighten to reflect the effect. Intensity defaults to the last setting used.

B. To access the Interior Light Rotation Mode

The lighting performance can be user enhanced by controlling the intensity and frequency effects as follows:

1. Press button C to enter the Light Rotation Mode (Figure E).

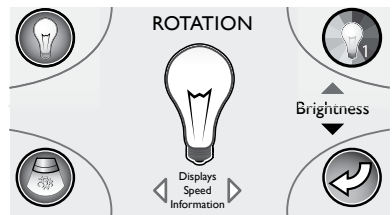

2. To control the speed of the light rotation use the Quad Keypad by pressing the Right button to increase the speed of the light rotation speed from 1, 2, 3, 4, 5 or 6 (60, 33, 18, 10, 5 or 3 seconds, respectively) or press the Left button to decrease the speed of the light rotation from 6, 5, 4, 3, 2 or 1 (3, 5, 10, 18, 33 or 60 seconds, respectively). On the LCD display you will see a number from 1-6 to indicate the speed selection (Figure F).

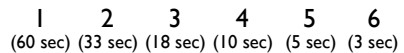

3. To increase or decrease light intensity, use the Quad Keypad as follows:
 - Press the Up button to increase the intensity in 25% increments.
 - Press the Down button to decrease the intensity in 25% increments.

Note: The intensity range is from 25% to 100%, in increments of 25%. As the intensity is increased the bulb will darken to reflect the effect (Figure D, page 52). Intensity defaults to the last setting used.
4. Press button A to deactivate light rotation mode and select a solid color (the last color and intensity used).
5. Press button B go to exterior lights - Feature is not available.
6. Press button C to turn off the interior lights.
7. Press button D to return to Main Menu.

11.4 Optional Exterior Lighting

Exterior lighting is not available (Figure G).

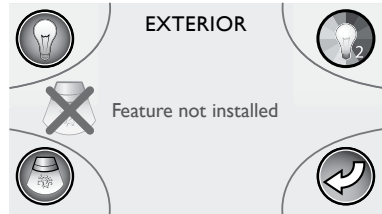

Figure G

11.5 Adjusting Individual Jet Flow

The water flow to certain jets in your spa can be increased or decreased by rotating the outside jet face.

Note: Always keep at least 6 adjustable jets open at all times.



11.6 Adjusting PowerPro™ MX2 Jets

Tilt PowerPro MX2 Jet nozzle to angle of choice as desired. Rotate nozzle clockwise to reduce flow volume from jet or rotate counterclockwise to increase flow volume.

Note: Always keep at least 6 adjustable jets open at all times.



11.7 Adjusting RX Jets

Turn center jet adjustment knob clockwise to decrease or shut off water flow. Turn center jet adjustment knob counterclockwise to turn on or increase water flow.

Note: Always keep at least 6 adjustable jets open at all times.



11.8 WaterColour™ Waterfall Control

Turn waterfall control valve (pages 22-32) counterclockwise to increase waterfall output. Turn control valve clockwise to decrease or turn off waterfalls.



11.9 Air Controls

Certain jet systems have their own air control. Each control introduces air into the water lines that supply that specific jet group (pages 22-32). Simply rotate any air control clockwise to open or rotate counterclockwise to close. To minimize heat loss, all air controls should be closed when the spa is not in use.



11.10 Selecting the Desired Massage Action

Your Jacuzzi spa is equipped to allow you to customize the massage action you desire. Each model incorporates a massage selector that allow you to customize the massage and performance by diverting water between various jet systems. Simply turn massage selector to position A (Combo), B, or C to divert water pressure to various jet groups.

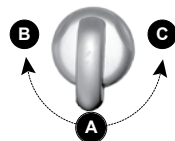

Note: The massage selector valve(s) is designed to operate in positions A (Combo), B, and C for optimum performance. It is considered normal for sound levels within the valve to vary between positions due to the large amounts of water flowing through it. For optimum filtration benefits, leave the valve in position A when spa is covered. Select position B or C for maximum jet performance during spa use.

11.11 Optional J-1000™ JBL Audio System

Jacuzzi models equipped with the optional audio system offer enhanced hot tub enjoyment by offering an integrated state-of-the-art audio system. These models include an integrated AM/FM/CD/MP3/iPod/USB, and NAND (internal hard-drive) player receiver, high-quality spa engineered speakers for unsurpassed sound quality and long-life, and an integrated subwoofer for an enhanced acoustical experience.



12.0 Programming Instructions for Settings 1 Menu

Your Jacuzzi spa is equipped with two settings menus that allow you to program and activate different components of the spa. In the “Settings 1” menu you can program the Language, Date and Time, Lock/Unlock the spa and the check/clean filter reminder. You can also access the “Settings 2” menu (Section 13.0, page 59).

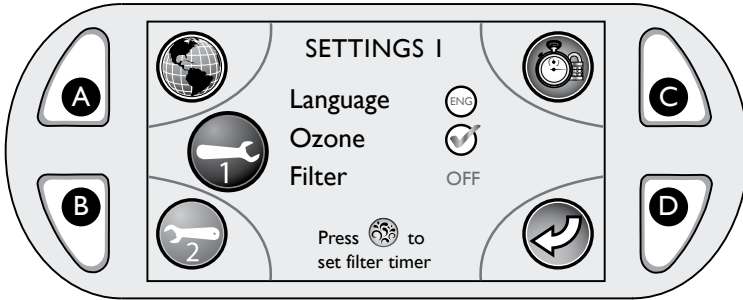

Figure A

12.1 To access the Settings 1 Menu:

1. Press button D from the Main Menu (page 35) to enter the Settings 1 Menu (Figure A).
2. From this menu you can choose a language (either English or Français), set the time and date, lock/unlock the spa, set the change/clean filter remainder and check the “on” or “off” status for the ozone (if equipped, the ozone is not programmable).

12.2 Choosing the Language

1. Press button A to enter the Language submenu. The screen will change to the Figure B.

Note: English is the default language.

2. Use the Quad Keypad to switch between English and Français by pressing the Up or Down button.

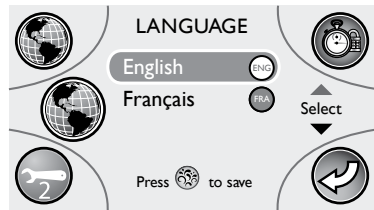

Figure B

3. Press the Splash button to save your change. The screen will return to the Settings 1 Main Menu.

12.3 Setting the Check Filter Reminder

1. Use the Quad Keypad to scroll from Language to Filter by using the Down button. After “Filter” selection is active, press the Splash button to access the “set filter timer” (Figure C).
2. Press the Left or Right button on the Quad Keypad to scroll the number of days you would like the reminder to appear so the filters and polishing bag can be cleaned or replaced (Figure D).
3. Press the Splash button to confirm and save your selection.

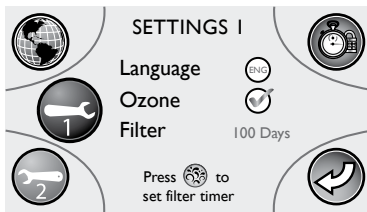

Figure C

4. When the set time period expires, the “Please check filter!” message will appear on the Main Menu display (page 76). The reminder must be reset when the time allotted expires.

Note: The time range is from 10 to 365 days in increments of 10 days or you can elect to turn the feature “OFF”.

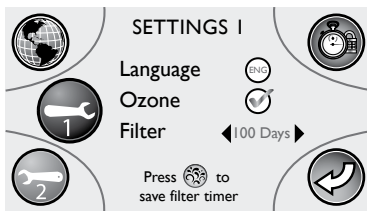

Figure D

12.4 Setting the Date

1. Press button C (Figure A, page 55) to enter the date and time menu.
2. The “Date Settings” is already selected once you enter the screen (Figure E). Press the Splash button on the Quad Keypad to go to the submenus.
3. The screen will open with the “Set Year” selected (Figure F). Press the Left or Right button on the Quad Keypad to scroll through selection. Once the correct year is displayed, press the Down button on the Quad Keypad to access the month selection.



Figure E



Figure F

4. With the “Set Month” selected (Figure G), use the Left or Right button on the Quad Keypad to scroll through selection. Once the correct month is displayed, press the Down button to access the day selection.



Figure G

5. With the “Set Day” selected (Figure H), press the Left or Right button on the Quad Keypad to scroll through selection. Once the correct day is displayed, press the Splash button to save your changes. Press button D to return to the Date and Time Setting menu.



Figure H

12.5 Setting the Time

1. Press the Down button on the Quad keypad to access the “Time Settings” (Figure I) menu, then press “Splash” to enter the submenus.



Figure I

2. The screen will open with “Set Clock” selected (Figure J). Press either the Left or Right button on the Quad Keypad to choose either a 12-hour or 24-hour (military time) display. Then press the Down button to access the hour selection.



Figure J

3. With “Set Hour” selected (Figure K), press the Left (decrease) or Right (increase) button on the Quad Keypad to scroll through the selection. Once the correct hour is displayed, press the Down button to access the minutes selection.

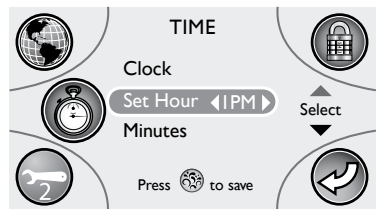

Figure K

Note: If you are using a standard 12-hour period, you will see the hour displayed as “1PM”. For the 24-hour period it will read “1300”.

- With "Set Min." selected (Figure L), press the Left (decrease) or Right (increase) button on the Quad Keypad to scroll through the selection. Once the correct minutes are displayed, press the Splash button to save your changes. Press button D to return to the Settings 1 Main Menu.



Figure L

12.6 Locking and Unlocking the Topside

- From the "Date and Time" Menu (Figure M), press button C to access the Lock feature. This feature accepts a three digit code to lock and unlock the panel from unauthorized use.

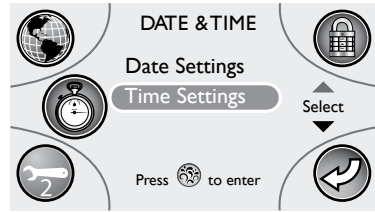

Figure M

- To set each "lock code" digit, use the Left or Right button on the Quad Keypad. To change a number, press the Up or Down button to scroll through selection 0-9 (Figure N). Once you have selected a 3-digit code, press the Splash button to save your changes. When the spa is locked the LCD display will look like Figure O.

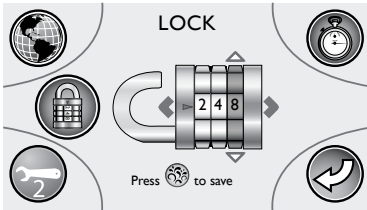

Figure N

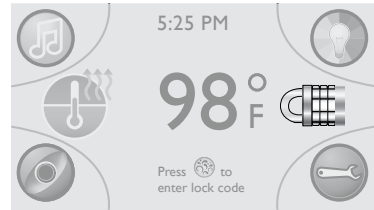

Figure O

- To Unlock the topside panel, press the Splash button on the Quad Keypad. The lock icon will appear on the LCD display (Figure P). Press the Up, Down, Left and Right Quad Keypad buttons to enter "lock code" from left to right. After all three lock code digits are entered, press the Splash button to access the Main Menu (if correct code was entered).

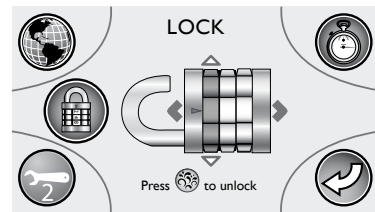

Figure P

Note: In case the lock/unlock code is lost or forgotten, a default code of 772 can be used to unlock the panel.

13.0 Programming Instructions for Settings 2 Menu

The “Settings 2” screen allows you to program Heating, Primary Filter and Secondary Filter modes.

13.1 Programming Heating Cycles

Your Jacuzzi spa is equipped with two modes of heating. An automatic mode called “Auto-Heating”, where the spa’s temperature is maintained at all times by the “Setpoint”. The second mode is called “Programmable”, where the spa will only activate the heater at set times programmed by you. To activate either mode follow the procedures below.

To access the “Settings 2” Menu:

1. From the Settings 1 Menu (Figure A), press button B.
2. The “Settings 2” Menu will appear (Figure B).

Note: You can return to the factory default heating and filtration modes by pressing the Splash button on the Quad Keypad while in the Settings 2 Main Menu (Figure B) at any time.

Figure A

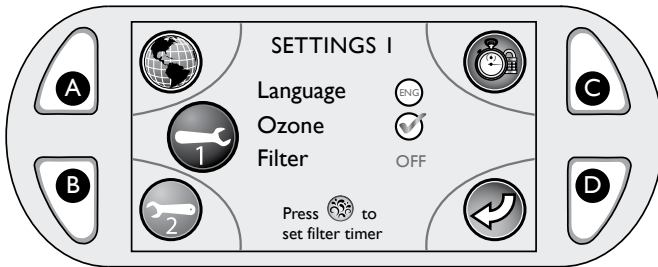
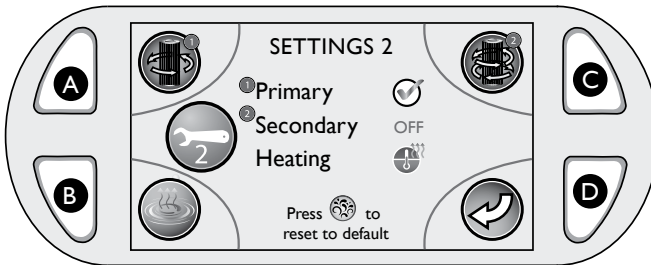

Figure B



13.2 Auto-Heating Mode

Auto-Heating mode is typically selected by customers in cold climates where heat up times are extended due to lower ambient temperatures. In this mode, water temperature is regulated by the set temperature which activates the heater automatically as needed.

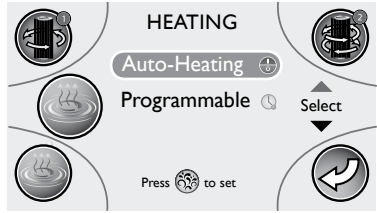

Figure C

Note: If you elect to use Auto-Heating, you can skip this section. Auto-Heating is the default spa setting.

1. Press button B to enter the Heating Menu (Figure C). The menu appears with Auto-Heating selected. If you elect to use this mode, press the Splash button on the Quad Keypad. The display will confirm your selection and Figure D will be displayed.

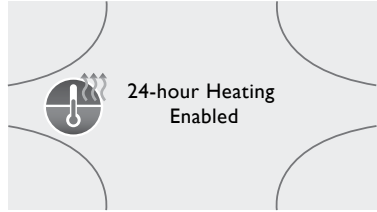

Figure D

2. To exit the submenu, press button D to return to the “Settings 2” Menu.

13.3 Programmable Heating Mode

Programmable heating mode is typically selected by customers in warm climates where heat up times are minimized due to higher ambient temperatures. In this mode, the water temperature is regulated by the set temperature only when a programmed heating cycle is running, unless in summer logic page 64.

1. From the Heating Menu (Figure C), use the Quad Keypad Down button to select the programmable setting, then press the Splash button to enable selection.

A. Program A Heating Mode

1. You are allowed to have two separate programs in the programmable mode, you can elect to use both or just one. Press the Splash button to enter the submenus for “Program A” (Figure E).

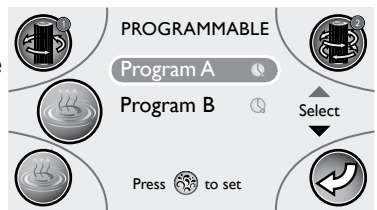

Figure E

- From this menu (Figure F), you can set the days, times, and duration. With “Day Settings” selected press the Splash button on the Quad Keypad to access the submenus.

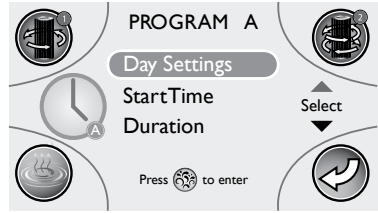

Figure F

- When you enter the submenu (Figure G), you can choose the day(s) you would like “Program A” to run for a heating cycle. Press the Up or Down button (on the Quad Keypad) to scroll through and choose the days you would like the heater to activate. Press the Left or Right button to turn “ON” (☑) or “OFF” the heater for that day.



Figure G

- Press the Splash button once to save settings.
- Press button D to return to the submenu (Figure F) to continue programming the start time and duration.
- Press the Down button on the Quad keypad to select “Start Time” (Figure H). Press the Left or Right button on the Quad Keypad to select the time you wish the spa to run. Press the Down button to access the “Duration” submenus.

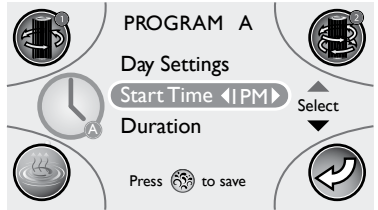

Figure H

Note: If you are using a standard 12-hour period, you will see the hour displayed as “1PM”. For the 24-hour period it will read “1300”.

- Now you will need to adjust the cycle “Duration” (Figure I). Cycle duration range is adjustable from 0 (OFF) to 6 hours. Press the Left or Right button on the Quad Keypad to make adjustments in increments of 1 hour.

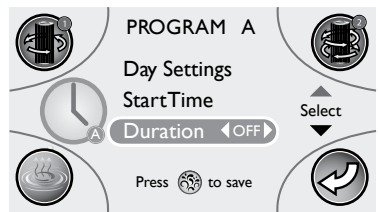

Figure I

- Press the Splash button on the Quad Keypad to save your changes and return to the Heating Menu. At this point you can program a Secondary Heating Mode (Program B) or to continue on to the Filtering programming (see Section 13.5, page 64).

B. Program B Heating Mode

- To program the Secondary Heating mode press the Down button on the Quad Keypad to access the “Program B” (Figure J) settings. Press the Splash button to enter the submenus for Program B.

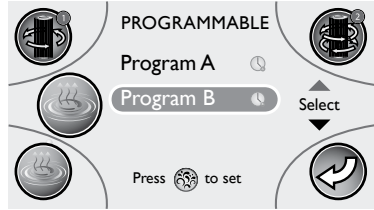

Figure J

- From this menu (Figure K), you can set the days, times, and duration. With “Day Settings” selected, press the Splash button on the Quad Keypad to confirm selection.

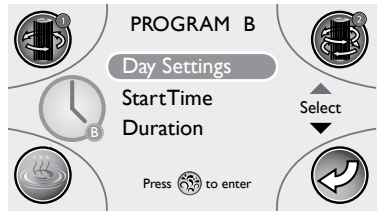

Figure K

- When you enter the submenu (Figure L), you can choose the day(s) you would like “Program B” to run for a heating cycle. Press the Up or Down button (on the Quad Keypad) to scroll through and change the days you would like the heating to activate. Press the Left or Right button to turn “ON” (☑) or “OFF” the heating for that day.



Figure L

- Press the Splash button once to save settings.
- Press button D to return to the submenu to continue programming the start time and duration (Figure K).

6. Once back to the “Program B” Main Menu, press the Down button on the Quad Keypad to select “Start Time” (Figure M). Press the Left or Right button on the Quad Keypad to select the time you wish the spa to run. Press the Down button on the Quad keypad to access the “Duration” setting.

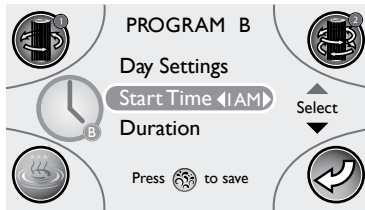

Figure M

Note: If you are using a standard 12-hour period, you will see the hour displayed as “1PM”. For the 24-hour period it will read “1300”.

7. Now you will need to adjust the “Duration” (Figure N) of the cycle. The duration range is from 0 (OFF) to 6 hours. Press the Left or Right button on the Quad Keypad to make your adjustment(s) in increments of 1 hour.



Figure N

Note: The default “Duration” is OFF.

8. Press the Splash button on the Quad Keypad to save your changes and return to the Heating Menu.

9. Press button D to exit the Heating Menu and return to the Settings 2 Main Menu. If you have programmed both heating cycles and the settings have been accepted, you will see the two program icons next to word Heating on the display (Figure O). If only one cycle was programmed, there will only be one icon. If no cycles were programmed there would be a thermometer with wavy arrows as the icon.

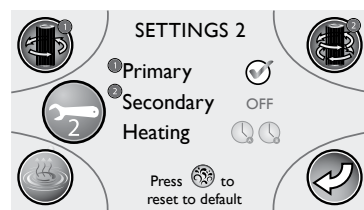

Figure O

13.4 Clean-Up “Blow-Out” Cycle

The clean-up cycle is once per day in both Auto-Heating and Programmable modes at 12:00 (noon) for two minutes. This is not user programmable. Each jets pump activates for one minute to circulate any water in the plumbing unless a pump has just finished a 20 minute time out, it will not automatically activate for the clean-up cycle. Be aware, the factory programmed clean-up cycle cannot be canceled or altered!

13.5 Programming the Primary Filter Cycle

1. To program the Primary Filter cycle press button A (Figure P). This cycle is mainly used to alter the pre-programmed 12-hour running period of the circulation pump. The 12-hour cycle is from 12:00 AM to 12:00 PM. (If you would like to leave the circulation pump as is, then skip this section). Upon entering the Primary submenu the “Start Time” will be selected (Figure Q).

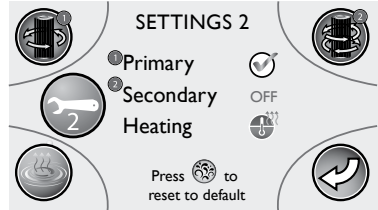

Figure P

2. Press the Left or Right button on the Quad Keypad to choose the hour you want the circulation pump to start running (Figure Q).

Note: If you are using a standard 12-hour period, you will see the hour displayed as “1PM”. For the 24-hour period it will read “1300”.

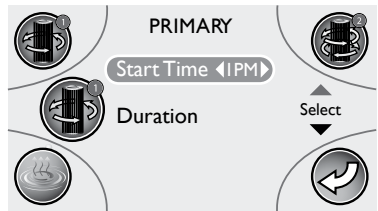

Figure Q

3. Now you will need to adjust the “Duration” (Figure R) of the cycle. Press the Left or Right button on the Quad Keypad to make adjustments in increments of 1 hour. Press the Splash button on the Quad Keypad to save hour and duration selections and return to the Settings 2 Main Menu (Figure P).

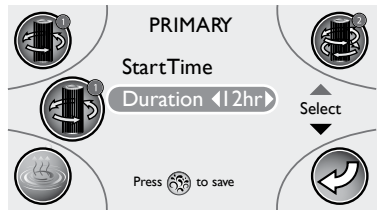

Figure R

Summer Logic: In warm weather, the water temperature in the spa may exceed the set temperature. This condition may occur due to heat transference from the filter/circulation pump and jets pumps. If the water temperature is higher than 95°F (35°C) and rises two degrees above the set temperature, a “Summer Logic” condition occurs that deactivates the filter/circulation pump and ozonator (if equipped). This safety feature cannot be altered! The filter/circulation pump and ozonator will remain off until the water temperature cools to the set temperature (except between 9:00-11:00 AM when the filter/circulation pump runs for its mandatory 2-hour cycle). To help prevent a “Summer Logic” condition, it may be necessary to reduce filter/circulation pump cycles run times in warm weather.

13.6 Programming the Secondary Filter Cycle

- To program the Secondary Filter cycle, press button C. This cycle will activate the main jet pump to run for additional filtration when programmed (Figure S). If you choose not to use this feature, please skip this section.

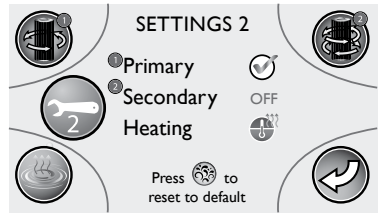

Figure S

- When you enter the Secondary Filter Cycle submenu, the “Day Settings” will be selected (Figure T). From this menu, you can set the day, time, and duration. Press the Splash button on the Quad Keypad to confirm selection.



Figure T

- You can choose the day(s) you would like to run a secondary filter cycle (Figure U). Press the Up or Down button on the Quad Keypad to scroll through and change the days you would like the filtration to run. Press the Left or Right button to turn “ON” (☑) or “OFF” the filtration for that day.

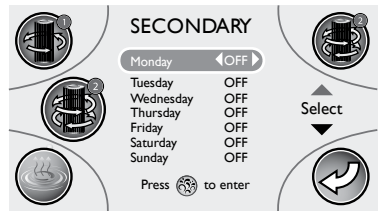

Figure U

- Press the Splash button to save settings.
- Press button D to return to the submenu to continue programming the start time and duration (Figure T).
- Press the Down button on the Quad Keypad to select “Start Time” (Figure V). Press the Left or Right button on the Quad Keypad to select the time you wish the spa to filter. Press the Down button on the Quad keypad to access the “Duration” setting.

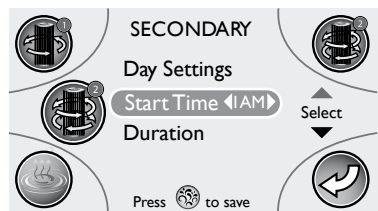

Figure V

Note: If you are using a standard 12-hour period, you will see the hour displayed as “1PM”. For the 24-hour period it will read “1300”.

7. Now you will need to adjust the filter cycle “Duration” (Figure W). The duration range is from 0 (OFF) to 120 minutes. Press the Left or Right button on the Quad Keypad to make your adjustments in increments of 15 minutes.

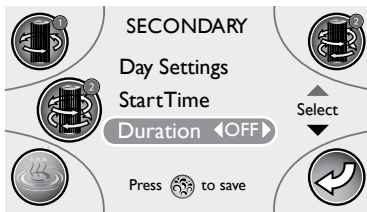

Figure W

8. Press the Splash button on the Quad Keypad to save selection. Then press button D several times to return to the main operation menu (page 35).

14.0 Spa Maintenance

Proper and regular maintenance of your spa will help it retain its beauty and performance. Your authorized Jacuzzi dealer can supply you with all the information, supplies, and accessory products you will need to accomplish this.



DANGER: RISK OF SEVERE INJURY OR DROWNING BY ENTRAPMENT!

- Keep hair, loose articles of clothing or hanging jewelry away from suction fittings, rotating jets or other moving components to avoid entrapment that could lead to drowning or severe injury.
- Never use the spa unless all suction guards, filter, filter lid, or skimmer assembly are installed to prevent body and/or hair entrapment.
- Never operate or use the spa if the filter, filter lid, or skimmer assembly are broken or any part of the skimmer assembly is missing. Please contact your dealer or nearest service center for service.
- The suction fittings and suction covers in this spa are sized to match the specific water flow created by the pump(s). If it is necessary to replace the suction fittings, suction covers or pump(s), be sure that the flow rates are compatible and are in compliance with the VGB Safety Act, page 2.
- Never replace a suction fitting or suction cover with one rated less than the flow rate marked on the original suction fitting. Using improper suction fittings or suction covers can create a body or hair suction entrapment hazard that may lead to drowning or severe injury.
- Owners must alert all spa users to the potential risk of Hair, Limb, Body, Evisceration (disembowelment), and Mechanical Entrapment, page 6.

14.1 Cleaning the Filter Cartridges

A programmable “Please Check Filter” reminder appears on the control panel display after a specified number days to remind you to clean the skimmer filter and to check the polishing bag filter. This reminder must be reset at each filter cleaning interval.

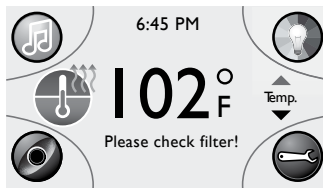

Refer to Section 12.3 (page 56) for additional information and programming details. Your new spa is equipped with an advanced 2-stage filtration system. Fine debris are filtered by the circulation pump drawing water through the ProClear™ skimmer and pleated filter cartridge 12 hours (unless programmed otherwise). Large debris are filtered when either jets pump is running when the spa is in use or during a programmed filter cycle. These pumps draw water from footwell suction fitting and through a secondary water polishing bag filter and additional filter. The exclusive footwell “sweeper” suction fitting enhances filtration in the footwell area by creating a “swirling” water motion to maximize particle agitation and pickup.

To ensure optimum performance, the ProClear II skimming filter cartridge (A) must be cleaned every three months and replaced once a year. The secondary ProClear Plus polishing filter bag (B) should be emptied weekly and replaced every 3 months. The ProClear II filter cartridge (C) must be cleaned every three months and replaced once a year. To accomplish this, refer to the following filter cleaning procedure.

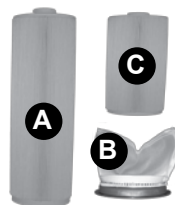

Note: Do not attempt to wash the polishing filter bag (B) or it will come apart!

DANGER: TURN POWER TO SPA OFF! TO DECREASE RISK OF DEATH, DROWNING, OR ENTRAPMENT, NEVER OPERATE SPA WHEN FILTER IS NOT PROPERLY INSTALLED OR IF WEIR ASSEMBLY IS DAMAGED OR ALTERED!

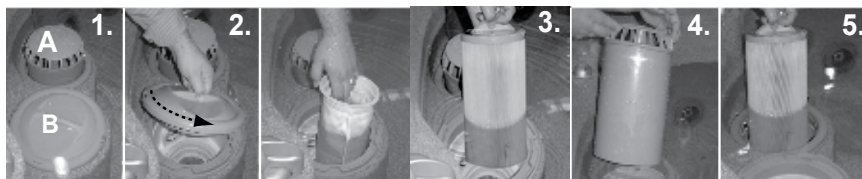

1. Remove power to the hot tub before removing the skimmer (A) or filter bag cover (B).
2. Remove the polishing bag lid (B) by rotating it counterclockwise approximately 5 degrees until you feel it unlatch.
3. Remove the polishing bag by reaching into the filter bucket and gently pulling upward on the blue filter ring (empty filter bag weekly)

or install a new bag every three months.) Located below the bag is a small ProClear filter. Remove the filter by rotating it counterclockwise. For cleaning procedures see step 6 below. Once the filter has been cleaned or replaced, reinstall it into the skimmer below the polishing bag. Replace bag, then install filter lid by rotating it clockwise until you feel it latch in place. **DO NOT FORCE LID! FINGER TIGHT ONLY!**



4. Remove the ProClear skimmer assembly (A) by gently lifting upward from the filter bucket.
5. Remove the ProClear filter cartridge by rotating it counterclockwise to unthread it, then remove the center cap and chemical dispenser from the filter cartridge as shown (right).
6. Clean the ProClear filter cartridges with a garden hose and high pressure nozzle. Rinse debris from the filter pleats beginning at the top and working your way downward. Continue, one section at a time until you have cleaned all debris from the filter pleats. When replacing the filter cartridge, make sure you remove the center cap and chemical dispenser for use with the new cartridge. Replacement filter cartridges may be purchased from your authorized Jacuzzi dealer.

14.2 Draining and Refilling

About every 3 to 6 months, you will want to replace the spa's water. The frequency depends on a number of variables including the amount of use, number of users, attention paid to water quality maintenance, etc. You will know it is time for a change when you cannot control sudsing and/or you can no longer get the normal feel or sparkle to the water even though the key water balance measurements are all within the proper parameters.

CAUTION! READ THIS BEFORE DRAINING: To prevent damage to the spas components, turn off power to the spa at the circuit breaker before draining it. Do not turn the power back on until your spa has been refilled.

CAUTION: There are certain precautions to keep in mind when draining your spa. If it is extremely cold, and the spa is outdoors, freezing could occur in the lines or the equipment (see "WINTERIZING", page 70). On the other hand, if it is hot outdoors, do not leave the spa's surface exposed to direct sunlight.

To drain your spa, perform the following steps:

1. Turn off power to spa at breaker.
2. Locate the drain valve located on the front left corner on the black plastic pan. Hold the larger (rear) drain valve body to prevent it from turning, then loosen and remove the front cap to expose the underlying male hose threads.
3. Attach a garden hose to the exposed threads.
4. Gently rotate the larger (rear) valve body 1/3 turn counterclockwise to unlock the drain valve.
5. Pull the larger (rear) body outward as shown to open drain.
6. After the spa drains, perform steps 2-5 in reverse order to close the drain prior to refilling spa.

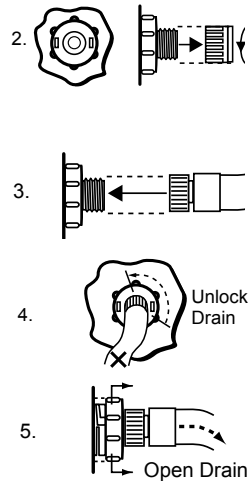

After refilling, turn on power to the spa and follow the steps listed under “Spa Fill Up Procedures.” (page 17). Always fill your spa through both filter buckets.

14.3 Cleaning the Spa Interior

To preserve the sheen of your spa’s surface, it is crucial that you avoid using abrasive cleaners or cleaners which have adverse chemical effect on the surface. If you are not certain as to the suitability of a particular cleanser, consult your authorized Jacuzzi dealer. Regardless of the cleanser used, use extreme care to assure that no soap residue is left on the surface. This could cause severe sudsing when the spa is refilled.

14.4 Pillow Care

Clean the headrests in your spa as needed by wiping them with a cloth with soapy water. It is not necessary to remove the headrests for cleaning. To remove headrests for long term storage or replacement, grasp both ends of each headrest and gently pull inward towards the center of the spa. To reinstall, over mounting strip and press down until headrest mounting bracket emits a “click” sound. Then adjust headrest height by simply moving up or down as desired.

14.5 Maintaining the Synthetic Cabinet

The synthetic cabinet requires little or no maintenance of any kind. To clean, simply wipe cabinet with mild detergent soap solution and a clean towel.

14.6 Cleaning the Control Panel

To clean, simply wipe cabinet with a micro-fiber cloth that is used for cleaning polycarbonate lenses.



CAUTION: Never spray cabinet with a high pressure garden hose for any reason since this action may induce an electrical short in the spa's electrical equipment.

14.7 Vinyl Cover Care and Maintenance

Your Jacuzzi cover has a vinyl encasement. This vinyl encasement is attractive and durable. Monthly cleaning and conditioning is strongly recommended to maintain and increase the longevity of your cover.

A. To Clean and Condition the Vinyl Cover

1. Use a garden hose to loosen debris and dirt.
2. Using a large sponge or a soft bristle brush, use diluted or mild soap and scrub the vinyl top. Rinse clean and do not allow soap to dry on cover. Do not use soap on the underside of the cover.
3. Please check with your Jacuzzi Dealer for recommended cover care and conditioning products. Condition using non-petroleum based conditioners to keep the vinyl supple and threads/stitching from drying out. Do not use solvents, abrasive cleaners or strong detergents. Do not use products that contain silicone or alcohol.

B. Additional Care and Maintenance Instructions:

1. Debris can accumulate on the spa cover. Removal of snow or other debris will help to avoid breakage of the foam cores.
2. Be sure to lock the cover straps to secure the cover from unwanted or accidental entry.
3. Do not place heavy objects on the vinyl.
4. Do not walk, sit or stand on the cover.
5. Do not drag or use the flaps/skirt or the cover lock straps to remove the cover.
6. Use only recommended cover lift systems.
7. Use only chemicals and cleaners recommended by Jacuzzi.
8. Remember to keep spa covered when not in use. Maintaining proper water levels assures efficient operation and efficient electrical usage.
9. Do not expose your spa to the sun for extended periods of time as UV rays can damage the interior surface.
10. Use caution when removing cover. Before removing cover, assure all locks have been released to avoid lock breakage and or cover strap damage.

14.8 Winterizing

Your Jacuzzi spa is designed to automatically protect itself against freezing when operating properly. During periods of severe freezing temperatures, you should check periodically to be certain that the electrical supply to the spa has not been interrupted. In extreme, bitter

cold weather (less than -20°F) verify auto-heating is set for 24-hour operation (Section 13.5 Programming The Primary Filter Cycle, page 64) and that auto-heating is selected (Section 13.2 Auto-Heating or Section 13.3 Programmable Heating Mode, page 60) to protect against damage to the spa.

If you do not intend to use your spa, or if there is a prolonged power outage during periods of severe freezing temperatures, **it is important that all water be removed from the spa and equipment to protect against damage from freezing.**

Expert winterization of your spa is highly recommended, contact your authorized Jacuzzi dealer. In emergency situations, damage can be minimized by taking the following steps:

CAUTION: TURN OFF POWER TO SPA.

1. Follow the directions on page 68 for draining the spa.
 2. Turn the massage/diverter selector(s) into the middle combo position to allow the water in the plumbing lines to drain, see page 54.
 3. Turn the waterfall valve to the open position to allow the water in the plumbing lines to drain, see page 54.
 4. As the water level drops below the seats, use whatever means necessary to get the water out of the recessed seating areas and into the footwell, such as a wet/dry vacuum.
 5. When the water level ceases to drop, use whatever means available to remove any remaining water from the footwell, such as a wet/dry vacuum.
 6. Remove the equipment-side cabinet panels and locate the drain plugs in the front of each pump (Figure A, page 12). Remove these plugs to allow the water to drain out of the pumps and heater.
- Note:** Approximately one to two gallons will be released during this procedure. Use a wet/dry vacuum or other means to keep this from flooding the equipment compartment. Replace the drain plugs.
7. Loosen hose clamp at bottom of heater (Figure A, page 12) and pull hose off of heater fitting (twist the hose back and forth while pulling downward). Tip hose down and allow to drain, then reinstall hose and clamp.
 8. Loosen the hose clamp on the circulation pump (if equipped) intake behind the control box (Figure A) and pull the hose off (twist hose back and forth while pulling outward). Tip hose down and allow to drain, then reinstall hose and clamp.
 9. Re-install cabinet side panels and cover spa so that no casual moisture can enter into it.

Consult your Jacuzzi dealer if you have any questions regarding winter use or winterizing.

14.9 Restarting Your Spa in Cold Weather

If you want to start up your spa after it has sat empty for a time in freezing temperatures, be aware that the water remaining in certain sections of the piping may still be frozen. This situation will block water flow preventing the spa from operating properly and possibly damaging the equipment. We recommend you consult your dealer for guidance before attempting to restart your spa under these conditions.

15.0 Water Quality Maintenance

To decrease the risk of contracting a waterborne illness (e.g. an infection, bacteria or virus) and/or respiratory ailments, maintain water quality within specified limits. This will enhance your enjoyment and prolong the life of the hot tub's equipment. Doing so requires regular attention because the water chemistry involved is a balance of several factors. Procrastination in regard to water maintenance will result in poor and potentially unhealthful conditions for soaking and even damage to your hot tub investment. For specific guidance on maintaining water quality, consult your Authorized Jacuzzi dealer who can recommend appropriate chemical products for sanitizing and maintaining your hot tub.



WARNING: FAILURE TO MAINTAIN WATER QUALITY WILL:

- Increase risk of contracting a waterborne illness (e.g. an infection bacteria or virus) and/or respiratory ailments.
- Damage the equipment, components and spa shell, which are not covered under the hot tub's warranty.

CAUTION: Never store hot tub chemicals inside the hot tub's equipment bay. The equipment bay may reach elevated temperatures, this is where high voltage electronic devices are located. This area is not intended for storage of any kind.

15.1 pH Control

pH is a measure of relative acidity or alkalinity of water and is measured on a scale of 0 to 14. The midpoint of 7 is said to be neutral, above which is alkaline and below which is acidic. In spa water, it is very important to maintain a slightly alkaline condition of 7.4 to 7.6. Problems become proportionately severe the further outside of this range the water gets. A low pH will be corrosive to metals in the spa equipment. A high pH will cause minerals to deposit on the interior surface (scaling). In addition, the ability of the sanitation agents to keep the spa clean is severely affected as the pH moves beyond the ideal range. That is why almost all spa water test kits contain a measure for pH as well as sanitizer.

15.2 Sanitizing

To destroy bacteria and organic compounds in the spa water, a sanitizer must be used regularly. Chlorine and bromine are the two most popular sanitizers used to date. The "Proclear Mineral Spa Clarifier" designed especially for your hot tub is a beneficial product for water maintenance. Many other additives are available for your spa. Some are necessary to compensate for out-of-balance water; some aid in cosmetic water treatment and others simply alter the feel or smell of the water. Your authorized Jacuzzi dealer can advise you on the use of these additives. When adding spa shock (chlorine or non-chlorine) or pH balancing chemicals activate the jets pump(s) and leave the spa cover open for a minimum of 20 minutes. By doing this you will allow excessive chemical vapors to exit the spa, protecting pillows and plastic knobs from chemical attack.



WARNING: RISK OF PERSONAL INJURY, DROWNING OR ENTRAPMENT!

Never leave your hot tub unattended for any reason while the cover is open and accessible, especially to small children and animals!

CAUTION: RISK OF PERSONAL INJURY OR SPA DAMAGE!

Never add chlorine tablets (trichlor) or acid to your hot tub for any reason! These chemical may damage components within your hot tub, burn or irritate your skin, create a rash and void the manufacturer warranty for your spa.

15.3 Other Additives

Many other additives are available for your spa. Some are necessary to compensate for out-of-balance water, some aid in cosmetic water treatment and others simply alter the feel or smell of the water. Your authorized Jacuzzi dealer can advise you on the use of these additives.

15.4 Ozone Water Maintenance System (Optional)

This system is optional on North American models and standard equipment on export 50 Hz models. If your spa is equipped with the Jacuzzi CD ozone water purification system you will find that your water stays fresh and clear with significantly less chemical usage. You will probably be able to go longer between complete spa drainings.

Note: To maximize sanitation benefits from this product, always turn off the spa waterfall valve when the spa is covered or not in use. This setting ensures maximum water flow through the ozone injector and higher ozone concentrations. The ozone only runs when the circulation pump is running and shuts off when either jets pump is manually activated during spa use. The ozone will remain off for 5 minutes after both jets pumps time out or are manually turned off, then resume operation as programmed.

16.0 Error/Display Messages

There are a number of unique functions designed into your Jacuzzi spa to protect it from damage and/or to aid in troubleshooting. When an error occurs the spa will notify you by showing the screen below and an error code next to it. Following is a listing of all the possible messages along with their meanings:

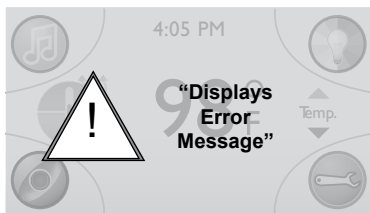

1.  **WARNING: RISK OF HYPERTHERMIA (OVER-HEATING) CAUSING SEVERE INJURY, BURNS, OR WELTS.**

Overheat protection: (Heater is deactivated, filter/circulation pump is activated). Water temperature is above acceptable limits. **DO NOT ENTER THE WATER!** Remove spa cover to speed cooling. See "Water Is Too Hot" on page 79. If condition persists, contact your authorized dealer or authorized service center.

2. Water is below set-temp: If the spa water is more than 20°F/6°C cooler than the temperature set point, the circulation pump and heater will automatically activate to provide freeze protection. The spa will stay in this mode until the water temperature reaches 15 degrees below the set temperature. No corrective action is necessary.
3. Communication error: Communication between the control panel and circuit board is faulty. If condition persists, contact your authorized dealer or service organization.
4. Pump does not operate: Proper flow of water is inhibited or a flow switch has malfunctioned. Check for proper water level and for clogged filter (page 67). If no sound is detected or if a "buzzing" sound is detected, turn off power to the hot tub. Pump may not be properly primed. If condition persists, contact your authorized dealer or service organization.
5. Freeze protection: A potential freeze condition has been detected. No action is required. Jets pump(s) and heater operate until the spa is out of danger. Depending on the amperage provided, operation will be as follows:
 - In 60A or 20A (50Hz only) logic, the heater remains on at all times, while pump 1 and pump 2 turn on for 10 minutes and then off for 10 minutes. The pumps will alternate on and off until the spa gets out of the freeze condition.

- In 50A or 30A logic, the heater turns on for 10 minutes then turns off. Then pump 1 and pump 2 turn on for 10 minutes, then turn off. The spa will alternate between the heater and the pumps being on and off until the spa gets out of the freeze condition.

Note: The pumps cannot be manually controlled while the Freeze condition is active. If a button is pushed, the error message will go away, but will reappear if the spa is still in the Freeze condition 5 minutes later. This error commonly occurs when the spa is first filled because tap water is often very cold.



**WARNING: RISK OF HYPERTHERMIA (OVER-HEATING)
CAUSING SEVERE INJURY, BURNS, OR WELTS.**

6. Emergency shutdown: Water temperature is above acceptable limits. **DO NOT ENTER SPA!** (spa is deactivated) A problem has been detected which could cause damage to the spa or its components. Contact your authorized dealer or service organization.
7. Open sensor: The temperature sensor is not functional. Heater is disabled. This must be repaired only by a qualified authorized service organization or service technician.
8. Shorted sensor: The temperature sensor is not functional. Heater is disabled. This must be repaired only by a qualified authorized service organization or service technician.
9. Open sensor: The hi-limit temperature sensor is not functional. Heater is disabled. This must be repaired only by a qualified authorized service organization or service technician.
10. Shorted sensor: The hi-limit temperature sensor is not functional. Heater is disabled. This must be repaired only by a qualified authorized service organization or service technician.
11. Start-up malfunction: Flow switch is non-functional. Closed or shorted flow switch on system start-up (system disabled). This must be repaired only by an authorized dealer or qualified service organization.
12. Open Flow Switch: (Heater is deactivated. The filter/circulation may also be deactivated). The flow switch is malfunctioning open, the circulation pump's filter cartridge is excessively dirty, or an air lock condition has occurred at the circulation pump intake. Contact your authorized dealer or service organization.
13. Closed Flow Switch: (Heater is deactivated. The filter/circulation may also be deactivated). The flow switch is malfunctioning closed. Contact your authorized dealer or service organization.

14. Audio Communication Malfunction: Communication between the control panel and audio system is faulty. Shutdown power to the spa, wait 3 seconds and restart the spa to reset the communication. Contact your authorized dealer or service organization.

15. Blinking Heater icon: This icon will blink on and off to indicate that:

- The temperature sensor is sensing a -20°F/6°C difference between the actual and set temperature or;
- The temperature sensor is sensing a temperature above 112°F/44°C or the hi-limit temperature sensor is sensing a temperature above 116°F/46°C.



16. Extended Temperature Activated:

The spa is set to go up to 104°F (40°C), but it can be set to reach 106°F (41°C). To access the

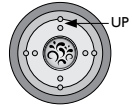
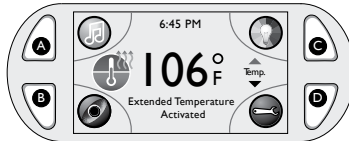

Figure A

extended temperature you must press the “Up” (on the Quad Keypad) button and the button D at the same time for 2 seconds. The system will now allow you to raise the temperature to 106°F (41°C) and the LCD display will read “**EXTENDED TEMPERATURE ACTIVATED**” (Figure A). To clear this message, just press the Down button on the Quad Keypad to lower the temperature below or back to 104°F (40°C).

17. Please Check Filter!

This message will appear when the filter reminder time has expired (Figure B). Please remove the Proclear filters and filter bag for cleaning or replacement.

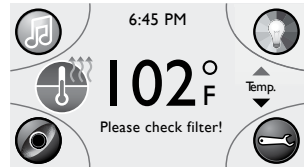

Figure B

18. Feature not installed: (Exterior lights)

This message will appear when a user tries to activate the exterior lights and they are not installed (Figure C). To clear the message press button D to return to Main Menu.

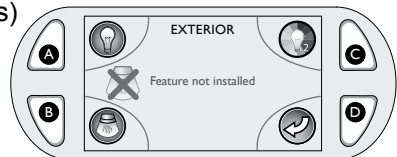

Figure C

19. Clear Settings 2 Programs

This message will appear when you choose to reset all settings 2 menu settings back to factory defaults (Figure D). You can either press the Splash button to reset or press the Previous button D to cancel.

Figure D



20. Remote bonding screens

These message screens will appear when the wireless remote has been bonded to the spa and can now be used to control the spa functions (Figure E).

Figure E



17.0 Troubleshooting Procedures

In the unlikely event your spa is not working the way you believe it should, please first review all the installation and operating instructions in this manual and check the message on the panel display; second, if you are still not satisfied it is working properly, please follow the appropriate troubleshooting instructions.

PROBLEM

PROCEDURE

NONE OF THE COMPONENTS OPERATE (i.e. pump light)

Check the control panel lights.

1. If there are letters or symbols displayed on the screen, refer to the previous section to determine the meaning and action required.
2. If nothing appears on the screen:
 - A. Check the household circuit breaker.
 - B. Contact you dealer or authorized service center.

PUMP DOES NOT OPERATE AND ICON DOES

Activate the "JETS":

1. If no sound is detected or if a "buzzing" sound is detected, turn off power to the spa and contact your dealer or service center.
2. If motor operates but no water flows to jets:
 - A. Pump may not be properly primed. See instructions below.
 - B. Contact dealer or authorized service center.

Pump Priming Instructions:

1. Turn off power to the spa.
2. Remove the handle from the massage selector supplied by the pump you are priming.
3. Loosen the massage selector's cap slightly (counterclockwise), listening for the air to seep out.
4. Tighten the cap finger-tight, replace the handle and turn the hot tub's power back on.

Note: This method must be used for the jet's pumps because these pumps are not connected to the main filter system in any way.

CAUTION: If freezing conditions exist and pump is not operational, take measures to protect the system from freeze damage. See Section titled "Winterizing" (page 70).

POOR JET ACTION
(see pages 22-32)

1. Make certain the jets pump is turned on.
2. Check position of massage selectors.
3. Open air control for selected jet system.
4. Check for adequate water level.
5. Check for dirty filter (page 67).

WATER IS TOO HOT

1. Reduce thermostat setting (page 18).
2. Switch hot tub to “Programmable” mode to turn heater on only during programmed filter cycles (page 60).

NO HEAT

1. Check thermostat setting.
2. Keep the cover in place while heating.
3. If heater indicator is displayed, but no temperature increase is experienced after a reasonable period of time, contact your dealer or authorized service center.

**FILTER/CIRCULATION
PUMP OFF**

1. Verify filter/circulation pump is programmed to run 12 hours a day (page 64).
2. Filter/circulation pump cycle canceled by power interruption. Wait 24 hours for hot tub to reset.
3. Hot tub water is warmer than 95°F (34°C) and two degrees warmer than the set temperature. The “Summer Logic” safety feature has activated. See note on page 64 for details.

Jacuzzi builds the best spas in the industry. Nonetheless, we are always striving to improve the quality and features of our products. Your input as a Jacuzzi spa owner is a cherished part of this process. If you have any comments or suggestions, or if you wish to be informed on any new products for your spa, please write to us.

CONGRATULATIONS on your good taste and welcome to the happiest and most relaxed family in the world!

18.0 Typical Spa Wiring Diagrams

18.1 Wiring diagram for North American 60 Hz Models Only

A 2-Pole Circuit Breaker with 2-Wire Grounded Load Connection (3 Wires to Hot Tub, 2-Hot (L1-L2), 1-Ground)

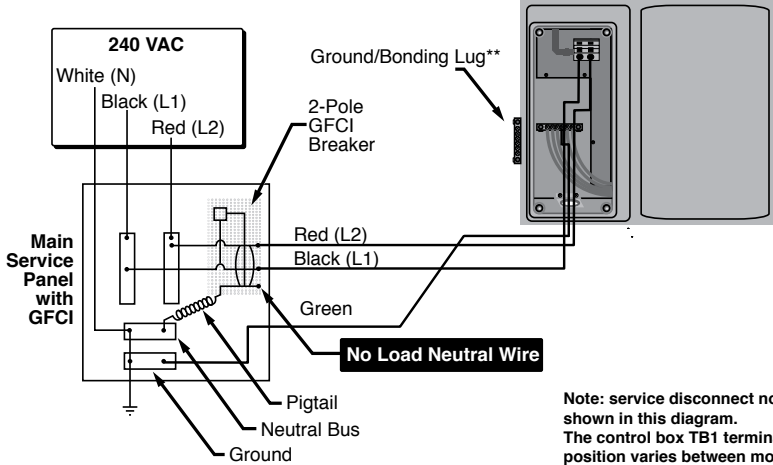

B Main Panel with Secondary GFCI Shut-Off Box Using a 2-Pole GFCI Breaker with 2-Wire Grounded Connection (3 Wires to Hot Tub, 2-Hot (L1-L2), 1-Ground)

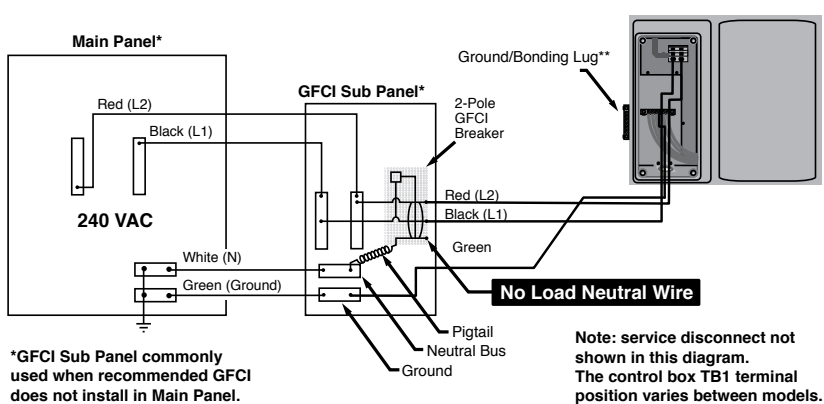

19.0 Optional Jacuzzi J-1000™ Audio System Stereo System Features

19.1 J-1000 Audio System Sound System Controls



- | | |
|-----------------------------|--------------------------------|
| 1. Power On/Off Button | 11. AUX Input Jack |
| 2. Tune/Seek Up/Down Button | 12. iPod Docking Station |
| 3. Volume Up/Down Button | 13. Disc Eject Button |
| 4. Mode Button | 14. CD Installation Slot |
| 5. SEL/EQ Button | 15. Front Panel Release Button |
| 6. AS/PS Button | 16. Front Panel |
| 7. MUTE Button | 17. Function Display |
| 8. BAND/RPT Button | 18. IR Sensor |
| 9. ENT/SH/RDM Button | |
| 10. USB Docking Station | |

19.2 J-1000 Audio System Sound System Operation

1. Power On and Off

Press power button (1) once to turn on stereo system. Press a second time to turn off.

2. Adjusting Volume

Press VOL Up/Down button (3) to increase or decrease volume. Current volume setting is briefly displayed (0 to 45).

3. Mute

In Radio or AUX mode, press mute button (7) once to mute audio output ("MUTE" appears on display). To restore audio output, press button (7) a second time, or press Volume Up/Down button. In CDP, USB, NAND and iPod mode, press button (7) to pause playback. Press again to resume playback.

4. Program Selection

Press MODE button (4) to cycle through available program sources as follows: Radio --> CDP --> USB --> NAND --> IPOD --> AUX --> Radio. If a CD or iPod is unavailable, that source will not appear on the display (17).

5. Adjusting Bass Level

Press EQ button (5) repeatedly until display reads "BASS". Press VOL Up/Down button (3) to choose desired setting. A display of "BASS 0" indicates center, -1 to -7 indicates bass cut, and +1 to +7 indicates bass boost.

Note: Unit returns to volume mode if volume control is not operated for 3 seconds.

6. Adjusting Treble Level

Press EQ button (5) repeatedly until display reads "TREBLE." Press VOL Up/Down button (3) to choose desired setting. A display of "TREBLE 0" indicates center, -1 to -7 indicates treble cut, +1 to +7 indicates treble boost.

Note: Unit returns to volume mode if volume control is not operated for 3 seconds.

7. Adjusting Balance Level

Press EQ button (5) repeatedly until display reads "BALANCE." Press VOL Up/Down button (3) to choose desired setting. A display of "BALANCE R-L" indicates center, L01 to 15 indicates left balance, R01 to 15 indicates right balance.

Note: Unit returns to volume mode if volume control is not operated for 3 seconds.

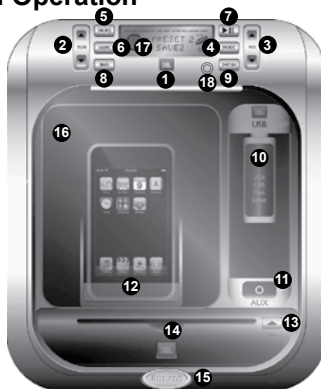

8. **Adjusting Fader Level**

Press EQ button (5) repeatedly until display reads "FADER." Press VOL Up/Down button (3) to choose desired setting. A display of "FADER F-R" indicates center, R01 to 15 indicates rear fade, F01 to 15 indicates front fade.

Note: Unit returns to volume mode if volume control is not operated for 3 seconds.

9. **Adjusting Beep Level**

Press and hold down EQ button (5) for about 2 seconds until display reads "BEEP 2ND", then release. Press VOL Up/Down button (3) to select either BEEP 2ND or BEEP on option.

- Select BEEP on, you can hear "beep" sound when you press all buttons.
- Select BEEP 2ND, you can hear "beep" sound when you press the button over 1.5 secs.

Note: Unit returns to volume mode if volume control is not operated for 3 seconds.

10. **Adjusting I-VOL Level**

Press and hold the EQ button (5) for about 2 seconds, then repeatedly press until display reads "I-VOL" (Initial Volume Level Adjustment). Press VOL Up/Down button (3) to choose desired setting (0 to 45), and the I-VOL will be set automatically. This feature regulates the max volume level during power up. If the volume level is higher than the initial volume setting when audio unit is turned off, once the audio unit is switched back on again, the audio unit will keep the volume adjusted to the preset level. If the volume level is lower than the initial volume setting when audio unit is turned off, it will remember the lower level and resume volume at that level when unit is turned on again.

Note: Unit returns to volume mode if volume control is not operated for 3 seconds.

11. **Adjusting Area**

In Radio mode, press and hold the EQ button (5) for about 2 seconds, then repeatedly press until display reads "AREA USA" or "AREA EUR". Press VOL Up/Down button (3) to choose desired setting, then press and hold the BND button (8) for 2 seconds to confirm selection.

Note: Unit returns to volume mode if volume control is not operated for 3 seconds.

12. Open/Close Front Panel

Press firmly on the release button (15), then open front panel (16) by gently lifting upward on bottom edge. To close front panel, gently flip panel down, then press firmly on panel directly above release button (15) until you hear an audible “click”. Keep front panel closed at all the times to prevent water intrusion, except when changing discs.

NOTE: Never insert wet discs into unit or CD player will be damage!



19.3 J-1000 Audio System Radio Operation

1. Radio Operation.

Press MODE button (4) to select Radio mode. Station frequency is indicated on display.

- To Select Band: Press BAND button (8) repeatedly to scroll through radio mode as follows: FM1 --> FM2 --> FM3 --> AM1 --> AM2 --> FM1. Each radio band stores up to 6 independent stations, for a total of 18 FM and 12 AM presets.
- To Program Station Presets in Radio mode: Press and hold SH button (9) until display reads “SHIFT”. Immediately afterwards, press and hold the Tune Up/Down button (2) for 2 seconds, then repeatedly press to select preset 1 to 6. At desired preset, press the ENT button (9) to store current frequency into selected preset.

Note: When power to spa is shut off for any reason, all station presets are reset.

2. Automatically Setting Station Presets

Press and hold the AS/PS button (6) for approximately 2 seconds until you hear a beep that confirms the memory function is engaged. The unit will search for six strong stations and automatically store them on the current band. All 18 FM and 12 AM presets can be set sequentially by selecting the next band and continuing the operation during auto programming.

3. Seek/Manual Tune

Press TUN Up/Down button (2) once to activate manual tuning mode, then press TUN Up/Down repeatedly to manually increase or decrease displayed frequency. Press and hold either TUN Up/Down button (2) for at least 2 seconds to activate auto tuning mode. The unit will automatically search and stop at the next higher or lower station with sufficient signal strength.

4. **Preset Scan Function**

Press AS/PS button (6) once to enter scan mode. Each preset station in the current band will play for 5 seconds while the preset number is flashes on the display (17). At the desired station, press AS/PS button (6) a second time.

5. **Accessing Preset Stations**

Press and hold ENT/SH button (9) until display reads "SHIFT". Repeatedly press TUN Up/Down button (2) to choose preset 1-6, then press ENT/SH button (9) to confirm selection.

19.4 J-1000 Audio System CD Player Operation

1. **Insert, Play, and Eject a CD**

Open front panel (16) by pressing firmly on release button (15) and lifting panel upward from bottom edge. Gently insert CD into slot (14) with label facing up. The CD will be drawn inside by the motorized mechanism. DO NOT FORCE! Close front panel by folding down, then press firmly on panel directly above release latch (15) until you hear an audible "click". Keep front panel closed at all the times to prevent water intrusion, except when changing discs. CD playback will automatically begin after CD is loaded. A "S-CDP" icon on the display indicates that a disc is inside the mechanism.

- To Play CD: Press the MODE button (4) to change to CD mode. The CD will play. The display shows current track, play time, and animates a 3-D rotating disc during playback.
- To Remove CD: Open the front panel and press CD eject button (13). Remove CD from drive and close front panel as instructed in step 12 (page 84).

2. **Changing CD Tracks and Music Seek**

To advance to next track, press TUN Up button (2) once to increase track counter one track. When final CD track is reached, play will resume on track #1.

- To fast forward through tracks: Press and hold TUN Up button (2) until track counter displays desired track, then release button.
- To rewind current track: Press and hold the TUN Down button (2) the track will quickly rewind until you release the button.

Note: It will go back to the beginning of the playing track when you press the Tune/Seek down button once, and it will go back to the previous track when you press the button once again.

3. **Random, Repeat**

- Random Mode: Press SH button (9) to play the CD tracks in random order. The left side of the display (17) reads "RDM" when random mode is enabled. Press a second time to deactivate.
- Repeat Mode: Press BND button (8) to repeat current CD track. The left side of the display reads "RPT" when repeat mode is enabled. Press a second time to deactivate.

4. Searching File or Folder in MP3/WMA CD

- To Search File in CDP (MP3/WMA) mode: Press AS/PS button (6) to enter track searching mode. Then press the VOL Up/Down button (3) to scroll through available tracks. At desired track, press ENT button (9) to confirm selection. Once a track is selected, it will automatically begin to play.
- To Search Folder in CDP (MP3/WMA) mode: Press and hold AS/PS button (6) for 2 or more seconds to enter folder searching mode. Then press VOL Up/Down button (3) to search through available folders. At desired folder, press ENT button (9) to confirm selection. Once a folder is selected, it will automatically begin to play the first track in the selected folder.

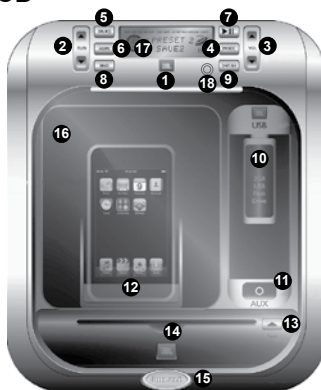

5. Display ID3

While in MP3 or WMA track is playing, you can know its ID3 information by following operation:

- Press and hold ENT button (9) for about 2 seconds until it displays “SHIFT” icon on LCD. Then repeatedly press MODE to display TITLE, FILE, ARTIST, and ALBUM.

Note: The intervals between each push should be less than 4 seconds. Once the “SHIFT” icon disappears from the LCD, it would work as changing mode. After the “SHIFT” icon disappears from the LCD, it would scroll the selected ID3 information on LCD.

19.5 J-1000 Audio System USB & NAND Operation

1. Play USB or NAND (internal memory)

Open the front panel and plug a USB device into the USB Docking Station (10). The USB device will begin to play automatically. Close the front panel. The “USB” symbol on the display indicates that a USB device is connected.

- To Play connected USB device: Press MODE button (4) to change to USB mode. The USB will play. The display (17) shows the current track, play time, and USB symbol. If no USB device is connected, simply plug a USB device into the USB docking station (10) and the unit will automatically switch to USB mode.
- To Play NAND: Press MODE button (4) to change to NAND mode. The NAND will play. The display shows the current track and play time. The Play/Pause, Repeat, and Random function for USB and NAND are the same as CD Player Operation (pages 85-86).

2. Copying Music Files from USB to NAND (internal memory)

In USB mode, press and hold SEL button (5) for about 2 seconds until “ONE COPY” displays on LCD (17), then press VOL Up/Down

button (3) to choose ONE or ALL. Press ENT button (9) to confirm selection.

- If ONE COPY is selected: The record percent “DOWN LOAD xx%” will display on the LCD (17). After copying is finished, the next track will automatically begin playback.
- If ALL COPY is selected: “The number of total track --> the number of recorded track” will display on LCD (17). After copying is finished, the unit will beep for about 3 seconds, then automatically begin playback of track #1.

Note: In copying process, you can change to other modes. (USB and NAND modes could not be selected.) While in other modes, the screen will default to the downloading process after 3 seconds.

3. **Deleting Music Files from NAND (internal memory)**

In NAND mode, press and hold SEL button (15) for about 2 seconds until “ONE DEL” displays on LCD (17). Use VOL up or down button (3) to choose ONE or ALL. Press ENT button (9) to confirm selection.

- If ONE DEL is selected: Next track will begin playback after file deletion has finished.
- If ALL COPY is selected: “DELETING” will display on LCD, then “NO FILE” will display after deletion process has finished. After that it would automatically switch to Radio mode.

4. **Searching File or Folder in USB/NAND**

- To Search File In USB or NAND mode: Press AS/PS button (6) once to enter track searching mode, then press VOL Up/Down button (3) to scroll through available tracks. At desired track, press ENT button (9) to confirm selection. Once track is selected, it will automatically begin to play.
- To Search Folder in USB or NAND mode: Press AS/PS button (6) to enter folder searching mode. Then press VOL Up/Down button (3) to scroll through available folders. At desired folder, press ENT button (9) to confirm selection. Then search your desired file as above method.

19.6 J-1000 Audio System iPod Operation

1. **Play iPod**

Open front panel (16) and plug an iPod into the iPod Docking Station (12) as shown. Refer to step 12 (page 84) for details. The iPod will begin to play automatically. Close front panel. The “iPod” symbol will display to indicate an iPod is connected.

- To Play connected iPod: Press MODE button (4) to change to iPod mode. The iPod will play. The display will either show:
 - A. The current track and play time or
 - B. The iPod will resume or pick up the last song played prior to docking it. Please note after a few seconds the stereo display will show audio information from iPod.

2. Searching Folders in iPod Mode

- To select folder in iPod mode: Press AS/PS button (6) to display music and then playlist. Press VOL Up/Down button (3) to select between Playlist, Artist, Albums, Genres, Songs and Composer (the scroll sequence depends on the iPod that is used). At the desired menu, press ENT button (9) to confirm selection and enter into Sub-folder selection. Then press VOL Up/Down to select again. At each desired folder/file, you need to press ENT to confirm selection.

Note: The DRM (Digital Rights Management Files) cannot be played on this deck. Personal files (MP3, WMA, iTunes or AAC) can be played as long as they are not DRM encrypted files.

3. Searching Files in iPod

- To advance to next track, press TUN Up button (2) once to increase track counter one track. When final track is reached, play will resume to track #1.
- To fast forward through tracks: Press and hold TUN Up button (2) until track counter displays desired track, then release button.
- To rewind current track: Press and hold the TUN Down button (2), the track will quickly rewind until you release the button.

Note: It will go back to the beginning of the playing track when you press the Tune/Seek Down button once, and it will go back to the previous track when you press the button once again.

4. Notes for iPod mode

- In iPod Mode, the play/pause function works.
- In iPod Mode, the RDM function does work.
- In iPod Mode, press RPT button only can play the current track repeatedly. If RPT function is activated, press Seek Up/Down button could not select the next or previous track, it could only go back to the beginning of the current track and begin to play again.

19.7 Docking your iPod Music Player

1. Docking Your iPod

The Docking Station for iPod is compatible with most dockable Apple iPod models. The Docking Station also charges the iPod when docked.

Note: The 3G/3GS iPhone models are compatible.

To dock an Apple iPod:

- Open Docking Station door (A) as outlined in step 12 (page 84).
- Center iPod over Docking Station Interface Port, then gently press downward as shown (B). **DO NOT FORCE!**
- Close Docking Station door as shown (C), then press firmly on door directly above door release latch (15) until you hear an audible “click”.





WARNING: RISK OF ELECTRICAL SHOCK HAZARD EXISTS AND EQUIPMENT DAMAGE! Never install or remove iPod while hands are wet or while sitting partially immersed or fully immersed in spa!

CAUTION: Never leave iPod in Docking Station when spa is not in use to prevent damage from outdoor elements! Never spray Docking Station with pressurized water hose for any reason! Damage to iPod or spa stereo system caused by water intrusion is not covered under the manufacturer warranty! Damage to Docking Station port or iPod due to excessive force or improper alignment during installation or removal from Docking Station is not covered under warranty.

19.8 Generic MP3 Player Operation

1. Connecting Your MP3 Player

- A. Plug in any MP3 player's headphone output jack with supplied cable into the auxiliary port (11) using the supplied audio RCA cable. Close stereo compartment during use to prevent moisture from entering the compartment.

2. Setting Up The MP3 Player for Use

- A. Select preferred song/album/playlist prior to plugging in MP3 player and start playback.
- B. Press "Mode Button" on stereo receiver until the LCD display reads "AUX".

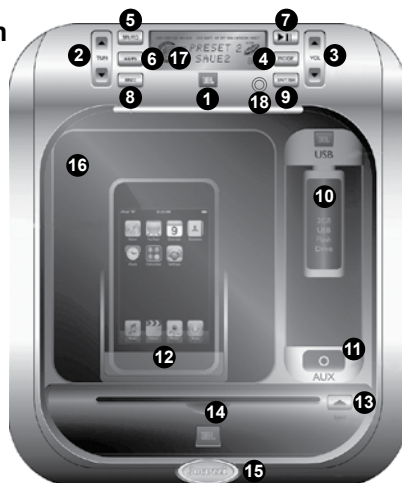

Note: All external MP3 player playback operations are performed solely by the MP3 Player with the exception of volume control and "Mode Button" selector, which can be controlled via wireless remote or on the stereo receiver.



WARNING: RISK OF ELECTRICAL SHOCK HAZARD EXISTS AND EQUIPMENT DAMAGE! Never connect, disconnect or operate external MP3 player while hands are wet or while sitting or standing partially or fully immersed in water!

19.9 J-1000 Audio System Stereo Troubleshooting

1. Unit will not turn-on

Make sure spa power is turned on, then check both harness fuses on side of unit making sure they are the proper ratings:

- Yellow memory B+ line (10A fuse).
- When faced with a malfunction during operation, push BND button (8) and Eject button (13) at the same time to reset software.
- With spa power off, use a paperclip to press the reset button located besides the USB Docking Station (10) to do a hardware reset.

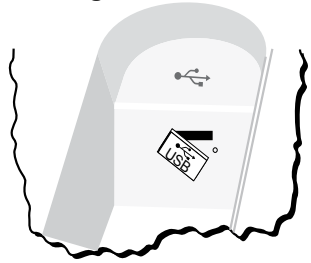

Note: It will be necessary to re-enter the radio preset memories and other personal settings after performing a reset. After resetting player, always ensure all functions are operation correctly.

2. Fogged CDs and Lens

This condition may occur when it's cold. Wipe fogged CDs with a soft cloth. Fogged optical components inside the unit will return to normal operation after an hour in a heated environment.

19.10 J-1000 Audio System Stereo Specifications

Tuner

FM usable sensitivity	10 dB
FM 50 dB quieting sensitivity	25 dB
FM alternate channel selectivity	80 dB
FM stereo separation @ 1 kHz.	30 dB
AM usable sensitivity	35 dB

CD Player

Sampling frequency (8X oversampling)	44.1 kHz
Channel separation @ 1 kHz	50 dB
Signal-to-noise ratio	60 dB
Frequency-to-noise response @ +/-2 dB	20-20 kHz

Audio

Maximum power output	(45 watts x 4 channel, 4Ω, 1 kHz) 180W
Continuous power.	18 watts x 4, 4 ohms, THD = 1%, 1 kHz
Bass boost/cu.	100 Hz +/- 10 dB
Treble boost/cut	10 kHz +/-10 dB

General

Nominal power supply	14.4 VDC
Allowable power supply	10.8-15.6 VDC
Current consumption	<15 mA
Speaker impedance	4-8 Ω

19.11 J-1000 Wireless Remote

A. The J-1000 Remote

Your spa is equipped with a technologically advance wireless remote (Figure A). Most spa functions can be controlled with the remote. The sleek modern design and easy navigation make this remote a great addition to your spa enjoyment. Listed below are the remote features, how to access and control them. General features of the remote are:

- The remote does not have a touch screen.
- When you first use the remote, it needs to be bonded to the spa.
- When not in used or after any 15 seconds of inactivity the remote goes into a “Sleep” status until activated. The backlighting and display will turn off.
- When activated the remote checks and verifies that it and the control system are bonded.
- When activated the remote checks to see if any of the components are running. If so, the component icon will blink on the remote LCD display to alert you that those components are activated. The water temperature is displayed on top of the screen, while the main menu is displayed.
- Pressing any key will activate the remote; the backlight will turn on and illuminate the keys and display. This lighting has a 10 second time-out period if no keys are pressed.

Note: Remote unit is water resistant not waterproof, therefore the unit should never be left in the spa while the cover is on and spa is not in use.

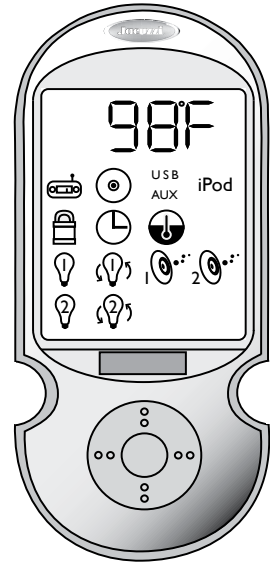

Figure A



= **Lock icon:** Will only appear if the spa is in locked mode and needs to be unlocked via the spa not the remote.



= **Temperature icon:** Allows you to set and control the temperature.



= **Time icon:** Allows you to set and control the time, either in a 12-hour or 24-hour period.



= **Lights 1 icon:** Allows you to control the interior lights.





= **Show 1 icon:** Allows you to control the interior Light Rotation mode.





= **Lights 2 icon:** Feature not available.

 = **Show 2 icon:** Feature not available.

 = **Jet 1 icon:** Allows you to turn on/off the jets pump 1.

 = **Jet 2 icon:** Allows you to turn on/off the jets pump 2.

 = **Low Battery icon:** Notifies you when the batteries are low and might need to be replaced. This icon will only appear if the battery is low.

 = **Return button:** Will return you to the Main menu for most submenus.

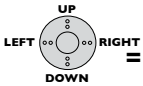

Navigational Keypad: Allows you to make selections using the Up, Down, Left, and Right buttons. The Select button is in the middle.

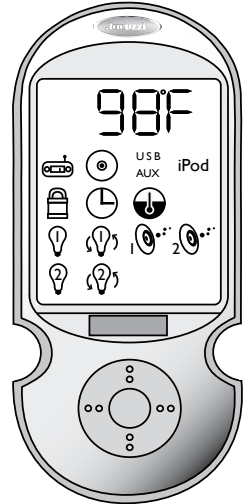

For spas with the stereo option the features below are also included.

AM = **AM icon:** Only appears when you are in the radio mode.

FM = **FM icon:** Only appears when you are in the radio mode.

 = **Radio icon:** Allows you to access the FM tuning, FM presets, AM tuning, AM presets.

 = **CD icon:** Shows the CD status.

USB = **USB icon:** Allows you to access files on a USB drive. Devices must be connected in order for the remote to operate them.

NAND = **NAND icon:** (Special icon arrangement.) Go to USB icon, the press the Up button on the Navigational Keypad. Display will blink with "NAND on it. Use only, if NAND hard drive is loaded with music files, otherwise this feature will not operate.

AUX = **AUX icon:** Allows you to access files on an auxiliary device. Devices must be connected in order for the remote to operate them.

iPod = **iPod icon:** Allows you to access files on an iPod.



Remote display for spas with the stereo option

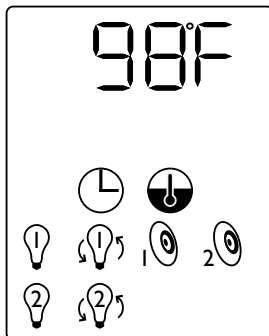

Remote display for spas without the stereo option

1. Bonding the remote and spa

When you first use the remote, it will need to be bonded to the spa for operational use. To bond the remote:

- Press button D and the Down button, at the same time, for 2 seconds (Figure A).
- The programming instructions will appear on the control panel LCD Display (Figure A).
- You will need to press the keys below on the remote unit, not the control panel on the spa, in the following sequence (Figure B):

1. Return, up
2. Return, up
3. Return, up
4. Select

- After you press the Select button, Figure C will appear on the control panel LCD Display.
- Finally, Figure D will appear once the bonding has finished. To clear the LCD display, press any key on the control panel.



Figure A

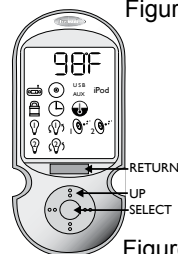

Figure B

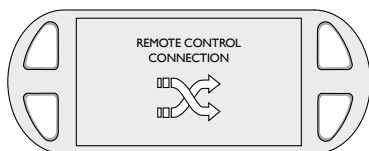

Figure C



Figure D

2. Main Menu

When any key is pressed and the remote awakes it will display the icons that are selectable. You can use the Navigational Keypad (up, down, left or right) to navigate through the screens and make selections. By moving through the icons, they will blink to let you know that if you hit the Select button you will activate that component or aspects of it.

3. Adjusting the Temperature

When the temperature icon is selected, all other icons on the display screen will disappear. The only two items shown are the thermometer icon and the digit temperature in °C or °F. Using the Navigational Keypad you can:

- Increase the temperature by pressing the Up button.
- Decrease the temperature by pressing the Down button.
- Use °C reading by pressing the Left button.
- Use °F reading by pressing the Right button.
- Go to the Main Menu by pressing the Return button or not pressing any keys for 4 seconds.

Note: When you first enter the screen the temperature display will be blinking. You can stop this by pressing any key.

4. Activating the Jets

When the Jets pump icon is selected, all other icons on the display screen will disappear. The only two items shown are the jets pump icon and the digit temperature in °C or °F. Using the Navigational Keypad you can:

- Turn on the Jets pump by pressing the Select button.
- Turn off the Jets pump by pressing the Select button.

5. Turning on the Interior Lights

When the Lights 1 icon is selected, all other icons on the display screen will disappear. The only two items shown are the temperature and the Light 1 icon. Using the Navigational Keypad you can:

- Press Select to turn the lights on or off.
- Increase the intensity by pressing the Up button (the lights will increase in increments of 25%, ranging from 25 to 100%).
- Decrease the intensity by pressing the Down button (the lights will decrease in increments of 25%, ranging from 25 to 100%).
- Go to the previous color by pressing the Left button.
- Go to the next color by pressing the Right button.
- Turn on or off the interior lights by pressing the Select button.
- Go to the Main Menu by pressing the Return button.

6. Turning on the Interior Light Rotation Mode

When the Show 1 icon is selected, all other icons on the display screen will disappear. The only two items shown are the temperature and the Show 1 icon. Using the Navigational Keypad you can:

- Increase the intensity by pressing the Up button.
- Decrease the intensity by pressing the Down button.
- Slow down the light show speed by pressing the Left button (the lights will decrease in speed from 3, 5, 10, 18, 33, or 60 seconds).
- Speed up the light show speed by pressing the Right button (the lights will increase in speed from 60, 33, 18, 10, 5, or 3 seconds).
- Turn on or off the interior Light Rotation mode by pressing the Select button.
- Go to the Main Menu by pressing the Return button.

7. **Turning on the Exterior Lights:** Feature is not available.

8. **Turning on the Exterior Light Rotation Mode:** Feature is not available.

9. Lock Reminder

If you press any key to activate the remote and the lock icon is the only thing showing, then the spa has been locked. You must first unlock the spa from the main control panel to be able to use the remote.

B. **If your model is equipped with the J-1000 Audio System powered by JBL, the additional functions below are also controllable by your remote.**

1. AM Radio Operation

You can scan through you AM preset stations and adjust the volume with the remote. When you are in the AM radio mode the screen will appear like Figure A; then it will change to the actual station number.

AM P3



Figure A

Using the Navigational Keypad you can:

- Increase the volume by pressing the Up button.
- Decrease the volume by pressing the Down button.
- Go to the previous preset station by pressing the Left button.
- Go to the next preset station by pressing the Right button.
- Go to the FM radio settings by pressing the Select button.
- Turn off the system by pressing and holding the Select button for longer than 3 seconds.
- Go to the Main Menu by pressing the Return button.

2. FM Radio Operation

You can scan through you FM preset stations and adjust the volume with the remote. When you are in the FM radio mode the screen will appear like Figure B; then it will change to the actual station number.

FM P5



Figure B

Using the Navigational Keypad you can:

- Increase the volume by pressing the Up button.
- Decrease the volume by pressing the Down button.
- Go to the previous preset station by pressing the Left button.
- Go to the next preset station by pressing the Right button.
- Go to the AM radio settings by pressing the Select button.
- Turn off the system by pressing and holding the Select button for longer than 3 seconds.
- Go to the Main Menu by pressing the Return button.

FM 92.7⁵



Figure C

Note: Export models will show a small superscripted number after the station number (Figure C).

3. CD Operation

You can scan through the track numbers and adjust the volume with the remote. When you are in the CD mode the screen will appear like Figure D; then it will change to the track duration screen for the track.



Figure D

Using the Navigational Keypad you can:

- Increase the volume by pressing the Up button.
- Decrease the volume by pressing the Down button.
- Go to the previous track by pressing the Left button.
- Go to the next track by pressing the Right button.
- Pause or play by pressing the Select button.
- Turn off the system by pressing and holding the Select button for longer than 3 seconds.
- Go to the Main Menu by pressing the Return button.

Note: If more than 2 seconds have elapsed since the CD menu was selected and the system does not detect a CD, it will return to the Main Menu.

4. USB Folder Operation

You can scan through the folders, track numbers and adjust the volume with the remote. Using the Navigational Keypad you can:

USB

Figure E

- Increase the volume by pressing the Up button.
- Decrease the volume by pressing the Down button.
- Go to the previous track by pressing the Left button.
- Go to the next track by pressing the Right button.
- Pause or play by pressing the Select button.
- Turn off the system by pressing and holding the Select button for longer than 3 seconds.
- Go to the Main Menu by pressing the Return button.

5. USB Track Operation

You can scan through the track numbers and adjust the volume with the remote. Once you enter the screen and the track number has appeared, the screen will change to the track duration for the track.

USB

Figure F

Using the Navigational Keypad you can:

- Increase the volume by pressing the Up button.
- Decrease the volume by pressing the Down button.
- Go to the previous track by pressing the Left button.
- Go to the next track by pressing the Right button.
- Pause or play by pressing the Select button.
- Turn off the system by pressing and holding the Select button for longer than 3 seconds.
- Go to the Main Menu by pressing the Return button.

6. NAND Folder Operation

To access the NAND menu, select the USB feature and then press the Up button. You can scan through the folders, track numbers and adjust the volume with the remote. Using the Navigational Keypad you can:

- Increase the volume by pressing the Up button.
- Decrease the volume by pressing the Down button.
- Go to the previous track by pressing the Left button.
- Go to the next track by pressing the Right button.
- Pause or play by pressing the Select button.
- Turn off the system by pressing and holding the Select button for longer than 3 seconds.
- Go to the Main Menu by pressing the Return button.



Figure G

7. Auxiliary Operation

You can control the volume of an auxiliary device. Using the Navigational Keypad you can (Figure H):

- Increase the volume by pressing the Up button.
- Decrease the volume by pressing the Down button.
- Turn off the system by pressing and holding the Select button for longer than 3 seconds.
- Go to the Main Menu by pressing the Return button.



Figure H

Note: Remote control has no effect on MP3 Player playback if/when the generic MP3 cable output is used.



WARNING: RISK OF ELECTRICAL SHOCK HAZARD EXISTS AND EQUIPMENT DAMAGE!

Never install, handle or remove MP3 Player while hands are wet or while sitting partially or fully immersed.

8. iPod® Operation

You can scan through the track numbers, play or pause and adjust the volume with the remote. When you are in the iPod mode the screen will appear like Figure I; then it will change to the track duration screen for the track. Using the Navigational Keypad you can:

- Increase the volume by pressing the Up button.
- Decrease the volume by pressing the Down button.
- Go to the previous track by pressing the Left button. Go to the next track by pressing the Right button.
- Pause or play by pressing the Select button.
- Turn off the system by pressing and holding the Select button for longer than 3 seconds.
- Go to the Main Menu by pressing the Return button.

iPod
Figure I



WARNING: RISK OF ELECTRICAL SHOCK HAZARD EXISTS AND EQUIPMENT DAMAGE! Never install or remove iPod while hands are wet or while sitting partially immersed or fully immersed in spa!

9. Error has occurred

If the remote senses an error that needs attention, it will display the words “Spa” - “Err”, one word at a time, (see Figure J). The words will cycle for 1 second each. Please go to the main spa control panel for further instructions. If this error is not detected by the user within 20 seconds, the remote will go to sleep mode and the backlighting will begin to flash on and off until a key is pressed.

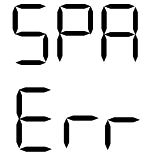

Figure J

19.12 J-1000 Wireless Remote Battery Replacement

1. Turn the remote unit over and locate the battery door (Figure A).

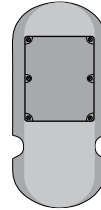

Figure A

2. Remove the six screws securing the door.

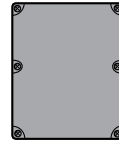

Figure B

3. Remove the battery door. You could use a small screwdriver to pry the door upward.

4. Replace or install 3 AAA batteries.

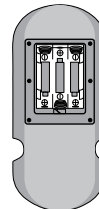

Figure C

5. Reinstall the battery door and screws.

Note: Remote unit is water resistant not waterproof, therefore the unit should be stored in a dry location within your home and never be left in the spa while the cover is on and spa is not in use.