

72" RESTAURANT RANGE



DESCRIPTION:

To be model #JSR _____ manufactured by Jade. Open top sections are to have cast iron 27,500 BTU burners with 12" x 24" cast iron grate over two burners. Griddles are to have polished 1" steel plate with 24,000 BTU burner every 12". Unit to be provided with 3/4" gas regulator.

SPECIFY BASE:

STANDARD OVEN

To have (1) or (2) conventional oven base with stainless steel lining. Oven sides and bottom to be removable without tools. Provide with one oven rack, with wires curled around main frame and chrome plated. Thermostat to adjust from 150°F to 500°F to have 35,000 BTU/hr burner per oven. Oven interior (20" W x 14" H x 24" D)(28" W x 14" H x 24" D).

CONVECTION OVEN

To have (1) or (2) convection oven base with 14 gauge stainless steel interior. Provide with one oven rack, with wires curled around main frame and chrome plated. Thermostat to adjust from 150°F to 500°F to have 30,000 BTU/hr burner. Provide with 1/3 HP 115/60/1 blower motor. Oven interior (19-3/4" W x 13-1/2" H x 20-1/2" D)(27-3/4" W x 13-1/2" H x 20-1/2" D).

CABINET BASE











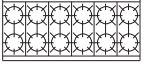
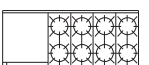
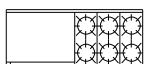
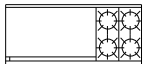

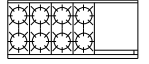
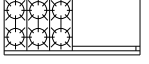
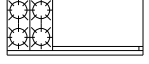
To have open cabinet base constructed of 14 gauge all welded steel.

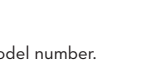
SPECIFY TYPE OF GAS WHEN ORDERING.

SPECIFY ALTITUDE WHEN ABOVE 2,000 FT.

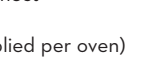
MODEL NO.

DESCRIPTION

<input type="checkbox"/> JSR-12-3636	12 OPEN BURNERS W/ 2 OVENS	
<input type="checkbox"/> JSR-12-36	12 OPEN BURNERS W/ OVEN AND CABINET BASE	
<input type="checkbox"/> JSR-24G-8-3636	24" GRIDDLE, 8 OPEN BURNERS W/ 2 OVENS	
<input type="checkbox"/> JSR-24G-8-36	24" GRIDDLE, 8 OPEN BURNERS, OVEN CABINET BASE	
<input type="checkbox"/> JSR-36G-6-3636	36" GRIDDLE, 6 OPEN BURNERS W/ 2 OVENS	
<input type="checkbox"/> JSR-36G-6-36	36" GRIDDLE, 4 OPEN BURNERS, OVEN, CABINET BASE	
<input type="checkbox"/> JSR-48G-4-3636	48" GRIDDLE, 4 OPEN BURNERS W/ 2 OVENS	
<input type="checkbox"/> JSR-48G-4-36	48" GRIDDLE, 4 OPEN BURNERS, OVEN, CABINET BASE	
<input type="checkbox"/> JSR-60G-2-3636	60" GRIDDLE, 2 OPEN BURNERS W/ 2 OVENS	
<input type="checkbox"/> JSR-60G-2-36	60" GRIDDLE, 2 OPEN BURNERS, OVEN, CABINET BASE	
<input type="checkbox"/> JSR-8-24G-3636	8 OPEN BURNERS, 24" GRIDDLE W/ 2 OVENS	
<input type="checkbox"/> JSR-8-24G-36	8 OPEN BURNERS, 24" GRIDDLE, OVEN, CABINET BASE	
<input type="checkbox"/> JSR-6-36G-3636	6 OPEN BURNERS, 36" GRIDDLE W/ 2 OVENS	
<input type="checkbox"/> JSR-6-36G-36	6 OPEN BURNERS, 36" GRIDDLE, OVEN, CABINET BASE	
<input type="checkbox"/> JSR-4-48G-3636	4 OPEN BURNERS, 48" GRIDDLE W/ 2 OVENS	
<input type="checkbox"/> JSR-4-48G-36	4 OPEN BURNERS, 48" GRIDDLE, OVEN, CABINET BASE	
<input type="checkbox"/> JSR-2-60G-3636	2 OPEN BURNERS, 60" GRIDDLE W/ 2 OVENS	
<input type="checkbox"/> JSR-2-60G-36	2 OPEN BURNERS, 60" GRIDDLE, OVEN, CABINET BASE	
<input type="checkbox"/> JSR-72G-3636	72" GRIDDLE W/ 2 OVENS	
<input type="checkbox"/> JSR-72G-36	72" GRIDDLE, OVEN, CABINET BASE	

Note: Add C to model number for one convection oven. Specify left or right location. Add two CC for two convection ovens. EXAMPLE: JSR-10-2436CC

Note: For hot top section in lieu of 2 open burners, add 1HT and delete 2 open burners from model number. For example: JSR-1HT-10-3636 (1 hot top, 8 open burners with 2 ovens).

STANDARD FEATURES

- Stainless steel front, sides, tray bed and high shelf
- 14 gauge stainless steel all welded construction
- Stainless steel removable oven interior
- One chrome plated oven rack per oven (wires curled and welded around main frame with no sharp ends)
- Oven control located in cool zone
- Stainless steel gas tubing throughout
- Stainless steel pilot tips
- 3/4" gas regulator
- Stainless steel single deck high shelf

GRIDDLE

- 1" thick highly polished steel plate
- One 24,000 BTU burner ever 12"

OPEN BURNERS

- 27,500 BTU cast iron open burner
- 12" x 24" lift-off cast iron top grates

AVAILABLE OPTIONS

- Stainless steel stub back
- Stainless steel high riser
- Thermostatic griddle control (add T to Model #)
- Grooved griddle surface (add G to Model #)
- Casters

ACCESSORIES

- 6" Casters, front two locking (5" diameter wheel)
- 36" flex hose with quick disconnect & restraining device
- 48" flex hose with quick disconnect & restraining device
- Additional oven rack (one supplied per oven)





72" RESTAURANT RANGE

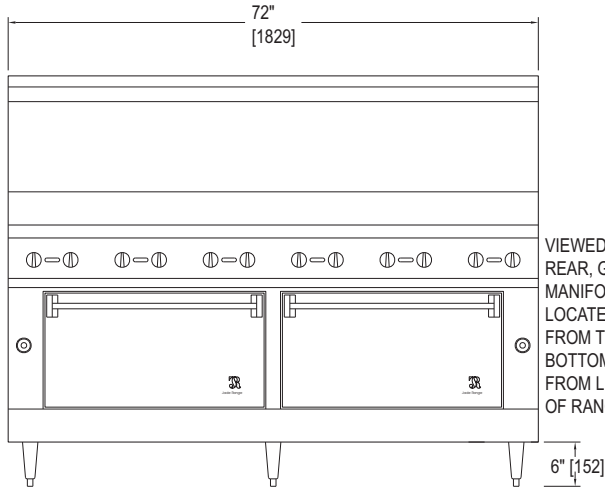

VIEWED FROM REAR, GAS MANIFOLD IS LOCATED 18" FROM THE BOTTOM AND 8" FROM LEFT END OF RANGE.

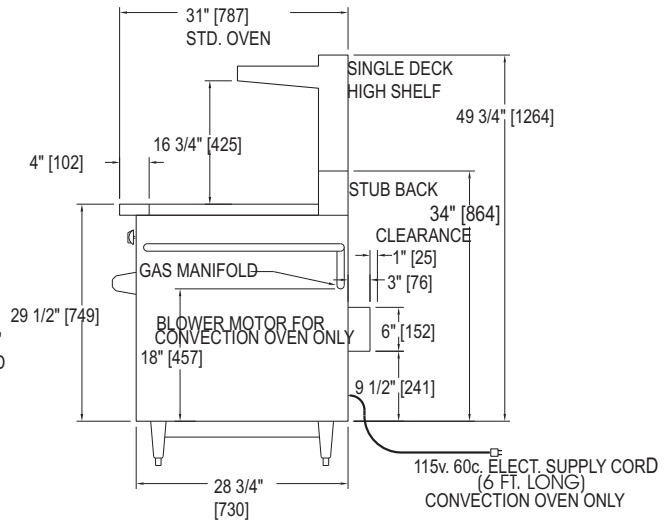

115v. 60c. ELECT. SUPPLY CORD
(6 FT. LONG)
CONVECTION OVEN ONLY

MODEL	BTUS	WIDTH	DEPTH	HEIGHT	APPX. SHP. WT.
JSR-12-3636*	390,000	72"	SEE DRAWING	SEE DRAWING	1050 LBS.
JSR-12-36*	360,000	72"	SEE DRAWING	SEE DRAWING	835 LBS.
JSR-24G-8-3636*	328,000	72"	SEE DRAWING	SEE DRAWING	1080 LBS.
JSR-24G-8-36*	298,000	72"	SEE DRAWING	SEE DRAWING	865 LBS.
JSR-36G-6-3636*	297,000	72"	SEE DRAWING	SEE DRAWING	1125 LBS.
JSR-36G-6-36*	267,000	72"	SEE DRAWING	SEE DRAWING	910 LBS.
JSR-48G-4-3636*	266,000	72"	SEE DRAWING	SEE DRAWING	1140 LBS.
JSR-48G-4-36	236,000	72"	SEE DRAWING	SEE DRAWING	925 LBS.
JSR-60G-2-3636	235,000	72"	SEE DRAWING	SEE DRAWING	1165 LBS.
JSR-60G-2-36	205,000	72"	SEE DRAWING	SEE DRAWING	950 LBS.
JSR-8-24G-3636*	328,000	72"	SEE DRAWING	SEE DRAWING	1080 LBS.
JSR-8-24G-36*	298,000	72"	SEE DRAWING	SEE DRAWING	865 LBS.
JSR-6-36G-3636*	297,000	72"	SEE DRAWING	SEE DRAWING	1125 LBS.
JSR-6-36G-36*	267,000	72"	SEE DRAWING	SEE DRAWING	910 LBS.
JSR-4-48G-3636*	266,000	72"	SEE DRAWING	SEE DRAWING	1140 LBS.
JSR-4-48G-36	236,000	72"	SEE DRAWING	SEE DRAWING	925 LBS.
JSR-2-60G-3636	235,000	72"	SEE DRAWING	SEE DRAWING	1165 LBS.
JSR-2-60G-36	205,000	72"	SEE DRAWING	SEE DRAWING	950 LBS.
JSR-72G-3636	204,000	72"	SEE DRAWING	SEE DRAWING	1200 LBS.
JSR-72G-36	174,000	72"	SEE DRAWING	SEE DRAWING	985 LBS.

Note: * 1" regulator recommended for BTU's of 250K or higher

ELECTRIC CONVECTION OVEN ONLY:

- Power Supply: 115/60/1 - 6 foot cord with 3 prong plug
- Total maximum amps 4.0/oven
- Electronic Spark Ignitor: activated by power switch, ignites standing pilot
- Fan Switch: three positions, on for normal operation, on for quick cool down, off.

NOTE: SPECIFY TYPE OF GAS WHEN ORDERING.

UTILITY INFORMATION:

- 3/4" Connection - see drawing for location
- Required operating pressure:
Natural Gas 5" W.C. minimum
Propane Gas 10" W.C. minimum
14" W.C. maximum

Note: This unit must be connected with the gas appliance regulator supplied.

WWW.JADERANGE.COM

JADE RANGE, LLC., A MIDDLEBY COMPANY • 2650 Orbiter Street • Brea, CA 92821 • PHONE: 800-884-5233 FAX: 714-961-2550
Note: In line with their policy to continually improve products, Jade reserves the right to change materials and specifications without notice. PRINTED IN USA