

**ROAD CHAMP**

JAKKS Pacific  
INC.

**FLY WHEELS**

### CONTENTS

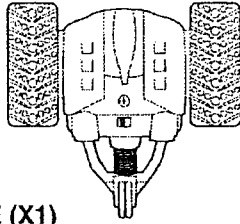

VEHICLE (X1)

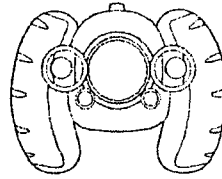

CONTROLLER (X1)



ANTENNA (X1)

### BATTERY INSTALLATION

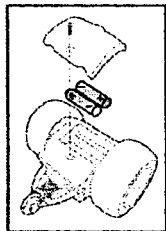

FLIP UNIT OVER AND PLACE 2 REMAINING AA BATTERIES INTO THE SECOND BATTERY COMPARTMENT.

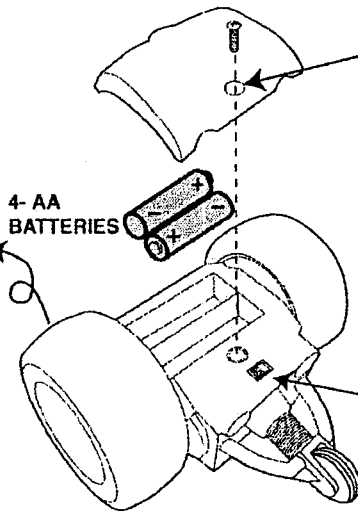

4- AA BATTERIES

HAVE AN ADULT REMOVE BATTERY COVERS WITH SCREWDRIVER (NOT INCLUDED)

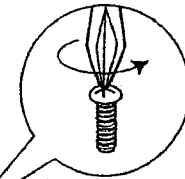

1- 9 VOLT BATTERY

ON/ OFF SWITCH

### OPERATION

THIS FLY WHEELS RADIO CONTROL VEHICLE IS POWERED BY TWO SEPARATE MOTORS WHICH CAUSE THE VEHICLE TO FLIP OVER AND REVERSE DIRECTION. WHEN VEHICLE IS FLIPPED, THE CONTROLS WILL PERFORM THE OPPOSITE FUNCTION AS SHOWN BELOW.

FORWARD

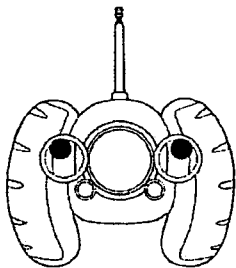

PUSH BOTH CONTROLS UP

REVERSE

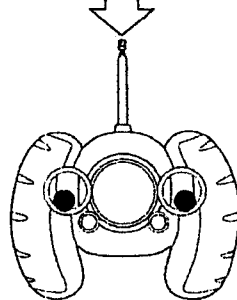

PUSH BOTH CONTROLS DOWN

SPIN LEFT

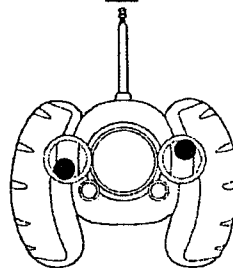

PUSH LEFT CONTROL DOWN. PUSH RIGHT CONTROL UP

SPIN RIGHT

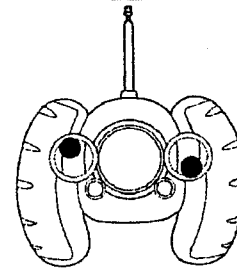

PUSH LEFT CONTROL UP. PUSH RIGHT CONTROL DOWN

VARY THE CONTROLS FOR ADDITIONAL FUN!

## WHEEL REMOVAL

TO REMOVE WHEELS PUSH AND HOLD BUTTON AND REMOVE WHEEL FROM VEHICLE BY TWISTING GENTLY COUNTER-CLOCKWISE AND PULLING. WHEEL WILL EASILY REMOVE. REPEAT FOR OPPOSITE SIDE.

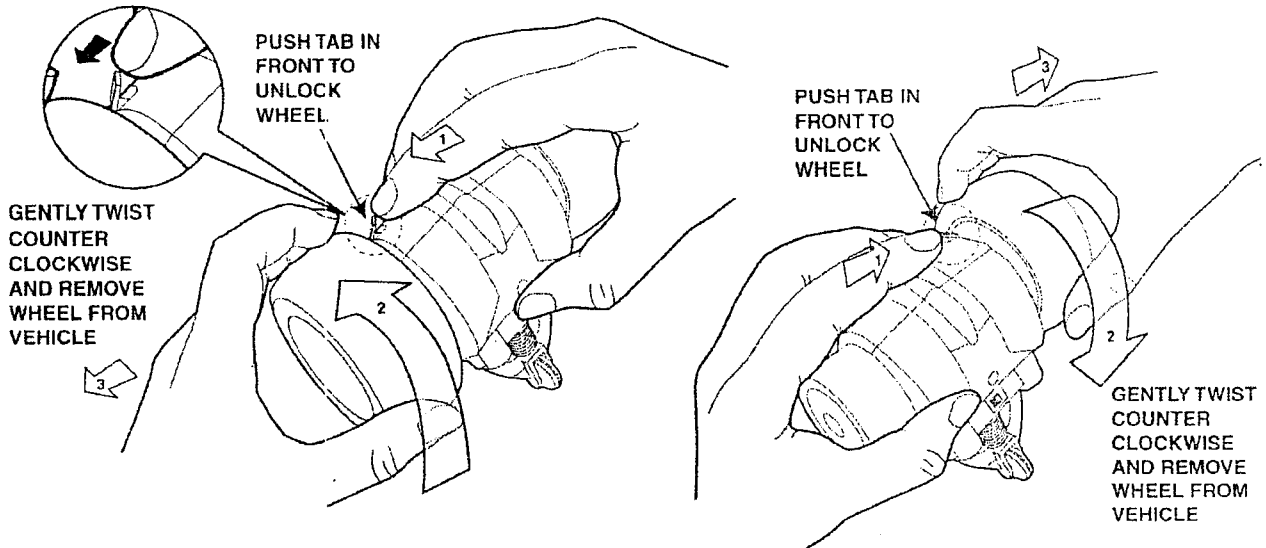

## WHEEL INSTALLATION

TO INSTALL WHEELS FIRST ALIGN TABS ON VEHICLE SIDE TO GROOVES ON INNER WHEEL HUB (SEE DIAGRAM A). INSTALL WHEEL ONTO VEHICLE AND GENTLY TWIST CLOCKWISE UNTIL IT LOCKS INTO PLACE. REPEAT FOR OPPOSITE SIDE.

DIAGRAM A

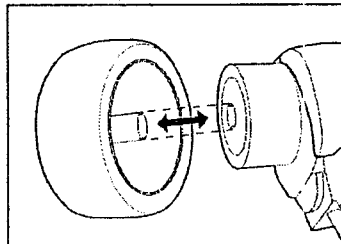

ALIGN GROOVES ON WHEEL HUB WITH TABS ON VEHICLE

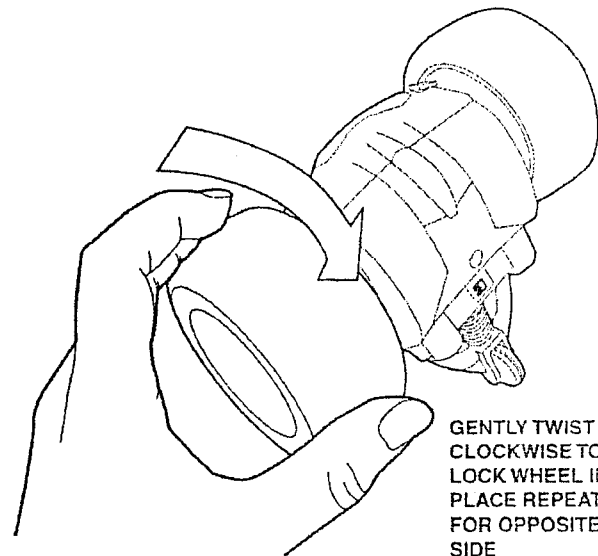
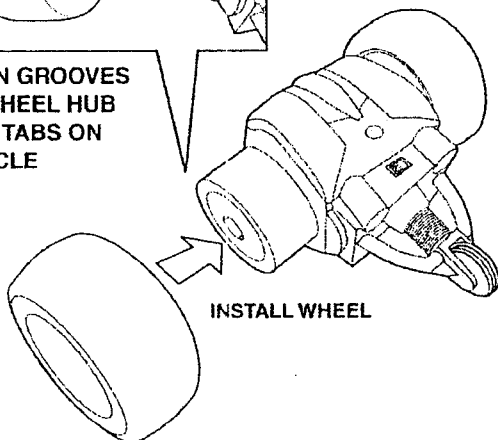

RADIO CONTROL VEHICLE IS DESIGNED TO WORK WITH ALL FLY WHEELS BRAND VEHICLE WHEELS. DIFFERENT DIAMETER WHEELS WILL AFFECT PERFORMANCE. COLLECT THEM ALL AND TRY THEM OUT!

This device complies with Part 15 of the FCC Rules. Operation is subject to the following two conditions: (1) this device may not cause harmful interference, and (2) this device must accept any interference received, including interference that may cause undesired operation.

Recommended age: 8+  
Recommended for use in outdoor areas.

ROAD CHAMPS, FLY WHEELS AND JAKKS PACIFIC ARE REGISTERED TRADEMARKS OF JAKKS PACIFIC, INC.

©2005 Road Champs, Inc., a subsidiary of JAKKS Pacific, Inc., Malibu, CA 90265 1-877-875-2557 toll free.

Printed in China.  
Patents Pending.

### FOR BEST RESULTS:

1. Be aware of Radio frequencies. Avoid operating within range of another unit using the same frequency. Radio frequency is indicated on the Package and Controller.
2. Use fresh Alkaline Batteries. Do not mix old and new batteries. If malfunction occurs, replace Batteries.
3. Keep Antennae tightly screwed into Controller. Extend Antennae to maximum length when in use.
4. Keep ON/OFF switch in "OFF" position when toy is not in use.
5. Remove Batteries when toy is not in use for extended periods of time.
6. Operate Controller within 45 feet of vehicle.
7. Keep contacts clean from rust and dust.
8. To prevent the vehicle from overheating, a protective circuit will disable the vehicle MOMENTARILY if any function is run continuously for a prolonged period of time.

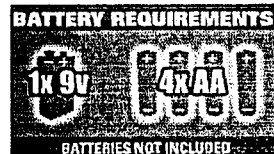

If you experience poor performance or limited reception, batteries may need to be changed.

Only adults should install and change the batteries.

- Never mix old and new batteries or different brands of batteries.
- Never mix alkaline, standard (carbon-zinc) and rechargeable (nickel-cadmium) batteries.
- Never use rechargeable batteries with this product.
- Do not dispose of batteries in fire. Batteries may leak and explode.
- Changes or modifications to this unit not expressly approved by the party responsible for compliance could void the user's authority to operate the equipment.