

MINI R.A.D.™

ROBOTIC AIR DEFENSE

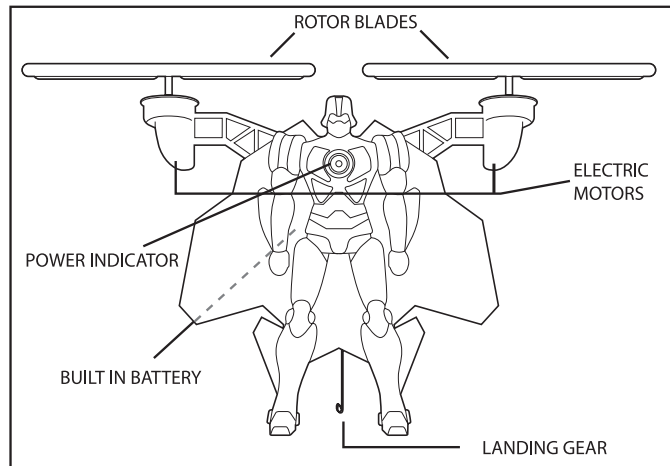

CONTENTS



XPV MINI R.A.D.™ FLYING ROBOT

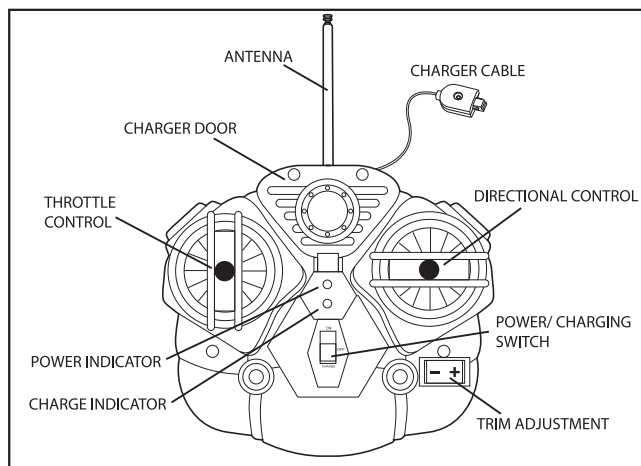

XPV MINI R.A.D.™ CONTROLLER/CHARGER

* Clear tape on XPV MINI R.A.D.™ vehicle is normal. It is used for reinforcement. DO NOT REMOVE

BATTERY INSTALLATION Only an adult should install and charge the batteries.

BATTERY INFORMATION	INCLUDED	REQUIRED
	XPV® Lithium-ion Polymer 3.7 volt rechargeable battery pack (BUILT INTO ROBOT)	6 "AA" alkaline batteries for controller (NOT INCLUDED)

INSTALL ALKALINE BATTERIES INTO CONTROLLER

1. Unscrew and remove battery cover from back of controller.
2. Install 6 "AA" alkaline batteries into controller as illustrated.
3. Replace and fasten battery cover.

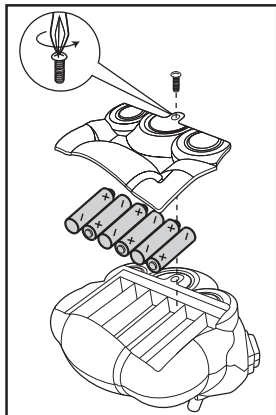

ATTACH ANTENNA

Carefully screw the antenna into top of Controller as illustrated to the right.

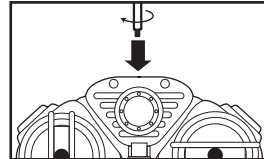

NOTE: Your XPV MINI R.A.D.™ Flying Robot has a permanently installed, rechargeable Lithium-ion polymer (LiPo) battery located in the vehicle's fuselage. Any attempt to remove the LiPo battery will permanently damage the battery and XPV MINI R.A.D.™ Flying Robot.

NOTE: For optimum flight performance, it is recommended that you replace the 6 "AA" alkaline batteries after approximately 15-20 flights.

CHARGING DIRECTIONS

The Rechargeable Battery is built into your XPV MINI R.A.D.™ Flying Robot. The battery is designed to have some stored power at all times, but will not be fully charged. Charge the battery completely before flying.

1. Turn your XPV MINI R.A.D.™ Flying Robot "ON/OFF" switch to the "OFF" position.
2. Set the Controller/Charger "ON/OFF/CHARGE" switch to the "CHARGE" position.
3. Open the charger cable door and pull out the charging cable.
4. Push the charger connector end into the XPV MINI R.A.D.™ Flying Robot charging port.
 - a. It will only fit one direction. Insert it with care so you do not damage the vehicle.
 - b. During charging, the green LED on the Controller/Charger will be on.
 - c. When done charging, the green LED will turn off.
5. Switch the Controller/Charger "ON/OFF/CHARGE" switch to the "OFF" position.
6. Remove the charger cable from the XPV MINI R.A.D.™ Flying Robot charging port, and replace the cable into the charger cable compartment and close door.

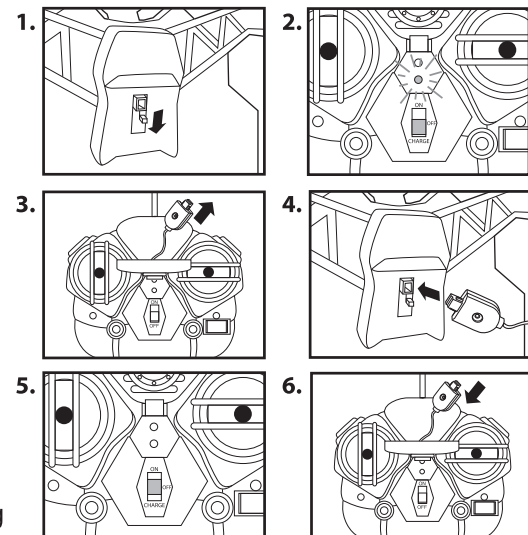

IMPORTANT: Disconnect the Controller/Charger from the vehicle when charging is finished. Failure to do so may result in damage to product.

XPV MINI R.A.D.™ FLYING ROBOT CONTROLS

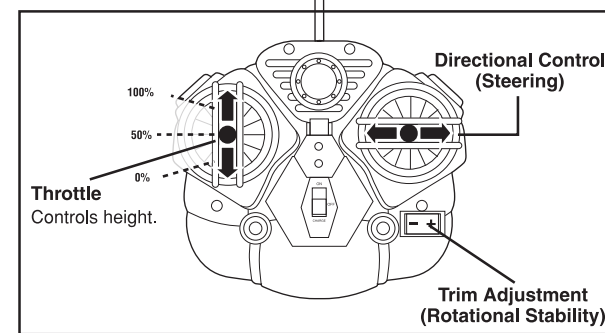

STEERING IS VERY SENSITIVE!

Use quick "flicks" of the Directional Control to steer your XPV MINI RAD™ Flying Robot either left or right. Continuous holding of the Directional Control may cause your XPV MINI RAD™ Flying Robot to over steer.

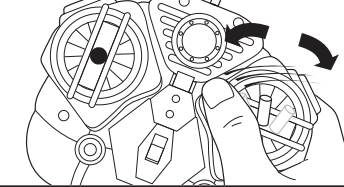

USE QUICK FLICKS TO STEER

XPV MINI R.A.D.™ FLYING ROBOT - FLYING OPERATION

PREPARATION FOR FLIGHT

1. Set the ON/OFF switch on the XPV MINI R.A.D.™ Flying Robot to ON. The Power Indicator LED in the chest will illuminate, indicating the power is on.
2. Set the ON/OFF/CHARGE switch on the controller to the ON position. The red LED will illuminate indicating the controller power is on.
3. Place the XPV MINI R.A.D.™ Flying Robot in a standing position on a flat surface. You are now ready to begin trimming and flight.

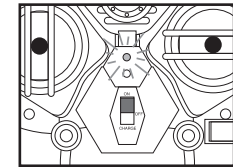

CONTROLLER ON

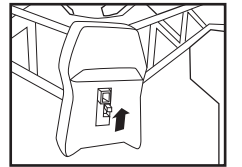

MINI R.A.D.™ ON

LIFTING OFF, HOVERING, AND LANDING

1. Push the Throttle up slowly at first to lift off the level surface.
2. With the XPV MINI R.A.D.™ Flying Robot about 3-6ft/1-2 m off the ground, vary the amount of Throttle to control its elevation. Push the Throttle gradually to increase its altitude, and decrease Throttle gradually to make it fly lower.
3. To land, slowly decrease the Throttle until the XPV MINI R.A.D.™ Flying Robot lands softly.
4. Being smooth with the Throttle Control will make the XPV MINI R.A.D.™ Flying Robot fly easier and maintain level flight.

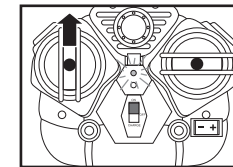

INCREASE HEIGHT

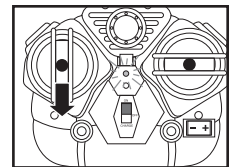

DECREASE HEIGHT

STEERING CLOCKWISE AND COUNTER CLOCKWISE

1. With the XPV MINI R.A.D.™ Flying Robot hovering above the ground, use **quick flicks** of the Directional Control to turn from side to side.
 - a. Push the Directional Control to the right to turn clockwise.
 - b. Push the Directional Control to the left to turn counter clockwise.
2. Holding the Steering control to one side can make the XPV MINI R.A.D.™ Flying Robot spiral out of control.
3. It will take practice and experience to master the controls. Keep working at it!

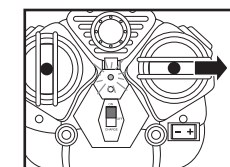

QUICK FLICKS RIGHT

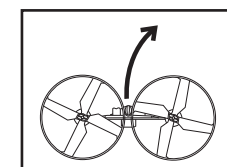

TURN RIGHT

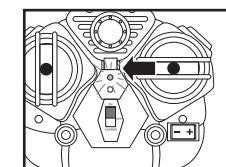

QUICK FLICKS LEFT

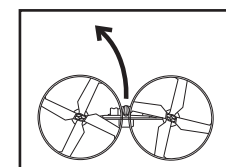

TURN LEFT

TRIMMING FOR BETTER CONTROL

The Trim Adjustment controls the rotational stability of the XPV MINI R.A.D.™ Flying Robot. Adjusting the trim helps to balance the motors and allows it to hover in one place.

1. Locate the Trim Adjustment on the Controller/Charger below the Directional Control.
2. Push the Throttle up to raise the XPV MINI R.A.D.™ Flying Robot about 3-6ft/1-2 m vertically.
3. If the XPV MINI R.A.D.™ Flying Robot spirals clockwise, push the right side of the Trim Adjustment repeatedly until the rotation stops and flies straight.
4. If the XPV MINI R.A.D.™ Flying Robot spirals counter clockwise, push the left side of the Trim Adjustment repeatedly until the rotation stops and flies straight.

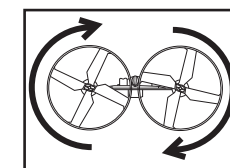

SPIRAL CLOCKWISE

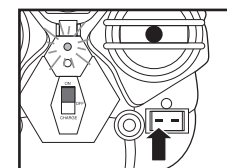

PRESS LEFT SIDE

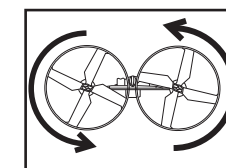

COUNTER CLOCKWISE

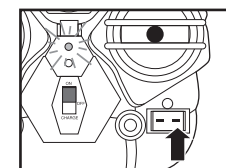

PRESS RIGHT SIDE

Visit www.XPV.com for additional information, instructions, and cool videos!

- Simple training steps
- Learn to do cool stunts
- Caring for your XPV® vehicle
- XPV® Products