

Enterprise Mobility XM75WA User Manual

For Android 6.0.1

PHONE & WLAN	FCC ID: UTWXM75WA / IC: 6914A-XM75WA
WLAN	FCC ID: UTWXM75WB / IC: 6914A-XM75WB

Note: WLCDMA/LTE feature is optional. Some product options only include WLAN feature.

User Manual

Please note your phone is battery-embedded design with removable battery and battery cover. Unauthorized personnel are strictly prohibited from disassembling the phone. Make sure to use only the power adapter (5V 2A Output AC/DC) that came with XM75WAWA.

In case your phone does not work as expected, you are strongly recommended to restart it by pressing and holding the power button for at least 12 seconds until the startup screen appears. If your phone has encountered a serious error and cannot be recovered, you should reset your phone to factory settings by using the menu, either “Backup & Reset”, or “Factory Reset”. For more details, please refer to “Factory data reset” section on page 42

Note: Please be cautious while performing the factory data reset. Because this will erase personalized settings and data saved in your phone, such as SMS, Contacts, Music, etc.



www.sar-tick.com

Body-worn Operation

This device was tested for typical body-worn operations with the Front & back of the phone kept 0.59 inches (1.5 cm) between the user's body and the Front & back of the phone.

To comply with FCC RF exposure requirements, a minimum separation distance of 0.59 inches (1.5 cm) must be maintained between the user's body and the front & back of the phone. Any beltclips, holsters, and similar accessories containing metallic components may not be used. Body-worn accessories that cannot maintain 0.59 inches (1.5 cm) separation distance between the user's body and the front & back of the phone, and have not been tested for typical body-worn operations may not comply with FCC RF exposure limits and should be avoided..



PROTECT YOUR HEARING

To prevent possible hearing damage, do not listen at high volume levels for long periods. Exercise caution when holding your device near your ear while the loudspeaker is in use.

Rev 01

Table of Contents

User Manual	1
Table of Contents	3
Getting Started.....	4
Major Parts	4
Accessory	6
Setup XM75WA	7
Charge XM75WA	10
Turn On/Off XM75WA	11
Hot swap the battery	12
Learning the basics.....	13
Use a keypad	13
Use a touch screen	15
Home Screen, Apps and Widget.....	17
Status & Notifications Icons	21
Make a call	23
Add to a contact.....	25
Send a message.....	26
Connect to your Wi-Fi network.....	28
Scanner Settings	30
Use a Scanner	30
Scan a Barcode	37
OS Update.....	39
OS Image update from a Storage.....	39
OS Image update from the FOTA.....	41
Factory data reset	43
Factory data reset from Settings.....	43
Force Factory data reset.....	45
EmKit.....	48
EmKit Secure	49
EmKit Remote.....	50
EmKit Tools.....	52

Major Parts

Getting Started



1. Barcode Scanner



2. Speaker

3. Touch Screen

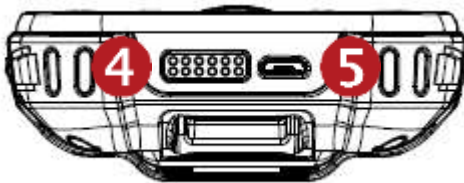

4. Pogo pin connector

5. micro USB

Major Parts

Getting Started

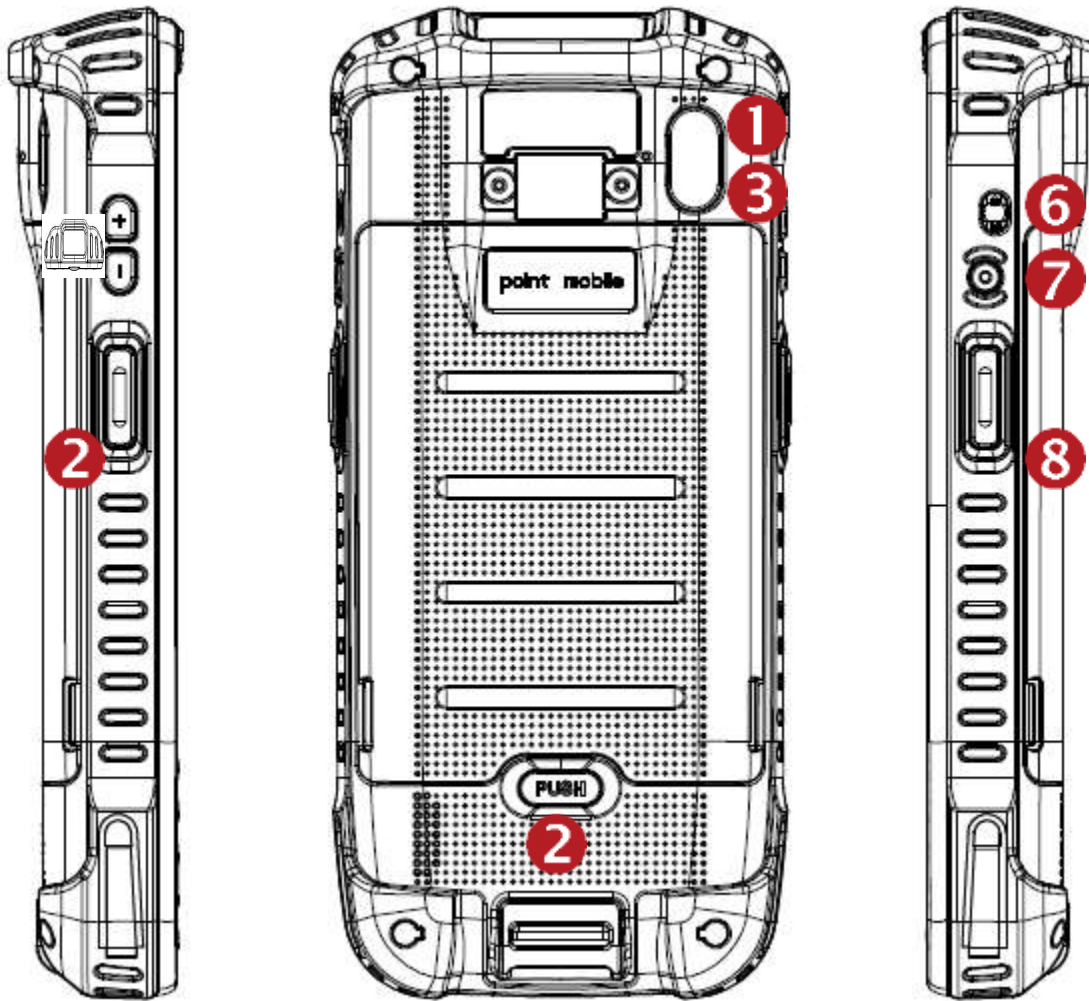

1. Volume Key
2. Scanner Trigger
3. Flash Light
4. Camera
5. Battery Cover Lock
6. 3.5mm Audio Jack
7. Power Key
8. Scan Trigger Key

Accessory

AC/DC adapter



Getting Started

Plug (US/ EU/ UK)



LCD protection film



Li-ion battery



Setup XM75WA

Getting Started

Remove the Battery Cover

1. Press “Battery Cover Lock” button
2. Pull up the Battery Cover from bottom side area

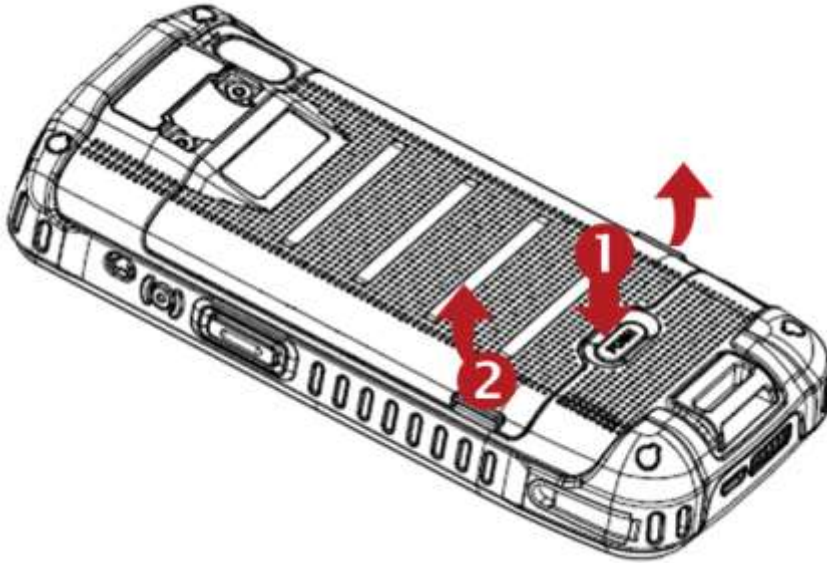

Insert SIM card

1. Insert the SIM card into the slot. (Gold plate should face down)
2. To remove the card, gently slide it out of the slot.

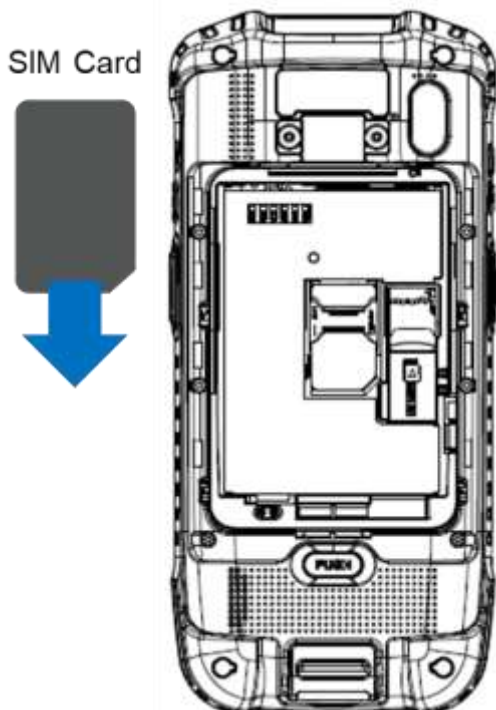

Setup XM75WA

Getting Started

Note: Your device only supports SIM cards. Do not attempt to insert other SIM types such as “Micro” and “Nano” SIM card, this may cause damage to your device. If you have to use different SIM card types, please use “SIM adaptor”.

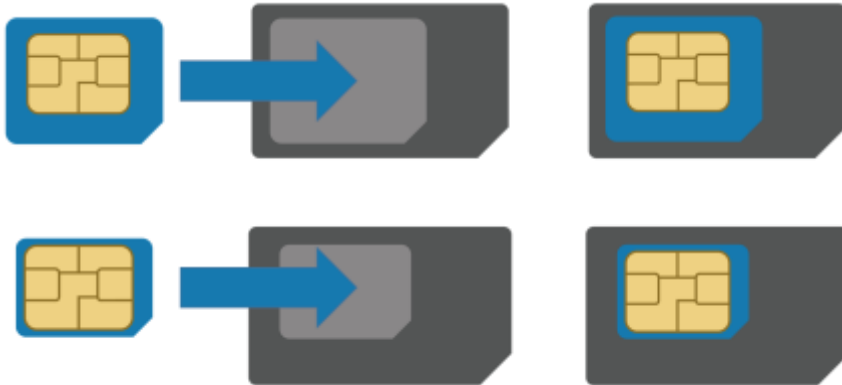

Install and Remove the microSD card

1. Insert the microSD card into the slot (Gold plate should face down).
2. To remove the microSD card, gently slide it out of the slot.

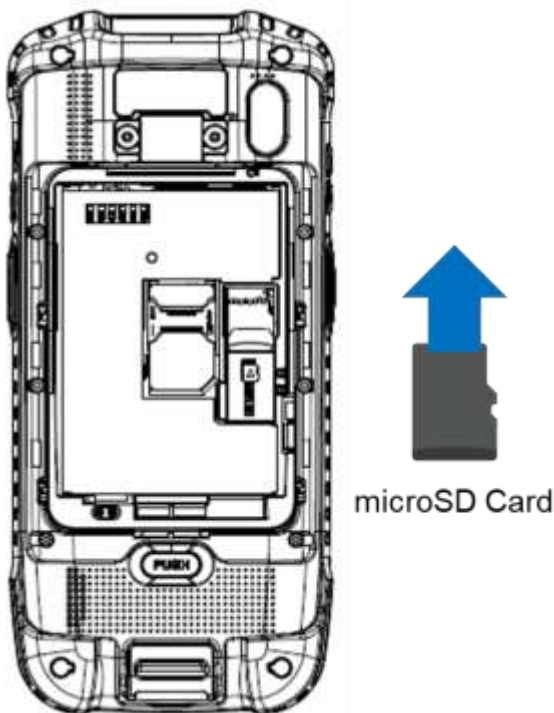

Note: To avoid data loss and SD card damage, please ensure the SD card is unmounted from Android system “**Settings – Storage - Unmount SD card**”

Setup XM75WA

Getting Started

Insert the Battery

Insert "Battery" from top area first and then put in bottom area. Make sure battery contact "Battery Connector" is properly seated.

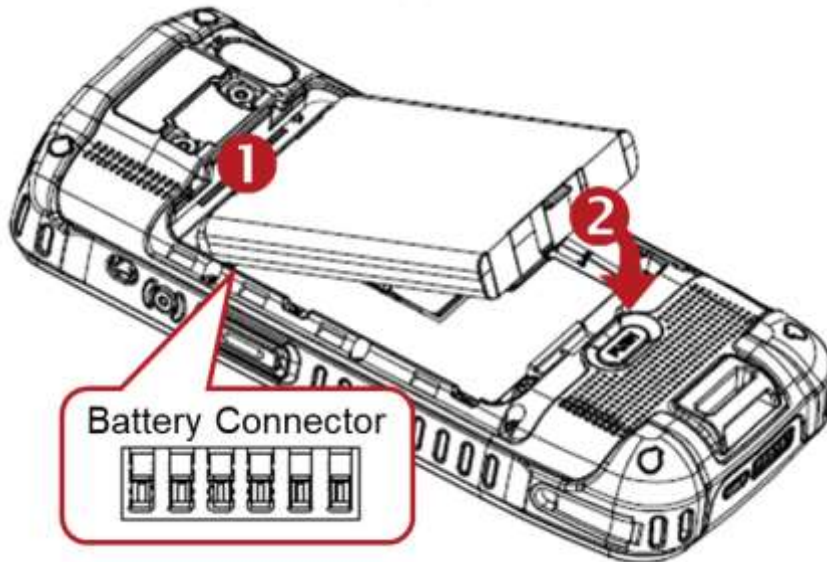

Close the Battery Cover

Insert "Battery Cover" from the top area first and then put in bottom area. Press battery cover with both hand firmly.

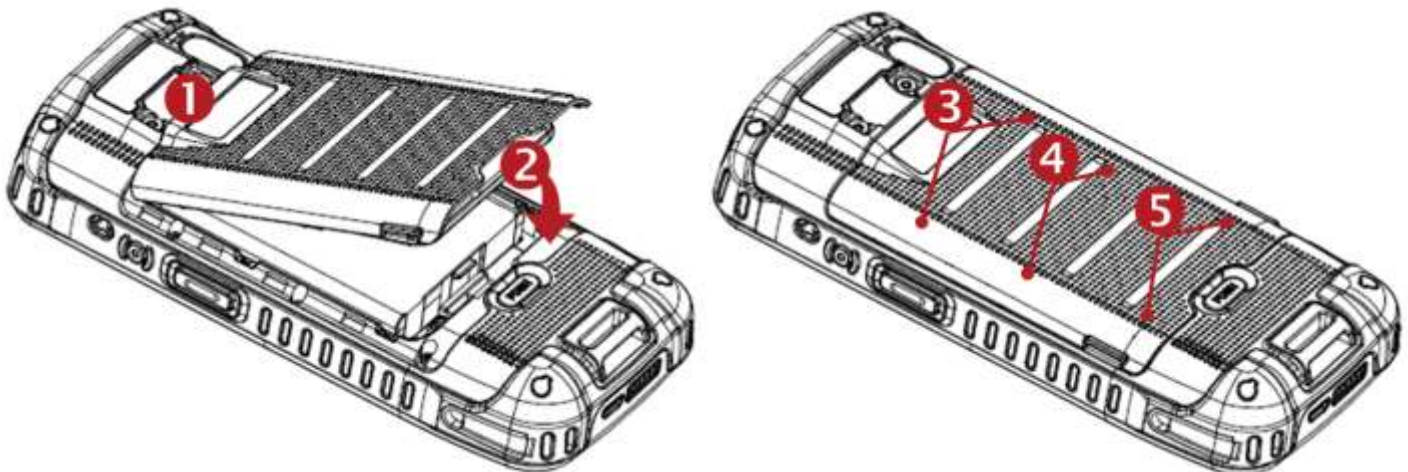

Charge XM75WA

Getting Started

1. Connect the AC/DC adaptor to your device and wall socket respectively

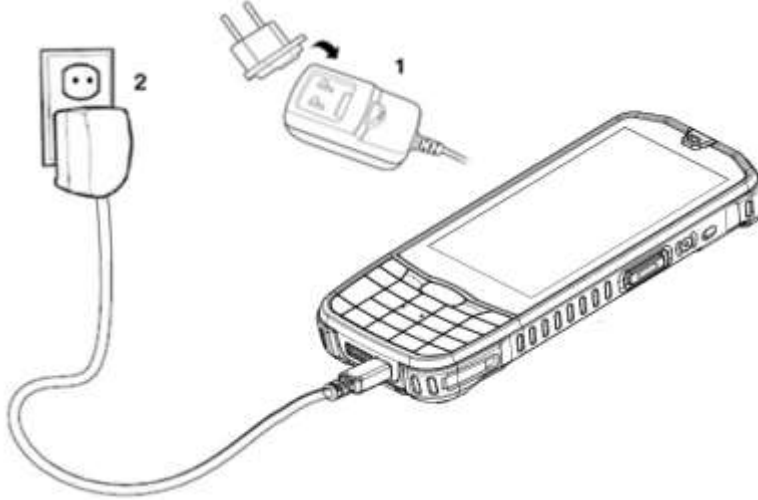

2. LED indicator will display charging status.

Steady Red	Battery is charging or Battery level is low
Blinking Red	Battery level is critical low
Steady Green	Battery is fully charged
Blinking Red and Green	Battery is removed or fail to recognize

XM75WA Battery Specification

Standard Battery	3.85V, 4,100mAh
Backup Battery	3.7V, 60mAh
Charging time	Standard Battery : About 6hours

Note: Always use an original charger and cable from Janam Technologies LLC. Other chargers and cables may damage XM75WA. In addition, make sure connector, charger, cables are not wet.

Turn On/Off XM75WA

Getting Started

Turn On

1. Press and hold down the “Power Key” for a few seconds.
2. When XM75WA enter to the boot mode, it will display “SMART BEYOND RUGGED” logo with short vibration
3. Release the “Power Key” and wait until XM75WA finish booting

Note: If you cannot turn on your XM75WA, try below steps

- To turn on XM75WA, battery needs to be charged certain level. Please charge first
- Press and hold the “Power key” for 12 seconds to force reboot
- Press and release the “Reset Hole” and then turn on XM75WA again

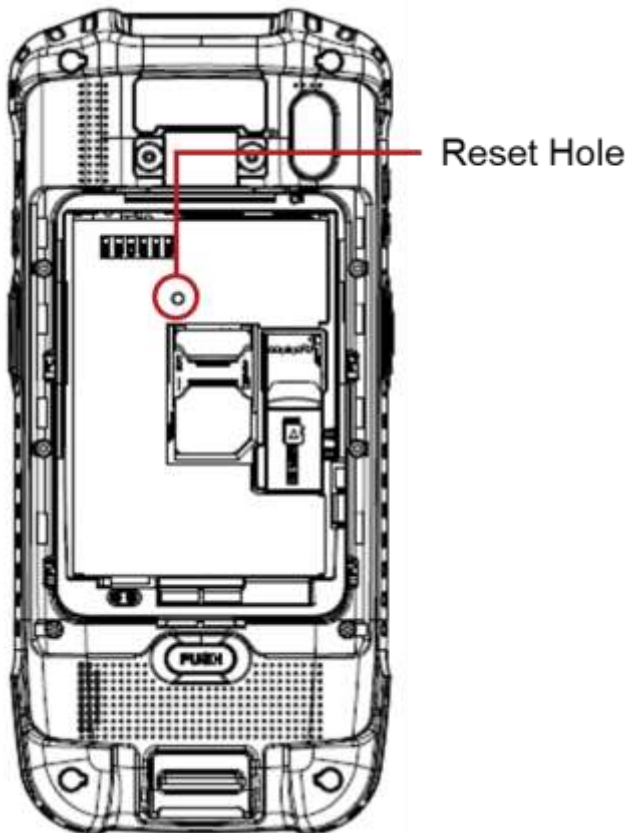

Turn Off

1. Press and hold the “Power Key” until you see the power menu
2. Among the menu, tap “Power Off”

Hot swap the battery

Getting Started

When battery level is low, you can replace the battery without turning off and on XM75WA.

- Remove the Battery and replace to another one.

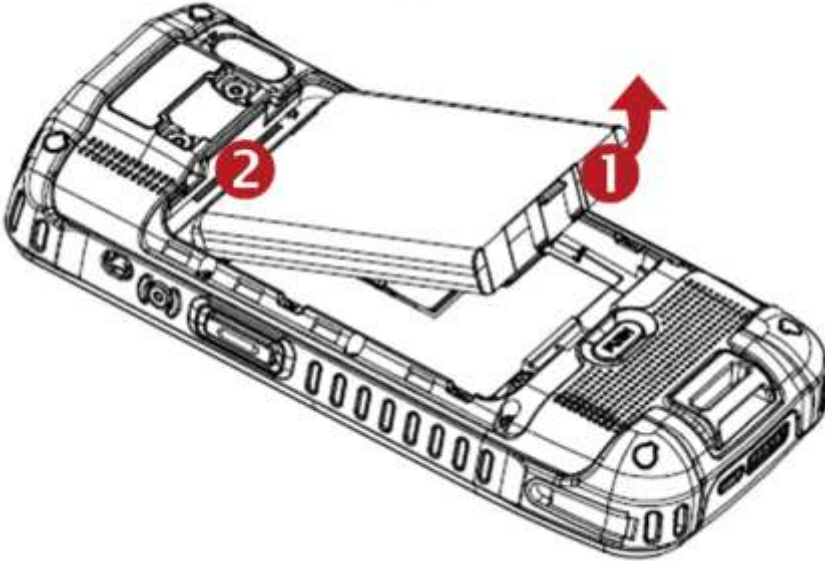

- Make sure the battery cover closed firmly.

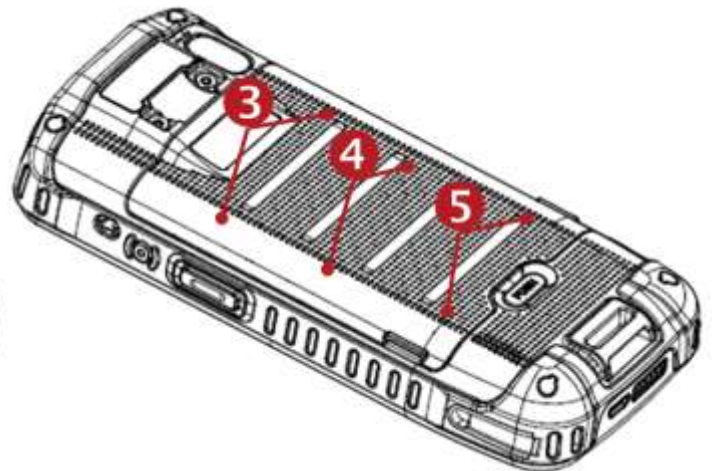
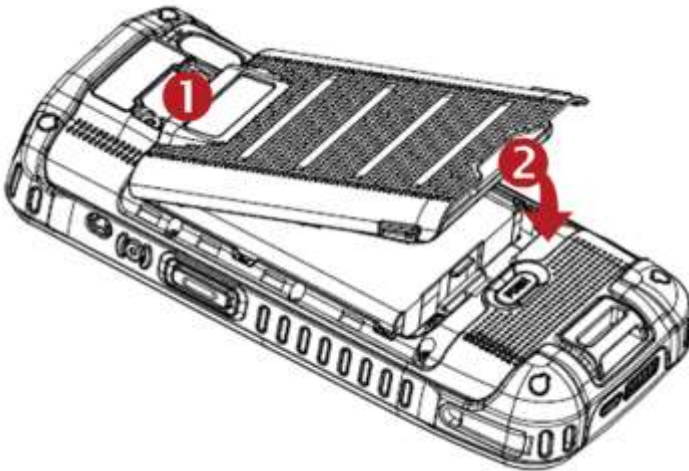

- Press the Power Key to use XM75WA again.

Use a keypad

Learning the basics

Power key

Press

- Lock the screen / Light up the screen.



Press and hold

- Display the power menu “Power Off / Reboot / Airplane mode”

Press and hold for 12seconds

- Forced to reboot

Press the “Power” key and “Volume Down” key together

- Screen capture

Volume keys

In general



- Adjusts the ringtone volume or “Mute” the ringtone of an incoming call.

In call mode

- Adjusts the earpiece or headset volume.



In Music / Video / Streaming

- Adjusts the media volume.

In camera preview

- Take the photo by pressing Volume Up or Down key.

Scanner Triggers

When “Scan Wedge” mode is activated

- By pressing, XM75WA scan the barcode.

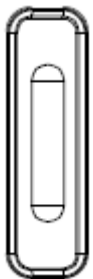

Using a keypad

Learning the basics

Front panel (Touch Key)



Recent Apps key

- Press to see recently used apps.

Home key

- From any apps or screens, press to return to the Home screen.

Back key

- Press to go back to the previous screen, or to close a dialog box, options menu, notification panel, etc.

Key Pad

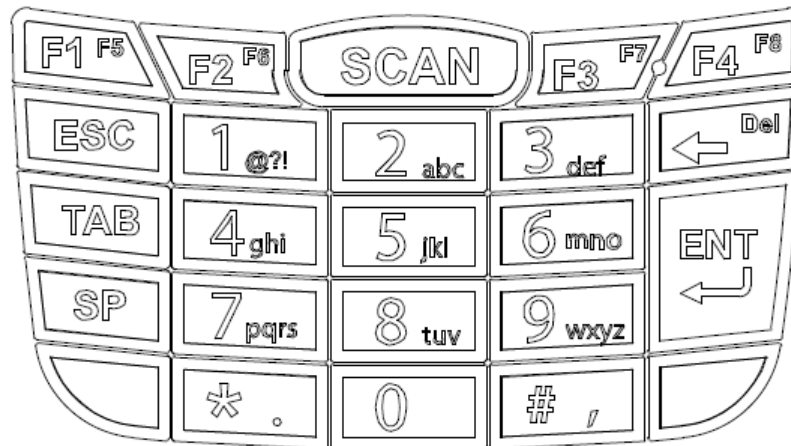

Use a touch screen

Learning the basics



Touch

One-finger press



Double touch

One-finger press, lift, one-finger press, lift for “Zoom in”



Long press

One-finger press, wait, lift for “Select an item”

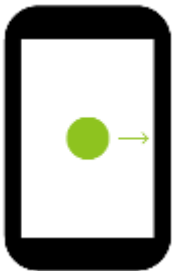

Drag, Swipe, or Fling

One-finger press, move, lift for “Scroll” or “Tilt”

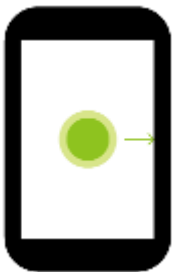

Long-press drag

One-finger press, wait, move, lift for “Pick up and move” or “select multiple items”

Use a touch screen

Learning the basics



Scroll

Vertical or horizontal swipe in a single direction

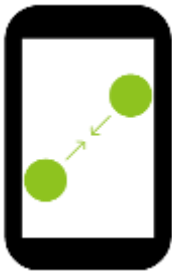

Pinch Open & Close

Two-finger press, move outwards and inwards, lift for “Zoom in and out”



Rotate

When XM75WA is turning sideways, screen orientation is changing

Home Screen, Apps and Widget

Learning the basics

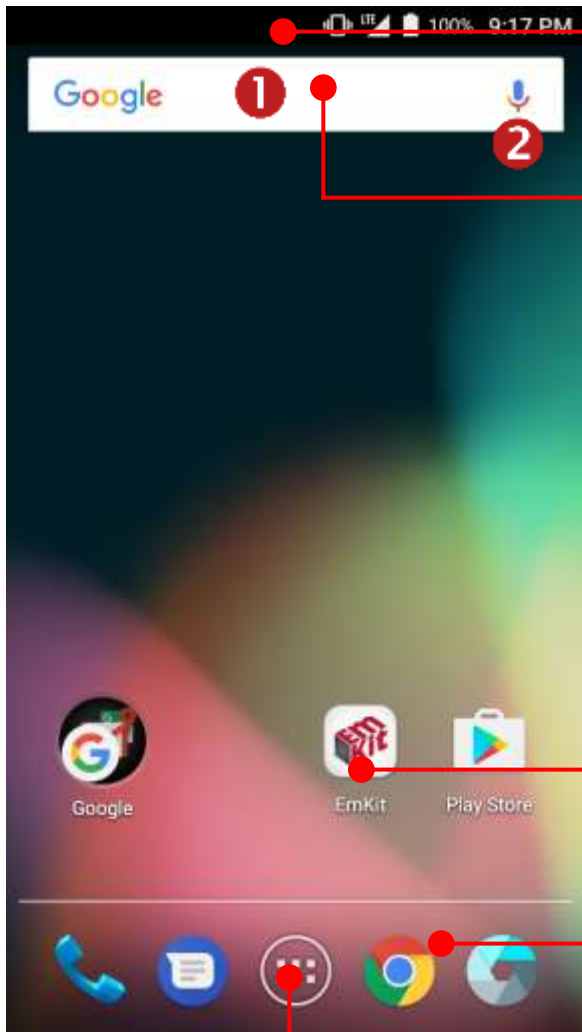

Status Bar

- Status / Notification
- Drag down to open the "Quick Setting Panel"

Search Bar

- Touch 1 to search by text
- Touch 2 to search by voice

Touch an icon to run an app, open folder, etc

Favorite tray apps

- Touch to run an app
- Touch and hold to reorganize

App Drawer

Touch to enter "Apps and Widget"

Home Screen, Apps and Widget

Learning the basics



Remove the app icon from home screen

- Long press the app icon and then drag it to the "Remove" area and then release

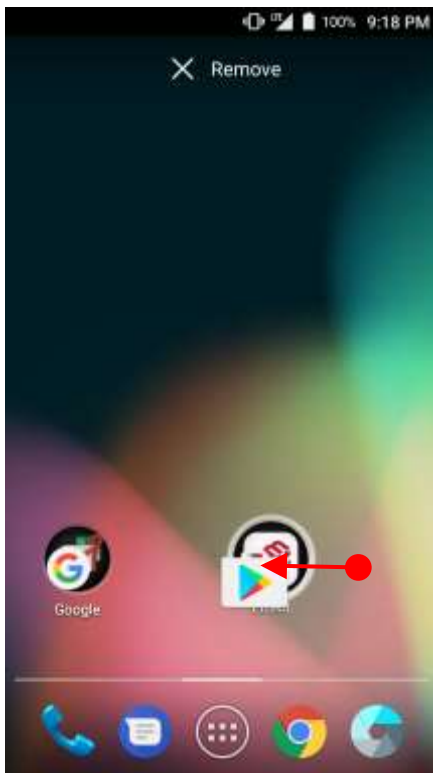

Create "App Folder"

- Long press the app icon to other app icon. This will create the "App Folder"
- To set the folder name, touch the "Unnamed Folder" and rename it

Home Screen, Apps and Widget

Learning the basics

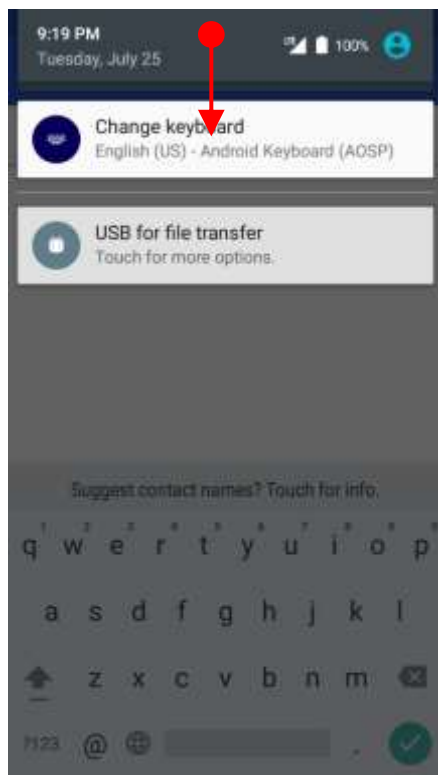

Notification panel

When there are notifications from the Android (system) or the App, you can check details by drag down the “Status Bar”.

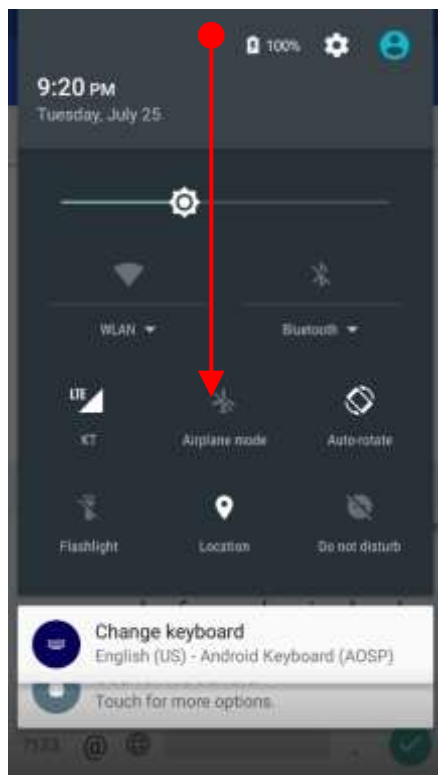



Quick setting panel

You can access “Quick setting panel” by drag down the “Notification panel”. You can enable / disable functions or change modes easily.

Home Screen, Apps and Widget

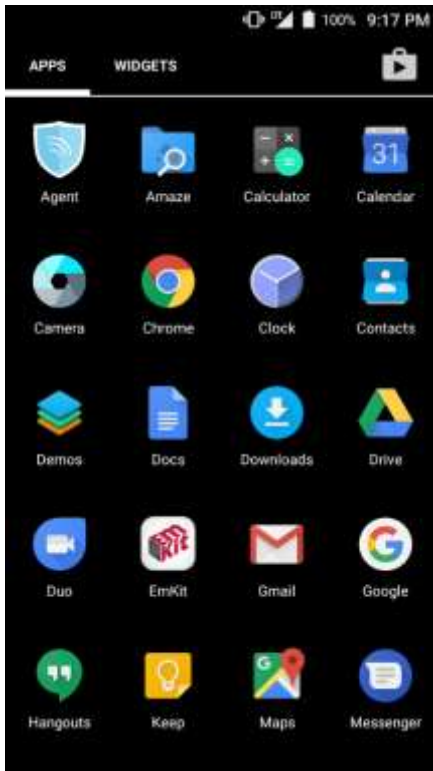
Learning the basics



By touching the “App drawer” icon,  you can enter to the “Apps” and “Widgets”

All installed apps are listed in the “Apps” tab, alphabetically

- Tap app icon to run.
- Long press, specific app icon to place to the “Home Screen”.



























All available widgets are listed in the “Widgets” tab, alphabetically.

- Long press, specific widget to place to the “Home Screen”.

Status & Notifications Icons

Learning the basics













Status icons

	3G connected		3G in use
	4G connected		4G in use
	Signal strength		No signal
	Roaming		Airplane mode
	No SIM card installed		
	WLAN is on		Connected to a WLAN network
	Bluetooth is on		Connected to a Bluetooth device
	Battery is full		Battery is partially drained
	Battery is low		Battery is very low
	Battery is charging		
	GPS is on		Alarm is set
	Speaker phone is on		Headset connected
	Vibrate mode/ Mute		Phone mic is mute

Status & Notifications Icons

Learning the basics

Notification icons

	Missed call		New SMS or MMS message
	New Email		Connected to VPN network
	Upcoming event		Screenshot captured
	Preparing SD card		SD card removed, unexpectedly
	OTG device connected		
	File uploaded		File downloaded
	There are more notification		Other input method available

Make a call

Learning the basics

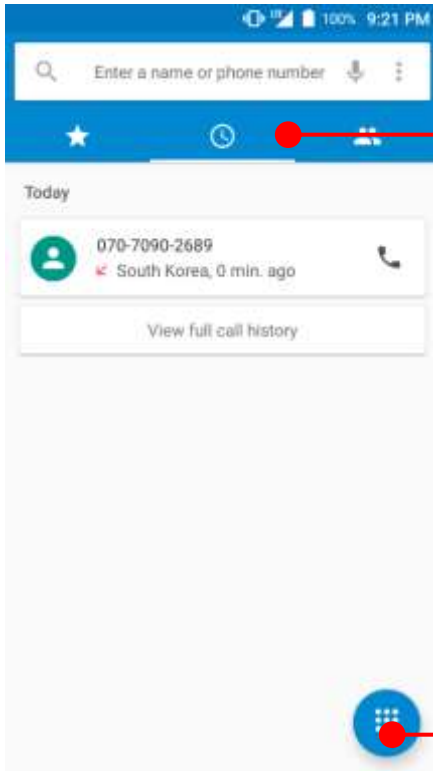

Touch  icon in the Favorite tray apps

Slide to access the “FAVORITE”, “RECENTS” and “CONTACTS”.

- To make a call from recent call list or missed call, select “RECENTS” tab
- To make a call from your contact list, select “CONTACTS”

Touch to use a dialer

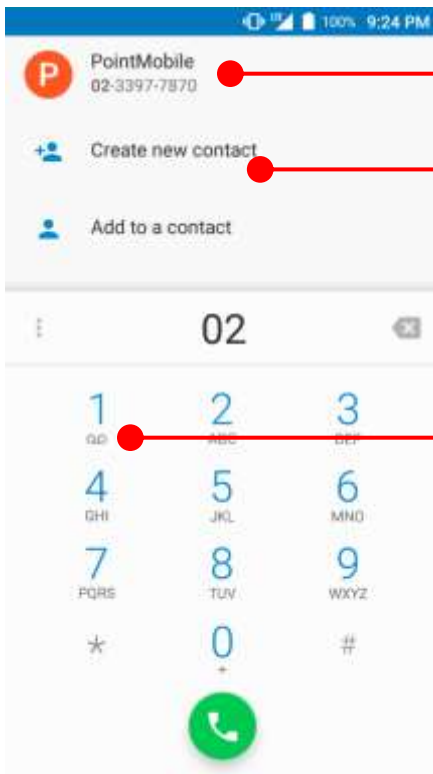

Suggested phone number(s)

Phone number can be saved to “CONTACTS”

Touch and hold the dial pad #1, to access voicemail.

Make a call

Learning the basics

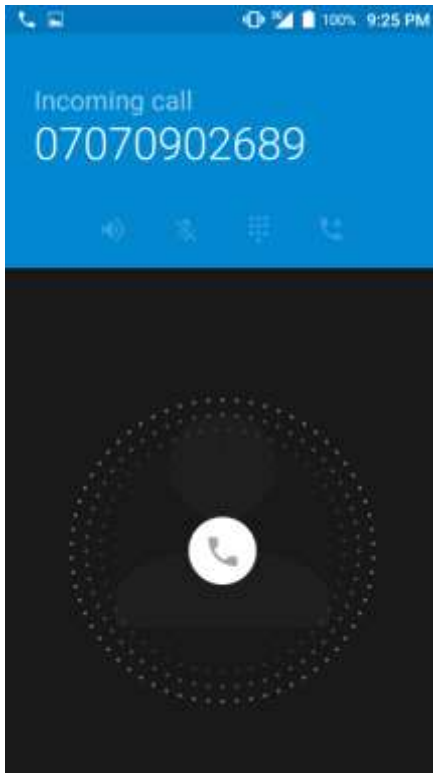

You can answer or rejecting a call by sliding the phone icon

Slide the  icon to the right direction in order to answer the call

Slide the  icon to the left direction in order to reject the call



Slide the  icon upwards to reject the call and send a preset message to the caller.

Tip: To mute the ringtone volume of an incoming call, keep press the “Volume down” key or turn your XM75WA over.

Add to a contact

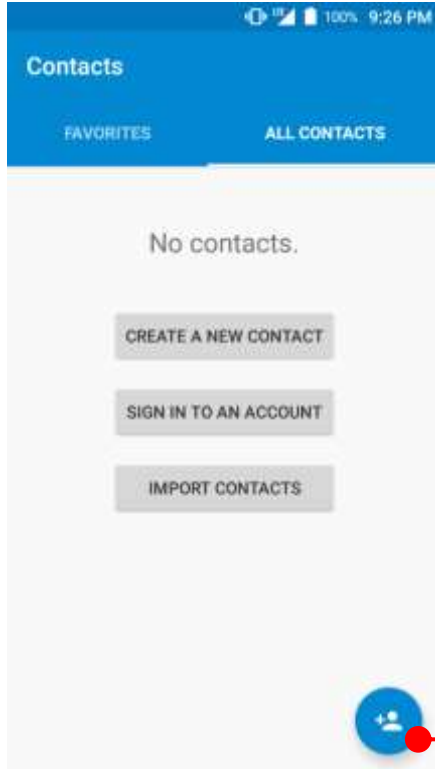
Learning the basics



Touch  "App Drawer" icon and then  icon

CREATE A NEW CONTACT

- You can manually create the new contact

SIGN IN TO AN ACCOUNT

- You can sync with your contacts in the Google account.

IMPORT CONTACTS

- You can import contact in the storage (.vcf file) or SIM card

Touch to add a new contact

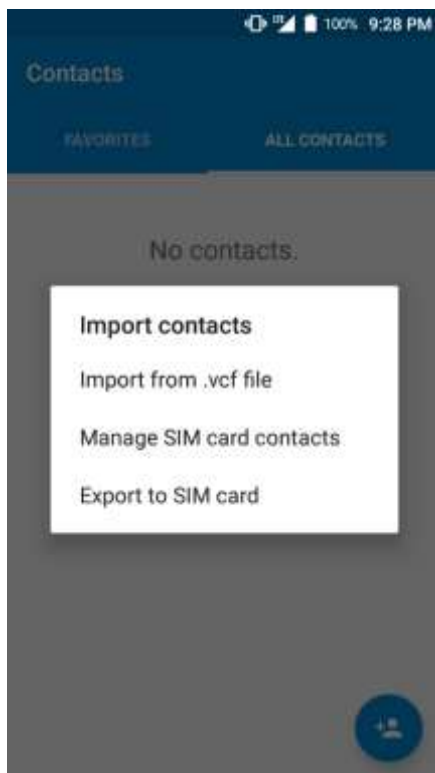

Send a message

Learning the basics

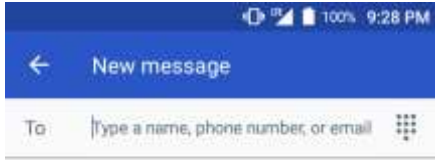

Touch  icon in the Favorite tray apps

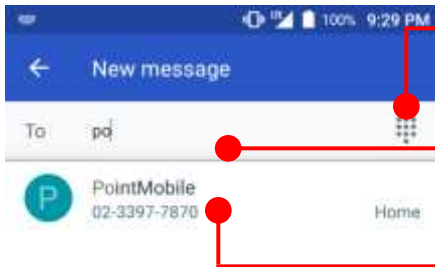

Touch to use a dialer

Touch to type a name, phone number or email

Suggest contact display here. Touch “Contacts” to compose a message



Send a message

Learning the basics

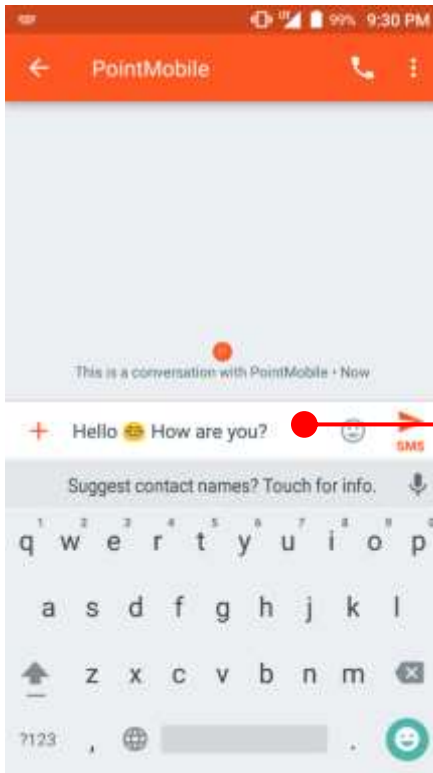

Your message display here

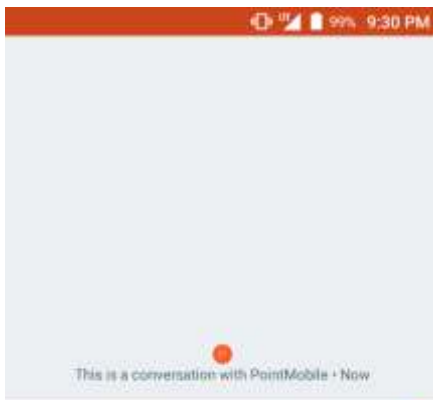

Touch to send the composed message

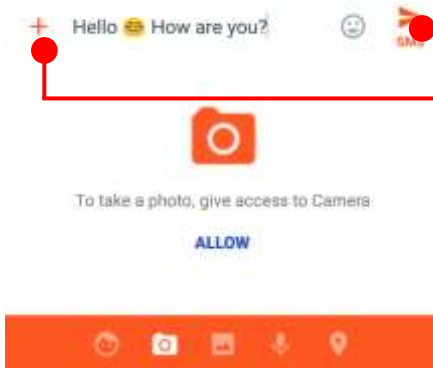



You can attach photo, saved picture, voice or location

Note: You may allow granting “Message App” access specific app or service.

Connect to your Wi-Fi network

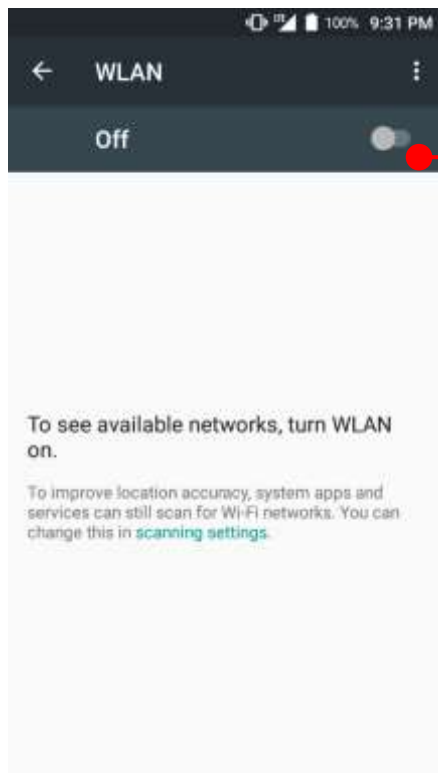
Learning the basics



Touch  "App Drawer" -  "Settings" and then "WLAN"
 Touch to turn On / Off the W-Fi



You can see nearby Wi-Fi network. Each AP's SSID information listed by signal strength



Icon means: Open Wi-Fi network. You don't need to enter the password



Icon means: Secured Wi-Fi network. To connect this Wi-Fi, you need to enter the password

Connect to your Wi-Fi network

Learning the basics

Touch SSID, which you want to connect.
To connect to secured network, enter the password

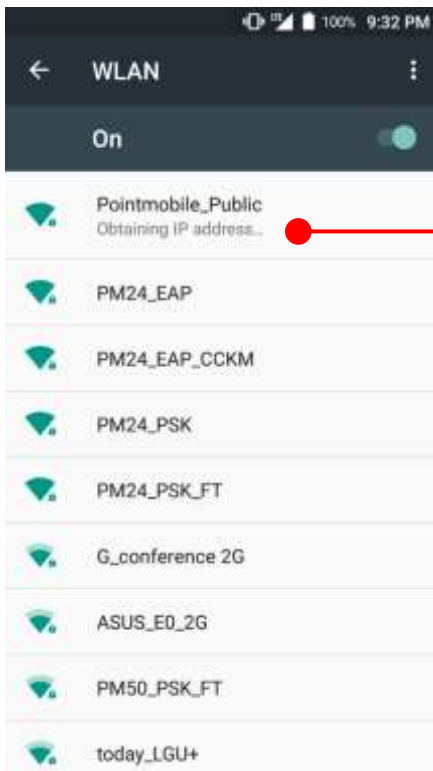
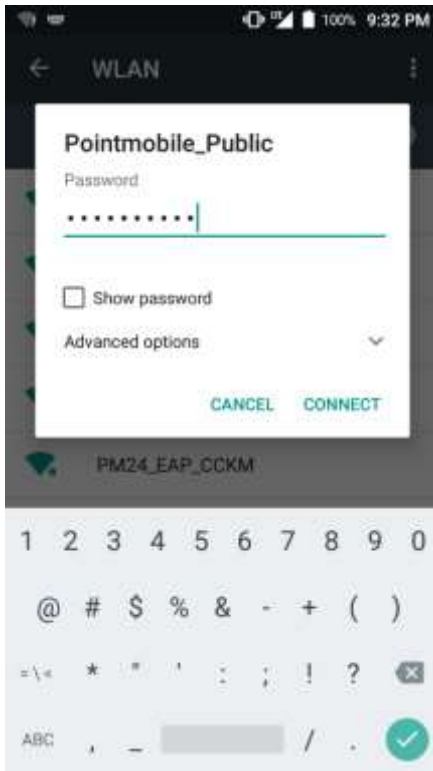



Your XM75WA is obtaining the IP address from selected AP

Use a Scanner

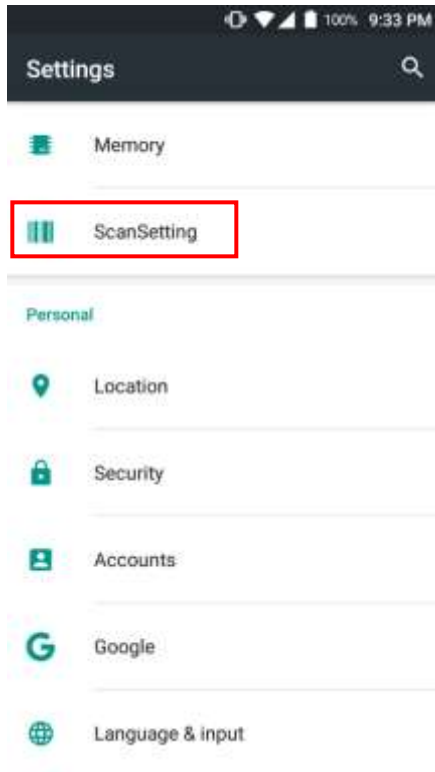
Scanner Settings



Default setting of Scanner is “Off”
To use the Scanner,

- Touch  EmKit and then “ScanSetting”
- Touch  “App Drawer” -  “Settings” and then “ScanSettings”



Touch to turn on the Scanner

Use a Scanner

Scanner Settings

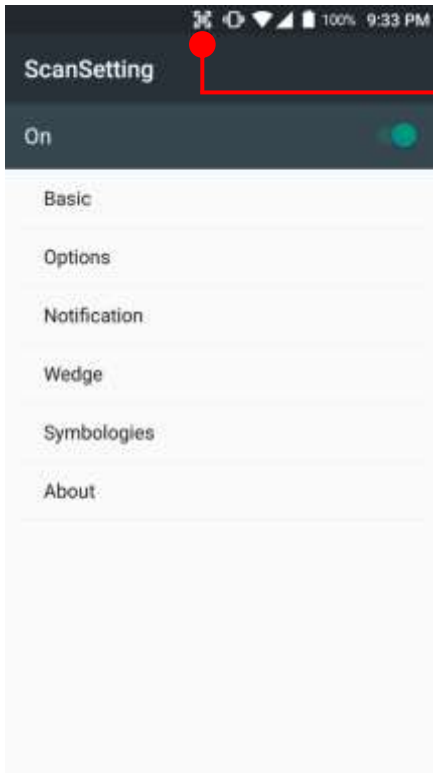

Now you can see "Scanner" icon in the "Status Bar"

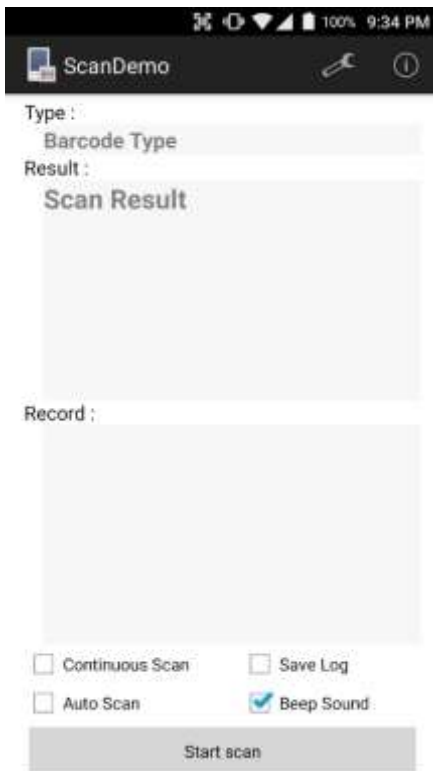

Note: When "Scanner" turned on, you can scan the barcode with "ScanDemo" in the EmKit

Use a Scanner

Scanner Settings

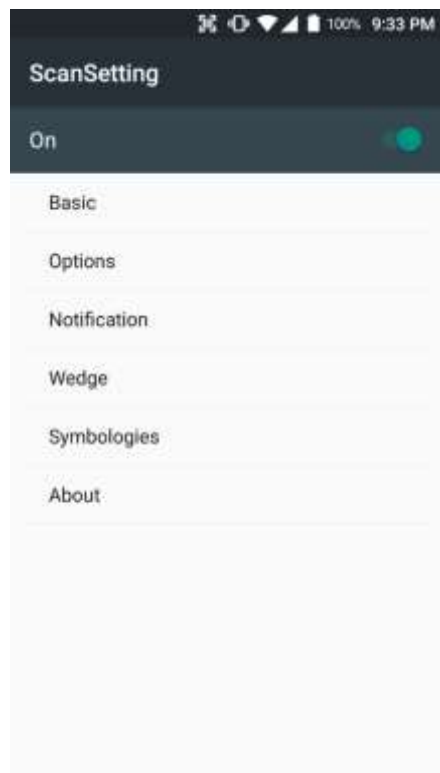

Scanner setting details

Scanner setting consist with “Basic”, “Options”, “Notification”, “Wedge”, “Symbologies”, and “About”

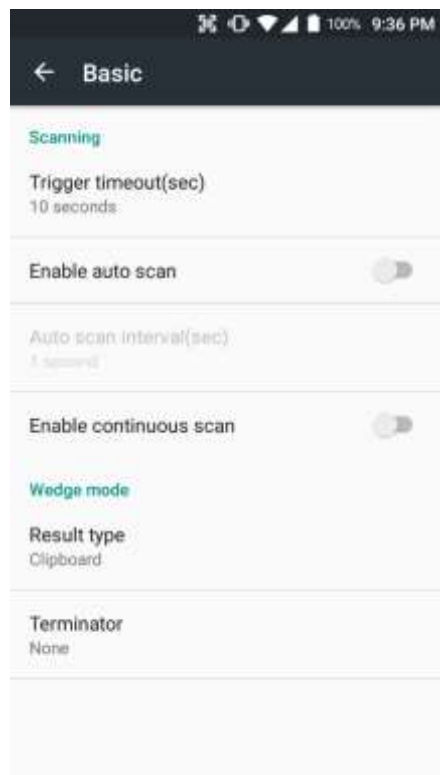

In the “Basic”, you can set “Scanning” option and “Wedge” mode option

In the “Scanning menu”, you can change Scanner’s trigger time out and set “Auto scan” & “Continues scan”

In the Wedge menu you can change, decode scan data’s result type handling “User Message”, “Keyboard Event”, “Clipboard” or ‘Intent Broadcast’. Also you can set “Terminator” – “Space”, “Tab”, “LF” or “Tab & LF”

Use a Scanner

Scanner Settings

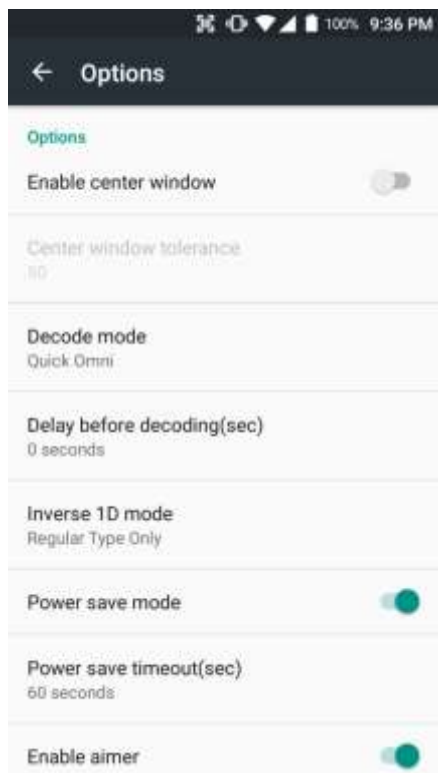

In the “Options”, you can enable / disable the “Center Window”, set “Decode mode”, “Power save mode” and enable / disable “Aimer” & “Illumination”

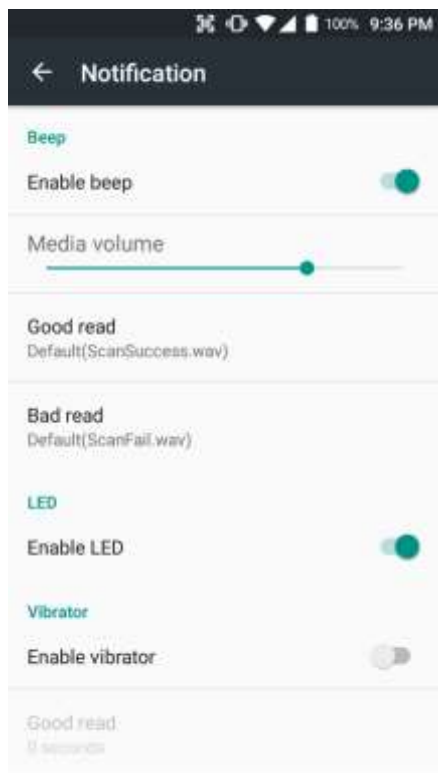

In the “Notification”, you can set notification option. You can change the volume level, notification sound, LED and vibration option

Use a Scanner

Scanner Settings

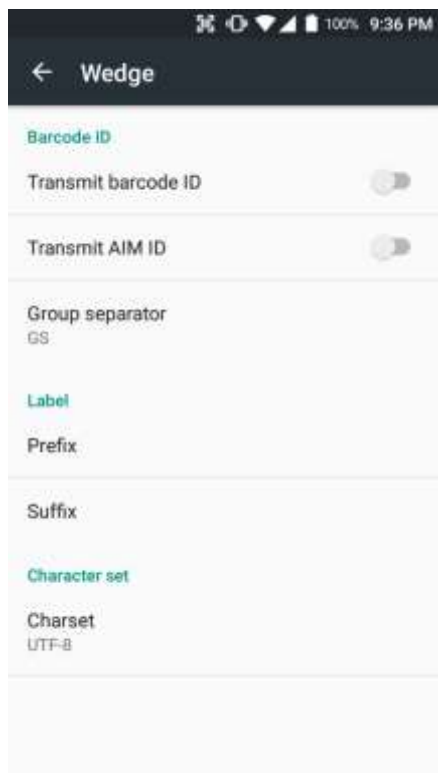

In the “Wedge”, you can enable / disable “Barcode ID” and “AIM ID”, set “Group separator”, “Prefix” & “Suffix” and “Character set”

Use a Scanner

Scanner Settings



In the “Symbologies”, you can enable / disable specific barcode.

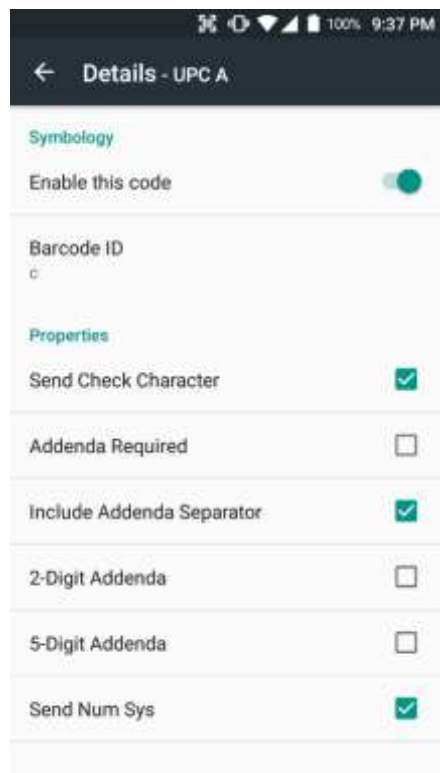

By touching each “Symbology” name, you can set detail option.

Use a Scanner

Scanner Settings

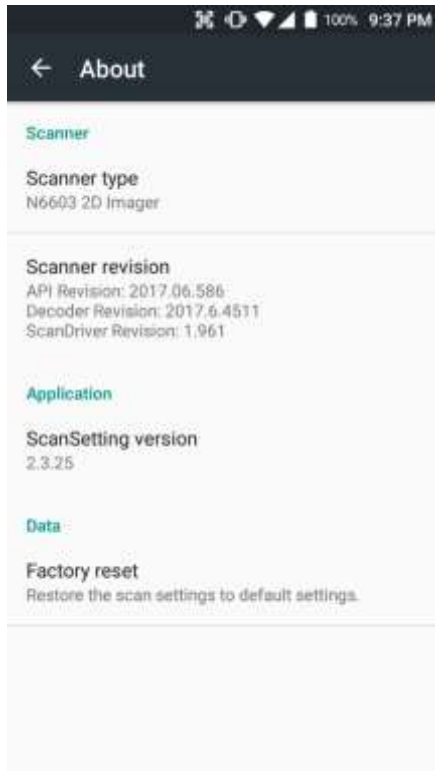

In the 'About', you can check your Scanner's information and restore Scanner's settings to default

Scan a Barcode

Scanner Settings

Example of good Barcode reading



Idle barcode scan
Please aim the middle of barcode



Even you aim the barcode slightly upper or down area or angle is tilted, you can read the barcode



Scan a Barcode

Scanner Settings

Example of bad Barcode reading



If you aim the barcode wrong direction or tilt too much, you can't read the barcode



If you aim part of Barcode or aim two barcode together, you can't read the barcode



OS Image update from a Storage

OS Update

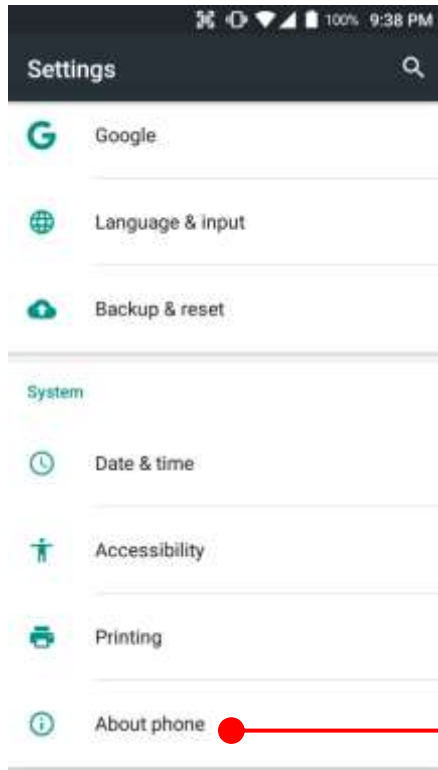

To update OS image, copy or place OS image file into the root folder of “Internal Storage” or “External Storage”

Touch  “App Drawer” -  “Settings” and then “About phone”



Touch “System Updates”

OS Image update from a Storage

OS Update

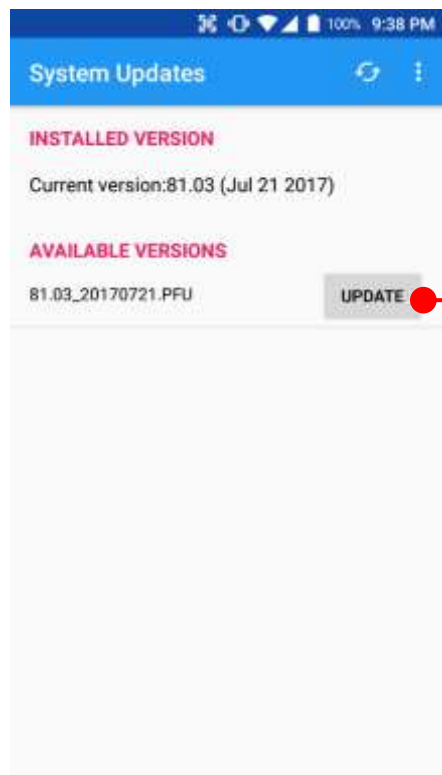

Your XM75WA will check storage and display available OS image

Touch "Update" button

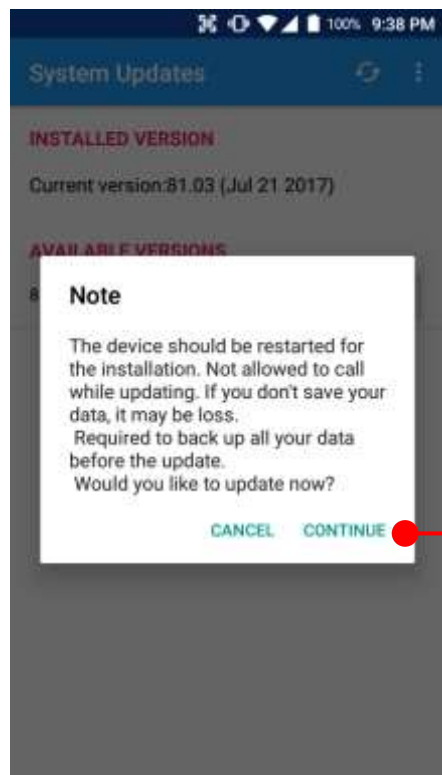

By touching the "CONTINUE" button, your XM75WA start to update the OS image. During this time, you cannot use your XM75WA. Please save the data before start, the OS update process.

OS Image update from the FOTA

OS Update

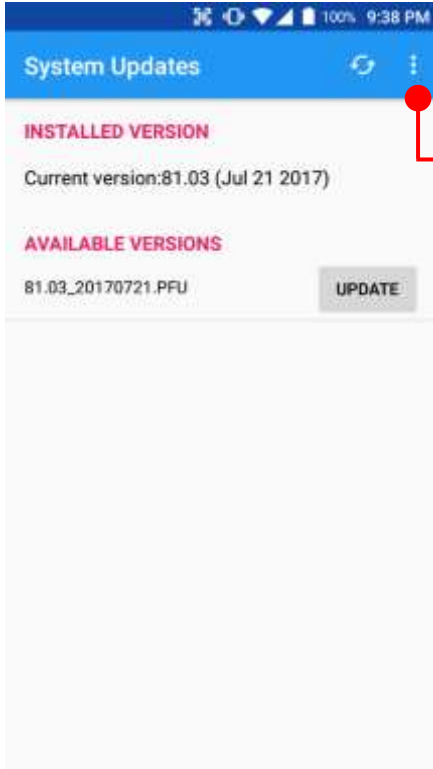

Tap  icon for the advanced option

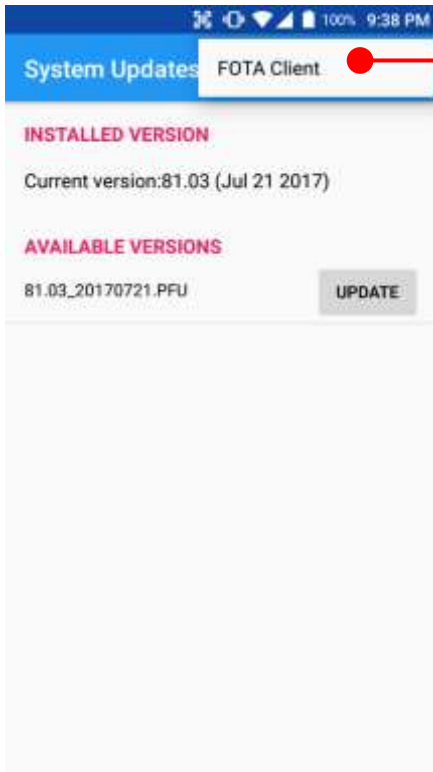

Touch "FOTA Client"

OS Image update from the FOTA

OS Update

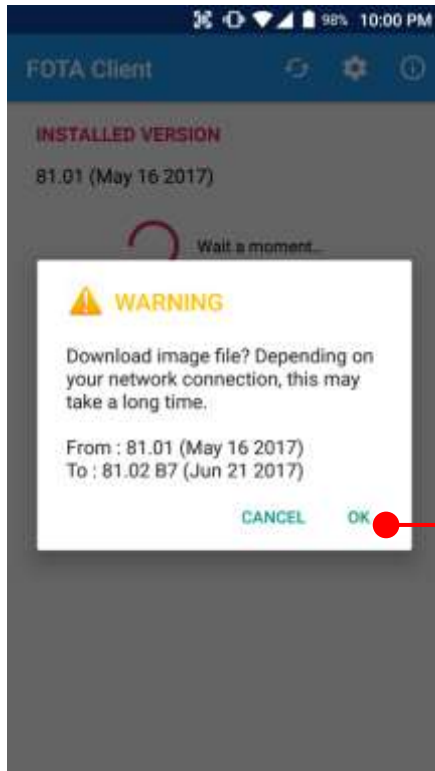

XM75WA will compare the OS image between FOTA server and current OS image. If there is newer OS image in the FOTA server, FOTA server will suggest downloading.

Touch "OK" to start download the image in the FOTA server

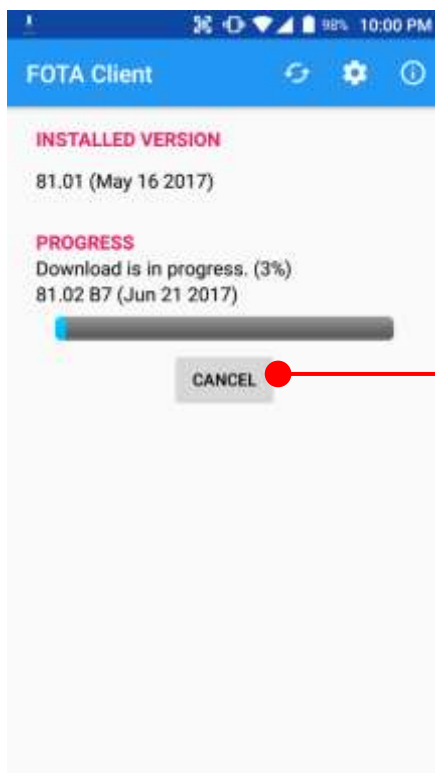

You can cancel OS image download process

Note: Default OS image download setting of FOTA Client is "Download over Wi-Fi only" Please connect to the nearby Wi-Fi network for FOTA service

Factory data reset from Settings

Factory data reset

When your XM75WA system is unstable and abnormal behavior occur but could not recover by rebooting, you may need to “Factory data reset” your XM75WA

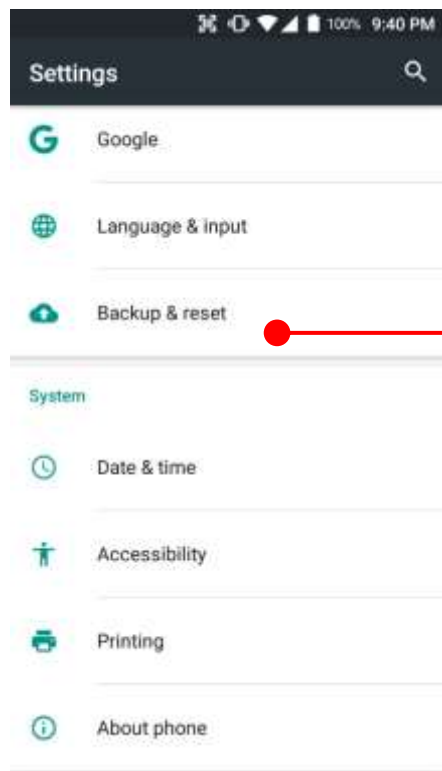

Touch  “App Drawer” -  “Settings” and then “Backup & reset”

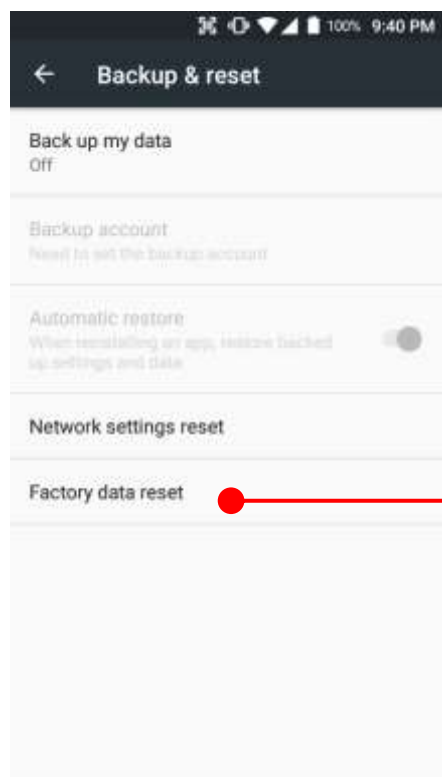

Touch “Factory data reset”

Factory data reset from Settings

Factory data reset

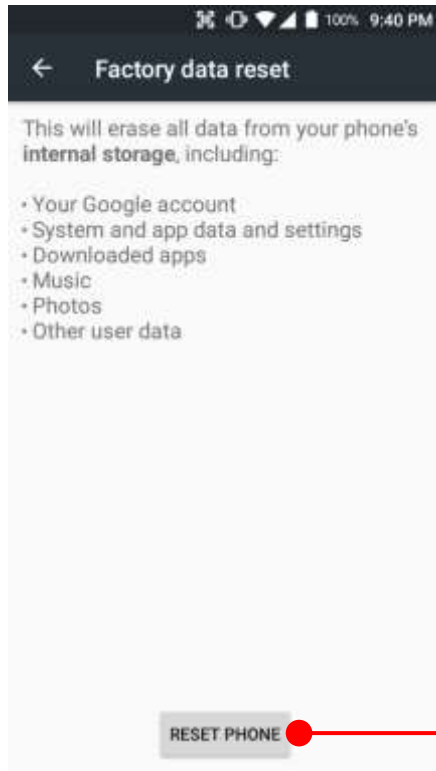

Please note, all apps and data in the internal storage will be deleted and restored to "Factory default" and this process cannot "Undo"

Touch to start "Factory Reset" process

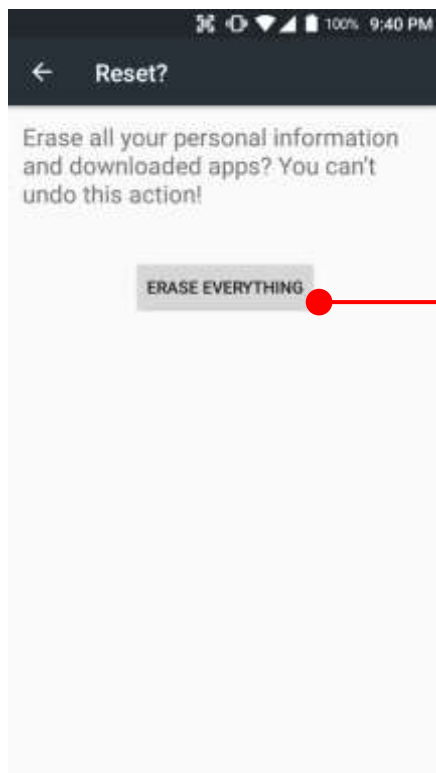

Touch to confirm erase of "Apps and Data"

Force Factory data reset

Factory data reset



Force Factory data reset your XM75WA

You can perform “force” factory data reset your XM75WA. When your XM75WA turned off, press “Power” + “Volume up” + “Home” button all together. After short vibration from your XM75WA, you may release the buttons.



XM75WA enter to the “Android Recovery” mode. In this mode, “Volume up” is “Move Up” in the menu tree and “Volume down” is “Move Down” in the menu tree. “Power Button” is “Select”

Force Factory data reset

Factory data reset



Select "Wipe data/factory reset"

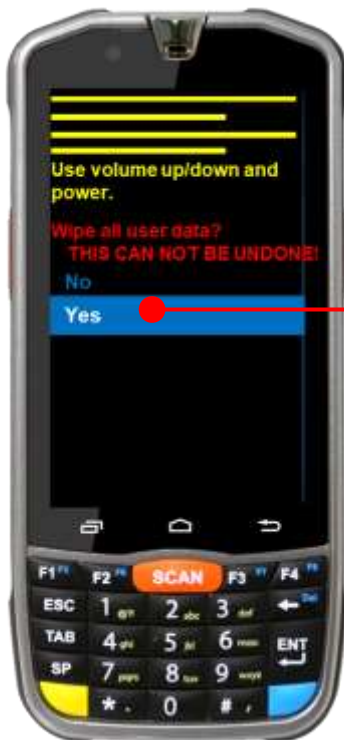

Select "Yes" to perform the "Factory data reset"
After that, your XM75WA start wiping the data

Force Factory data reset

Factory data reset



After data wiping, please select “Reboot system now” to finish the “Force Factory data reset” process

Enterprise Mobility Kit

EmKit

Enterprise Mobility Kit – Truly, what Enterprise needs

Janam Technologies LLC announces new software solution – called “EmKit” is new software solution for enterprise mobility users. Our every Android device shall have EmKit pre-installed and every user can access them for free of charge*. EmKit offers truly-value-added advantages, for enterprise users, which are against consumer-centric & non-customizable smartphones. Every solution in EmKit is 100% compatible with Janam Technologies LLC Android GMS certified devices.

* Necessary MDM license subjects upon individual subscribers



EmKit consist with “EmKit Secure”, “EmKit Remote”, “Emkit Tools” and “EmKit Demos”

- EmKit Secure “Lock Your Device”
- EmKit Remote “Mobile Device Management”
- EmKit Tools “Smarty Tools Ease Enterprise”
- EmKit Demos “Friendly For Programmers”

EmKit Secure

EmKit

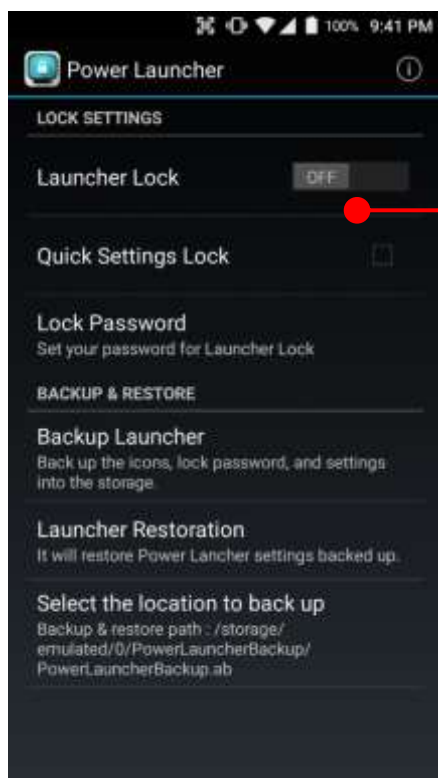

Power Launcher

You can lock your XM75WA's "Home Screen" and limit to access "Settings" from "Quick Setting" panel. This function as known as "Kiosk" mode

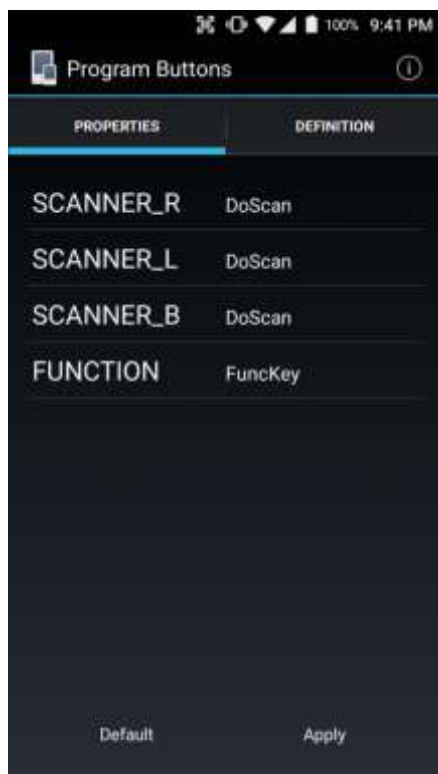

Program Buttons

You can assign Hardware buttons function to rich pre-assigned functions. Also you can applying the customized KCM file (Key Character Map Files) here

EmKit Remote

EmKit

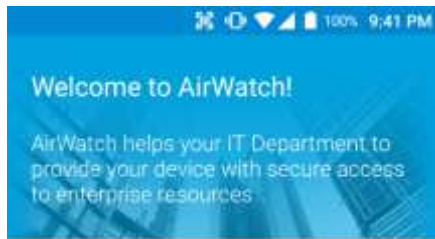

You will be guided through a three part process to authenticate, secure and configure your device.

Choose Authentication Method:

EMAIL ADDRESS

SERVER DETAILS

QR CODE

Airwatch Agent preinstalled.
Select option for enrollment process

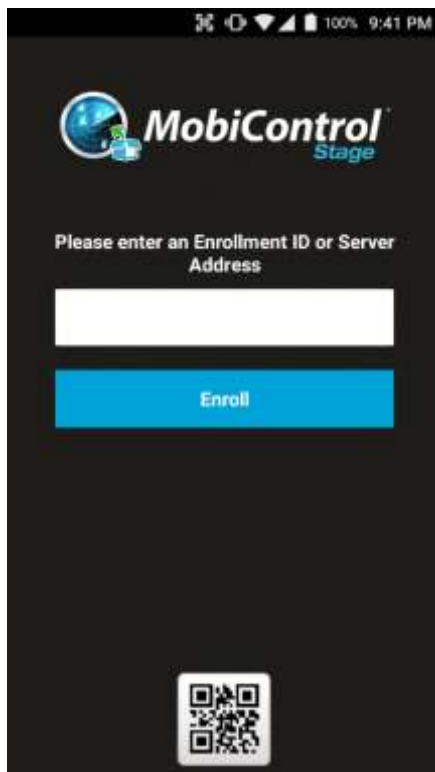

SOTI Mobi Control preinstalled
Enter enrollment information for the next process

EmKit Remote

EmKit

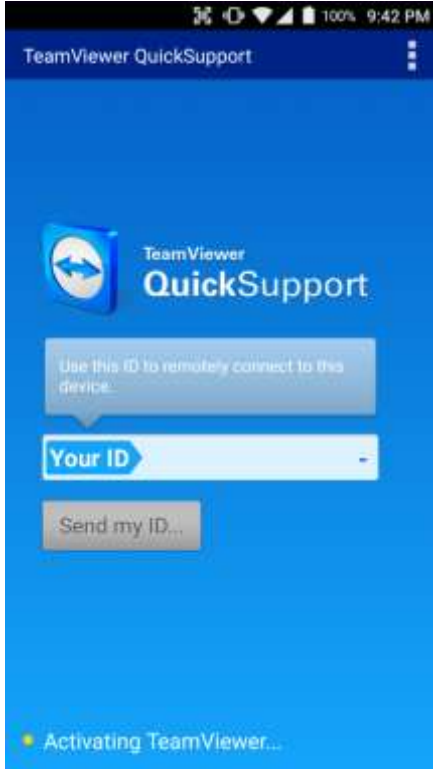

Teamviewer Quick Support App and Plugin, preinstalled. You may need to purchase "Teamviewer" license during remote access and control

EmKit Tools

EmKit

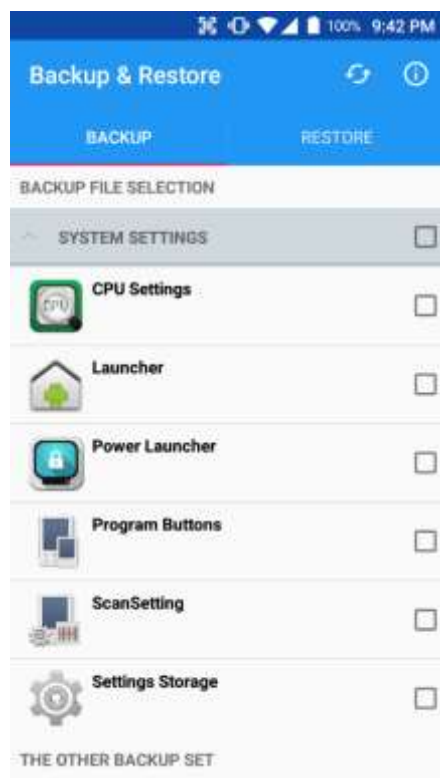

Backup & Restore

You can create the “Golden sample” and then “Restore” it to other XM75WA easily

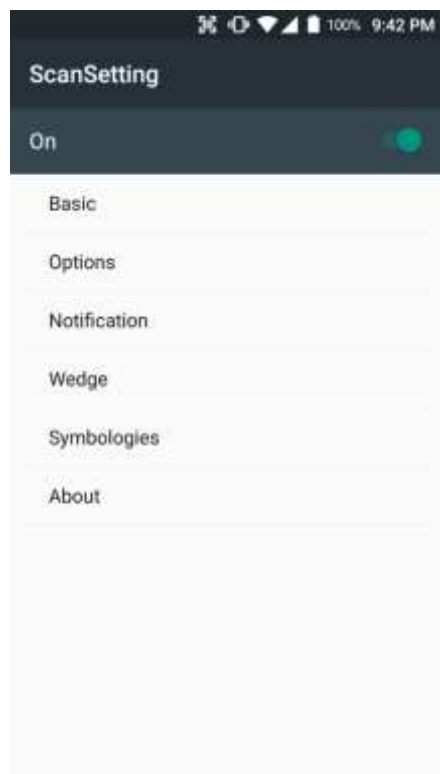

ScanSetting

You can set your XM75WA's scanner option with intuitive menu

EmKit Tools

EmKit



System information

All of SW and HW information available here and can save it to the file.

- Touch "Save to file"
- devinfo.html file saved to root folder of the internal storage.

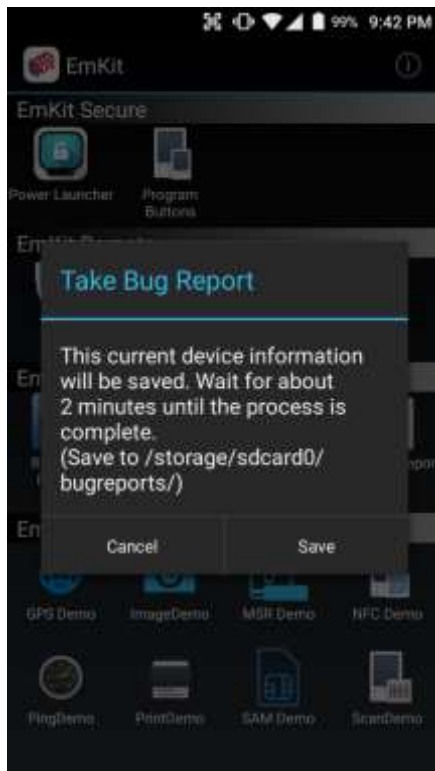

Take Bug Report

This function save logs and event to the internal storage. When you have a field issue, and need to contact service center, please find the reproduce step first.

- Reproduce the issue.
- After issue, reproduce, please run "Take bug report"
- File will be saved to "bugreports" folder.
- Copy the file to the PC and then zip it to reduce the file size
- Share bug report file to the service center with "reproduce" steps.

FCC

Changes or modifications not expressly approved by the manufacturer could void the user's authority to operate the equipment.

This device complies with part 15 of the FCC Rules. Operation is subject to the following two conditions: (1) This device may not cause harmful interference, and (2) this device must accept any interference received, including interference that may cause undesired operation.

This device has been tested and found to comply with the limits for a Class B digital device, pursuant to Part 15 of the FCC Rules. These limits are designed to provide reasonable protection against harmful interference in a residential installation. This equipment generates uses and can radiate radio frequency energy and, if not installed and used in accordance with the instructions, may cause harmful interference to radio communications. However, there is no guarantee that interference will not occur in a particular installation. If this equipment does cause harmful interference to radio or television reception, which can be determined by turning the equipment off and on, the user is encouraged to try to correct the interference by one or more of the following measures:

- Reorient or relocate the receiving antenna.
- Increase the separation between the equipment and receiver.
- Connect the equipment into an outlet on a circuit different from that to which the receiver is connected.
- Consult the dealer or an experienced radio/TV technician for help.

IC

This device complies with Industry Canada license-exempt RSS standard(s). Operation is subject to the following two conditions: (1) this device may not cause interference, and (2) this device must accept any interference, including interference that may cause undesired operation of the device

Le présent appareil est conforme aux CNR d'Industrie Canada applicables aux appareils radio exempts de licence.

L'exploitation est autorisée aux deux conditions suivantes :

(1) l'appareil ne doit pas produire de brouillage, et (2) l'utilisateur de l'appareil doit accepter tout brouillage radioélectrique subi, même si le brouillage est susceptible d'en compromettre le fonctionnement.

This device is restricted to indoor use only within the 5.15 ~ 5.35GHz Band.

Cet appareil est restreint à l'utilisation à l'intérieur seulement dans la bande 5.15 ~ 5.35GHz.