

User manual

Model: XT20

Brand: XT

Manufacture: Janam Technologies LLC

Mobile Device User Guide

Content

1.	Introduction	4
	About the Mobile Device.....	4
	Feature Summary.....	4
	Hardware Overview	5
2.	Get Started	7
	Unpack Your Device	7
	Recommended Host Computer Configuration/Requirements.....	7
	Attach the Handstrap.....	8
	Install the Battery.....	8
	Charge the Battery	8
	Removing Battery	8
	Installing MicroSD card.....	8
	Installing SIM card	8
	Installing PSAM card	9
	Turn the Device On	9
	Understanding the Desktop	9
3.	Set Up Your Device	10
	Set the Display Properties	10
	Set Volume and Enable Sounds.....	12
	Change Language & Input Settings.....	13
	Change the Date and Time Display	15
	Shortcutkey Settings.....	15
	Accounts.....	15
	Location Settings	16
	Screen Lock Settings.....	16
	About Phone.....	18
4.	Reset Your Device.....	19
	Performing Factory Data Reset	19
	Flash Rom	20
5.	User / Admin Mode.....	21
	Apply user mode	21
	Change to admin mode from user mode	21
	Disable Android keys in admin mode	21
	Change admin mode PIN	21
6.	Barcode Scanning	22
	Features	22
	Scanning Considerations.....	22
	Barcode Scanning Demonstration and Setup.....	23
	DataWedge.....	25
7.	USB Connection	26
	Connect to host computer	26
	Disconnect from host computer	27
8.	Application Deployment.....	28
	Install Applications via USB Connection	28
	Install Applications via Android Debug Bridge	29
	Uninstall Applications.....	29
	Storage	30

Mobile Device User Guide

	Applications Management	31
	To Stop An Application	32
	To Change Application Location	33
	Managing Downloads	33
9.	WiFi Connection	34
	Wireless Local Area Network Access	34
10.	Bluetooth	35
	Bluetooth Partnerships	35
11.	Regulatory and Warning	38
	Regulatory Information	38
	CE Marking and European Economic Area (EEA).....	38
	FCC Compliance	38
	Battery Warning.....	39
	General information	39

1. Introduction

About the Mobile Device

RUGGED, BIG SCREEN, SLIM, ALL DAY OPERATIONS, seems to be a group of features that cannot be comprised themselves into a single package. Until now, we have answered your requests with ST32. It is just 250g (with 3150mAh battery), long battery life (10+ hours operation), big screen (4.3" diagonal), high resolutions (WVGA resolution) and yet comfortably to hold .

The ST32 mobile computer is a neat package that packs with functions your customers needed in major industries, namely retail, restaurant, hospitality and field services. It is rugged (IP66 and 1.2 meters drop to concrete), fully connected (Bluetooth, Wi-Fi b/g/n) and has various options that you can customize for your customers' needs

Feature Summary

- Android 4.2.1
- Small and light - under 10 ounces
- Full 4.3" WVGA (480x800) TFT display with backlight
- High performance barcode scanning
- Autofocus 5MP camera
- WLAN IEEE 802.11 b/g/n (all 2.4GHz)
- Bluetooth
- 1GB RAM / 4GB FLASH memory
- User-accessible microSD card slot (MicroSDHC support)
- Sculpted to fit in the hand - truly pocketable
- Withstands multiple 4'/1.2m drops to concrete across a wide temperature range
- Sealed to IP66 standards
- Hi-Speed USB 2.0 and serial output
- Full system of accessories

Mobile Device User Guide

Hardware Overview

Front view and side view

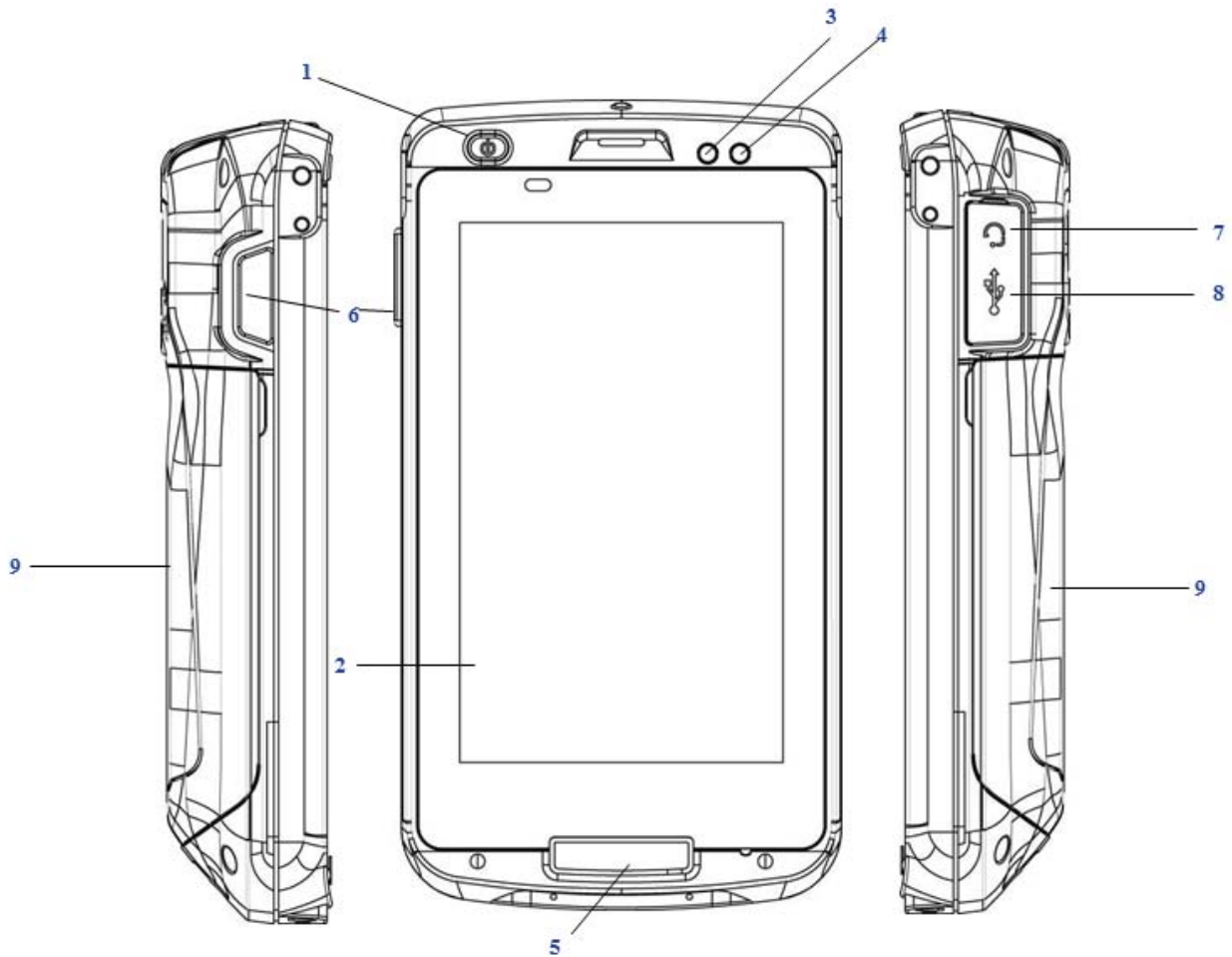

1. Power Button
2. LCD display
3. Charging LED
4. Status LED
5. Bottom trigger button
6. Scan / Action button
7. Ear phone
8. Micro USB connector
9. Battery cover

Mobile Device User Guide

Rear, top & bottom views

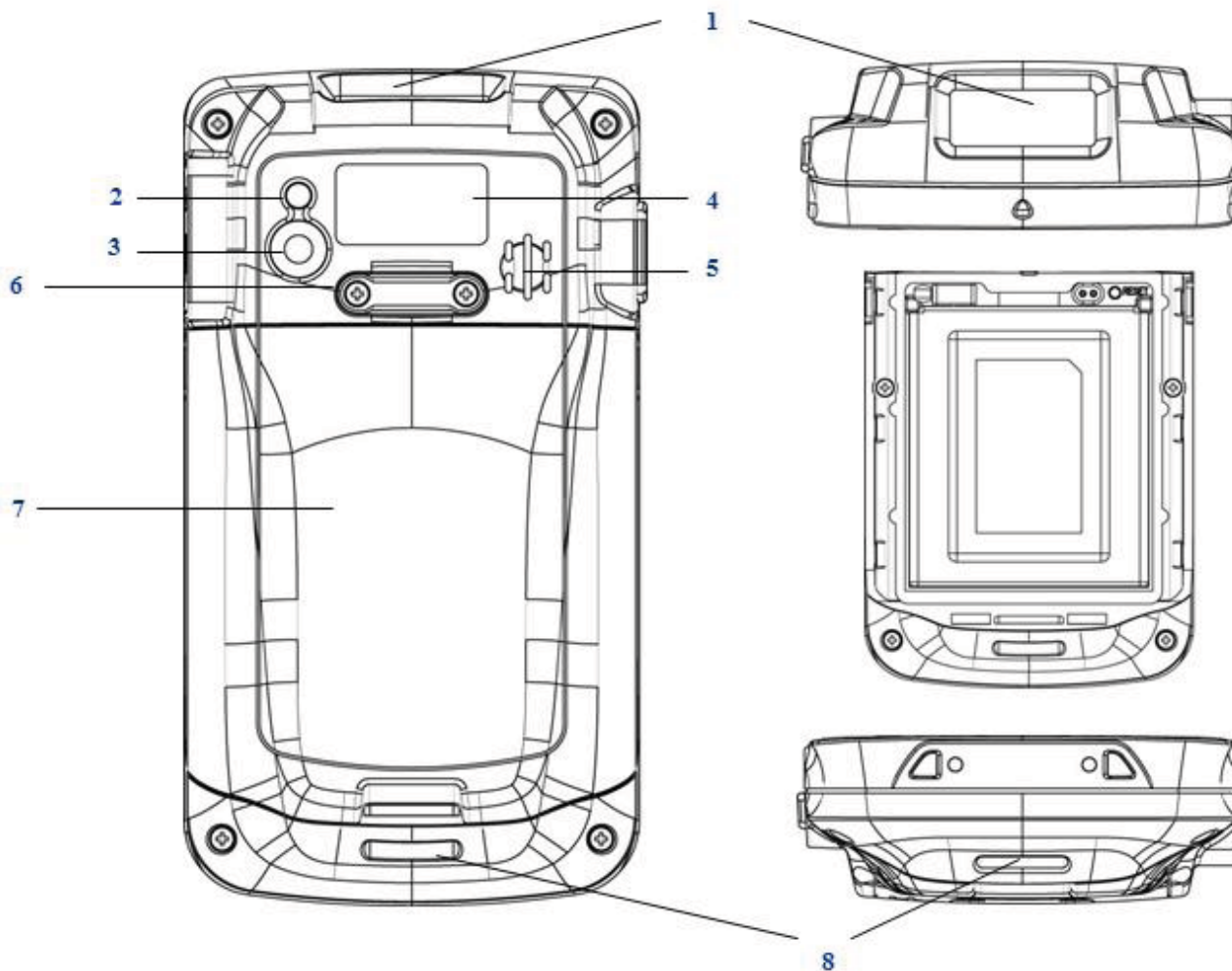

- 1. Data capture window
- 2. Flash
- 3. Camera
- 4. Label recess
- 5. Speaker
- 6. Handstrap clip
- 7. Battery cover
- 8. Handstrap bar

2. Get Started

Unpack Your Device

Make sure you have the following:

- Handheld computer
- Authorized battery
- Handstrap
- Charging accessory (ordered/packed separately) with one of the following kits:
 - USB cable with AC adapter

Recommended Host Computer Configuration/Requirements

The Development Kit assists programmers with the development of applications for rugged barcode scanners running the Android 4.2.1 system.

It contains all necessary details and instructions for developing applications that use libraries, including scanning, imaging and hardware utilities.

The development kit is designed for use with Microsoft eMbedded Visual C++ 4.0 (*SP4 or above*) or Microsoft Visual Studio 2005.

- IBM-compatible host computer with Pentium 450 MHz processor or higher
- Microsoft Windows XP Service Pack 2, Microsoft Windows 2000 Service Pack 4, Windows Server 2003 Service Pack 1 or Windows Vista
- 192 MB RAM (Recommended: 256 MB)
- Hard disk space:
 - Without Microsoft Developer Network (MSDN): 1 GB on system drive and 2 GB on installation drive
 - With MSDN: 1 GB on system drive; 3.8 GB on installation drive with a full installation of MSDN; and
 - 2 GB on installation drive with a default installation of MSDN
- CD-ROM or DVD-ROM drive
- One available serial port
- Video minimum 800 x 600, 256 colors (Recommended: 1024 x 768, high color 16-bit)
- Mouse or compatible pointing device

Mobile Device User Guide

Attach the Handstrap

1. Remove the screws from handstrap holder.
2. Separate the velcro of the handstrap.
3. Feed the loose end of the extended handstrap through the handstrap holder.
4. Wrap the handstrap around the holder and fasten together to close the strap.
5. Install the screws back to the handstrap holder.

Install the Battery

1. Lift up slightly, grasp the battery cover and remove it.
2. Insert the battery, left side (with golden contacts) first, into the battery compartment.
3. Press the battery down until the battery fully rests on the bottom of battery compartment.
4. Put the battery cover back, tab first, and press down until the latch secure the battery cover.



Charge the Battery

1. Insert the small end of power adapter into the Micro USB jack.
2. Plug the large end of power adapter into a power outlet



Removing Battery

1. Lift up slightly, grasp the battery cover and remove it.
2. Remove the battery, right side first, from the battery compartment.

Installing MicroSD card

1. Remove battery if necessary.
2. Insert MicroSD card into the card slot.
3. Make sure the card connector (the golden contacts) should be at the front of insert.

Installing SIM card

1. Remove battery if necessary.
2. Insert SIM card into the SIM card slot
3. Make sure the SIM card connector (the golden contacts) should be at the front of insert

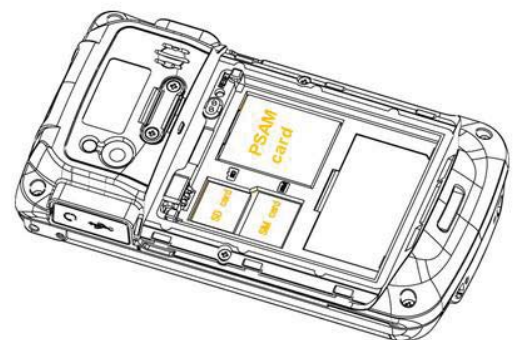

Mobile Device User Guide

Installing PSAM card

1. Remove battery if necessary.
2. Unlock the PSAM card lock.
3. Insert PSAM card into the SIM card slot
4. Make sure the SIM card connector (the golden contacts) should be at the front of insert
5. Lock the PSAM card slot.

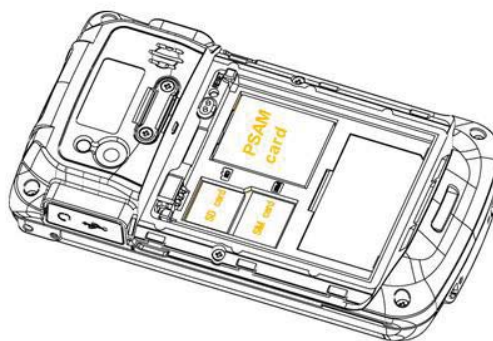

Turn the Device On

After installing the battery in the device, press the power button at the top of the device.

Understanding the Desktop



3. Set Up Your Device

Set the Display Properties

You may change the display appearance easily base on your preference in Menu > Settings > Device > Display.

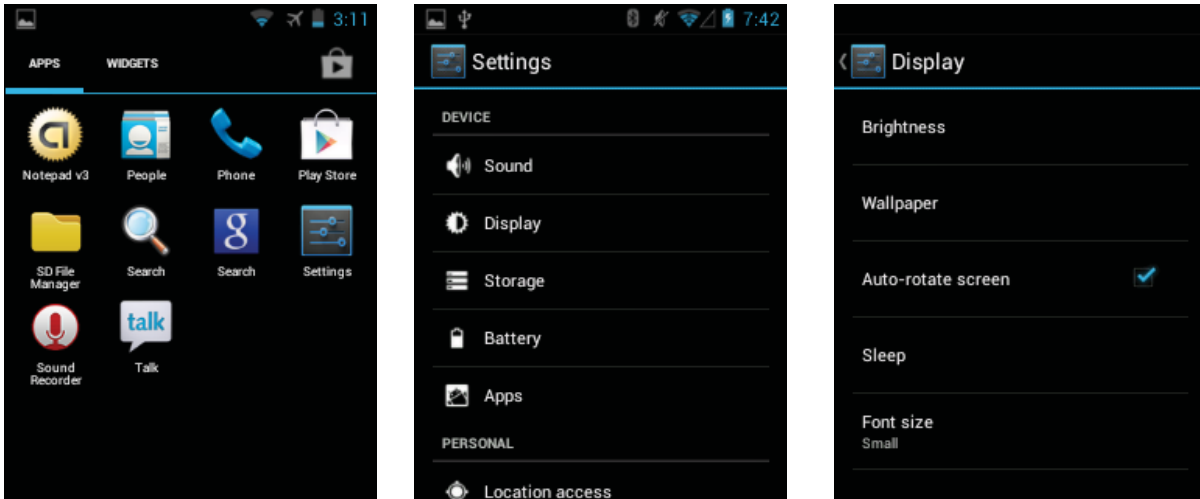

To adjust brightness

1. Tap Display > Brightness.
2. Adjust brightness by moving the arrow left side or right side.
3. Click OK.

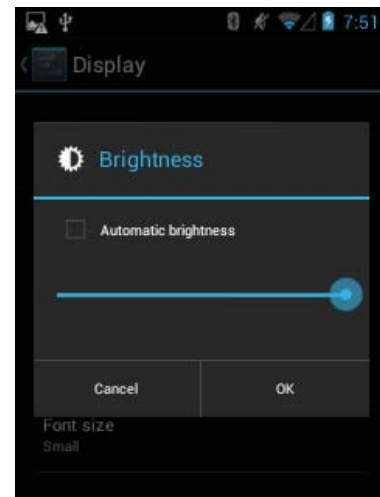

To enable / disable Auto-rotate screen

1. Tap Display > check the box to enable / disable Auto-rotate screen.

Mobile Device User Guide

To choose a background

1. Tap Display > Wallpaper > Choose wallpaper.
2. Choose background from Gallery / Live Wallpapers / Wallpapers, and select the background you like.
3. Click Set wallpaper.

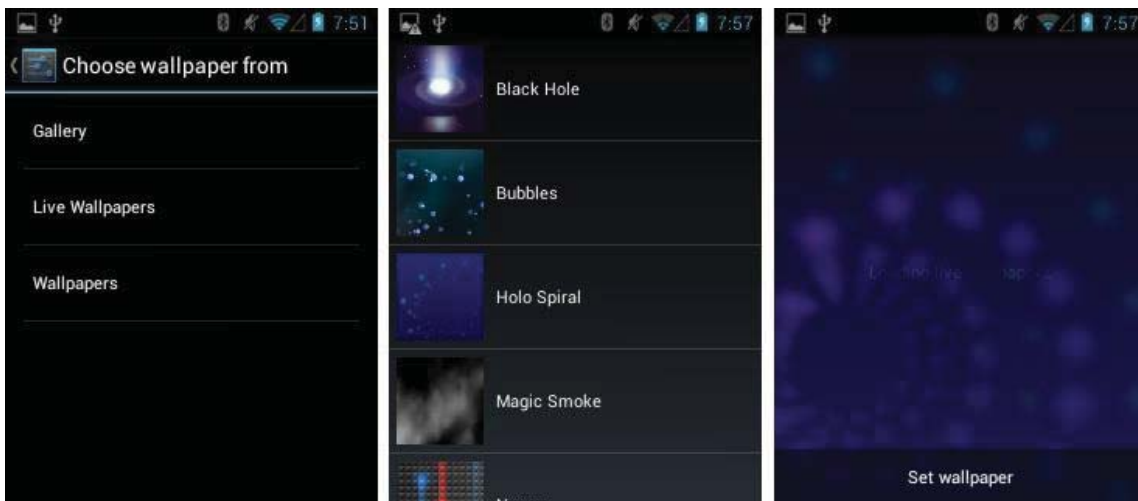

To set Sleep mode duration

1. Tap Display > Sleep.
2. Set sleep mode duration.

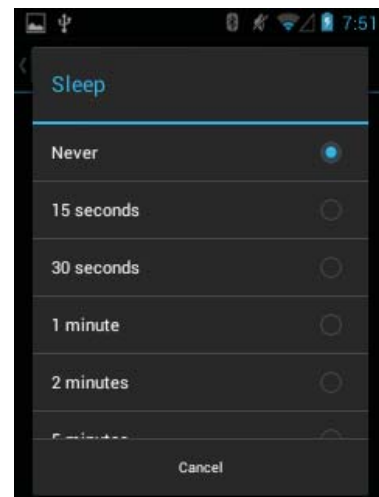

To set Font size

1. Tap Display>Font size.
2. Select font size.

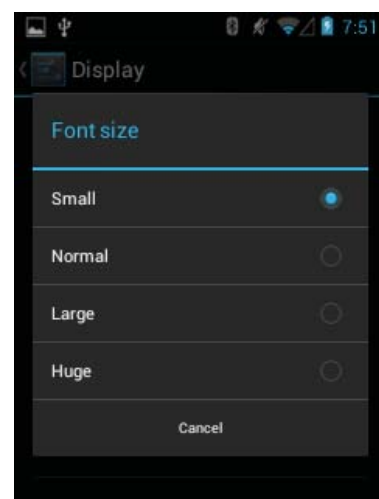

Mobile Device User Guide

Set Volume and Enable Sounds

You may adjust volume or change the type of sound base on your preference in Settings > Device > Sound.

To adjust volume / select phone ringtone / enable vibration

1. Tap Sound > Volumes. Adjust base on your preferences. Click OK to confirm.
2. Tap Sound > Phone ringtone to select sounds. You may click Preview to sample any sound. Click OK to confirm.
3. Click the box Vibrate when ringing to enable or disable vibration.

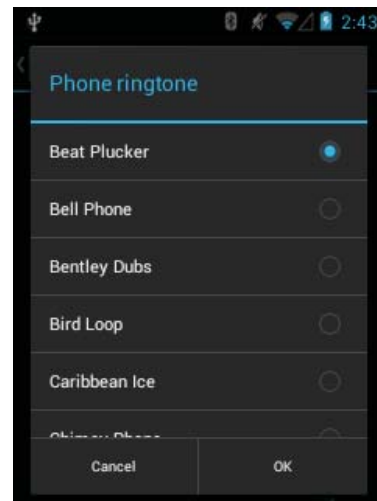
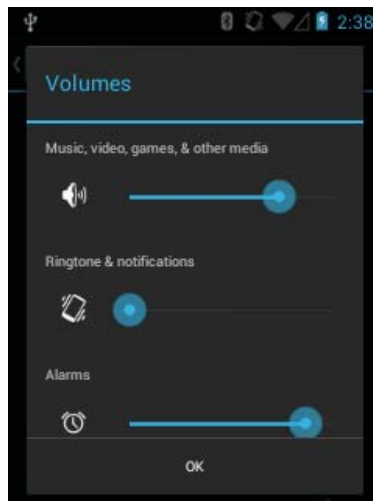
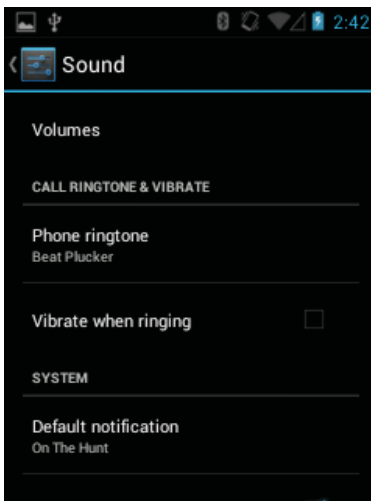

To select notification ringtone

1. Tap Sound > Default notification. You may click Preview to sample any sound. Click OK to confirm.

Check the box to enable / disable functions below

- Dial pad touch tones
- Touch sounds
- Screen lock sound
- Vibrate on touch

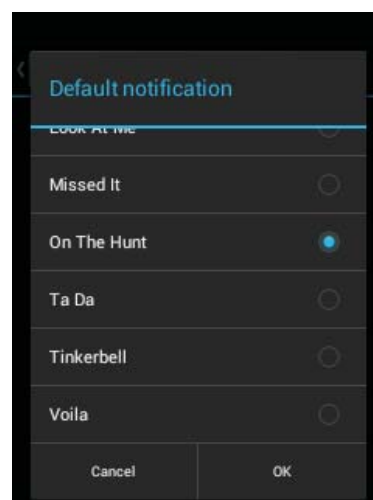
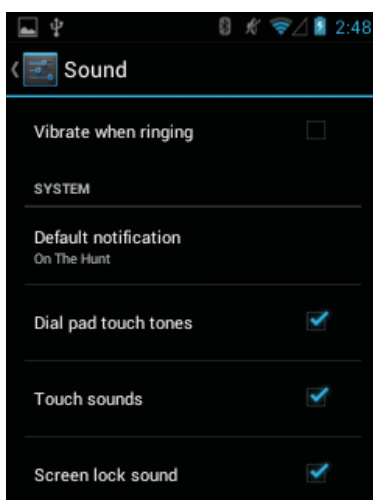

Mobile Device User Guide

Change Language & Input Settings



Tap Menu > Settings > Language & input settings to change the language that display for the text and add words to its dictionary.

Change the language settings

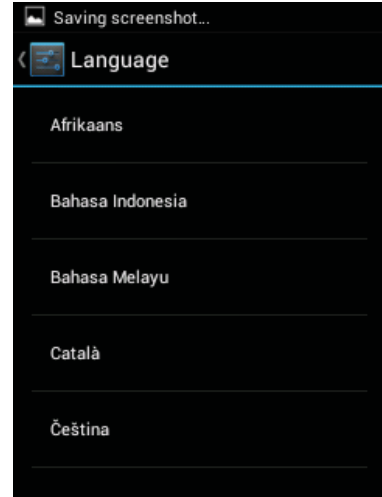
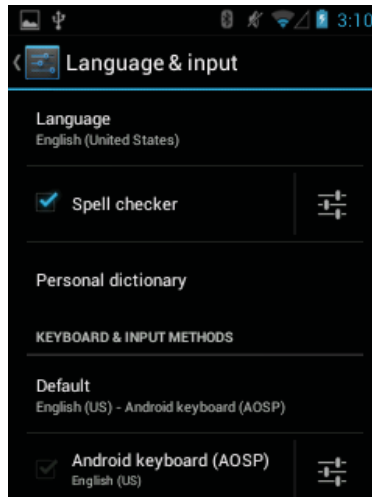
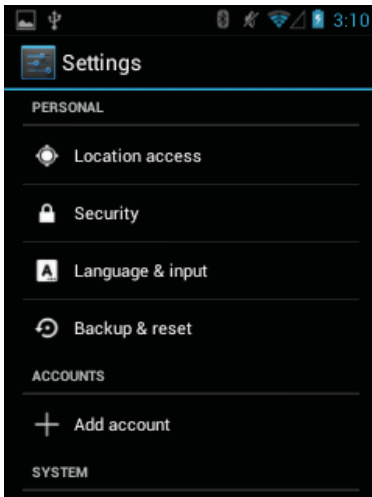
1. Tap Language & input > Language.
2. Select language from the list.



To change Spell checker preference

1. Click the box to enable / disable spell checker.
2. Click the icon  to enter spell checker screen, select type of spell checker.
3. Next to the option, click the icon , click the box to enable or disable spell checker in your contact list.
4. In the Spell checker screen, click  and select the language.

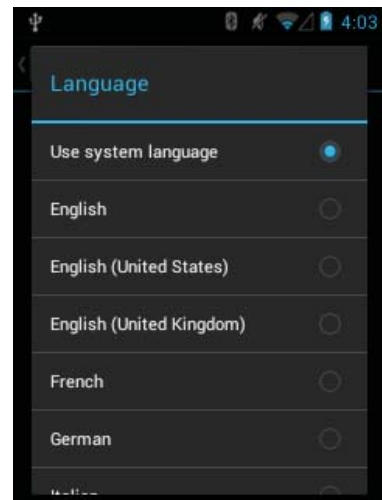
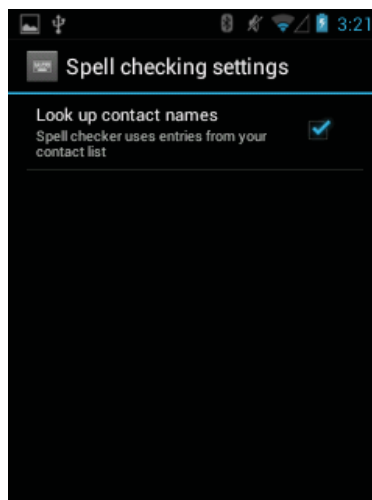
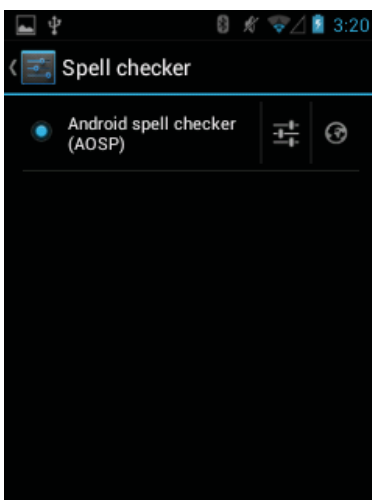

Mobile Device User Guide

Adding words to personal dictionary

1. In the Language & input screen, tap Personal dictionary.
2. Tap + to add a new phrase to the dictionary.
3. In the Phrase text box, enter the word or phrase.
4. In the Shortcut text box, enter a shortcut for the word or phrase.
5. In the Language drop-down list, select the language that this word or phrase is stored.
6. Touch Add to dictionary in the top left corner of the screen to add the new word.

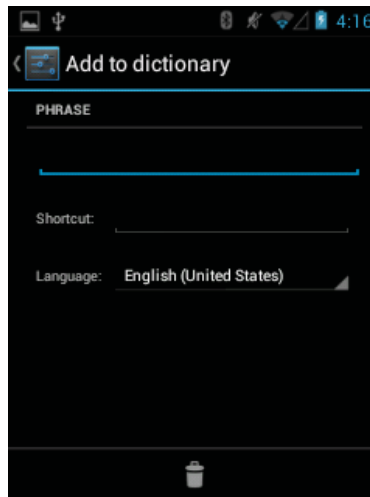
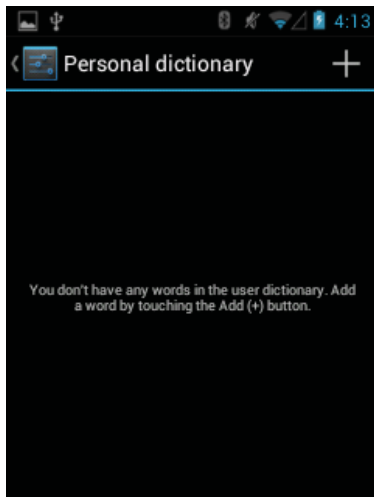

Keyboard Setting

Use the Language & input settings for configuring the on-screen keyboards. The device contains the following keyboard settings:

- Android keyboard
- Baidu IME
- Google voice typing
- Google pinyin

Click  to have further settings.

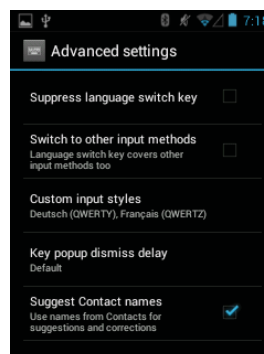
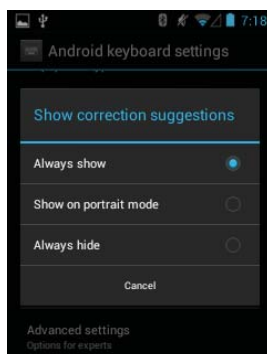
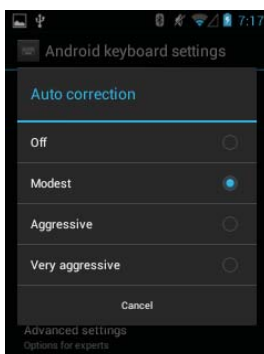
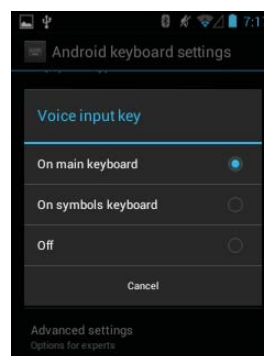
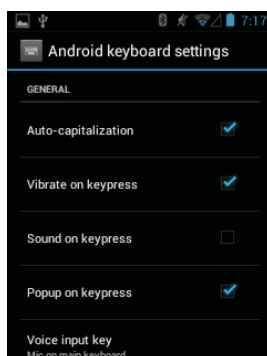
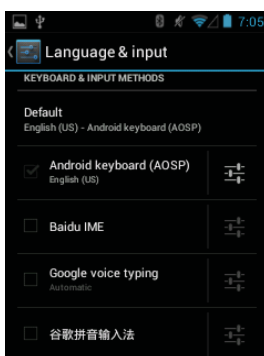

Mobile Device User Guide

Change the Date and Time Display

Tap Menu>Settings>Date & time to change followings:-

- Date
- Time
- Time zone
- 12/24-hour format
- Date format

Or select Automatic setting (use network-provided date, time and time zone).

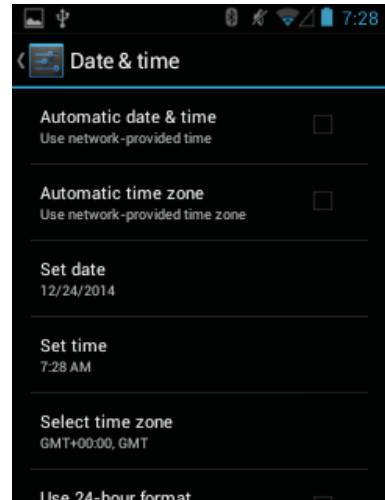

Shortcutkey Settings

1. Tap Settings > ShortcutKey Settings.
2. Select a button to remap.
3. Select function or application shortcut to map to the button.

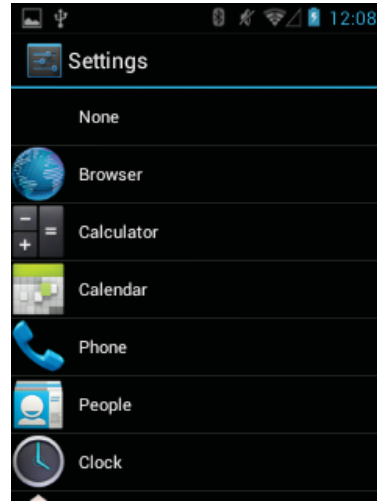
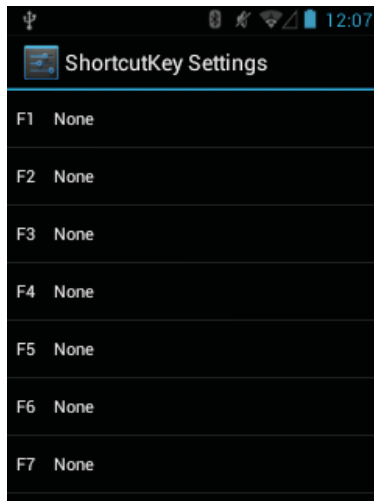
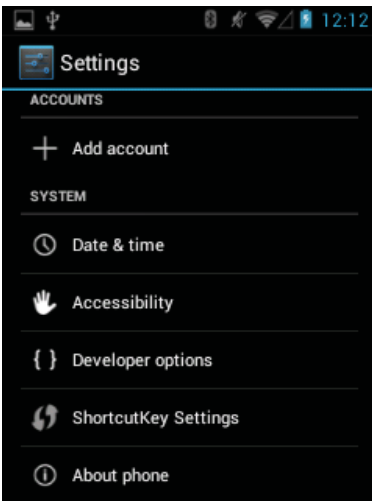

Accounts

Tap Settings > Accounts to add, remove, and manage accounts. The Accounts settings can control how applications send, receive, and sync data, or whether applications can synchronize user data automatically.

Applications may also have their own settings to control how they synchronize data; see the documentation for those applications for details.

- **General sync settings**
- **Background data** – Enable applications to synchronize data in the background. Disable this setting can save battery power.
- **Auto-sync** - Enable applications to synchronize data on their own schedule.
- **Manage accounts** - Lists accounts added to the device. Touch an account to open its account screen.

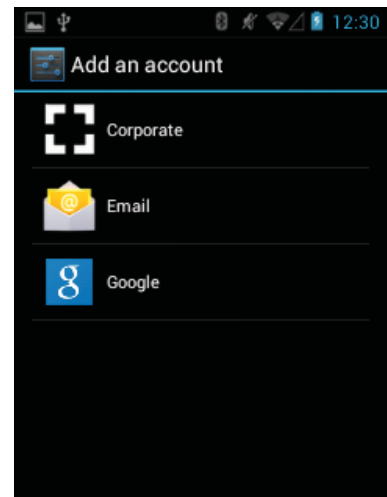

Mobile Device User Guide

Location Settings

Use Location access to customize preference for using and sharing location information:

Tap Menu > Settings > Location access

- **Access to my location:** let applications that have asked your permission to use your location information
- **GPS satellites:** let applications use GPS on your device to pinpoint your location
- **WiFi & mobile network location:** let applications use Google's location service to estimate your location faster. Anonymous location data will be collected and sent to Google.

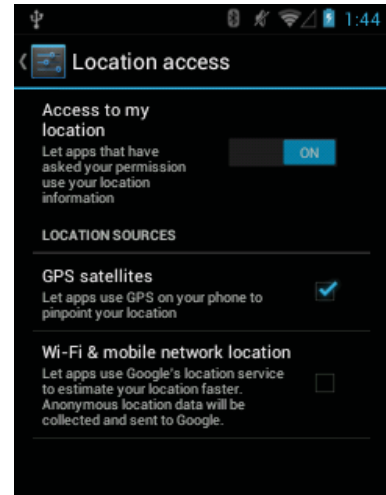

Screen Lock Settings

Screen lock function can protect access the data which stored in the device. To select your locking preference, tap Menu > Settings > Security > Screen lock.

- **None:** Disable screen lock security
- **Slide:** Slide the lock icon to unlock the device
- **Pattern:** Draw your own pattern to unlock the device
- **Pin:** Enter a numeric PIN (between 4-16 characters) to unlock the device
- **Password:** Enter a password (between 4-16 characters and at least 1 alphabet letter) to unlock the device

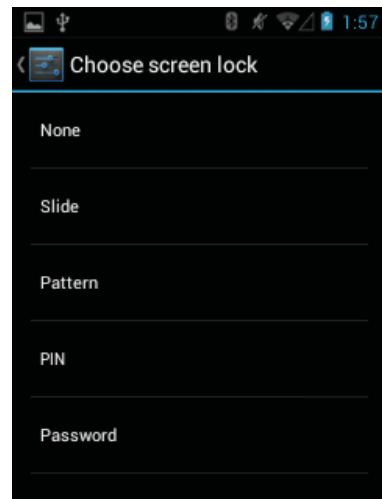

Pattern screen lock preference:

1. Go to Menu > Settings > Security > Screen lock > Pattern.
2. Watch the example of how to draw a pattern, tap Next
3. Draw a pattern connecting at least 4 dots. Tap Continue.
4. Re-draw the pattern. Tap Confirm. The device will require a pattern to unlock next time.

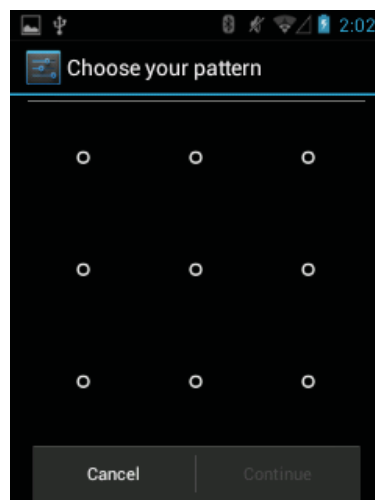
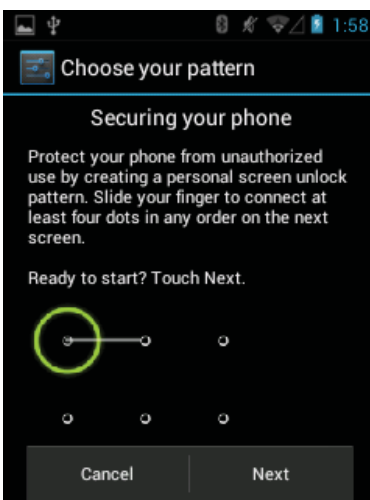

Mobile Device User Guide

PIN screen lock preference:

1. Go to Menu > Settings > Security > Screen lock > PIN.
2. Enter a PIN (between 4-16 characters), tap Next.
3. Re-enter the PIN, tap Next.
4. The device will require a PIN to unlock next time.

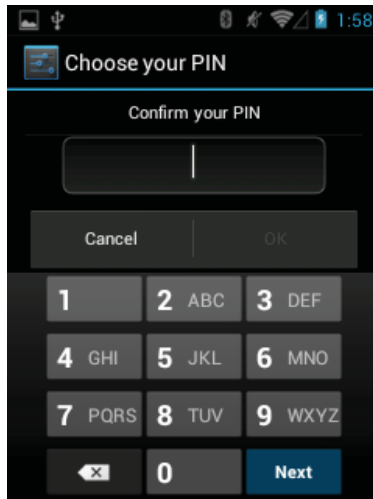
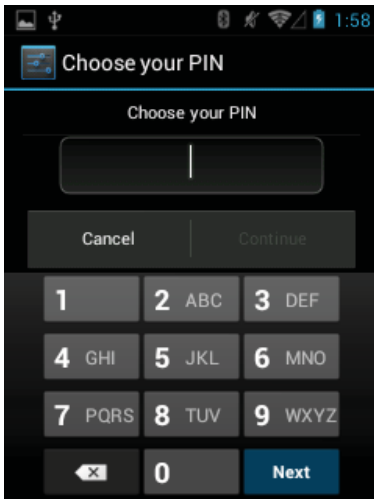

Password screen lock preference:

1. Go to Menu > Settings > Security > Screen lock > Password.
2. Enter a Password (between 4-16 characters and at least 1 alphabet letter), tap Next.
3. Re-enter the Password, tap Next.
4. The device will require a password to unlock next time.

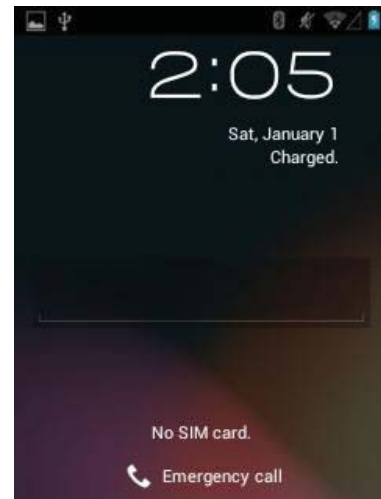
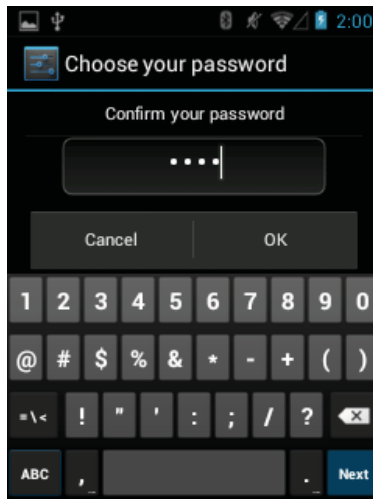
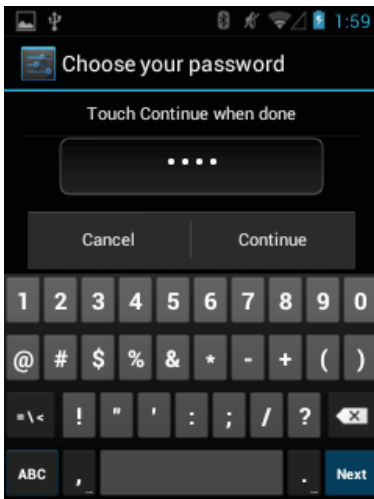

Mobile Device User Guide

About Phone

Use About phone settings to view information about the device. Tap Menu > Settings > About phone.

- **System update:** check for the up-to-date software
- **Status:** tap to show below information:
 - (a) Battery status - shows if the battery is charging (on cradle / USB) or discharging (on battery power).
 - (b) Battery level - shows the battery charge level in percentage.
 - (c) Network – shows the network carrier.
 - (d) Signal strength - shows the radio signal strength.
 - (e) Mobile network type - shows the mobile network type.
 - (f) Service state – shows the state of service.
 - (g) Roaming - shows if the device is roaming outside the network.
 - (h) Mobile network state - shows the mobile network state.
 - (i) My phone number - displays the phone number.
 - (j) IMEI - shows the IMEI number of the device.
 - (k) IMEI SV - shows the IMEI SV number of the device.
 - (l) IP address - shows the IP address of the device.
 - (m) Wi-Fi MAC address - shows the Wi-Fi radio MAC address.
 - (n) Bluetooth address - shows the Bluetooth radio Bluetooth address.
 - (o) Serial number - shows the serial number of the device.
 - (p) Up time - shows the time that the device has been running since being turned on.

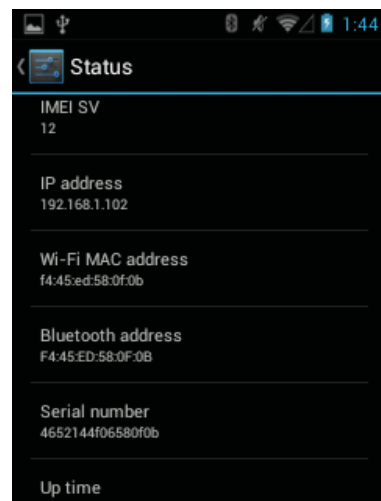
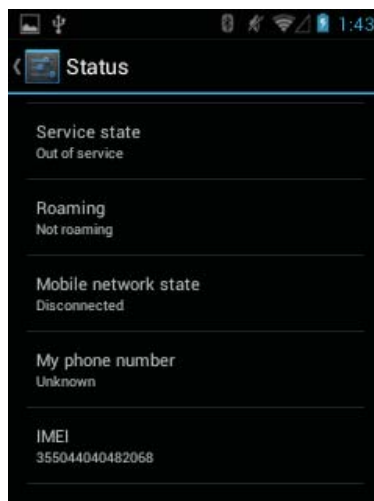
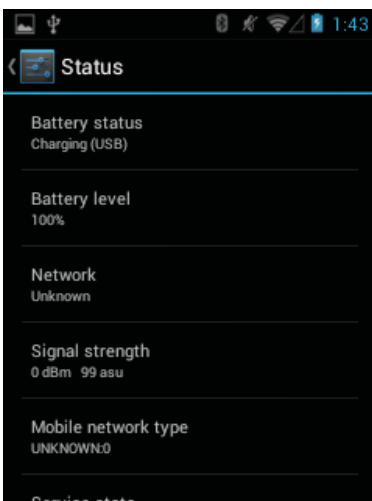
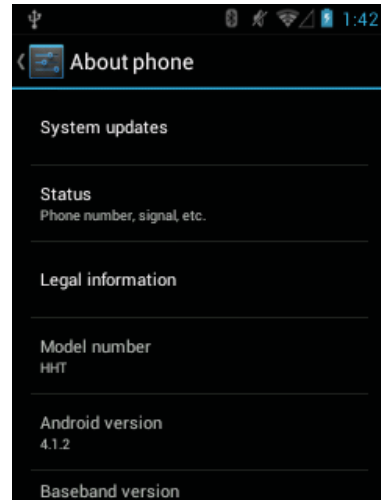

- **Legal information:** shows legal information about the software included on the device.
- **Model number:** shows the devices model number.
- **Android Version:** - shows the Android ROM version.
- **Baseband version:** - shows WAN radio firmware version.
- **Kernel version:** - shows the kernel version.
- **Build number:** - shows the software build number.

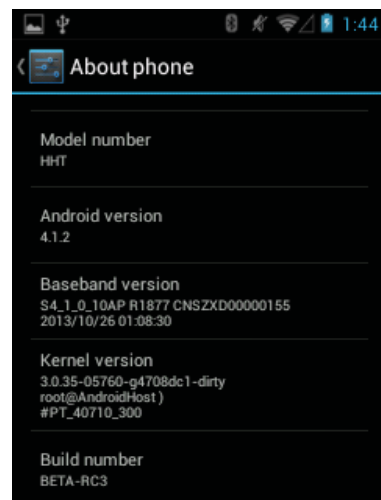

4. Reset Your Device

Performing Factory Data Reset

A hard reset returns the device to factory settings, removing ALL applications and data from the device. Be sure that all data is backed up before performing a hard reset.

To perform a factory date reset, do the following:

1. Tap Apps icon, then select Settings.
2. In Personal selection, select Back up and reset.
3. Select Factory date reset, click Reset phone.

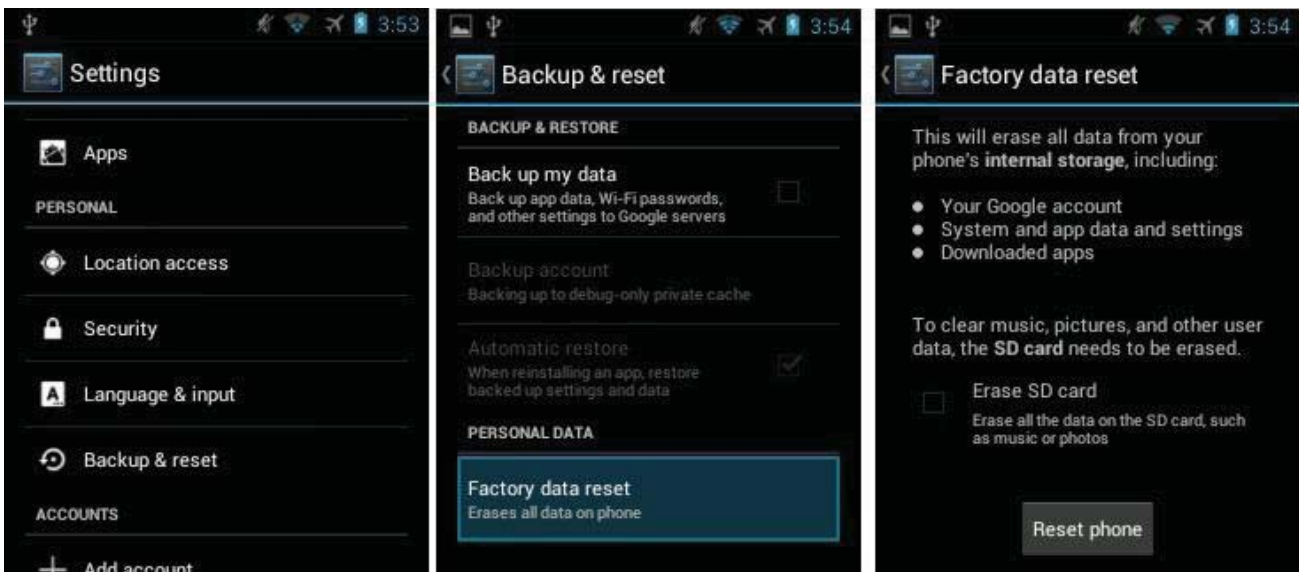

Mobile Device User Guide

Flash Rom

1. Copy ROM zip file to the root directory of the MicroSD card
2. Open the battery cover, remove the battery
3. Insert the MicroSD card
4. Install the battery to the battery compartment.
5. Press and hold the power button and the left side Scan / Action button for few seconds
6. Continue to press and hold the left side Scan / Action button and press power button until the update screen appears.
7. Press power button, update menu appears.
8. Select update from SD card, press the bottom trigger button.
9. Select the ROM zip file from SD card, press bottom trigger button.
10. After complete installation, select wipe factory reset, press bottom trigger button.

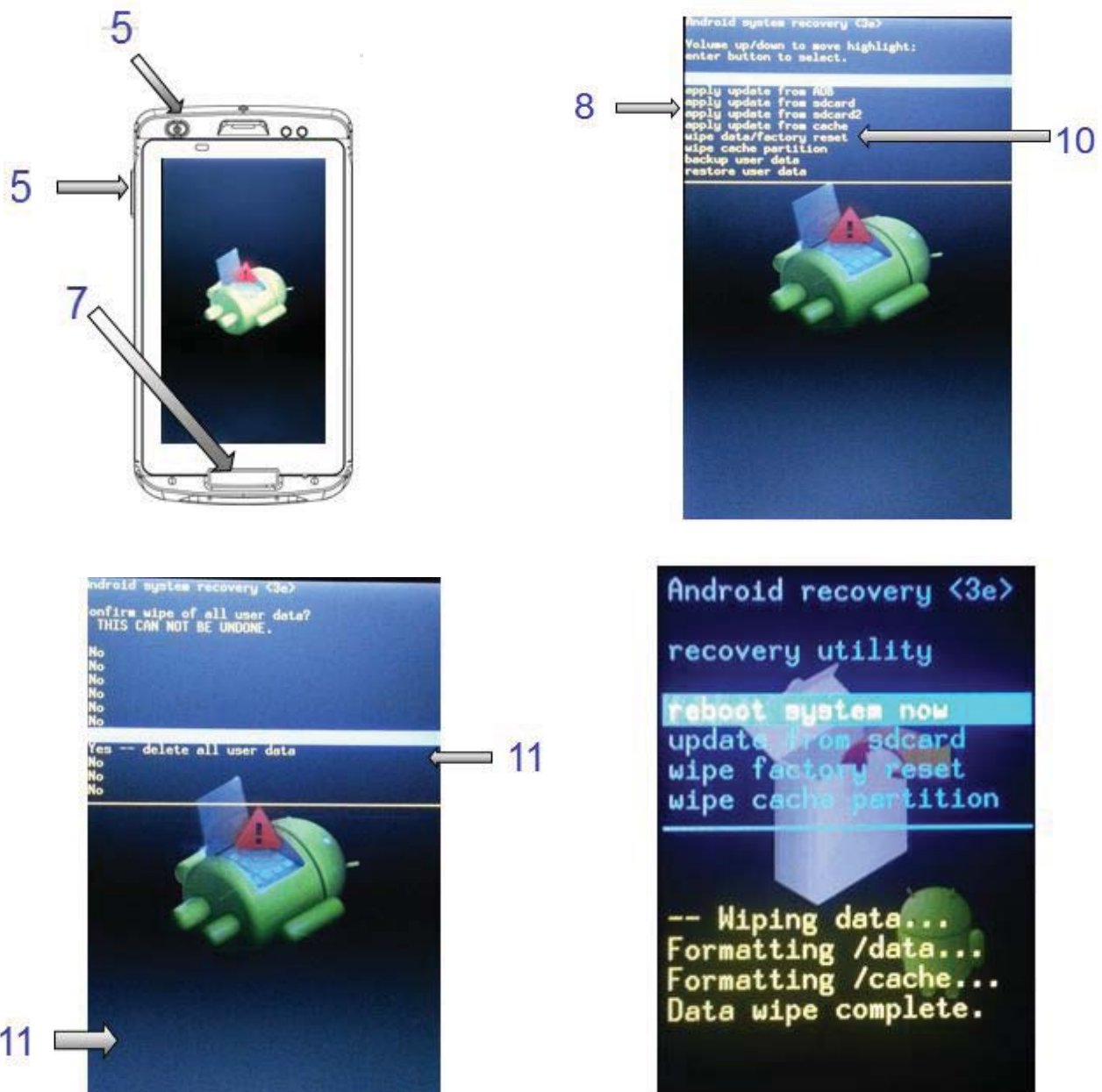

Mobile Device User Guide

5. User / Admin Mode

LPT82 has two operating modes. Admin mode is the environment for administrator with full rights on system/application settings; such as disable Android keys eg. Menu, Home, Back button and notification bar. User Mode is a specially designed mode for end users which users cannot access to system settings.

Apply user mode

System reboot can apply user mode. And there are several ways to apply user mode too:

- Press and hold power key, select Apply User Mode
- At the Home screen, press and hold power key, and select Apply User Mode

Change to admin mode from user mode

1. Press and hold power key, select Apply Admin Mode.
2. Enter admin mode password. The default password is 12345678.

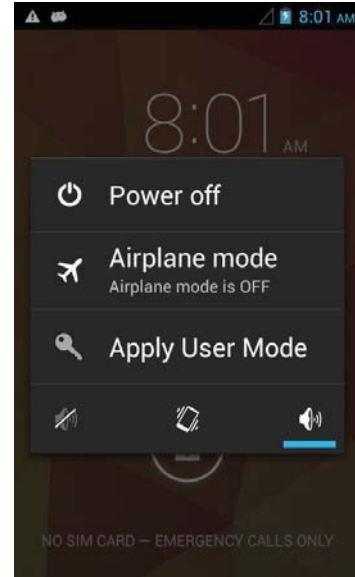

Disable Android keys in admin mode

1. Go to Settings > Security.
2. Disable Android keys base on your preference.

Change admin mode PIN

1. Go to Settings > Security.
2. Select Admin Mode PIN.
3. Enter new PIN, click Confirm.

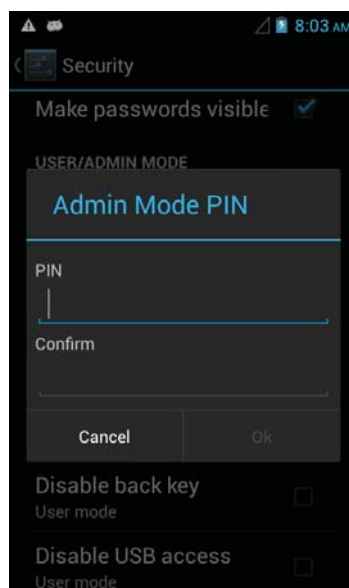
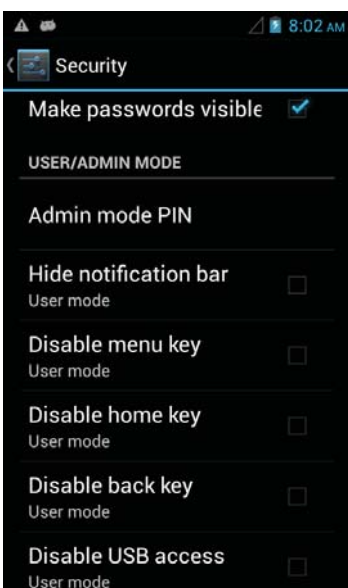

6. Barcode Scanning

Features

1. High performance in 1D bar code scanning
2. Easy point-and-shoot operation

Scanning Considerations

To ensure barcode scanning in high performance, below factors should be considered:

1. Range

- Any scanning device decodes well over a particular working range — minimum and maximum distances from the bar code. This range varies according to bar code density and scanning device optics.

- Scanning within range brings quick and constant decodes; scanning too close or too far away mostly causes inaccurate decode. Move the scanner to find the right working range for the bar codes being scanned.

2. Angle

- Scan angle is important for promoting quick decodes.

It is recommended to hold the device at some angle (approx. within 65°) as shown in the figure, so that the laser beam is at an angle and the reader receives an irregular reflection. When the laser beam is mounted at a right angle to the barcode, the reflection becomes too strong (specular reflection) for the barcode reader to detect it properly, resulting in inaccurate reading.

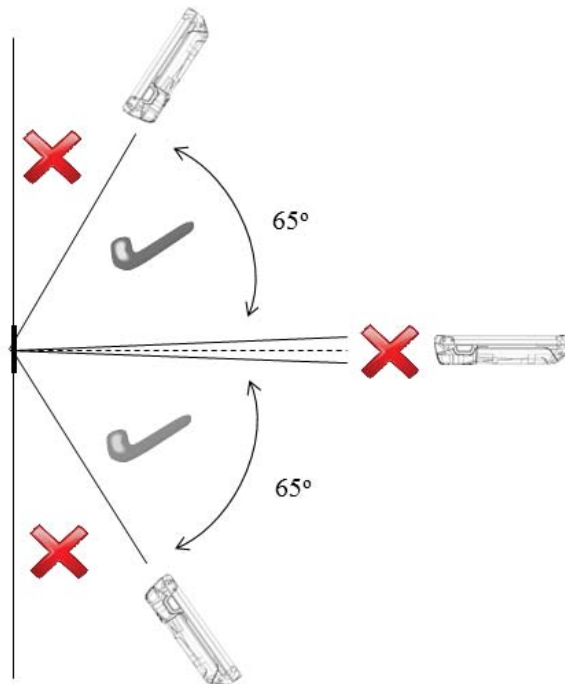

Mobile Device User Guide

Barcode Scanning Demonstration and Setup

To run the demo:

1. Tap the Apps menu on the Main Menu screen, select Basic Scan.



2. Point the scanner at a barcode, and press the red scan trigger button on the device or press “Scan” on the screen. The red LED lights will indicate that data capture is in process.

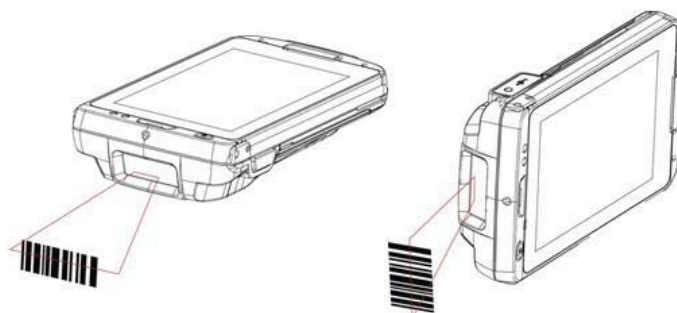
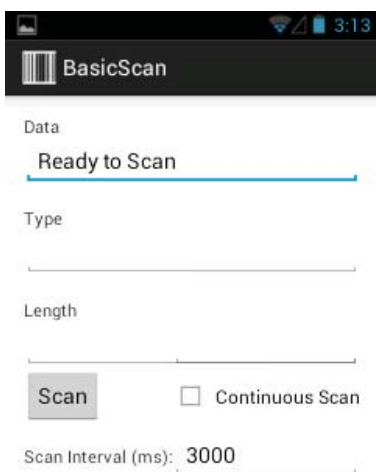

Mobile Device User Guide

3. Place the red aiming pattern across the barcode.

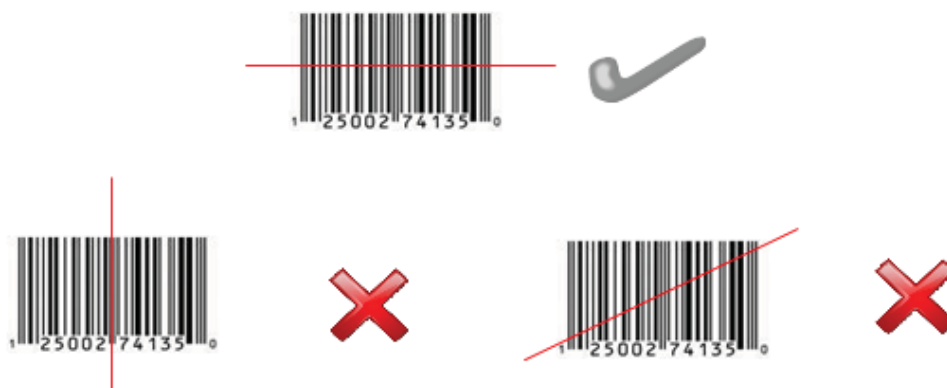

4. The results will display on the text field after a successful scan with a beep sound.



5. Select "Continuous Scan" can scan automatically when scanner detects barcodes without pressing scan trigger / scan button on screen. You may press "Stop" to stop the process.

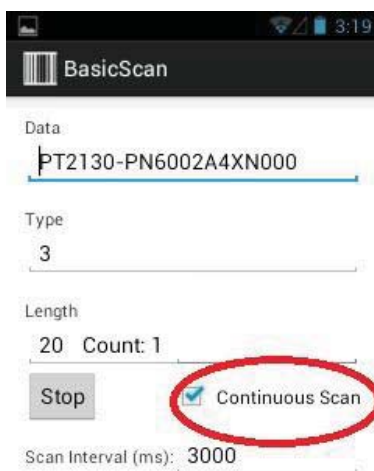

Mobile Device User Guide

DataWedge

DataWedge is an application that reads data, processes the data and sends the data to an application. To launch DataWedge, tap app menu, select DataWedge. A General Setting menu appears. You may select your scanning preference here.

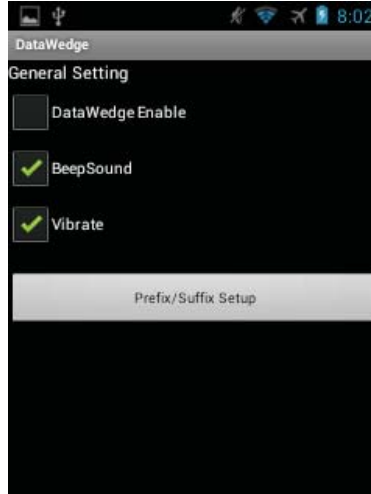

- **DataWedge Enabled:** Enables or disables Basic Data Formatting. A check in the checkbox indicates that it is enabled.
- **BeepSound:** Enables or disables beep sound while scanning in input field.
- **Vibrate:** Enables or disables vibration while scanning in input field.
- **Prefix / Suffix Setup:**
 - **Allow escapes in prefix / suffix:** Enabling this option allows escape sequences to be embedded in prefix and suffix strings. Escape sequences allow non-textual data to be transmitted as part of the prefix or suffix string. All escape sequences begin with the backslash “\” character.
 - **Prefix to send before data:** Add characters to the beginning of the data when sent.
 - **Suffix to send after data:** Add characters to the end of the data when sent. .
 - **Send barcode data:** Set to transfer the captured data to the foreground application. Disabling this option prevents the actual data from being transmitted. However, the prefix and suffix strings, if present, are still transmitted.
 - **Send ENTER key after suffix:** Set to append an enter character to the end of the processed data.
 - **Send TAB key after suffix:** Set to append a tab character to the end of the processed data.

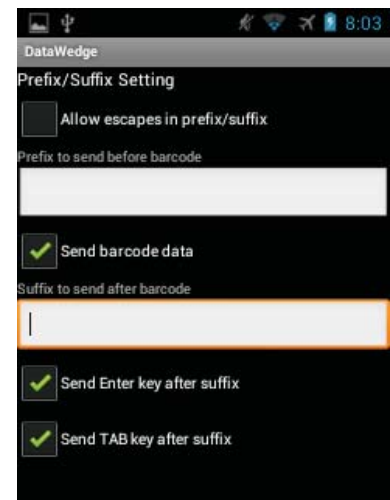

7. USB Connection

Connect the device to a host computer using the USB Charging cable and Single Slot USB cradle / cable cup to transfer files between the device and the host computer.

Connect to host computer

1. Place the device into a single slot cradle or cable cup, connect the USB Charging cable to the cradle / cable cup and computer.
2. Connected as a media device or Connected as an USB mass storage with the large green Android icon appears on the screen and USB connected icon will be appeared on Status bar.
3. Click Turn on USB storage. The green Android icon will turn orange, indicating that the phone is now in USB Mass Storage mode and should now appear as USB disk drives in "Devices with Removable Storage."
4. On the host computer, click open folder to view files.

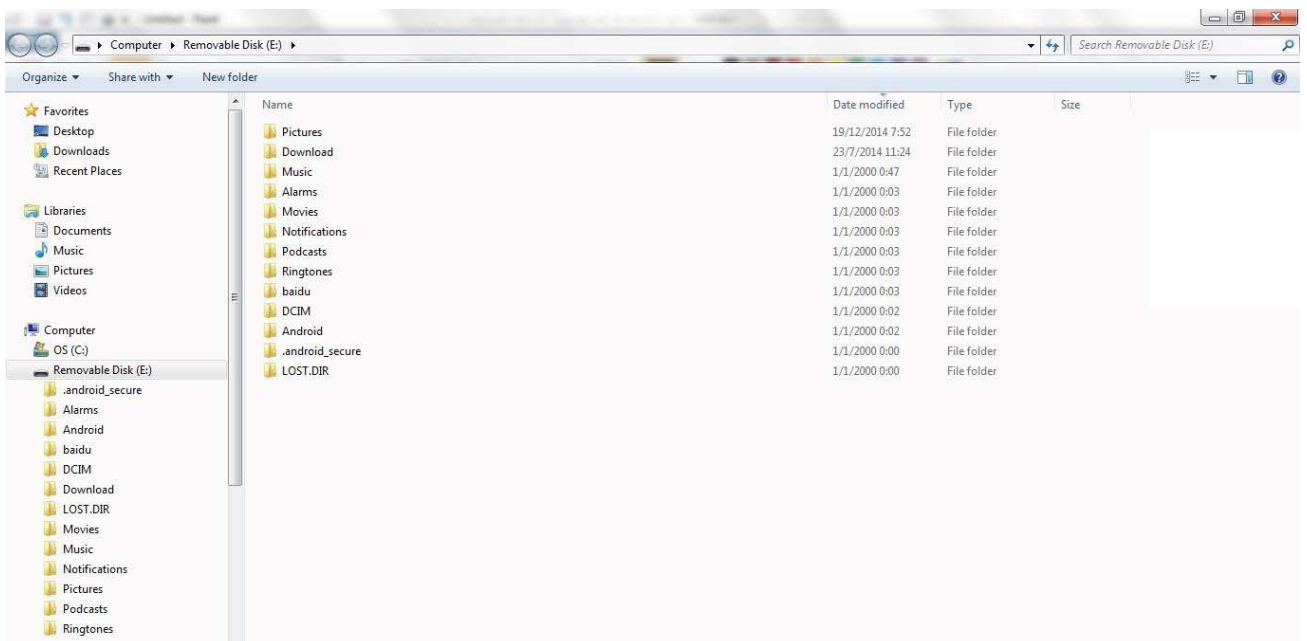

Mobile Device User Guide

Disconnect from host computer

1. On the host computer, unmounts the device.
2. Pull down the Notification shade, tap Turn off USB storage.
3. On the USB mass storage screen with orange Android icon, tap Turn off USB storage.
4. Remove the device from the cradle.

--NOTE--: Carefully follow the host computer's instructions to unmount the microSD card and disconnect USB device correctly to avoid losing information.



8. Application Deployment

Install Applications via USB Connection

1. Connect the device to a host computer using USB. See USB Connection in Chapter 6.
2. On the host computer, copy the application .apk file from the host computer to the device (SD card).
3. Disconnect the device from the host computer.
4. Tap Menu, select SD File Manager.
5. Tap  , select extsd to view files on SD card.

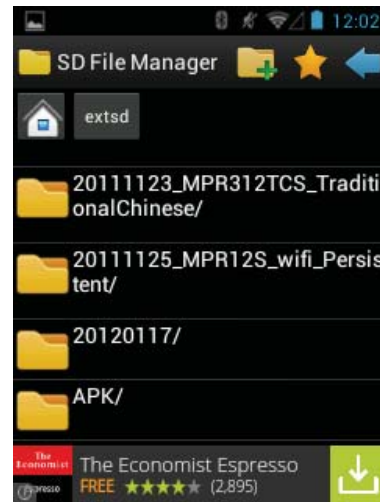
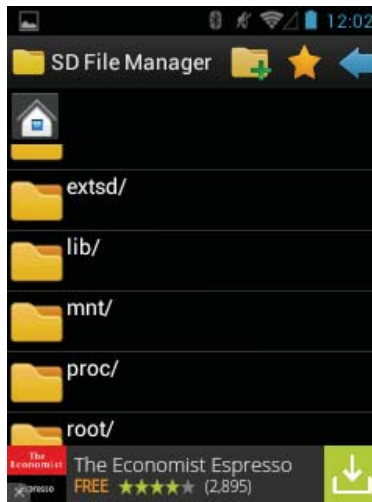
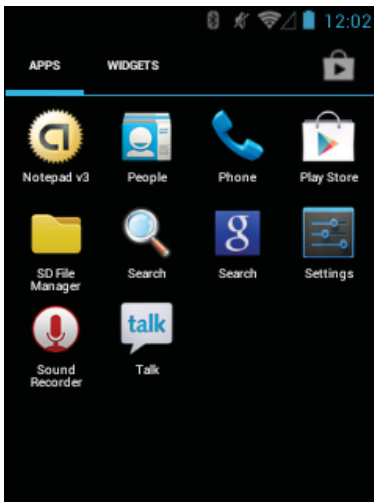

6. Tap the application file to begin the installation.
7. To confirm installation, tap Install otherwise tap Cancel.
8. Tap Open to open the application or Close to exit the installation process.

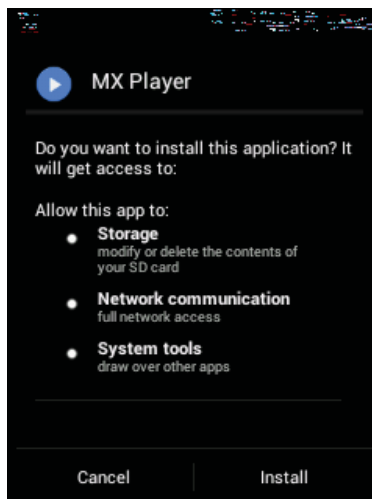
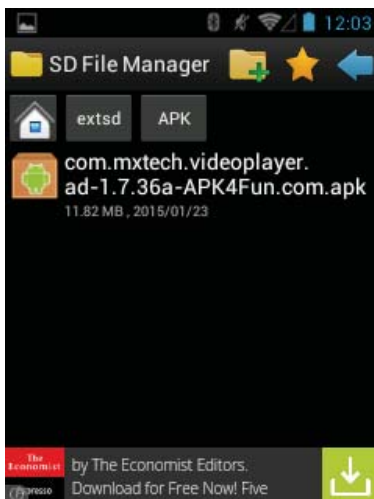

Mobile Device User Guide

Install Applications via Android Debug Bridge

1. Connect the device to a host computer using USB. See USB Communication in Chapter 6.
2. Tap Menu, select Settings.
3. Select {} Developer options.
4. Turn on Developer options. Click OK to allow development settings.
5. Select USB Debugging. The Allow USB debugging? dialog box appears. Tap OK to allow debug settings.

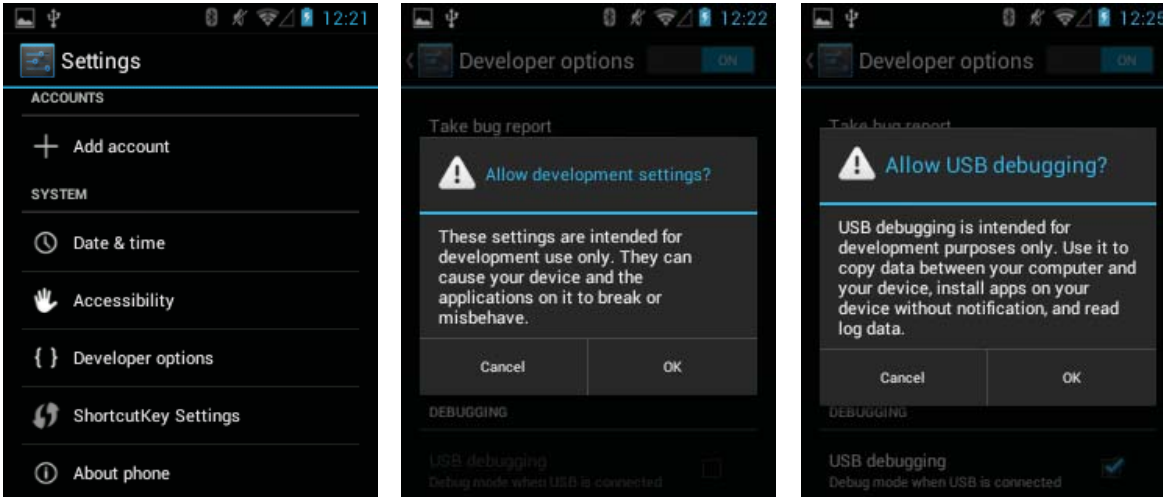

6. On the host computer, open a command prompt window and use the adb command: `adb install <application>` where: `<application>` = the path and filename of the apk file.
7. Disconnect the device from the host computer..

Uninstall Applications

1. Tap Menu, select Settings.
2. Select Apps.
3. Tap the app which has to be uninstalled.
4. Tap Uninstall.
5. Tap OK to confirm uninstallation.

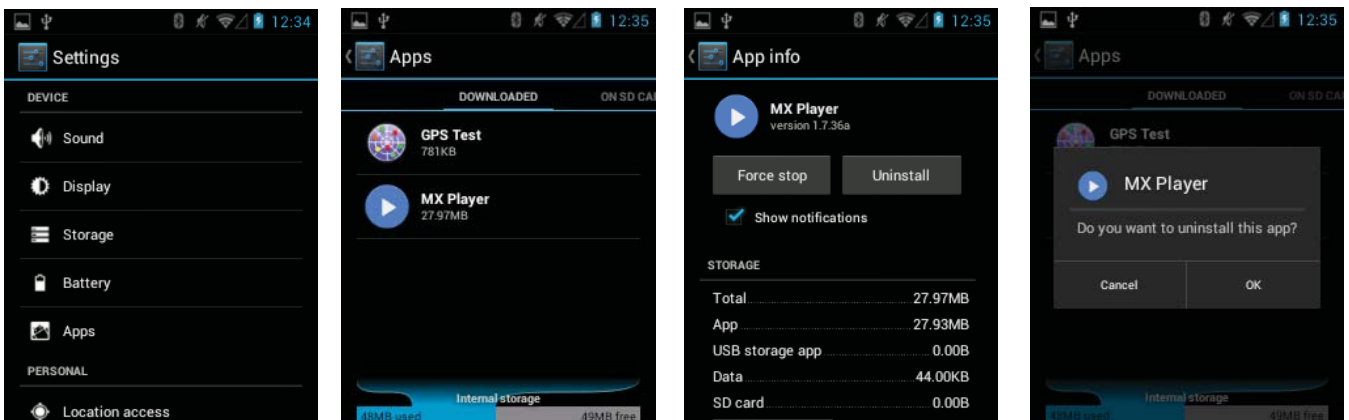

Mobile Device User Guide

Storage

The device contains 4 types of file storage:-

- (a) Random Access Memory (RAM)
- (b) Internal storage
- (c) External storage (MicroSD card)
- (d) Enterprise folder

Random Access Memory (RAM)

Executing programs use RAM to store data. Data stored in RAM is lost upon a reset.

The operating system manages how applications use RAM. It only allows applications and component processes and services to use RAM when required. It may cache recently used processes in RAM, so they restart more quickly when opened again, but it will erase the cache if it needs the RAM for new activities.

To check out the amount of free and used memory, tap Settings > Apps. Swipe to the Running screen. The bar at the bottom of the screen shows the amount of free and used RAM.

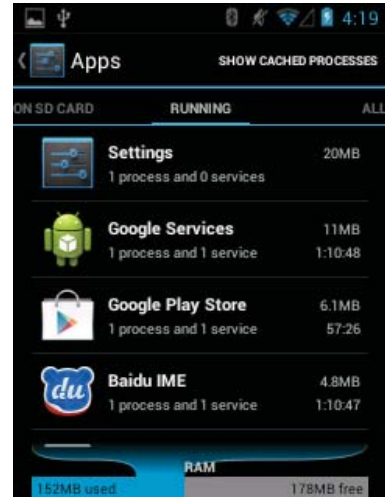

Internal Storage

The internal storage content can be viewed and files can be transferred when the device is connected to a host computer.

To check out the used and available space on the internal storage, tap Settings > Storage.

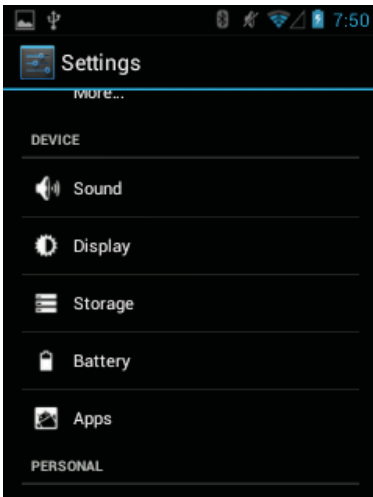

- **Total space** - shows the total amount of space on internal storage.
- **Apps** - shows the space used for applications and media content on internal storage.
- **Available** - shows the free space on internal storage.

Move down to view the distribution of the used and free space, including Apps, Pictures/Videos, Audio, Downloads and Available.

Mobile Device User Guide

External Storage (MicroSD card)

The device can be inserted a MicroSD card. The MicroSD card content can be viewed and files can be transferred when the device is connected to a host computer.

To check out the used and available space on the MicroSD card, tap Settings > Storage.

- **Erase SD card** - erases all data on the installed MicroSD card.
- **Total space** - shows the total amount of space on the installed MicroSD card.
- **Available** - shows the free space on the installed MicroSD card.
- **Unmount SD card** - unmounts the installed MicroSD card from the device so it can be safely removed.

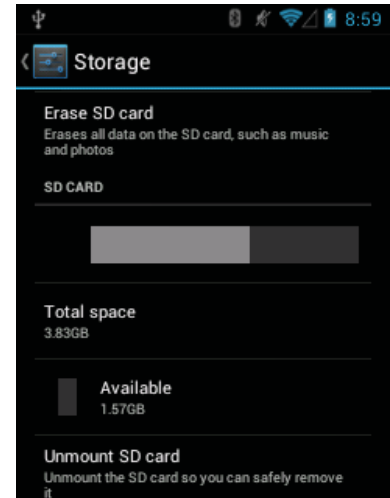

Enterprise Folder

The Enterprise folder (within internal storage) is a super-persistent storage that is persistent after a reset and an Enterprise Reset. The Enterprise folder is deleted after a Hard Reset. The Enterprise folder is used for deployment and device-unique data. It is approximately 128 MB (formatted). Applications can persist data after an Enterprise Reset by saving data to the enterprise/user folder.

Applications Management

To manage applications, tap Settings > Apps. The Manage Applications screen has four tabs, including Downloaded, On SD Card, Running, All, with listing applications and their components in each. There is a bar showing the amount of used memory and free memory at the bottom of each tab.

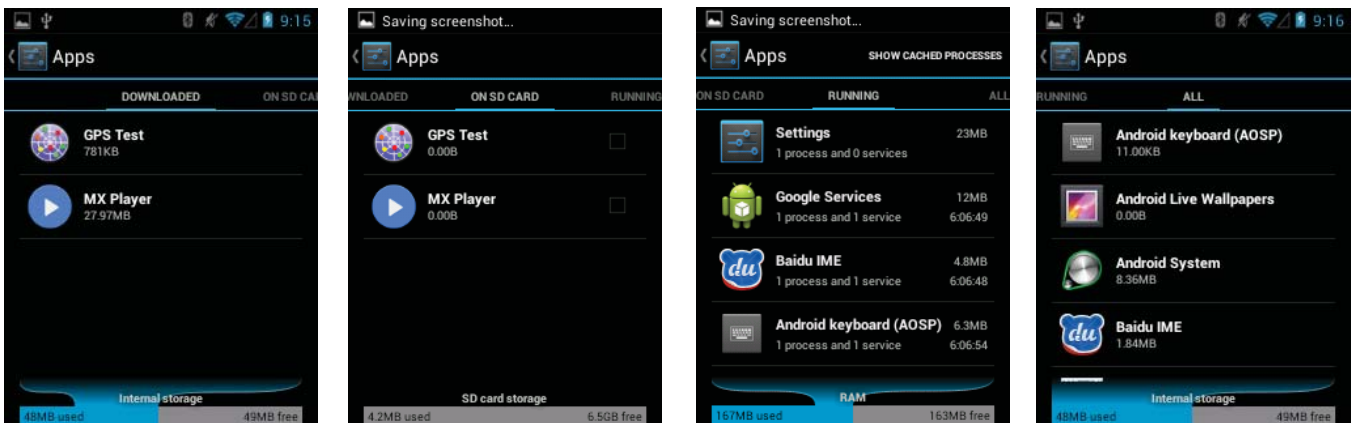

- **Downloaded** - view the applications downloaded to the device.
- **SD card** - view the applications installed on the microSD card.
- **Running** - view the applications and their processes and services that are running or cached
- **All** - view all the applications installed on the device, including factory installed applications and downloaded applications.

Mobile Device User Guide

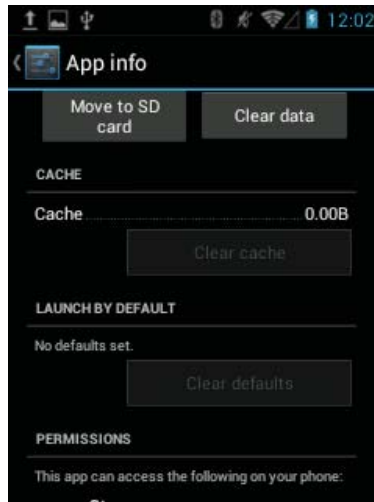
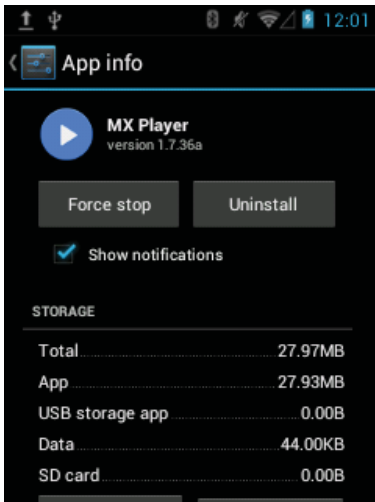

Tap an application, process, or service in the list. A screen will pop up with details, depending on the item, to change its settings, stop it or uninstall it.

Applications have different kinds of information as below:

- Tap **Force stop** to stop an application.
- Tap **Uninstall** to delete the application and all of its data and settings from the device.
- Tap **Move to SD card / Move to Phone** to change location of applications.
- Tap **Clear data** to delete an application's settings and data.
- **Cache** lists how much information is stored in a temporary area. Tap Clear Cache to clear information.
- **Launch by default** clears if you have configured an application to launch certain file types by default, you can clear that setting by tapping Clear defaults.
- **Permissions** shows the areas on the device that the application can access to.

To Stop An Application

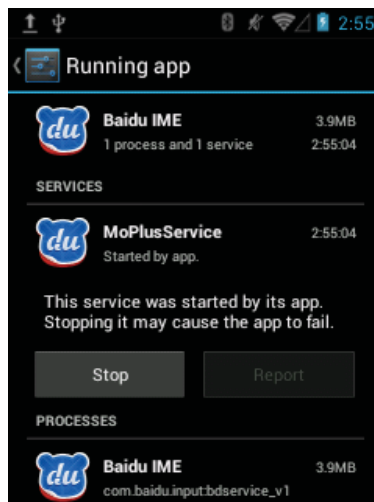
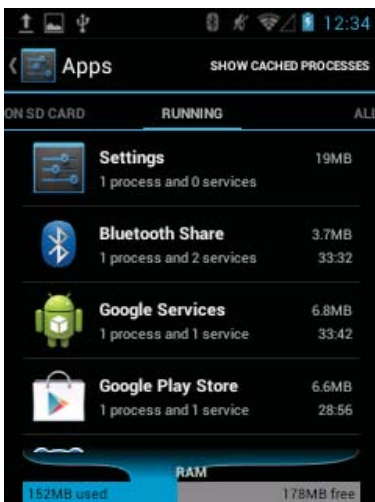

1. Tap Menu, select Settings.
2. Select Apps.
3. Slide to the Running tab. At the right top corner, tap Show running services or Show cached processes to switch back and forth. The Running tab shows the applications, processes, and services that are currently running. Cached processes tab shows how much RAM they are using.
4. Tap the application.
5. Tap Stop.

Mobile Device User Guide

To Change Application Location

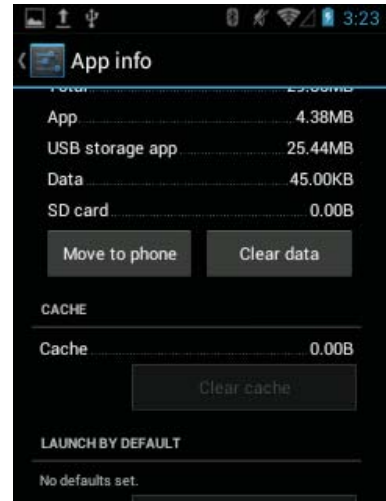
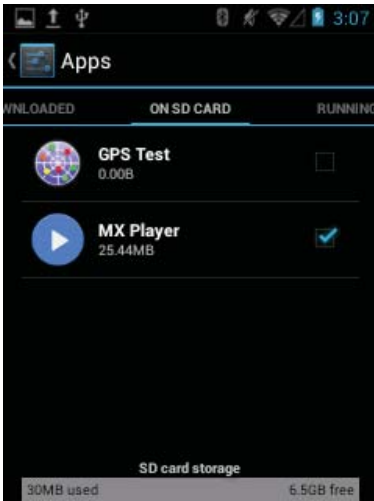

1. Tap Menu, select Settings.
2. Select Apps.
3. Slide to the On SD Card tab. The tab lists the applications that can be stored In the MicroSD card. Each application shows the amount of storage it uses on internal storage. Applications that are stored in the MicroSD card are checked.
4. Tap the application from the list.
5. Tap Move to SD card to move the application from the device's internal storage to the MicroSD card. Or tap Move to phone to move the application back to internal storage.

Managing Downloads

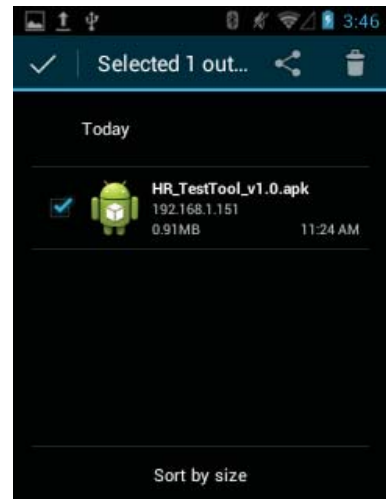
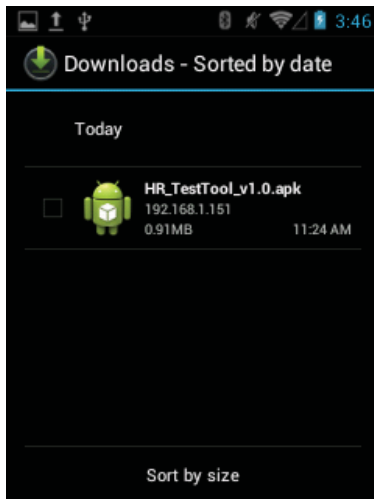

1. Tap Menu, select Downloads.
2. Tap headings to view earlier downloads.
3. Tap Sort by size or Sort by time to switch back and forth.
4. Tap an application to open it.
5. To delete file from storage, check the box and tap the rubbish bin at the top right corner.

9. WiFi Connection

Wireless Local Area Network Access

Enable WiFi

1. Click Menu > Settings.
2. In WIRELESS & NETWORKS section, turn on WiFi.
3. Tap the WiFi text on the setting screen.
4. The device will detect available Wi-Fi networks. Select the network you want to connect to, and then click Connect to network. If password is required, enter password. If it is necessary, you may click Show advanced options to edit Proxy settings & IP settings. Then click Connect.

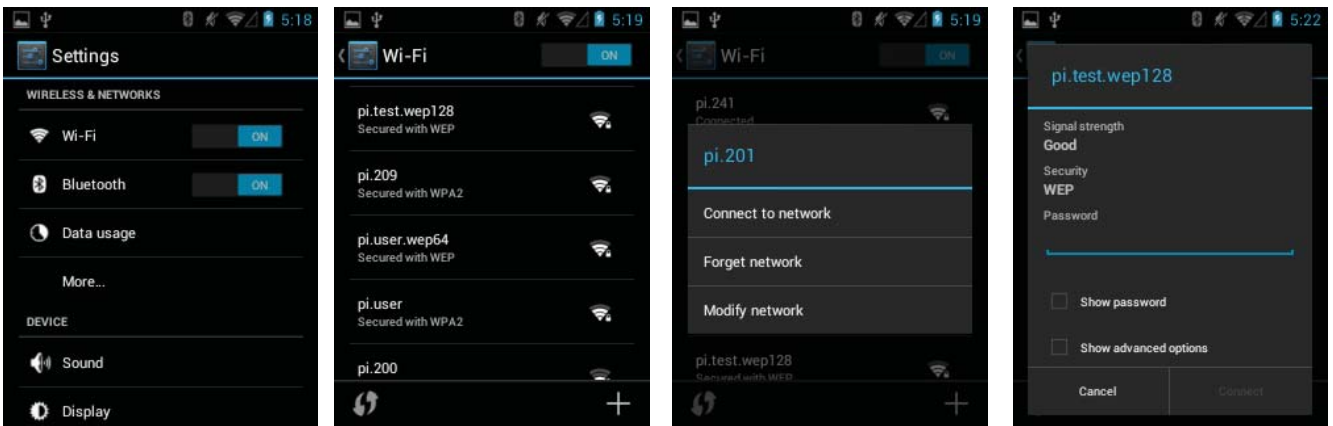

5. If not, click + to configure your own network.
On the Settings screen, change any of the following information:
In Network SSID, enter a name for the connection.
Select security options.
Click Show advanced options to edit Proxy settings & IP settings.
6. Click Save.

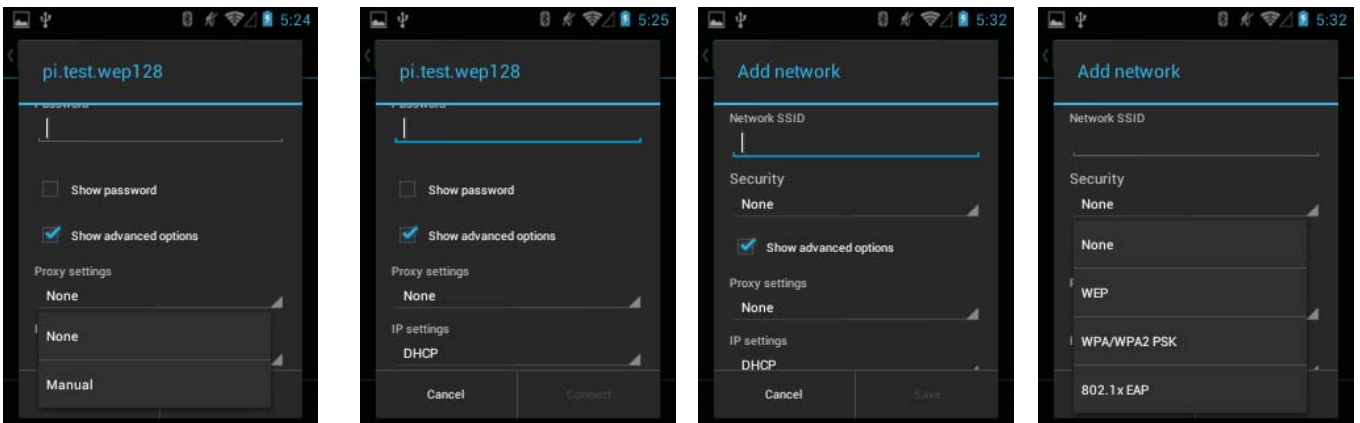

Disable WiFi

1. Click Menu > Settings.
2. In WIRELESS & NETWORKS section, turn on WiFi.

10. Bluetooth

Bluetooth is a short-range wireless communications technology. Devices with Bluetooth function can exchange information over a distance of about 10 meters (30 feet) even if the devices are in different rooms.

To turn Bluetooth on/off

1. Click Menu > Settings.
2. In WIRELESS & NETWORKS section, turn on Bluetooth.



To make a device visible

Other devices with Bluetooth capabilities can detect your device and attempt to beam information to it, establish a partnership, or use a Bluetooth service.

1. Tap Menu > Settings.
2. Tap the word Bluetooth to enter Bluetooth setting page.
3. Tap on the device's name (as below image "BlueZ") to make the device visible.



Bluetooth Partnerships

A partnership is a relationship that you create between your device and another Bluetooth device to securely exchange information. You have to enter passcode on both device to create a partnership, the devices need only have Bluetooth turned on to exchange information; they do not need to be visible.

Once you create a partnership on both devices, they can exchange information without entering the passcode afterwards.

Mobile Device User Guide

To create a Bluetooth partnership

1. Tap Menu > Settings.
2. Tap the word Bluetooth to enter Bluetooth setting page.
3. Tap SEARCH FOR DEVICES.
4. Your device searches for other devices with Bluetooth capabilities and displays them in the list.
5. Tap the name of the device to be paired.
6. Enter a PIN, and tap OK.

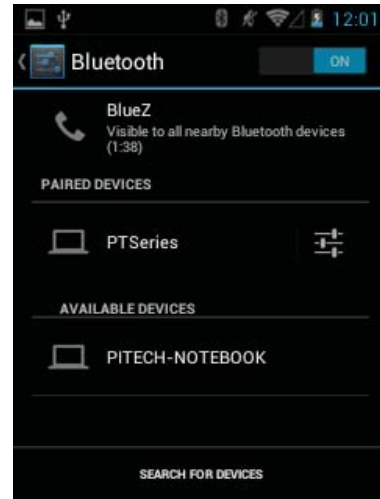
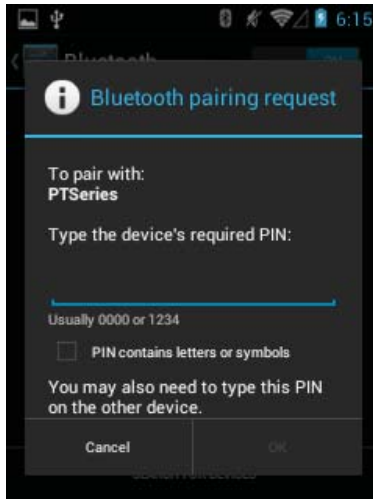
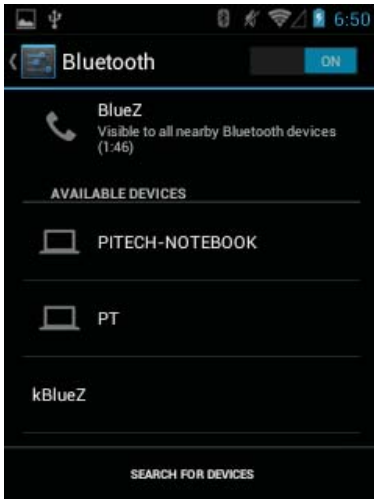

To accept a Bluetooth partnership

1. Ensure that your device is turned on, visible and within close range.
2. Enter a PIN, and tap OK. You must enter the same PIN that was entered on the device requesting the partnership.

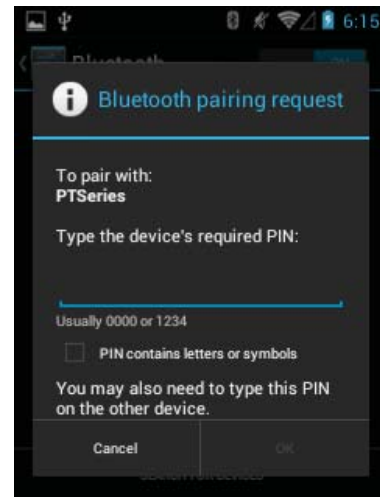

Mobile Device User Guide

To delete a Bluetooth partnership

1. Tap Menu > Settings.
2. Tap the word Bluetooth to enter Bluetooth setting page.
3. You can see the paired up device on your list.
4. Click  next to the partnership you want to end.
5. Tap Unpair.

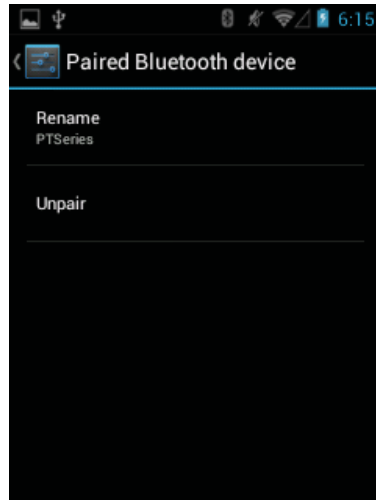
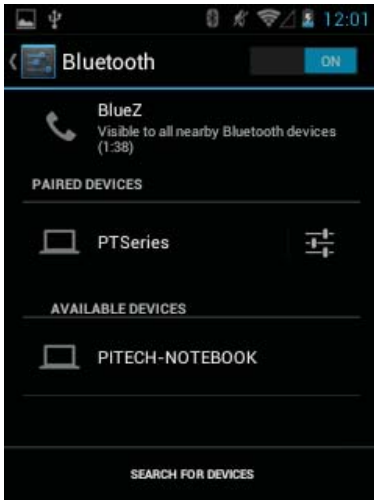

To transfer file

1. Open the file.
2. Tap , select Bluetooth.
3. Bluetooth device chooser screen appears.
4. Select the device from the available devices list. Tap the device name.
5. Send File pop up will appear.

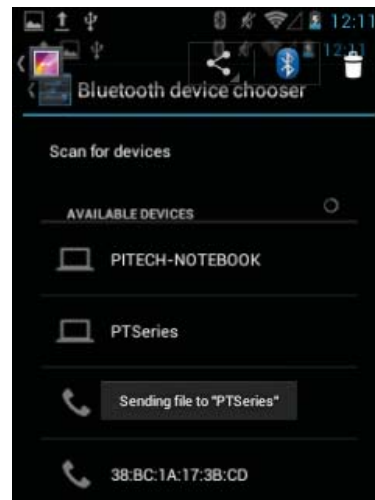
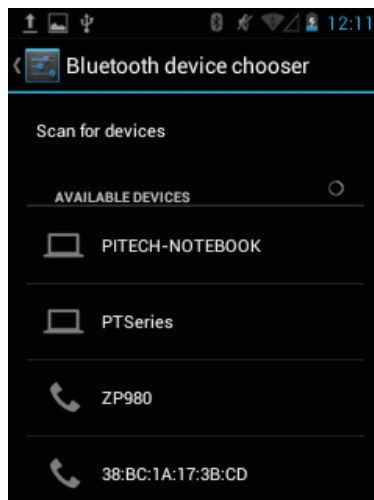
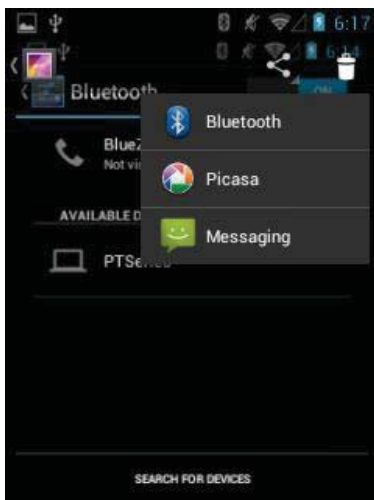

11. Regulatory and Warning

Regulatory Information

Device and the logo are trademarks of our company. Other product and brand names may be trademarked or registered trademarks of their respective owners.

Our company assumes no responsibility for any damage or loss resulting from the use of this guide. Our company assumes no responsibility for any loss or claims by third parties which may arise through the use of this product. Our company assumes no responsibility for any damage or loss caused by deletion of data as a result of malfunction, dead battery or repairs. Be sure to make backup copies of all important data on other media to protect against data loss.

CE Marking and European Economic Area (EEA)

Hereby, our company declares that this product is in compliance with the essential requirements and other relevant provisions of Directive, 1999/5/EC.

Our company shall not be liable for use of our product with equipment (i.e., power supplies, personal computers, etc.) that is not CE marked and does not comply with the Low Voltage Directive.

FCC Compliance

Radio Frequency Interference Requirements-FCC

Note: This equipment has been tested and found to comply with the limits for a Class B digital device, pursuant to Part 15 of the FCC rules. These limits are designed to provide reasonable protection against harmful interference in a residential installation. This equipment generates, uses and can radiate radio frequency energy and, if not installed and used in accordance with the instructions, may cause harmful interference to radio communications. However there is no guarantee that interference will not occur in a particular installation. If this equipment does cause harmful interference to radio or television reception, which can be determined by turning the equipment off and on, the user is encouraged to try to correct the interference by one or more of the following measures:

- Reorient or relocate the receiving antenna
- Increase the separation between the equipment and receiver
- Connect the equipment into an outlet on a circuit different from that to which the receiver is connected
- Consult the dealer or an experienced radio/TV technician for help.

Mobile Device User Guide

Battery Warning

1. Use manufacturer's original battery and charger only. Any incompatible battery or charger may result in a fire, explosion, or other hazard.
2. Do not disassemble or open, crush, bend or deform, puncture, or shred the battery.
3. Do not short-circuit a battery by allowing conductive materials to contact the battery terminals.
4. Do not immerse or expose the battery to water or other liquids.
5. Do not dispose of batteries in fire or place the battery into a microwave oven or dryer.
6. If battery leakage is found, avoid the liquid to come in contact with the skin or eyes.
7. If contact has been made, rinse the affected area with water and seek medical advice.
8. If you suspect damage to your equipment or battery, contact the manufacturer for inspection.
9. Follow the local regulations to dispose or recycle the used re-chargeable batteries.

General information

1. Before using the standard charger, read all instructions and warnings.
2. Please retain these instructions for future reference.

For more battery safety and charger safety guidelines, refer to the Quick Start Guide.

Charge the MOBILE BARCODE TERMINAL

Before using the device for the first time, you must charge the battery.

1. You can charge the device with a travel adapter or by connecting the device to a PC with a USB cable.
2. Battery full icon is shown when finished if your device is off.

Notes :

1. Use only qualified factory-supplied chargers and cables. The use of unapproved accessories could damage your phone or cause the battery to explode.
2. You can directly use the Li-Polymer battery in the pack. Please normally use off the battery and fully charge the battery for its perfect performance.
3. If the phone has been shut off for a long time or the battery has been used up, you should charge the phone for 3 to 5 minutes then turn on.
4. Normal charge temperature: -10°C to 40°C.

FCC Warning

This device complies with part 15 of the FCC Rules. Operation is subject to the following two conditions: (1) This device may not cause harmful interference, and (2) this device must accept any interference received, including interference that may cause undesired operation.

Any Changes or modifications not expressly approved by the party responsible for compliance could void the user's authority to operate the equipment.

Note: This equipment has been tested and found to comply with the limits for a Class B digital device, pursuant to part 15 of the FCC Rules. These limits are designed to provide reasonable protection against harmful interference in a residential installation. This equipment generates uses and can radiate radio frequency energy and, if not installed and used in accordance with the instructions, may cause harmful interference to radio communications. However, there is no guarantee that interference will not occur in a particular installation. If this equipment does cause harmful interference to radio or television reception, which can be determined by turning the equipment off and on, the user is encouraged to try to correct the interference by one or more of the following measures:

- ▶ -Reorient or relocate the receiving antenna.
- ▶ -Increase the separation between the equipment and receiver.
- ▶ -Connect the equipment into an outlet on a circuit different from that to which the receiver is connected.
- ▶ -Consult the dealer or an experienced radio/TV technician for help.

Specific Absorption Rate (SAR) information:

This MOBILE BARCODE TERMINAL meets the government's requirements for exposure to radio waves. The guidelines are based on standards that were developed by independent scientific organizations through periodic and thorough evaluation of scientific studies. The standards include a substantial safety margin designed to assure the safety of all persons regardless of age or health.

FCC RF Exposure Information and Statement

The SAR limit of USA (FCC) is 1.6 W/kg averaged over one gram of tissue. Device types: MOBILE BARCODE TERMINAL (FCC ID: UTWXT20) has also been tested against this SAR limit. The highest SAR value reported under this standard during product certification for use at the ear is 0.794W/kg and when properly worn on the body is 0.653W/kg. the Hotspot SAR value is 0.653W/kg, the simultaneous transmission SAR value is 1.109W/kg on the head and 0.895W/kg on the body. This device was tested for typical body-worn operations with the back of the handset kept 10mm from the body. To maintain compliance with FCC RF exposure requirements, use accessories that maintain a 10mm separation distance between the user's body and the back of the handset. The use of belt clips, holsters and similar accessories should not contain metallic components in its assembly. The use of accessories that do not satisfy these requirements may not comply with FCC RF exposure requirements, and should be avoided.

Body-worn Operation

This device was tested for typical body-worn operations. To comply with RF exposure requirements, a minimum separation distance of 10mm must be maintained between the user's

body and the handset, including the antenna. Third-party belt-clips, holsters, and similar accessories used by this device should not contain any metallic components. Body-worn accessories that do not meet these requirements may not comply with RF exposure requirements and should be avoided. Use only the supplied or an approved antenna.