

## MPE COMPLIANCE



MPE compliance distance: 1.28 meters (4.2 feet)

Users and other nearby individuals maintain 1.28 meters (4.2 feet) or more from a boat-mounted antenna during transmission.

Compliance with the FCC's MPE limits in 47 CFR Section 1.1310, Table 1(b).

- \* **Maximum permissible exposure (MPE):** The rms and peak electric and magnetic field strength, their squares, or the plane-wave equivalent power densities associated with these fields to which a person may be exposed without harmful effect and with an acceptable safety factor.

## Operation

### 1. Controls

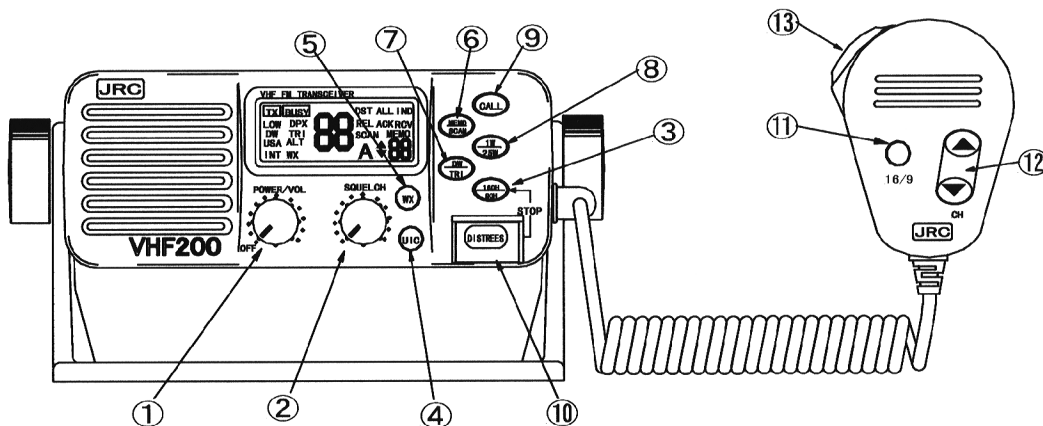

Figure 1: Controls

- ① **POWER/VOL Control:** Turns the radio on and off, and adjusts volume of the speaker.
- ② **SQUELCH Control:** Adjusts the squelch. Rotate the control counter-clockwise until noise is heard, then rotate it clockwise slowly until noise just fades out.
- ③ **16/9 Key:** Immediately recalls CH16 from any channel location. Pressing this key for more than 1 sec recalls CH09.
- ④ **U/I/C(USA, International, Canadian)Key :** Holding down this key for more than 1 sec changes the channel modes from USA, International to Canadian. "USA" or "INT" will appear on the LCD display for each mode, but no indicator will be displayed for Canadian channel mode.
- ⑤ **WX Key:** This key has double functions. When pressed once, it selects the weather channels receiving mode. "WX" will appear. While the radio is in this mode, the transmitter is always disabled.  
When pressed for more than 2 sec, it switches the LCD backlight on and off.

- ⑥ **MEMO/SCAN** Key: Controls the memory function. All receiving channels except weather channels can be stored in this memory.

Channel Memory:

First select the channel to be memorized, then hold the **MEM/SCAN** key down until a beep sounds (approx. 2 seconds). “MEMO” and the channel number will appear on the LCD.

To store more channels, repeat the same procedure.

Memory Scan:

Memorized channels can be scanned by simply pressing this key. “MEMO” blinks and the memorized channels are scanned one by one in an upward direction. This operation is invalid if no channel is stored in the memory.

Memory Clear:

To cancel a memorized channel, select the channel to be cleared. Then hold the key down until a beep sounds ( approx. 2 seconds). “MEMO” will disappear from the LCD.

\* Usage of this key in the DSC mode is explained in the DSC section.

- ⑦ **DW/TRI** Key: There are two kinds of scan mode; Dual watch and Tri-watch. First pressing of this key selects Dual watch, and pressing again leads to Tri-watch..

- ⑧ **1W/25W** Key: Alternately changes the transmitter output power between 1 watt ( “LOW” appears ) and 25 watts ( “LOW” disappears). USA channels 13,17,67 and 77 are automatically set to 1 watt, but channels 13 and 67 can be switched to 25 watts if **1/25** key is pressed while **PTT** switch is on.

- ⑨ **CALL** Key: Selects DSC operation. See the DSC section for details.

- ⑩ **DISTRESS** Key: Remove the cover, press the key once, then press for 3 seconds or more to send the distress call transmission using the DSC function. See the DSC section for details.

- ⑪ **16/9** Key: Works same as (3) **16/9** Key.

- ⑫ **UP/DWN▲▼**Key: Selects channels. Also selects functions in the DSC operation.

- ⑬ **PTT** Switch ( Push-to-Talk): Hold this switch down to transmit, and release it to listen. “TX” appears during transmission.

## 2. Indications

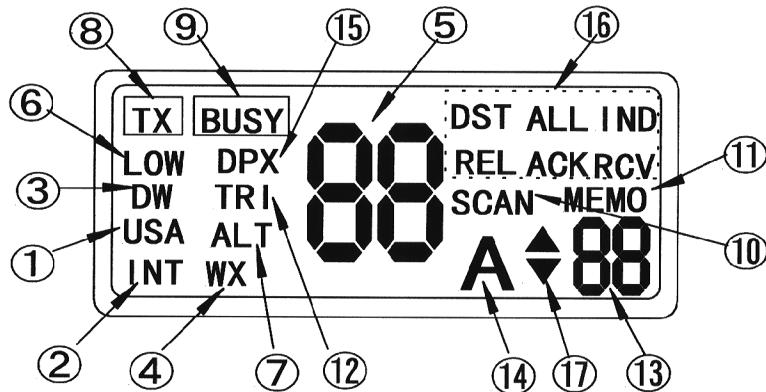

Figure 2: Indications

- ① **USA:** Appears when USA mode is selected with the **U/I/C** key.
- ② **INT:** Appears when International mode is selected with the **U/I/C** key.
- ③ **DW:** Appears when Dual watch mode is selected with the **DW** key.
- ④ **WX:** Appears when the Weather channel mode is selected with the **WX** key.
- ⑤ **LCD Segments:** Indicates the current channel number.
- ⑥ **LOW:** Appears when the low transmitter output power ( 1 watt) is selected with **1/25** key. It also appears when a low power channel has been selected with the **CHANNEL** key.
- ⑦ **ALT ( Weather Alert):** Blinks when a weather alert signal has been received.
- ⑧ **TX ( Transmit):** Appears when the **PTT** switch on the microphone is pressed and held.
- ⑨ **BUSY:** Appears while a signal is being received.
- ⑩ **SCAN :** Appears while the radio is scanning.
- ⑪ **MEMO:** Appears with the memorized channel number. If “SCAN” and “MEMO” appear together, the radio is in the Memory Scan mode.
- ⑫ **TRI:** Appears when Tri-watch mode is selected by the **SCAN** key.
- ⑬ **88:** In the normal receiving mode

CH16: being monitored while the radio is in the DW or TRI mode.

In the DSC mode

- "dS" Appears when **DISTRESS** key is pressed. once
- "rO" Appears when **CALL** key is pressed for more than 2 sec.
- "Un" Appears when "Unable to comply" is selected in the Individual Call Mode.
- "U0—U4" Shows the stored calling channels during "Unable to comply" mode is selected.
- "cA" Appears when Distress Cancellation Mode is selected.
- "GE" Appears when Geographical area call is received.
- "digit" (1) digit 1–9(ID number):Appears when ID number is registered.  
(2) digit 0–19(Voice communication channel): Appears when the Individual Call mode is selected by **CALL** key.

⑭ **A**: Appears when the channel is simplex on the U.S.A. or Canadian channel assignments.

⑮ **DPX** : Appears when the channel duplex mode is selected.

⑯ Indications during DSC Operation:

- \* **DST**: Appears when the Distress Call mode is selected with the **DISTRESS** key.
- \* **ALL**: Appears when the All Ships Call mode is selected with the **CALL** key.
- \* **IND**: Appears when the Individual Call mode is selected with the **CALL** key.
- \* **REL**: Appears when the Distress Relay Call has been received.
- \* **ACK**: Appears when the Acknowledgement of the distress call has been received.
- \* **RCV**: Appears when the DSC call signal has been received.

⑰ **▲▼** : Appears when the **UP/DWN ▲▼** key is used in the DSC operation.

### 3. DSC (Digital Selective Calling) Operation

This device complies with RTCM SC101-STD.

#### 3-1: Transmitting DSC ( Digital Selective Calling) Calls

This radio is equipped with the DSC function necessary for maritime traffic.

##### \* Distress Call

The Distress Call automatically sends the information including the vessel's DSC MMSID (Maritime Mobile Service ID) and Lat/Lon position.

**Note:** It is necessary that the radio is connected to GPS or LORAN to send the vessel's position.

1. Remove the cover and press the **DISTRESS** key. CH70, ▲▼dS and "DST" will appear On the display.
2. Press the key again (for about 3 seconds) and "TX" will appear.
3. After the distress signal has been sent, an alarm is sounded, and the radio dual-watches between CH16 and CH70 until an ACK is received. ("DST" blinks)

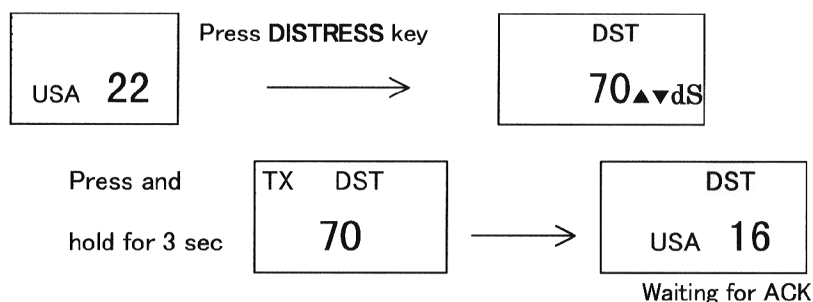

Transmission is repeated at the interval of 3.5min to 4.5min until an ACK signal is received.  
To quit this mode, press **16/9** key.

4. If an ACK signal is received, "ACK RCV" appears, the channel goes to CH16 automatically, and the Distress Alarm is sounded. To stop this Distress alarm, press any key.

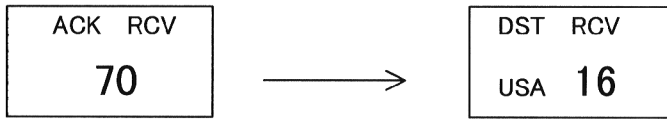

5. Distress Cancellation Mode:

To cancel the Distress call previously transmitted, press the **DISTRESS** key once

(Blinking "DST" and **▲▼dS** appear at CH70). **cA** is displayed by pressing the **UP/DOWN** key once.

Then press the **DISTRESS** key for more than 3 sec and the Distress cancellation call is sent. This cancellation function is invalid after an ACK signal has been received, or when the equipment is switched off.

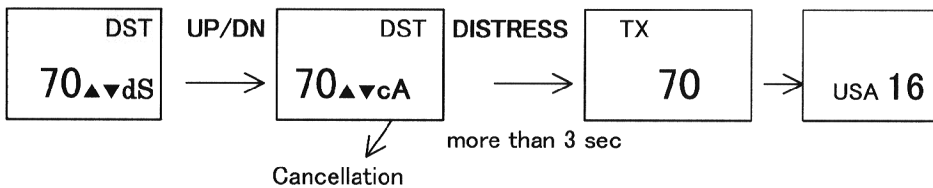

\* Individual Call

This function is to send a DSC signal to a specific party only.

1. Select a channel for voice communication, and press the **CALL** key. A beep is heard, "IND" appears, and the registered calling channel is displayed. ( max. 20 channels)
2. Select a calling channel you want to contact by pressing the **UP/DOWN** key.
3. Press the **CALL** key for more than 2 seconds to transmit the individual DSC call.

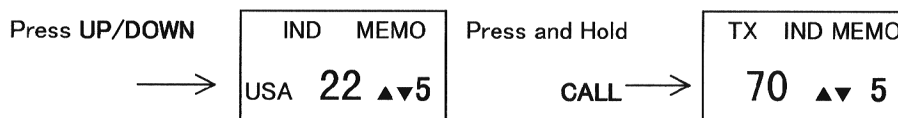
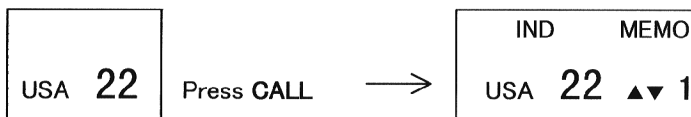

4. After the individual DSC call is transmitted, the transceiver waits 10 seconds for the acknowledgement. If no reply arrives after 10 seconds, the second call is transmitted automatically, and blinking "RCV" appears.

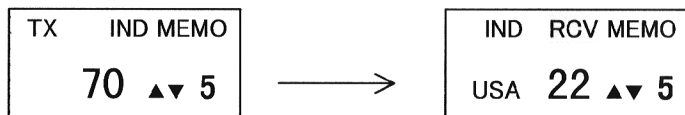

5. If the reply signal is not received after the second call, press the **CALL** key for more than two seconds to transmit again, or cancel this mode by pressing **CALL** key or **16/9** key.

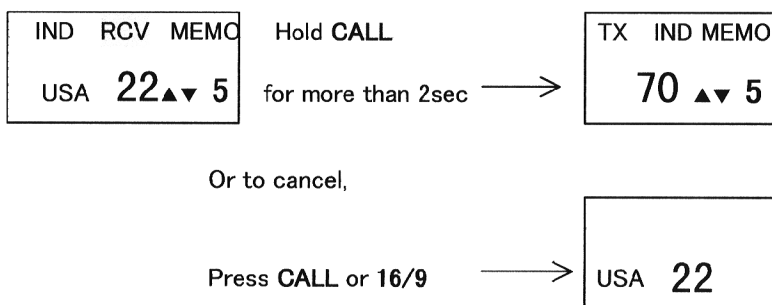

6. When an ACK signal (able to comply) is received, "ACK RCV" appears with an alarm. Cancel the alarm by pressing any key. Then the radio turns to the normal receiving mode.

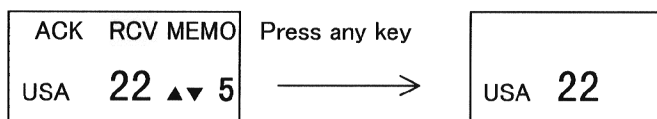



7. When an ACK ( unable to comply) is received, “ACK RCV” appears with an alarm, and “Un” is displayed. The established channel is automatically selected.

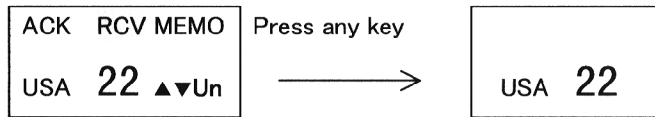

8.“ACK RCV” is displayed when an ACK signal is received and an alarm sounds for a few second.

**\* All Ships Call**

In the All Ships Call, it is not necessary to select the other vessel stations’ ID.

1.Select a channel for voice communication, then press the **CALL** key for more than 2 sec. “ALL” will appear on the LCD with rO, showing that the Routine Call is selected.

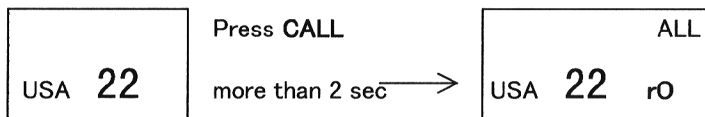

2.Press the **CALL** key again for more than 2 seconds. All Ships Call will be sent once. If CH70 is BUSY, transmission is invalid.

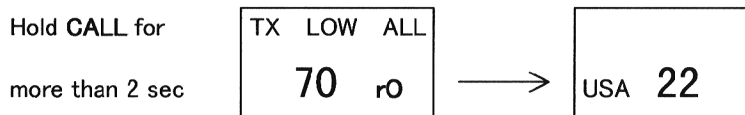

\* “MEM” Individual Call

This function allows you to call again in your convenient time after you transmitted an “Unable to comply” ACK signal. Maximum 5 calling channels ( U0 ~ U4) ※ can be stored.

※ “U” in this position means “ **Unable to comply**”.

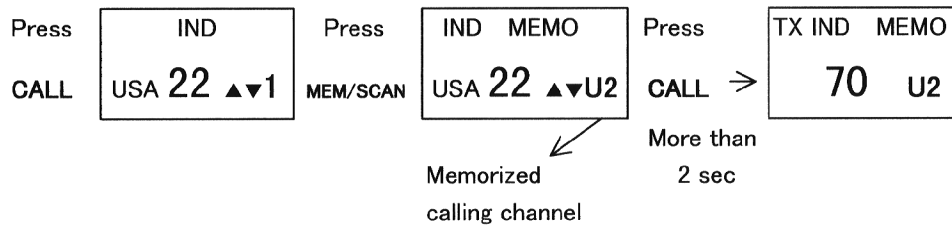

**Note:** The memorized calling channels change with each pressing of the **MEM/SCAN** key.

3-2: Receiving DSC Calls

\* Distress Call

When a Distress Call is received, an exclusive emergency alarm is sounded, and the channel is changed to CH16 automatically. Press any key to stop the alarm.

